

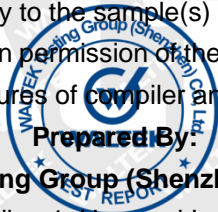


TEST REPORT

Reference No..... : WTX21X10116433E
 Applicant : Acrox Technologies Co., Ltd.
 Address : 4F., No.89, Minshan St., Neihu Dist., Taipei City 114, Taiwan
 Product : Gaming Mouse
 Test Model : AGM700*****(*=A~Z,a~z,0~9,/ ,or blank), AZ2
 Standards : EN 55032:2015+A11:2020
 : EN 55035:2017+A11:2020
 Date of Receipt sample : Oct. 29, 2021
 Date of Test..... : Oct. 29, 2021 to Nov. 01, 2021
 Date of Issue : Nov. 03, 2021
 Test Result..... : Pass

Remarks:

The results shown in this test report refer only to the sample(s) tested, this test report cannot be reproduced, except in full, without prior written permission of the company. The report would be invalid without specific stamp of test institute and the signatures of compiler and approver.



Prepared By:

Waltek Testing Group (Shenzhen) Co., Ltd.

Address: 1/F., Room 101, Building 1, Hongwei Industrial Park, Liuxian 2nd Road,
Block 70 Bao'an District, Shenzhen, Guangdong, China

Tel.: +86-755-33663308

Fax.: +86-755-33663309

Tested by:

Toby Zhang / Project Engineer

Reviewed By:

Evan Cai / EMC Manager

Approved & Authorized By:

Silin Chen / Manager



TABLE OF CONTENTS

1. GENERAL INFORMATION	3
1.1 PRODUCT DESCRIPTION FOR EQUIPMENT UNDER TEST (EUT).....	3
1.2 TEST STANDARDS.....	4
1.3 TEST METHODOLOGY.....	4
1.4 EUT SETUP AND OPERATION MODE.....	5
1.5 PERFORMANCE CRITERIA FOR EMS.....	6
1.6 TEST EQUIPMENT LIST AND DETAILS.....	7
2. SUMMARY OF TEST RESULTS	8
3. RADIATED EMISSION	9
3.1 MEASUREMENT UNCERTAINTY.....	9
3.2 BASIC TEST SETUP BLOCK DIAGRAM.....	9
3.3 CORRECTED AMPLITUDE & MARGIN CALCULATION.....	10
3.4 ENVIRONMENTAL CONDITIONS.....	10
3.5 SUMMARY OF TEST RESULTS.....	10
4. ELECTROSTATIC DISCHARGES (ESD)	13
4.1 TEST PROCEDURE.....	13
4.2 TEST PERFORMANCE.....	13
4.3 ENVIRONMENTAL CONDITIONS.....	13
4.4 BASIC TEST SETUP BLOCK DIAGRAM.....	13
4.5 ELECTROSTATIC DISCHARGE IMMUNITY TEST DATA.....	14
5. CONTINUOUS RF ELECTROMAGNETIC FIELD DISTURBANCES (RS)	15
5.1 TEST PROCEDURE.....	15
5.2 TEST PERFORMANCE.....	15
5.4 BASIC TEST SETUP BLOCK DIAGRAM.....	15
5.5 CONTINUOUS RADIATED DISTURBANCES TEST DATA.....	16
6. POWER-FREQUENCY MAGNETIC FIELDS (PFMF)	17
6.1 TEST PROCEDURE.....	17
6.2 TEST PERFORMANCE.....	17
6.3 ENVIRONMENTAL CONDITIONS.....	17
6.4 BASIC TEST SETUP BLOCK DIAGRAM.....	17
6.5 POWER-FREQUENCY MAGNETIC FIELD TEST DATA.....	18
EXHIBIT 1 - PRODUCT LABELING	19
PROPOSED CE LABEL FORMAT.....	19
PROPOSED LABEL LOCATION ON EUT.....	19
EXHIBIT 2 - EUT PHOTOGRAPHS	20
EXHIBIT 3 - TEST SETUP PHOTOGRAPHS	25



1. GENERAL INFORMATION

1.1 Product Description for Equipment Under Test (EUT)

Client Information

Applicant: Acrox Technologies Co., Ltd.
Address of applicant: 4F., No.89, Minshan St., Neihu Dist., Taipei City 114, Taiwan

Manufacturer: TPV Electronics (Fujian) Co., Ltd.
Address of manufacturer: HRongqiao Economic and Technological Development Zone, Fuqing City, Fujian Province, P.R.China

General Description of EUT	
Product Name:	Gaming Mouse
Trade Name:	TPV
Model No.:	AGM700*****(*=A~Z,a~z,0~9,/,or blank)
Adding Model(s):	AZ2
<i>Note: The test data is gathered from a production sample, provided by the manufacturer. The appearance of others models listed in the report is different from main-test model AGM700*****(*=A~Z,a~z,0~9,/,or blank), but the circuit and the electronic construction do not change, declared by the manufacturer.</i>	

Technical Characteristics of EUT	
Rated Voltage:	DC 5V
Rated Current:	/
Rated Power:	/
Power Adaptor Model:	/
Highest Internal Frequency:	Below 108MHz
Classification of Equipment:	Class B



1.2 Test Standards

The tests were performed according to following standards:

EN 55032:2015+A11:2020: Electromagnetic compatibility of multimedia equipment - Emission requirements.

EN 55035:2017+A11:2020: Electromagnetic compatibility of multimedia equipment - Immunity requirements.

Maintenance of compliance is the responsibility of the manufacturer. Any modification of the product maybe which result in lowering the emission/immunity should be checked to ensure compliance has been maintained.

1.3 Test Methodology

All measurements contained in this report were conducted with the standards EN 55032 and EN 55035 for electromagnetic compatibility of multimedia equipment, and all related testing and measurement techniques intentional standards.

WALTEK



1.4 EUT Setup and Operation Mode

The equipment under test (EUT) was configured to measure its highest possible emission/immunity level. The test modes were adapted according to the operation manual for use, more detailed description as follows:

Test Mode List			
Test Mode	Description	Remark	Power Supply Mode
TM1	Working mode	USB port is connect to Notebook	DC 5V(with notebook input)

EUT Cable List and Details				
Cable Description	Length (m)	Shielded/Unshielded	With / Without Ferrite	With / Without Chip
USB Cable	1.75	Shielded	Without	Without

Special Cable List and Details				
Cable Description	Length (m)	Shielded/Unshielded	With / Without Ferrite	With / Without Chip
/	/	/	/	/

Auxiliary Equipment List and Details			
Description	Manufacturer	Model	Serial Number
Notebook	Lenovo	XiaoXinPro 14IHU 2021	PF2V9FG1



1.5 Performance Criteria for EMS

All the test data has been collected, reduced, and analyzed within this report in accordance with Immunity requires the following as specific performance criteria:

- A. The apparatus shall continue to operate as intended during and after the test. The manufacturer specifies some minimum performance level. The performance level may be specified by the manufacturer as a permissible loss of performance.
- B. The apparatus shall continue to operate as intended after the test. This indicates that the EUT does not need to function at normal performance levels during the test, but must recover. Again some minimal performance is defined by the manufacturer. No change in operating state or loss of data is permitted.
- C. Temporary loss of function is allowed. Operation of the EUT may stop as long as it is either automatically reset or can be manually restored by operation of the controls.

WALTEK



1.6 Test Equipment List and Details

Description	Manufacturer	Model	Serial No.	Cal. Date	Due. Date
Spectrum Analyzer	Rohde & Schwarz	FSP	836079/035	2021-03-30	2022-03-29
EMI Test Receiver	Rohde & Schwarz	ESVB	825471/005	2021-04-12	2022-04-11
Amplifier	Agilent	8447F	3113A06717	2021-04-12	2022-04-11
Amplifier	C&D	PAP-1G18	2002	2021-04-12	2022-04-11
Trilog Broadband Antenna	Schwarz beck	VULB9163	9163-333	2021-03-20	2023-03-19
Horn Antenna	ETS	3117	00086197	2021-03-19	2023-03-18
Loop Antenna	Schwarz beck	FMZB 1516	9773	2021-03-20	2023-03-19
EMI Test Receiver	Rohde & Schwarz	ESPI	101391	2021-05-06	2022-05-05
Trilog Broadband Antenna	Schwarz beck	VULB9163(B)	9163-635	2021-04-09	2023-04-08
Amplifier	Agilent	8447D	2944A10179	2021-04-12	2022-04-11
EMI Test Receiver	Rohde & Schwarz	ESPI	101611	2021-04-12	2022-04-11
Pulse Limiter	Rohde & Schwarz	ESH3-Z2	100911	2021-04-15	2022-04-14
AC LISN	Schwarz beck	NSLK8126	8126-224	2021-04-12	2022-04-11
8-WIRE LISN	Schwarz beck	8158	CAT3-8158-0059	2021-04-12	2022-04-11
8-WIRE LISN	Schwarz beck	8158	CAT5-8158-0117	2021-04-12	2022-04-11
PMF Generator	LIONCEL	PMF-801C-C	0171101	2021-04-12	2022-04-11
PMF Antenna	LIONCEL	PMF-801C-A	0180302	2021-04-12	2022-04-11
Instantaneous PMF Generator Module	LIONCEL	PMF-801C-T	0171001	2021-04-12	2022-04-11
Digital Power Analyzer	California Instrument	CTS	72831	2021-04-12	2022-04-11
Power Source	California Instrument	5001IX-CTS-400	25965	2021-04-12	2022-04-11
ESD Generator	LIONCEL	ESD-203B	0170901	2021-04-16	2022-04-15
Transient 2000	EMC PARTNER	TRA2000	863	2021-04-12	2022-04-11
Couple Clamp	EMC PARTNER	CN-EFT1000	513	2021-04-12	2022-04-11
CONDUCTED IMMUNITY TEST SYSTEM	FRANKONIA	CIT-10/75	126B1247/2013	2021-01-08	2022-01-07
CDN	LIONCEL	CDN-T8	0210401	2021-05-06	2022-05-05
Attenuator	EMTEST	MA-5100/6BF2	1009	2021-03-30	2022-03-29
CDN	Luthi	L-801M2/M3	2665	2021-04-12	2022-04-11
Signal Generator	HP	8688B	3438A00604	2021-03-30	2022-03-29
Power Meter	KEITHLEY	3500	1162591	2021-03-27	2022-03-26
Power Meter	KEITHLEY	3500	1121428	2021-03-27	2022-03-26
RF Power Amplifier	MicoTop	MPA-80-1000-250	MPA1906239	2021-03-27	2022-03-26
RF Power Amplifier	MicoTop	MPA-80-1000-100	MPA1906238	2021-03-27	2022-03-26
Antenna	SCHWARZBECK	STLP 9129	9129 114	N/A	N/A



2. SUMMARY OF TEST RESULTS

Standards	Description of Test Item	Result
EN 55032	Conducted Emission	N/A
	Radiated Emission	Compliant
EN IEC 61000-3-2	Harmonic Current Emission	N/A
EN 61000-3-3	Voltage Fluctuation and Flicker	N/A
EN 55035	Electrostatic Discharge Immunity in accordance with EN 61000-4-2	Compliant
	Continuous RF electromagnetic field Disturbances Immunity in accordance with EN 61000-4-3	Compliant
	Electrical Fast Transient/Burst Immunity in accordance with EN 61000-4-4	N/A
	Surges Immunity in accordance with EN 61000-4-5	N/A
	Continuous induced RF disturbances Immunity in accordance with EN 61000-4-6	N/A
	Power-frequency Magnetic Fields Immunity in accordance With EN 61000-4-8	Compliant
	Voltage Dips/Interruptions Immunity in accordance with EN 61000-4-11	N/A
	Broadband impulse noise disturbances, repetitive	N/A
	Broadband impulse noise disturbances, isolated	N/A

N/A: not applicable



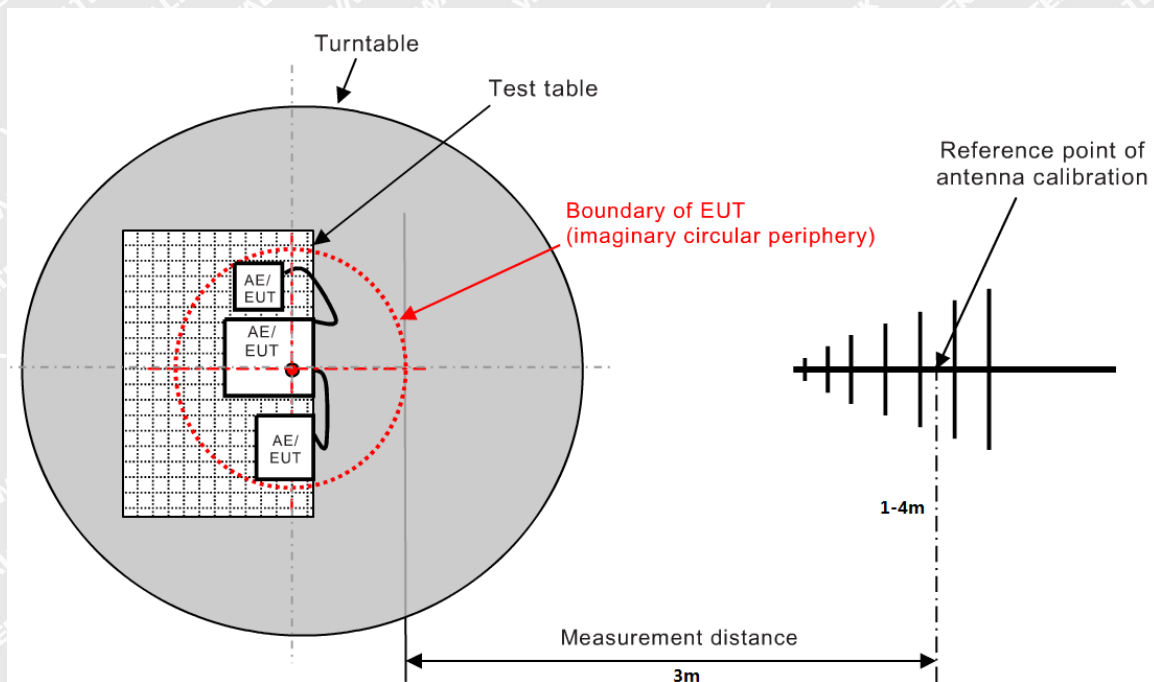
3. Radiated Emission

3.1 Measurement Uncertainty

Base on NIS 81, The Treatment of Uncertainty in EMC Measurements, the best estimate of the uncertainty of any radiation emissions measurement:

Measurement uncertainty		
Parameter	Conditions	Uncertainty
Radiated Emissions	Radiated	30-200MHz $\pm 4.52\text{dB}$
		0.2-1GHz $\pm 5.56\text{dB}$
		1-6GHz $\pm 3.84\text{dB}$
		6-18GHz $\pm 3.92\text{dB}$

3.2 Basic Test Setup Block Diagram





3.3 Corrected Amplitude & Margin Calculation

The Corrected Amplitude is calculated by adding the Antenna Factor and the Cable Factor, and subtracting the Amplifier Gain from the Amplitude reading. The basic equation is as follows:

$$\text{Corr. Ampl.} = \text{Indicated Reading} + \text{Correct Correct} = \text{Ant.Factor} + \text{Cable Loss} - \text{Ampl.Gain}$$

The “**Margin**” column of the following data tables indicates the degree of compliance with the applicable limit. For example, a margin of -6dB μ V means the emission is 6dB μ V below the maximum limit for Class B device. The equation for margin calculation is as follows:

$$\text{Margin} = \text{Corr. Ampl.} - \text{EN 55032 Class B Limit}$$

3.4 Environmental Conditions

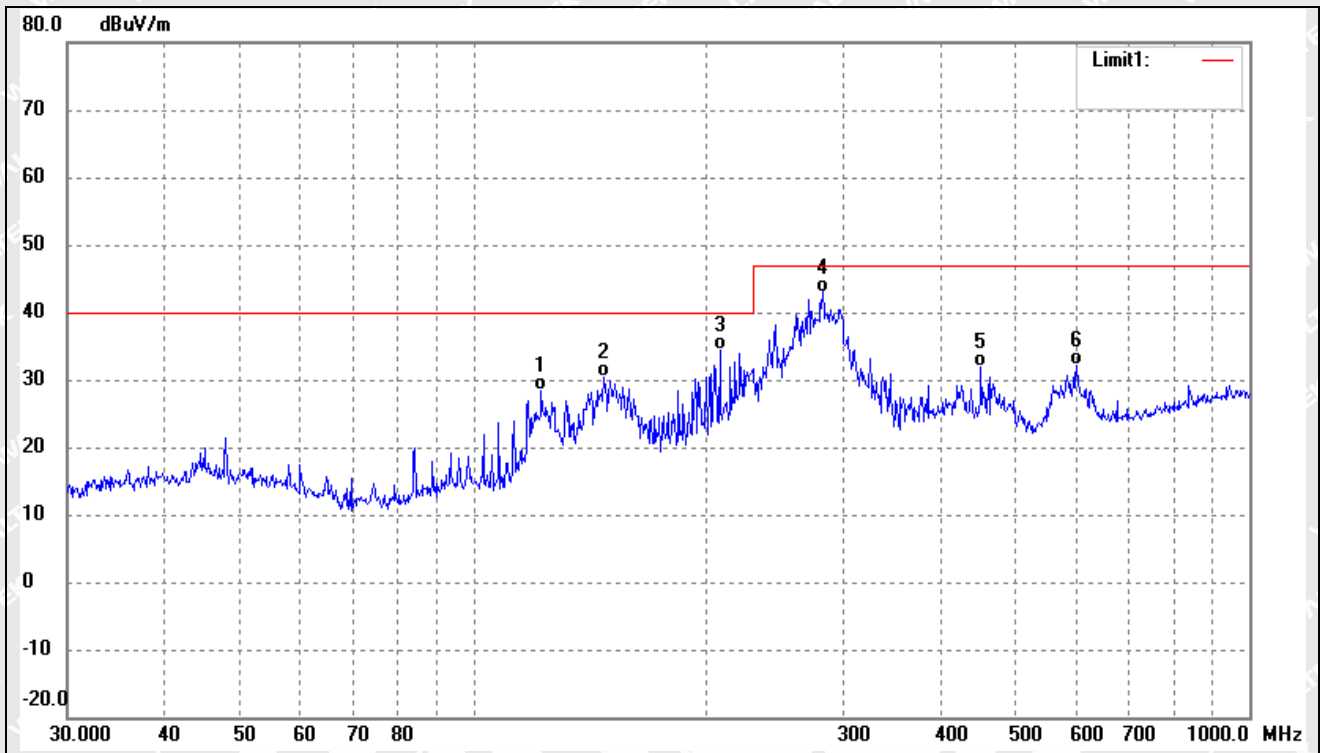
Temperature:	22.5° C
Relative Humidity:	54 %
ATM Pressure:	1010 mbar

3.5 Summary of Test Results

Please find the results below:



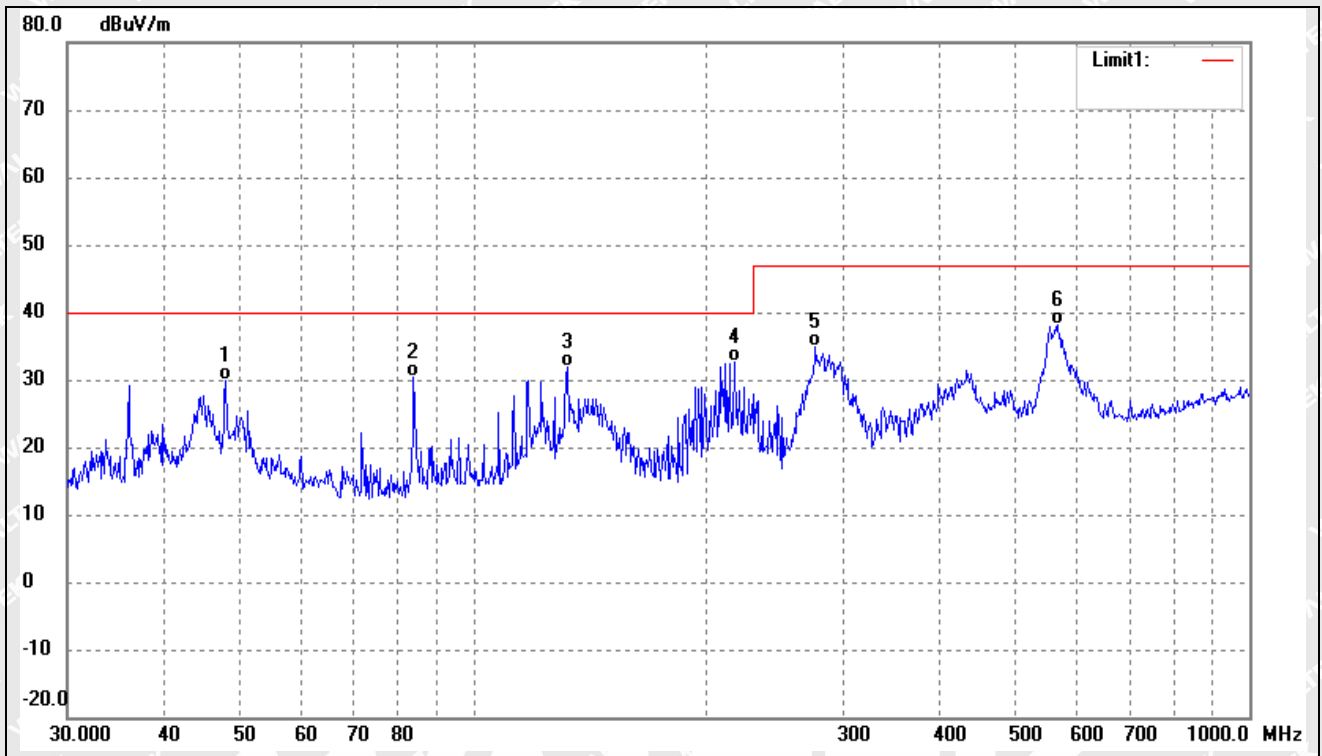
Test mode:	TM1	Polarity:	Horizontal
------------	-----	-----------	------------



No.	Frequency (MHz)	Reading (dBuV/m)	Correct dB/m	Result (dBuV/m)	Limit (dBuV/m)	Margin (dB)	Degree (°)	Height (cm)	Remark
1	122.4040	42.64	-14.14	28.50	40.00	-11.50	281	100	QP
2	147.4036	45.56	-15.27	30.29	40.00	-9.71	92	100	QP
3	207.8501	46.64	-12.17	34.47	40.00	-5.53	331	100	QP
4	281.9946	52.89	-9.89	43.00	47.00	-4.00	97	100	QP
5	451.1350	37.24	-5.45	31.79	47.00	-15.21	217	100	QP
6	599.3212	35.96	-3.76	32.20	47.00	-14.80	115	100	QP



Test mode:	TM1	Polarity:	Vertical
------------	-----	-----------	----------



No.	Frequency (MHz)	Reading (dBuV/m)	Correct (dB/m)	Result (dBuV/m)	Limit (dBuV/m)	Margin (dB)	Degree (°)	Height (cm)	Remark
1	47.9940	40.66	-10.89	29.77	40.00	-10.23	149	100	QP
2	83.8156	44.76	-14.32	30.44	40.00	-9.56	114	100	QP
3	132.2206	46.77	-14.89	31.88	40.00	-8.12	97	100	QP
4	216.7828	44.52	-11.90	32.62	40.00	-7.38	132	100	QP
5	276.1235	44.88	-10.08	34.80	47.00	-12.20	184	100	QP
6	566.6223	42.57	-4.37	38.20	47.00	-8.80	308	100	QP



4. Electrostatic Discharges (ESD)

4.1 Test Procedure

Test is conducted under the description of EN 61000-4-2.

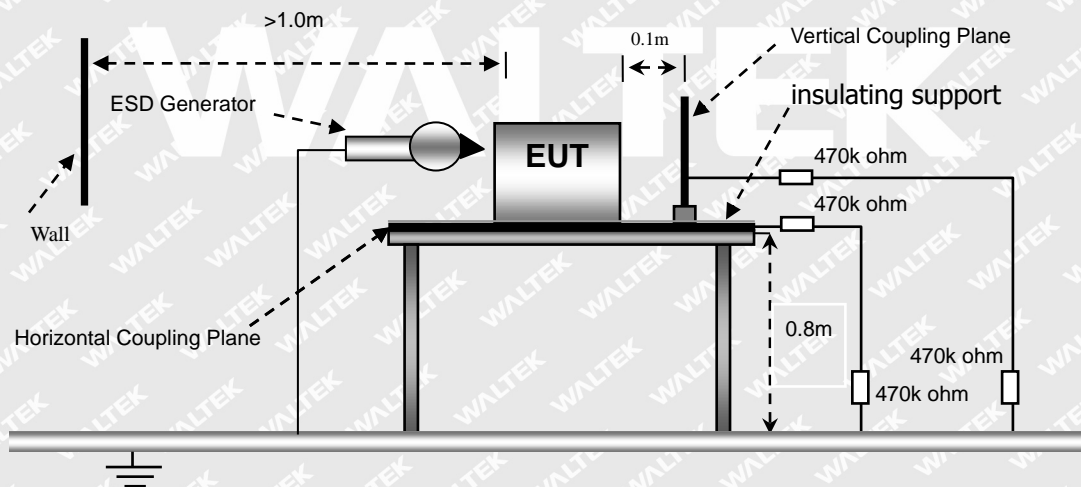
4.2 Test Performance

Performance Criterion: B

4.3 Environmental Conditions

Temperature:	20.5 °C
Relative Humidity:	47 %
ATM Pressure:	1012 mbar

4.4 Basic Test Setup Block Diagram





4.5 Electrostatic Discharge Immunity Test Data

Table 1: Electrostatic Discharge Immunity (Air Discharge)

EN 61000-4-2 Test Points	Test Voltage (kV)									
	-2	+2	-4	+4	-6	+6	-8	+8	-15	+15
New plastic shell	A	A	A	A	A	A	A	A	/	/
Shell crack	A	A	A	A	A	A	A	A	/	/

Table 2: Electrostatic Discharge Immunity (Direct Contact)

EN 61000-4-2 Test Points	Test Voltage (kV)									
	-2	+2	-4	+4	-6	+6	-8	+8	-15	+15
/	/	/	/	/	/	/	/	/	/	/

Table 3: Electrostatic Discharge Immunity (Indirect Contact HCP & VCP)

EN 61000-4-2 Test Points	Test Voltage (kV)									
	-2	+2	-4	+4	-6	+6	-8	+8	-15	+15
HCP (6 Sides)	A	A	A	A	/	/	/	/	/	/
VCP (4 Sides)	A	A	A	A	/	/	/	/	/	/

Test Result: Pass



5. Continuous RF Electromagnetic Field Disturbances (RS)

5.1 Test Procedure

Test is conducted under the description of EN 61000-4-3.

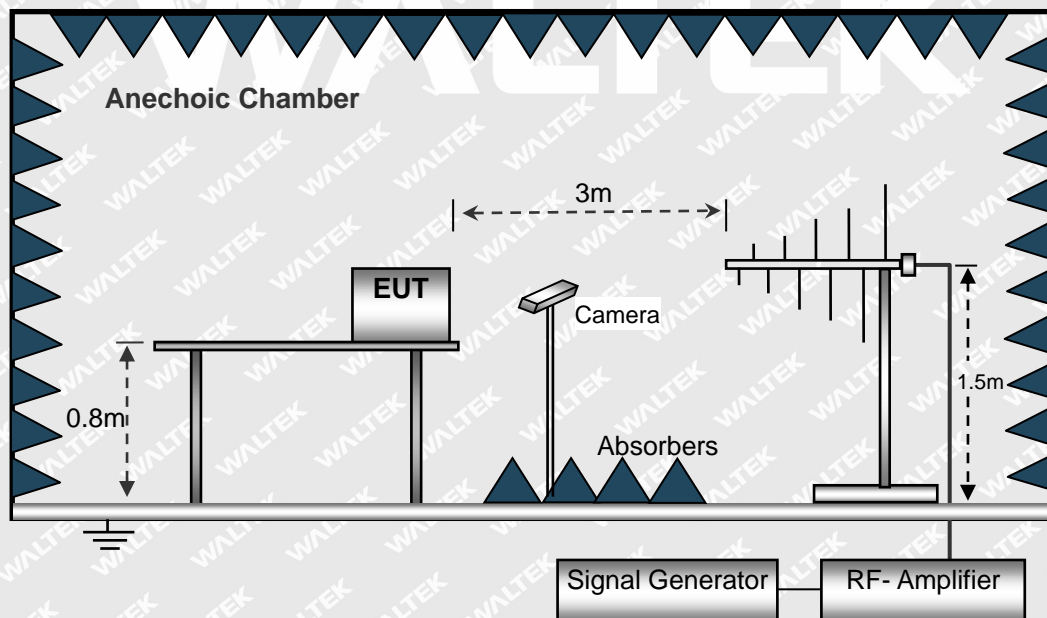
5.2 Test Performance

Performance Criterion: A

5.3 Environmental Conditions

Temperature:	23.0 °C
Relative Humidity:	54 %
ATM Pressure:	1011 mbar

5.4 Basic Test Setup Block Diagram





5.5 Continuous Radiated Disturbances Test Data

Frequency step: 1% of fundamental

Dwell time: 1 second

Modulation: AM by 1kHz sine wave with 80% modulation depth

Frequency Range(MHz)	Field (V/m)	Front		Rear		Left Side		Right Side	
		VERT	HORI	VERT	HORI	VERT	HORI	VERT	HORI
80-1000	3	A	A	A	A	A	A	A	A

Spot frequencies (MHz)	Field (V/m)	Front		Rear		Left Side		Right Side	
		VERT	HORI	VERT	HORI	VERT	HORI	VERT	HORI
1800	3	A	A	A	A	A	A	A	A
2600	3	A	A	A	A	A	A	A	A
3500	3	A	A	A	A	A	A	A	A
5000	3	A	A	A	A	A	A	A	A

Test Result: Pass



6. Power-Frequency Magnetic Fields (PFMF)

6.1 Test Procedure

Test is conducted under the description of EN 61000-4-8.

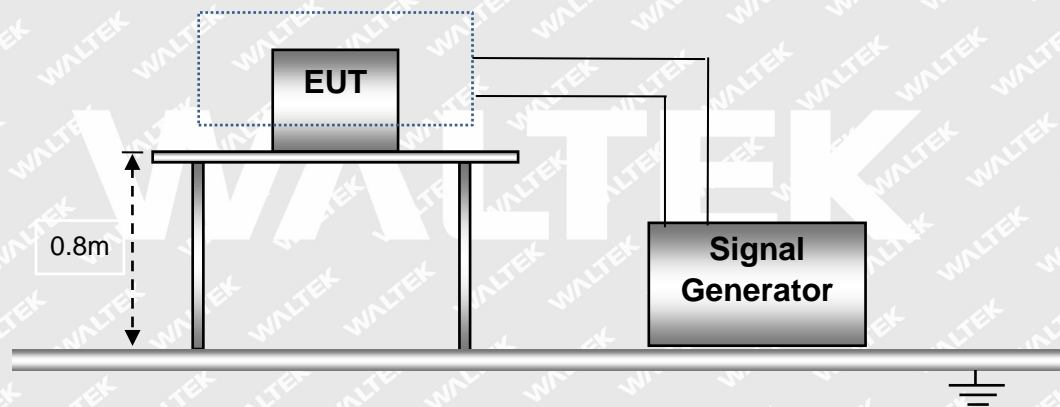
6.2 Test Performance

Performance Criterion: A

6.3 Environmental Conditions

Temperature:	23.0 °C
Relative Humidity:	52 %
ATM Pressure:	1013 mbar

6.4 Basic Test Setup Block Diagram



**6.5 Power-Frequency Magnetic Field Test Data**

Level	Magnetic Field Strength (r.m.s) A/m	Frequency Hz	Induction Coil Position	Pass	Fail
1	1	50	X, Y, Z	A	/
2	3	50	X, Y, Z	/	/
3	10	50	X, Y, Z	/	/
X	Special	/	/	/	/

Test Result: Pass

WALTEK



EXHIBIT 1 - PRODUCT LABELING

Proposed CE Label Format

<p>Gaming Mouse Model: AGM700*****(*=A~Z,a~z,0~9,/, or blank) Brand: TPV Importer Name: XXX Importer Address: XXX TPV Electronics (Fujian) Co., Ltd. HRongqiao Economic and Technological Development Zone, Fuqing City, Fujian Province, P.R.China</p>	
--	--

Specifications: Text is Black in color and is justified. Labels are printed in indelible ink on permanent adhesive backing or silk-screened onto the EUT or shall be affixed at a conspicuous location on the EUT. The 'CE' marking must be affixed to the EUT or to its data plate. Where this is not possible or not warranted on account of the nature of the apparatus, it must be affixed to the packaging, if any, and to the accompanying documents. The 'CE' marking is allowed less than 5 mm but must clear. If the 'CE' marking is reduced or enlarged the proportions given in the above graduated drawing must be respected. The Importer name, address and Manufacturer name and address should indicate on marking label or packaging or in a document accompanying.

Proposed Label Location on EUT

CE Label Location

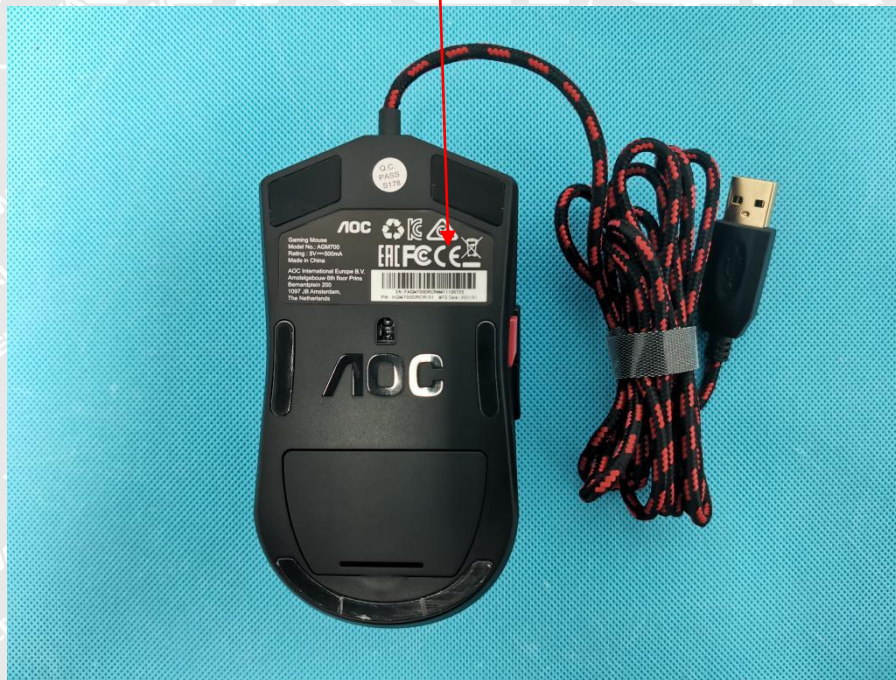
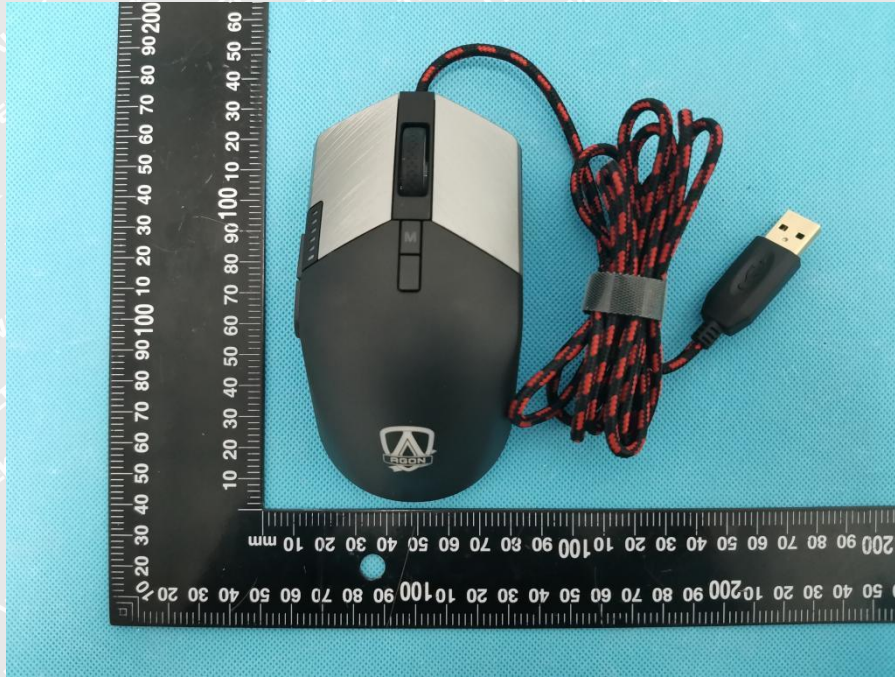




EXHIBIT 2 - EUT PHOTOGRAPHS

EUT View 1



EUT View 2





EUT View 3



EUT View 4





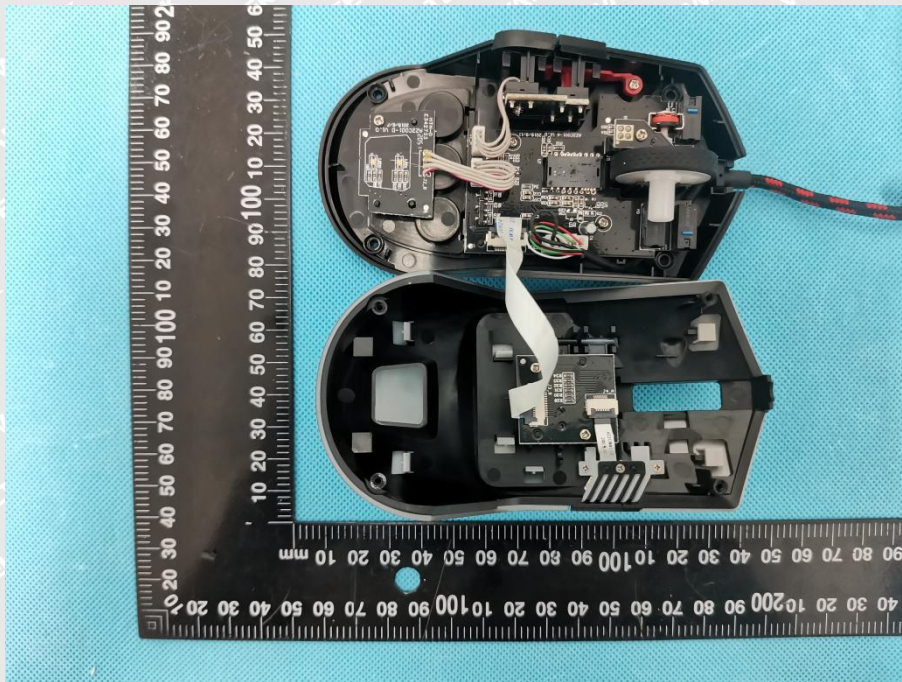
EUT View 5



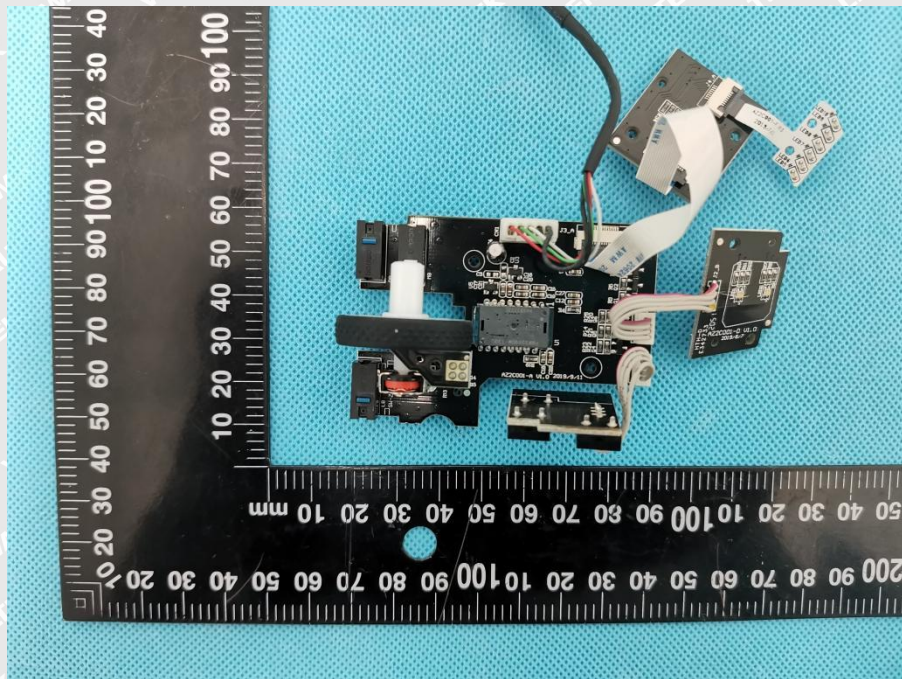
WALTEK



EUT Housing and Board View 1

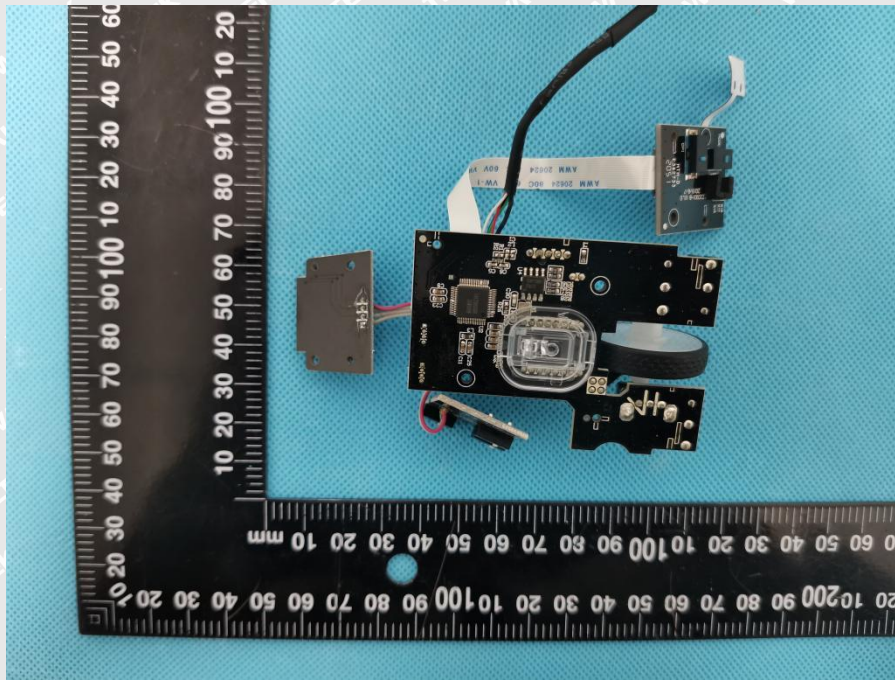


Solder Board-Component View 2





Solder Board-Component View 3

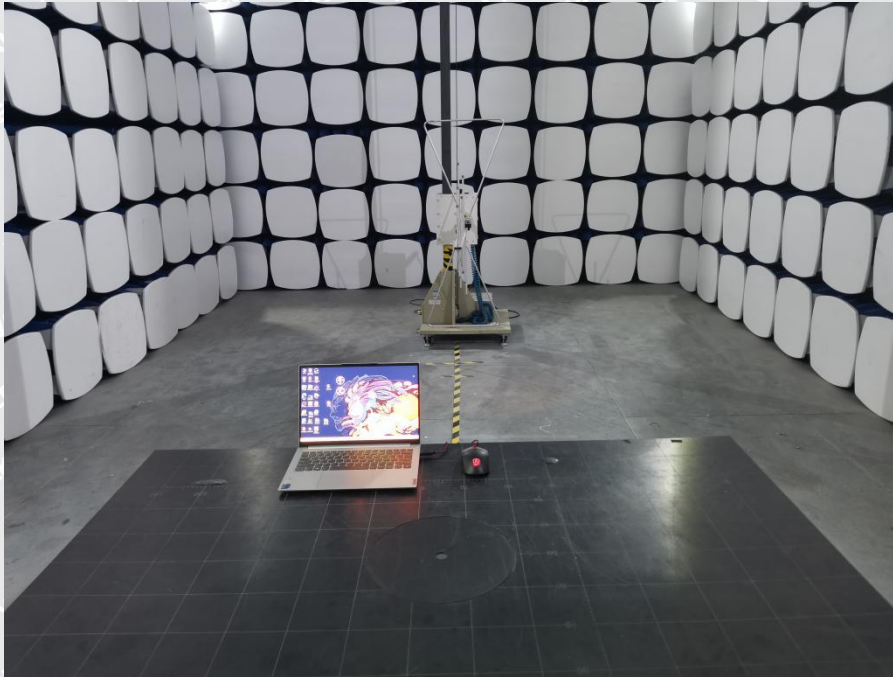


WALTEK

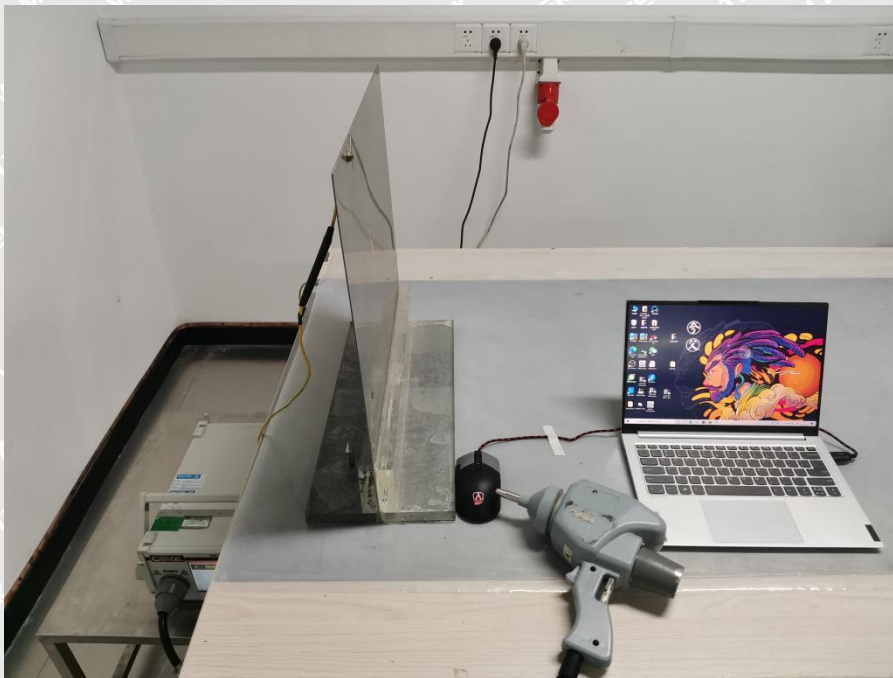


EXHIBIT 3 - TEST SETUP PHOTOGRAPHS

Radiation Emission Test View

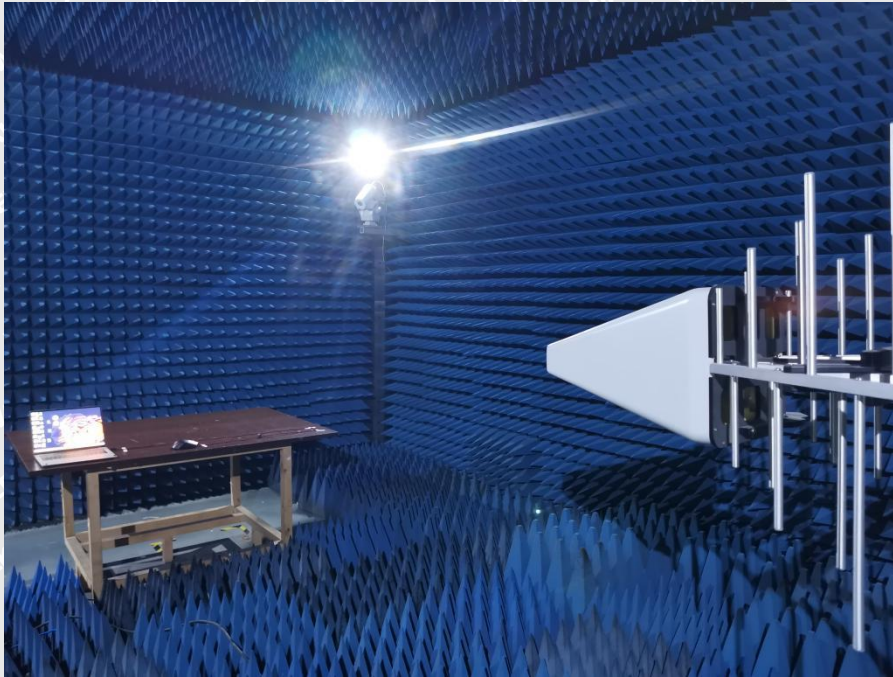


EN 61000-4-2 Test View



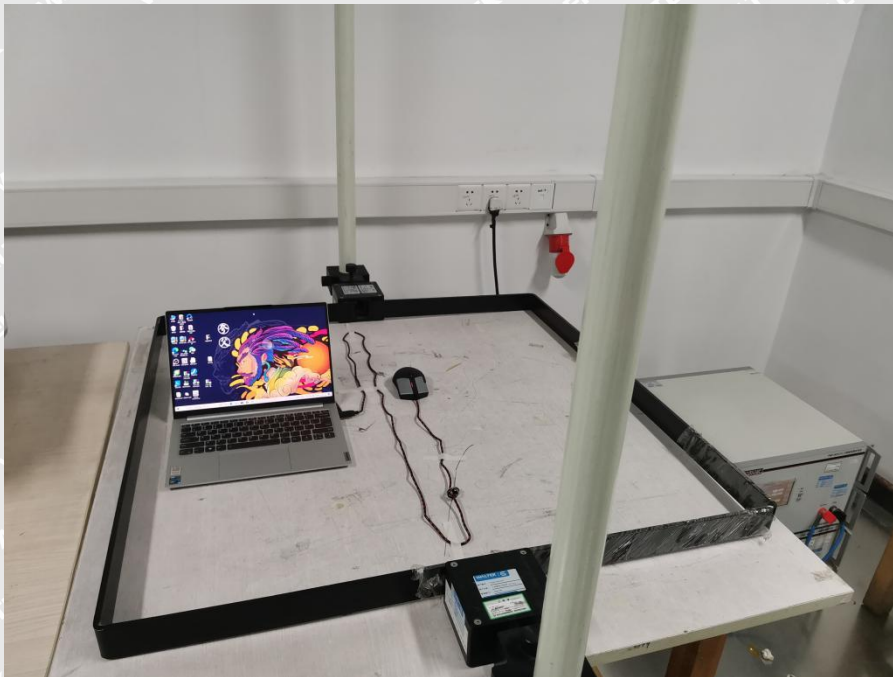


EN 61000-4-3 Test View



WALTEK

EN 61000-4-8 Test View



******* END OF REPORT *******