



CE&UKCA EMC Test Report

Project No. : 2409C261
Equipment : LCD Monitor
Brand Name : N/A
Model Name : 25G42E
Series Model : **25G4*****(*=0-9,A-Z,a-z,+,-,/,\ or blank)
Applicant : TPV Electronics (Fujian) Co., Ltd.
Address : Rongqiao Economic and Technological Development Zone, Fuqing City,
Fujian Province, P.R. China
Date of Receipt : Sep. 26, 2024
Date of Test : Sep. 26, 2024 ~ Oct. 16, 2024
Issued Date : Oct. 31, 2024
Report Version : R00
Test Sample : Engineering Sample No.: DG2024092639
Standard(s) : Please refer to Page 2.

The above equipment has been tested and found compliance with the requirement of the relative standards by BTL Inc.

Prepared by : _____
Albe Zhou

Approved by : _____
Kang Zhang

Room 108-116, 309-310, Building 2, No.1, Yile Road, Songshan Lake Zone, Dongguan City,
Guangdong, People's Republic of China

Tel: +86-769-8318-3000 Web: www.newbtl.com Service mail: btl_qa@newbtl.com

Standard(s) : EN 55032:2015
EN 55032:2015+A11:2020
EN 55032:2015+A1:2020
CISPR 32:2015+AMD1:2019
AS/NZS CISPR 32:2015+AMD1:2020
EN 61000-3-2:2014
EN IEC 61000-3-2:2019+A1:2021
EN 61000-3-3:2013
EN 61000-3-3:2013+A1:2019
EN 61000-3-3:2013+A2:2021
EN 55035:2017/CISPR 35:2016
EN 55035:2017+A11:2020

BS EN 55032:2015
BS EN 55032:2015+A11:2020
BS EN 55032:2015+A1:2020
BS EN 61000-3-2:2014
BS EN IEC 61000-3-2:2019+A1:2021
BS EN 61000-3-3:2013
BS EN 61000-3-3:2013+A1:2019
BS EN 61000-3-3:2013+A2:2021
BS EN 55035:2017
BS EN 55035:2017+A11:2020

Declaration

BTL represents to the client that testing is done in accordance with standard procedures as applicable and that test instruments used has been calibrated with standards traceable to international standard(s) and/or national standard(s).

BTL's reports apply only to the specific samples tested under conditions. It is manufacture's responsibility to ensure that additional production units of this model are manufactured with the identical electrical and mechanical components. **BTL** assumes no responsibility for the data provided by the customer, any statements, inferences or generalizations drawn by the customer or others from the reports issued by **BTL**.

The report must not be used by the client to claim product certification, approval, or endorsement by A2LA or any agency of the U.S. Government.

This report is the confidential property of the client. As a mutual protection to the clients, the public and ourselves, the test report shall not be reproduced, except in full, without our written approval.

BTL's laboratory quality assurance procedures are in compliance with the ISO/IEC 17025: 2017 requirements, and accredited by the conformity assessment authorities listed in this test report.

BTL is not responsible for the sampling stage, so the results only apply to the sample as received.

The information, data and test plan are provided by manufacturer which may affect the validity of results, so it is manufacturer's responsibility to ensure that the apparatus meets the essential requirements of applied standards and in all the possible configurations as representative of its intended use.

Limitation

For the use of the authority's logo is limited unless the Test Standard(s)/Scope(s)/Item(s) mentioned in this test report is (are) included in the conformity assessment authorities acceptance respective.

Please note that the measurement uncertainty is provided for informational purpose only and are not use in determining the Pass/Fail results.

Table of Contents	Page
REPORT ISSUED HISTORY	8
1 . SUMMARY OF TEST RESULTS	9
1.1 TEST FACILITY	11
1.2 MEASUREMENT UNCERTAINTY	11
1.3 TEST ENVIRONMENT CONDITIONS	13
2 . GENERAL INFORMATION	14
2.1 GENERAL DESCRIPTION OF EUT	14
2.2 DESCRIPTION OF TEST MODES	15
2.3 EUT OPERATING CONDITIONS	17
2.4 BLOCK DIAGRAM SHOWING THE CONFIGURATION OF SYSTEM TESTED	17
2.5 DESCRIPTION OF SUPPORT UNITS	17
3 . EMC EMISSION TEST- EN 55032:2015	19
3.1 RADIATED EMISSIONS UP TO 1 GHZ	19
3.1.1 LIMITS	19
3.1.2 MEASUREMENT INSTRUMENTS LIST	19
3.1.3 TEST PROCEDURE	20
3.1.4 DEVIATION FROM TEST STANDARD	20
3.1.5 TEST SETUP	20
3.1.6 MEASUREMENT DISTANCE	21
3.1.7 TEST RESULTS	22
3.2 RADIATED EMISSIONS ABOVE 1 GHZ	24
3.2.1 LIMITS	24
3.2.2 MEASUREMENT INSTRUMENTS LIST	24
3.2.3 TEST PROCEDURE	25
3.2.4 DEVIATION FROM TEST STANDARD	25
3.2.5 TEST SETUP	25
3.2.6 MEASUREMENT DISTANCE	26
3.2.7 TEST RESULTS	27
3.3 CONDUCTED EMISSION MEASUREMENT AT AC MAINS POWER PORTS	29
3.3.1 LIMITS	29
3.3.2 MEASUREMENT INSTRUMENTS LIST	29
3.3.3 TEST PROCEDURE	29
3.3.4 DEVIATION FROM TEST STANDARD	30
3.3.5 TEST SETUP	30
3.3.6 TEST RESULTS	31
4 . EMC EMISSION TEST- EN 55032:2015+A11:2020	33
4.1 RADIATED EMISSIONS UP TO 1 GHZ	33
4.1.1 LIMITS	33
4.1.2 MEASUREMENT INSTRUMENTS LIST	33

Table of Contents	Page
4.1.3 TEST PROCEDURE	34
4.1.4 DEVIATION FROM TEST STANDARD	34
4.1.5 TEST SETUP	34
4.1.6 MEASUREMENT DISTANCE	35
4.1.7 TEST RESULTS	36
4.2 RADIATED EMISSIONS ABOVE 1 GHZ	46
4.2.1 LIMITS	46
4.2.2 MEASUREMENT INSTRUMENTS LIST	46
4.2.3 TEST PROCEDURE	47
4.2.4 DEVIATION FROM TEST STANDARD	47
4.2.5 TEST SETUP	47
4.2.6 MEASUREMENT DISTANCE	48
4.2.7 TEST RESULTS	49
4.3 CONDUCTED EMISSION MEASUREMENT AT AC MAINS POWER PORTS	59
4.3.1 LIMITS	59
4.3.2 MEASUREMENT INSTRUMENTS LIST	59
4.3.3 TEST PROCEDURE	59
4.3.4 DEVIATION FROM TEST STANDARD	59
4.3.5 TEST SETUP	60
4.3.6 TEST RESULTS	61
4.4 HARMONIC CURRENT EMISSIONS TEST	69
4.4.1 LIMITS	69
4.4.2 MEASUREMENT INSTRUMENTS LIST	69
4.4.3 TEST PROCEDURE	69
4.4.4 DEVIATION FROM TEST STANDARD	69
4.4.5 TEST SETUP	69
4.4.6 TEST RESULTS	70
4.5 VOLTAGE FLUCTUATIONS (FLICKER) TEST	73
4.5.1 LIMITS	73
4.5.2 MEASUREMENT INSTRUMENTS LIST	73
4.5.3 TEST PROCEDURE	73
4.5.4 DEVIATION FROM TEST STANDARD	73
4.5.5 TEST SETUP	74
4.5.6 TEST RESULTS	75
5 . EMC IMMUNITY TEST	76
5.1 STANDARD COMPLIANCE/SEVERITY LEVEL/CRITERIA	76
5.2 GENERAL PERFORMANCE CRITERIA	79
5.3 ANNEX D (NORMATIVE) - DISPLAY AND DISPLAY OUTPUT FUNCTION	80
5.3.1 PERFORMANCE CRITERIA	80
5.4 ANNEX G (NORMATIVE) - AUDIO OUTPUT FUNCTION	81
5.4.1 PERFORMANCE CRITERIA	81
5.5 ELECTROSTATIC DISCHARGE IMMUNITY TEST (ESD)	82

Table of Contents	Page
5.5.1 TEST SPECIFICATION	82
5.5.2 MEASUREMENT INSTRUMENTS	82
5.5.3 TEST PROCEDURE	82
5.5.4 DEVIATION FROM TEST STANDARD	83
5.5.5 TEST SETUP	83
5.5.6 TEST RESULTS	84
5.6 RADIATED, RADIO-FREQUENCY, ELECTROMAGNETIC FIELD IMMUNITY TEST (RS)	87
5.6.1 TEST SPECIFICATION	87
5.6.2 MEASUREMENT INSTRUMENTS	87
5.6.3 TEST PROCEDURE	87
5.6.4 DEVIATION FROM TEST STANDARD	88
5.6.5 TEST SETUP	88
5.6.6 TEST RESULTS	90
5.7 ELECTRICAL FAST TRANSIENT/BURST IMMUNITY TEST (EFT)	93
5.7.1 TEST SPECIFICATION	93
5.7.2 MEASUREMENT INSTRUMENTS	93
5.7.3 TEST PROCEDURE	93
5.7.4 DEVIATION FROM TEST STANDARD	93
5.7.5 TEST SETUP	94
5.7.6 TEST RESULTS	95
5.8 SURGE IMMUNITY TEST (SURGE)	96
5.8.1 TEST SPECIFICATION	96
5.8.2 MEASUREMENT INSTRUMENTS	96
5.8.3 TEST PROCEDURE	96
5.8.4 DEVIATION FROM TEST STANDARD	96
5.8.5 TEST SETUP	97
5.8.6 TEST RESULTS	98
5.9 IMMUNITY TO CONDUCTED DISTURBANCES, INDUCED BY RADIO-FREQUENCY FIELDS TEST (CS)	99
5.9.1 TEST SPECIFICATION	99
5.9.2 MEASUREMENT INSTRUMENTS	99
5.9.3 TEST PROCEDURE	99
5.9.4 DEVIATION FROM TEST STANDARD	100
5.9.5 TEST SETUP	100
5.9.6 TEST RESULTS	101
5.10 POWER FREQUENCY MAGNETIC FIELD IMMUNITY TEST (PFMF)	103
5.10.1 TEST SPECIFICATION	103
5.10.2 MEASUREMENT INSTRUMENTS	103
5.10.3 TEST PROCEDURE	103
5.10.4 DEVIATION FROM TEST STANDARD	103
5.10.5 TEST SETUP	104
5.10.6 TEST RESULTS	105
5.11 VOLTAGE DIPS, SHORT INTERRUPTIONS AND VOLTAGE VARIATIONS IMMUNITY	

Table of Contents**Page**

TEST (DIPS)	106
5.11.1 TEST SPECIFICATION	106
5.11.2 MEASUREMENT INSTRUMENTS	106
5.11.3 TEST PROCEDURE	106
5.11.4 DEVIATION FROM TEST STANDARD	106
5.11.5 TEST SETUP	106
5.11.6 TEST RESULTS	107
6 . EUT TEST PHOTO	108

REPORT ISSUED HISTORY

Report No.	Version	Description	Issued Date	Note
BTL-EMC-1-2409C261	R00	Original report.	Oct. 31, 2024	Valid

1. SUMMARY OF TEST RESULTS

Test procedures according to the technical standards:

Emission			
Standard(s)	Test Item	Result	
EN 55032:2015 EN 55032:2015+A11:2020 EN 55032:2015+A1:2020 CISPR 32:2015+AMD1:2019 AS/NZS CISPR 32:2015+AMD1:2020 BS EN 55032:2015 BS EN 55032:2015+A11:2020 BS EN 55032:2015+A1:2020	Radiated emissions up to 1 GHz	PASS	
	Radiated emissions above 1 GHz	PASS	
	Radiated emissions from FM receivers	N/A	
	Conducted emissions AC mains power port	PASS	
	Asymmetric mode conducted emissions	AAN	N/A
		Current Probe	N/A
		CP+CVP	N/A
Conducted differential voltage emissions	N/A		

Standard(s)	Test Item	Result
EN 61000-3-2:2014 EN IEC 61000-3-2:2019+A1:2021 BS EN 61000-3-2:2014 BS EN IEC 61000-3-2:2019+A1:2021	Harmonic current	PASS
EN 61000-3-3:2013 EN 61000-3-3:2013+A1:2019 EN 61000-3-3:2013+A2:2021 BS EN 61000-3-3:2013 BS EN 61000-3-3:2013+A1:2019 BS EN 61000-3-3:2013+A2:2021	Voltage fluctuations (Flicker)	PASS

Immunity			
Standard(s)	Ref Standard(s)	Test Item	Result
EN 55035:2017/CISPR 35:2016 EN 55035:2017+A11:2020 BS EN 55035:2017 BS EN 55035:2017+A11:2020	IEC 61000-4-2:2008 EN 61000-4-2:2009	ESD	PASS
	IEC 61000-4-3:2020 EN IEC 61000-4-3:2020	RS	PASS
	IEC 61000-4-4:2012 EN 61000-4-4:2012	EFT	PASS
	IEC 61000-4-5:2014+AMD1:2017 EN 61000-4-5:2014+A1:2017	Surge	PASS
	IEC 61000-4-6:2013 EN 61000-4-6:2014+AC:2015	CS	PASS
	IEC 61000-4-8:2009 EN 61000-4-8:2010	PFMF	PASS
	IEC 61000-4-11:2020 EN IEC 61000-4-11:2020	Dips	PASS

Standard(s)	Section	Test Item	Result
EN 55035:2017/CISPR 35:2016 EN 55035:2017+A11:2020	4.2.7	BIN-R	N/A
BS EN 55035:2017 BS EN 55035:2017+A11:2020	4.2.7	BIN-I	N/A

NOTE:

- (1) "N/A" denotes test is not applicable to this device.

1.1 TEST FACILITY

The test facilities used to collect the test data in this report is

1# For RS / EFT/ SURGE / PFMF items: Room 108-116, 309-310, Building 2, No.1, Yile Road, Songshan Lake Zone, Dongguan City, Guangdong, People's Republic of China.

2# For other items: 1-2/F, 4/F, Building A, 1-2/F, Building B, 3/F, Building C, No.3, Jinshagang 1st Road, Dalang Town, Dongguan City, Guangdong People's Republic of China.

1.2 MEASUREMENT UNCERTAINTY

Where relevant, the following measurement uncertainty levels have been estimated for tests performed on the EUT as specified in CISPR 16-4-2, The BTL measurement uncertainty is less than the CISPR 16-4-2 U_{CISPR} requirement.

The reported uncertainty of measurement $y \pm U$, where expanded uncertainty U is based on a standard uncertainty multiplied by a coverage factor of $k=2$, providing a level of confidence of approximately **95%**.

A. Radiated emissions up to 1 GHz measurement:

Test Site	Method	Measurement Frequency Range	Ant. H / V	U ,(dB)
DG-CB08 (10m)	CISPR	30MHz ~ 200MHz	V	4.48
		30MHz ~ 200MHz	H	4.50
		200MHz ~ 1,000MHz	V	4.60
		200MHz ~ 1,000MHz	H	4.84

B. Radiated emissions above 1 GHz measurement:

Test Site	Method	Measurement Frequency Range	U ,(dB)
DG-CB08 (3m)	CISPR	1GHz ~ 6GHz	4.24

C. Conducted emissions AC mains power port measurement:

Test Site	Method	Measurement Frequency Range	U ,(dB)
DG-C02	CISPR	150kHz ~ 30MHz	2.88

D. Harmonic current / Voltage fluctuations (Flicker) measurement:

Test Site	Method	Item	U (%)
DG-C01	EN 61000-3-2 EN 61000-3-3	Current	0.757
		Voltage	0.592

E. Immunity Measurement:

Test Site	Method	Item	U
DG-SR02	IEC 61000-4-2	Rise time tr	7.00%
		Peak current Ip	6.50%
		Current at 30 ns	6.60%
		Current at 60 ns	6.80%
SSL-CB03	IEC 61000-4-3 (80MHz~6GHz)	Electromagnetic field immunity test	2.26dB
		On-ear acoustic & Acoustic measurements on loudspeakers	2.28dB
SSL-SR01	IEC 61000-4-4	Peak voltage (VP)	3.7%
		Rise time (tr)	4.4%
		Pulse width(tw)	4.2%
		Pulse Freq.(kHz)	0.7%
		Burst Duration(ms)	1.4%
		Burst Period(ms)	1.4%
SSL-SR01	IEC 61000-4-5	Open-Circuit Output Voltage (1.2/50us)	4.0%
		Open circuit front time (1.2/50us)	6.1%
		Open circuit time of half value (1.2/50us)	4.7%
DG-CB06	IEC 61000-4-6 (150kHz-80MHz)	CDN	1.28dB
		On-ear acoustic & Acoustic measurements on loudspeakers	1.36dB
SSL-SR01	IEC 61000-4-8	Magnetic Field Strength	1.91%
DG-SR01	IEC 61000-4-11	DIP Amplitude	3.6%
		DIP Time Event	4.0%

Note: Unless specifically mentioned, the uncertainty of measurement has not been taken into account to declare the compliance or non-compliance to the specification.

1.3 TEST ENVIRONMENT CONDITIONS

Test Item	Temperature	Humidity	Tested By	Test Date
Radiated emissions up to 1 GHz	21°C	46%	Zinco Chen	Oct. 12, 2024
Radiated emissions above 1 GHz	21°C	46%	Zinco Chen	Oct. 12, 2024
Conducted emissions AC mains power port	25°C	50%	Yang Yan	Sep. 29, 2024
Harmonic current	24°C	55%	Bernie Wu	Sep. 30, 2024
Voltage fluctuations (Flicker)	24°C	55%	Bernie Wu	Oct. 01, 2024

Test Item	Temperature	Humidity	Pressure	Tested By	Test Date
ESD	27°C	48%	1012hPa	Jerry Lu	Sep. 27, 2024
RS	23°C	44%	/	Kieran Huang	Oct. 09, 2024
EFT	24°C	65%	/	Jason Fang	Oct. 09, 2024
Surge	24°C	65%	/	Jason Fang	Oct. 09, 2024
CS	23°C	61%	/	Penn Li	Sep. 26, 2024- Sep. 27, 2024
PFMF	24°C	65%	/	Jason Fang	Oct. 09, 2024
Dips	27°C	60%	/	Ellery Liang	Sep. 28, 2024

2. GENERAL INFORMATION

2.1 GENERAL DESCRIPTION OF EUT

Equipment	LCD Monitor
Brand Name	N/A
Model Name	25G42E
Series Model	**25G4*****(*=0-9,A-Z,a-z,+,-,/, \ or blank)
Model Difference(s)	Only differ in model name due to marketing purpose.
Identification No. of EUT(S/N)	N/A
Dimensions and mass	560.1*427.7*193.9mm(W*H*D)
Component unit of EUT	<input checked="" type="checkbox"/> Single unit <input type="checkbox"/> Multiple unit
Sample Status	<input checked="" type="checkbox"/> Engineering sample <input type="checkbox"/> Final shipment prototype
Power Source	AC Mains.
Power Rating	100-240V ~ 50/60Hz 1.5A
Connecting I/O Port(s)	1* AC port 1* HDMI port 1* DP port 1* Earphone port
Classification of EUT	Class B
Highest Internal Frequency(Fx)	415.6MHz

Cable Type	Shielded Type	Ferrite Core	Length(m)	Note
AC Power Cord	Non-shielded	NO	1.8/1.5/1.2	-
HDMI	Shielded	YES	1.8/1.5/1.2	Bonded two Ferrite Cores
DP	Shielded	NO	1.8/1.5/1.2	-

Note:

1. For a more detailed features description, please refer to the manufacturer's specifications or the user's manual.

2.2 DESCRIPTION OF TEST MODES

To investigate the maximum EMI emission characteristics generated from EUT, the test system was pre-scanning tested based on the consideration of following EUT operation mode or test configuration mode which possibly have effect on EMI emission level. Each of these EUT operation mode(s) or test configuration mode(s) mentioned above was evaluated respectively.

Pretest Mode	Description
Mode 1	HDMI 1920*1080/180Hz 1.8m
Mode 2	HDMI 1920*1080/60Hz 1.8m
Mode 3	DP 1920*1080/180Hz 1.8m
Mode 4	HDMI 1080P 1.8m DVD
Mode 5	HDMI 1280*1024/60Hz 1.8m
Mode 6	HDMI 640*480/60Hz 1.8m
Mode 7	HDMI 1920*1080/180Hz 1.5m
Mode 8	DP 1920*1080/180Hz 1.5m
Mode 9	HDMI 1920*1080/180Hz 1.2m
Mode 10	DP 1920*1080/180Hz 1.2m
Mode 11	HDMI 1920*1080/180Hz 1.8m(Without Earphone)

Radiated emissions up to 1 GHz Test	
Final Test Mode	Description
Mode 1	HDMI 1920*1080/180Hz 1.8m
Mode 3	DP 1920*1080/180Hz 1.8m
Mode 4	HDMI 1080P 1.8m DVD
Mode 11	HDMI 1920*1080/180Hz 1.8m(Without Earphone)

Radiated emissions Above 1 GHz Test	
Final Test Mode	Description
Mode 1	HDMI 1920*1080/180Hz 1.8m
Mode 3	DP 1920*1080/180Hz 1.8m
Mode 4	HDMI 1080P 1.8m DVD
Mode 11	HDMI 1920*1080/180Hz 1.8m(Without Earphone)

Conducted emissions AC mains power port Test	
Final Test Mode	Description
Mode 1	HDMI 1920*1080/180Hz 1.8m
Mode 3	DP 1920*1080/180Hz 1.8m
Mode 4	HDMI 1080P 1.8m DVD

Harmonic current & Voltage fluctuations (Flicker) Test	
Final Test Mode	Description
Mode 1	HDMI 1920*1080/180Hz 1.8m

Immunity Test	
Final Test Mode	Description
Mode 1	HDMI 1920*1080/180Hz 1.8m
Mode 2	HDMI 1920*1080/60Hz 1.8m
Mode 3	DP 1920*1080/180Hz 1.8m
Mode 4	HDMI 1080P 1.8m DVD
Mode 7	HDMI 1920*1080/180Hz 1.5m
Mode 8	DP 1920*1080/180Hz 1.5m
Mode 9	HDMI 1920*1080/180Hz 1.2m
Mode 10	DP 1920*1080/180Hz 1.2m

Note:

1. For EMI: the standard of EN 55032:2015+A11:2020 tested all the modes, and the EN 55032:2015 tested the worst case and recorded in the test report.
2. For Radiated emissions: Evaluated the mode 1-11. The worst case is Mode 1. According to the client's requirement, choose mode 1, mode 3, mode 4, and mode 11 and recorded in test report.
3. For Conducted emissions: Evaluated the mode 1-10. The worst case is Mode 1. According to the client's requirement, choose mode 1, mode 3, and mode 4 and recorded in test report.
4. RS: The Front, Rear, Left and Right were evaluated. The worst placement direction has recorded in this report.
5. The audio output function of CS/RS is recorded the worst mode.

2.3 EUT OPERATING CONDITIONS

The EUT exercise program used during radiated and/or conducted emission measurement was designed to exercise the various system components in a manner similar to a typical use. The standard test signals and output signal as following:

1. EUT connected to Earphone via Earphone Cable.
2. EUT connected to PC via HDMI & DP Cable.
3. PC connected to Mouse & Keyboard via USB Cable.

2.4 BLOCK DIAGRAM SHOWING THE CONFIGURATION OF SYSTEM TESTED

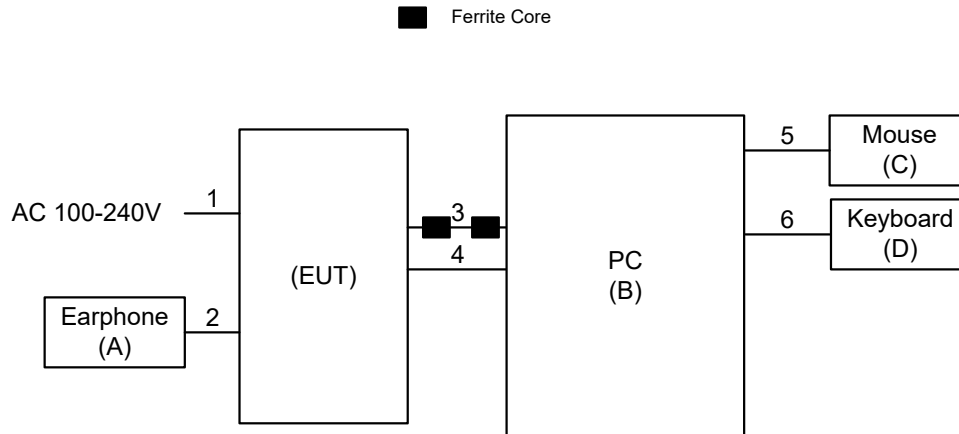

Ground Plane

Remote system

2.5 DESCRIPTION OF SUPPORT UNITS

The EUT has been tested as an independent unit together with other necessary accessories or support units. The following support units or accessories were used to form a representative test configuration during the tests.

For RS / EFT/ SURGE / PFMF items:

Item	Equipment	Mfr/Brand	Model/Type No.	Series No.
A	Earphone	APPLE	NA	NA
B	PC	DELL	optiplex 7080	72FZWF3
C	Mouse	DELL	MS116T1	N/A
D	Keyboard	DELL	KB216D1	N/A

For other items:

Item	Equipment	Mfr/Brand	Model/Type No.	Series No.
A	Earphone Cable	APPLE	NA	NA
B	PC	DELL	8920-D16N8S	GZS91L2
C	Mouse	DELL	MS111-P	CN011D3V71581279OLOT
D	Keyboard	DELL	KB212-B	CN0HTXH97158125004DXA01

Item	Cable Type	Shielded Type	Ferrite Core	Length
1	AC Cable	NO	NO	1.8/1.5/1.2m
2	Earphone Cable	NO	NO	1.2m
3	HDMI Cable	YES	YES	1.8/1.5/1.2m
4	DP Cable	YES	NO	1.8/1.5/1.2m
5	USB Cable	YES	NO	1.8m
6	USB Cable	YES	NO	1.8m

3. EMC EMISSION TEST- EN 55032:2015

3.1 RADIATED EMISSIONS UP TO 1 GHZ

3.1.1 LIMITS

Class B equipment up to 1 GHz

Frequency Range MHz	Measurement			Class B limits dB(μV/m)
	Facility	Distance m	Detector type/ bandwidth	
30 - 230	SAC	10	Quasi peak / 120 kHz	30
230 - 1000				37

Notes:

- (1) The limit for radiated test was performed according to as following: EN 55032
- (2) The tighter limit applies at the band edges.
- (3) Emission level (dBuV/m)=20log Emission level (uV/m).
- (4) The test result calculated as following:
 Measurement Value = Reading Level + Correct Factor
 Correct Factor = Antenna Factor + Cable Loss - Amplifier Gain(if use)
 Margin Level = Measurement Value - Limit Value

3.1.2 MEASUREMENT INSTRUMENTS LIST

Item	Kind of Equipment	Manufacturer	Type No.	Serial No.	Calibrated until
1	EMI Test Receiver	Keysight	N9038A	MY56400060	Dec. 22, 2024
2	MXE EMI Receiver	Agilent	N9038A	MY53220133	Jun. 01, 2025
3	Pre-Amplifier	EMC INSTRUMENT	EMC 9135	980284	May 31, 2025
4	Pre-Amplifier	EMC INSTRUMENT	EMC 9135	980283	May 31, 2025
5	Trilog-Broadband Antenna	Schwarzbeck	VULB9168	947	Nov. 10, 2024
6	Attenuator	EMCI	EMCI-N-6-06	AT-N0670	Nov. 10, 2024
7	Trilog-Broadband Antenna	Schwarzbeck	VULB9168	1461	Nov. 28, 2024
8	Attenuator	EMC INSTRUMENT	EMCI-N-6-06	AT-06010	Nov. 28, 2024
9	Measurement Software	Farad	EZ-EMC Ver.BTL-2ANT-1	N/A	N/A
10	Multi-Device Controller	ETS-Lindgren	2090	N/A	N/A
11	Controller	MF	MF-7802	MF780208159	N/A
12	Cable	RW	LMR400-NMNM-10M	N/A	Dec. 03, 2024
13	Cable	RW	LMR400-NMNM-7M	N/A	Dec. 03, 2024
14	Cable	RW	LMR400-NMNM-3.5M	N/A	Dec. 03, 2024
15	Cable	RW	LMR400-NMNM-7M	N/A	Sep. 04, 2025
16	Cable	RW	LMR400-NMNM-8M	N/A	Sep. 04, 2025
17	Cable	RW	LMR400-NMNM-3.5M	N/A	Sep. 04, 2025

Remark: "N/A" denotes no model name, no serial no. or no calibration specified.

All calibration period of equipment list is one year.

3.1.3 TEST PROCEDURE

- The measuring distance of 10 m shall be used for measurements. The EUT was placed on the top of a rotating table 0.8 meter above the ground at a 10 meter semi-anechoic chamber. The table was rotated 360 degrees to determine the position of the highest radiation.
- The height of the equipment or of the substitution antenna shall be 0.8 m, the height of the test antenna shall vary between 1 m to 4 m. Both horizontal and vertical polarizations of the antenna are set to make the measurement.
- The initial step in collecting radiated emission data is a receiver peak detector mode pre-scanning the measurement frequency range. Significant peaks are then marked and then Quasi Peak detector mode re-measured.
- All readings are Peak unless otherwise stated QP in column of Note. Peak denotes that the Peak reading compliance with the QP Limits and then QP Mode measurement didn't perform.
- For the actual test configuration, please refer to the related Item - EUT Test Photos.

3.1.4 DEVIATION FROM TEST STANDARD

No deviation

3.1.5 TEST SETUP

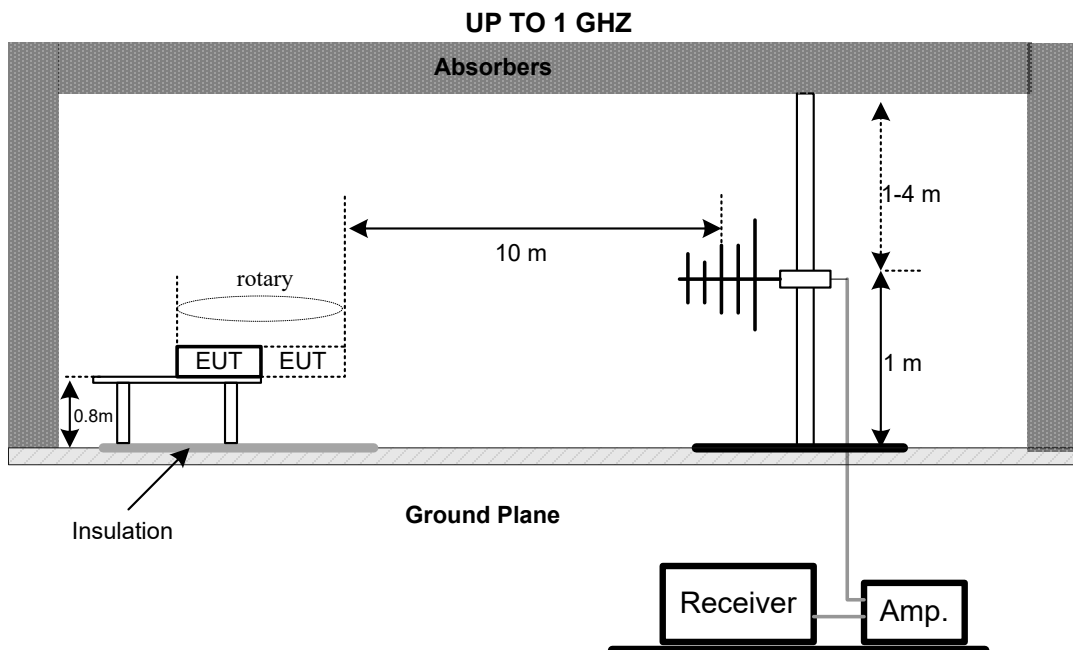

3.1.6 MEASUREMENT DISTANCE

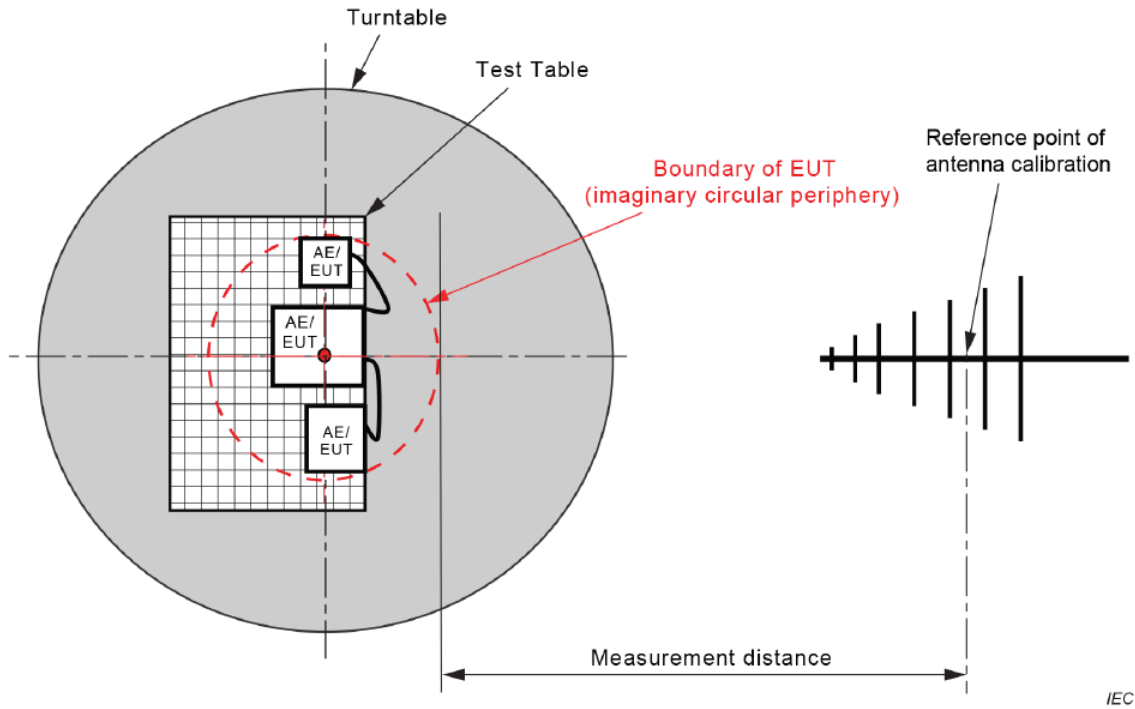

IEC

Figure C.1 – Measurement distance

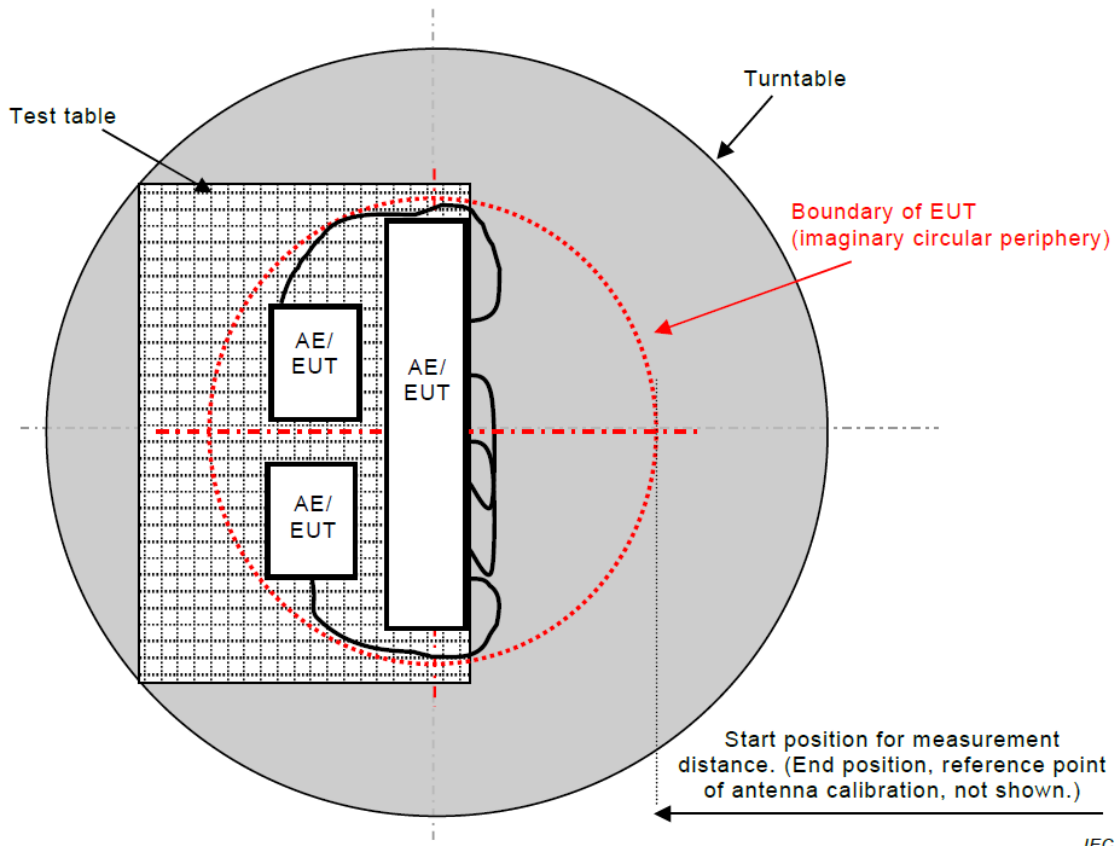

IEC

Figure C.2 – Boundary of EUT, Local AE and associated cabling

3.1.7 TEST RESULTS

Test Voltage	AC 230V/50Hz	Polarization	Vertical
Test Mode	Mode 1		

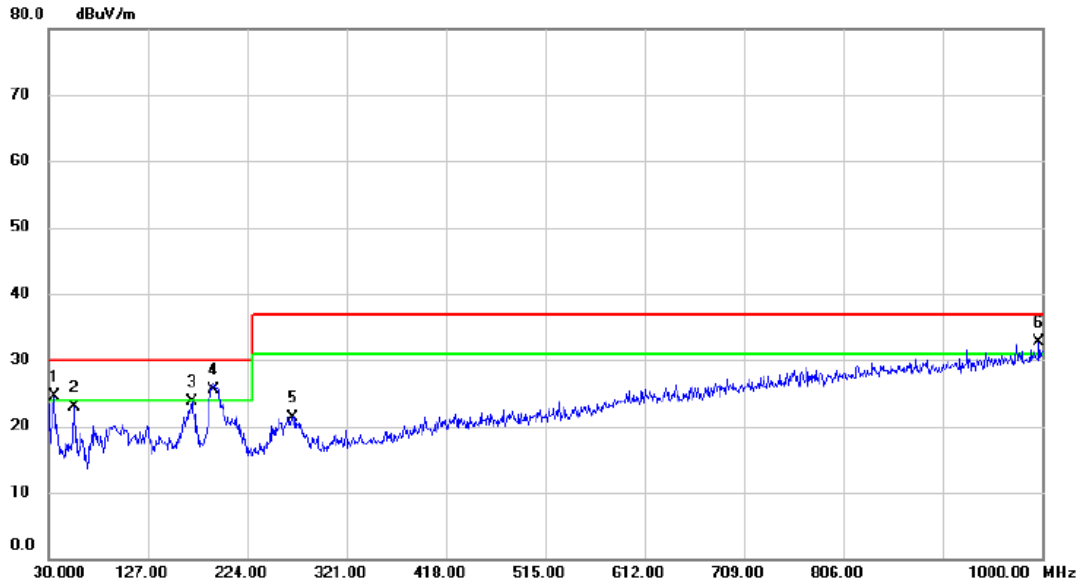

No.	Mk.	Freq. MHz	Reading Level dBuV	Correct Factor dB	Measure- ment dBuV/m	Limit dBuV/m	Margin dB	Detector	Comment
1	!	35.8200	42.42	-17.88	24.54	30.00	-5.46	QP	
2		55.2200	39.76	-16.90	22.86	30.00	-7.14	QP	
3		169.6800	39.00	-15.28	23.72	30.00	-6.28	QP	
4	!	191.0200	43.38	-17.89	25.49	30.00	-4.51	QP	
5		268.6200	36.62	-15.26	21.36	37.00	-15.64	QP	
6	*	997.0900	34.63	-1.87	32.76	37.00	-4.24	QP	

Test Voltage	AC 230V/50Hz	Polarization	Horizontal
Test Mode	Mode 1		

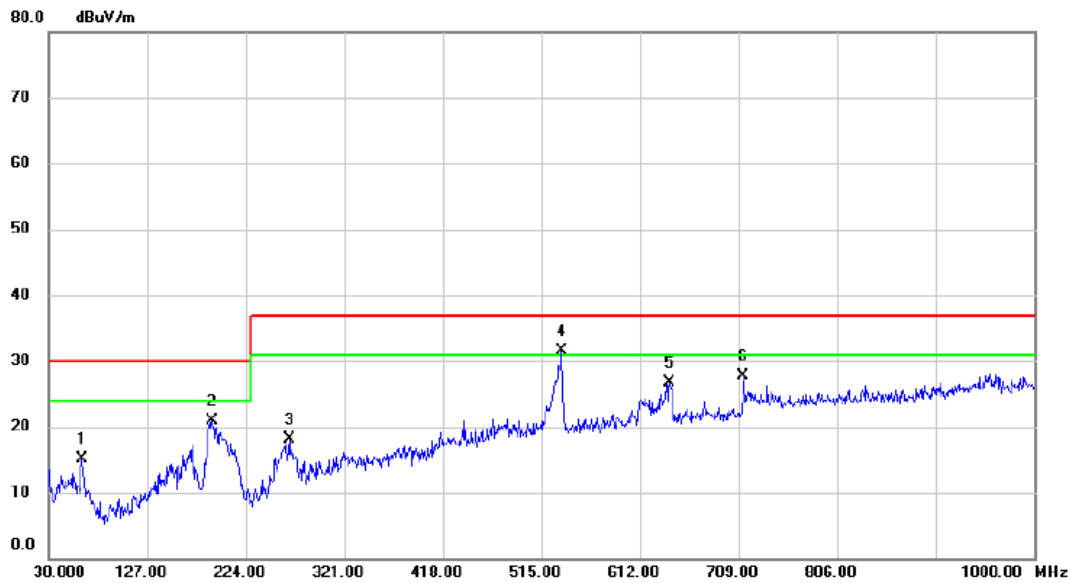

No.	Mk.	Freq. MHz	Reading Level dBuV	Correct Factor dB	Measure- ment dBuV/m	Limit dBuV/m	Margin dB	Detector	Comment
1		62.9800	34.07	-18.97	15.10	30.00	-14.90	QP	
2		191.0200	40.11	-19.15	20.96	30.00	-9.04	QP	
3		266.6800	35.09	-16.94	18.15	37.00	-18.85	QP	
4	*	535.3700	42.01	-10.60	31.41	37.00	-5.59	QP	
5		641.1000	35.75	-9.05	26.70	37.00	-10.30	QP	
6		713.8500	36.23	-8.55	27.68	37.00	-9.32	QP	

3.2 RADIATED EMISSIONS ABOVE 1 GHZ

3.2.1 LIMITS

Class B equipment above 1 GHz

Frequency Range MHz	Measurement			Class B limits dB(μV/m)
	Facility	Distance m	Detector type/bandwidth	
1000 - 3000	FSOATS	3	Average / 1 MHz	50
3000 - 6000				54
1000 - 3000			Peak / 1 MHz	70
3000 - 6000				74

Notes:

- (1) The limit for radiated test was performed according to as following: EN 55032
- (2) The tighter limit applies at the band edges.
- (3) Emission level (dBuV/m)=20log Emission level (uV/m).
- (4) The test result calculated as following:
 Measurement Value = Reading Level + Correct Factor
 Correct Factor = Antenna Factor + Cable Loss - Amplifier Gain(if use)
 Margin Level = Measurement Value - Limit Value

Required highest frequency for radiated measurement

Highest internal frequency (F _x)	Highest measured frequency
F _x ≤ 108 MHz	1 GHz
108 < F _x ≤ 500 MHz	2 GHz
500 < F _x ≤ 1000 MHz	5 GHz
F _x > 1 GHz	5 x F _x up to a maximum of 6 GHz

3.2.2 MEASUREMENT INSTRUMENTS LIST

Item	Kind of Equipment	Manufacturer	Type No.	Serial No.	Calibrated until
1	Horn Antenna	ETS	3115	9605-4803	Jul. 07, 2025
2	MXE EMI Receiver	Agilent	N9038A	MY53220133	Jun. 01, 2025
3	Preamplifier	EMC INSTRUMENT	EMC118A45SE	981003	Nov. 17, 2024
4	Measurement Software	Farad	EZ-EMC Ver.BTL-2ANT-1	N/A	N/A
5	Multi-Device Controller	ETS-Lindgren	2090	N/A	N/A
6	Controller	MF	MF-7802	MF780208159	N/A
7	Cable	RegalWay	RWLP50-4.0A-S MSM-9M	N/A	Sep. 02, 2025
8	Cable	RW	RWLP50-4.0A-N MRASM-1M	N/A	Sep. 02, 2025
9	Cable	RW	RWLP50-4.0A-N MRASM-4M	N/A	Sep. 02, 2025

Remark: "N/A" denotes no model name, no serial no. or no calibration specified.

All calibration period of equipment list is one year.

3.2.3 TEST PROCEDURE

- The measuring distance of 3 m shall be used for measurements. The EUT was placed on the top of a rotating table 0.8 meter above the ground at a 10 meter semi-anechoic chamber. The table was rotated 360 degrees to determine the position of the highest radiation.
- The height of the equipment or of the substitution antenna shall be 0.8 m, the height of the test antenna shall vary between 1 m to 4 m. Both horizontal and vertical polarizations of the antenna are set to make the measurement.
- The initial step in collecting radiated emission data is a receiver peak detector mode pre-scanning the measurement frequency range. Significant peaks are then marked and then AVG detector mode re-measured.
- All readings are Peak Mode value unless otherwise stated AVG in column of Note. If the Peak Mode Measured value compliance with the Peak Limits and lower than AVG Limits, the EUT shall be deemed to meet both Peak & AVG Limits and then only Peak Mode was measured, but AVG Mode didn't perform.
- For the actual test configuration, please refer to the related Item - EUT Test Photos.

3.2.4 DEVIATION FROM TEST STANDARD

No deviation

3.2.5 TEST SETUP

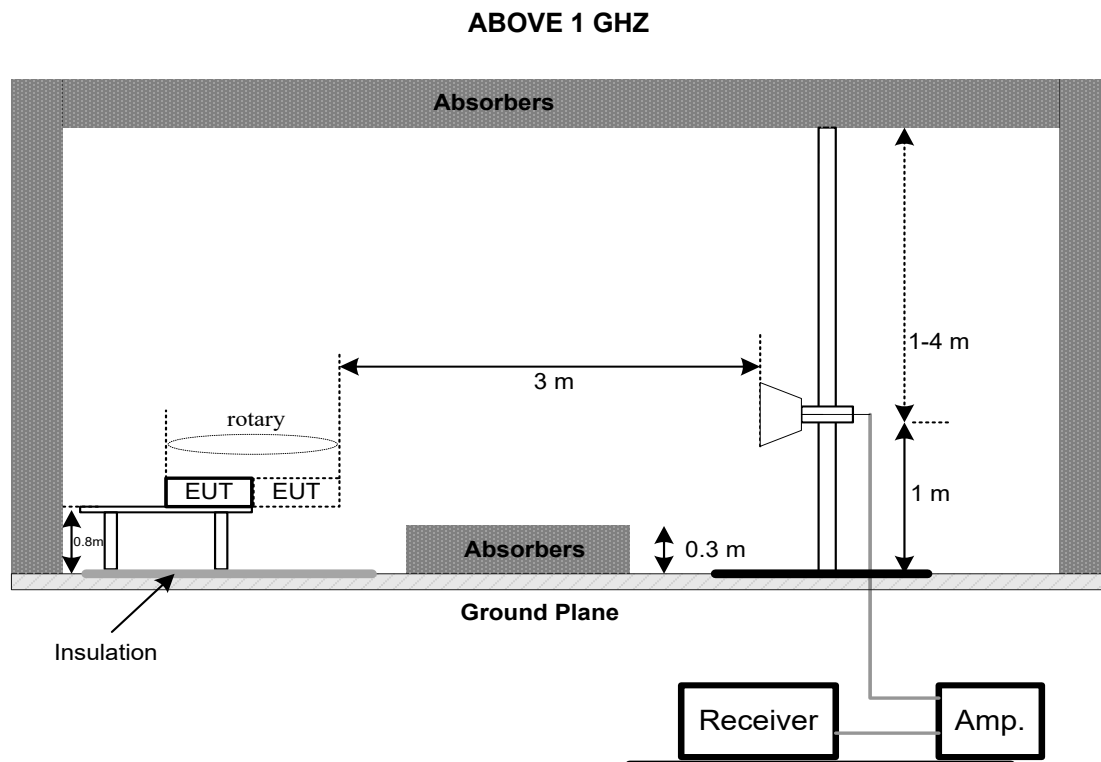

3.2.6 MEASUREMENT DISTANCE

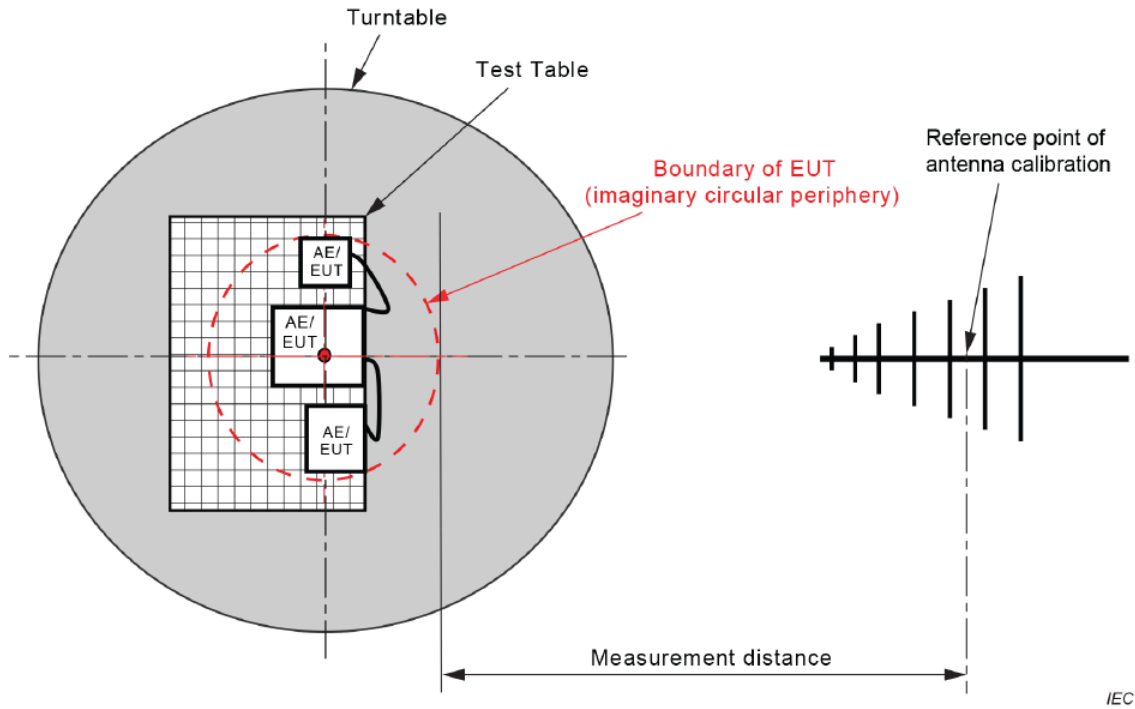

Figure C.1 – Measurement distance

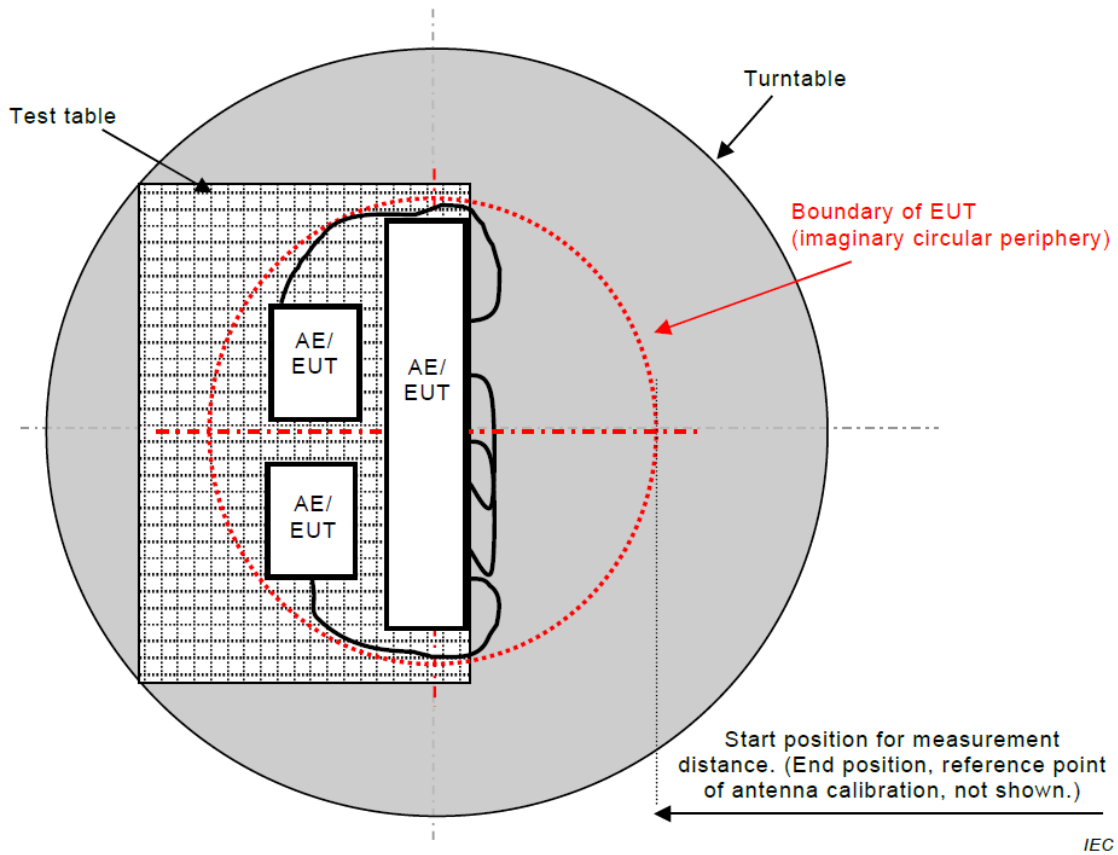
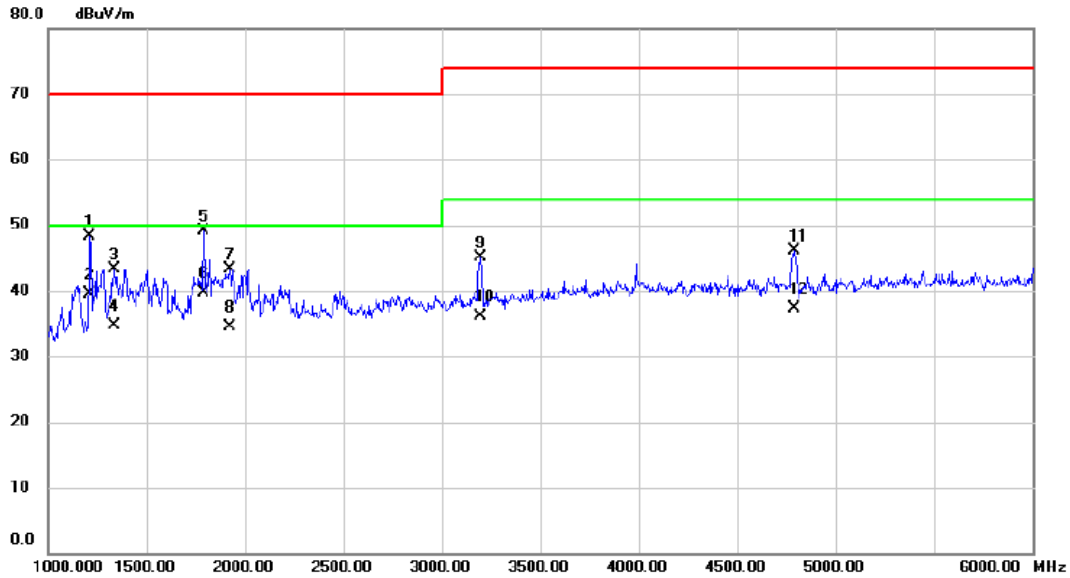

Figure C.2 – Boundary of EUT, Local AE and associated cabling

3.2.7 TEST RESULTS

Test Voltage	AC 230V/50Hz	Polarization	Vertical
Test Mode	Mode 1		



No. Mk.	Freq. MHz	Reading Level dBuV	Correct Factor dB	Measurement dBuV/m	Limit dBuV/m	Margin dB	Detector	Comment
1	1210.000	54.01	-5.61	48.40	70.00	-21.60	peak	
2	1210.000	45.12	-5.61	39.51	50.00	-10.49	AVG	
3	1335.000	48.67	-5.28	43.39	70.00	-26.61	peak	
4	1335.000	40.01	-5.28	34.73	50.00	-15.27	AVG	
5	1792.500	52.77	-3.65	49.12	70.00	-20.88	peak	
6 *	1792.500	43.26	-3.65	39.61	50.00	-10.39	AVG	
7	1922.500	46.38	-3.12	43.26	70.00	-26.74	peak	
8	1922.500	37.58	-3.12	34.46	50.00	-15.54	AVG	
9	3197.500	44.55	0.60	45.15	74.00	-28.85	peak	
10	3197.500	35.49	0.60	36.09	54.00	-17.91	AVG	
11	4787.500	43.27	2.78	46.05	74.00	-27.95	peak	
12	4787.500	34.57	2.78	37.35	54.00	-16.65	AVG	

Test Voltage	AC 230V/50Hz	Polarization	Horizontal
Test Mode	Mode 1		

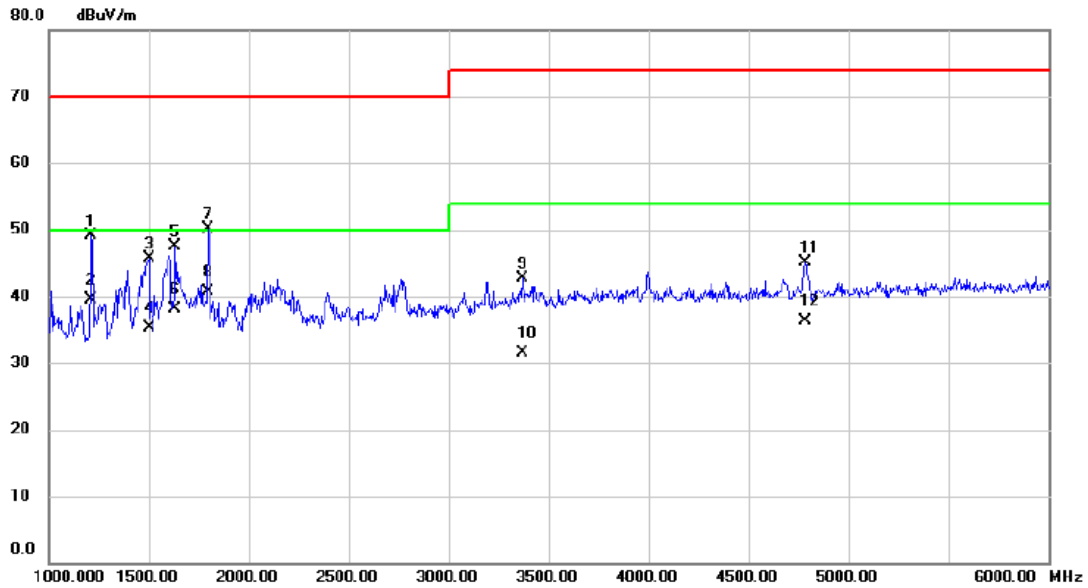

No.	Mk.	Freq. MHz	Reading Level dBuV	Correct Factor dB	Measure- ment dBuV/m	Limit dBuV/m	Margin dB	Detector	Comment
1		1210.000	54.76	-5.61	49.15	70.00	-20.85	peak	
2		1210.000	45.21	-5.61	39.60	50.00	-10.40	AVG	
3		1500.000	50.48	-4.83	45.65	70.00	-24.35	peak	
4		1500.000	40.17	-4.83	35.34	50.00	-14.66	AVG	
5		1632.500	51.82	-4.29	47.53	70.00	-22.47	peak	
6		1632.500	42.32	-4.29	38.03	50.00	-11.97	AVG	
7		1797.500	53.80	-3.63	50.17	70.00	-19.83	peak	
8	*	1797.500	44.25	-3.63	40.62	50.00	-9.38	AVG	
9		3367.500	41.76	0.98	42.74	74.00	-31.26	peak	
10		3367.500	30.62	0.98	31.60	54.00	-22.40	AVG	
11		4782.500	42.25	2.78	45.03	74.00	-28.97	peak	
12		4782.500	33.59	2.78	36.37	54.00	-17.63	AVG	

3.3 CONDUCTED EMISSION MEASUREMENT AT AC MAINS POWER PORTS

3.3.1 LIMITS

Requirements for conducted emissions from AC mains power ports of Class B equipment

Frequency Range MHz	Coupling Device	Detector Type / bandwidth	Class B Limits (dB(μV))
0.15 - 0.5	AMN	Quasi Peak / 9 kHz	66-56
0.5 - 5			56
5 - 30			60
0.15 - 0.5	AMN	Average / 9 kHz	56-46
0.5 - 5			46
5 - 30			50

NOTE:

(1) The test result calculated as following:

Measurement Value = Reading Level + Correct Factor

Correct Factor = Insertion Loss + Cable Loss + Attenuator Factor(if use)

Margin Level = Measurement Value – Limit Value

3.3.2 MEASUREMENT INSTRUMENTS LIST

Item	Kind of Equipment	Manufacturer	Type No.	Serial No.	Calibrated until
1	EMI TEST RECEIVER	R&S	ESCI	100382	Dec. 22, 2024
2	TWO-LINE V-NETWORK	R&S	ENV216	102974	Dec. 22, 2024
3	TWO-LINE V-NETWORK	R&S	ENV216	101447	Dec. 22, 2024
4	Measurement Software	Farad	EZ-EMC Ver.NB-03A1-01	N/A	N/A
5	Cable	N/A	SFT205-NMNM-9M -001	9M	Nov. 27, 2024

Remark: "N/A" denotes no model name, no serial no. or no calibration specified.

All calibration period of equipment list is one year.

3.3.3 TEST PROCEDURE

- a. The EUT was placed 0.8 meters from the horizontal ground plane with EUT being connected to the power mains through a line impedance stabilization network (LISN). All other support equipment powered from additional LISN(s). The LISN provide 50 Ohm/ 50uH of coupling impedance for the measuring instrument.
- b. Interconnecting cables that hang closer than 40 cm to the ground plane shall be folded back and forth in the center forming a bundle 30 to 40 cm long.
- c. I/O cables that are not connected to a peripheral shall be bundled in the center. The end of the cable may be terminated, if required, using the correct terminating impedance. The overall length shall not exceed 1 m.
- d. LISN at least 80 cm from nearest part of EUT chassis.
- e. For the actual test configuration, please refer to the related Item –EUT Test Photos.

3.3.4 DEVIATION FROM TEST STANDARD

No deviation

3.3.5 TEST SETUP

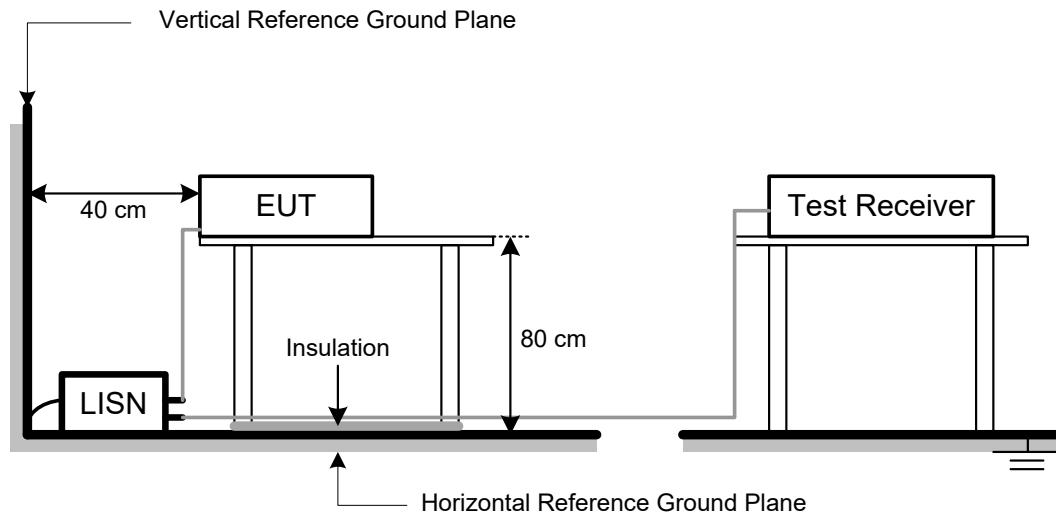

3.3.6 TEST RESULTS

Test Voltage	AC 230V/50Hz	Phase	Line
Test Mode	Mode 1		

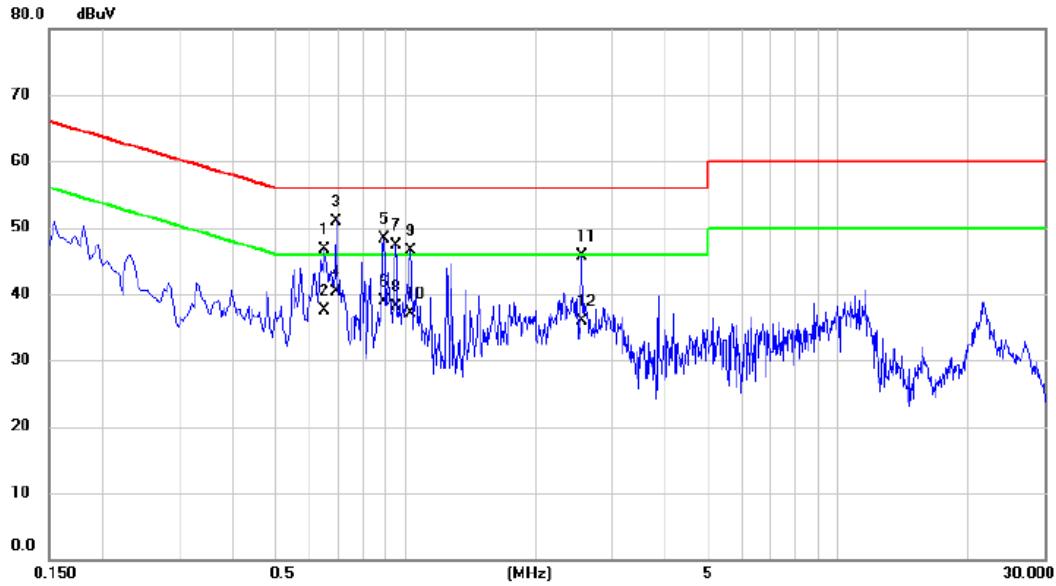

No.	Mk.	Freq. MHz	Reading Level dBuV	Correct Factor dB	Measure- ment dBuV	Limit dBuV	Margin dB	Detector	Comment
1		0.6493	36.82	9.79	46.61	56.00	-9.39	QP	
2		0.6493	27.80	9.79	37.59	46.00	-8.41	AVG	
3	*	0.6900	41.20	9.80	51.00	56.00	-5.00	QP	
4		0.6900	30.60	9.80	40.40	46.00	-5.60	AVG	
5		0.8923	38.58	9.81	48.39	56.00	-7.61	QP	
6		0.8923	29.10	9.81	38.91	46.00	-7.09	AVG	
7		0.9510	37.56	9.82	47.38	56.00	-8.62	QP	
8		0.9510	28.20	9.82	38.02	46.00	-7.98	AVG	
9		1.0274	36.61	9.82	46.43	56.00	-9.57	QP	
10		1.0274	27.30	9.82	37.12	46.00	-8.88	AVG	
11		2.5620	35.73	9.88	45.61	56.00	-10.39	QP	
12		2.5620	26.10	9.88	35.98	46.00	-10.02	AVG	

Test Voltage	AC 230V/50Hz	Phase	Neutral
Test Mode	Mode 1		

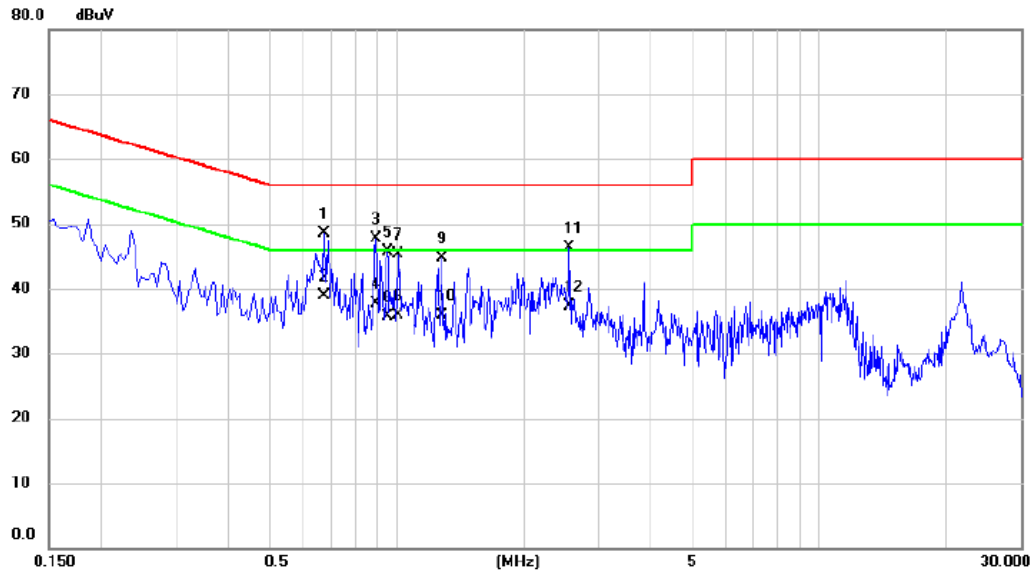

No.	Mk.	Freq. MHz	Reading Level dBuV	Correct Factor dB	Measure- ment dBuV	Limit dBuV	Margin dB	Detector	Comment
1		0.6720	38.86	9.67	48.53	56.00	-7.47	QP	
2	*	0.6720	29.30	9.67	38.97	46.00	-7.03	AVG	
3		0.8923	37.96	9.67	47.63	56.00	-8.37	QP	
4		0.8923	28.10	9.67	37.77	46.00	-8.23	AVG	
5		0.9510	35.96	9.68	45.64	56.00	-10.36	QP	
6		0.9510	26.10	9.68	35.78	46.00	-10.22	AVG	
7		1.0094	35.54	9.68	45.22	56.00	-10.78	QP	
8		1.0094	26.20	9.68	35.88	46.00	-10.12	AVG	
9		1.2840	35.04	9.69	44.73	56.00	-11.27	QP	
10		1.2840	26.20	9.69	35.89	46.00	-10.11	AVG	
11		2.5620	36.59	9.73	46.32	56.00	-9.68	QP	
12		2.5620	27.60	9.73	37.33	46.00	-8.67	AVG	

4. EMC EMISSION TEST- EN 55032:2015+A11:2020

4.1 RADIATED EMISSIONS UP TO 1 GHZ

4.1.1 LIMITS

Class B equipment up to 1 GHz

Frequency Range MHz	Measurement			Class B limits dB(μV/m)
	Facility	Distance m	Detector type/ bandwidth	
30 - 230	SAC	10	Quasi peak / 120 kHz	30
230 - 1000				37

Notes:

- (1) The limit for radiated test was performed according to as following: EN 55032
- (2) The tighter limit applies at the band edges.
- (3) Emission level (dBuV/m)=20log Emission level (uV/m).
- (4) The test result calculated as following:
 Measurement Value = Reading Level + Correct Factor
 Correct Factor = Antenna Factor + Cable Loss - Amplifier Gain(if use)
 Margin Level = Measurement Value - Limit Value

4.1.2 MEASUREMENT INSTRUMENTS LIST

Item	Kind of Equipment	Manufacturer	Type No.	Serial No.	Calibrated until
1	EMI Test Receiver	Keysight	N9038A	MY56400060	Dec. 22, 2024
2	MXE EMI Receiver	Agilent	N9038A	MY53220133	Jun. 01, 2025
3	Pre-Amplifier	EMC INSTRUMENT	EMC 9135	980284	May 31, 2025
4	Pre-Amplifier	EMC INSTRUMENT	EMC 9135	980283	May 31, 2025
5	Trilog-Broadband Antenna	Schwarzbeck	VULB9168	947	Nov. 10, 2024
6	Attenuator	EMCI	EMCI-N-6-06	AT-N0670	Nov. 10, 2024
7	Trilog-Broadband Antenna	Schwarzbeck	VULB9168	1461	Nov. 28, 2024
8	Attenuator	EMC INSTRUMENT	EMCI-N-6-06	AT-06010	Nov. 28, 2024
9	Measurement Software	Farad	EZ-EMC Ver.BTL-2ANT-1	N/A	N/A
10	Multi-Device Controller	ETS-Lindgren	2090	N/A	N/A
11	Controller	MF	MF-7802	MF780208159	N/A
12	Cable	RW	LMR400-NMNM-10M	N/A	Dec. 03, 2024
13	Cable	RW	LMR400-NMNM-7M	N/A	Dec. 03, 2024
14	Cable	RW	LMR400-NMNM-3.5M	N/A	Dec. 03, 2024
15	Cable	RW	LMR400-NMNM-7M	N/A	Sep. 04, 2025
16	Cable	RW	LMR400-NMNM-8M	N/A	Sep. 04, 2025
17	Cable	RW	LMR400-NMNM-3.5M	N/A	Sep. 04, 2025

Remark: "N/A" denotes no model name, no serial no. or no calibration specified.

All calibration period of equipment list is one year.

4.1.3 TEST PROCEDURE

- The measuring distance of 10 m shall be used for measurements. The EUT was placed on the top of a rotating table 0.8 meter above the ground at a 10 meter semi-anechoic chamber. The table was rotated 360 degrees to determine the position of the highest radiation.
- The height of the equipment or of the substitution antenna shall be 0.8 m, the height of the test antenna shall vary between 1 m to 4 m. Both horizontal and vertical polarizations of the antenna are set to make the measurement.
- The initial step in collecting radiated emission data is a receiver peak detector mode pre-scanning the measurement frequency range. Significant peaks are then marked and then Quasi Peak detector mode re-measured.
- All readings are Peak unless otherwise stated QP in column of Note. Peak denotes that the Peak reading compliance with the QP Limits and then QP Mode measurement didn't perform.
- For the actual test configuration, please refer to the related Item - EUT Test Photos.

4.1.4 DEVIATION FROM TEST STANDARD

No deviation

4.1.5 TEST SETUP

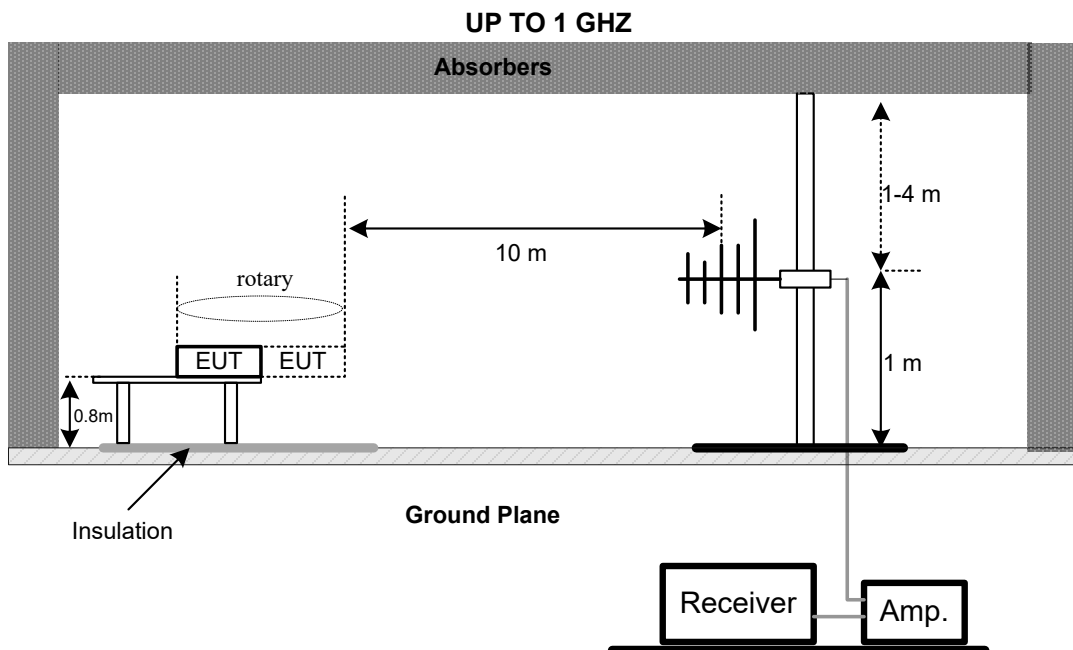

4.1.6 MEASUREMENT DISTANCE

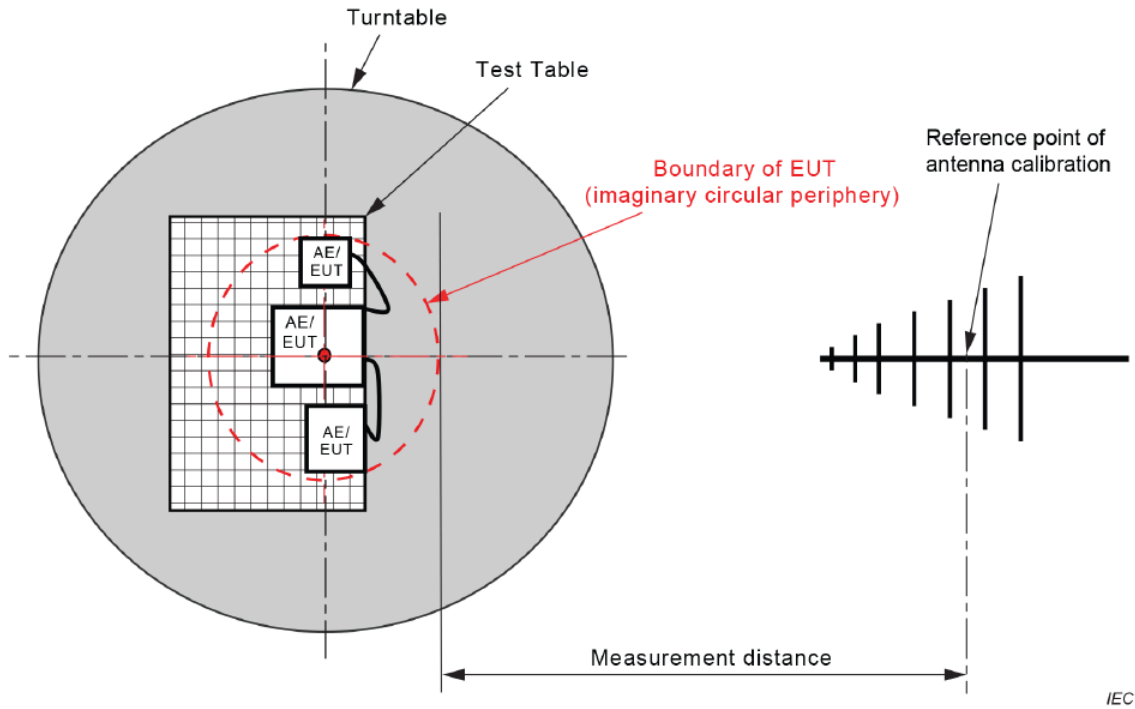

Figure C.1 – Measurement distance

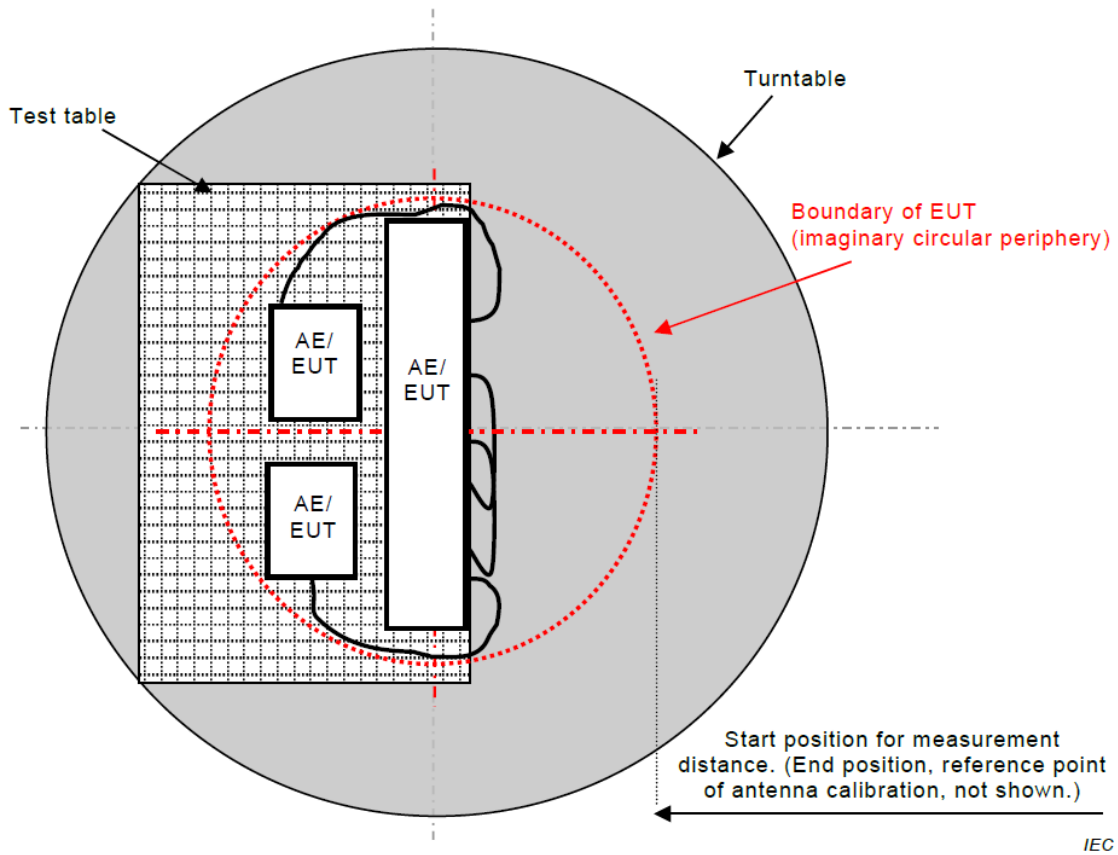
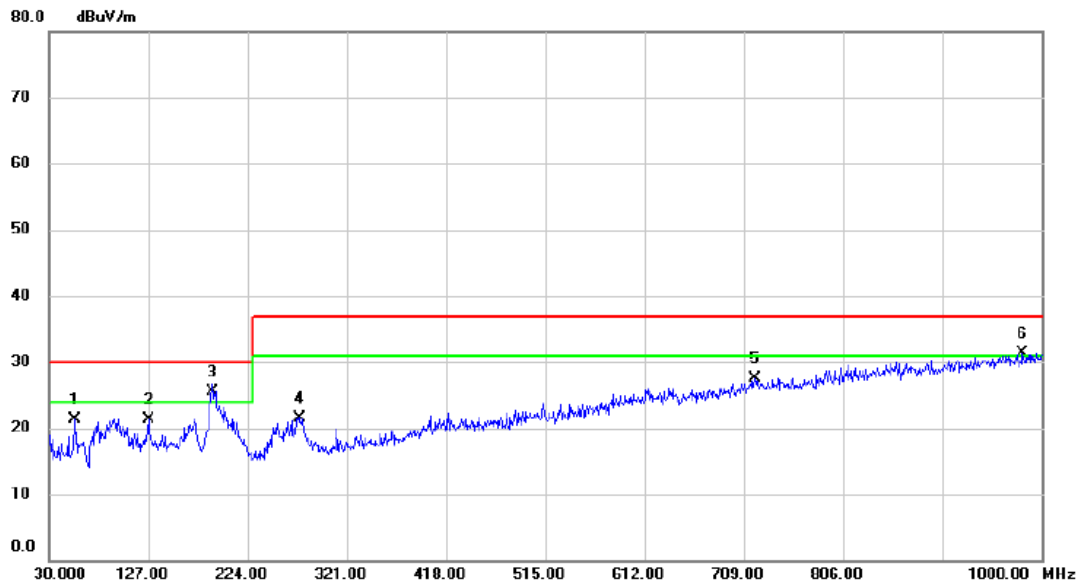

Figure C.2 – Boundary of EUT, Local AE and associated cabling

4.1.7 TEST RESULTS

Test Voltage	AC 230V/50Hz	Polarization	Vertical
Test Mode	Mode 1		



No.	Mk.	Freq. MHz	Reading Level dBuV	Correct Factor dB	Measure- ment dBuV/m	Limit dBuV/m	Margin dB	Detector	Comment
1		55.2200	38.17	-16.90	21.27	30.00	-8.73	QP	
2		127.0000	38.65	-17.32	21.33	30.00	-8.67	QP	
3	*	190.0500	43.44	-17.87	25.57	30.00	-4.43	QP	
4		274.4400	36.45	-14.85	21.60	37.00	-15.40	QP	
5		719.6700	33.34	-5.86	27.48	37.00	-9.52	QP	
6	!	981.5700	33.46	-2.23	31.23	37.00	-5.77	QP	

Test Voltage	AC 230V/50Hz	Polarization	Horizontal
Test Mode	Mode 1		

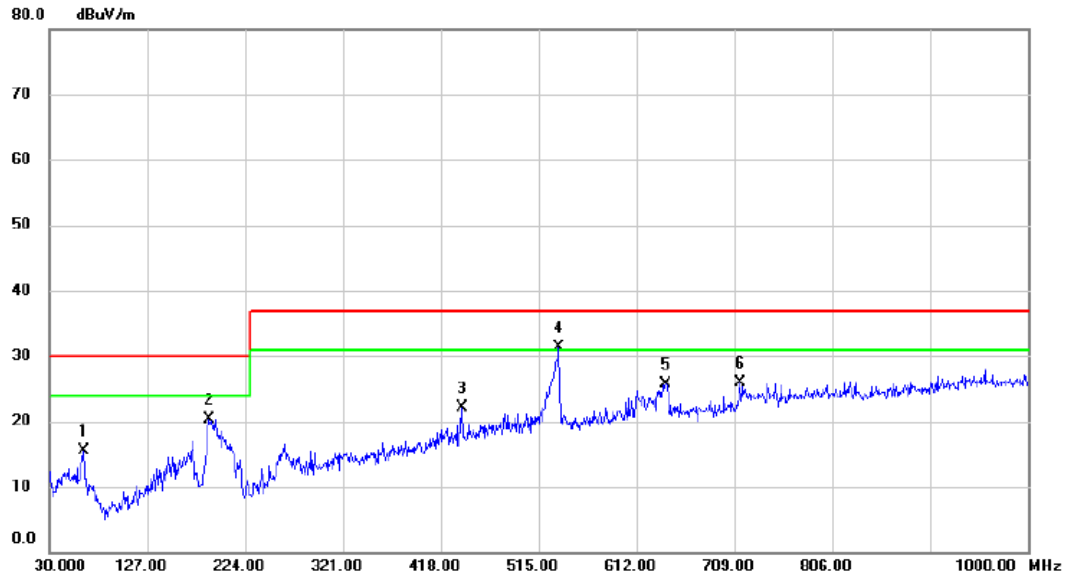

No.	Mk.	Freq. MHz	Reading Level dBuV	Correct Factor dB	Measure- ment dBuV/m	Limit dBuV/m	Margin dB	Detector	Comment
1		63.9500	34.52	-19.09	15.43	30.00	-14.57	QP	
2		188.1100	39.30	-18.93	20.37	30.00	-9.63	QP	
3		439.3400	34.18	-12.12	22.06	37.00	-14.94	QP	
4	*	535.3700	41.83	-10.60	31.23	37.00	-5.77	QP	
5		641.1000	34.84	-9.05	25.79	37.00	-11.21	QP	
6		714.8200	34.34	-8.52	25.82	37.00	-11.18	QP	

Test Voltage	AC 230V/50Hz	Polarization	Vertical
Test Mode	Mode 3		

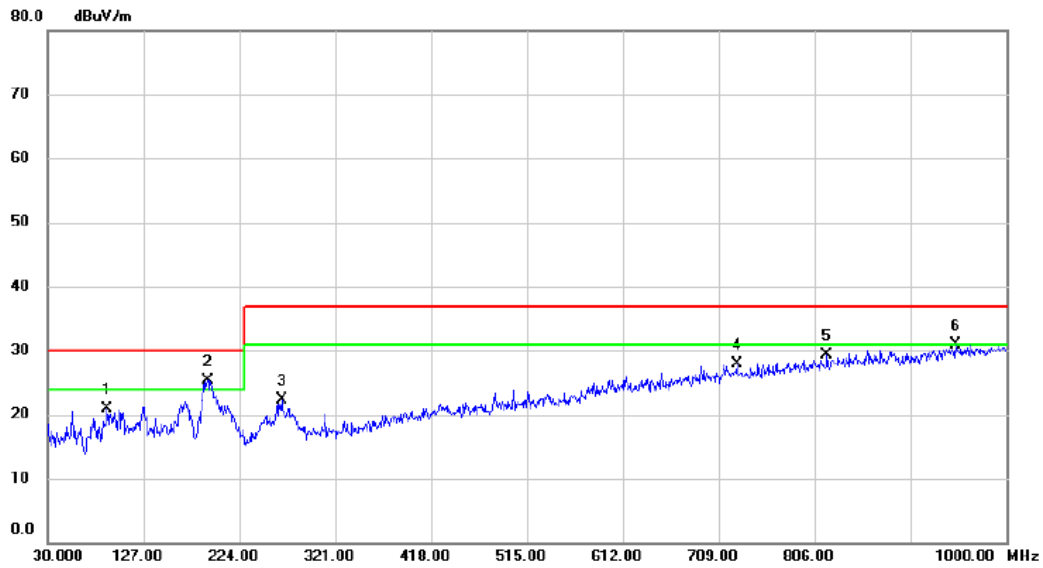

No.	Mk.	Freq. MHz	Reading Level dBuV	Correct Factor dB	Measure- ment dBuV/m	Limit dBuV/m	Margin dB	Detector	Comment
1		90.1400	42.74	-21.88	20.86	30.00	-9.14	QP	
2	*	191.9900	43.26	-17.92	25.34	30.00	-4.66	QP	
3		266.6800	37.68	-15.38	22.30	37.00	-14.70	QP	
4		727.4300	33.65	-5.76	27.89	37.00	-9.11	QP	
5		818.6100	33.93	-4.58	29.35	37.00	-7.65	QP	
6		948.5900	33.91	-3.00	30.91	37.00	-6.09	QP	

Test Voltage	AC 230V/50Hz	Polarization	Horizontal
Test Mode	Mode 3		

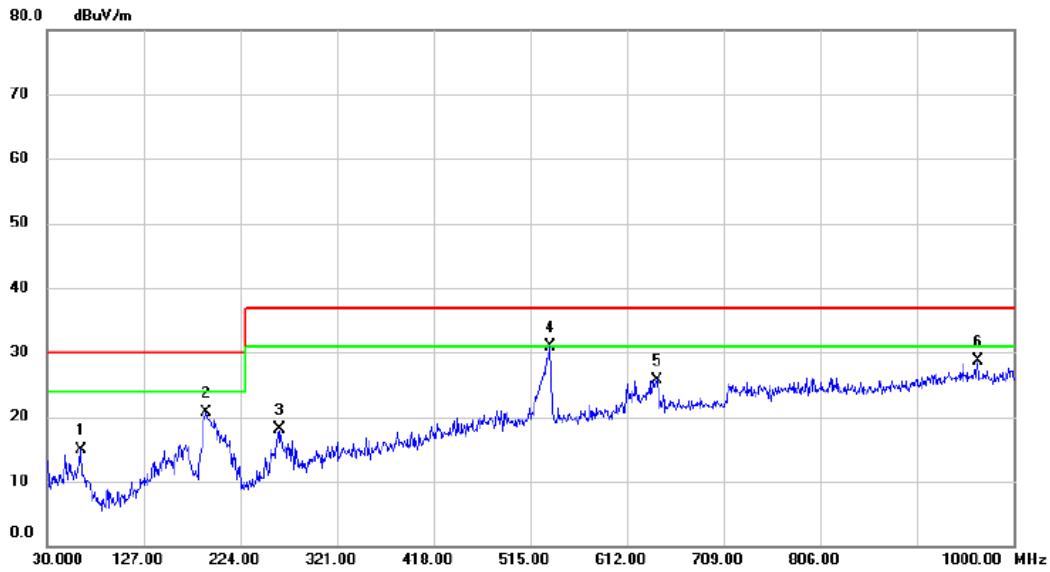

No. Mk.	Freq. MHz	Reading Level dBuV	Correct Factor dB	Measurement dBuV/m	Limit dBuV/m	Margin dB	Detector	Comment
1	63.9500	33.91	-19.09	14.82	30.00	-15.18	QP	
2	189.0800	39.63	-19.01	20.62	30.00	-9.38	QP	
3	263.2850	35.15	-17.12	18.03	37.00	-18.97	QP	
4 *	535.3700	41.57	-10.60	30.97	37.00	-6.03	QP	
5	642.0700	34.83	-9.04	25.79	37.00	-11.21	QP	
6	964.1100	34.58	-5.90	28.68	37.00	-8.32	QP	

Test Voltage	AC 230V/50Hz	Polarization	Vertical
Test Mode	Mode 4		

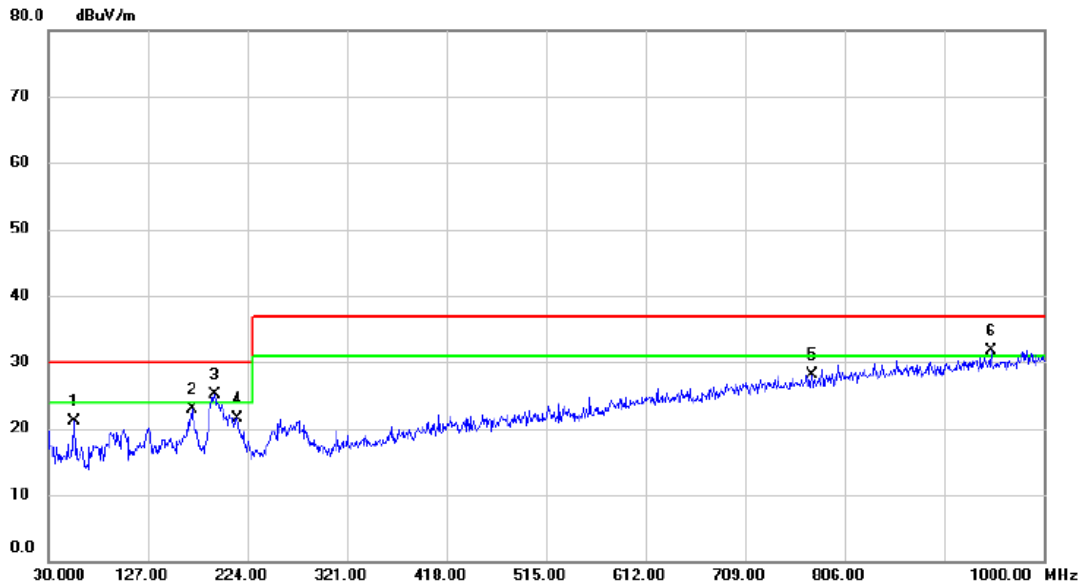

No. Mk.	Freq. MHz	Reading Level dBuV	Correct Factor dB	Measurement dBuV/m	Limit dBuV/m	Margin dB	Detector	Comment
1	55.2200	38.01	-16.90	21.11	30.00	-8.89	QP	
2	170.1650	38.18	-15.31	22.87	30.00	-7.13	QP	
3 *	191.9900	43.12	-17.92	25.20	30.00	-4.80	QP	
4	214.3000	39.50	-17.95	21.55	30.00	-8.45	QP	
5	773.9900	33.33	-5.24	28.09	37.00	-8.91	QP	
6 !	948.5900	34.71	-3.00	31.71	37.00	-5.29	QP	

Test Voltage	AC 230V/50Hz	Polarization	Horizontal
Test Mode	Mode 4		

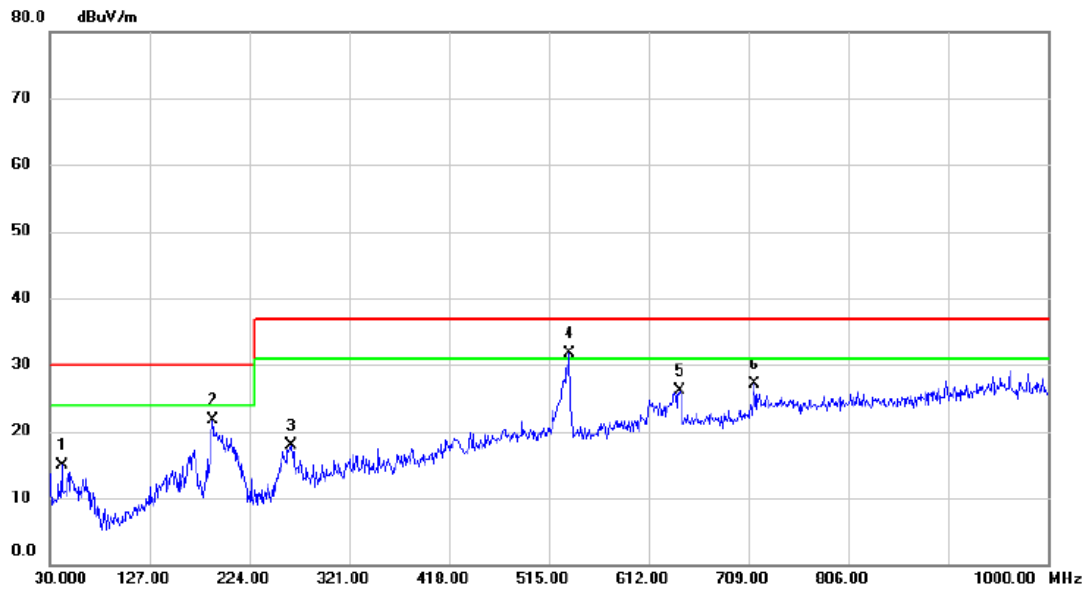

No. Mk.	Freq. MHz	Reading Level dBuV	Correct Factor dB	Measurement dBuV/m	Limit dBuV/m	Margin dB	Detector	Comment
1	41.6400	33.69	-18.77	14.92	30.00	-15.08	QP	
2	188.1100	40.57	-18.93	21.64	30.00	-8.36	QP	
3	264.7400	34.89	-17.05	17.84	37.00	-19.16	QP	
4 *	535.3700	42.39	-10.60	31.79	37.00	-5.21	QP	
5	642.0700	35.07	-9.04	26.03	37.00	-10.97	QP	
6	714.8200	35.54	-8.52	27.02	37.00	-9.98	QP	

Test Voltage	AC 230V/50Hz	Polarization	Vertical
Test Mode	Mode 11		

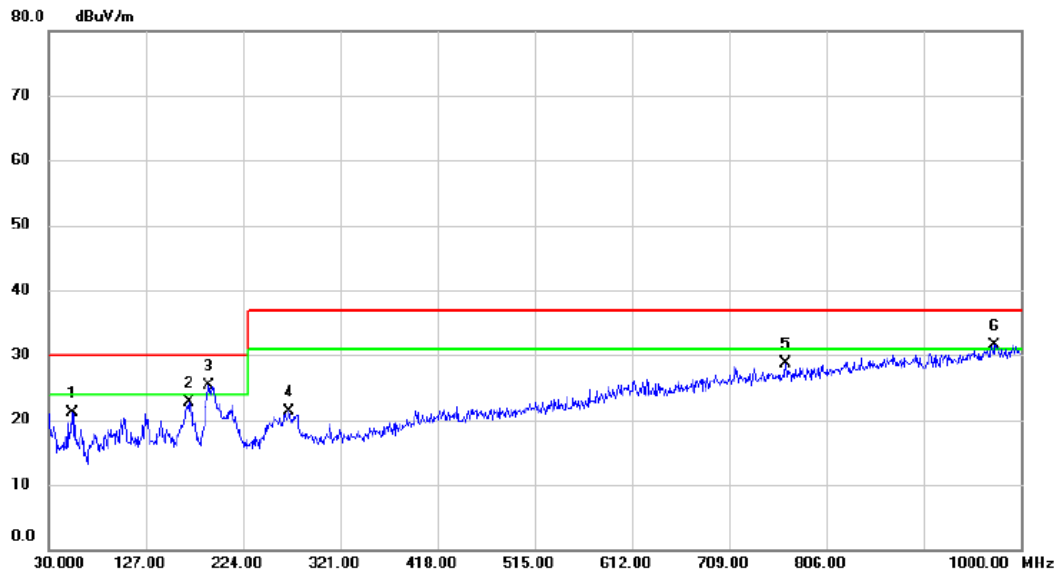

No.	Mk.	Freq. MHz	Reading Level dBuV	Correct Factor dB	Measure- ment dBuV/m	Limit dBuV/m	Margin dB	Detector	Comment
1		53.2800	37.98	-16.84	21.14	30.00	-8.86	QP	
2		170.6500	38.01	-15.38	22.63	30.00	-7.37	QP	
3	*	190.0500	43.22	-17.87	25.35	30.00	-4.65	QP	
4		269.5900	36.57	-15.19	21.38	37.00	-15.62	QP	
5		765.2600	34.05	-5.34	28.71	37.00	-8.29	QP	
6	!	973.8100	33.93	-2.42	31.51	37.00	-5.49	QP	

Test Voltage	AC 230V/50Hz	Polarization	Horizontal
Test Mode	Mode 11		

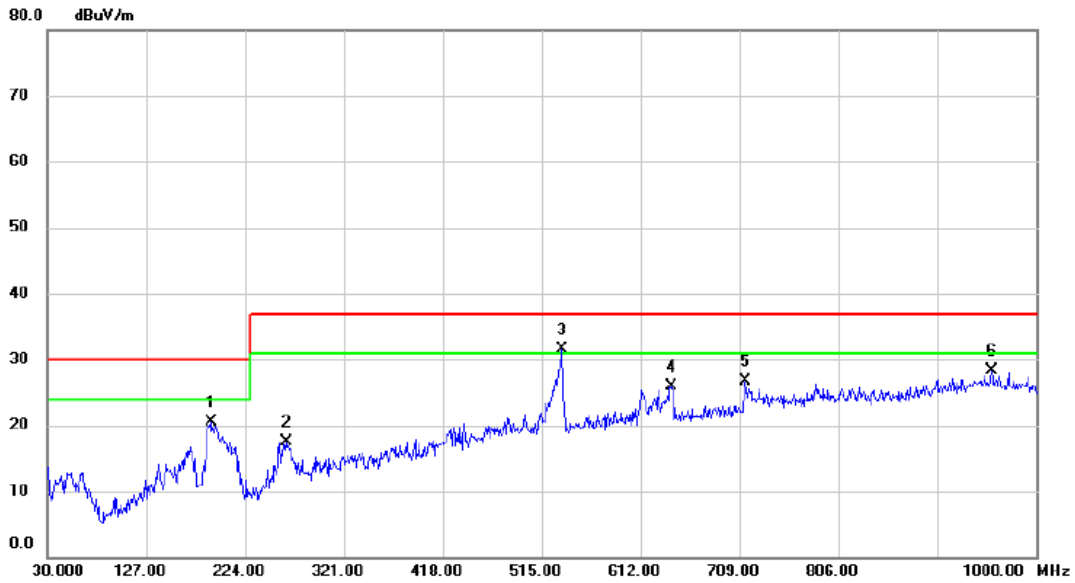

No.	Mk.	Freq. MHz	Reading Level dBuV	Correct Factor dB	Measure- ment dBuV/m	Limit dBuV/m	Margin dB	Detector	Comment
1		190.5350	39.66	-19.13	20.53	30.00	-9.47	QP	
2		264.2550	34.59	-17.07	17.52	37.00	-19.48	QP	
3	*	535.3700	42.17	-10.60	31.57	37.00	-5.43	QP	
4		642.0700	34.92	-9.04	25.88	37.00	-11.12	QP	
5		714.8200	35.15	-8.52	26.63	37.00	-10.37	QP	
6		956.3500	34.15	-5.92	28.23	37.00	-8.77	QP	

Test Voltage	AC 110V/60Hz	Polarization	Vertical
Test Mode	Mode 1		

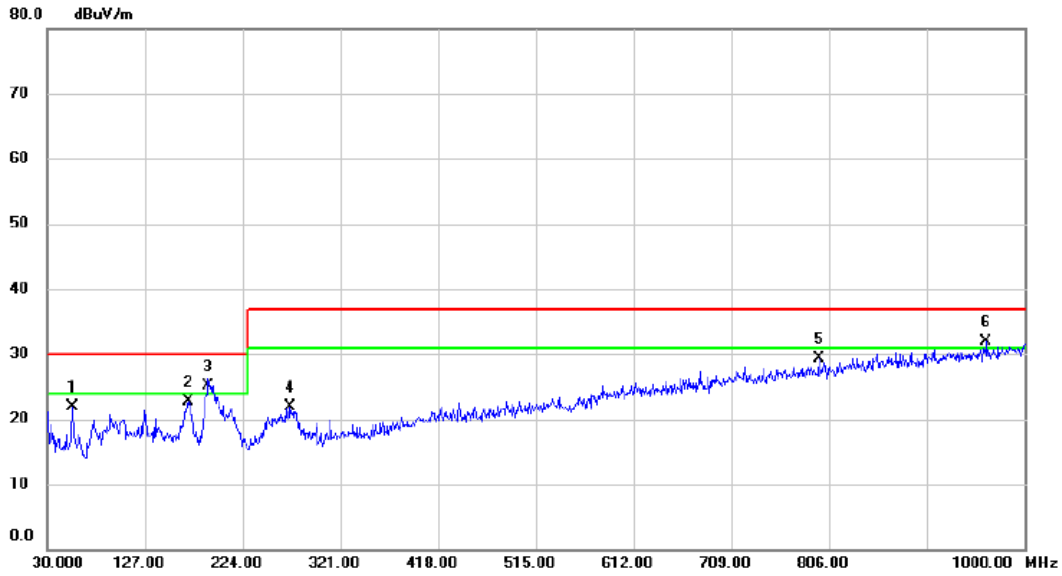

No.	Mk.	Freq. MHz	Reading Level dBuV	Correct Factor dB	Measure- ment dBuV/m	Limit dBuV/m	Margin dB	Detector	Comment
1		55.2200	38.84	-16.90	21.94	30.00	-8.06	QP	
2		169.6800	37.98	-15.28	22.70	30.00	-7.30	QP	
3	*	190.0500	43.03	-17.87	25.16	30.00	-4.84	QP	
4		271.5300	36.95	-15.06	21.89	37.00	-15.11	QP	
5		796.3000	34.28	-5.00	29.28	37.00	-7.72	QP	
6	!	962.1700	34.54	-2.69	31.85	37.00	-5.15	QP	

Test Voltage	AC 110V/60Hz	Polarization	Horizontal
Test Mode	Mode 1		

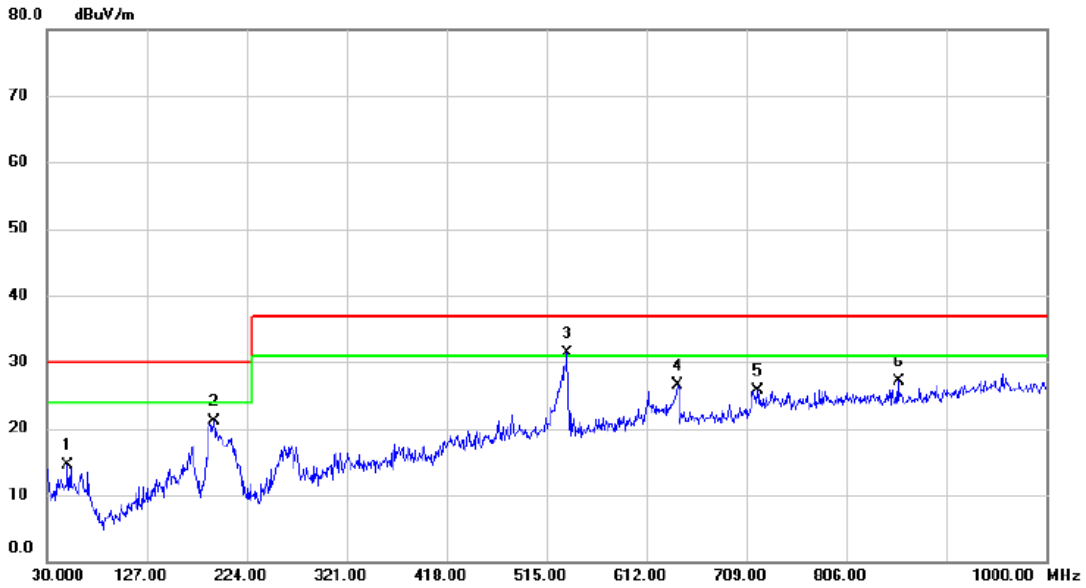

No.	Mk.	Freq. MHz	Reading Level dBuV	Correct Factor dB	Measure- ment dBuV/m	Limit dBuV/m	Margin dB	Detector	Comment
1		50.3700	32.70	-18.22	14.48	30.00	-15.52	QP	
2		191.9900	40.37	-19.20	21.17	30.00	-8.83	QP	
3	*	535.3700	41.95	-10.60	31.35	37.00	-5.65	QP	
4		642.0700	35.57	-9.04	26.53	37.00	-10.47	QP	
5		719.6700	34.13	-8.41	25.72	37.00	-11.28	QP	
6		856.4400	34.65	-7.60	27.05	37.00	-9.95	QP	

4.2 RADIATED EMISSIONS ABOVE 1 GHZ

4.2.1 LIMITS

Class B equipment above 1 GHz

Frequency Range MHz	Measurement			Class B limits dB(μV/m)
	Facility	Distance m	Detector type/bandwidth	
1000 - 3000	FSOATS	3	Average / 1 MHz	50
3000 - 6000				54
1000 - 3000			Peak / 1 MHz	70
3000 - 6000				74

Notes:

- (1) The limit for radiated test was performed according to as following: EN 55032
- (2) The tighter limit applies at the band edges.
- (3) Emission level (dBuV/m)=20log Emission level (uV/m).
- (4) The test result calculated as following:
 Measurement Value = Reading Level + Correct Factor
 Correct Factor = Antenna Factor + Cable Loss - Amplifier Gain(if use)
 Margin Level = Measurement Value - Limit Value

Required highest frequency for radiated measurement

Highest internal frequency (F_x)	Highest measured frequency
$F_x \leq 108$ MHz	1 GHz
$108 < F_x \leq 500$ MHz	2 GHz
$500 < F_x \leq 1000$ MHz	5 GHz
$F_x > 1$ GHz	5 x F_x up to a maximum of 6 GHz

4.2.2 MEASUREMENT INSTRUMENTS LIST

Item	Kind of Equipment	Manufacturer	Type No.	Serial No.	Calibrated until
1	Horn Antenna	ETS	3115	9605-4803	Jul. 07, 2025
2	MXE EMI Receiver	Agilent	N9038A	MY53220133	Jun. 01, 2025
3	Preamplifier	EMC INSTRUMENT	EMC118A45SE	981003	Nov. 17, 2024
4	Measurement Software	Farad	EZ-EMC Ver.BTL-2ANT-1	N/A	N/A
5	Multi-Device Controller	ETS-Lindgren	2090	N/A	N/A
6	Controller	MF	MF-7802	MF780208159	N/A
7	Cable	RegalWay	RWLP50-4.0A-S MSM-9M	N/A	Sep. 02, 2025
8	Cable	RW	RWLP50-4.0A-N MRASM-1M	N/A	Sep. 02, 2025
9	Cable	RW	RWLP50-4.0A-N MRASM-4M	N/A	Sep. 02, 2025

Remark: "N/A" denotes no model name, no serial no. or no calibration specified.

All calibration period of equipment list is one year.

4.2.3 TEST PROCEDURE

- The measuring distance of 3 m shall be used for measurements. The EUT was placed on the top of a rotating table 0.8 meter above the ground at a 10 meter semi-anechoic chamber. The table was rotated 360 degrees to determine the position of the highest radiation.
- The height of the equipment or of the substitution antenna shall be 0.8 m, the height of the test antenna shall vary between 1 m to 4 m. Both horizontal and vertical polarizations of the antenna are set to make the measurement.
- The initial step in collecting radiated emission data is a receiver peak detector mode pre-scanning the measurement frequency range. Significant peaks are then marked and then AVG detector mode re-measured.
- All readings are Peak Mode value unless otherwise stated AVG in column of Note. If the Peak Mode Measured value compliance with the Peak Limits and lower than AVG Limits, the EUT shall be deemed to meet both Peak & AVG Limits and then only Peak Mode was measured, but AVG Mode didn't perform.
- For the actual test configuration, please refer to the related Item - EUT Test Photos.

4.2.4 DEVIATION FROM TEST STANDARD

The limit of the EN 55032:2015+A1:2020&AS/NZS CISPR 32:2015+AMD1:2020&CISPR 32:2015+AMD1:2019 standard deviates from the requirements, but the limit of the EN 55032:2015+A11:2020 standard is more stringent and can be covered, so the test data meets the EN 55032:2015+A1:2020 &AS/NZS CISPR 32:2015+AMD1:2020&CISPR 32:2015+AMD1:2019 standard.

4.2.5 TEST SETUP

ABOVE 1 GHZ

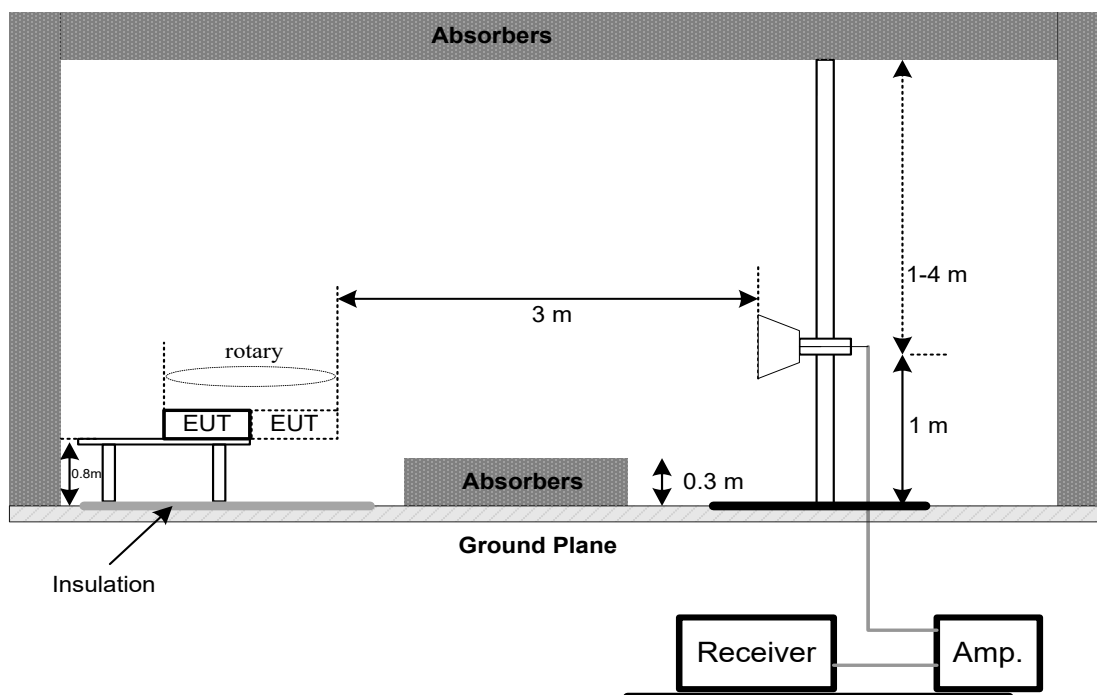

4.2.6 MEASUREMENT DISTANCE

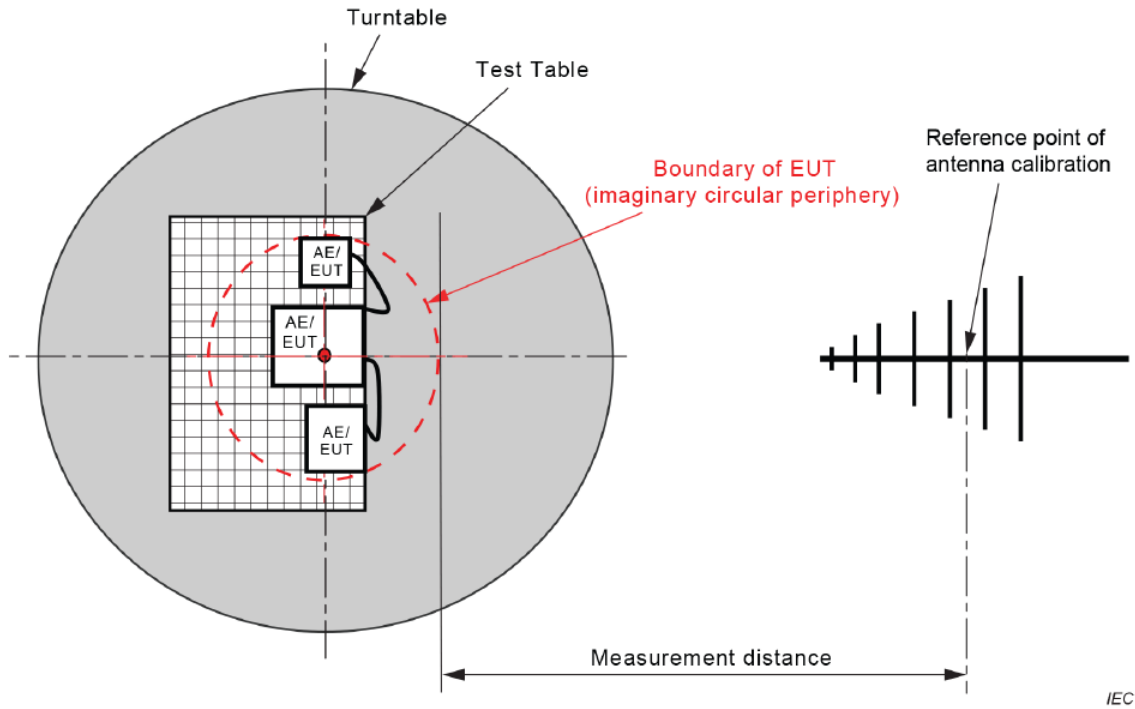

Figure C.1 – Measurement distance

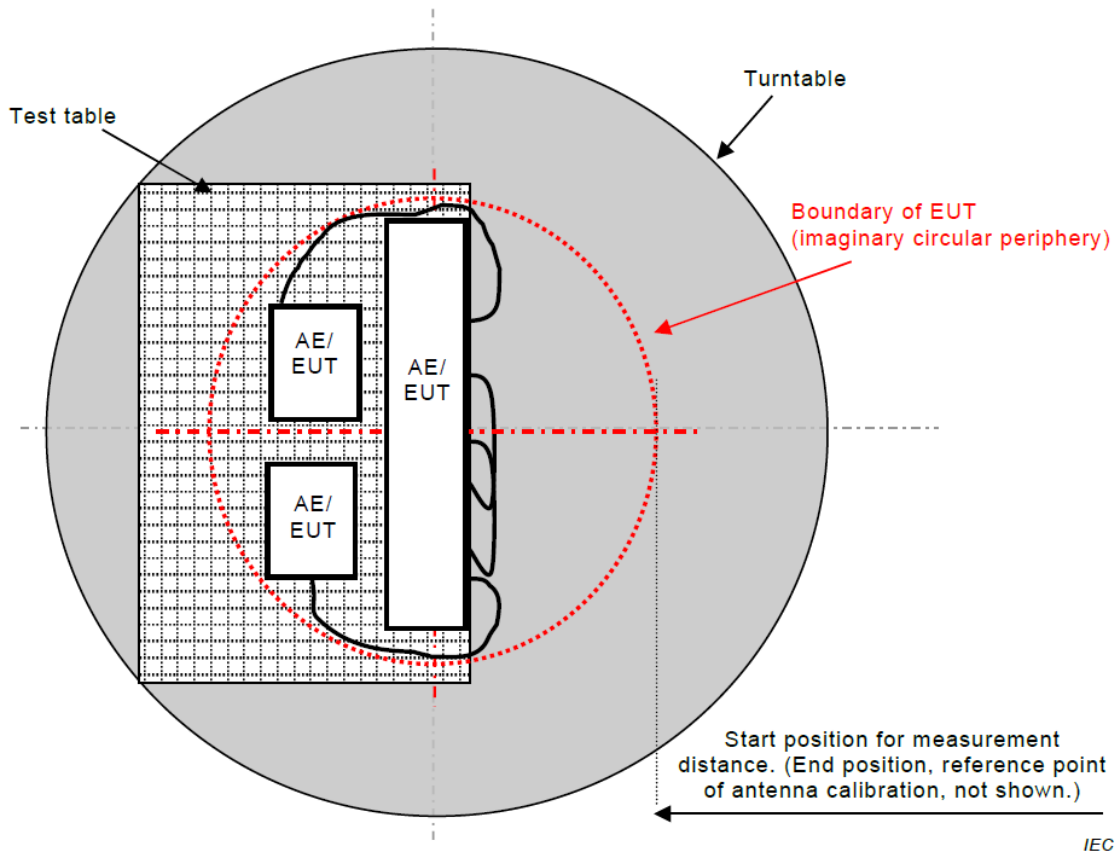
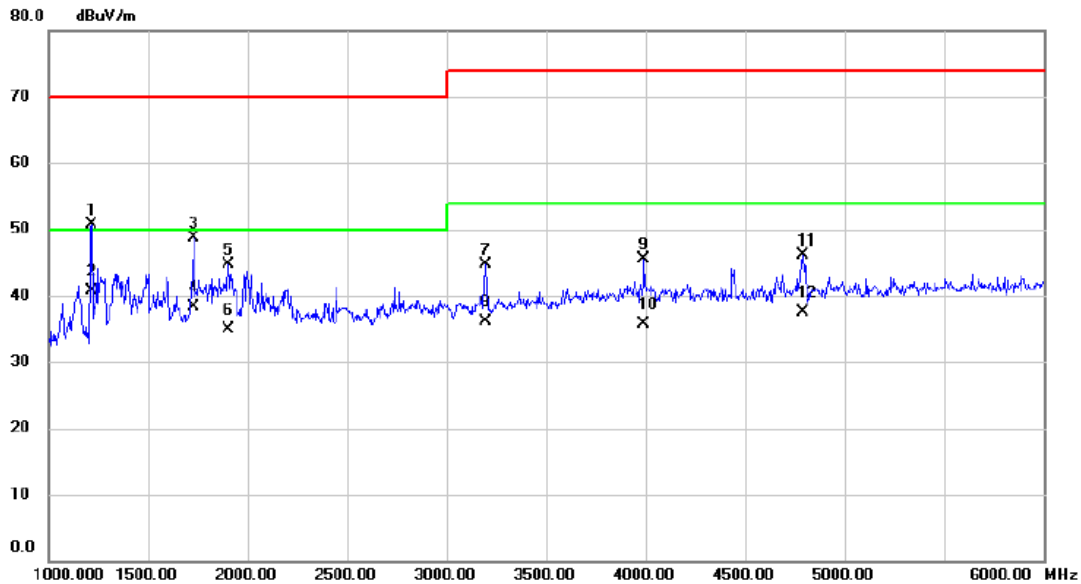

Figure C.2 – Boundary of EUT, Local AE and associated cabling

4.2.7 TEST RESULTS

Test Voltage	AC 230V/50Hz	Polarization	Vertical
Test Mode	Mode 1		



No.	Mk.	Freq. MHz	Reading Level dBuV	Correct Factor dB	Measure- ment dBuV/m	Limit dBuV/m	Margin dB	Detector	Comment
1		1215.000	56.36	-5.60	50.76	70.00	-19.24	peak	
2	*	1215.000	46.21	-5.60	40.61	50.00	-9.39	AVG	
3		1727.500	52.54	-3.91	48.63	70.00	-21.37	peak	
4		1727.500	42.31	-3.91	38.40	50.00	-11.60	AVG	
5		1902.500	47.91	-3.21	44.70	70.00	-25.30	peak	
6		1902.500	38.21	-3.21	35.00	50.00	-15.00	AVG	
7		3197.500	44.04	0.60	44.64	74.00	-29.36	peak	
8		3197.500	35.41	0.60	36.01	54.00	-17.99	AVG	
9		3990.000	42.79	2.62	45.41	74.00	-28.59	peak	
10		3990.000	33.16	2.62	35.78	54.00	-18.22	AVG	
11		4787.500	43.37	2.78	46.15	74.00	-27.85	peak	
12		4787.500	34.70	2.78	37.48	54.00	-16.52	AVG	

Test Voltage	AC 230V/50Hz	Polarization	Horizontal
Test Mode	Mode 1		

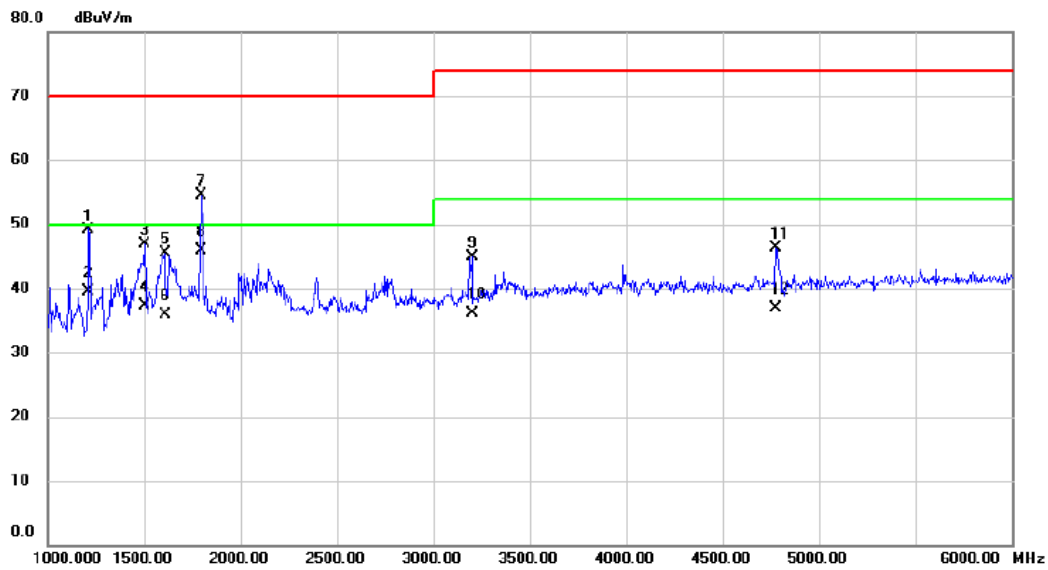

No.	Mk.	Freq. MHz	Reading Level dBuV	Correct Factor dB	Measure- ment dBuV/m	Limit dBuV/m	Margin dB	Detector	Comment
1		1210.000	54.81	-5.61	49.20	70.00	-20.80	peak	
2		1210.000	45.21	-5.61	39.60	50.00	-10.40	AVG	
3		1500.000	51.75	-4.83	46.92	70.00	-23.08	peak	
4		1500.000	42.11	-4.83	37.28	50.00	-12.72	AVG	
5		1607.500	49.97	-4.39	45.58	70.00	-24.42	peak	
6		1607.500	40.31	-4.39	35.92	50.00	-14.08	AVG	
7		1795.000	58.10	-3.65	54.45	70.00	-15.55	peak	
8	*	1795.000	49.47	-3.65	45.82	50.00	-4.18	AVG	
9		3200.000	44.29	0.60	44.89	74.00	-29.11	peak	
10		3200.000	35.55	0.60	36.15	54.00	-17.85	AVG	
11		4777.500	43.47	2.76	46.23	74.00	-27.77	peak	
12		4777.500	34.12	2.76	36.88	54.00	-17.12	AVG	

Test Voltage	AC 230V/50Hz	Polarization	Vertical
Test Mode	Mode 3		

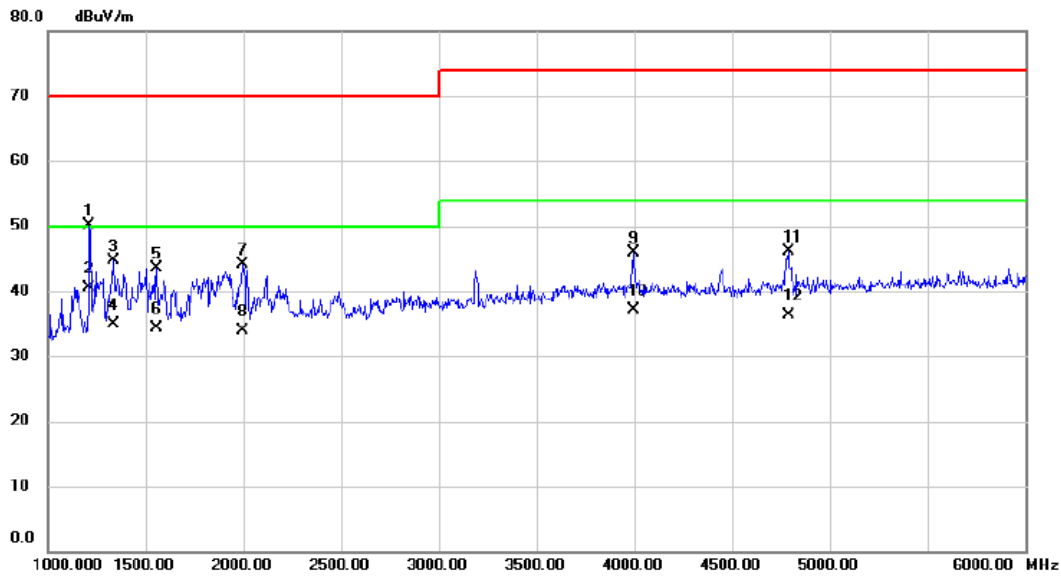

No.	Mk.	Freq. MHz	Reading Level dBuV	Correct Factor dB	Measure- ment dBuV/m	Limit dBuV/m	Margin dB	Detector	Comment
1		1212.500	55.65	-5.61	50.04	70.00	-19.96	peak	
2	*	1212.500	46.21	-5.61	40.60	50.00	-9.40	AVG	
3		1335.000	49.90	-5.28	44.62	70.00	-25.38	peak	
4		1335.000	40.11	-5.28	34.83	50.00	-15.17	AVG	
5		1555.000	48.09	-4.61	43.48	70.00	-26.52	peak	
6		1555.000	38.97	-4.61	34.36	50.00	-15.64	AVG	
7		1995.000	46.96	-2.83	44.13	70.00	-25.87	peak	
8		1995.000	36.74	-2.83	33.91	50.00	-16.09	AVG	
9		3995.000	43.30	2.64	45.94	74.00	-28.06	peak	
10		3995.000	34.52	2.64	37.16	54.00	-16.84	AVG	
11		4787.500	43.36	2.78	46.14	74.00	-27.86	peak	
12		4787.500	33.61	2.78	36.39	54.00	-17.61	AVG	

Test Voltage	AC 230V/50Hz	Polarization	Horizontal
Test Mode	Mode 3		

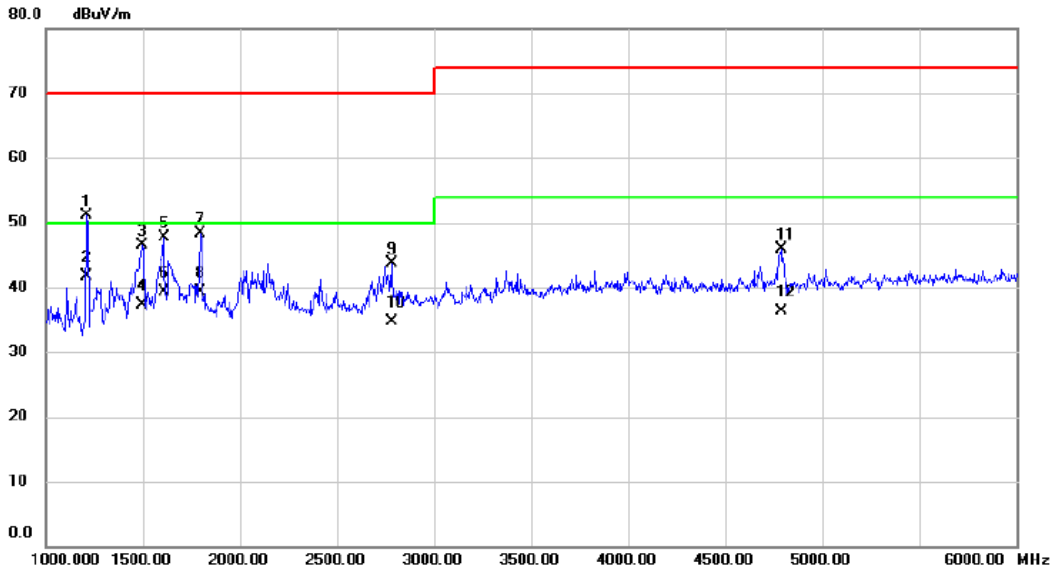

No.	Mk.	Freq. MHz	Reading Level dBuV	Correct Factor dB	Measure- ment dBuV/m	Limit dBuV/m	Margin dB	Detector	Comment
1		1207.500	56.72	-5.62	51.10	70.00	-18.90	peak	
2	*	1207.500	47.25	-5.62	41.63	50.00	-8.37	AVG	
3		1497.500	51.30	-4.84	46.46	70.00	-23.54	peak	
4		1497.500	42.13	-4.84	37.29	50.00	-12.71	AVG	
5		1607.500	52.12	-4.39	47.73	70.00	-22.27	peak	
6		1607.500	43.62	-4.39	39.23	50.00	-10.77	AVG	
7		1797.500	52.00	-3.63	48.37	70.00	-21.63	peak	
8		1797.500	42.85	-3.63	39.22	50.00	-10.78	AVG	
9		2780.000	44.36	-0.63	43.73	70.00	-26.27	peak	
10		2780.000	35.41	-0.63	34.78	50.00	-15.22	AVG	
11		4787.500	43.14	2.78	45.92	74.00	-28.08	peak	
12		4787.500	33.62	2.78	36.40	54.00	-17.60	AVG	

Test Voltage	AC 230V/50Hz	Polarization	Vertical
Test Mode	Mode 4		

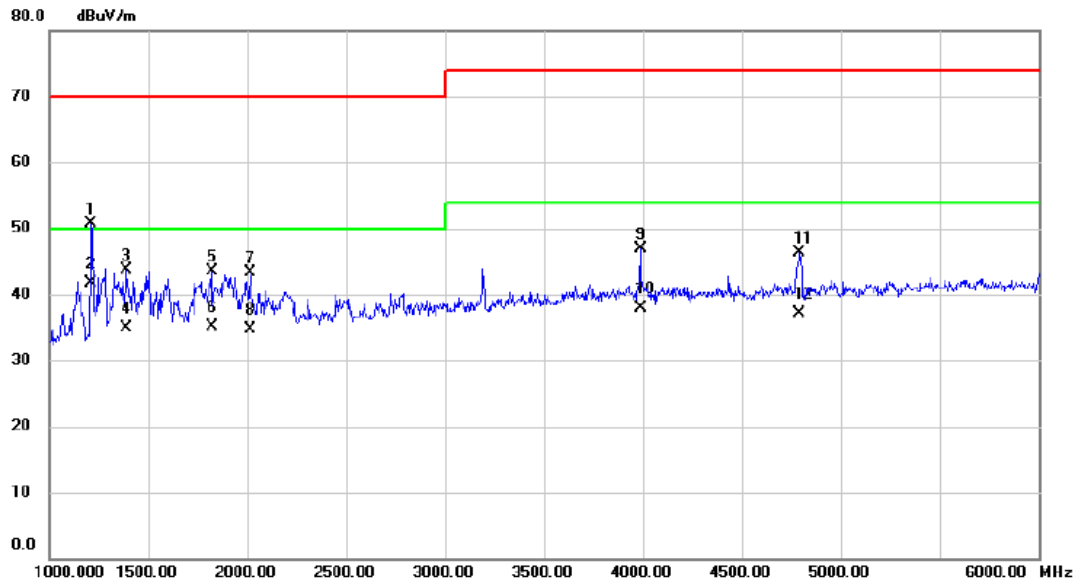

No.	Mk.	Freq. MHz	Reading Level dBuV	Correct Factor dB	Measure- ment dBuV/m	Limit dBuV/m	Margin dB	Detector	Comment
1		1210.000	56.35	-5.61	50.74	70.00	-19.26	peak	
2	*	1210.000	47.22	-5.61	41.61	50.00	-8.39	AVG	
3		1392.500	48.88	-5.12	43.76	70.00	-26.24	peak	
4		1392.500	40.12	-5.12	35.00	50.00	-15.00	AVG	
5		1820.000	47.12	-3.55	43.57	70.00	-26.43	peak	
6		1820.000	38.57	-3.55	35.02	50.00	-14.98	AVG	
7		2017.500	46.11	-2.77	43.34	70.00	-26.66	peak	
8		2017.500	37.46	-2.77	34.69	50.00	-15.31	AVG	
9		3987.500	44.28	2.62	46.90	74.00	-27.10	peak	
10		3987.500	35.21	2.62	37.83	54.00	-16.17	AVG	
11		4790.000	43.57	2.79	46.36	74.00	-27.64	peak	
12		4790.000	34.22	2.79	37.01	54.00	-16.99	AVG	

Test Voltage	AC 230V/50Hz	Polarization	Horizontal
Test Mode	Mode 4		

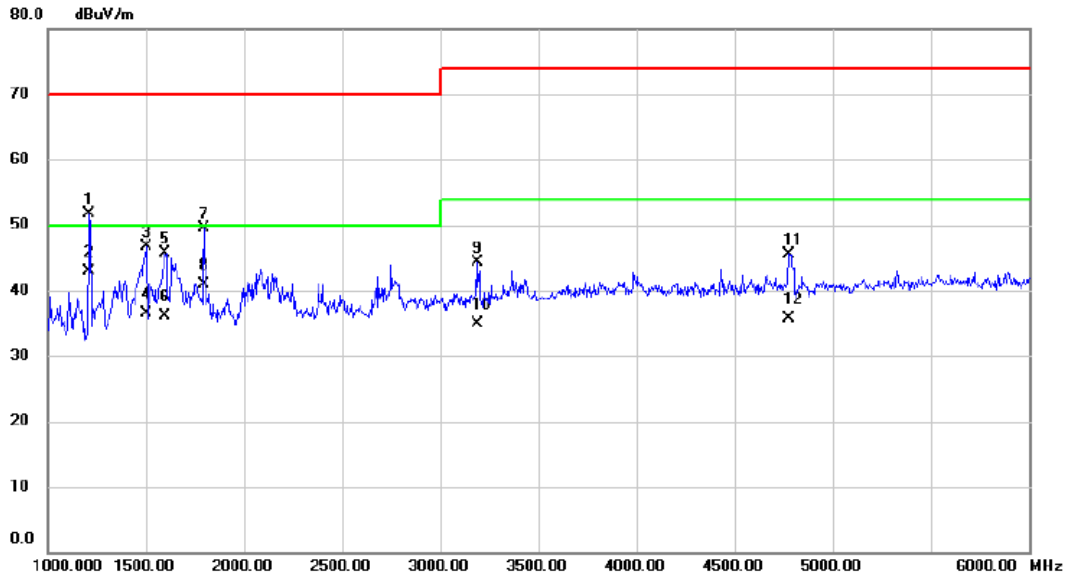

No.	Mk.	Freq. MHz	Reading Level dBuV	Correct Factor dB	Measure- ment dBuV/m	Limit dBuV/m	Margin dB	Detector	Comment
1		1210.000	57.39	-5.61	51.78	70.00	-18.22	peak	
2	*	1210.000	48.52	-5.61	42.91	50.00	-7.09	AVG	
3		1500.000	51.47	-4.83	46.64	70.00	-23.36	peak	
4		1500.000	41.32	-4.83	36.49	50.00	-13.51	AVG	
5		1595.000	50.23	-4.45	45.78	70.00	-24.22	peak	
6		1595.000	40.52	-4.45	36.07	50.00	-13.93	AVG	
7		1795.000	53.13	-3.65	49.48	70.00	-20.52	peak	
8		1795.000	44.61	-3.65	40.96	50.00	-9.04	AVG	
9		3187.500	43.82	0.57	44.39	74.00	-29.61	peak	
10		3187.500	34.25	0.57	34.82	54.00	-19.18	AVG	
11		4777.500	42.84	2.76	45.60	74.00	-28.40	peak	
12		4777.500	32.96	2.76	35.72	54.00	-18.28	AVG	

Test Voltage	AC 230V/50Hz	Polarization	Vertical
Test Mode	Mode 11		

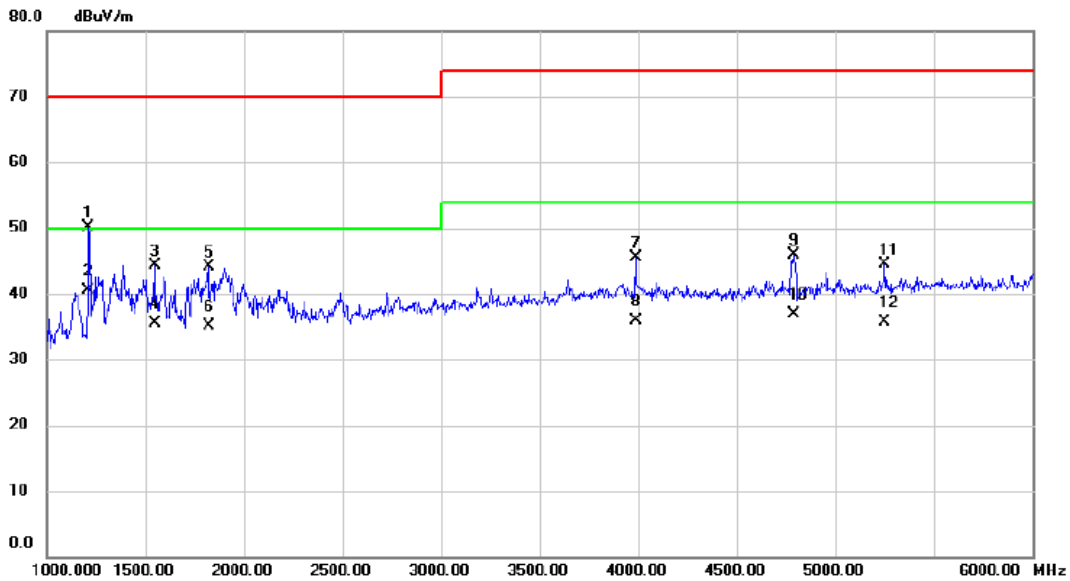

No.	Mk.	Freq. MHz	Reading Level dBuV	Correct Factor dB	Measure- ment dBuV/m	Limit dBuV/m	Margin dB	Detector	Comment
1		1212.500	55.69	-5.61	50.08	70.00	-19.92	peak	
2	*	1212.500	46.21	-5.61	40.60	50.00	-9.40	AVG	
3		1547.500	49.03	-4.64	44.39	70.00	-25.61	peak	
4		1547.500	40.12	-4.64	35.48	50.00	-14.52	AVG	
5		1820.000	47.69	-3.55	44.14	70.00	-25.86	peak	
6		1820.000	38.57	-3.55	35.02	50.00	-14.98	AVG	
7		3987.500	42.90	2.62	45.52	74.00	-28.48	peak	
8		3987.500	33.21	2.62	35.83	54.00	-18.17	AVG	
9		4787.500	43.14	2.78	45.92	74.00	-28.08	peak	
10		4787.500	34.16	2.78	36.94	54.00	-17.06	AVG	
11		5250.000	41.06	3.52	44.58	74.00	-29.42	peak	
12		5250.000	32.15	3.52	35.67	54.00	-18.33	AVG	

Test Voltage	AC 230V/50Hz	Polarization	Horizontal
Test Mode	Mode 11		

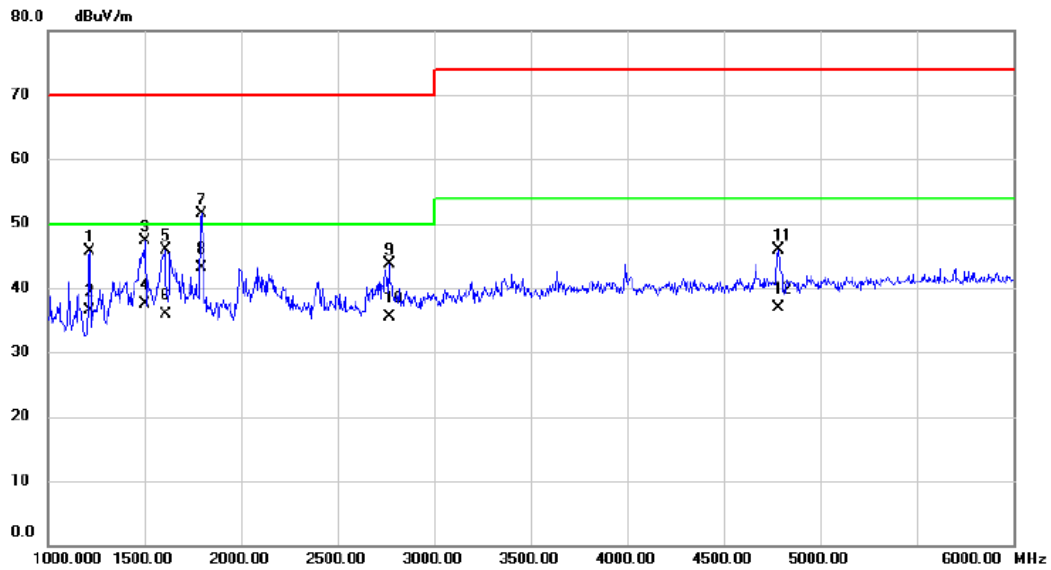

No. Mk.	Freq. MHz	Reading Level dBuV	Correct Factor dB	Measurement dBuV/m	Limit dBuV/m	Margin dB	Detector	Comment
1	1215.000	51.29	-5.60	45.69	70.00	-24.31	peak	
2	1215.000	42.15	-5.60	36.55	50.00	-13.45	AVG	
3	1500.000	52.08	-4.83	47.25	70.00	-22.75	peak	
4	1500.000	42.36	-4.83	37.53	50.00	-12.47	AVG	
5	1607.500	50.39	-4.39	46.00	70.00	-24.00	peak	
6	1607.500	40.33	-4.39	35.94	50.00	-14.06	AVG	
7	1797.500	55.15	-3.63	51.52	70.00	-18.48	peak	
8 *	1797.500	46.78	-3.63	43.15	50.00	-6.85	AVG	
9	2767.500	44.38	-0.68	43.70	70.00	-26.30	peak	
10	2767.500	36.25	-0.68	35.57	50.00	-14.43	AVG	
11	4780.000	43.06	2.78	45.84	74.00	-28.16	peak	
12	4780.000	34.11	2.78	36.89	54.00	-17.11	AVG	

Test Voltage	AC 110V/60Hz	Polarization	Vertical
Test Mode	Mode 1		

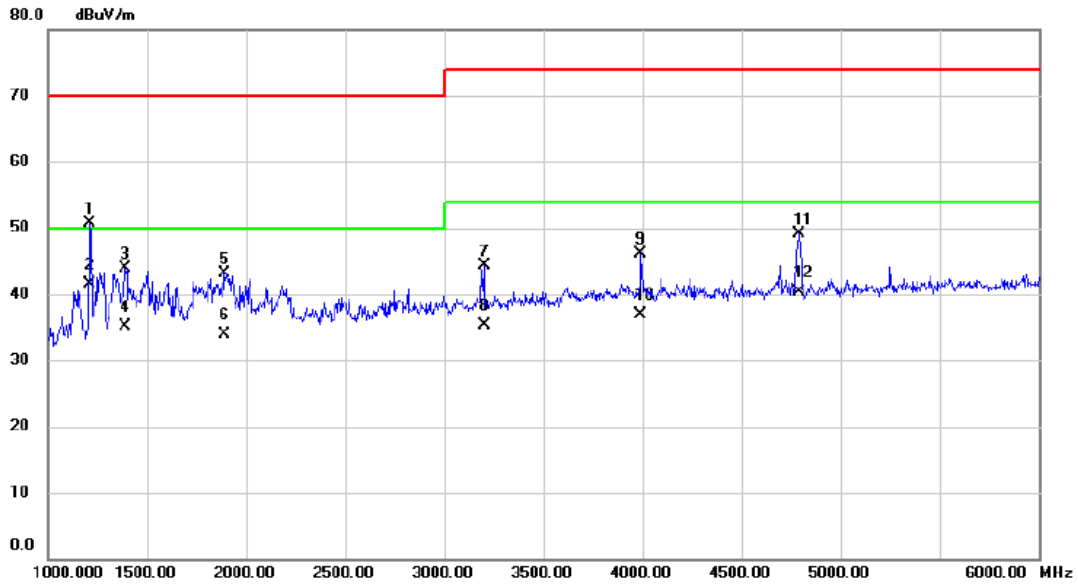

No.	Mk.	Freq. MHz	Reading Level dBuV	Correct Factor dB	Measure- ment dBuV/m	Limit dBuV/m	Margin dB	Detector	Comment
1		1212.500	56.22	-5.61	50.61	70.00	-19.39	peak	
2	*	1212.500	47.21	-5.61	41.60	50.00	-8.40	AVG	
3		1390.000	49.10	-5.13	43.97	70.00	-26.03	peak	
4		1390.000	40.15	-5.13	35.02	50.00	-14.98	AVG	
5		1892.500	46.45	-3.25	43.20	70.00	-26.80	peak	
6		1892.500	37.15	-3.25	33.90	50.00	-16.10	AVG	
7		3200.000	43.66	0.60	44.26	74.00	-29.74	peak	
8		3200.000	34.61	0.60	35.21	54.00	-18.79	AVG	
9		3992.500	43.53	2.63	46.16	74.00	-27.84	peak	
10		3992.500	34.25	2.63	36.88	54.00	-17.12	AVG	
11		4790.000	46.37	2.79	49.16	74.00	-24.84	peak	
12		4790.000	37.48	2.79	40.27	54.00	-13.73	AVG	

Test Voltage	AC 110V/60Hz	Polarization	Horizontal
Test Mode	Mode 1		

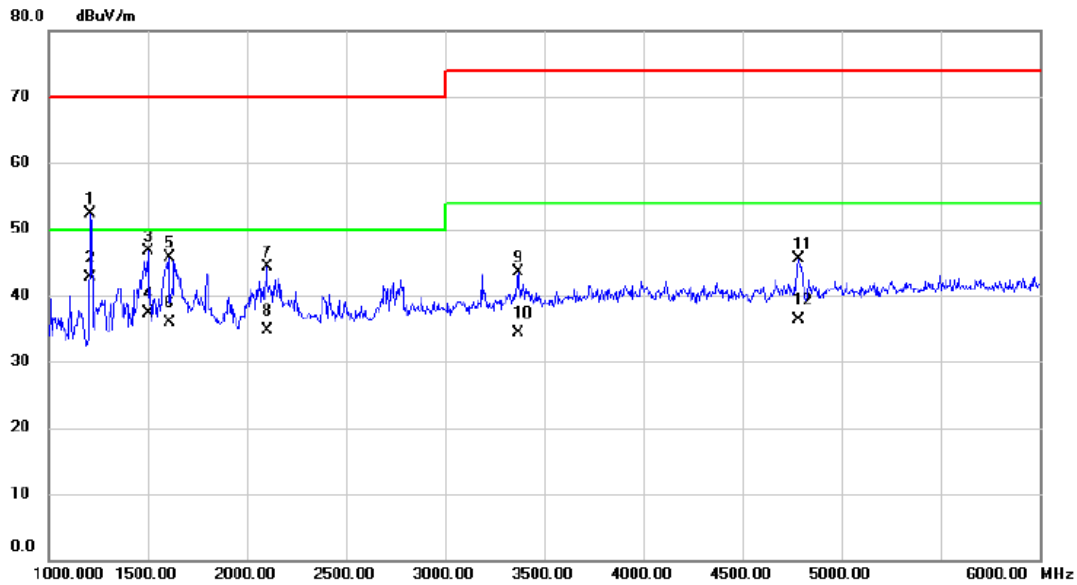

No.	Mk.	Freq. MHz	Reading Level dBuV	Correct Factor dB	Measure- ment dBuV/m	Limit dBuV/m	Margin dB	Detector	Comment
1		1210.000	57.88	-5.61	52.27	70.00	-17.73	peak	
2	*	1210.000	48.25	-5.61	42.64	50.00	-7.36	AVG	
3		1500.000	51.46	-4.83	46.63	70.00	-23.37	peak	
4		1500.000	42.16	-4.83	37.33	50.00	-12.67	AVG	
5		1607.500	50.17	-4.39	45.78	70.00	-24.22	peak	
6		1607.500	40.31	-4.39	35.92	50.00	-14.08	AVG	
7		2102.500	46.97	-2.57	44.40	70.00	-25.60	peak	
8		2102.500	37.25	-2.57	34.68	50.00	-15.32	AVG	
9		3367.500	42.49	0.98	43.47	74.00	-30.53	peak	
10		3367.500	33.24	0.98	34.22	54.00	-19.78	AVG	
11		4785.000	42.76	2.79	45.55	74.00	-28.45	peak	
12		4785.000	33.61	2.79	36.40	54.00	-17.60	AVG	

4.3 CONDUCTED EMISSION MEASUREMENT AT AC MAINS POWER PORTS

4.3.1 LIMITS

Requirements for conducted emissions from AC mains power ports of Class B equipment

Frequency Range MHz	Coupling Device	Detector Type / bandwidth	Class B Limits (dB(μV))
0.15 - 0.5	AMN	Quasi Peak / 9 kHz	66-56
0.5 - 5			56
5 - 30			60
0.15 - 0.5	AMN	Average / 9 kHz	56-46
0.5 - 5			46
5 - 30			50

NOTE:

(1) The test result calculated as following:

Measurement Value = Reading Level + Correct Factor

Correct Factor = Insertion Loss + Cable Loss + Attenuator Factor(if use)

Margin Level = Measurement Value – Limit Value

4.3.2 MEASUREMENT INSTRUMENTS LIST

Item	Kind of Equipment	Manufacturer	Type No.	Serial No.	Calibrated until
1	EMI TEST RECEIVER	R&S	ESCI	100382	Dec. 22, 2024
2	TWO-LINE V-NETWORK	R&S	ENV216	102974	Dec. 22, 2024
3	TWO-LINE V-NETWORK	R&S	ENV216	101447	Dec. 22, 2024
4	Measurement Software	Farad	EZ-EMC Ver.NB-03A1-01	N/A	N/A
5	Cable	N/A	SFT205-NMNM-9M -001	9M	Nov. 27, 2024

Remark: "N/A" denotes no model name, no serial no. or no calibration specified.

All calibration period of equipment list is one year.

4.3.3 TEST PROCEDURE

- a. The EUT was placed 0.8 meters from the horizontal ground plane with EUT being connected to the power mains through a line impedance stabilization network (LISN). All other support equipment powered from additional LISN(s). The LISN provide 50 Ohm/ 50uH of coupling impedance for the measuring instrument.
- b. Interconnecting cables that hang closer than 40 cm to the ground plane shall be folded back and forth in the center forming a bundle 30 to 40 cm long.
- c. I/O cables that are not connected to a peripheral shall be bundled in the center. The end of the cable may be terminated, if required, using the correct terminating impedance. The overall length shall not exceed 1 m.
- d. LISN at least 80 cm from nearest part of EUT chassis.
- e. For the actual test configuration, please refer to the related Item –EUT Test Photos.

4.3.4 DEVIATION FROM TEST STANDARD

No deviation

4.3.5 TEST SETUP

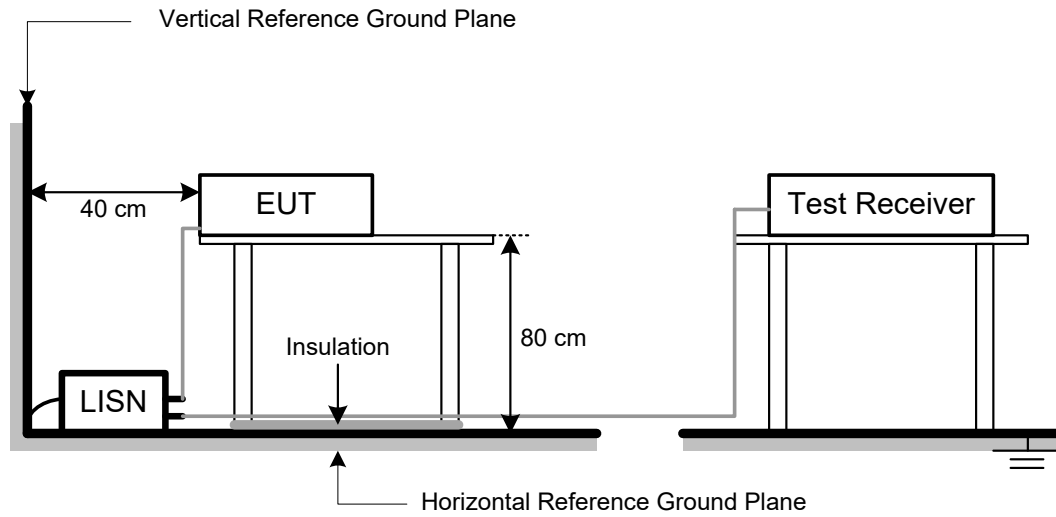

4.3.6 TEST RESULTS

Test Voltage	AC 230V/50Hz	Phase	Line
Test Mode	Mode 1		

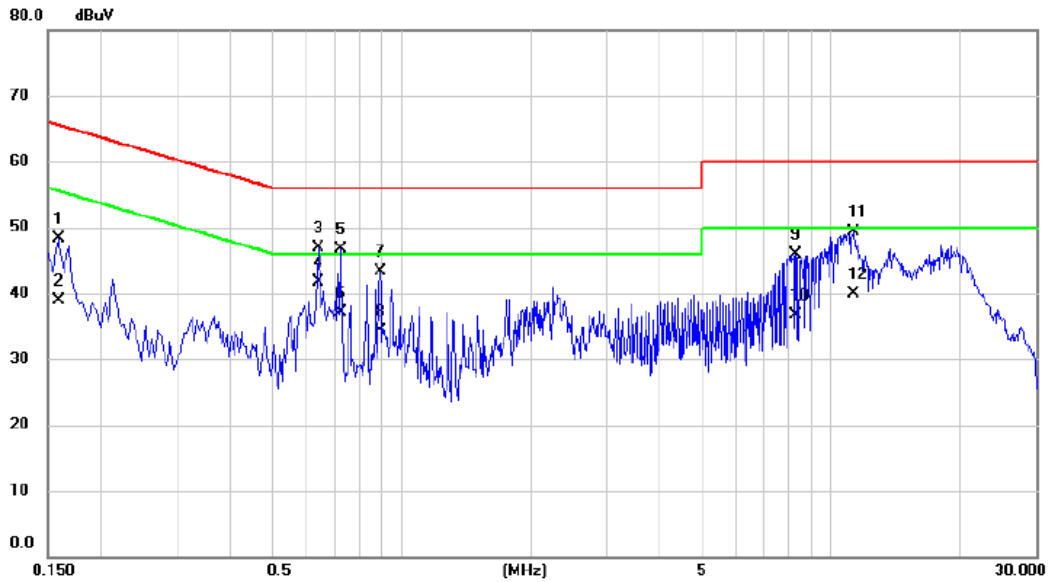

No.	Mk.	Freq. MHz	Reading Level dBuV	Correct Factor dB	Measure- ment dBuV	Limit dBuV	Margin dB	Detector	Comment
1		0.1590	38.53	9.74	48.27	65.52	-17.25	QP	
2		0.1590	29.10	9.74	38.84	55.52	-16.68	AVG	
3		0.6405	37.05	9.79	46.84	56.00	-9.16	QP	
4	*	0.6405	31.90	9.79	41.69	46.00	-4.31	AVG	
5		0.7215	36.87	9.80	46.67	56.00	-9.33	QP	
6		0.7215	27.40	9.80	37.20	46.00	-8.80	AVG	
7		0.8925	33.52	9.81	43.33	56.00	-12.67	QP	
8		0.8925	24.50	9.81	34.31	46.00	-11.69	AVG	
9		8.2590	35.59	10.32	45.91	60.00	-14.09	QP	
10		8.2590	26.40	10.32	36.72	50.00	-13.28	AVG	
11		11.3055	38.77	10.52	49.29	60.00	-10.71	QP	
12		11.3055	29.30	10.52	39.82	50.00	-10.18	AVG	

Test Voltage	AC 230V/50Hz	Phase	Neutral
Test Mode	Mode 1		

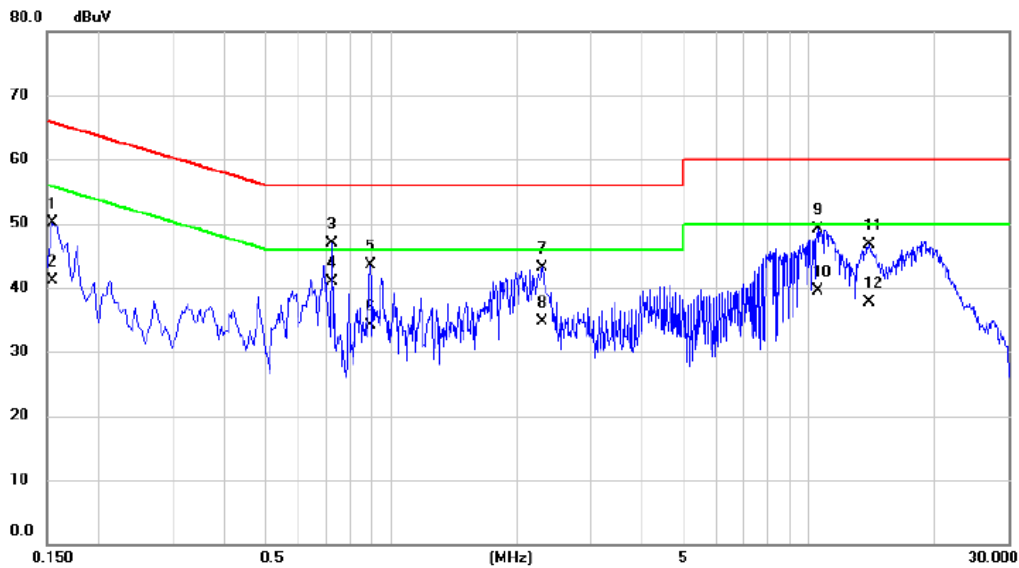

No.	Mk.	Freq. MHz	Reading Level dBuV	Correct Factor dB	Measure- ment dBuV	Limit dBuV	Margin dB	Detector	Comment
1		0.1545	40.50	9.59	50.09	65.75	-15.66	QP	
2		0.1545	31.50	9.59	41.09	55.75	-14.66	AVG	
3		0.7215	37.15	9.67	46.82	56.00	-9.18	QP	
4	*	0.7215	31.30	9.67	40.97	46.00	-5.03	AVG	
5		0.8925	33.78	9.67	43.45	56.00	-12.55	QP	
6		0.8925	24.50	9.67	34.17	46.00	-11.83	AVG	
7		2.3055	33.47	9.73	43.20	56.00	-12.80	QP	
8		2.3055	24.90	9.73	34.63	46.00	-11.37	AVG	
9		10.5045	38.67	10.44	49.11	60.00	-10.89	QP	
10		10.5045	29.10	10.44	39.54	50.00	-10.46	AVG	
11		13.9515	36.51	10.24	46.75	60.00	-13.25	QP	
12		13.9515	27.50	10.24	37.74	50.00	-12.26	AVG	

Test Voltage	AC 230V/50Hz	Phase	Line
Test Mode	Mode 3		

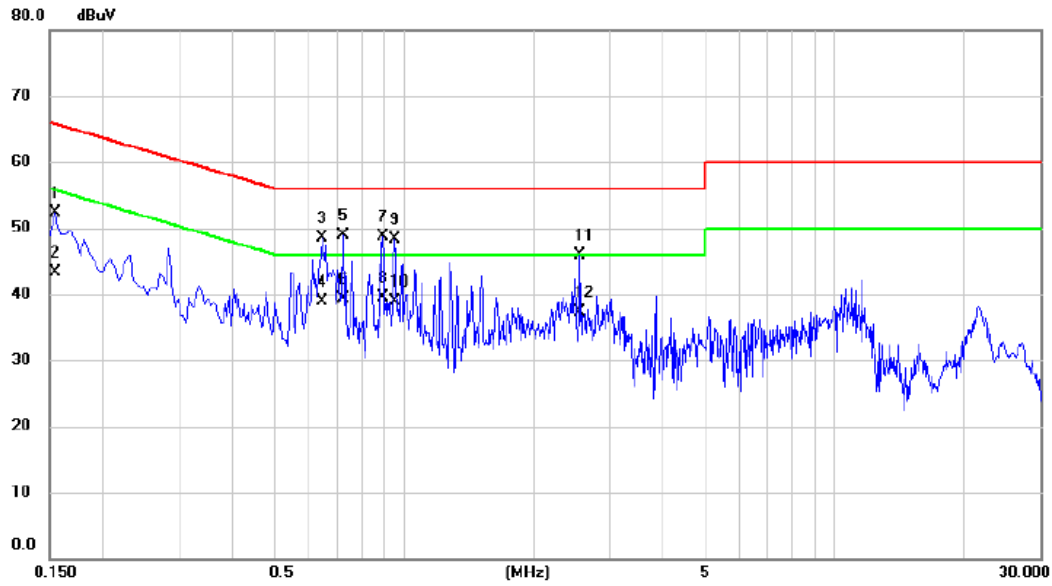

No.	Mk.	Freq. MHz	Reading Level dBuV	Correct Factor dB	Measure- ment dBuV	Limit dBuV	Margin dB	Detector	Comment
1		0.1544	42.52	9.74	52.26	65.76	-13.50	QP	
2		0.1544	33.50	9.74	43.24	55.76	-12.52	AVG	
3		0.6450	38.68	9.79	48.47	56.00	-7.53	QP	
4		0.6450	29.10	9.79	38.89	46.00	-7.11	AVG	
5		0.7214	39.05	9.80	48.85	56.00	-7.15	QP	
6		0.7214	29.50	9.80	39.30	46.00	-6.70	AVG	
7		0.8923	38.93	9.81	48.74	56.00	-7.26	QP	
8	*	0.8923	29.60	9.81	39.41	46.00	-6.59	AVG	
9		0.9510	38.46	9.82	48.28	56.00	-7.72	QP	
10		0.9510	29.10	9.82	38.92	46.00	-7.08	AVG	
11		2.5620	36.10	9.88	45.98	56.00	-10.02	QP	
12		2.5620	27.50	9.88	37.38	46.00	-8.62	AVG	

Test Voltage	AC 230V/50Hz	Phase	Neutral
Test Mode	Mode 3		

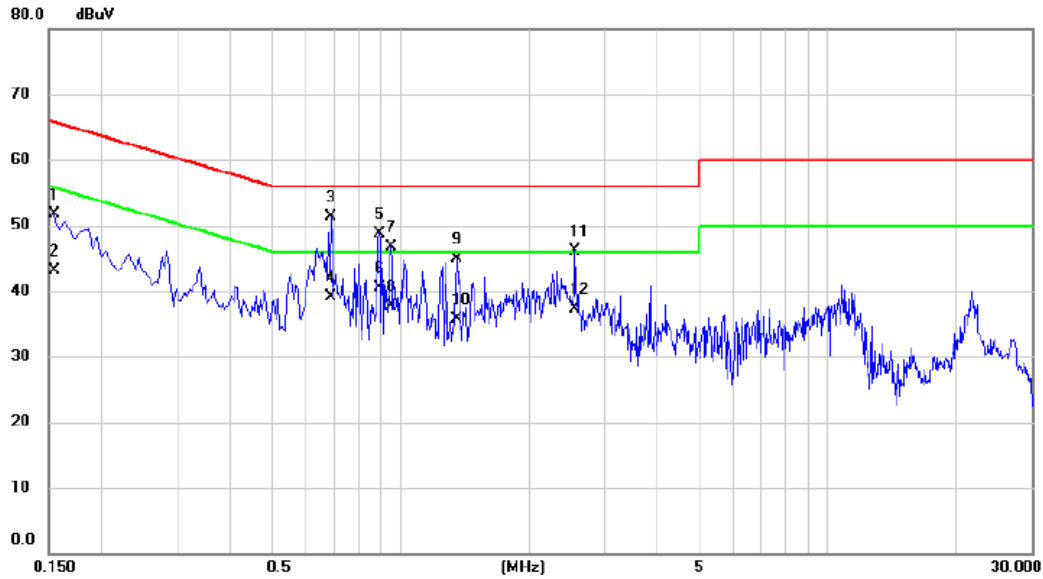

No.	Mk.	Freq. MHz	Reading Level dBuV	Correct Factor dB	Measure- ment dBuV	Limit dBuV	Margin dB	Detector	Comment
1		0.1544	42.16	9.59	51.75	65.76	-14.01	QP	
2		0.1544	33.60	9.59	43.19	55.76	-12.57	AVG	
3	*	0.6854	41.55	9.67	51.22	56.00	-4.78	QP	
4		0.6854	29.50	9.67	39.17	46.00	-6.83	AVG	
5		0.8923	39.13	9.67	48.80	56.00	-7.20	QP	
6		0.8923	30.80	9.67	40.47	46.00	-5.53	AVG	
7		0.9510	37.12	9.68	46.80	56.00	-9.20	QP	
8		0.9510	28.10	9.68	37.78	46.00	-8.22	AVG	
9		1.3560	35.12	9.69	44.81	56.00	-11.19	QP	
10		1.3560	26.10	9.69	35.79	46.00	-10.21	AVG	
11		2.5620	36.33	9.73	46.06	56.00	-9.94	QP	
12		2.5620	27.60	9.73	37.33	46.00	-8.67	AVG	

Test Voltage	AC 230V/50Hz	Phase	Line
Test Mode	Mode 4		

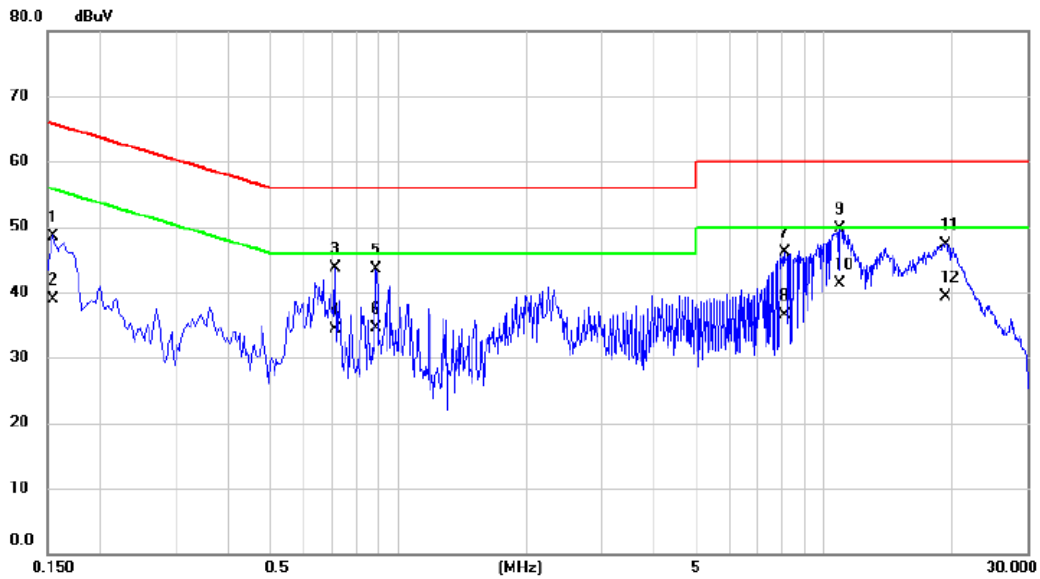

No.	Mk.	Freq. MHz	Reading Level dBuV	Correct Factor dB	Measure- ment dBuV	Limit dBuV	Margin dB	Detector	Comment
1		0.1548	38.86	9.74	48.60	65.74	-17.14	QP	
2		0.1548	29.10	9.74	38.84	55.74	-16.90	AVG	
3		0.7124	33.99	9.80	43.79	56.00	-12.21	QP	
4		0.7124	24.50	9.80	34.30	46.00	-11.70	AVG	
5		0.8880	33.65	9.81	43.46	56.00	-12.54	QP	
6		0.8880	24.60	9.81	34.41	46.00	-11.59	AVG	
7		8.0970	35.71	10.30	46.01	60.00	-13.99	QP	
8		8.0970	26.30	10.30	36.60	50.00	-13.40	AVG	
9		10.9050	39.11	10.55	49.66	60.00	-10.34	QP	
10	*	10.9050	30.80	10.55	41.35	50.00	-8.65	AVG	
11		19.2480	36.95	10.43	47.38	60.00	-12.62	QP	
12		19.2480	28.90	10.43	39.33	50.00	-10.67	AVG	

Test Voltage	AC 230V/50Hz	Phase	Neutral
Test Mode	Mode 4		

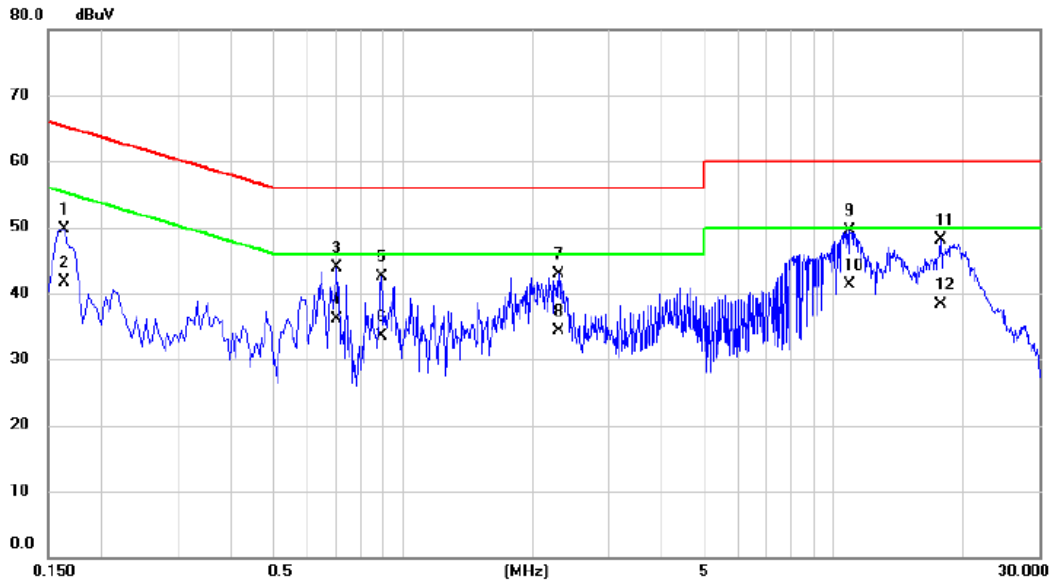

No.	Mk.	Freq. MHz	Reading Level dBuV	Correct Factor dB	Measure- ment dBuV	Limit dBuV	Margin dB	Detector	Comment
1		0.1635	40.18	9.59	49.77	65.28	-15.51	QP	
2		0.1635	32.20	9.59	41.79	55.28	-13.49	AVG	
3		0.7034	34.30	9.67	43.97	56.00	-12.03	QP	
4		0.7034	26.40	9.67	36.07	46.00	-9.93	AVG	
5		0.8924	32.82	9.67	42.49	56.00	-13.51	QP	
6		0.8924	23.80	9.67	33.47	46.00	-12.53	AVG	
7		2.3054	33.17	9.73	42.90	56.00	-13.10	QP	
8		2.3054	24.50	9.73	34.23	46.00	-11.77	AVG	
9		10.9050	39.04	10.41	49.45	60.00	-10.55	QP	
10	*	10.9050	30.80	10.41	41.21	50.00	-8.79	AVG	
11		17.7225	37.79	10.26	48.05	60.00	-11.95	QP	
12		17.7225	28.10	10.26	38.36	50.00	-11.64	AVG	

Test Voltage	AC 110V/60Hz	Phase	Line
Test Mode	Mode 1		

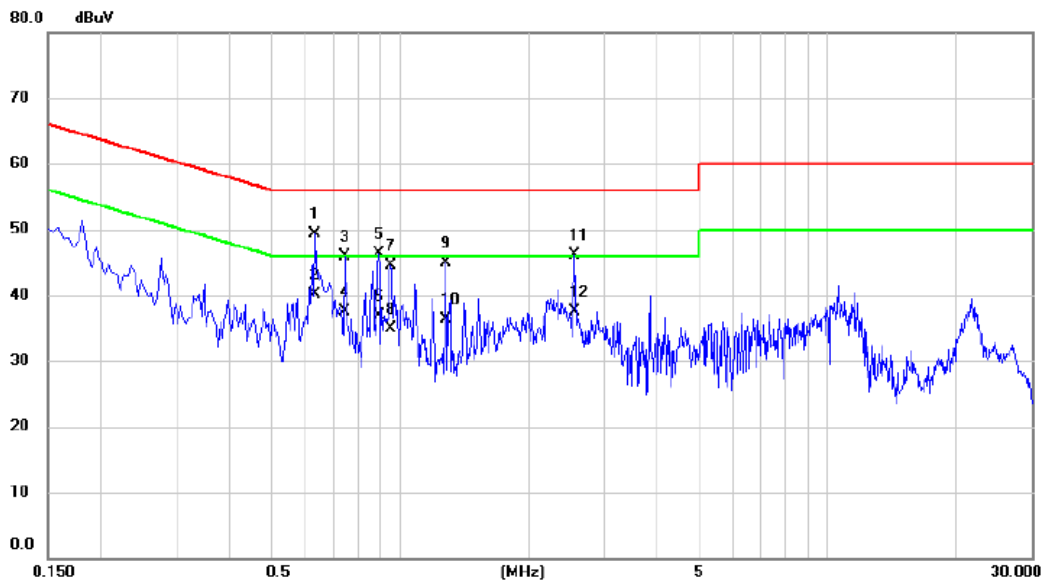

No.	Mk.	Freq. MHz	Reading Level dBuV	Correct Factor dB	Measure- ment dBuV	Limit dBuV	Margin dB	Detector	Comment
1		0.6313	39.57	9.79	49.36	56.00	-6.64	QP	
2	*	0.6313	30.30	9.79	40.09	46.00	-5.91	AVG	
3		0.7440	36.17	9.80	45.97	56.00	-10.03	QP	
4		0.7440	27.80	9.80	37.60	46.00	-8.40	AVG	
5		0.8923	36.50	9.81	46.31	56.00	-9.69	QP	
6		0.8923	27.10	9.81	36.91	46.00	-9.09	AVG	
7		0.9510	34.61	9.82	44.43	56.00	-11.57	QP	
8		0.9510	25.10	9.82	34.92	46.00	-11.08	AVG	
9		1.2840	35.07	9.83	44.90	56.00	-11.10	QP	
10		1.2840	26.50	9.83	36.33	46.00	-9.67	AVG	
11		2.5620	36.15	9.88	46.03	56.00	-9.97	QP	
12		2.5620	27.60	9.88	37.48	46.00	-8.52	AVG	

Test Voltage	AC 110V/60Hz	Phase	Neutral
Test Mode	Mode 1		

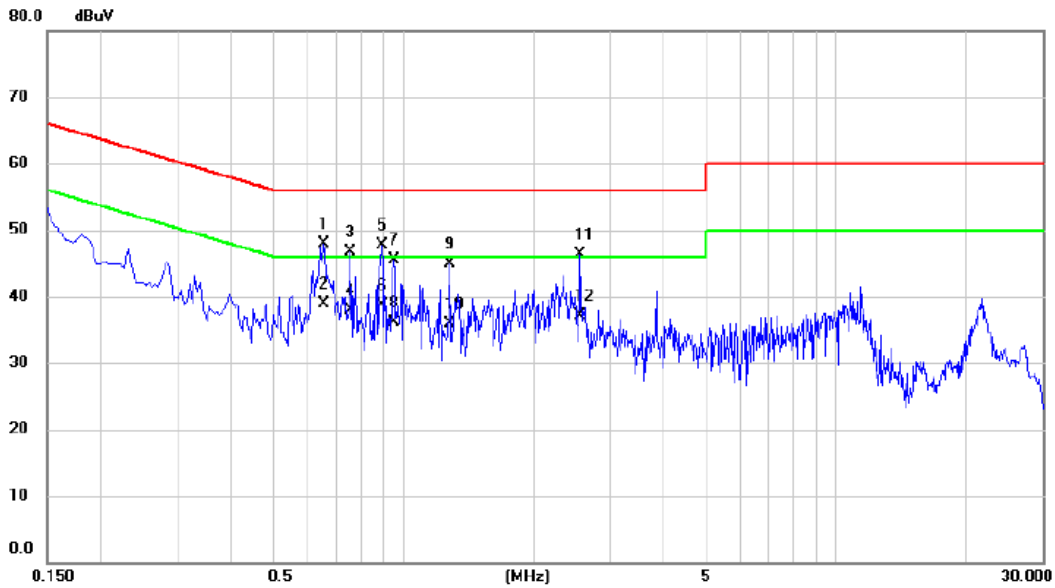

No.	Mk.	Freq. MHz	Reading Level dBuV	Correct Factor dB	Measure- ment dBuV	Limit dBuV	Margin dB	Detector	Comment
1		0.6540	38.30	9.67	47.97	56.00	-8.03	QP	
2	*	0.6540	29.30	9.67	38.97	46.00	-7.03	AVG	
3		0.7530	37.04	9.67	46.71	56.00	-9.29	QP	
4		0.7530	28.30	9.67	37.97	46.00	-8.03	AVG	
5		0.8923	38.08	9.67	47.75	56.00	-8.25	QP	
6		0.8923	29.10	9.67	38.77	46.00	-7.23	AVG	
7		0.9510	35.81	9.68	45.49	56.00	-10.51	QP	
8		0.9510	26.50	9.68	36.18	46.00	-9.82	AVG	
9		1.2794	35.24	9.69	44.93	56.00	-11.07	QP	
10		1.2794	26.30	9.69	35.99	46.00	-10.01	AVG	
11		2.5620	36.58	9.73	46.31	56.00	-9.69	QP	
12		2.5620	27.40	9.73	37.13	46.00	-8.87	AVG	

4.4 HARMONIC CURRENT EMISSIONS TEST

4.4.1 LIMITS

The power consumption is less than 75W, there is no limit applied.

4.4.2 MEASUREMENT INSTRUMENTS LIST

Item	Kind of Equipment	Manufacturer	Type No.	Serial No.	Calibrated until
1	Harmonics and Flicker Analyzer	California Instruments	PACS-1	72344	Jun. 01, 2025
2	3KVA AC Power source	California Instruments	3001ix	56309	Jun. 01, 2025
3	Measurement Software	California	CTS4.0 Version 4.29	N/A	N/A

Remark: "N/A" denotes no model name, no serial No. or no calibration specified.

All calibration period of equipment list is one year.

4.4.3 TEST PROCEDURE

- The EUT was placed on the top of a wooden table 0.8 meters above the ground and operated to produce the maximum harmonic components under normal operating conditions.
- The classification of EUT is according to of EN 61000-3-2. The EUT is classified as Class D.
- The correspondent test program of test instrument to measure the current harmonics emanated from EUT is chosen. The measure time shall be not less than the time necessary for the EUT to be exercised.

4.4.4 DEVIATION FROM TEST STANDARD

No deviation

4.4.5 TEST SETUP

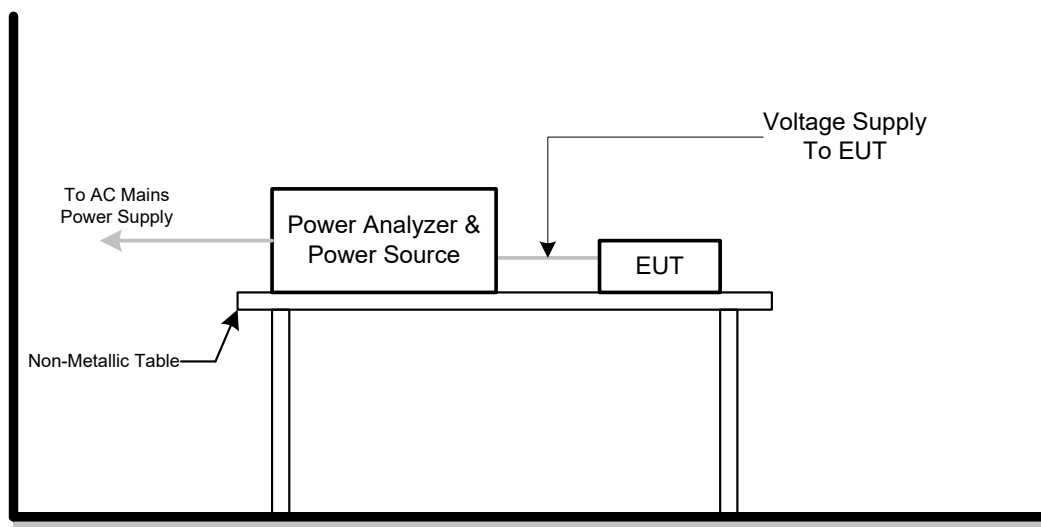

4.4.6 TEST RESULTS

Harmonics – Class-D	
Test Voltage	AC 230V/50Hz
Test Mode	Mode 1

Current & voltage waveforms



Harmonics and Class D limit line European Limits

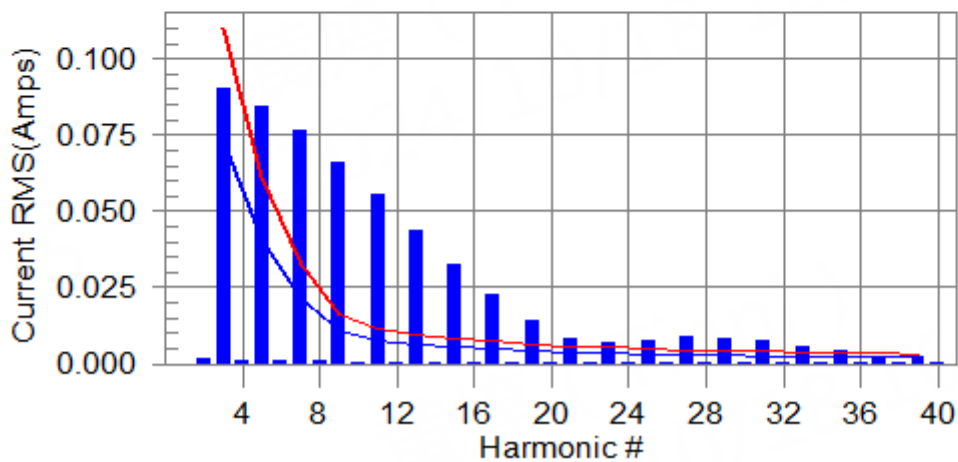

Testresult: N/L Worst harmonics H0-0.0% of 150% limit, H0-0% of 100% limit

Current Test Result Summary (Run time)

Test Voltage	AC 230V/50Hz
Test Mode	Mode 1

Highest parameter values during test:

V _{RMS} (Volts):	229.99	Frequency(Hz):	50.00
I _{Peak} (Amps):	0.835	I _{RMS} (Amps):	0.209
I _{Fund} (Amps):	0.103	Crest Factor:	4.017
Power (Watts):	21.6	Power Factor:	0.455

Harm#	Harms(avg)	100%Limit	%of Limit	Harms(max)	150%Limit	%of Limit	Status
2	0.001	0.000	N/A	0.002	0.000	N/A	N/L
3	0.090	0.073	N/A	0.092	0.110	N/A	N/L
4	0.001	0.000	N/A	0.002	0.000	N/A	N/L
5	0.084	0.041	N/A	0.085	0.061	N/A	N/L
6	0.001	0.000	N/A	0.001	0.000	N/A	N/L
7	0.076	0.022	N/A	0.077	0.032	N/A	N/L
8	0.001	0.000	N/A	0.001	0.000	N/A	N/L
9	0.066	0.011	N/A	0.067	0.016	N/A	N/L
10	0.001	0.000	N/A	0.001	0.000	N/A	N/L
11	0.055	0.008	N/A	0.056	0.011	N/A	N/L
12	0.000	0.000	N/A	0.001	0.000	N/A	N/L
13	0.044	0.006	N/A	0.045	0.010	N/A	N/L
14	0.000	0.000	N/A	0.000	0.000	N/A	N/L
15	0.033	0.006	N/A	0.033	0.008	N/A	N/L
16	0.000	0.000	N/A	0.000	0.000	N/A	N/L
17	0.023	0.005	N/A	0.023	0.007	N/A	N/L
18	0.000	0.000	N/A	0.000	0.000	N/A	N/L
19	0.014	0.004	N/A	0.015	0.007	N/A	N/L
20	0.000	0.000	N/A	0.001	0.000	N/A	N/L
21	0.009	0.004	N/A	0.009	0.006	N/A	N/L
22	0.000	0.000	N/A	0.001	0.000	N/A	N/L
23	0.007	0.004	N/A	0.007	0.005	N/A	N/L
24	0.000	0.000	N/A	0.000	0.000	N/A	N/L
25	0.008	0.003	N/A	0.008	0.005	N/A	N/L
26	0.000	0.000	N/A	0.000	0.000	N/A	N/L
27	0.009	0.003	N/A	0.009	0.005	N/A	N/L
28	0.000	0.000	N/A	0.000	0.000	N/A	N/L
29	0.009	0.003	N/A	0.009	0.004	N/A	N/L
30	0.000	0.000	N/A	0.000	0.000	N/A	N/L
31	0.008	0.003	N/A	0.008	0.004	N/A	N/L
32	0.000	0.000	N/A	0.000	0.000	N/A	N/L
33	0.006	0.003	N/A	0.006	0.004	N/A	N/L
34	0.000	0.000	N/A	0.000	0.000	N/A	N/L
35	0.004	0.002	N/A	0.004	0.004	N/A	N/L
36	0.000	0.000	N/A	0.000	0.000	N/A	N/L
37	0.002	0.002	N/A	0.003	0.003	N/A	N/L
38	0.000	0.000	N/A	0.000	0.000	N/A	N/L
39	0.002	0.002	N/A	0.002	0.003	N/A	N/L
40	0.000	0.000	N/A	0.000	0.000	N/A	N/L

Voltage Source Verification Data (Run time)	
Test Voltage	AC 230V/50Hz
Test Mode	Mode 1

Highest parameter values during test:

Voltage (Vrms):	229.99	Frequency(Hz):	50.00
I_Peak (Amps):	0.835	I_RMS (Amps):	0.209
I_Fund (Amps):	0.103	Crest Factor:	4.017
Power (Watts):	21.6	Power Factor:	0.455

Harm#	Harmonics V-rms	Limit V-rms	% of Limit	Status
2	0.137	0.460	29.69	OK
3	0.537	2.069	25.97	OK
4	0.061	0.460	13.34	OK
5	0.045	0.920	4.86	OK
6	0.031	0.460	6.68	OK
7	0.059	0.690	8.59	OK
8	0.019	0.460	4.16	OK
9	0.034	0.460	7.48	OK
10	0.023	0.460	5.03	OK
11	0.043	0.230	18.72	OK
12	0.016	0.230	7.04	OK
13	0.026	0.230	11.13	OK
14	0.013	0.230	5.78	OK
15	0.030	0.230	13.22	OK
16	0.017	0.230	7.26	OK
17	0.014	0.230	6.27	OK
18	0.014	0.230	5.93	OK
19	0.018	0.230	7.92	OK
20	0.019	0.230	8.34	OK
21	0.008	0.230	3.48	OK
22	0.011	0.230	4.65	OK
23	0.009	0.230	3.86	OK
24	0.005	0.230	2.01	OK
25	0.012	0.230	5.32	OK
26	0.008	0.230	3.28	OK
27	0.009	0.230	3.78	OK
28	0.007	0.230	3.26	OK
29	0.014	0.230	6.20	OK
30	0.005	0.230	2.12	OK
31	0.010	0.230	4.16	OK
32	0.005	0.230	1.98	OK
33	0.014	0.230	5.98	OK
34	0.003	0.230	1.22	OK
35	0.007	0.230	3.06	OK
36	0.002	0.230	1.07	OK
37	0.005	0.230	2.15	OK
38	0.003	0.230	1.18	OK
39	0.006	0.230	2.46	OK
40	0.007	0.230	2.87	OK

4.5 VOLTAGE FLUCTUATIONS (FLICKER) TEST

4.5.1 LIMITS

Tests	Limits	Descriptions
	EN 61000-3-3	
Pst	≤ 1.0 , Tp= 10 min.	Short Term Flicker Indicator
Plt	≤ 0.65 , Tp=2 hr.	Long Term Flicker Indicator
dc	$\leq 3.3\%$	Relative Steady-State V-Change
dmax	$\leq 4\%$	Maximum Relative V-change
d (t)	≤ 500 ms	Relative V-change characteristic

4.5.2 MEASUREMENT INSTRUMENTS LIST

Item	Kind of Equipment	Manufacturer	Type No.	Serial No.	Calibrated until
1	Harmonics and Flicker Analyzer	California Instruments	PACS-1	72344	Jun. 01, 2025
2	3KVA AC Power source	California Instruments	3001ix	56309	Jun. 01, 2025
3	Measurement Software	California	CTS4.0 Version 4.29	N/A	N/A

Remark: "N/A" denotes no model name, no serial No. or no calibration specified.

All calibration period of equipment list is one year.

4.5.3 TEST PROCEDURE

- Tests was performed according to the Test Conditions/Assessment of Voltage Fluctuations specified in EN 61000-3-3 depend on which standard adopted for compliance measurement.
- All types of harmonic current and/or voltage fluctuation in this report are assessed by direct measurement using flicker-meter.

4.5.4 DEVIATION FROM TEST STANDARD

No deviation

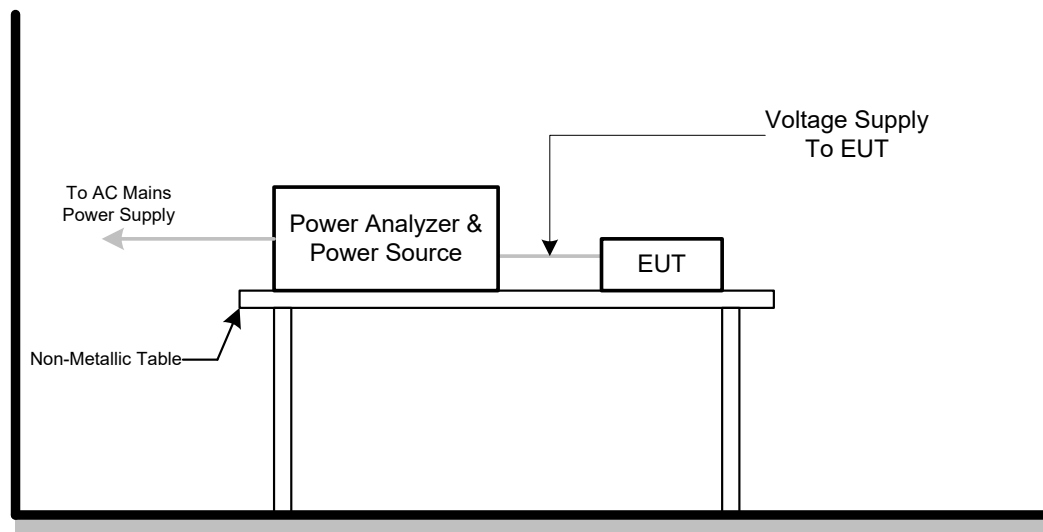
4.5.5 TEST SETUP

4.5.6 TEST RESULTS

Test Voltage	AC 230V/50Hz
Test Mode	Mode 1

Pst and limit line

European Limits

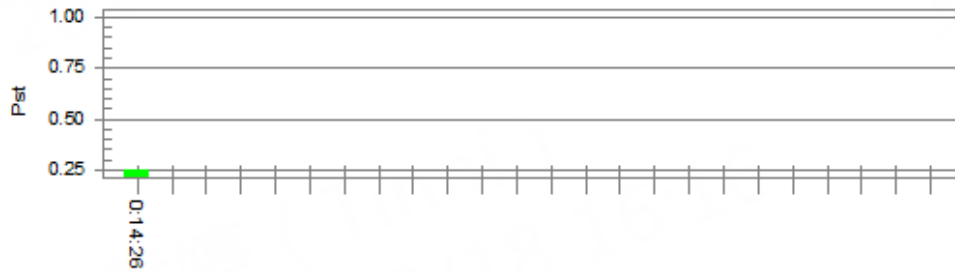

Plt and limit line

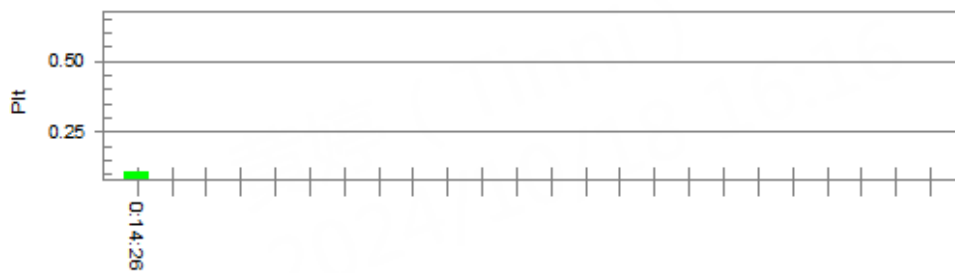

Parameter values recorded during the test:

Vrms at the end of test (Volt): 229.93

Highest dt (%):

T-max (mS): 0

Highest dc (%): 0.00

Highest dmax (%): 0.00

Highest Pst (10 min. period): 0.248

Highest Plt (2 hr. period): 0.108

Test limit (%):

Test limit (mS): 500.0 Pass

Test limit (%): 3.30 Pass

Test limit (%): 4.00 Pass

Test limit: 1.000 Pass

Test limit: 0.650 Pass

5. EMC IMMUNITY TEST

5.1 STANDARD COMPLIANCE/SEVERITY LEVEL/CRITERIA

Tests Standard No.	Test Specification Level / Test Mode	Test Ports	Criteria
Electrostatic discharge IEC 61000-4-2 (ESD)	±8kV air discharge ±4kV contact discharge (Direct Mode)	Enclosure	B
	±4kV HCP discharge ±4kV VCP discharge (Indirect Mode)	Enclosure	B
Continuous RF electromagnetic field disturbances,swept test IEC 61000-4-3 (RS)	80 MHz to 1000 MHz 3V/m(unmodulated, r.m.s), 1 kHz, 80%, AM modulated	Enclosure	A
Continuous RF electromagnetic field disturbances,spot test IEC 61000-4-3 (RS)	1800 MHz, 2600MHz, 3500 MHz, 5000MHz(±1 %) 3V/m(unmodulated, r.m.s), 1 kHz, 80%, AM modulated	Enclosure	A
Electrical fast transient/burst immunity IEC 61000-4-4 (EFT)	±0.5kV(peak) 5/50ns Tr/Th 5kHz Repetition Frequency (100kHz Repetition Frequency for xDSL port)	Analogue/digital data ports (NOTE 2)	B
	±0.5kV(peak) 5/50ns Tr/Th 5kHz Repetition Frequency	DC network power ports (NOTE 2)	B
	±1 kV(peak) 5/50ns Tr/Th 5kHz Repetition Frequency	AC mains power ports	B

Surge immunity IEC 61000-4-5 (Surge)	Port Type: unshielded symmetrical		
	Apply: lines to ground		
	Primary protection is Intended ±1 kV and ±4 kV 10/700(5/320)Tr/Th µs	Analogue/digital data ports (NOTE 1) & (NOTE 2)	C
	Primary protection is not Intended ±1 kV 10/700(5/320) Tr/Th µs		C
	Port type: coaxial or shielded		
	Apply: shield to ground		
±0.5 kV 1.2/50(8/20) Tr/Th µs	Analogue/digital data ports (NOTE 1) & (NOTE 2)	B	
line to reference ground for each individual line: ±0.5 kV(peak) 1.2/50(8/20) Tr/Th µs	DC network power ports (NOTE 2)	B	
±1 kV(peak) 1.2/50(8/20) Tr/Th µs (line to line) ±2 kV(peak) 1.2/50(8/20) Tr/Th µs (line to earth or ground)	AC mains power ports	B	
Continuous induced RF disturbances IEC 61000-4-6 (CS)	0.15 MHz to 10 MHz 3V(unmodulated, r.m.s), 10 MHz to 30 MHz 3V to 1V(unmodulated, r.m.s), 30 MHz to 80 MHz 1V(unmodulated, r.m.s), 1kHz 80%, AM 150Ω source impedance	Analogue/digital data ports (NOTE 2)	A
	0.15 MHz to 10 MHz 3V(unmodulated, r.m.s), 10 MHz to 30 MHz 3V to 1V(unmodulated, r.m.s), 30 MHz to 80 MHz 1V(unmodulated, r.m.s), 1kHz 80%, AM 150Ω source impedance	DC network power ports (NOTE 2)	A
	0.15 MHz to 10 MHz 3V(unmodulated, r.m.s), 10 MHz to 30 MHz 3V to 1V(unmodulated, r.m.s), 30 MHz to 80 MHz 1V(unmodulated, r.m.s), 1kHz 80%, AM 150Ω source impedance	AC mains power ports	A

Power frequency magnetic field immunity IEC 61000-4-8 (PFMF)	50 Hz or 60Hz, 1A/m(r.m.s)	Enclosure	A
Voltage dips, short interruptions and voltage variations immunity IEC 61000-4-11 (Dips)	Voltage dips: Residual voltage<5% 0.5 cycle Residual voltage<70% 25 cycle(50Hz), 30 cycle (60Hz) Voltage interruptions: Residual voltage<5% 250 cycle (50Hz), 300 cycle (60Hz)	AC Power Ports	B C C
Broadband impulse noise disturbances, repetitive (BIN-R)	0.15 MHz to 0.5 MHz 107 dBuV 0.5 MHz to 10 MHz 107 dBuV to 36 dBuV 10 MHz to 30 MHz 36 dBuV to 30 dBuV	Analogue/digital data ports (Applicable only to CPE xDSL ports)	A
	0.70 ms 8.3 ms(for 60Hz) 10 ms(for 50Hz)	Analogue/digital data ports (Apply period based on the AC mains frequency)	A
Broadband impulse noise disturbances, isolated (BIN-I)	0.15 MHz to 30 MHz 110 dBuV	Analogue/digital data ports (Applicable only to CPE xDSL ports)	B
	0.24 ms 10 ms 300 ms	Analogue/digital data ports (Apply all burst durations)	B

Note.

- 1) Applicable only to ports which, according to the manufacturer's specification, may connect directly to outdoor cables.
- 2) Applicable only to ports which, according to the manufacturer's specification, support cable lengths greater than 3 m.

5.2 GENERAL PERFORMANCE CRITERIA

According to **EN 55035** standards, the general performance criteria as following:

Criterion A	<p>The equipment shall continue to operate as intended without operator intervention. No degradation of performance, loss of function or change of operating state is allowed below a performance level specified by the manufacturer when the equipment is used as intended. The performance level may be replaced by a permissible loss of performance. If the minimum performance level or the permissible performance loss is not specified by the manufacturer, then either of these may be derived from the product description and documentation, and by what the user may reasonably expect from the equipment if used as intended.</p>
Criterion B	<p>During the application of the disturbance, degradation of performance is allowed. However, no unintended change of actual operating state or stored data is allowed to persist after the test.</p> <p>After the test, the equipment shall continue to operate as intended without operator intervention; no degradation of performance or loss of function is allowed, below a performance level specified by the manufacturer, when the equipment is used as intended. The performance level may be replaced by a permissible loss of performance. If the minimum performance level (or the permissible performance loss), or recovery time, is not specified by the manufacturer, then either of these may be derived from the product description and documentation, and by what the user may reasonably expect from the equipment if used as intended.</p>
Criterion C	<p>Loss of function is allowed, provided the function is self-recoverable, or can be restored by the operation of the controls by the user in accordance with the manufacturer's instructions. A reboot or re-start operation is allowed.</p> <p>Information stored in non-volatile memory, or protected by a battery backup, shall not be lost.</p>

5.3 ANNEX D (NORMATIVE) - DISPLAY AND DISPLAY OUTPUT FUNCTION

5.3.1 PERFORMANCE CRITERIA

Performance criterion A

for continuous radiated and conducted disturbances tests:

Apply criterion A as defined in GENERAL PERFORMANCE CRITERIA. Additionally, an increase in any degradation greater than just perceptible by observation of the image shall not occur as a consequence of the application of the test. Examples of such degradations are:

- superimposed patterning;
- positional disturbances due to synchronisation errors;
- geometric distortion;
- change of contrast or brightness;
- picture artefacts;
- freezing or disturbance of motion;
- image loss;
- video data or decoding errors.

Performance criterion A

for the power frequency magnetic field tests:

Alternative 1: A continuous magnetic field of 1 A/m:

The jitter (in mm) shall not exceed the value
$$\frac{(\text{character height in mm} + 0,3) \times 2,5}{33,3}$$

Performance criterion B:

Apply criterion B as defined in GENERAL PERFORMANCE CRITERIA.

Performance criterion C:

Apply criterion C as defined in GENERAL PERFORMANCE CRITERIA.

5.4 ANNEX G (NORMATIVE) - AUDIO OUTPUT FUNCTION

5.4.1 PERFORMANCE CRITERIA

Performance criterion A:

For devices that support telephony functions the limits of Table G.3 shall apply.

With respect to Table G.3:

- the interference ratio (electrical or acoustic) shall meet the limits in column 3; or,
- the acoustic level of the demodulated audio shall be less than the limits in column 4; or,
- the digitally coded level of demodulated audio shall be less than limits in column 5; or,
- the analogue level of the demodulated audio shall be less than the limits in column 6.

Table G.3 – Performance criterion A – Limits for devices supporting telephony

Type of immunity test	Frequency range MHz	Acoustic or electrical interference ratio	Equivalent direct measurement		
			dB (SPL)	Digital dBm0	Analogue dBm
Conducted	0,15 to 30	-20 dB	55	-50	-50
	30 to 80	-10 dB	65	-40	-40
Radiated	80 to 1000	0 dB	75	-30	-30

For terminals connected to digital wired network ports (such as Ethernet, ISDN), measurements of the demodulated 1 kHz may be performed on a remote AE, ideally of the same design.

For all other devices:

The measured acoustic interference ratio and/or the measured electrical interference ratio during the test shall be –20 dB or better.

Performance criterion B:

Use the general performance criterion B. See GENERAL PERFORMANCE CRITERIA.

Performance criterion C:

Use the general performance criterion C. See GENERAL PERFORMANCE CRITERIA.

5.5 ELECTROSTATIC DISCHARGE IMMUNITY TEST (ESD)

5.5.1 TEST SPECIFICATION

Basic Standard	IEC 61000-4-2
Discharge Impedance	330 ohm / 150 pF
Required Performance	B
Discharge Voltage	Air Discharge: $\pm 2\text{kV}$, $\pm 4\text{kV}$, $\pm 8\text{kV}$ Contact Discharge: $\pm 2\text{kV}$, $\pm 4\text{kV}$
Polarity	Positive & Negative
Number of Discharge	20 times at each test point
Discharge Mode	Single Discharge
Discharge Period	1 second

5.5.2 MEASUREMENT INSTRUMENTS

Item	Kind of Equipment	Manufacturer	Type No.	Serial No.	Calibrated until
1	ESD Generator	TESEQ AG	NSG 437	450	Nov. 12, 2024

Remark: "N/A" denotes no model name, no serial No. or no calibration specified.

All calibration period of equipment list is one year.

5.5.3 TEST PROCEDURE

The test generator necessary to perform direct and indirect application of discharges to the EUT in the following manner:

- a. The test shall be performed with single discharges. On each pre-selected point at least 10 single discharges (in the most sensitive polarity) shall be applied.

NOTE 1 The minimum number of discharges applied is depending on the EUT; for products with synchronized circuits the number of discharges should be larger.

For the time interval between successive single discharges an initial value of 1 s is recommended. Longer intervals may be necessary to determine whether a system failure has occurred.

NOTE 2 The points to which the discharges should be applied may be selected by means of an exploration carried out at a repetition rate of 20 discharges per second, or more.

Vertical Coupling Plane (VCP):

The coupling plane, of dimensions 0.5m x 0.5m, is placed parallel to, and positioned at a distance 0.1m from, the EUT, with the Discharge Electrode touching the coupling plane.

The four faces of the EUT will be performed with electrostatic discharge.

Horizontal Coupling Plane (HCP):

The coupling plane is placed under to the EUT. The generator shall be positioned vertically at a distance of 0.1m from the EUT, with the Discharge Electrode touching the coupling plane.

The four faces of the EUT will be performed with electrostatic discharge.

- b. For TABLE-TOP equipment:

The configuration consisted of a wooden table 0.8 meters high standing on the Ground Reference Plane. The GRP consisted of a sheet of aluminum at least 0.25mm thick, and 2.5 meters square connected to the protective grounding system. A Horizontal Coupling Plane (1.6m x 0.8m) was placed on the table and attached to the GRP by means of a cable with 940k total impedance. The equipment under test was installed in a representative system as described in IEC 61000-4-2, and its cables were placed on the HCP and isolated by an insulating support of 0.5mm thickness. A distance of 1-meter minimum was provided between the EUT and the walls of the laboratory and any other metallic structure.

5.5.4 DEVIATION FROM TEST STANDARD

No deviation

5.5.5 TEST SETUP

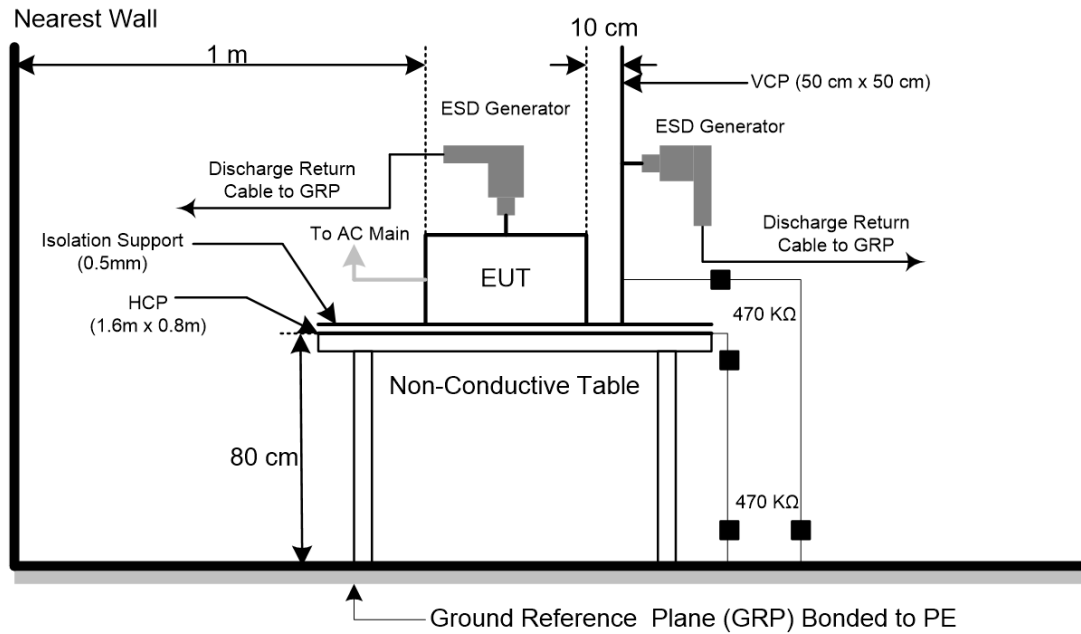

5.5.6 TEST RESULTS

Test Voltage	AC 230V/50Hz
Test Mode	Mode 1-4, Mode 7-10

Mode	Air Discharge								Contact Discharge					
	2kV		4kV		8kV		- kV		2kV		4kV		- kV	
Test Level	P	N	P	N	P	N	P	N	P	N	P	N	P	N
Location	P	N	P	N	P	N	P	N	P	N	P	N	P	N
1	A	A	A	A	A	A	-	-	A	A	B	B	-	-
2	A	A	A	A	A	A	-	-	-	-	-	-	-	-
3	A	A	A	A	B	B	-	-	-	-	-	-	-	-
4	A	A	A	A	B	B	-	-	-	-	-	-	-	-
Criteria	B						-		B				-	
Result	B						-		B				-	

Mode	HCP Contact Discharge						VCP Contact Discharge					
	2kV		4kV		- kV		2kV		4kV		- kV	
Test Level	P	N	P	N	P	N	P	N	P	N	P	N
Location	P	N	P	N	P	N	P	N	P	N	P	N
Left side	A	A	A	A	-	-	A	A	A	A	-	-
Right side	A	A	A	A	-	-	A	A	A	A	-	-
Front side	A	A	A	A	-	-	A	A	A	A	-	-
Rear side	A	A	A	A	-	-	A	A	A	A	-	-
Criteria	B				-		B				-	
Result	A				-		A				-	

Note:

- 1) P/N denotes the Positive/Negative polarity of the output voltage.
- 2) N/A - denotes test is not applicable in this test report

PHOTO(S) SHOWN THE LOCATION(S) OF ESD EVALUATED

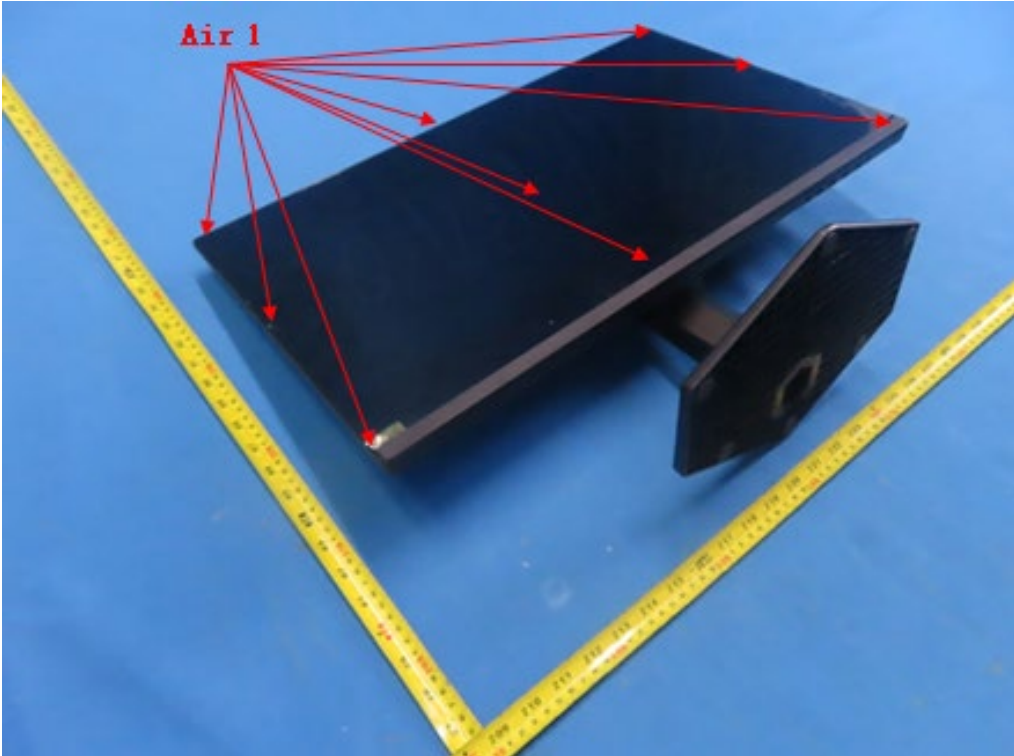

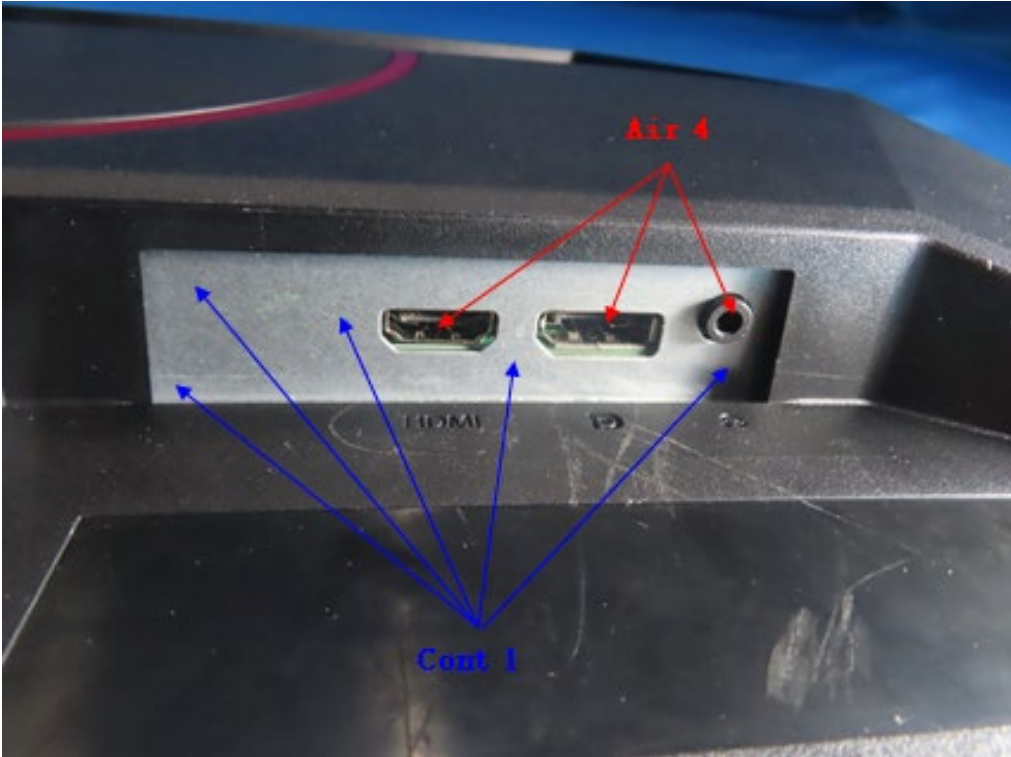
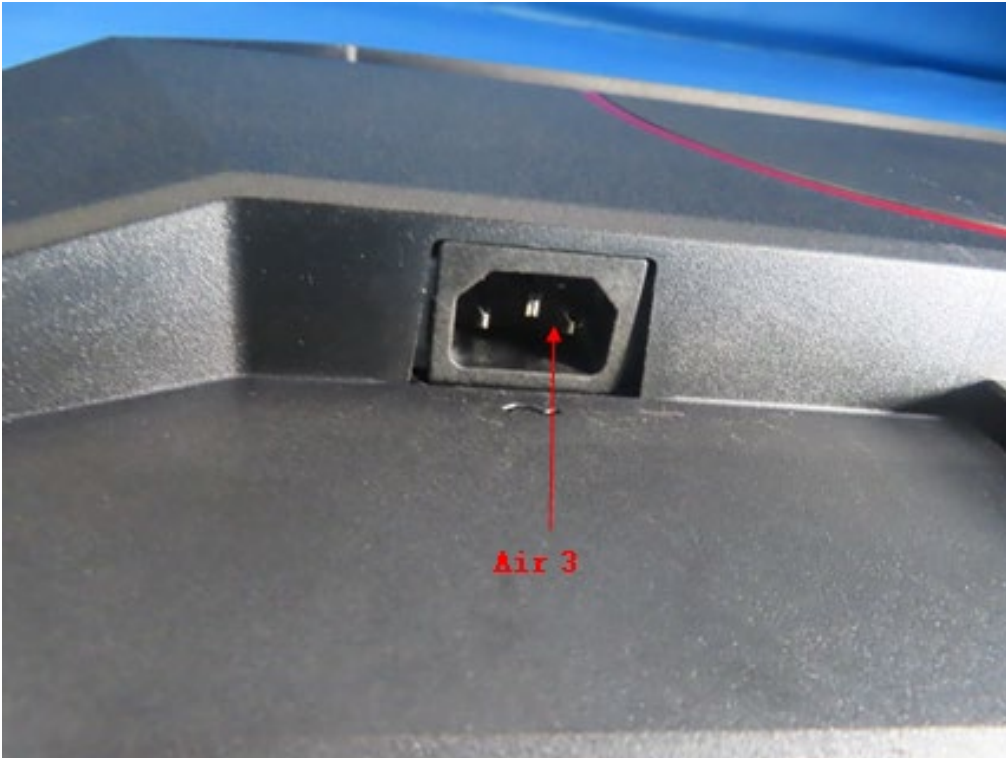

5.6 RADIATED, RADIO-FREQUENCY, ELECTROMAGNETIC FIELD IMMUNITY TEST (RS)

5.6.1 TEST SPECIFICATION

Basic Standard	IEC 61000-4-3
Required Performance	A
Frequency Range	80 MHz - 1000 MHz, 1800 MHz, 2600 MHz, 3500 MHz, 5000MHz ($\pm 1\%$)
Field Strength	3 V/m(unmodulated, r.m.s)
Modulation	1 kHz Sine Wave, 80%, AM Modulation
Frequency Step	1% of the preceding frequency.
Polarity of Antenna	Horizontal and Vertical
Test Distance	3 m
Antenna Height	1.55 m
Dwell Time	3 seconds

5.6.2 MEASUREMENT INSTRUMENTS

Item	Kind of Equipment	Manufacturer	Type No.	Serial No.	Calibrated until
1	Stacked Double Log.-Per.Antenna	Schwarzbeck	STLP 9129	00210	N/A
2	Power amplifier	RFLIGHT	NTWPA-00810300	21113246	Jan. 19, 2025
3	Power amplifier	RFLIGHT	NTWPA-1060100P	21123268	Jan. 19, 2025
4	MXG Vector Signal Generator	Keysight	N5181A	MY50144565	Jun. 28, 2025
5	Measurement Software	Tonscend	TS+	N/A	N/A
6	UPV Audio Analyzer	R&S	UPV	101941	Jun. 28, 2025

Remark: "N/A" denotes no model name, no serial No. or no calibration specified.

All calibration period of equipment list is one year.

5.6.3 TEST PROCEDURE

The EUT and support equipment are in a fully-anechoic chamber.

The testing distance from antenna to the EUT was 3 meters.

For TABLE-TOP equipment:

The EUT installed in a representative system as described in IEC 61000-4-3 was placed on a non-conductive table 0.8 meters in height. The system under test was connected to the power and signal wire according to relevant installation instructions.

- a. The field strength level was 3 V/m(unmodulated, r.m.s).
- b. The frequency range is swept from 80 MHz to 1000 MHz, with the signal 80%amplitude modulated with a 1 kHz sine wave. Where the frequency range is swept incrementally, the step size was 1% of the preceding frequency.
- c. The dwell time at each frequency shall be not less than the time necessary for the EUT to be able to respond.
- d. The test was performed with the EUT exposed to both vertically and horizontally polarized fields on each of the four sides.

For Display and display output functions:

- a. The display quality evaluated by direct observation.
- b. For display output function evaluation, a suitable display device shall be connected. This device shall meet the immunity requirements for displays specified in this document. The screen size shall be typical for the display output. the diagonal screen size shall be at least 0,50 m.
- c. The display shall be observed under normal viewing conditions including viewing distance using a reduced ambient light level preferably in the range 15 lx to 20 lx. The viewing distance or settings of the video camera monitoring system shall be sufficient to provide visibility of the whole display. In the case of direct observation the selected viewing distance shall be recorded in the test report.

For Acoustic measurements:

- a. Apply an appropriate input signal to the EUT so that a sine wave (tone) at the frequency that will be used to modulate the applied disturbance (typically 1 kHz) is generated from the port under test at a level equal to the acoustic reference level.
- b. Record the resulting dB (SPL) level (or other appropriate dB unit) as the value of L_0 .
(BTL lab uses the software to take L_0 as the reference value and make it return to zero.)
- c. Change the input to the EUT so that the port under test is silent, or represents silence. This change shall not alter the terminating impedance at the EUT's input.
- d. Apply the RF disturbance to the applicable port of the EUT and record the resulting demodulated audio level in dB (SPL) (or other dB unit used in step d)) as the value of L_1 .
- e. Ensure that non-linear processing does not impact the measurements.
- f. Calculate the acoustic interference ratio using the following formula:
Acoustic interference ratio = $L_1 - L_0$.
(For step e-f, BTL lab proceeds the test with software and calculate Acoustic interference ratio = $L_1 - L_0$).

5.6.4 DEVIATION FROM TEST STANDARD

No deviation

5.6.5 TEST SETUP

- a) For Continuous induced RF disturbances

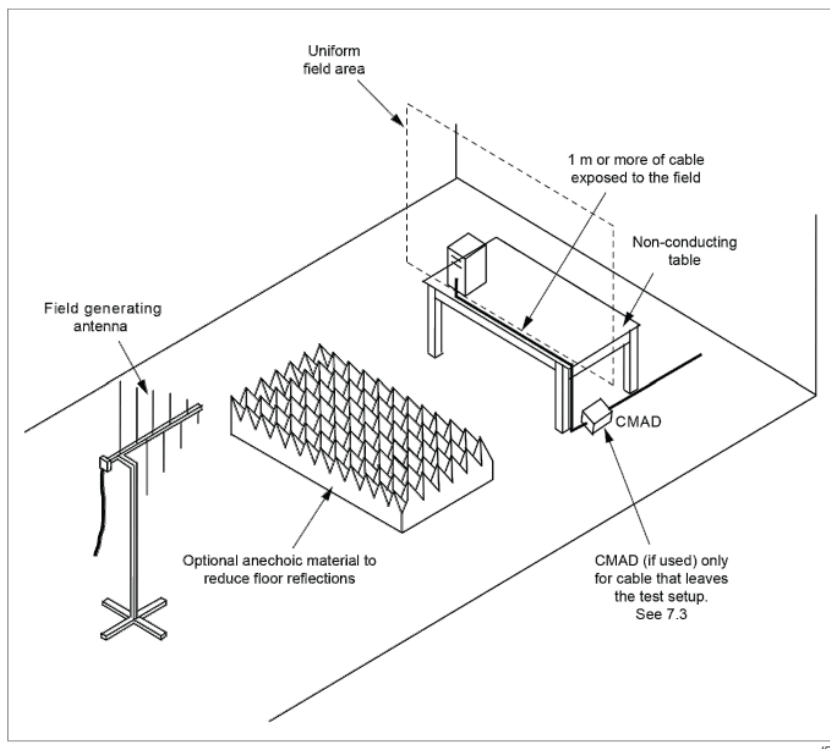

For Audio output function

(1) Audio output port

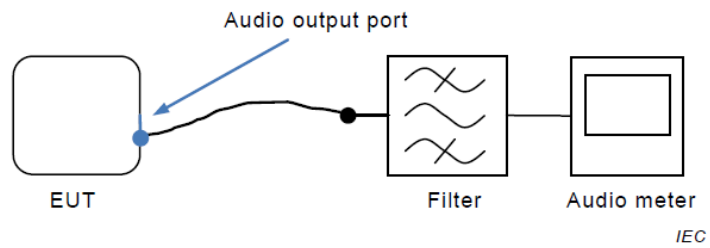

The filter is the audio filter specified in G.6.1 and is typically incorporated into the audio meter. Additional filtering might be necessary to ensure that the RF disturbance signal does not interfere with the measurement.

5.6.6 TEST RESULTS

Test Voltage	AC 230V/50Hz
Test Mode	Mode 1-4, Mode 7-10

Frequency Range (MHz)	RF Field Position	R.F. Field Strength	Modulation	Azimuth	Criterion	Result
80 - 1000	H / V	3V/m	AM Modulated 1000Hz, 80%	0	A	A
				90		
				180		
				270		
1800, 2600, 3500, 5000 (±1%)	H / V	3V/m	AM Modulated 1000Hz, 80%	0	A	A
				90		
				180		
				270		

For Audio output function

(1) For Audio output port:

Test Voltage	AC 230V/50Hz
Test Mode	Mode 1_Vertical_Front

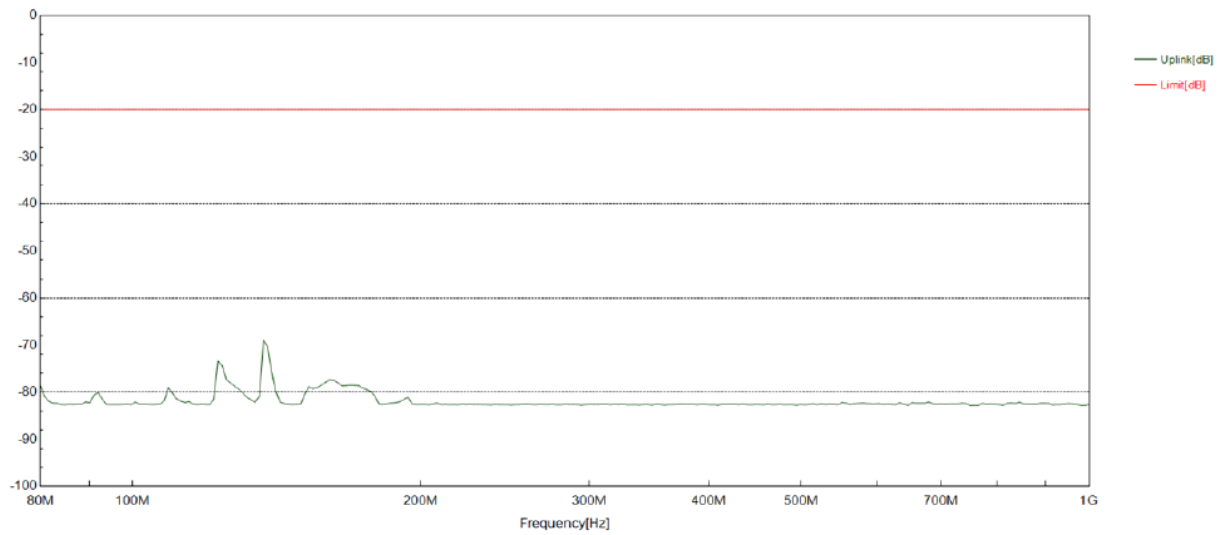

Test Voltage	AC 230V/50Hz
Test Mode	Mode 1_ Horizontal _Front

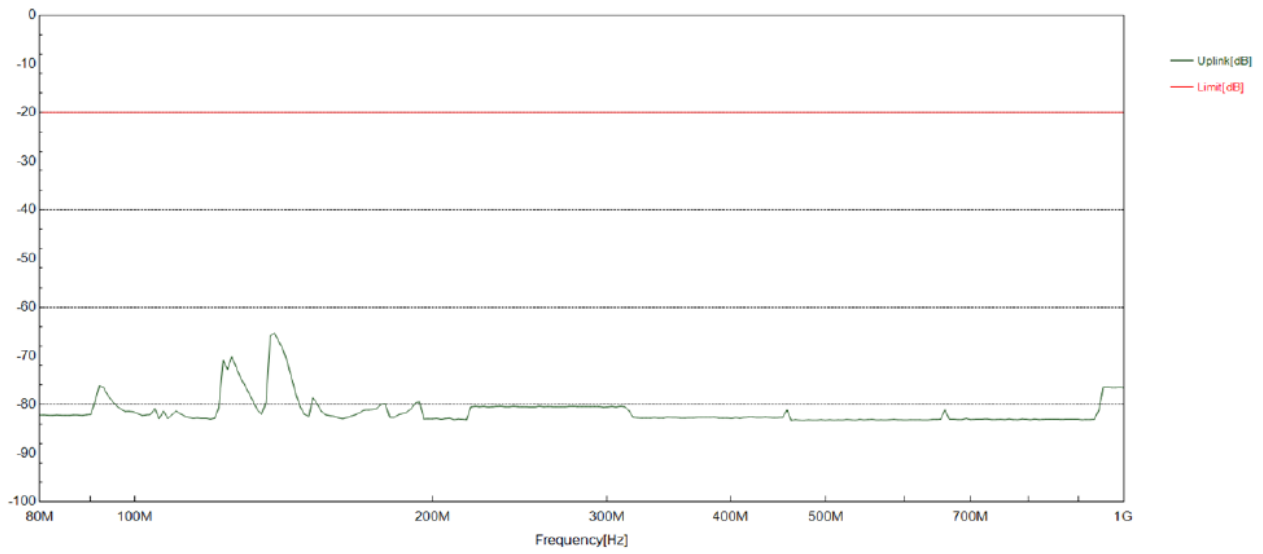

5.7 ELECTRICAL FAST TRANSIENT/BURST IMMUNITY TEST (EFT)

5.7.1 TEST SPECIFICATION

Basic Standard	IEC 61000-4-4
Required Performance	B
Test Voltage	AC mains power ports: ± 1 kV
Polarity	Positive & Negative
Impulse Frequency	5 kHz
Impulse Wave shape	5/50 ns
Burst Duration	15 ms
Burst Period	300 ms
Test Duration	1 min.

5.7.2 MEASUREMENT INSTRUMENTS

Item	Kind of Equipment	Manufacturer	Type No.	Serial No.	Calibrated until
1	Fast Transient Burst Simulator	Prima	EFT61004TA	PR201843360	Jun. 28, 2025
2	Measurement Software	Prima	EFT_Series	N/A	N/A

Remark: "N/A" denotes no model name, no serial No. or no calibration specified.

All calibration period of equipment list is one year.

5.7.3 TEST PROCEDURE

For TABLE-TOP equipment:

The configuration consisted of a wooden table (0.8m high) standing on the Ground Reference Plane and should be located 0.1 m \pm 0.01m above the Ground Reference Plane. The GRP consisted of a sheet of aluminum (at least 0.25mm thick and 2.5m square) connected to the protective grounding system. A minimum distance of 0.5m was provided between the EUT and the walls of the laboratory or any other metallic structure.

- a. Both positive and negative polarity discharges were applied.
- b. The duration time of each test sequential was 1 minute.

5.7.4 DEVIATION FROM TEST STANDARD

No deviation

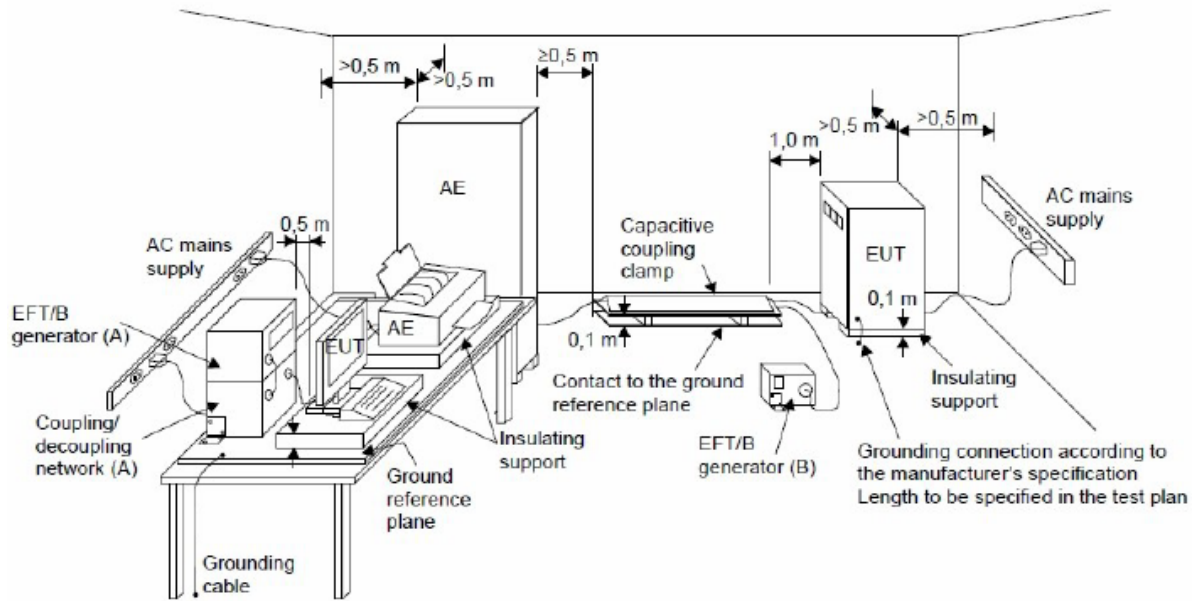
5.7.5 TEST SETUP

5.7.6 TEST RESULTS

Test Voltage	AC 230V/50Hz
Test Mode	Mode 1-4, Mode 7-10

EUT Ports Tested		Polarity	Repetition Frequency	Test Level	Criterion	Result
				1kV		
AC Power Port	Line (L)	+	5 kHz	A	B	A
		-	5 kHz	A		
	Neutral (N)	+	5 kHz	A	B	A
		-	5 kHz	A		
	Ground (PE)	+	5 kHz	A	B	A
		-	5 kHz	A		
	L+N	+	5 kHz	A	B	A
		-	5 kHz	A		
	L+PE	+	5 kHz	A	B	A
		-	5 kHz	A		
	N+PE	+	5 kHz	A	B	A
		-	5 kHz	A		
	L+N+PE	+	5 kHz	A	B	A
		-	5 kHz	A		

5.8 SURGE IMMUNITY TEST (SURGE)

5.8.1 TEST SPECIFICATION

Basic Standard	IEC 61000-4-5
Required Performance	B(AC mains power ports)
Wave-Shape	1.2/50(8/20) Tr/Th μ s combination wave
Test Voltage	AC mains power ports: ± 0.5 kV, ± 1 kV, ± 2 kV
Generator Source Impedance	2 Ω of the low-voltage power supply network. 12 Ω (10 Ω +2 Ω) of the low-voltage power supply network and ground.
Phase Angle, Polarity and Number of Tests	Five positive pulses line-to-neutral at 90°phase Five negative pulses line-to-neutral at 270°phase Five positive pulses line-to-earth at 90°phase Five negative pulses line-to-earth at 270°phase Five negative pulses neutral-to-earth at 90°phase Five positive pulses neutral-to-earth at 270°phase
Pulse Repetition Rate	1 time / min

5.8.2 MEASUREMENT INSTRUMENTS

Item	Kind of Equipment	Manufacturer	Type No.	Serial No.	Calibrated until
1	Lightning Surge Generator	Prima	SUG61005TB	PR210655102	Jun. 28, 2025
2	Measurement Software	Prima	SUG_Series	N/A	N/A

Remark: "N/A" denotes no model name, no serial No. or no calibration specified.

All calibration period of equipment list is one year.

5.8.3 TEST PROCEDURE

a. For EUT power supply:

The surge is to be applied to the EUT power supply terminals via the capacitive coupling network. Decoupling networks are required in order to avoid possible adverse effects on equipment not under test that may be powered by the same lines, and to provide sufficient decoupling impedance to the surge wave. The power cord between the EUT and the coupling/decoupling networks shall be 2meters in length (or shorter).

b. For test applied to unshielded unsymmetrically operated interconnection lines of EUT :

The surge is applied to the lines via the capacitive coupling. The coupling /decoupling networks shall not influence the specified functional conditions of the EUT. The interconnection line between the EUT and the coupling/decoupling networks shall be 2 meters in length (or shorter).

c. For test applied to unshielded symmetrically operated interconnection /telecommunication lines of EUT :

The surge is applied to the lines via gas arrestors coupling. Test levels below the ignition point of the coupling arrestor cannot be specified. The interconnection line between the EUT and the coupling/decoupling networks shall be 2 meters in length (or shorter).

5.8.4 DEVIATION FROM TEST STANDARD

No deviation

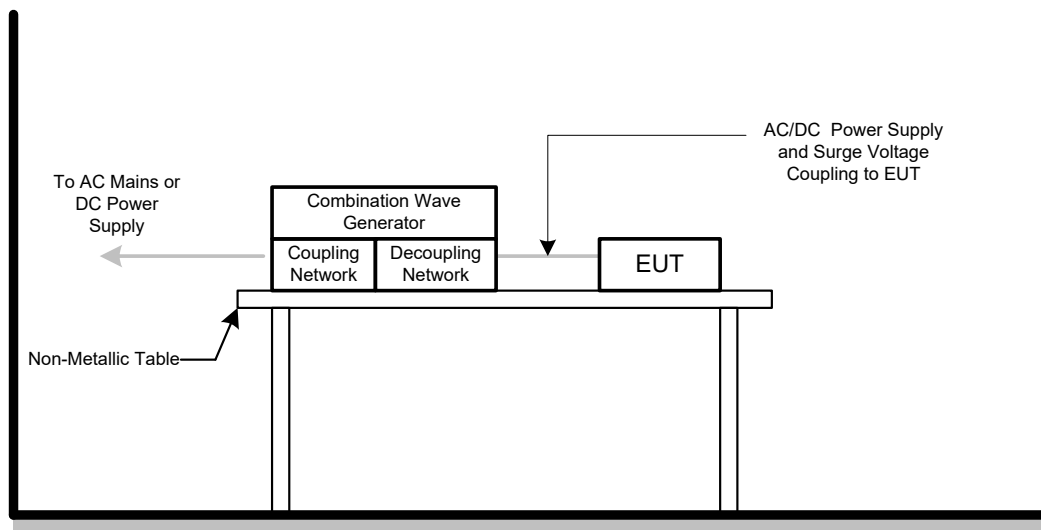
5.8.5 TEST SETUP

5.8.6 TEST RESULTS

Test Voltage	AC 230V/50Hz
Test Mode	Mode 1-4, Mode 7-10

Wave Form EUT Ports Tested		1.2/50(8/20)Tr/Thµs						Criterion	Result
		Polarity	Phase	Voltage					
				0.5kV	1kV	-- kV	-- kV		
AC	L – N	+	90°	A	A	-	-	B	A
		-	270°	A	A	-	-		

Wave Form EUT Ports Tested		1.2/50(8/20)Tr/Thµs						Criterion	Result
		Polarity	Phase	Voltage					
				0.5kV	1kV	2kV	-- kV		
AC	L – PE	+	90°	A	A	A	-	B	A
		-	270°	A	A	A	-		
	N – PE	-	90°	A	A	A	-	B	A
		+	270°	A	A	A	-		

5.9 IMMUNITY TO CONDUCTED DISTURBANCES, INDUCED BY RADIO-FREQUENCY FIELDS TEST (CS)

5.9.1 TEST SPECIFICATION

Basic Standard	IEC 61000-4-6
Required Performance	A
Frequency Range&Field Strength	0.15 MHz - 10 MHz: 3V (unmodulated, r.m.s.) 10 MHz - 30 MHz: 3V to 1V (unmodulated, r.m.s.) 30 MHz - 80 MHz: 1V (unmodulated, r.m.s.)
Modulation	1 kHz Sine Wave, 80%, AM Modulation
Frequency Step	1 % of the preceding frequency value
Dwell Time	3 seconds

5.9.2 MEASUREMENT INSTRUMENTS

Item	Kind of Equipment	Manufacturer	Type No.	Serial No.	Calibrated until
1	TEST SYSTEM FOR CONDUCTED AND RADIATED IMMUNITY	TESEQ	NSG 4070B	37513	Jun. 01, 2025
2	Attenuator	Teseq	100-SA-FFN-06	163357	May 31, 2025
3	Measurement Software	Farad	EZ-CS (V2.0.1.4)	N/A	N/A
4	Power CDN	FCC	FCC-801-M2/M3 -16A	100270	Dec. 22, 2024
5	Coupling Decoupling Network	Teseq GmbH	CDN M016	35834	May 31, 2025
6	UPV Audio Analyzer	R&S	UPV	104259	Dec. 22, 2024

Remark: "N/A" denotes no model name, no serial No. or no calibration specified.

All calibration period of equipment list is one year.

5.9.3 TEST PROCEDURE

The EUT and support equipment, are placed on a table that is 0.8 meter above a metal ground plane measured 1m*1m min. and 0.65mm thick min.

The other condition as following manner:

- The field strength level was 3 V (unmodulated, r.m.s.)
- The frequency range is swept from 150 kHz to 80 MHz, with the signal 80%amplitude modulated with a 1 kHz sinewave. Where the frequency range is swept incrementally, the step size shall not exceed 1 % of the preceding frequency value.
- The dwell time at each frequency shall be not less than the time necessary for the EUT to be able to respond.

For Display and display output functions:

- The display quality evaluated by direct observation.
- For display output function evaluation, a suitable display device shall be connected. This device shall meet the immunity requirements for displays specified in this document. The screen size shall be typical for the display output.the diagonal screen size shall be at least 0,50 m.
- The display shall be observed under normal viewing conditions including viewing distance using a reduced ambient light level preferably in the range 15 lx to 20 lx. The viewing distance or settings of the video camera monitoring system shall be sufficient to provide visibility of the whole display. In the case of direct observation the selected viewing distance shall be recorded in the test report.

For Acoustic measurements:

- Apply an appropriate input signal to the EUT so that a sine wave (tone) at the frequency that will be used to modulate the applied disturbance (typically 1 kHz) is generated from the port under test at a level equal to the acoustic reference level.
- Record the resulting dB (SPL) level (or other appropriate dB unit) as the value of L_0 . (BTL lab uses the software to take L_0 as the reference value and make it return to zero.)
- Change the input to the EUT so that the port under test is silent, or represents silence. This change shall not alter the terminating impedance at the EUT's input.
- Apply the RF disturbance to the applicable port of the EUT and record the resulting demodulated audio level in dB (SPL) (or other dB unit used in step d)) as the value of L_1 .
- Ensure that non-linear processing does not impact the measurements.
- Calculate the acoustic interference ratio using the following formula:
Acoustic interference ratio = $L_1 - L_0$.
(For step e-f, BTL lab proceeds the test with software and calculate Acoustic interference ratio = $L_1 - L_0$).

5.9.4 DEVIATION FROM TEST STANDARD

No deviation

5.9.5 TEST SETUP

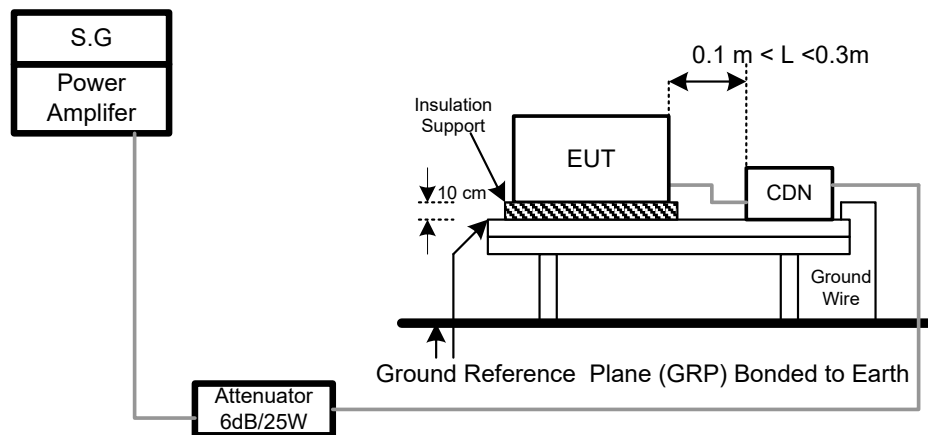

For Audio output function

(1) Audio output port

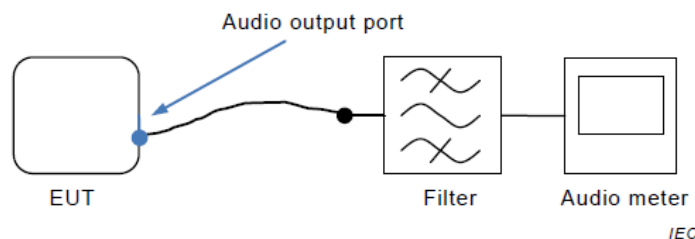

The filter is the audio filter specified in G.6.1 and is typically incorporated into the audio meter. Additional filtering might be necessary to ensure that the RF disturbance signal does not interfere with the measurement.

5.9.6 TEST RESULTS

Test Voltage	AC 230V/50Hz
Test Mode	Mode 1-4, Mode 7-10

Test Ports (Mode)	Freq.Range (MHz)	Field Strength	Modulation	Criteria	Results
AC mains power ports	0.15 - 10	3V	AM Modulated 1000Hz, 80%	A	A
	10 - 30	3V to 1V			
	30 - 80	1V			

For Audio output function

(1) For Audio output port:

Test Voltage	AC 230V/50Hz
Test Mode	Mode 1_CDN M3

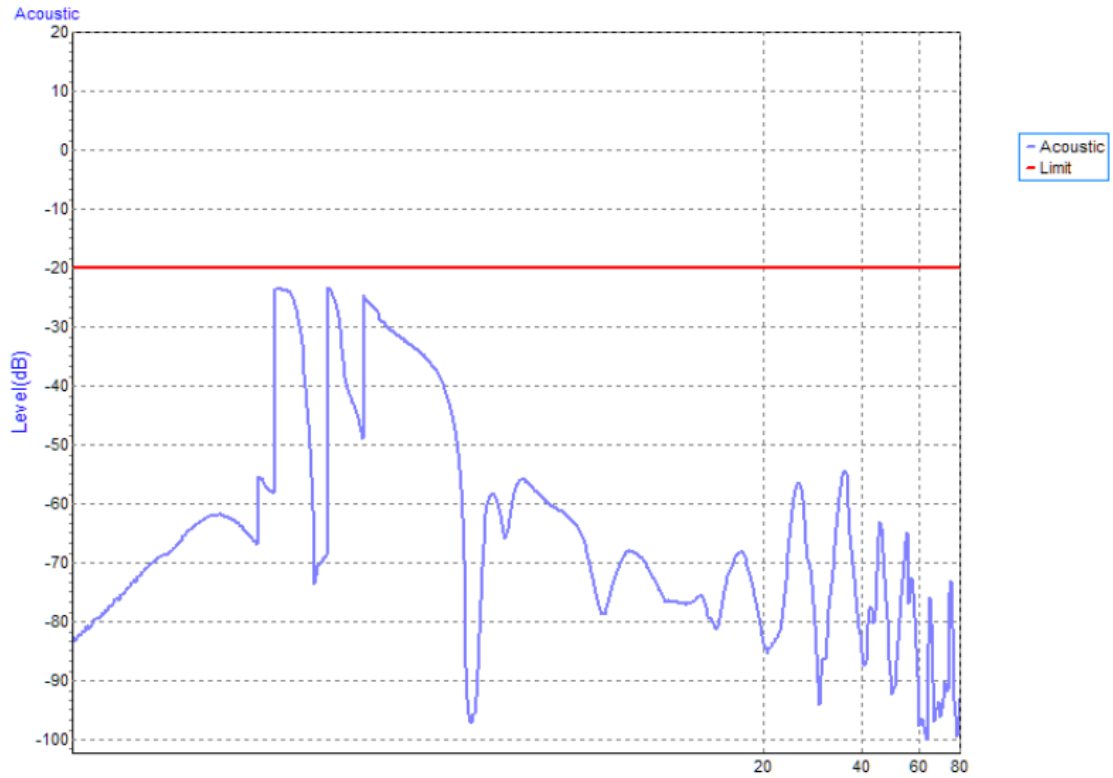

5.10 POWER FREQUENCY MAGNETIC FIELD IMMUNITY TEST (PFMF)

5.10.1 TEST SPECIFICATION

Basic Standard	IEC 61000-4-8
Required Performance	A
Frequency Range	50/60Hz
Field Strength	1 A/m
Observation Time	1 minute
Inductance Coil	Rectangular type, 1mx1m

5.10.2 MEASUREMENT INSTRUMENTS

Item	Kind of Equipment	Manufacturer	Type No.	Serial No.	Calibrated until
1	Power frequency magnetic field interferes with main engine	3ctest	MFS 400	ES045000821015	Jun. 28, 2025
2	Magnetic field generator module	3ctest	MFT400	ES046000121015	Jun. 28, 2025
3	magnetic field coil	3ctest	TCXS111	TCXS21070924	Jun. 28, 2025

Remark: "N/A" denotes no model name, no serial No. or no calibration specified.

All calibration period of equipment list is one year.

5.10.3 TEST PROCEDURE

For TABLE-TOP equipment:

The equipment shall be subjected to the test magnetic field by using the induction coil of standard dimension (1 m x 1 m). The induction coil shall then be rotated by 90 degrees in order to expose the EUT to the test field with different orientations.

The other condition as following manner:

- a. The equipment cabinets shall be connected to the safety earth directly on the GRP via the earth terminal of the EUT.
- b. The cables supplied or recommended by the equipment manufacturer shall be used. 1 meter of all cables used shall be exposed to the magnetic field.

5.10.4 DEVIATION FROM TEST STANDARD

No deviation

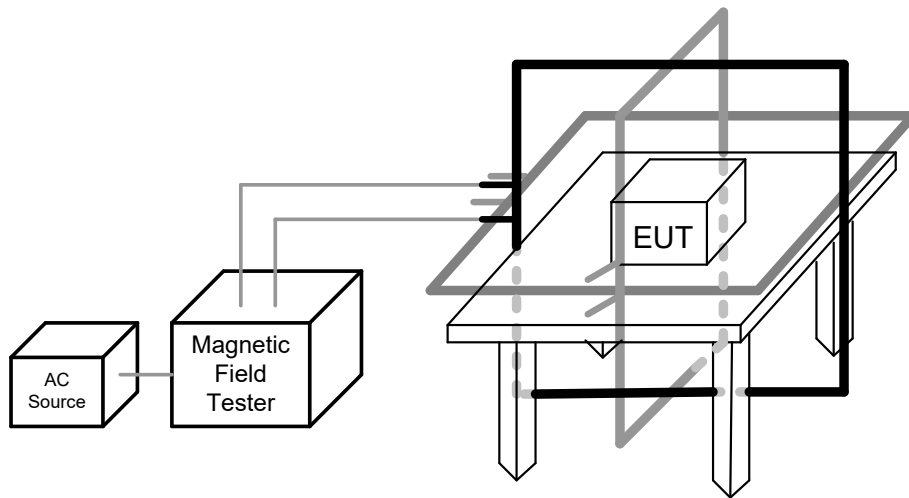
5.10.5 TEST SETUP

5.10.6 TEST RESULTS

Test Voltage	AC 230V/50Hz
Test Mode	Mode 1-4, Mode 7-10

50Hz

Test Mode	Test Level	Antenna aspect	Duration	Criteria	Results
Enclosure	1 A/m	X	60s	A	A
Enclosure	1 A/m	Y	60s	A	A
Enclosure	1 A/m	Z	60s	A	A

60Hz

Test Mode	Test Level	Antenna aspect	Duration	Criteria	Results
Enclosure	1 A/m	X	60s	A	A
Enclosure	1 A/m	Y	60s	A	A
Enclosure	1 A/m	Z	60s	A	A

5.11 VOLTAGE DIPS, SHORT INTERRUPTIONS AND VOLTAGE VARIATIONS IMMUNITY TEST (DIPS)

5.11.1 TEST SPECIFICATION

Basic Standard	IEC 61000-4-11
Required Performance	Voltage dips: B (For <5% residual voltage, dips) C (For 70% residual voltage, dips) C (For <5% residual voltage, Interruptions)
Interval between Event	Ten seconds
Phase Angle	0°/180°
Test Cycle	3 times

5.11.2 MEASUREMENT INSTRUMENTS

Item	Kind of Equipment	Manufacturer	Type No.	Serial No.	Calibrated until
1	Cycle Sag Simulator	Prima	DRP61011TA	PR19076452	May 31, 2025

Remark: "N/A" denotes no model name, no serial No. or no calibration specified.

All calibration period of equipment list is one year.

5.11.3 TEST PROCEDURE

The EUT shall be tested for each selected combination of test levels and duration with a sequence of three dips/interruptions with intervals of 10 s minimum (between each test event). Each representative mode of operation shall be tested. Abrupt changes in supply voltage shall occur at zero crossings of the voltage waveform.

5.11.4 DEVIATION FROM TEST STANDARD

No deviation

5.11.5 TEST SETUP

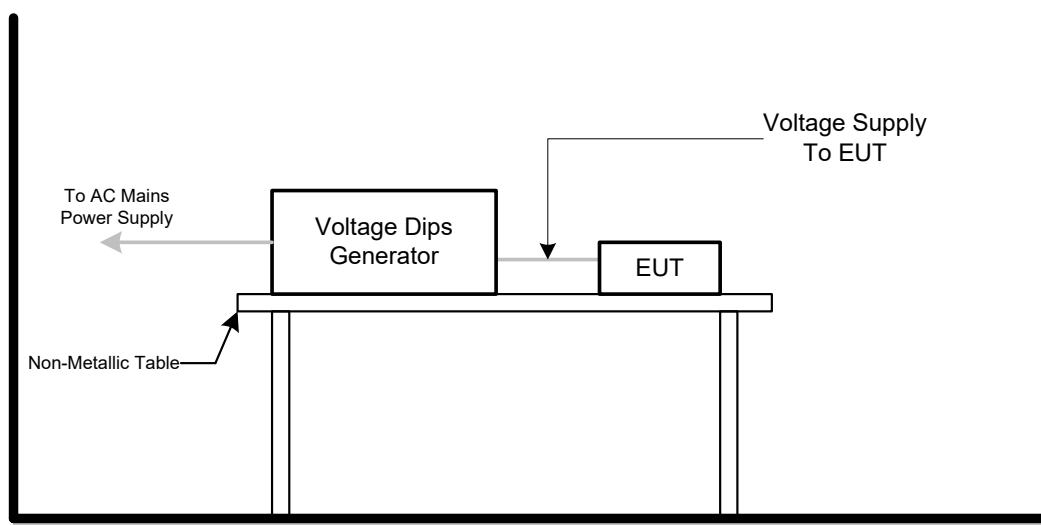

5.11.6 TEST RESULTS

Test Voltage	AC 100V/50Hz, AC 230V/50Hz, AC 240V/50Hz
Test Mode	Mode 1-4, Mode 7-10

AC 100V/50Hz				
Item	Residual Voltage	Cycle	Criteria	Results
Voltage dips	<5%	0.5	B	A
Voltage dips	70%	25	C	C
Voltage Interruption	<5%	250	C	C

AC 230V/50Hz				
Item	Residual Voltage	Cycle	Criteria	Results
Voltage dips	<5%	0.5	B	A
Voltage dips	70%	25	C	A
Voltage Interruption	<5%	250	C	C

AC 240V/50Hz				
Item	Residual Voltage	Cycle	Criteria	Results
Voltage dips	<5%	0.5	B	A
Voltage dips	70%	25	C	A
Voltage Interruption	<5%	250	C	C

6. EUT TEST PHOTO

EN 55032:2015

Radiated emissions up to 1 GHz

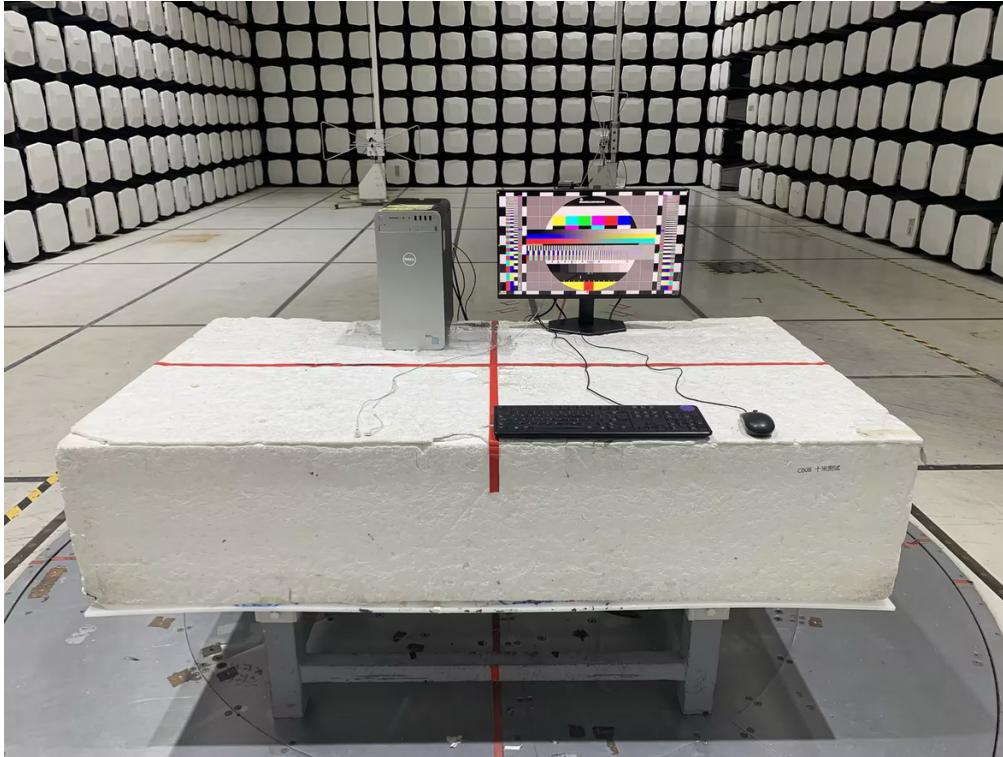

Radiated emissions above 1 GHz

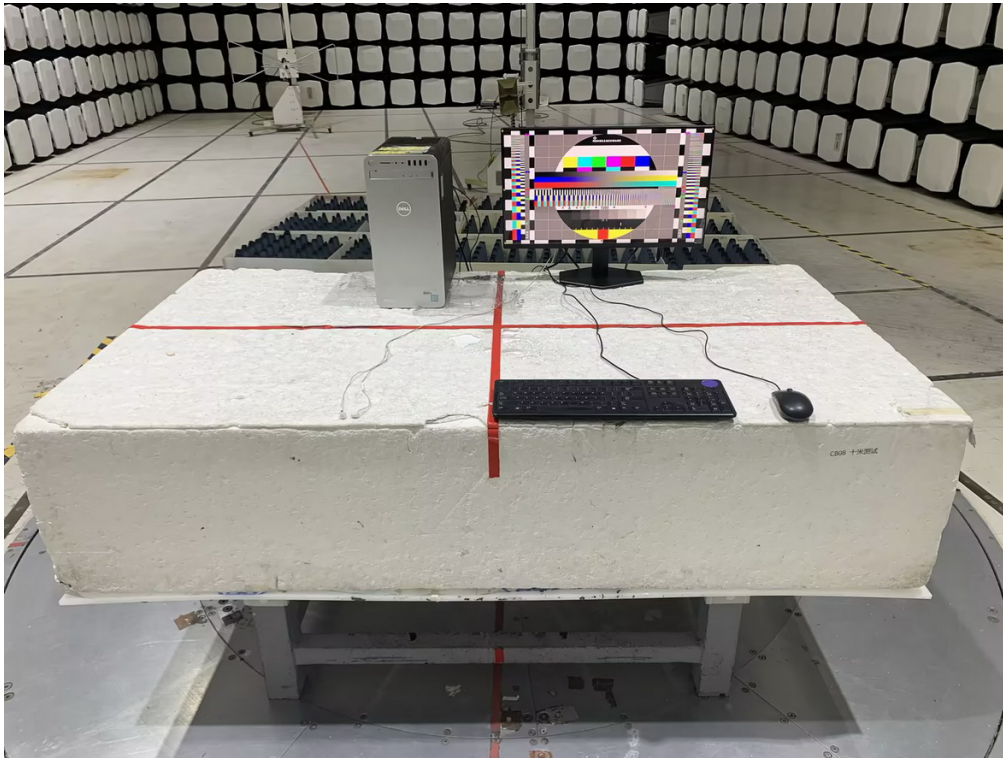

Conducted emissions AC mains power port

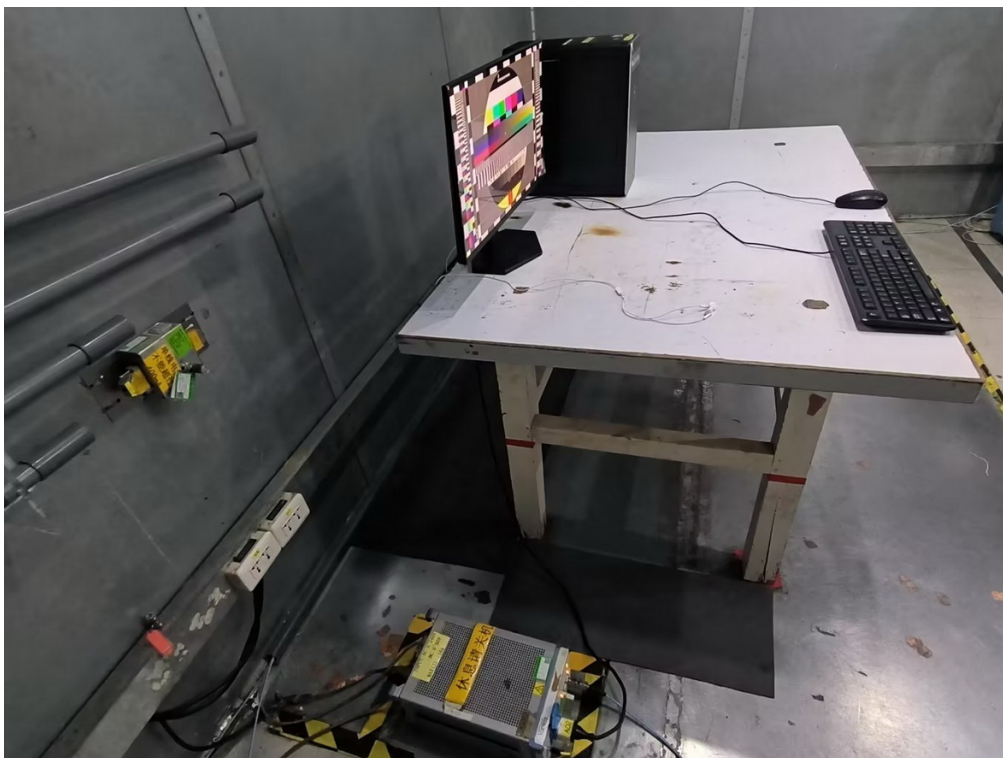

EN 55032:2015+A11:2020

Radiated emissions up to 1 GHz

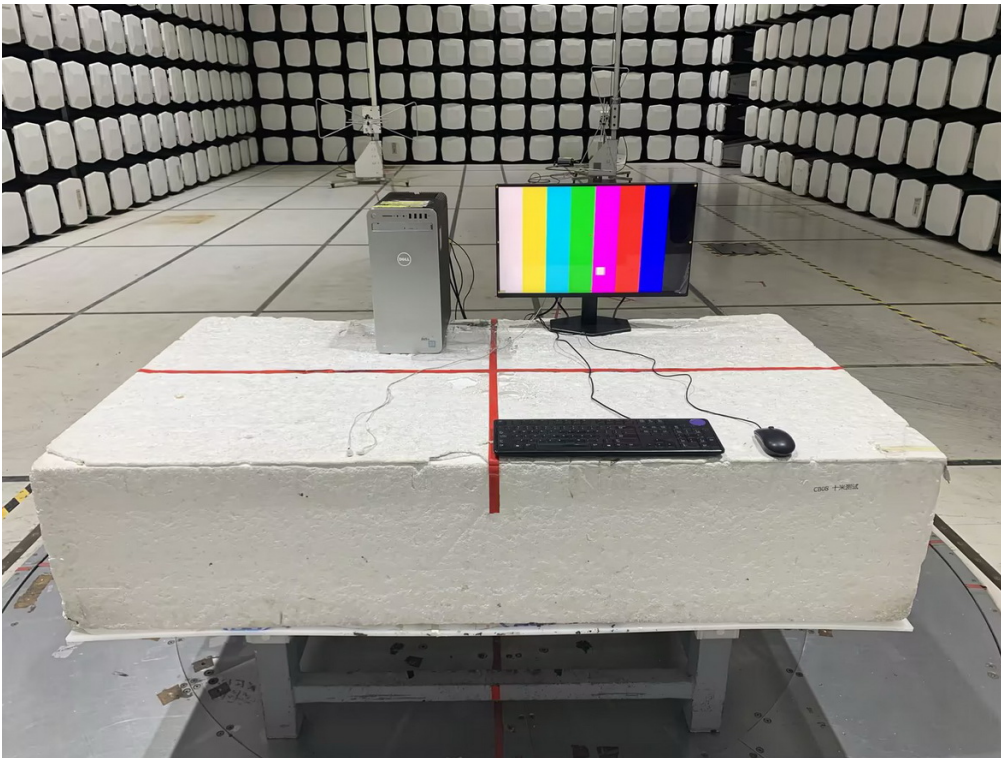

Radiated emissions above 1 GHz

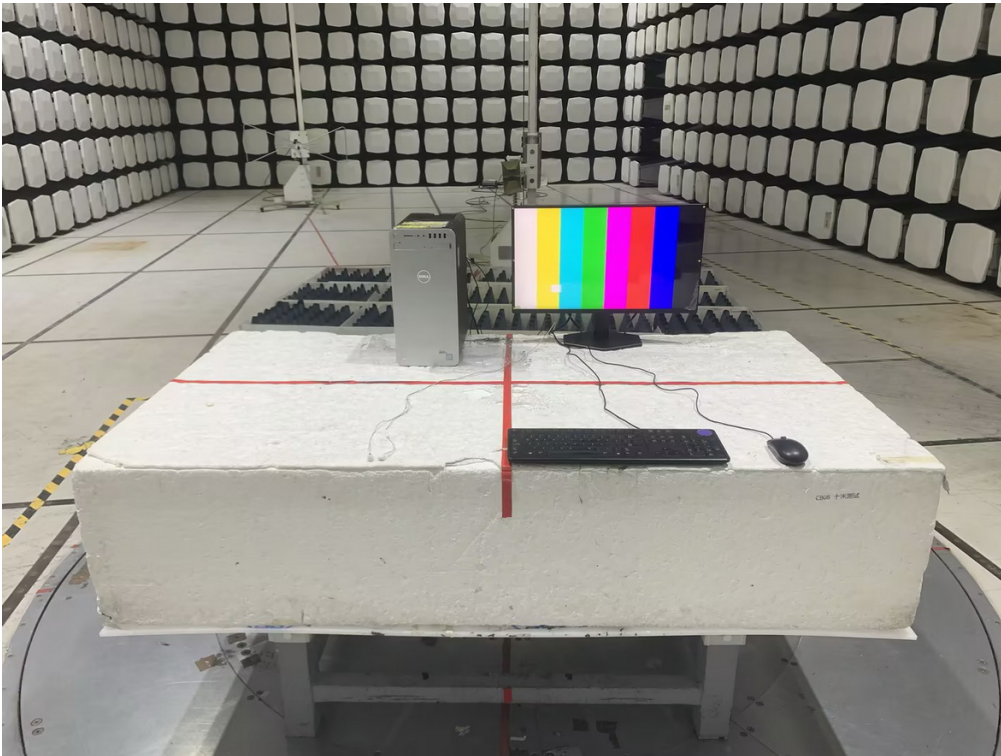

Conducted emissions AC mains power port

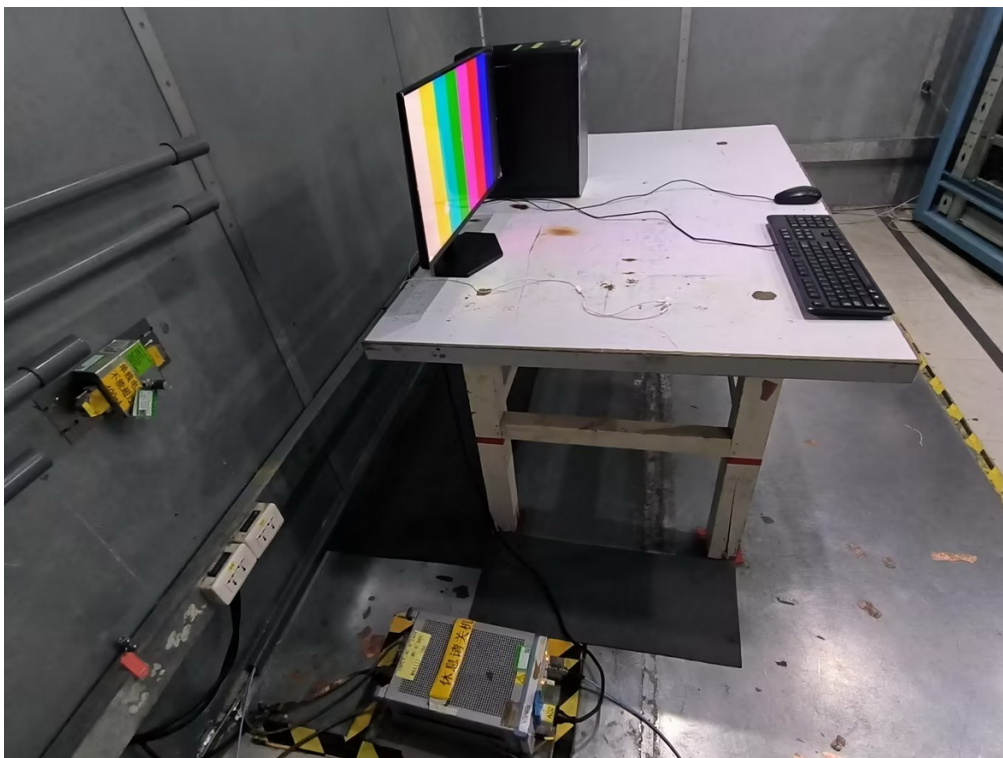

Harmonic current



Voltage fluctuations (Flicker)



Electrostatic discharge immunity



Radiated, radio-frequency, electromagnetic field immunity – Up to 1GHz



Radiated, radio-frequency, electromagnetic field immunity – Above 1GHz



Electrical fast transient/burst immunity - AC



Surge immunity - AC



Immunity to conducted disturbances, induced by radio-frequency fields - AC



Power frequency magnetic field immunity

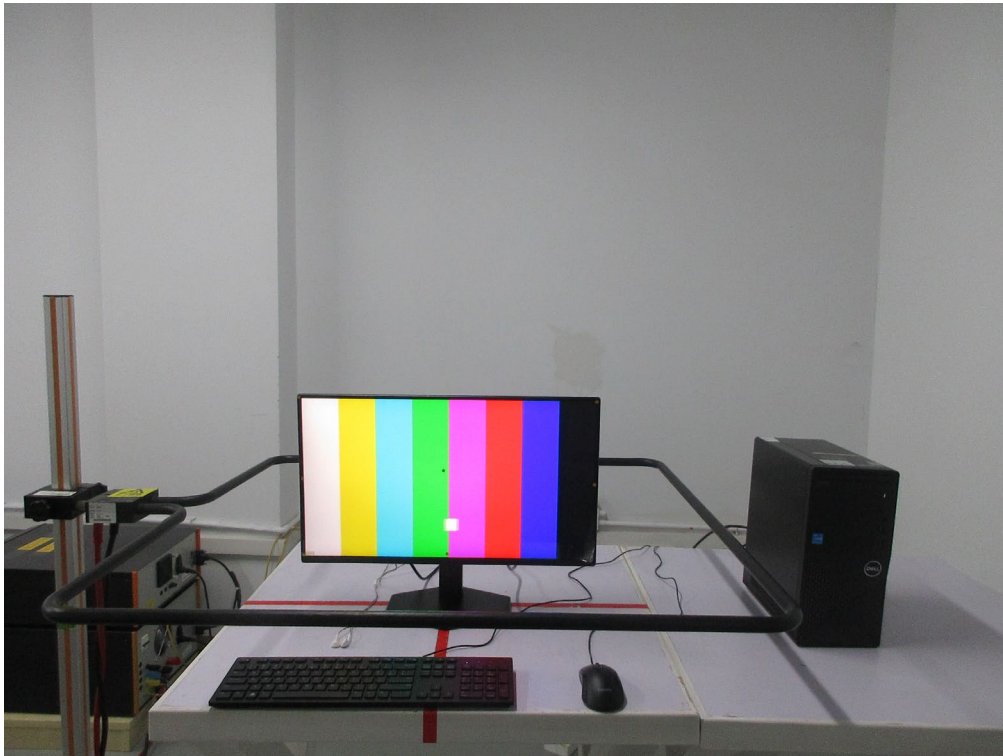

Voltage dips, short interruptions and voltage variations immunity



End of Test Report