



OLED Monitor

User Manual

AG326UD

As an OLED product, this display needs regular screen maintenance to reduce the risk of image retention (burn-in).



Safety	1
Notational Conventions.....	1
Power.....	2
Installation	3
Cleaning	4
Other.....	5
Setup.....	6
Contents in Box.....	6
Setup Stand & Base	7
Adjusting the monitor.....	8
Connecting the Monitor.....	9
Wall Mounting	10
Adaptive-Sync function	11
HDR	12
Adjusting	13
Hotkeys.....	13
OSD Key Guide (Menu)	14
OSD Setting	16
Game Setting	17
Luminance	19
PIP Setting	21
Color Setup.....	22
Audio	23
Light FX	24
OLED Care/Extra	25
OSD Setup	27
LED Indicator.....	28
Troubleshooting	29
Specification	30
General Specification.....	30
Preset Display Modes	32
Pin Assignments	33
Plug and Play.....	34

Safety

Notational Conventions

The following subsections describe notational conventions used in this document.

Notes, Cautions, and Warnings

Throughout this guide, blocks of text may be accompanied by an icon and printed in bold type or in italic type. These blocks are notes, cautions, and warnings, and they are used as follows:



NOTE: A NOTE indicates important information that helps you make better use of your computer system.





CAUTION: A CAUTION indicates either potential damage to hardware or loss of data and tells you how to avoid the problem.



WARNING: A WARNING indicates the potential for bodily harm and tells you how to avoid the problem. Some warnings may appear in alternate formats and may be unaccompanied by an icon. In such cases, the specific presentation of the warning is mandated by regulatory authority.

Power

 The monitor should be operated only from the type of power source indicated on the label. If you are not sure of the type of power supplied to your home, consult your dealer or local power company.

 The monitor is equipped with a three-pronged grounded plug, a plug with a third (grounding) pin. This plug will fit only into a grounded power outlet as a safety feature. If your outlet does not accommodate the three-wire plug, have an electrician install the correct outlet, or use an adapter to ground the appliance safely. Do not defeat the safety purpose of the grounded plug.

 Unplug the unit during a lightning storm or when it will not be used for long periods of time. This will protect the monitor from damage due to power surges.

 Do not overload power strips and extension cords. Overloading can result in fire or electric shock.

 To ensure satisfactory operation, use the monitor only with UL listed computers which have appropriate configured receptacles marked between 100-240V AC, Min. 5A.

 The wall socket shall be installed near the equipment and shall be easily accessible.

Installation

! Do not place the monitor on an unstable cart, stand, tripod, bracket, or table. If the monitor falls, it can injure a person and cause serious damage to this product. Use only a cart, stand, tripod, bracket, or table recommended by the manufacturer or sold with this product. Follow the manufacturer's instructions when installing the product and use mounting accessories recommended by the manufacturer. A product and cart combination should be moved with care.

! Never push any object into the slot on the monitor cabinet. It could damage circuit parts causing a fire or electric shock. Never spill liquids on the monitor.

! Do not place the front of the product on the floor.

! If you mount the monitor on a wall or shelf, use a mounting kit approved by the manufacturer and follow the kit instructions.

! Leave some space around the monitor as shown below. Otherwise, air-circulation may be inadequate hence overheating may cause a fire or damage to the monitor.

! To avoid potential damage, for example the panel peeling from the bezel, ensure that the monitor does not tilt downward by more than -5 degrees. If the -5 degree downward tilt angle maximum is exceeded, the monitor damage will not be covered under warranty.

See below the recommended ventilation areas around the monitor when the monitor is installed -on the stand:

Installed with stand

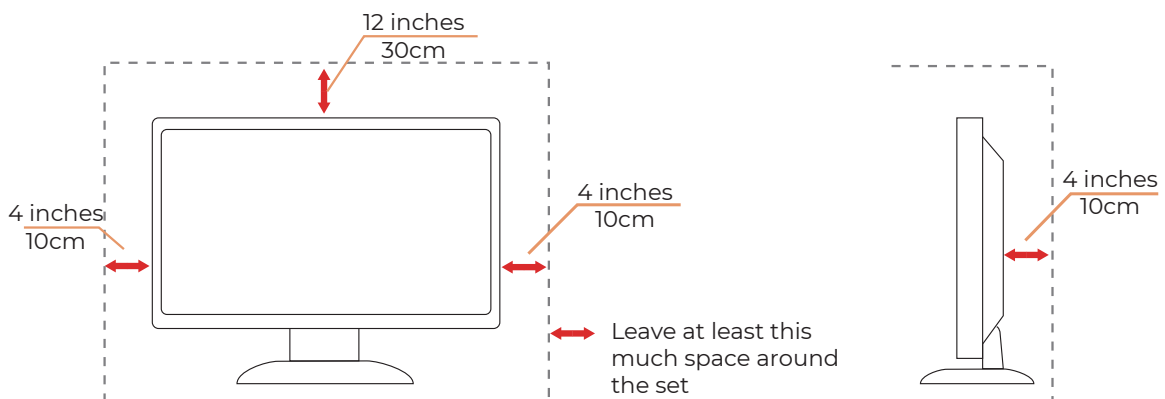

Cleaning

⚠ Clean the cabinet regularly with a water-dampened, soft cloth.

⚠ When cleaning use a soft cotton or microfiber cloth. The cloth should be damp and almost dry, do not allow liquid into the case.



⚠ Please disconnect the power cord before cleaning the product.

Other

 If the product is emitting a strange smell, sound or smoke, disconnect the power plug IMMEDIATELY and contact a Service Center.

 Make sure that the ventilating openings are not blocked by a table or curtain.

 Do not engage the OLED monitor in severe vibration or high impact conditions during operation.

 Do not knock or drop the monitor during operation or transportation.

 It is not recommended to use this OLED product for more than four continuous hours. Possible image retention (burn-in) may occur beyond this usage duration. To reduce the probability of image retention this product uses a number of technologies A maintenance cycle takes about 10 minutes. For details, refer to the "Screen Maintenance" section.

Setup

Contents in Box

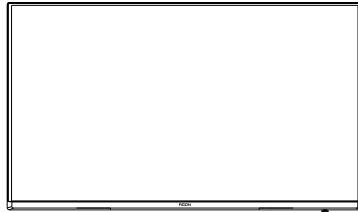

OLED Monitor

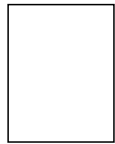

Quick Start Guide

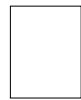

Warranty card



Stand

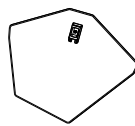

Base

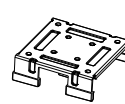

Wall Mount Bracket

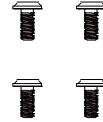

Wall Mount Screws



Stand Screws



Screwdriver



Power Cable



DisplayPort Cable



HDMI Cable



USB Cable

*Not all signal cables will be provided for all countries and regions. Please check with the local dealer or AOC branch office for confirmation.

Setup Stand & Base

Please setup or remove the base following the steps as below.

Setup:

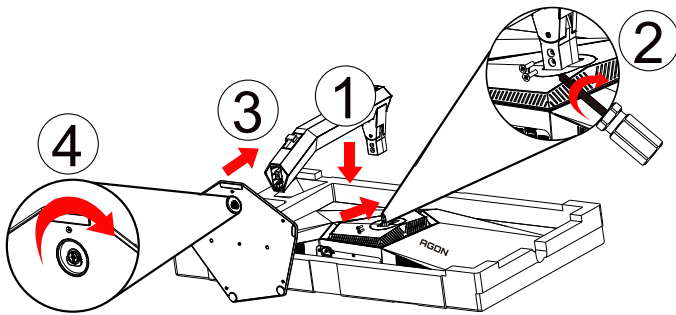

Remove:

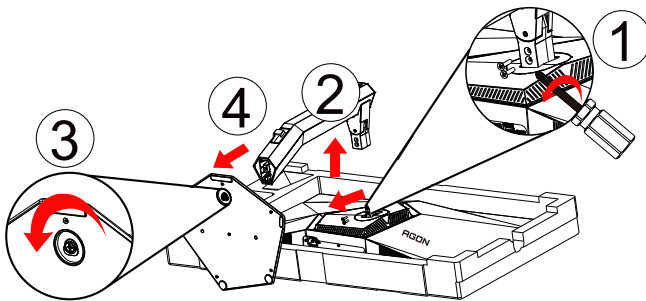

Adjusting the monitor

For optimal viewing it is recommended to look at the full face of the monitor, then adjust the monitor's angle to your own preference.

Hold the stand to steady the monitor, and grasp only the bezel to adjust the monitor's angle.

You are able to adjust the monitor as below:

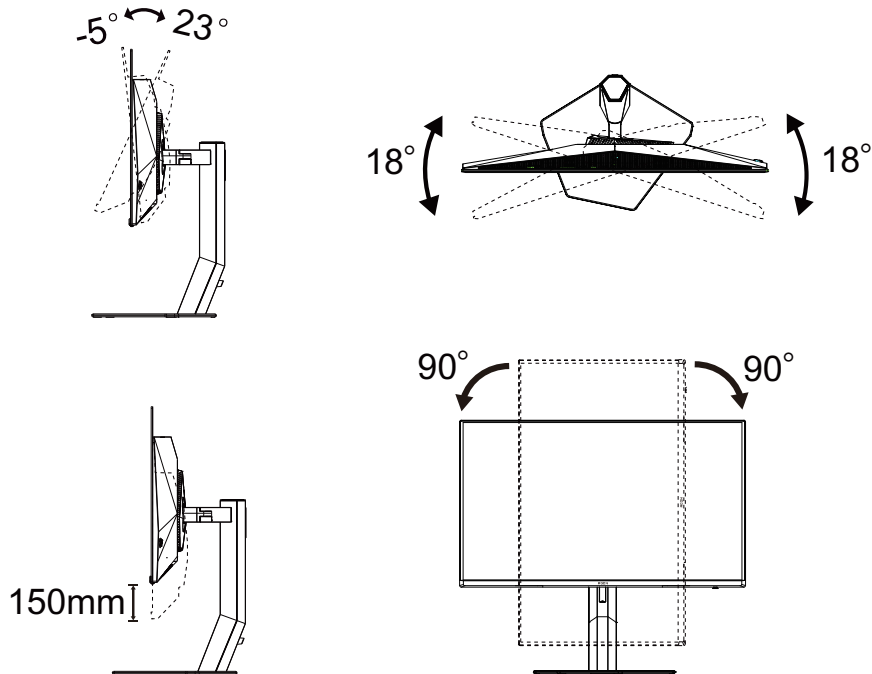

NOTE:

Do not touch the OLED screen when you change the angle. Touching the OLED screen may cause damage.

Warning:

1. To avoid potential screen damage, such as panel peeling, ensure that the monitor does not tilt downward by more than -5 degrees.
2. Do not press the screen while adjusting the angle of the monitor. Grasp only the bezel.

Connecting the Monitor

Cable Connections In Back of Monitor:

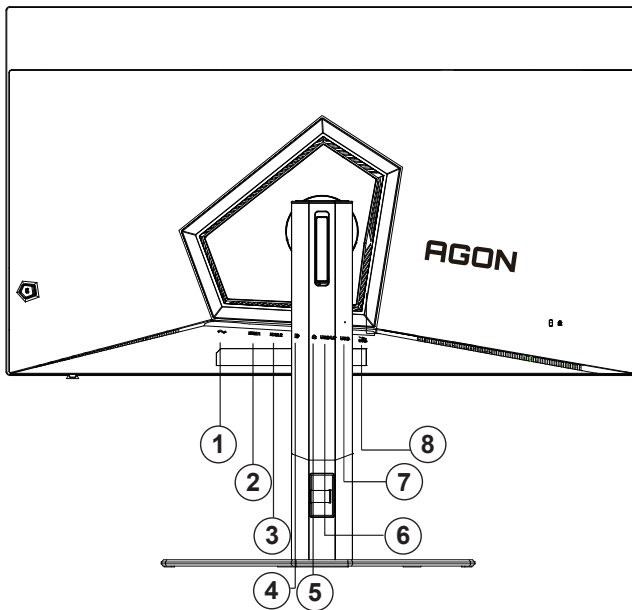

1. Power
2. HDMI1
3. HDMI2
4. DisplayPort
5. Earphone
6. USB3.2 Gen1 upstream
7. USB3.2 Gen1 downstream x2
8. USB3.2 Gen1 downstream + fast charging x1

Connect to PC

1. Connect the power cord to the back of the display firmly.
2. Turn off your computer and unplug its power cable.
3. Connect the display signal cable to the video connector on your computer.
4. Plug the power cord of your computer and your display into a nearby outlet.
5. Turn on your computer and display.

If your monitor displays an image, installation was successful and is complete. If your monitor does not display an image, please refer to the "Troubleshooting" section.

To protect equipment, always turn off the PC and OLED monitor before connecting.

Wall Mounting

Preparing to Install An Optional Wall Mounting Arm.

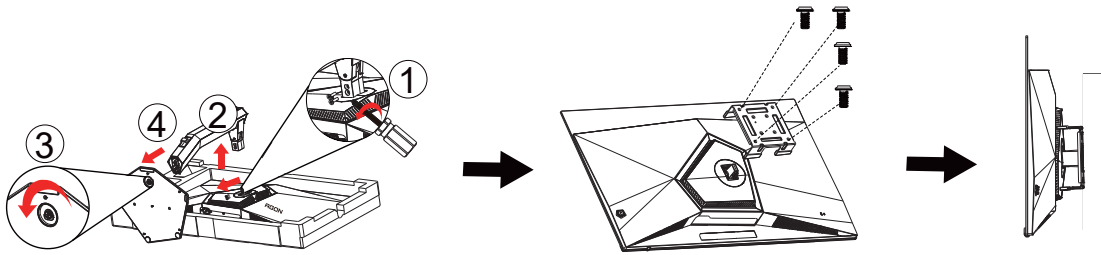

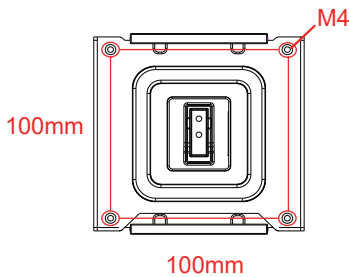

This monitor can be attached to a wall mounting arm you purchase separately. Disconnect power before this procedure. Follow these steps:

1. Remove the base.
2. Follow the manufacturer’s instructions to assemble the wall mounting arm.
3. Place the wall mounting arm onto the back of the monitor. Line up the holes of the arm with the holes in the back of the monitor.
4. Reconnect the cables. Refer to the user’s manual that came with the optional wall mounting arm for instructions on attaching it to the wall.

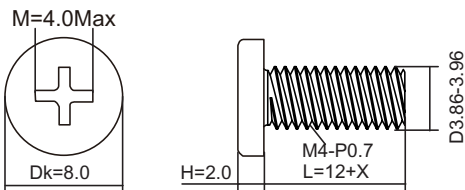

Specification of wall hanger screws: M4*(12+X)mm, (X=Thickness of Wall mount bracket)



 Noted: VESA mounting screw holes are not available for all models, please check with the dealer or official department of AOC.

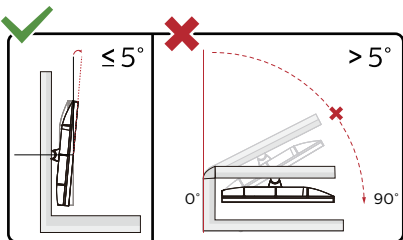

Display design may differ from those illustrated.

Warning:

1. To avoid potential screen damage, such as panel peeling, ensure that the monitor does not tilt downward by more than -5 degrees.
2. Do not press the screen while adjusting the angle of the monitor. Grasp only the bezel.

Adaptive-Sync function

1. Adaptive-Sync function is working with DisplayPort/HDMI
2. Compatible Graphics Card: Recommend list is as the below, also could be checked by visiting www.AMD.com

Graphics Cards

- Radeon™ RX Vega series
- Radeon™ RX 500 series
- Radeon™ RX 400 series
- Radeon™ R9/R7 300 series (R9 370/X, R7 370/X, R7 265 except)
- Radeon™ Pro Duo (2016)
- Radeon™ R9 Nano series
- Radeon™ R9 Fury series
- Radeon™ R9/R7 200 series (R9 270/X, R9 280/X except)

Processors

- AMD Ryzen™ 7 2700U
- AMD Ryzen™ 5 2500U
- AMD Ryzen™ 5 2400G
- AMD Ryzen™ 3 2300U
- AMD Ryzen™ 3 2200G
- AMD PRO A12-9800
- AMD PRO A12-9800E
- AMD PRO A10-9700
- AMD PRO A10-9700E
- AMD PRO A8-9600
- AMD PRO A6-9500
- AMD PRO A6-9500E
- AMD PRO A12-8870
- AMD PRO A12-8870E
- AMD PRO A10-8770
- AMD PRO A10-8770E
- AMD PRO A10-8750B
- AMD PRO A8-8650B
- AMD PRO A6-8570
- AMD PRO A6-8570E
- AMD PRO A4-8350B
- AMD A10-7890K
- AMD A10-7870K
- AMD A10-7850K
- AMD A10-7800
- AMD A10-7700K
- AMD A8-7670K
- AMD A8-7650K
- AMD A8-7600
- AMD A6-7400K

HDR

It is compatible with input signals in HDR10 format.

The display may automatically activate the HDR function if the player and content are compatible. Please contact the device manufacturer and the content provider for information on the compatibility of your device and content. Please select "OFF" for the HDR function when you have no need for automatical activation function.

Note:

1. No special setting is needed for the DisplayPort/HDMI interface in WIN10 versions lower (older) than V1703.
2. Only the HDMI interface is available and the DisplayPort interface cannot function in WIN10 version V1703.
3. Display Setting :
 - a. The display resolution is set to 3840*2160, and HDR is preset to ON.
 - b. After entering an application, the best HDR effect can be achieved when the resolution is changed to 3840*2160 (if available).

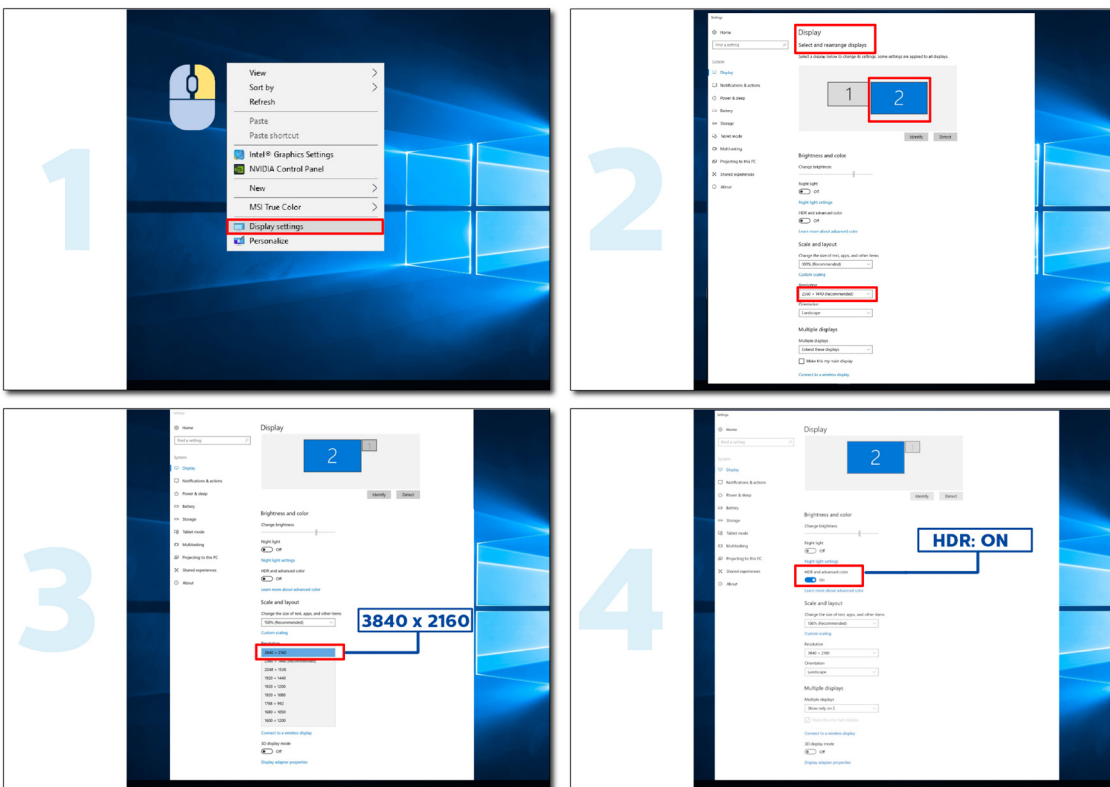

Adjusting

Hotkeys

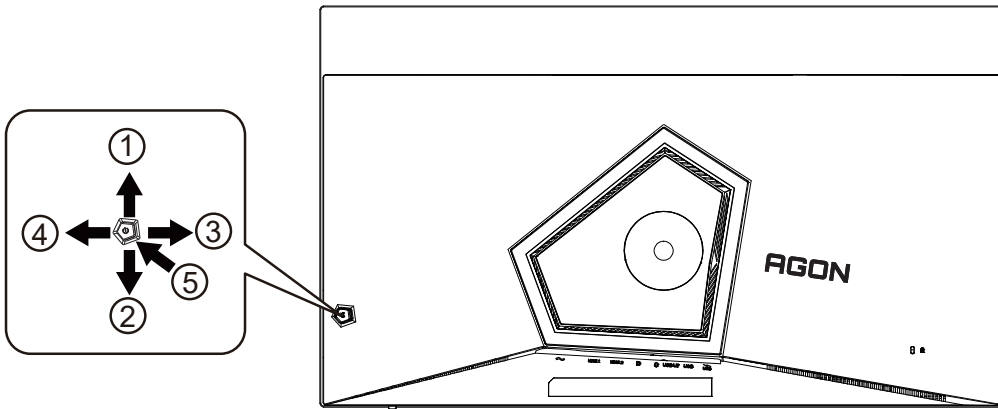

1	Source/Up
2	Dial Point/Down
3	Game Mode/Left
4	Light FX /Right
5	Power/ Menu/Enter

Power/Menu/Enter

Press the Power button to turn on the monitor.

When there is no OSD, Press to display the OSD or confirm the selection. Press about 2 seconds to turn off the monitor.

Dial Point/Down

When there is no OSD, press Dial Point button to show / hide Dial Point.

Game Mode/Left

When there is no OSD, press "Left" key to open game mode function, then press "Left" or "Right" key to select game mode (FPS, RTS, Racing, Gamer 1, Gamer 2 or Gamer 3) basing on the different game types.

Light FX/Right

When there is no OSD, press "Right" key to active Light FX function.

Source/Up

When the OSD is closed, press Source/Auto/Up button will be Source hot key function.

OSD Key Guide (Menu)



Enter : Use Enter key to enter the next OSD level

Move : Use Left / Up / Down key to move OSD selection

Exit : Use Right key to exit OSD

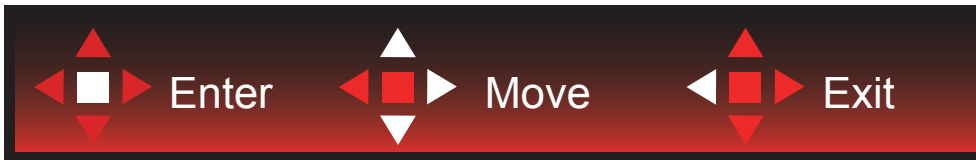

Enter : Use Enter key to enter the next OSD level

Move : Use Right / Up / Down key to move OSD selection

Exit : Use Left key to exit OSD

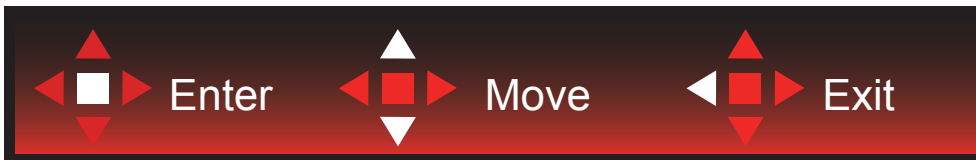

Enter : Use Enter key to enter the next OSD level

Move : Use Up / Down key to move OSD selection

Exit : Use Left key to exit OSD

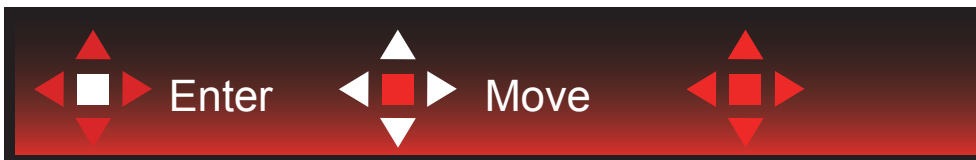

Move : Use Left / Right / Up / Down Key to move OSD selection



Exit : Use Left key to exit OSD to previous OSD level

Enter : Use Right key to enter next OSD level

Select : Use Up / Down key to move OSD selection



Enter : Use Enter key to apply the OSD setting and back to previous OSD level

Select : Use Down key to adjust OSD setting



Select : Use Up / Down key to adjust OSD setting



Enter : Use Enter key to exit OSD to previous OSD level

Select : Use Left / Right key to adjust OSD setting

OSD Setting

Basic and simple instruction on the control keys.

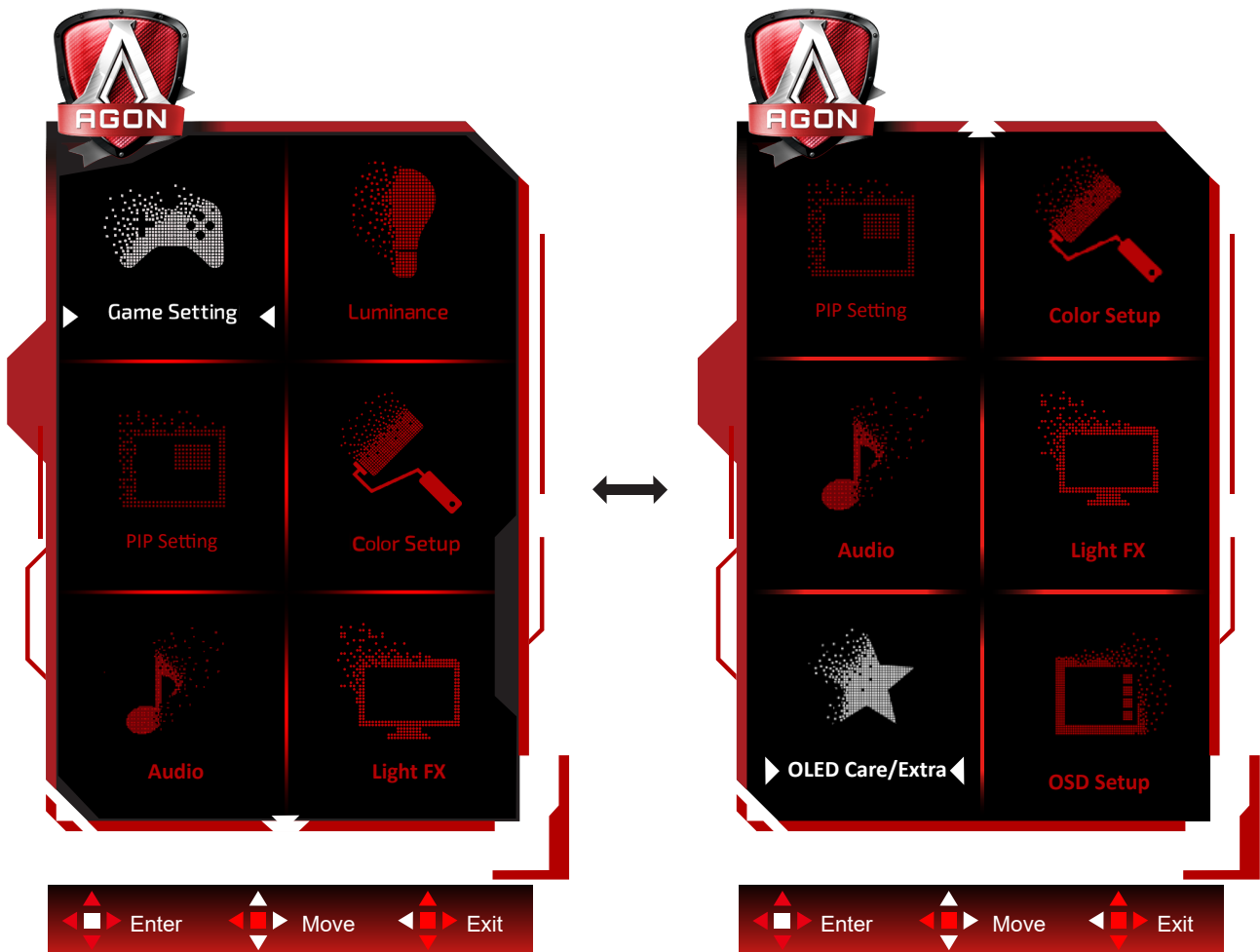

- 1). Press the MENU-button to activate the OSD window.
- 2). Follow Key Guide to move or select (adjust) OSD settings
- 3). OSD Lock/Unlock Function: To lock or unlock the OSD, press and hold the Down-button for 10s while OSD function is not active.

Notes: If the product has only one signal input, the item of "Input Select" is disable to adjust.

Game Setting

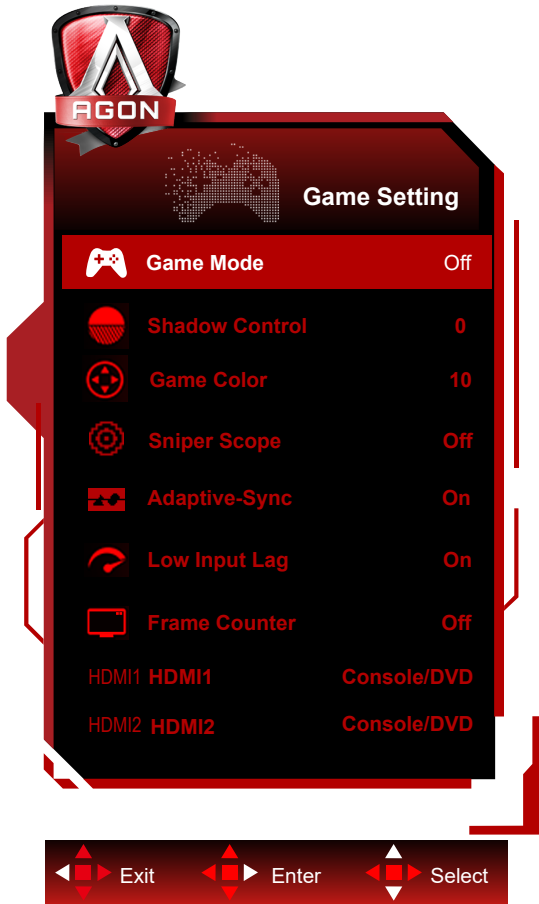

	Game Mode	Off	No optimization by Game Mode.
		FPS	For playing FPS (First Person Shooters) games. Improves dark theme black level details.
		RTS	For playing RTS (Real Time Strategy). Improves the image quality.
		Racing	For playing Racing games, Provides fastest response time and high color saturation.
		Gamer 1	User's preference settings saved as Gamer 1.
		Gamer 2	User's preference settings saved as Gamer 2.
		Gamer 3	User's preference settings saved as Gamer 3.
	Shadow Control	0-20	Shadow Control Default is 0, then end-user can adjust from 0 to 20 increase for a clearer picture. If picture is too dark to be saw the detail clearly, adjusting from 0 to 20 for a clear picture.
	Game Color	0-20	Game Color will provide 0-20 level for adjusting saturation to get better picture.
	Sniper Scope	Off /1.0 /1.5 /2.0	Zoom in locally to make it easier to target when shooting.
Adaptive-Sync	On / Off	Disable or Enable Adaptive-Sync. Adaptive-Sync Run Reminder: When the Adaptive-Sync feature is enabled, there may be flashing in some game environments.	

	Low Input lag	On / Off	Shutting down the frame buffer can reduce input delay. Note: Low Input lag at UHD 120Hz/165Hz resolution, and PIP/PBP , Sniper Scope turn off can be adjusted . It is enabled by default in the Adaptive-Sync state and cannot be adjusted.
	Frame Counter	Off / Right-Up / Right-Down / Left-Down / Left-Up	Display V frequency on the corner selected (Frame counter feature only works with AMD graphic card.)
	HDMI1	Console/DVD / PC	Select the type of device connected. When using HDMI1 to connect the game console or DVD player, set HDMI1 to the game console/DVD.
	HDMI2	Console/DVD / PC	Select the type of device connected. When using HDMI2 to connect the game console or DVD player, set HDMI2 to the game console/DVD.

Note:

- 1) When the "HDR Mode" under "Luminance" is set to "non-off", "Shadow Control" and "Game Color" is not adjustable.
- 2) When the "HDR" under "Luminance" is set to "non-off", "Game Mode", "Shadow Control" and "Game Color" is not adjustable.
- 2) When the "Color Gamut" under "Color Setup" is set to "sRGB" or "DCI-P3", "Shadow Control" and "Game Color" is not adjustable.

Luminance

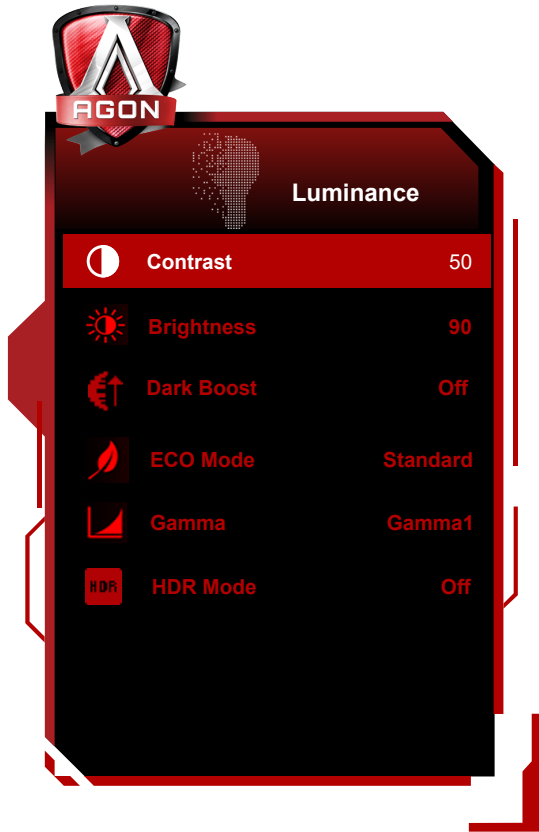

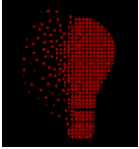
	Contrast	0-100	Contrast from Digital-register.
	Brightness	0-100	Backlight Adjustment
	Dark Boost	Off	Enhance the screen details in the dark or bright area to adjust the brightness in the bright area and ensure that it is not oversaturated.
		Level 1	
		Level 2	
		Level 3	
	ECO Mode	Standard	Standard Mode
		Text	Text Mode
		Internet	Internet Mode
		Game	Game Mode
		Movie	Movie Mode
		Sports	Sports Mode
		Reading	Reading Mode
	Gamma	Gamma1	Adjust to Gamma 1
		Gamma2	Adjust to Gamma 2
Gamma3		Adjust to Gamma 3	
HDR	Off	Set the HDR profile according to your usage requirements. Note: When HDR is detected, the HDR option is displayed for adjustment.	
	DisplayHDR		
	HDR Peak		
	HDR Picture		
	HDR Game		

	HDR Mode	Off	Optimized for the color and contrast of the picture, which will simulate showing the HDR effect. Note: When HDR is not detected, the HDR Mode option is displayed for adjustment.
		HDR Picture	
		HDR Movie	
		HDR Game	

Note:

- 1). When "HDR Mode" is set to "non-off", "Contrast", "ECO Mode", "Gamma" items cannot be adjusted.
- 2). When "HDR" is set to "non-off", all the items under "Luminance" cannot be adjusted.
- 3). When the "Color Gamut" under "Color Setup" is set to "sRGB" or "DCI-P3", "Contrast", "Dark Boost", "ECO Mode", "Gamma", "HDR"/"HDR Mode" items cannot be adjusted.

PIP Setting

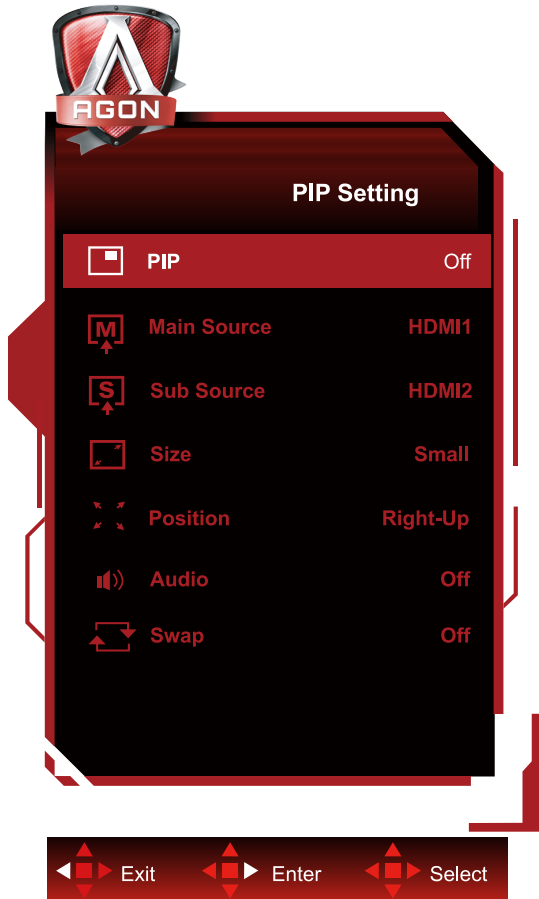

	PIP Setting	Off / PIP / PBP	Disable or Enable PIP or PBP.
	Main Source		Select main screen source.
	Sub Source		Select sub screen source.
	Size	Small / Middle / Large	Select screen size.
	Position	Right-up	Set the screen location.
		Right-down	
		Left-up	
		Left-down	
Audio	On: PIP Audio	Disable or Enable Audio Setup.	
	Off: Main Audio		
Swap	On: Swap	Swap the screen source.	
	Off: non action		

Note:

- 1) When "HDR" under "Luminance" is set to the non-off state, all items under "PIP Settings" cannot be adjusted.
- 2) When PIP/PBP is enabled, some color-related adjustments in the OSD menu are valid only for the main screen, while the sub-screen is not supported. Hence, the main screen and the sub-screen may have different colors.
- 3) Set the input signal resolution to 1920X2160@60Hz at PBP to achieve the desired display effect.
- 4) When PBP/PIP is enabled, the compatibility of the main screen/sub-screen input source is shown in the following table:

PBP/PIP		Main source		
		HDMI1	HDMI2	DP
Sub source	HDMI1	V	V	V
	HDMI2	V	V	V
	DP	V	V	V

Color Setup

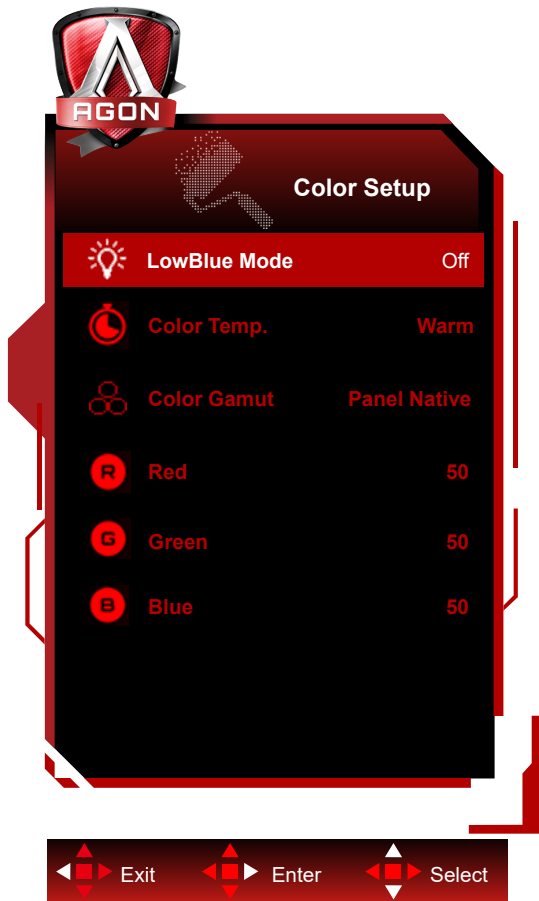

	LowBlue Mode	Off / Multimedia / Internet / Office / Reading	Decrease blue light wave by controlling color temperature.
	Color Temp.	Warm	Recall Warm Color Temperature from EEPROM.
		Normal	Recall Normal Color Temperature from EEPROM.
		Cool	Recall Cool Color Temperature from EEPROM.
		User	Restore user color temperature from EEPROM.
	Color Gamut	Panel Native	Standard color space panel.
		sRGB	sRGB Color space.
		DCI-P3	DCI-P3 color space.
Red	0-100	Red gain from Digital-register.	
Green	0-100	Green gain from Digital-register.	
Blue	0-100	Blue gain from Digital-register.	

Note:

- 1). When "HDR Mode"/"HDR" under "Luminance" is set to "non-off" , all the items under "Color Setup" cannot be adjusted.
- 2). When the "Color Gamut" is set to "sRGB" or "DCI-P3" ,all the items under "Color Setup" cannot be adjusted.

Audio

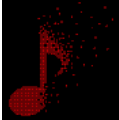

	Volume	0-100	Adjust volume setting
---	--------	-------	-----------------------

Light FX

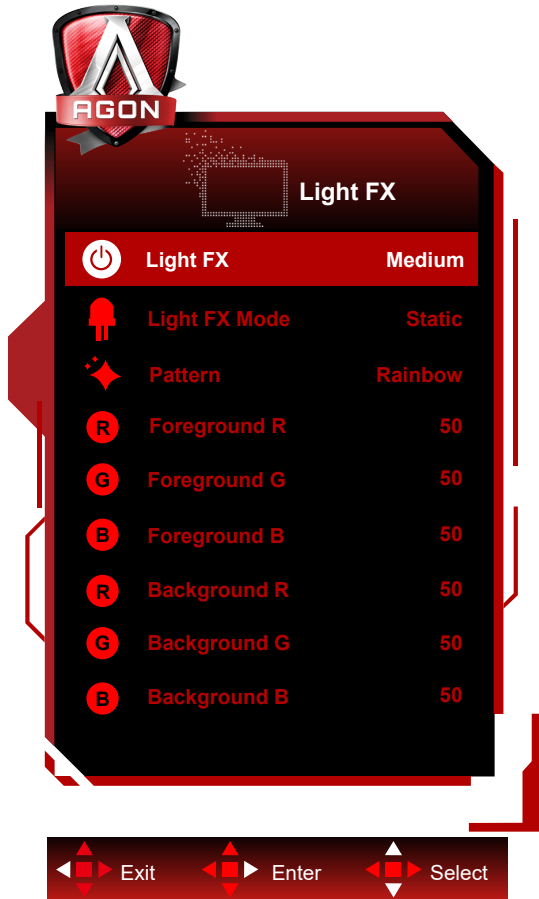

	Light FX	Off / Low / Medium / Strong	Select the intensity of Light FX.
	Light FX Mode	Audio1 / Audio2 / Static / Dark Point Sweep / Gradient Shift / Spread Fill / Drip Fill / Spreading Drip Fill / Breathing / Light Point Sweep / Zoom / Rainbow / Wave / Flashing / Demo	Select Light FX Mode
	Pattern	Red / Green / Blue / Rainbow / User Define	Select Light FX Pattern
	Foreground R	0-100	User can adjust Light FX foreground color, when Pattern setting to user define
	Foreground G		
	Foreground B		
	Background R	0-100	User can adjust Light FX background color, when Pattern setting to user define
	Background G		
Background B			

OLED Care/Extra



	Pixel Orbiting	Off / Weak / Medium / Strong	Orbit will slightly shift the displayed image at the pixel level, once a second to prevent image retention. This function is "On (Weak)" by default, "Weak" moves the least, "Strong" moves the most, "Off" disables the movement and increases the chance of image retention. This can be set in the OSD menu.
	Auto Warning	On/ Off	Enable/Disable the "Pixel Refresh" Auto Warning feature. The monitor will automatically display an "Auto Warning" every 4 hours of cumulative usage to remind the user to run the "Pixel Refresh" process. Select "Off" to stop the Auto Warning for "Pixel Refresh." However, if the recommended time for running the "Pixel Refresh" is not followed, it may increase the risk of image retention on the screen. Please proceed with caution.
	Pixel Refresh	On/ Off	This function will help eliminate image retention. After startup, select "Yes" from the menu prompt. The display will shutdown the screen and run the maintenance cycle. The power indicator will flash white (1 second on/1 second off) while the cycle runs, about 10 minutes. At the end of the cycle the power indicator will turn off and the display will be in standby state.

Screen Saver	Off / Slow / Fast	When a static image is detected for a certain period of time, the screen saver function will dim the screen to protect the panel from sticking. When a moving image is detected, the monitor will recover luminance to previous working status. Default setting is Slow and may change as Fast to active Screen Saver sooner. Would highly recommend that you always turn on Screen Saver as Slow or Fast to protect the screen. It is also recommended that you also set your device to use a screen saver.
Logos Protection	Off / 1 / 2	When there are multiple static logos detected on the screen, it's suggested to turn on logos Protection; which will dim the screen to protect the panel from image sticking where logos are detected.
Boundary Dimmer	Off / 1 / 2 / 3	For special aspect ratios that have a black area in the frame of the screen or a split-screen, the boundary dimmer feature can automatically detect and dim the brightness of specific areas with a large difference in brightness levels.
Taskbar Dimmer	Off / 1 / 2 / 3	The Taskbar Dimmer technology will dim the brightness of the taskbar area on the screen. No brightness changes will be noticeable in the areas other than in the taskbar.
ThermalProtection	Off / On	When the temperature of the monitor is over 60 degrees Celsius, the Thermal Protection feature will automatically dim the brightness of the screen in order to ensure heat dissipation properly. It is recommended that you turn on the feature for the monitor.
Input Select	Auto/ HDMI1 / HDMI2 / DP	Select Input Signal Source
Off Timer	0-24hrs	Select DC off time
Image Ratio	Wide /Aspect / 4:3 / 1:1 / 17"(4:3) / 19"(4:3) / 19"(5:4) / 19"W(16:10) / 21.5"W(16:9) / 22"W(16:10) / 23"W(16:9) / 23.6"W(16:9) / 24"W(16:9) / 27"W(16:9) / 30"W (21:9)	Select image ratio for display.
DDC/CI	Yes or No	Turn On/Off DDC/CI Support
Reset	Yes or No	Reset the menu to default
Time after Pixel Refresh		It refers to the time that the screen lights up after the last Pixel Refresh operation is executed, in units of hours. A prompt of executing Pixel Refresh will be automatically sent to the user every four hours.
Pixel Refresh Counts		It is used to record the number of times of executing Pixel Refresh.

OSD Setup

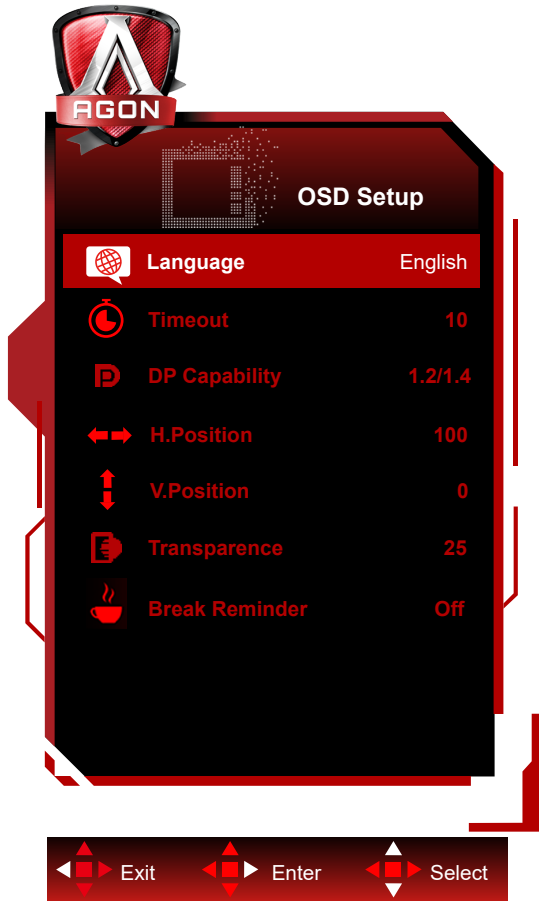

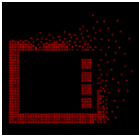
	Language		Select the OSD language
	Timeout	5-120	Adjust the OSD Timeout
	DP Capability	1.1 / 1.2 / 1.4	Note: Only DP1.2/DP1.4 support Adaptive-Sync functionality.
	H. Position	0-100	Adjust the horizontal position of OSD
	V. Position	0-100	Adjust the vertical position of OSD
	Transparence	0-100	Adjust the transparence of OSD
	Break Reminder	On / Off	Enable a reminder for the user to take a break every hour of continuous activity, to prevent repetitive stress injury.

LED Indicator

Status	LED Color
Full Power Mode	White
Active-off Mode	Orange
Pixel Refresh under process	Flashing White (1 second on / 1 second off)
OLED panel malfunction	Flashing Orange (1 second on / 1 second off)
Shutdown mode	The indicator is not lit.

Troubleshooting

Problems	Possible solutions
The power indicator is not lit.	<ul style="list-style-type: none"> • Check if the power is turned on. • Check if the power cord is connected. • Check if the computer power is turned on.
The power indicator is lit, but there is no image display.	<ul style="list-style-type: none"> • Check if the graphics card of the computer is well plugged. • Check that the signal wire of the display has been correctly connected to the computer. • Check the plug of the signal wire of the display, and make sure all pins are not bent. • Observe the indicator through the Caps Lock key on the keypad of the computer to confirm if the computer is working.
There is no image, but the power indicator flashes orange.	<ul style="list-style-type: none"> • The OLED panel malfunctions and fails to work properly. Seek advice from AOC after-sales service persons.
Failure to realize plug-to-use.	<ul style="list-style-type: none"> • Check if it supports plug-to-use. • Check if the adapter supports plug-to-use.
Dim image.	<ul style="list-style-type: none"> • Adjust luminance and contrast ratio.
The image is bouncing or rippled.	<ul style="list-style-type: none"> • There may be electrical appliances and devices at the periphery that may cause electronic interference.
The screen displays "the signal wire is not available" or "no signal."	<ul style="list-style-type: none"> • Check if the signal wire is correctly connected. • Check if the pin of the signal wire plug is damaged. • The Pixel Refresh function can be enabled and run in the display menu to eliminate image retention which has been generated. Running this function for several times can obtain a desirable image display effect. For other instructions regarding screen maintenance, refer to the User Instructions in the official website.
The screen displays "invalid input".	<ul style="list-style-type: none"> • Check if your computer is set in an improper display mode Please re-set your computer in the display mode listed in the detailed user instructions.
Image retention.	<ul style="list-style-type: none"> • Based on the characteristics of the OLED panel, the Pixel Refresh function can be enabled and run in the display menu to eliminate image retention which has been generated. It is recommended to run this function for several times to obtain a desirable image display effect. For other instructions regarding screen maintenance, please refer to the User Instructions in the official website.
Regulation & Service	Please refer to Regulation & Service Information which is in the CD manual or www.aoc.com (to find the model you purchase in your country and to find Regulation & Service Information in Support page.

Specification

General Specification

Panel	Model Name	AG326UD		
	Driving System	OLED		
	Viewable Image Size	80.3 cm Diagonal		
	Pixel Pitch	0.1814mm(H) x 0.1814mm(V)		
	Display Color	1.07B Colors ^[1]		
Others	Horizontal Scan Range	30k-370kHz		
	Horizontal scan Size(Maximum)	699.48 mm		
	Vertical Scan Range	48-165Hz		
	Vertical Scan Size(Maximum)	394.73 mm		
	Optimal Preset Resolution	3840 x 2160@60Hz		
	Max Resolution	3840 x 2160@165Hz ^[2]		
	Plug & Play	VESA DDC2B/CI		
	Connector	HDMI2/DisplayPort/USBx3/USB upstream/Earphone		
	Power Source	100-240V~ 50/60Hz 2.5A		
	Power Consumption	Typical(Default Brightness And Contrast)	123 W	
Max. (Brightness = 100, Contrast =100)		≤182 W		
Standby Mode		≤ 0.5 W		
Environmental	Temperature	Operating	0°C~ 40°C	
		Non-Operating	-25°C~ 55°C	
	Humidity	Operating	10% ~ 85% (Non-Condensing)	
		Non-Operating	5% ~ 93% (Non-Condensing)	
	Altitude	Operating	0m~ 5000m (0ft~ 16404ft)	
		Non-Operating	0m~ 12192m (0ft~ 40000ft)	

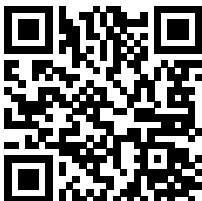

[1]:The maximum number of display colors supported by this product is 1.07 billion, and the setting conditions are as follows (there may be differences due to the output limitation of some graphics cards):

Signal Version Color Format State Color Bit	HDMI2.1		DisplayPort1.4	
	YCbCr422 YCbCr420	YCbCr444 RGB	YCbCr422 YCbCr420	YCbCr444 RGB
3840x2160 165Hz 10bpc	OK	OK	OK	OK
3840x2160 165Hz 8bpc	OK	OK	OK	OK
3840x2160 160Hz 10bpc	OK	OK	OK	OK
3840x2160 160Hz 8bpc	OK	OK	OK	OK
3840x2160 144Hz 10bpc	OK	OK	OK	OK
3840x2160 144Hz 8bpc	OK	OK	OK	OK
3840x2160 120Hz 10bpc	OK	OK	OK	OK
3840x2160 120Hz 8bpc	OK	OK	OK	OK
3840x2160 60Hz 10bpc	OK	OK	OK	OK
3840x2160 60Hz 8bpc	OK	OK	OK	OK
Low resolution 10bpc	OK	OK	OK	OK
Low resolution 8bpc	OK	OK	OK	OK

Note: NVIDIA® graphics cards are recommended to use DisplayPort interface, AMD® graphics cards can use HDMI or DisplayPort interface.

[2]: DisplayPort1.4 signal input, in order to reach UHD 120Hz/160Hz/165Hz, you must use a DSC-enabled video card. Consult your graphics card manufacturer for DSC support.

Preset Display Modes

STANDARD	RESOLUTION (±1Hz)	HORIZONTAL FREQUENCY(kHz)	VERTICAL FREQUENCY(Hz)
VGA	640×480@60Hz	31.469	59.940
	640×480@72Hz	37.861	72.809
	640×480@75Hz	37.500	75.000
	640×480@100Hz	51.080	99.769
	640×480@120Hz	60.938	119.720
SVGA	800×600@56Hz	35.156	56.250
	800×600@60Hz	37.879	60.317
	800×600@72Hz	48.077	72.188
	800×600@75Hz	46.875	75.000
	800×600@100Hz	62.760	99.778
	800×600@120Hz	76.302	119.972
XGA	1024×768@60Hz	48.363	60.004
	1024×768@70Hz	56.476	70.069
	1024×768@75Hz	60.023	75.029
SXGA	1280×1024@60Hz	63.981	60.020
	1280×1024@75Hz	79.976	75.025
FHD	1920×1080@60Hz	67.500	60.000
	1920×1080@100Hz	112.500	100.000
	1920×1080@120Hz	137.260	119.982
QHD	2560×1440@60Hz	96.180	60.000
	2560×1440@120Hz	183	120
	2560×1440@144Hz	222.194	144.01
PBP	1280×1440@60Hz	89.450	59.913
	1280×1440@75Hz	111.972	74.998
UHD	3840×2160@60Hz	141.12	60
	3840×2160 @100Hz	222.202	100.001
	3840×2160 @120Hz	282.25	120.005
	3840×2160 @144Hz	338.69	144
	3840×2160 @160Hz	351.362	160.001
	3840×2160 @165Hz	388.08	165
IBM MODES			
DOS	720×400@70Hz	31.469	70.087
MAC MODES			
VGA	640×480@67Hz	35.000	66.667
SVGA	832×624@75Hz	49.725	74.551

Note: According to the VESA standard, different operating systems and graphics cards may have certain errors (+/-1Hz) on resolution. Actual please refer to the actual product.

Pin Assignments



19-Pin Color Display Signal Cable

Pin No.	Signal Name	Pin No.	Signal Name	Pin No.	Signal Name
1.	TMDS Data 2+	9.	TMDS Data 0-	17.	DDC/CEC Ground
2.	TMDS Data 2 Shield	10.	TMDS Clock +	18.	+5V Power
3.	TMDS Data 2-	11.	TMDS Clock Shield	19.	Hot Plug Detect
4.	TMDS Data 1+	12.	TMDS Clock-		
5.	TMDS Data 1Shield	13.	CEC		
6.	TMDS Data 1-	14.	Reserved (N.C. on device)		
7.	TMDS Data 0+	15.	SCL		
8.	TMDS Data 0 Shield	16.	SDA		

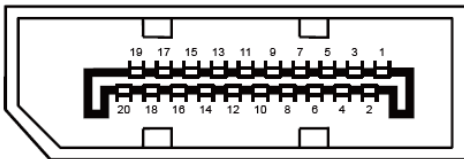

20-Pin Color Display Signal Cable

Pin No.	Signal Name	Pin No.	Signal Name
1	ML_Lane 3 (n)	11	GND
2	GND	12	ML_Lane 0 (p)
3	ML_Lane 3 (p)	13	CONFIG1
4	ML_Lane 2 (n)	14	CONFIG2
5	GND	15	AUX_CH(p)
6	ML_Lane 2 (p)	16	GND
7	ML_Lane 1 (n)	17	AUX_CH(n)
8	GND	18	Hot Plug Detect
9	ML_Lane 1 (p)	19	Return DP_PWR
10	ML_Lane 0 (n)	20	DP_PWR

Plug and Play

Plug & Play DDC2B Feature

This monitor is equipped with VESA DDC2B capabilities according to the VESA DDC STANDARD. It allows the monitor to inform the host system of its identity and, depending on the level of DDC used, communicate additional information about its display capabilities.

The DDC2B is a bi-directional data channel based on the I2C protocol. The host can request EDID information over the DDC2B channel.