

PORSCHE DESIGN



AGON
BY AOC

User Manual

PD34

www.aoc.com

©2024 AOC. All rights reserved

Safety	1
National Conventions	1
Power	2
Installation	3
Cleaning	4
Other	5
Setup	6
Contents in Box	6
Setup Stand & Base	7
Screen Maintenance	8
Adjusting the monitor	9
Connecting the Monitor	10
Wall Mounting	11
Adaptive-Sync function	13
HDR	14
KVM function	15
Adjusting	16
Hotkeys	16
OSD Setting	17
Game Setting	18
Luminance	19
Image Setup	20
Color Setup	22
Audio	23
Light FX	24
OLED Care/Extra	25
OSD Setup	27
LED Indicator	28
Troubleshoot	29
Specification	30
General Specification	30
Preset Display Modes	32
Pin Assignments	33
Plug and Play	34

Safety

National Conventions

The following subsections describe notational conventions used in this document.

Notes, Cautions, and Warnings

Throughout this guide, blocks of text may be accompanied by an icon and printed in bold type or in italic type. These blocks are notes, cautions, and warnings, and they are used as follows:



NOTE: A NOTE indicates important information that helps you make better use of your computer system.





CAUTION: A CAUTION indicates either potential damage to hardware or loss of data and tells you how to avoid the problem.



WARNING: A WARNING indicates the potential for bodily harm and tells you how to avoid the problem. Some warnings may appear in alternate formats and may be unaccompanied by an icon. In such cases, the specific presentation of the warning is mandated by regulatory authority.

Power

 The monitor should be operated only from the type of power source indicated on the label. If you are not sure of the type of power supplied to your home, consult your dealer or local power company.

 The monitor is equipped with a three-pronged grounded plug, a plug with a third (grounding) pin. This plug will fit only into a grounded power outlet as a safety feature. If your outlet does not accommodate the three-wire plug, have an electrician install the correct outlet, or use an adapter to ground the appliance safely. Do not defeat the safety purpose of the grounded plug.

 Unplug the unit during a lightning storm or when it will not be used for long periods of time. This will protect the monitor from damage due to power surges.

 Do not overload power strips and extension cords. Overloading can result in fire or electric shock.

 To ensure satisfactory operation, use the monitor only with UL listed computers which have appropriate configured receptacles marked between 100-240V AC, Min. 5A.

 The wall socket shall be installed near the equipment and shall be easily accessible.

 For use only with the attached power adapter.

Manufacturers: FSP Group Inc.

Model: FSP230-AJAS3

Installation

! Do not place the monitor on an unstable cart, stand, tripod, bracket, or table. If the monitor falls, it can injure a person and cause serious damage to this product. Use only a cart, stand, tripod, bracket, or table recommended by the manufacturer or sold with this product. Follow the manufacturer's instructions when installing the product and use mounting accessories recommended by the manufacturer. A product and cart combination should be moved with care.

! Never push any object into the slot on the monitor cabinet. It could damage circuit parts causing a fire or electric shock. Never spill liquids on the monitor.

! Do not place the front of the product on the floor.

! If you mount the monitor on a wall or shelf, use a mounting kit approved by the manufacturer and follow the kit instructions.

! **WARNING: SUPPLY LINES! DANGER TO LIFE BY ELECTRIC SHOCK!**

Take appropriate measures to avoid damaging supply lines (electric, gas, water) during wall mounting.

! Leave some space around the monitor as shown below. Otherwise, air-circulation may be inadequate hence overheating may cause a fire or damage to the monitor.

! To avoid potential damage, for example the panel peeling from the bezel, ensure that the monitor does not tilt downward by more than -5 degrees. If the -5 degree downward tilt angle maximum is exceeded, the monitor damage will not be covered under warranty.

See below the recommended ventilation areas around the monitor when the monitor is installed on the wall or on the stand:

Installed with stand

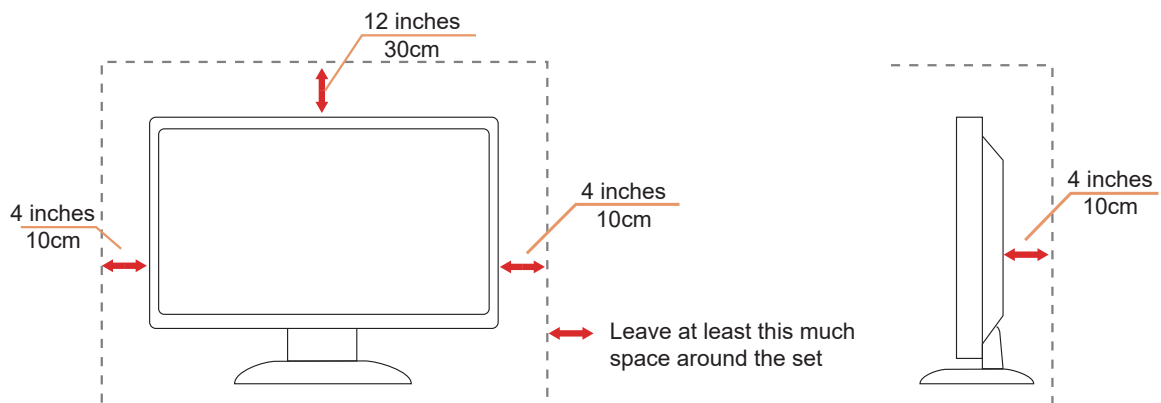

Cleaning

! Clean the cabinet regularly with a water-dampened, soft cloth.

! When cleaning use a soft cotton or microfiber cloth. The cloth should be damp and almost dry, do not allow liquid into the case.



! Please disconnect the power cord before cleaning the product.

Other

 If the product is emitting a strange smell, sound or smoke, disconnect the power plug IMMEDIATELY and contact a Service Center.

 Make sure that the ventilating openings are not blocked by a table or curtain.

 Do not engage the OLED monitor in severe vibration or high impact conditions during operation.

 Do not knock or drop the monitor during operation or transportation.

 **DANGER TO LIFE AND RISK OF ACCIDENTS FOR INFANTS AND CHILDREN!**

Never leave children unsupervised with the packaging material. The packaging material poses a suffocation hazard. Children frequently underestimate dangers.

Always keep children away from the product.

 Keep all documents for future use. When passing this product on to third parties, please include the installation instructions and safety notes.

 Do not place the device near a heat source and protect it from direct sunlight.

 Never expose the device to humidity, condensation or moisture.

Setup

Contents in Box

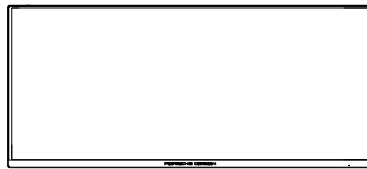

Monitor



Quick Start Guide



Warranty Card

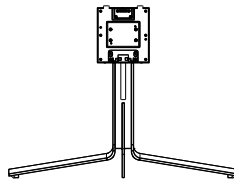

Stand/Base



Porsche Design
USB Disk



Power Cable



Adapter



DP Cable



HDMI Cable



USB Cable



USB C-C
Cable



USB C-C/A
Cable

* Not all signal cables will be provided for all countries and regions. Please check with the local dealer or AOC branch office for confirmation.

Setup Stand & Base

Please setup or remove the base following the steps as below.

Setup:

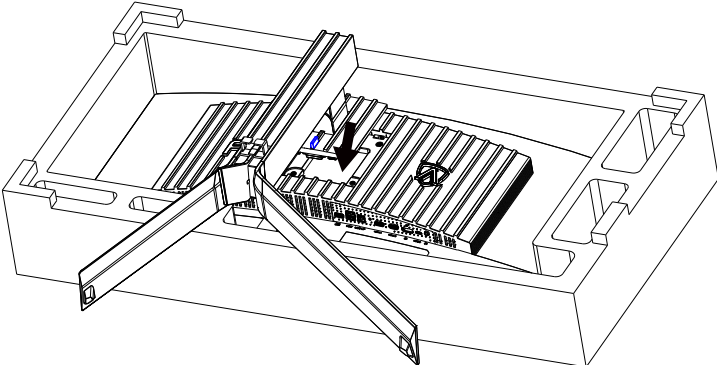

Remove:

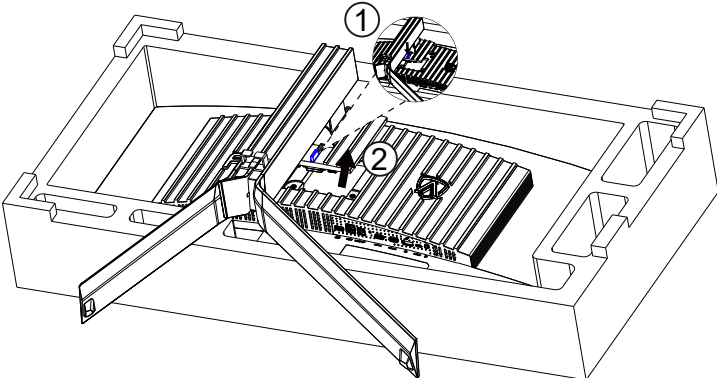

Screen Maintenance

To reduce the risk of image retention on the screen, regularly conduct the following maintenance. Not following these instructions may void your warranty.

- **Avoid displaying a still image for extended periods.**

A still image refers to an image that does not change over time, such as a photograph.

A still image may result in permanent damage to the QD-OLED screen, causing the image to continue to appear when no longer actively being shown.

For best results:

1. **No Static Images.** Do not display a still image for an extended time (4 hours). This may cause screen image residue (burn-in). If an image needs to be displayed for an extended time, reduce the brightness and contrast as much as possible.
2. **Use Full Screen.** When watching video that is letterboxed or pillar-boxed, such as 4:3 video, may result in artifacts. Use full screen mode to reduce this issue.
3. **No Stickers.** Do not put labels or stickers directly on the screen. This may cause screen damage.

- **Do not use this display for more than four hours continuously.**

This product uses many technologies to reduce or eliminate image retention (burn-in). Use the default screen settings to avoid image retention and maintain image quality.

- **Pixel Orbiting (Image Shift)**

Orbit will slightly shift the displayed image at the pixel level, once a second to prevent image retention.

This function is “On (Weak)” by default, “Weak” moves the least, “Strong” moves the most, “Off” disables the movement and increases the chance of image retention. This can be set in the OSD menu.

- **Pixel Refresh (Elimination of image retention)**

QD-OLED-skärmar börjar visa bildretention när en stillbild visas under en längre tid, cirka 4 timmars kontinuerlig användning.

För att eliminera bildrester som börjar dyka upp, kör funktionerna för eliminering av skärmbildsrester regelbundet för bästa visningsprestanda.

The following features have the default setting of “Off”, however they can be used to further protect your monitor against QD-OLED burn-in. It is recommended that you turn on these functions to further protect your panel:

- **Screen Saver**

The screen saver function will dim the screen to protect the panel from sticking.

- **Logos Protection**

The Multi-logo protection feature will dim the screen brightness if static logos are detected.

- **Boundary Dimmer**

The Boundary Dimmer feature will dim the brightness levels of detected areas that have a great change in brightness.

- **Taskbar Dimmer**

The Taskbar Dimmer feature will dim the brightness of the taskbar area.

- **ThermalProtection**

The Thermal Protection feature will keep the monitor’s temperature under 60 degrees by reducing brightness levels.

Adjusting the monitor

For optimal viewing it is recommended to look at the full face of the monitor, then adjust the monitor's angle to your own preference. Hold the stand so you will not topple the monitor when you change the monitor's angle. You are able to adjust the monitor as below:

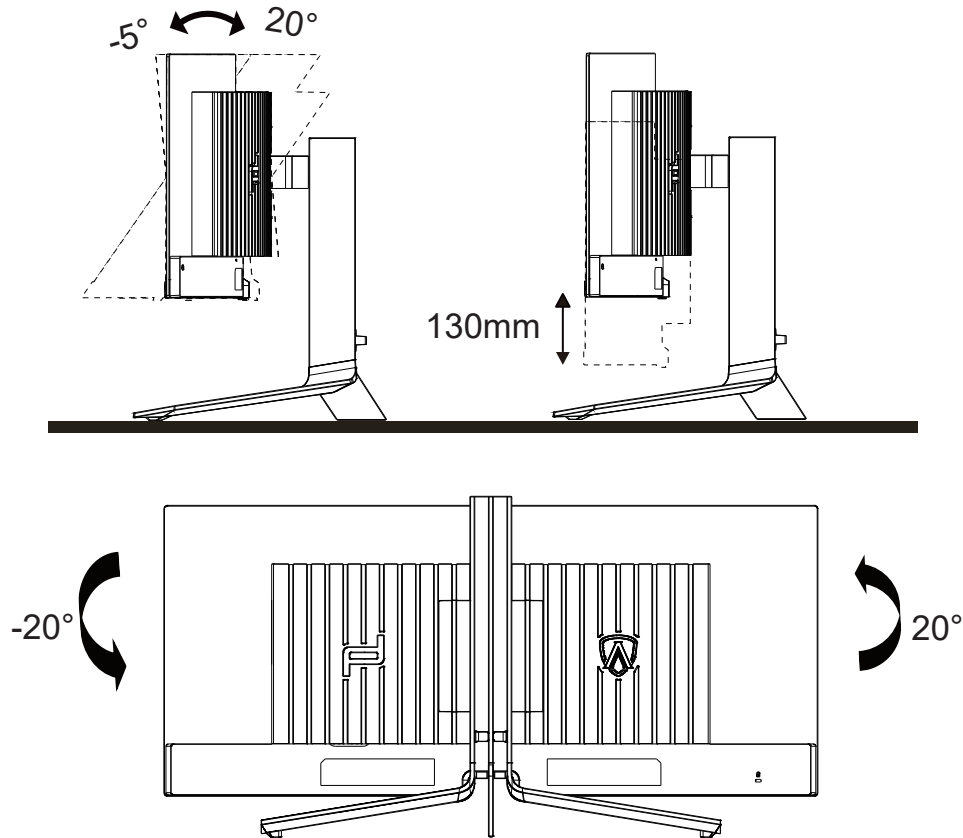

NOTE:

Do not touch the OLED screen when you change the angle. Touching the OLED screen may cause damage.

Warning:

1. To avoid potential screen damage, such as panel peeling, ensure that the monitor does not tilt downward by more than -5 degrees.
2. Do not press the screen while adjusting the angle of the monitor. Grasp only the bezel.

Connecting the Monitor

Cable Connections In Back of Monitor and Computer:

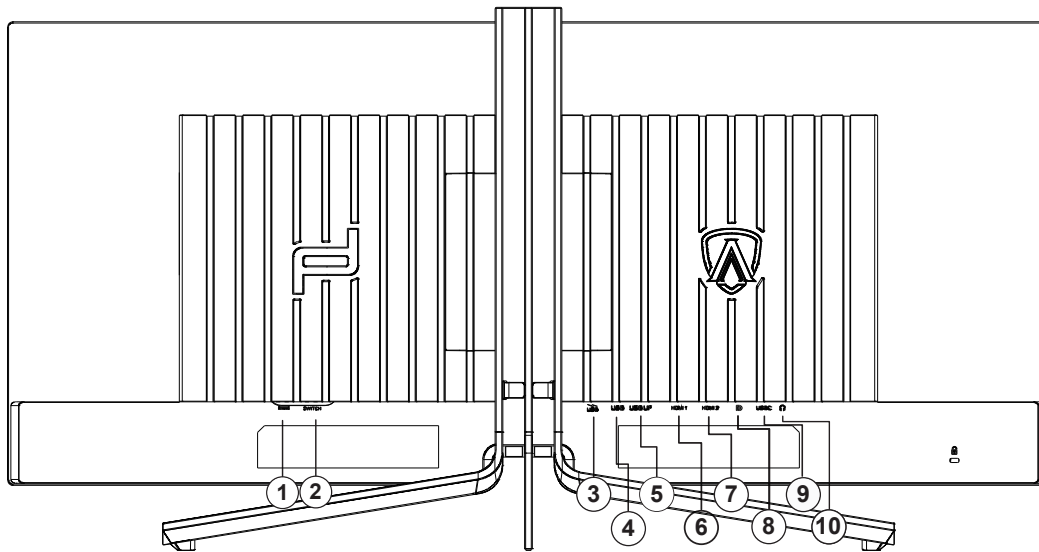

1. Power
2. Power Switch
3. USB3.2 Gen1+fast chargingx1
4. USB3.2 Gen1x2
5. USB UP
6. HDMI1
7. HDMI2
8. DisplayPort
9. USB C
10. Earphone

Connect to PC

1. Connect the power cord to the back of the display firmly.
2. Turn off your computer and unplug its power cable.
3. Connect the display signal cable to the video connector on the back of your computer.
4. Plug the power cord of your computer and your display into a nearby outlet.
5. Turn on your computer and display.

If your monitor displays an image, installation is complete. If it does not display an image, please refer Troubleshooting.

To protect equipment, always turn off the PC and OLED monitor before connecting.

Wall Mounting

Preparing to Install An Optional Wall Mounting Arm.

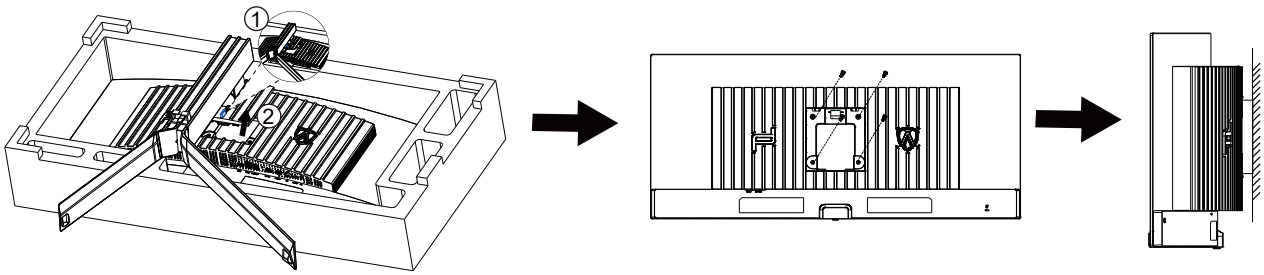

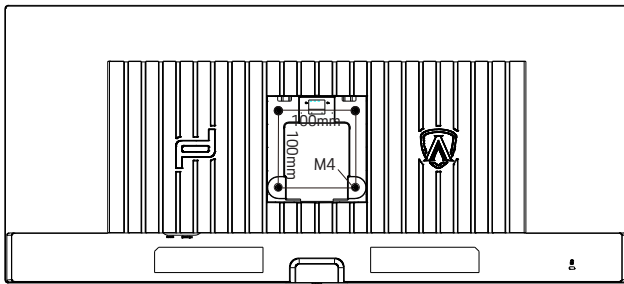

This monitor can be attached to a wall mounting arm you purchase separately. Disconnect power before this procedure. Follow these steps:

1. Remove the base.
2. Follow the manufacturer's instructions to assemble the wall mounting arm.
3. Place the wall mounting arm onto the back of the monitor. Line up the holes of the arm with the holes in the back of the monitor.
4. Reconnect the cables. Refer to the user's manual that came with the optional wall mounting arm for instructions on attaching it to the wall.

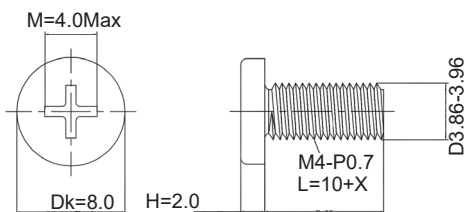

Specification of wall hanger screws: $M4*(10+X)mm$, (X=Thickness of Wall mount bracket)



 Note: VESA mounting screw holes are not available for all models, please check with the dealer or official department of AOC.

Always contact manufacturer for wall-mount installation.

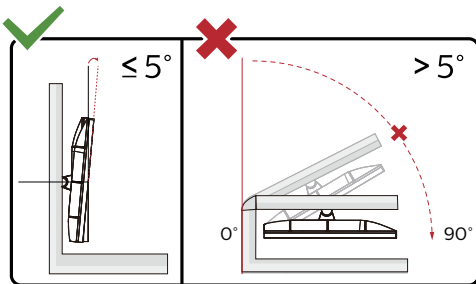

* Display design may differ from those illustrated.

Warning :

1. To avoid potential screen damage, such as panel peeling, ensure that the monitor does not tilt downward by more than -5 degrees.
2. Do not press the screen while adjusting the angle of the monitor. Grasp only the bezel.

Adaptive-Sync function

1. Adaptive-Sync function is working with DisplayPort/HDMI/USB C
2. Compatible Graphics Card: Recommend list is as the below, also could be checked by visiting www.AMD.com

Graphics Cards

- Radeon™ RX Vega series
- Radeon™ RX 500 series
- Radeon™ RX 400 series
- Radeon™ R9/R7 300 series (R9 370/X, R7 370/X, R7 265 except)
- Radeon™ Pro Duo (2016)
- Radeon™ R9 Nano series
- Radeon™ R9 Fury series
- Radeon™ R9/R7 200 series (R9 270/X, R9 280/X except)

Processors

- AMD Ryzen™ 7 2700U
- AMD Ryzen™ 5 2500U
- AMD Ryzen™ 5 2400G
- AMD Ryzen™ 3 2300U
- AMD Ryzen™ 3 2200G
- AMD PRO A12-9800
- AMD PRO A12-9800E
- AMD PRO A10-9700
- AMD PRO A10-9700E
- AMD PRO A8-9600
- AMD PRO A6-9500
- AMD PRO A6-9500E
- AMD PRO A12-8870
- AMD PRO A12-8870E
- AMD PRO A10-8770
- AMD PRO A10-8770E
- AMD PRO A10-8750B
- AMD PRO A8-8650B
- AMD PRO A6-8570
- AMD PRO A6-8570E
- AMD PRO A4-8350B
- AMD A10-7890K
- AMD A10-7870K
- AMD A10-7850K
- AMD A10-7800
- AMD A10-7700K
- AMD A8-7670K
- AMD A8-7650K
- AMD A8-7600
- AMD A6-7400K

HDR

It is compatible with input signals in HDR10 format.

The display may automatically activate the HDR function if the player and content are compatible. Please contact the device manufacturer and the content provider for information on the compatibility of your device and content. Please select "OFF" for the HDR function when you have no need for automatical activation function.

Note:

1. No special setting is needed for the DisplayPort/HDMI interface in WIN10 versions lower (older) than V1703.
2. Only the HDMI interface is available and the DisplayPort interface cannot function in WIN10 version V1703.
3. 3440 x1440@60Hz only suggest for Blu-ray Player, Xbox and PlayStation.
 - a. The display resolution is set to 3440 x1440, and HDR is preset to ON.
 - b. After entering an application, the best HDR effect can be achieved when the resolution is changed to 3440 x1440(if available).

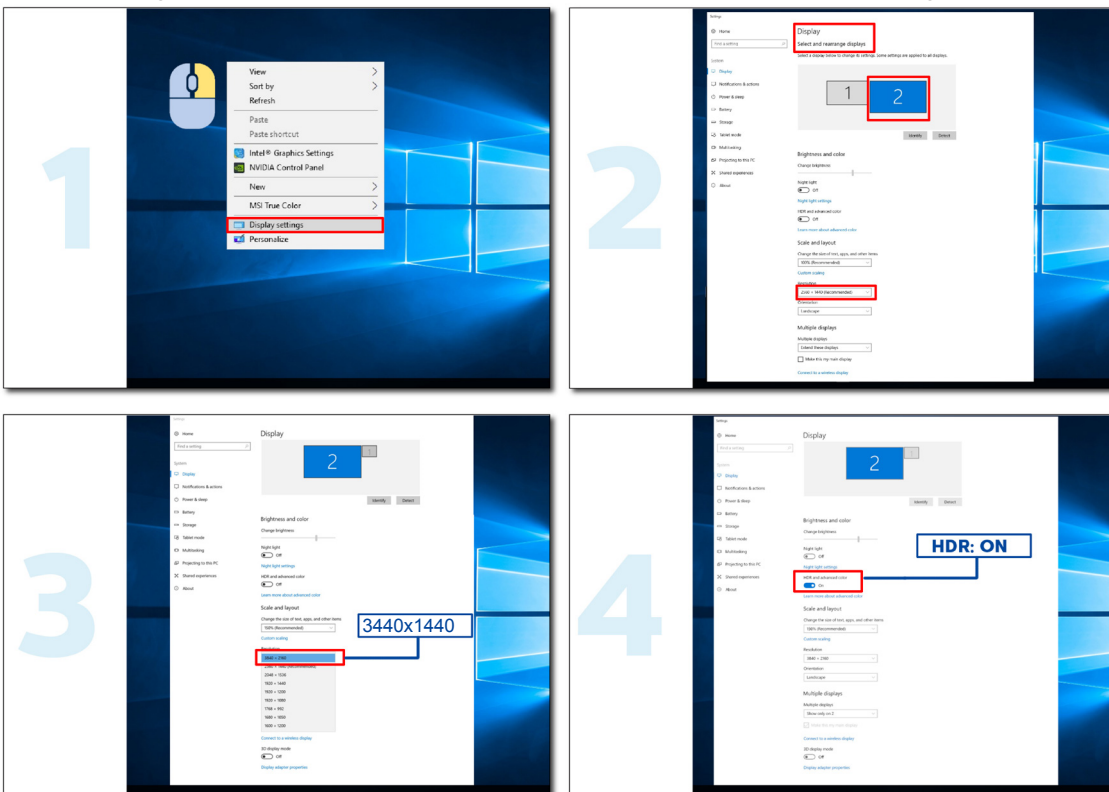

KVM function

What is KVM?

With KVM function, you can show two PCs, or two notebooks, or one PC and one notebook on one AOC monitor and control the two devices with one set of keyboard and mouse. Switch your control over your PC or notebook devices by choosing input signal source on "Input Select" of OSD menu.

How to use KVM?

Step 1: Please connect one device (PC or notebook) to monitor via USB C.

Step 2: Please connect the other device to monitor via HDMI or DisplayPort. Then please also connect this device to monitor with USB upstream.

Step 3: Please connect your peripherals (keyboard and mouse) to monitor via USB port.

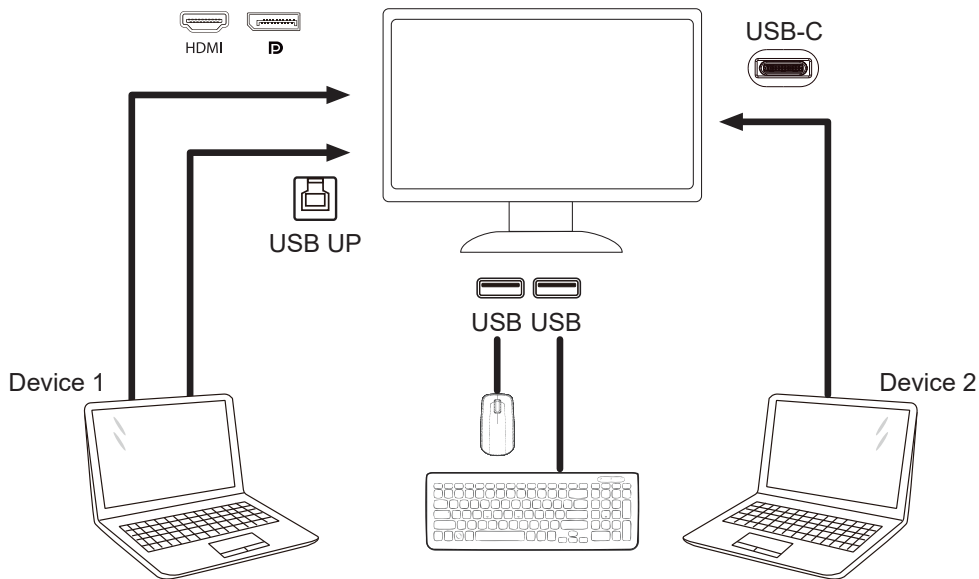

Note: Display design may differ from that illustrated

Step 4: Enter to OSD menu. Go to OSD Setup page and select "Auto", "USB C", or "USB UP" of USB Selection tab.

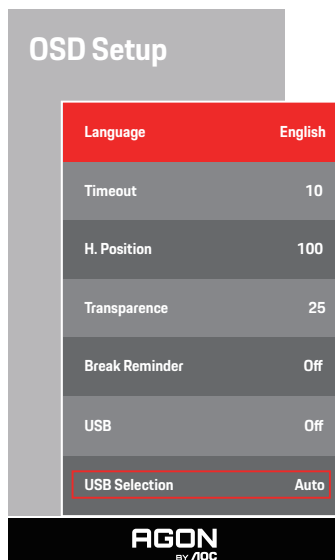

USB Selection	Function Description
Auto	Auto selects USB C or USB Up depending on the input source.
USB C	Provides USB Hub function through Type-C cable.
USB Up	Provides USB Hub function through USB B cable.

Adjusting

Hotkeys

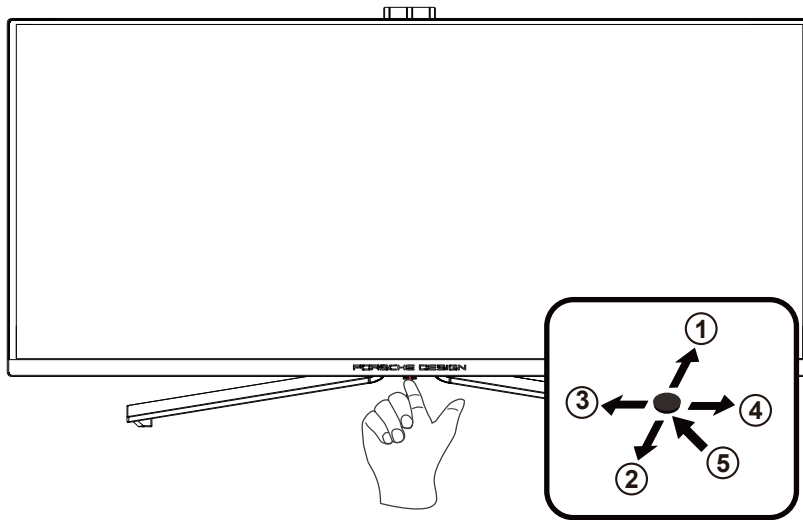

1	Source/Up
2	Dial Point/Down
3	Game Mode/Left
4	Light FX /Right
5	Power/ Menu/Enter

Power/Menu/Enter

Press the Power button to turn on the monitor.

When there is no OSD, Press to display the OSD or confirm the selection. Press about 2 seconds to turn off the monitor.

Dial Point/Down

When there is no OSD, press Dial Point button to show / hide Dial Point.

Game Mode/Left

When there is no OSD, press "Left" key to open game mode function, then press "Left" or "Right" key to select game mode (FPS, RTS, Racing, Gamer 1, Gamer 2 or Gamer 3) basing on the different game types.

Light FX/Right

When there is no OSD, press "Right" key to active Light FX function.

Source/Up

When the OSD is closed, press Source/Up button will be Source hot key function.

OSD Setting

Basic and simple instruction on the control keys.

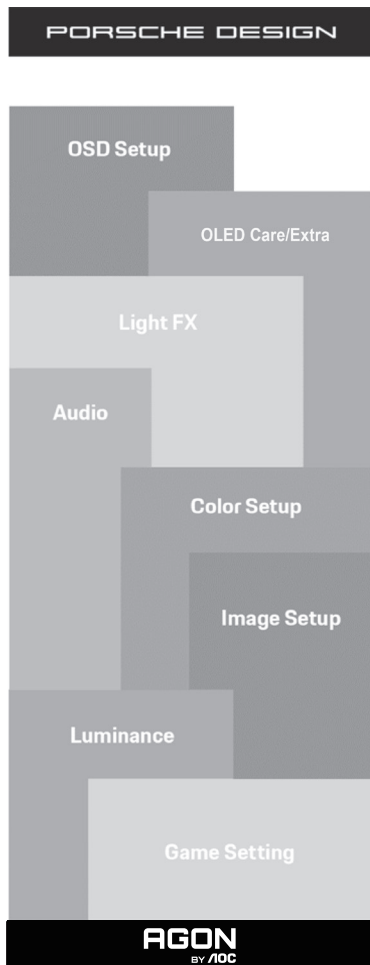

- 1). Press the MENU-button to activate the OSD window.
- 2). OSD Lock/Unlock Function: To lock or unlock the OSD, press and hold the Down-button for 10s while OSD function is not active.

Notes:

- 1). If the product has only one signal input, the item of "Input Select" is disable to adjust.
- 2). ECO modes (except Standard mode), DCB mode , for these three states that only one state can exist.

Game Setting

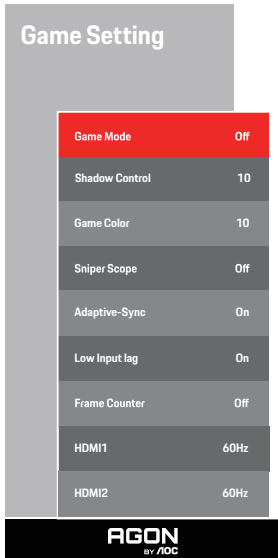

Game Mode	Off	No optimization by game game.
	FPS	For playing FPS (First Person Shooter) games. Improves dark theme black level details.
	RTS	For playing RTS (Real Time Strategy) games. Improves the image quality.
	Racing	For playing Racing games, Provides fastest response time and high color saturation.
	Gamer 1	User's preference settings saved as Gamer 1.
	Gamer 2	User's preference settings saved as Gamer 2.
	Gamer 3	User's preference settings saved as Gamer 3.
Shadow Control	0-20	Shadow Control Default is 10, then end-user can adjust from 10 to 20 or 0 to increase contrast for clear picture. 1. If picture is too dark to be saw the detail clearly, adjusting from 10 to 20 for clear picture. 2. If picture is too white to be saw the detail clearly, adjusting from 10 to 0 for clear picture
Game Color	0-20	Game Color will provide 0-20 level for adjusting saturation to get better picture.
Sniper Scope	Off / 1.0 / 1.5 / 2.0	Zoom in locally to make it easier to target when shooting.
Adaptive-Sync	On / Off	Disable or Enable Adaptive-Sync ..
Low Input lag	On / Off	Turn off frame buffer to decrease input lag
Frame Counter	Off / Right-Up / Right-Down / Left-Down / Left-Up	Display V frequency on the corner selected (Frame counter feature only works with AMD graphic card.)
HDMI1	60Hz/240Hz	When using the PS2(3) ,XBOX or DVD player, please change the OSD setting to "60Hz"
HDMI2	60Hz/240Hz	When using the PS2(3) ,XBOX or DVD player, please change the OSD setting to "60Hz"

Note:

When HDR is set to "non-off" under "Image Setup" and the input source has HDR content, "Game Mode", "Shadow Control", "Game Color" items cannot be adjusted .

Luminance

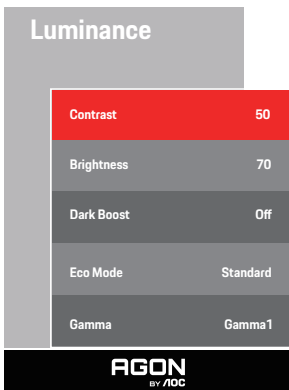

Contrast	0-100	Contrast from Digital-register.
Brightness	0-100	Backlight Adjustment
Dark Boost	Off/Level 1/Level 2/ Level 3	Enhance the screen details in the dark or bright area to adjust the brightness in the bright area and ensure that it is not oversaturated.
Eco Mode	Standard	Standard Mode
	Text	Text Mode
	Internet	Internet Mode
	Game	Game Mode
	Movie	Movie Mode
	Sports	Sports Mode
Gamma	Reading	Reading Mode
	Gamma 1	Adjust to Gamma 1
	Gamma 2	Adjust to Gamma 2
	Gamma 3	Adjust to Gamma 3

Note:

When the HDR Mode under "Image Setup" is set to "non-off", "Contrast", "Brightness" and "Gamma" is not adjustable.

When the HDR under "Image Setup" is set to "non-off", all items under "Luminance" is not adjustable.

When the "Color Space" under "Color Settings" is set to non "Standard", the "Contrast", "Brightness Profile", and "Gamma" items cannot be adjusted.

Image Setup

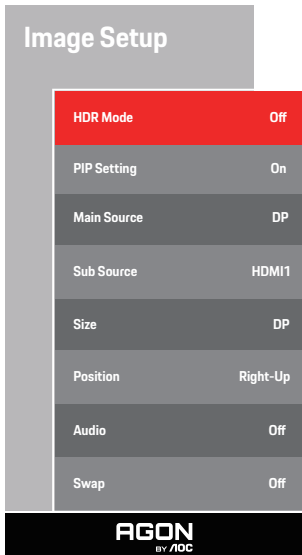

HDR	Off /HDR True Black/HDR 1000 Max/ HDR Picture / HDR Movie / HDR Game / HDR Native	Disable or Enable HDR
HDR Mode	Off / HDR Picture / HDR Movie / HDR Game	Disable or Enable HDR Mode
PIP Setting	Off/PIP/PBP	Disable or Enable PIP or PBP.
Main Source		Select main screen source.
Sub Source		Select sub screen source.
Size	Small /Middle /Large	Select screen size.
Position	Right-Up /Right-Down / Left-Down / Left-Up	Set the screen location.
Audio	On: Sub Audio Off: Main Audio	Swap Audio source.
Swap	On:Swap Off:non action	Swap the screen source.

Note:

- 1) When HDR is detected, the HDR option is displayed for adjustment; when HDR is not detected, the HDR Mode option is displayed for adjustment.
- 2) When the HDR is set to "non-off", In addition to "HDR", "Luminous Max" under "image setup" , other items are not adjustable.

3) When PIP/PBP is On, the Main source / Sub-source input source compatibility is as follow:

PIP/PBP		Main source			
		HDMI1	HDMI2	DP	USB-C
Sub source	HDMI1	V	V	V	V
	HDMI2	V	V	V	V
	DP	V	V	V	V
	USB-C	V	V	V	V

Color Setup

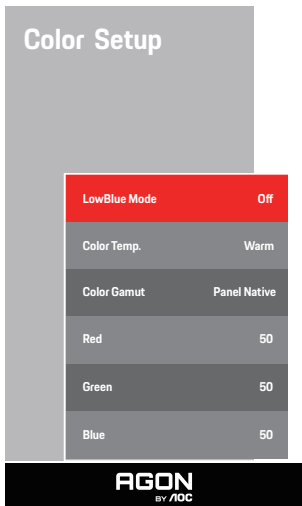

LowBlue Mode	Off / Multimedia / Internet / Office / Reading	Decrease blue light wave by controlling color temperature.
Color Temp.	Warm	Recall Warm Color Temperature from EEPROM.
	Normal	Recall Normal Color Temperature from EEPROM.
	Cool	Recall Cool Color Temperature from EEPROM.
	User	Red Gain from Digital-register Green Gain Digital-register. Blue Gain from Digital-register
Color Gamut	Panel Native / NTSC / sRGB / Display-P3 / DCI-P3 / DCI-P3 (D50) / Adobe RGB / Adobe RGB (D50) / Rec. 2020 / Rec. 709	Choose a different color space
Red	0-100	Red gain from Digital-register.
Green	0-100	Green gain from Digital-register.
Blue	0-100	Blue gain from Digital-register.

Note:

When the HDR/HDR Mode setting under "Image Setup" is set to "non-off" and the input source has HDR content, "Color Setup" is not adjustable.

Audio

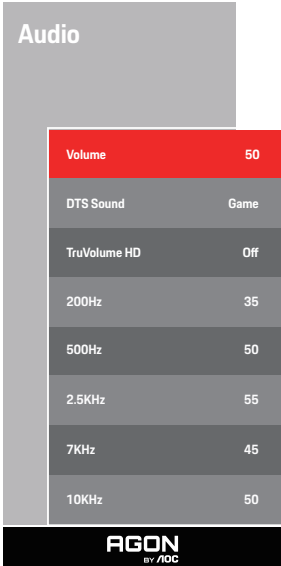

Volume	0-100	Adjust volume setting
DTS Sound	Game / Rock / Classical / Live / Theater / Off	Select DTS Sound mode. Note: It may take up to 2 seconds to switch modes.
TruVolume HD	On / Off	When opened, it can automatically balance the output volume of the horn. Suitable for night use.
200Hz	0-100	Low frequency base audio, also the root audio frequency of the chord in the tone.
500Hz	0-100	Mainly used to express vocals (eg. singing, reading), Strengthen the thickness and strength of vocals.
2.5KHz	0-100	This frequency has a strong penetrating power and can be improved to improve the brightness and clarity of the sound.
7KHz	0-100	Enhance the clarity of vocals.
10KHz	0-100	The high-pitched area of music is most sensitive to the high-frequency performance of the sound.

Light FX

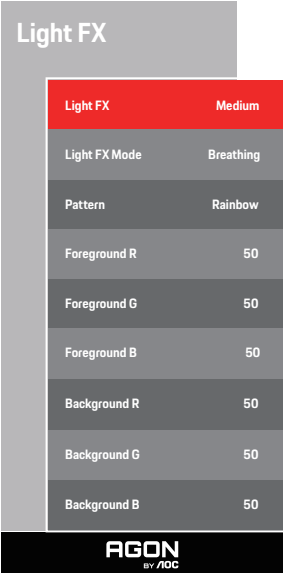

Light FX	Off / Low / Medium / Strong	Select the intensity of Light FX.
Light FX Mode	Static/Simple Shift/Gradient Shift/ Simple Filling/1 Way Filling/2 Way Filling/Breathing/Motion Point/Zoom/ Discolor/ Wave/Flashing/Demo	Select Light FX Mode
Pattern	Red / Green / Blue / Rainbow / User Define	Select Light FX Pattern
ForegroundR	0-100	User can adjust Light FX foreground color, when Pattern setting to user define
ForegroundG		
ForegroundB		
BackgroundR	0-100	User can adjust Light FX background color, when Pattern setting to user define
BackgroundG		
BackgroundB		

OLED Care/Extra

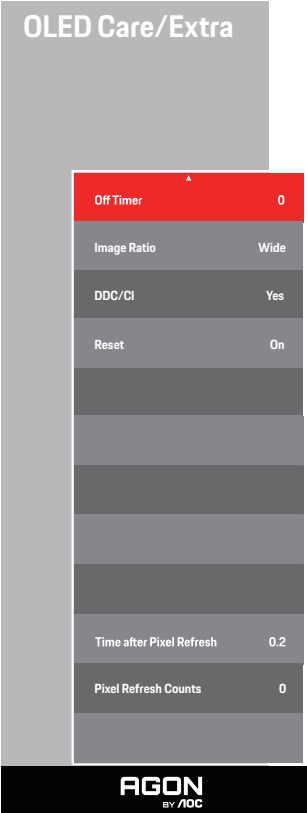
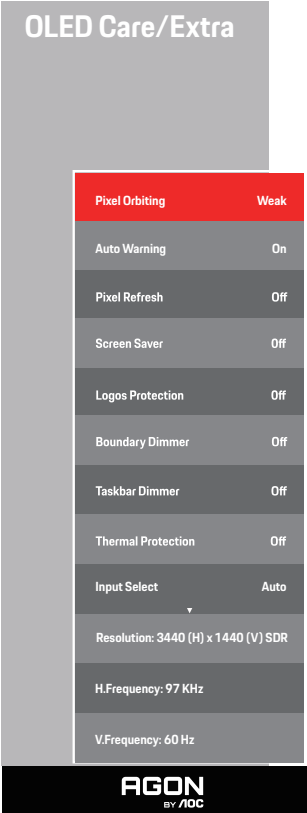

Pixel Orbiting (Image shift)	Off / Weak / Medium / Strong	It is used to turn the Pixel Orbiting function on to reduce the risk of generating image retention. Recommended function setting: "On." After this function is enabled, image pixels will circularly move as a whole. The movement amplitude is based on the settings. The moved character may be side cut. When "Strong" is selected, image retention is most unlikely generated, but possible side cut may be most notable.
Auto Warning	On/Off	Turn on/off the automatic prompt function of Pixel Refresh. The display automatically pop up a menu to remind the user to run Pixel Refresh every 4 hours. Selecting Close will no longer automatically display the automatic prompt menu of Pixel Refresh. Failure to perform Pixel Refresh at the recommended time will increase the risk of image residual on the screen. Please proceed cautiously.
Pixel Refresh (Elimination of image retention)	On/Off	It is used to enable and run the Pixel Refresh to eliminate image retention which has been generated. After startup, select "Yes" according to menu prompts, and then the display will automatically shut down the screen. Keep power on, and do not operate any keys. The power indicator flashes in white (on for 1 second/off for 1 second) and the whole process takes about 10 minutes. The power indicator turns off at the end, and the display enters standby state.
Screen Saver	Off / Slow / Fast	V
Logos Protection	Off/1/2	When there are multiple static logos detected on the screen, it's suggested to turn on logos Protection; which will dim the screen to protect the panel from image sticking where logos are detected.

Boundary Dimmer	Off/1/2/3	For special aspect ratios that have a black area in the frame of the screen or a split-screen, the boundary dimmer feature can automatically detect and dim the brightness of specific areas with a large difference in brightness levels.
Taskbar Dimmer	Off/1/2/3	A tecnologia Taskbar Dimmer irá diminuir o brilho da área da barra de tarefas no ecrã. Nenhuma alteração de brilho será ser perceptível nas áreas que não estejam na barra de tarefas.
Thermal Protection	On/Off	When the temperature of the monitor is over 60 degrees Celsius, the Thermal Protection feature will automatically dim the brightness of the screen in order to ensure heat dissipation properly. It is recommended that you turn on the feature for the monitor.
Input Select	AUTO/HDMI1/HDMI2/DP/USB C	Select Input Signal Source
Off Timer	0-24hrs	Select DC off time
Image Ratio	Wide /4:3/1:1 / 17"(4:3) / 19"(4:3) / 19"(5:4) / 19"W(16:10) / 21.5"W(16:9) / 22"W(16:10) / 23"W(16:9) / 23.6"W(16:9) / 24"W(16:9) / 27"W(16:9)	Select image ratio for display.
DDC/CI	Yes or No	Turn ON/OFF DDC/CI Support
Reset	Yes or No	Reset the menu to default
Time after Pixel Refresh		It refers to the time that the screen lights up after the last Pixel Refresh operation is executed, in units of hours. A prompt of executing Pixel Refresh will be automatically sent to the user every four hours.
Pixel Refresh Counts		It is used to record the number of times of executing Pixel Refresh.

Note:

[1] The device needs to support USB C (DP Alt) function.

When used for the first time or after resetting the OSD menu, the USB C (DP Alt) function is turned off by default and can be turned on again in any of the following ways:

- 1) The display has been turned on and off twice in total.
- 2) Set the "USB" option under "OSD Settings" in the OSD menu to a non closed state.

OSD Setup

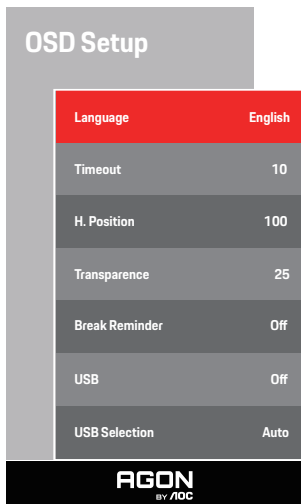

Language		Select the OSD language
Timeout	5-120	Adjust the OSD Timeout
H. Position	0-100	Adjust the horizontal position of OSD
Transparence	0-100	Adjust the transparence of OSD
Break Reminder	On /Off	Break reminder if the user continuously work for more than 1hrs
USB	Off/High-Speed / High-res.	Turn off USB function or set USB interface version.
USB Selection	Auto / USB C / USB up	Auto : switch with display input source USB C / USB up : fix up stream not change with input source

LED Indicator

Status	LED Color
Full Power Mode	White
Active-off Mode	Orange
Pixel Refresh under process	White indicator flashes (on a second and off a second alternatively)
OLED panel malfunction	Orange indicator flashes (on a second and off a second alternatively)
Shutdown mode	The indicator is not lit.

Troubleshoot

Problems	Possible solutions
The power indicator is not lit.	<ul style="list-style-type: none"> ● Check if the power is turned on. ● Check if the power cord is connected.
The power indicator is lit, but there is no image display.	<ul style="list-style-type: none"> ● Check if the computer power is turned on. ● Check if the graphics card of the computer is well plugged. ● Check that the signal wire of the display has been correctly connected to the computer. ● Check the plug of the signal wire of the display, and make sure all pins are not bent. ● Observe the indicator through the Caps Lock key on the keypad of the computer to confirm if the computer is working.
There is no image, but the power indicator flashes orange.	<ul style="list-style-type: none"> ● The OLED panel malfunctions and fails to work properly. Seek advice from AOC after-sales service persons.
Failure to realize plug-to-use.	<ul style="list-style-type: none"> ● Check if it supports plug-to-use. ● Check if the adapter supports plug-to-use.
Dim image.	<ul style="list-style-type: none"> ● Adjust luminance and contrast ratio.
The image is bouncing or rippled.	<ul style="list-style-type: none"> ● There may be electrical appliances and devices at the periphery that may cause electronic interference.
The screen displays "the signal wire is not available" or "no signal."	<ul style="list-style-type: none"> ● Check if the signal wire is correctly connected. ● Check if the pin of the signal wire plug is damaged. ● The Pixel Refresh function can be enabled and run in the display menu to eliminate image retention which has been generated. Running this function for several times can obtain a desirable image display effect. For other instructions regarding screen maintenance, refer to the User Instructions in the official website.
The screen displays "invalid input".	<ul style="list-style-type: none"> ● Check if your computer is set in an improper display mode Please re-set your computer in the display mode listed in the detailed user instructions.
Image retention.	<ul style="list-style-type: none"> ● Based on the characteristics of the OLED panel, the Pixel Refresh function can be enabled and run in the display menu to eliminate image retention which has been generated. It is recommended to run this function for several times to obtain a desirable image display effect. For other instructions regarding screen maintenance, please refer to the User Instructions in the official website.
Regulation & Service	Please refer to Regulation & Service Information which is in the CD manual or www.aoc.com (to find the model you purchase in your country and to find Regulation & Service Information in Support page.

Specification

General Specification

Panel	Model Name	PD34	
	Driving System	OLED	
	Viewable Image Size	86.8cm diagonal	
	Pixel Pitch	0.2315mm(H) x 0.2315mm(V)	
	Display Color	1.07B ^[1]	
Others	Horizontal Scan Range	30k~360kHz	
	Horizontal Scan Size(Maximum)	800.06mm	
	Vertical Scan Range	48~240Hz	
	Vertical Scan Size(Maximum)	337.06mm	
	Optimal Preset Resolution	3440 x1440@60Hz	
	Max Resolution	3440 x1440@240Hz	
	Plug & Play	VESA DDC2B/CI	
	Power Source	19.5V \equiv 11.8A	
	Power Consumption	Typical (default brightness and contrast)	108W*
Max. (Brightness = 100, contrast = 100)		\leq 240W*	
Standby mode		\leq 0.5 W	
Physical Characteristics	USB C Power Delivery	USB PD version 3.0 up to 65W ^[3] (5V/3A,7V3A, 9V/3A, 10V/3A, 12V/3A, 15V/3A, 20V/3.25A)	
	Connector Type	HDMIx2/DisplayPort/USB C/USB UP/USBx3(Include 1 Fast Charge)/ Earphone	
	Signal Cable Type	Detachable	
	Built-In Speaker	8Wx2	
Environmental	Temperature	Operating	0°C~40°C
		Non-Operating	-25°C~55°C
	Humidity	Operating	10%~85% (non-condensing)
		Non-Operating	5%~93% (non-condensing)
	Altitude	Operating	0m~5000m(0ft~16404ft)
		Non-Operating	0m~12192m (0ft~40000ft)

*The power specification is the power consumption of display (including power adapter) tested at the input end of the power adapter.

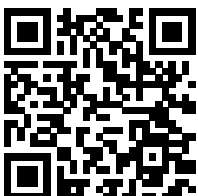

Note:

[1]: The maximum number of colors supported by this product is 1.07 billion, the setting conditions are as follows (due to different graphics card policies, some options will be hidden, graphics card support, please refer to the actual situation) :

Color Bit	Signal Version		Color Format		USB C @USB High Data Speed	USB C @USB High Resolution	USB C @USB High Data Speed	USB C @USB High Resolution
	HDMI2.1		DP1.4					
	YCbCr422 YCbCr420	YCbCr444 RGB	YCbCr422 YCbCr420	YCbCr444 RGB				
3440 x1440 240Hz 10bpc	V	V	V	V	V	V	V	V
3440 x1440 240Hz 8bpc	V	V	V	V	V	V	V	V
3440 x1440 200Hz 10bpc	\	\	V	V	V	V	V	V
3440 x1440 200Hz 8bpc	\	\	V	V	V	V	V	V
3440 x1440 165Hz 10bpc	V	V	V	V	V	V	V	V
3440 x1440 165Hz 8bpc	V	V	V	V	V	V	V	V
3440 x1440 144Hz 10bpc	V	V	V	V	V	V	V	V
3440 x1440 144Hz 8bpc	V	V	V	V	V	V	V	V
3440 x1440 120Hz 10bpc	V	V	V	V	V	V	V	V
3440 x1440 120Hz 8bpc	V	V	V	V	V	V	V	V
low resolutions 10bpc	V	V	V	V	V	V	V	V
low resolutions 8bpc	V	V	V	V	V	V	V	V

Note: Due to Windows system restrictions, HDR may not be enabled when the display color depth is 8 bpc+YCbCr422 or lower.

[2]: When USB C (DP Alt, HBR3) signal input and "USB" is set to "High Resolution", the maximum resolution is 3440 x1440@240Hz, and the USB interface is transmitted at the USB 2.0 rate, and when "USB" is set to "High Data Speed", the maximum resolution is 3440 x1440@165Hz, and the USB interface is transmitted at the USB 3.2 Gen1 rate. Differences may occur due to output limitations of some graphics cards.

[3]: The USB C port supports a maximum output power of 65W, as detailed in the following table:

4 USB downstream ports output total power	The maximum output power of the USB C interface	Output power specifications
16.5W	65W	5V/3A,7V3A,9V/3A,10V/3A,12V/3A,15V/3A,20V/3.25A

Note: Under the "OSD Settings" menu, set "High Data Speed" or "High Resolution" in the "USB" field.

Preset Display Modes

STANDARD	RESOLUTION(± 1 Hz)	HORIZONTAL FREQUENCY(kHz)	VERTICAL FREQUENCY(Hz)
VGA	640x480@60Hz	31.469	59.94
VGA	640x480@67Hz	35	66.667
VGA	640x480@72Hz	37.861	72.809
VGA	640x480@75Hz	37.5	75
VGA	640x480@100Hz	51.08	99.769
VGA	640x480@120Hz	61.91	119.518
DOS MODE	720x400@70Hz	31.469	70.087
DOS MODE	720x480@60Hz	29.855	59.710
SD	720x576@50Hz	31.25	50
SVGA	800x600@56Hz	35.156	56.25
SVGA	800x600@60Hz	37.879	60.317
SVGA	800x600@72Hz	48.077	72.188
SVGA	800x600@75Hz	46.875	75
SVGA	800x600@100Hz	63.684	99.662
SVGA	800x600@120Hz	76.302	119.97
SVGA	832x624@75Hz	49.725	74.551
XGA	1024x768@60Hz	48.363	60.004
XGA	1024x768@70Hz	56.476	70.069
XGA	1024x768@75Hz	60.023	75.029
XGA	1024x768@100Hz	81.577	99.972
XGA	1024x768@120Hz	97.551	119.989
SXGA	1280x1024@60Hz	63.981	60.02
SXGA	1280x1024@75Hz	79.975	75.025
Full HD	1920x1080@60Hz	67.5	60
QHD	2560x1440@60Hz	88.787	59.951
QHD	2560x1440@120Hz	183	120
WQHD	3440x1440@60Hz	88.861	60
WQHD	3440x1440@100Hz	161.9	100
WQHD	3440x1440@120Hz	194.28	120
WQHD	3440x1440@144Hz	233.138	144.001
WQHD	3440x1440@165Hz	267.135	165
WQHD	3440x1440@200Hz (Dp-only interface)	323.8	200
WQHD	3440x1440@240Hz	388.56	240

Note: According to the VESA standard, there may be a certain error (± 1 Hz) when calculating the refresh rate (field frequency) of different operating systems and graphics cards. In order to improve compatibility, the nominal refresh rate of this product has been rounded off. Please refer to the actual product.

Pin Assignments



19-Pin Color Display Signal Cable

Pin No.	Signal Name	Pin No.	Signal Name	Pin No.	Signal Name
1.	TMDS Data 2+	9.	TMDS Data 0-	17.	DDC/CEC Ground
2.	TMDS Data 2 Shield	10.	TMDS Clock +	18.	+5V Power
3.	TMDS Data 2-	11.	TMDS Clock Shield	19.	Hot Plug Detect
4.	TMDS Data 1+	12.	TMDS Clock-		
5.	TMDS Data 1Shield	13.	CEC		
6.	TMDS Data 1-	14.	Reserved (N.C. on device)		
7.	TMDS Data 0+	15.	SCL		
8.	TMDS Data 0 Shield	16.	SDA		

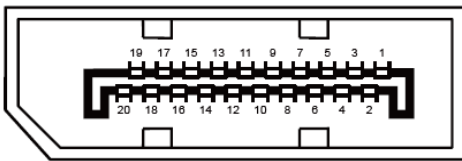

20-Pin Color Display Signal Cable

Pin No.	Signal Name	Pin No.	Signal Name
1	ML_Lane 3 (n)	11	GND
2	GND	12	ML_Lane 0 (p)
3	ML_Lane 3 (p)	13	CONFIG1
4	ML_Lane 2 (n)	14	CONFIG2
5	GND	15	AUX_CH(p)
6	ML_Lane 2 (p)	16	GND
7	ML_Lane 1 (n)	17	AUX_CH(n)
8	GND	18	Hot Plug Detect
9	ML_Lane 1 (p)	19	Return DP_PWR
10	ML_Lane 0 (n)	20	DP_PWR

Plug and Play

Plug & Play DDC2B Feature

This monitor is equipped with VESA DDC2B capabilities according to the VESA DDC STANDARD. It allows the monitor to inform the host system of its identity and, depending on the level of DDC used, communicate additional information about its display capabilities.

The DDC2B is a bi-directional data channel based on the I2C protocol. The host can request EDID information over the DDC2B channel.



For DTS patents, see <http://patents.dts.com>. Manufactured under license from DTS Licensing Limited. DTS, the Symbol, & DTS and the Symbol together are registered trademarks, and DTS Sound is a trademark of DTS, Inc. © DTS, Inc. All Rights Reserved.