

CE EMC TEST REPORT

Report No.: DDT-B23103005-1E01

Applicant	:	TPV Electronics (Fujian) Co., Ltd.
Address	:	Rongqiao Economic and Technological Development Zone, Fuqing City, Fujian Province, P.R. China
Equipment under Test	:	LCD Monitor
Model No.	:	**24G4***** ("*" = 0-9, A-Z, a-z, +, -, /, \ or blank)
Trade Mark	:	AOC

Issued By: Tianjin Dongdian Testing Service Co., Ltd.

Address: Building D-1, No. 19, West Road, Microelectronics Industrial Park, Development Area, Tianjin, China.

Tel: +86-22-58038033, **E-mail:** ddt@agddt.com, <http://www.ddttest.com>



CONTENTS

1 Summary of Test Results	6
2 General Test Information	7
2.1 Description of EUT	7
2.2 Primary Function of EUT	7
2.3 Port of EUT	7
2.4 Accessories of EUT	8
2.5 Test peripherals	8
2.6 Block diagram EUT configuration for test	9
2.7 EUT operating mode(s)	9
2.8 Performance Criteria	10
2.9 Deviations of test standard	10
2.10 Test laboratory	10
2.11 Measurement uncertainty	11
2.12 Abbreviations	11
3 Conducted Emissions (AC mains power ports)	12
3.1 General Information	12
3.2 Test Equipment	12
3.3 Reference Standard	12
3.4 Test Arrangement	12
3.5 Test Specification and Limit	14
3.6 Test Result	14
4 Radiated Emissions (30MHz to 1GHz)	16
4.1 General Information	16
4.2 Test Equipment	16
4.3 Reference Standard	16
4.4 Test Arrangement	17
4.5 Test Specification and Limit	19
4.6 Test Result	19
5 Radiated Emissions (Above 1GHz)	21
5.1 General Information	21
5.2 Test Equipment	21
5.3 Reference Standard	21
5.4 Test Arrangement	21
5.5 Test Specification and Limit	24
5.6 Test Result	24
6 Harmonic Current Emissions	26
6.1 General Information	26
6.2 Test Equipment	26
6.3 Reference Standard	26
6.4 Test Arrangement	26
6.5 Test Specification and Limit	27
6.6 Test Result	27
7 Voltage Changes, Voltage Fluctuations and Flicker	29
7.1 General Information	29
7.2 Test Equipment	29
7.3 Reference Standard	29
7.4 Test Arrangement	29
7.5 Test Specification and Limit	30
7.6 Test Result	30
8 Electrostatic Discharge Immunity	31
8.1 General Information	31
8.2 Test Equipment	31
8.3 Reference Standard	31
8.4 Test Arrangement	31
8.5 Test Specification and Limit	32
8.6 Test Result	32

9 Radiated, Radio-frequency, Electromagnetic Field Immunity	34
9.1 General Information	34
9.2 Test Equipment	34
9.3 Reference Standard	34
9.4 Test Arrangement	35
9.5 Test Specification and Limit	35
9.6 Test Result	36
10 Electrical Fast Transient/Burst Immunity	37
10.1 General Information	37
10.2 Test Equipment	37
10.3 Reference Standard	37
10.4 Test Arrangement	37
10.5 Test Specification and Limit	38
10.6 Test Result	39
11 Surge Immunity	40
11.1 General Information	40
11.2 Test Equipment	40
11.3 Reference Standard	40
11.4 Test Arrangement	40
11.5 Test Specification and Limit	41
11.6 Test Result	42
12 Immunity to Conducted Disturbances, Induced by Radio-frequency Fields	43
12.1 General Information	43
12.2 Test Equipment	43
12.3 Reference Standard	43
12.4 Test Arrangement	44
12.5 Test Specification and Limit	45
12.6 Test Result	45
13 Power Frequency Magnetic Field Immunity	46
13.1 General Information	46
13.2 Test Equipment	46
13.3 Reference Standard	46
13.4 Test Arrangement	47
13.5 Test Specification and Limit	47
13.6 Test Result	47
14 Voltage Dips, Short Interruptions and Voltage Variations Immunity	48
14.1 General Information	48
14.2 Test Equipment	48
14.3 Reference Standard	48
14.4 Test Arrangement	48
14.5 Test Specification and Limit	49
14.6 Test Result	49
Annex A. Test Setup Photos	50

Test Report Declare

Applicant	:	TPV Electronics (Fujian) Co., Ltd.
Address	:	Rongqiao Economic and Technological Development Zone, Fuqing City, Fujian Province, P.R. China
Equipment under Test	:	LCD Monitor
Model No.	:	**24G4***** ("*" = 0-9, A-Z, a-z, +, -, /, \ or blank)
Trade Mark	:	AOC

Test Standard Used:

CISPR 32:2015/AMD1:2019,CISPR 35:2016,EN 55032:2015,EN 55032:2015/A11:2020,
EN 55032:2015/A1:2020,EN 55035:2017,EN 55035:2017/A11:2020, AS/NZS CISPR 32:2015 AMD
1:2020,BS EN 55032:2015,BS EN 55032:2015+A11:2020,BS EN 55032:2015+A1:2020,
BS EN 55035:2017,BS EN 55035:2017+A11:2020,BS EN 61000-3-2:2014,BS EN 61000-3-
3:2013,BS EN 61000-3-3:2013+A1:2019,BS EN 61000-3-3:2013+A2:2021,BS EN IEC 61000-3-
2:2019+A1:2021,EN 61000-3-2:2014,EN 61000-3-3:2013,EN 61000-3-3:2013/A1:2019,
EN 61000-3-3:2013/A2:2021,EN IEC 61000-3-2:2019/A1:2021,IEC 61000-4-11:2020,
IEC 61000-4-2:2008,IEC 61000-4-3:2020,IEC 61000-4-4:2012,IEC 61000-4-
5:2014/AMD1:2017,IEC 61000-4-6:2013,IEC 61000-4-8:2009

We Declare:

The equipment described above is tested and assessed by Tianjin Dongdian Testing Service Co., Ltd. and in the configuration assessed the equipment complied with the standards specified above. The tested and assessed results are contained in this test report and Tianjin Dongdian Testing Service Co., Ltd. is assumed of full responsibility for the accuracy and completeness of these assessments.

After test and evaluation, our opinion is that the equipment provided for test compliance with the requirement of the above standards.

Report No.:	DDT-B23103005-1E01		
Date of Receipt:	Nov. 20, 2023	Date of Test:	Nov. 26, 2023~ Nov. 30, 2023



Prepared By:

May Zhang

May Zhang/Engineer

Approved By:

Aaron Zhang

Aaron Zhang/EMC Manager

Note: This report applies to above tested sample only. This report shall not be reproduced in parts without written approval of Tianjin Dongdian Testing Service Co., Ltd.

The report must not be used by the client to claim product certification, approval, or endorsement by NVLAP, NIST, or any agency of the U.S. Government.

Revision History

Rev.	Revisions	Issue Date	Revised By
---	Initial issue Remark: This report add speakers and mainboard basis of the report DDT-B23082413-1E01	Dec. 07, 2023	

1 Summary of Test Results

Description of Test Item	Standard	Result
Conducted Emissions (AC mains power ports)	EN 55032:2015, EN 55032:2015/A11:2020, EN 55032:2015/A1:2020	Pass
Radiated Emissions (30MHz to 1GHz)	EN 55032:2015, EN 55032:2015/A11:2020, EN 55032:2015/A1:2020	Pass
Radiated Emissions (Above 1GHz)	EN 55032:2015, EN 55032:2015/A11:2020, EN 55032:2015/A1:2020	Pass
Harmonic Current Emissions	EN 61000-3-2:2014, EN IEC 61000-3-2:2019/A1:2021	N/A
Voltage Changes, Voltage Fluctuations and Flicker	EN 61000-3-3:2013, EN 61000-3-3:2013/A1:2019, EN 61000-3-3:2013/A2:2021	Pass
Electrostatic Discharge Immunity	EN 55035:2017, EN 55035:2017/A11:2020, IEC 61000-4-2:2008	Pass
Radiated, Radio-frequency, Electromagnetic Field Immunity	EN 55035:2017, EN 55035:2017/A11:2020, IEC 61000-4-3:2020	Pass
Electrical Fast Transient/Burst Immunity	EN 55035:2017, EN 55035:2017/A11:2020, IEC 61000-4-4:2012	Pass
Surge Immunity	EN 55035:2017, EN 55035:2017/A11:2020, IEC 61000-4-5:2014/AMD1:2017	Pass
Immunity to Conducted Disturbances, Induced by Radio-frequency Fields	EN 55035:2017, EN 55035:2017/A11:2020, IEC 61000-4-6:2013	Pass
Power Frequency Magnetic Field Immunity	EN 55035:2017, EN 55035:2017/A11:2020, IEC 61000-4-8:2009	Pass
Voltage Dips, Short Interruptions and Voltage Variations Immunity	EN 55035:2017, EN 55035:2017/A11:2020, IEC 61000-4-11:2020	Pass

2 General Test Information

2.1 Description of EUT

EUT Name	:	LCD Monitor
Model Number	:	**24G4***** ("*" = 0-9, A-Z, a-z, +, -, /, \ or blank)
Model Differences	:	All models difference is in sale marketing.
Serial Number	:	N/A
Test Model	:	24G4X
Sample No.	:	Y23103005-01
Power supply	:	100-240V ~ 50/60Hz
Test Power supply	:	230V 50Hz, 110V 60Hz
EUT Class	:	Class B
Maximum work frequency	:	415.6 MHz

2.2 Primary Function of EUT

Function	Description
Broadcast reception function	N/A
Print	N/A
Scan	N/A
Display or display output	Display
Musical tone generating	N/A
Networking	N/A
Audio output	Audio output function (internal speaker & audio output port)
Telephony	N/A
Bluetooth	N/A
Other	N/A

2.3 Port of EUT

Port	Description
AC mains power ports	AC mains power port
DC network power port	N/A
Wired network port	N/A
Signal data/control port	Two HDMI in Ports, One DP in Port
Antenna port	N/A
Broadcast receiver tuner port	N/A
Audio output port	One Audio out Port, Two Speakers
Video output port	N/A
Other	N/A

2.4 Accessories of EUT

Accessories	Manufacturer	Model No.	Description	Remark
AC Cable	N/A	N/A	Length: 1.2m/1.5m/1.8m, Unshielded	N/A
DP Cable	N/A	N/A	Length: 1.2m/1.5m/1.8m, Shielded	N/A
HDMI Cable	N/A	N/A	Length: 1.2m/1.5m/1.8m, Shielded	N/A

2.5 Test peripherals

Device	Manufacturer	Model No.	Description	Remark
PC	Hewlett-Packard	TPC-W058-MT	8CG0321Q58	N/A
PC	LENOVO	GeekPro-14ACN	M70Q5KC0	N/A
PC	DELL	Vostro 5890	700SBD3	N/A
DVD	PHILIPS	TAEP200/93	HCPE2025000750	N/A
Keyboard	DELL	N/A	N/A	N/A
Mouse	DELL	N/A	N/A	N/A
Speaker	JBL	GO2+	N/A	N/A
Headphone	N/A	N/A	N/A	N/A

2.6 Block diagram EUT configuration for test

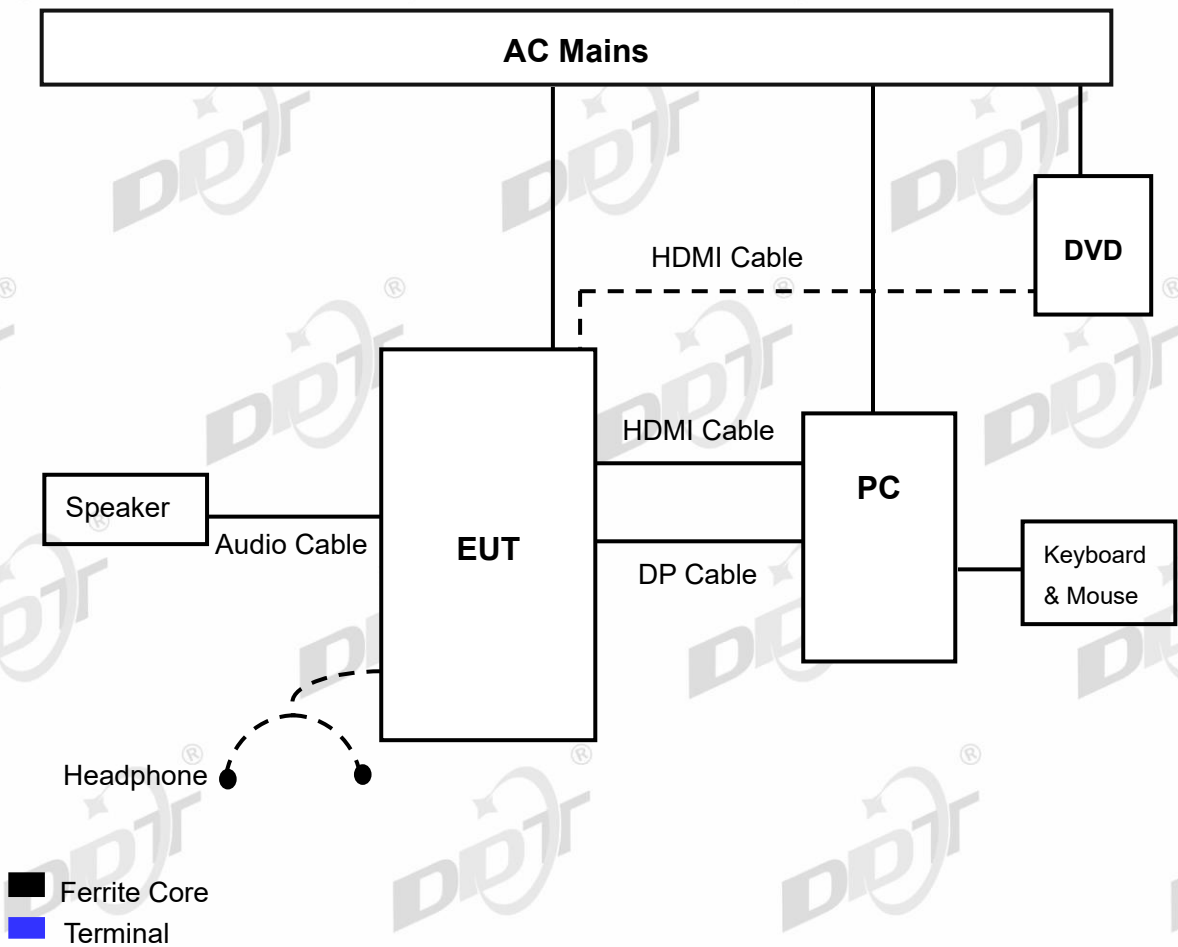

2.7 EUT operating mode(s)

Mode 1	Connect HDMI cable from PC's HDMI port to EUT's HDMI Port. Connect DP cable from PC's DP port to EUT's DP Port. Switch source to HDMI1. The test signal is color bars with moving picture element according to ITU-R BT 471-1.
Mode 2	Connect HDMI cable from PC's HDMI port to EUT's HDMI Port. Connect DP cable from PC's DP port to EUT's DP Port. Switch source to HDMI2. The test signal is color bars with moving picture element according to ITU-R BT 471-1.
Mode 3	Connect HDMI cable from PC's HDMI port to EUT's HDMI Port. Connect DP cable from PC's DP port to EUT's DP Port. Switch source to DP. The test signal is color bars with moving picture element according to ITU-R BT 471-1.

2.8 Performance Criteria

Criterion	Description
A	The equipment shall continue to operate as intended without operator intervention. No degradation of performance, loss of function or change of operating state is allowed below a performance level specified by the manufacturer when the equipment is used as intended. The performance level may be replaced by a permissible loss of performance. If the minimum performance level or the permissible performance loss is not specified by the manufacturer, then either of these may be derived from the product description and documentation, and by what the user may reasonably expect from the equipment if used as intended.
B	During the application of the disturbance, degradation of performance is allowed. However, no unintended change of actual operating state or stored data is allowed to persist after the test. After the test, the equipment shall continue to operate as intended without operator intervention; no degradation of performance or loss of function is allowed, below a performance level specified by the manufacturer, when the equipment is used as intended. The performance level may be replaced by a permissible loss of performance. If the minimum performance level (or the permissible performance loss), or recovery time, is not specified by the manufacturer, then either of these may be derived from the product description and documentation, and by what the user may reasonably expect from the equipment if used as intended.
C	Loss of function is allowed, provided the function is self-recoverable, or can be restored by the operation of the controls by the user in accordance with the manufacturer's instructions. A reboot or re-start operation is allowed. Information stored in non-volatile memory, or protected by a battery backup, shall not be lost.

2.9 Deviations of test standard

[Standard deviation 1] Radiated, radio-frequency, electromagnetic field immunity test was done according to IEC 61000-4-3:2020 instead of IEC 61000-4-3:2006+AMD1:2007+AMD2:2010.

[Standard deviation 2] Surge immunity test was done according to IEC 61000-4-5:2014/AMD1:2017 instead of IEC 61000-4-5:2005.

[Standard deviation 3] Radio-frequency conducted immunity test was done according to IEC 61000-4-6:2013 instead of IEC 61000-4-6:2008.

[Standard deviation 4] Voltage dips, short interruptions and voltage variations immunity tests was done according to IEC 61000-4-11:2020 instead of IEC 61000-4-11:2004.

2.10 Test laboratory

Tianjin Dongdian Testing Service Co., Ltd.

Address: Building D-1, No. 19, Weisi Road, Microelectronics Industrial Park Development Area, Tianjin, China.

Tel: +86-22-58038033, <http://www.ddttest.com>, Email: ddt@dgddt.com

NVLAP (National Voluntary Laboratory Accreditation Program) CODE: 500036-0

CNAS (China National Accreditation Service for Conformity Assessment) CODE: L13402

FCC Designation Number: CN5004; FCC Test Firm Registration Number: 368676

ISED (Innovation, Science and Economic Development Canada) Company Number: 27768

Conformity Assessment Body Identifier: CN0125

VCCI Facility Registration Number: C-20089, T-20093, R-20125, G-20122

2.11 Measurement uncertainty

Test Item	Uncertainty
Conducted Emissions at Mains Power Port	3.4 dB (150KHz-30MHz)
Conducted Emissions at Telecommunication Port (ISN T800)	4.59 dB
Conducted Emissions at Telecommunication Port (ISN ST08)	3.5 dB
Radiated Emissions (30MHz to 1GHz)	5.2 dB (Antenna Polarize: Hor.)
	5.2 dB (Antenna Polarize: Ver.)
Radiated Emissions (Above 1GHz)	5.0 dB
Harmonic Current Emissions	3.1 %
Voltage Changes, Voltage Fluctuations and Flicker	1.7 %

Note: This uncertainty represents an expanded uncertainty expressed at approximately the 95% confidence level using a coverage factor of k=2.
We have conducted the Electrostatic discharge, Electrical fast transient/burst, Surge, Voltage dips, short interruptions and voltage variations tests to check the uncertainty. Radiated, radio-frequency, electromagnetic field 5.4 dB. Conducted disturbances, induced by radio-frequency fields 1.1 dB.

2.12 Abbreviations

For the purposes of the present document, the following abbreviations apply:

EUT: Equipment Under Test

QP: Quasi-Peak

PK: Peak,

AV: Average

CAV: CISPR Average

CDN: Coupling Decoupling Network

AM: Amplitude Modulation

N/A: Not Applicable

3 Conducted Emissions (AC mains power ports)

3.1 General Information

Test date	Nov. 28, 2023	Test engineer	Sam Zhao	
Climate condition	Ambient temperature	23.1°C	Relative humidity	28.2%
	Atmospheric pressure	101.3kPa		
Test place	Shield Room 2#			

3.2 Test Equipment

Equipment	Manufacturer	Model No.	Serial No.	Last Cal.	Cal. Interval
Two-Line V-Network	Rohde & Schwarz	ENV216	101122	Feb. 15, 2023	1 Year
EMI Test Receiver	Rohde & Schwarz	ESCI	101397	Feb. 15, 2023	1 Year
Two-Line V-Network	Rohde & Schwarz	ENV216	101254	Feb. 15, 2023	1 Year
Test Software	TOYO	EP5/CE	Ver 5.4.40	N/A	N/A

3.3 Reference Standard

EN 55032:2015,
EN 55032:2015/A11:2020,
EN 55032:2015/A1:2020

3.4 Test Arrangement

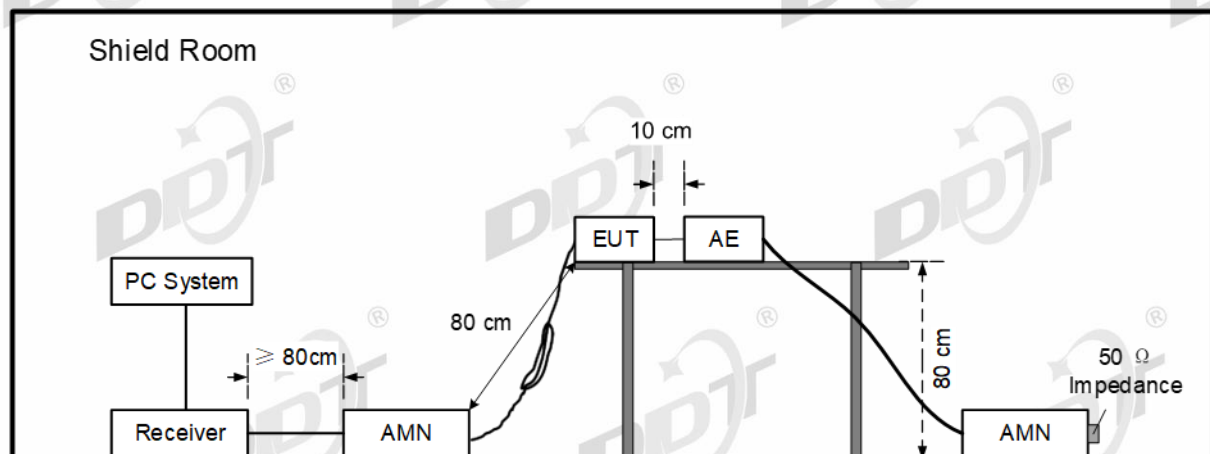

The EUT was placed on a non-metallic table, 80cm above the ground plane.

The EUT's power adapter was connected to the power mains through a line impedance stabilization network (AMN), which this provided a 50-ohm coupling impedance for the EUT (Please refer to the block diagram of the test setup and photographs). Both sides of power line were checked for maximum conducted disturbance.

The bandwidth of test receiver is set at 9 kHz.

The frequency range from 150 kHz to 30MHz is checked.

Pre-scan measurements were performed in all operating mode or resolution. But final measurements were performed in worst cases based on pre-scan measurements.

The EUT with following test modes were pre-tested:

No.	Test Voltage	Operation Mode	Cable Length	Resolution	Rotation	Audio	Stand Position	
1.	230V 50Hz	Mode 1 HDMI1	1.8m	1920*1080@180Hz	Landscape	External Speaker	HAS Stand-up	
2.			1.8m	1920*1080@60Hz	Landscape	External Speaker	HAS Stand-up	
3.			1.8m	1280*720@60Hz	Landscape	External Speaker	HAS Stand-up	
4.			1.8m	800*600@60Hz	Landscape	External Speaker	HAS Stand-up	
5.			1.5m	1920*1080@180Hz	Landscape	External Speaker	HAS Stand-up	
6.			1.2m	1920*1080@180Hz	Landscape	External Speaker	HAS Stand-up	
7.		Mode 2 HDMI2	1.8m	1920*1080@180Hz	Landscape	External Speaker	HAS Stand-up	
8.			1.8m	1920*1080@60Hz	Landscape	External Speaker	HAS Stand-up	
9.			1.8m	1280*720@60Hz	Landscape	External Speaker	HAS Stand-up	
10.			1.8m	800*600@60Hz	Landscape	External Speaker	HAS Stand-up	
11.			1.5m	1920*1080@180Hz	Landscape	External Speaker	HAS Stand-up	
12.			1.2m	1920*1080@180Hz	Landscape	External Speaker	HAS Stand-up	
13.		Mode 3 DP	HDMI1/2	1.8m	DVD	Landscape	External Speaker	HAS Stand-up
14.			1.8m	1920*1080@180Hz	Landscape	External Speaker	HAS Stand-up	
15.			1.8m	1920*1080@60Hz	Landscape	External Speaker	HAS Stand-up	
16.			1.8m	1280*720@60Hz	Landscape	External Speaker	HAS Stand-up	
17.			1.8m	800*600@60Hz	Landscape	External Speaker	HAS Stand-up	
18.			1.5m	1920*1080@180Hz	Landscape	External Speaker	HAS Stand-up	
19.			1.2m	1920*1080@180Hz	Landscape	External Speaker	HAS Stand-up	

20.		The worst case above with 1.5m power cord	Landscape	External Speaker	HAS Stand-up
21.		The worst case above with 1.2m power cord	Landscape	External Speaker	HAS Stand-up
22.		The worst case above with 1.8m power cord	Portrait (-90 degree)	External Speaker	HAS Stand-up
23.		The worst case above with 1.8m power cord	Portrait (-270 degree)	External Speaker	HAS Stand-up
24.		The worst case above with 1.8m power cord	Landscape	External Speaker	HAS Stand-down
25.		The worst case above with 1.8m power cord	Landscape	Headphone	HAS Stand-up
26.		The worst case above with 1.8m power cord	Landscape	Internal Speaker	HAS Stand-up
27.		The worst case above with 1.8m power cord with scrolling "H" pattern	Landscape	External Speaker	HAS Stand-up
28.	110V 60Hz	The worst case above with 1.8m power cord	Landscape	External Speaker	HAS Stand-up

3.5 Test Specification and Limit

Class B

Frequency	Quasi-Peak Level dB(μ V)	Average Level dB(μ V)
150kHz ~ 500kHz	66 ~ 56*	56 ~ 46*
500kHz ~ 5MHz	56	46
5MHz ~ 30MHz	60	50

Notes: 1. * Decreasing linearly with logarithm of frequency.
2. The lower limit shall apply at the transition frequencies.

3.6 Test Result

Sample No.	Operation Mode	Remarks	Result
Y23103005-01	Mode 1	Final measurement, minimum margin 6.0dB	Pass
Y23103005-01	Mode 2	Pre-scan measurement	Pass
Y23103005-01	Mode 3	Pre-scan measurement	Pass

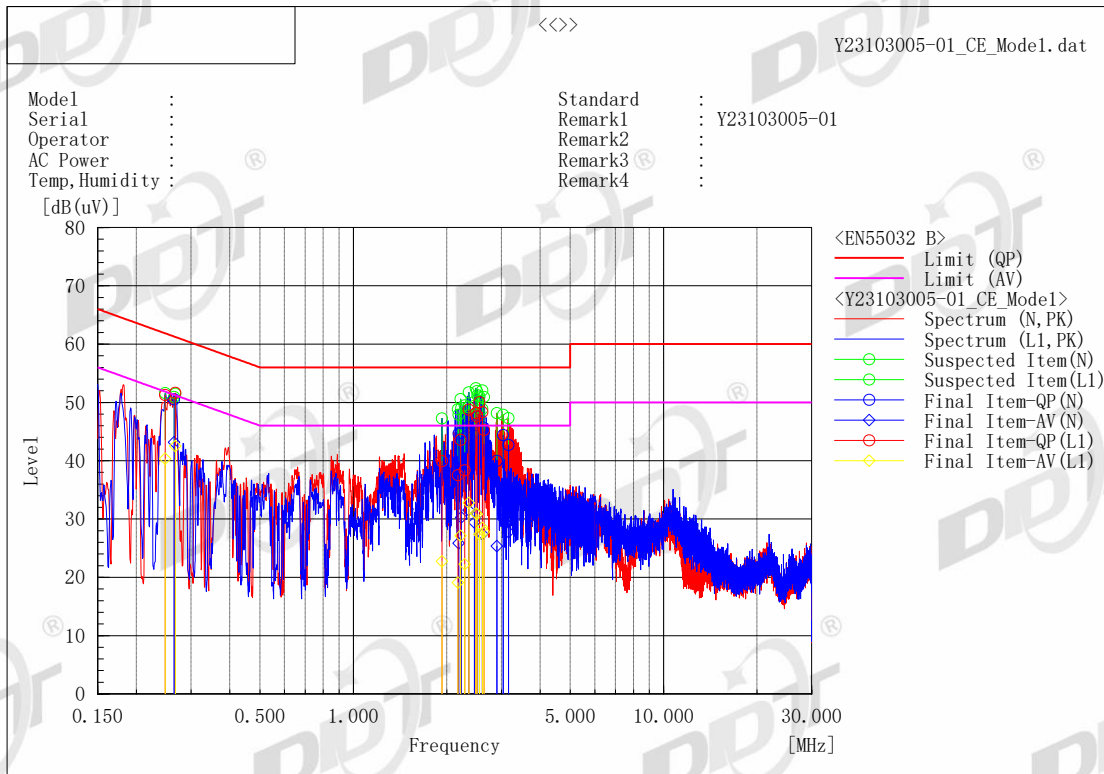

Final Result

--- N Phase ---										
No.	Frequency [MHz]	Reading QP [dB(uV)]	Reading CAV [dB(uV)]	c. f [dB]	Result QP [dB(uV)]	Result CAV [dB(uV)]	Limit QP [dB(uV)]	Limit AV [dB(uV)]	Margin QP [dB]	Margin CAV [dB]
1	0.26435	40.7	33.3	9.8	50.5	43.1	61.3	51.3	10.8	8.2
2	2.51168	37.6	20.9	9.9	47.5	30.8	56.0	46.0	8.5	15.2
3	3.03844	34.4	20.0	10.0	44.4	30.0	56.0	46.0	11.6	16.0
4	2.90389	30.0	15.3	10.0	40.0	25.3	56.0	46.0	16.0	20.7
5	3.16124	32.7	17.7	10.0	42.7	27.7	56.0	46.0	13.3	18.3
6	2.22773	34.9	20.4	9.9	44.8	30.3	56.0	46.0	11.2	15.7
7	2.35097	35.9	21.6	9.9	45.8	31.5	56.0	46.0	10.2	14.5
8	2.60622	35.8	17.5	9.9	45.7	27.4	56.0	46.0	10.3	18.6
9	2.45584	36.1	19.5	9.9	46.0	29.4	56.0	46.0	10.0	16.6
10	2.1835	34.7	15.9	9.9	44.6	25.8	56.0	46.0	11.4	20.2

--- L1 Phase ---										
No.	Frequency [MHz]	Reading QP [dB(uV)]	Reading CAV [dB(uV)]	c. f [dB]	Result QP [dB(uV)]	Result CAV [dB(uV)]	Limit QP [dB(uV)]	Limit AV [dB(uV)]	Margin QP [dB]	Margin CAV [dB]
1	0.24774	41.5	30.5	9.8	51.3	40.3	61.8	51.8	10.5	11.5
2	0.26675	41.8	32.7	9.8	51.6	42.5	61.2	51.2	9.6	8.7
3	2.4816	38.3	21.1	9.9	48.2	31.0	56.0	46.0	7.8	15.0
4	2.60501	38.4	18.6	9.9	48.3	28.5	56.0	46.0	7.7	17.5
5	2.64057	35.4	17.9	9.9	45.3	27.8	56.0	46.0	10.7	18.2
6	2.54934	40.1	17.5	9.9	50.0	27.4	56.0	46.0	6.0	18.6
7	2.50586	37.7	20.9	9.9	47.6	30.8	56.0	46.0	8.4	15.2
8	2.35535	38.8	22.8	9.9	48.7	32.7	56.0	46.0	7.3	13.3
9	2.21781	33.6	17.2	9.9	43.5	27.1	56.0	46.0	12.5	18.9
10	2.28504	28.5	12.3	9.9	38.4	22.2	56.0	46.0	17.6	23.8
11	2.17293	27.6	9.2	9.9	37.5	19.1	56.0	46.0	18.5	26.9
12	1.93004	30.0	12.9	9.9	39.9	22.8	56.0	46.0	16.1	23.2

Note for test result

Note1): According pre-test, the worst test modes decided as below and reported. Only data of worst mode was reported in test result.

Note2) Line = Polarity of input power (Live or Neutral), N: Abbreviation of Neutral Polarity, L1: Abbreviation of Live Polarity,

Note3) Level (Quasi-Peak and/or C/Average) = Meter Reading + Factor,

Note4) Factor = AMN (or AAN) Insertion Loss + Cable Loss,

Note5) Margin = Limit - Level (Quasi-Peak and/or C/Average)

4 Radiated Emissions (30MHz to 1GHz)

4.1 General Information

Test date	Nov. 26, 2023	Test engineer	Dominic Du	
Climate condition	Ambient temperature	23.7°C	Relative humidity	34.5%
	Atmospheric pressure	101.9kPa		
Test place	10m Chamber			

4.2 Test Equipment

Equipment	Manufacturer	Model No.	Serial No.	Last Cal.	Cal. Interval
EMI Test Receiver	Rohde & Schwarz	ESCI	101024	Feb. 15, 2023	1 Year
EMI Test Receiver	Rohde & Schwarz	ESCI	101030	Feb. 15, 2023	1 Year
BiLog Antenna	TESEQ	CBL 6112D	29068	Oct. 10, 2022	2 Year
BiLog Antenna	TESEQ	CBL 6112D	29069	Oct. 10, 2022	2 Year
Low Noise Amplifier	SONOMA	310N	300913	Feb. 15, 2023	1 Year
Low Noise Amplifier	SONOMA	310N	334532	Feb. 16, 2023	1 Year
RF Selector 4CH	TOYO	NS4904N	Selector1	N/A	N/A
RF Selector 4CH	TOYO	NS4904N	Selector2	N/A	N/A
Mast Control	INNCO	CONTROLLE R CO2000	ZOAA97AZ10 0013D	N/A	N/A
Test Software	TOYO	EP5/RE	Ver 5.7.10	N/A	N/A

4.3 Reference Standard

EN 55032:2015,
EN 55032:2015/A11:2020,
EN 55032:2015/A1:2020

4.4 Test Arrangement

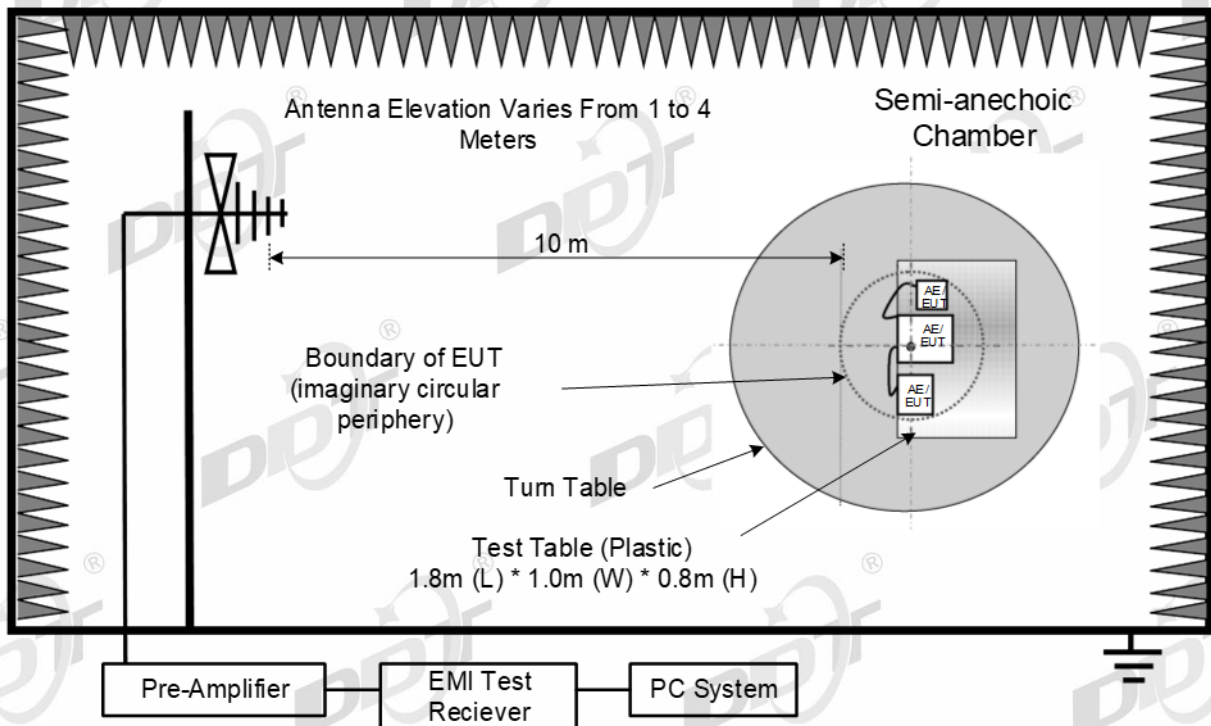

The EUT was placed on a non-metallic table, 80 cm above the ground plane inside a semi-anechoic chamber.

Test antenna was located 10m from the EUT on an adjustable mast. A pre-scan was first performed in order to find prominent radiated emissions. For final emissions measurements at each frequency of interest, the EUT were rotated and the antenna height was varied between 1m and 4m in order to maximize the emission. Measurements in both horizontal and vertical polarities were made and the data was recorded.

Spectrum frequency from 30MHz to 1GHz was investigated.

For final emissions measurements at each frequency of interest, the EUT were rotated and the antenna height was varied between 1m and 4m in order to maximize the emission. Measurements in both horizontal and vertical polarities were made and the data was recorded.

For emissions from 30MHz to 1GHz, Quasi-Peak values were measured with EMI Receiver and the bandwidth of Receiver is 120 kHz.

Final measurements consisted of 3 steps. First step, frequency fine tuning to find exact emission frequency. Second step, rechecking to search for maximum height and azimuth for interference from EUT. In final step, there are conducted measuring with quasi-peak detector for points which are detected from 1st step & 2nd step. Results checked manually and points close to the limit line were re-measured.

Pre-scan measurements were performed in all operating mode or condition. But final measurements were performed in worst cases based on pre-scan measurements.

The EUT with following test modes were pre-tested:

No.	Test Voltage	Operation Mode	Cable Length	Resolution	Rotation	Audio	Stand Position	
1.	230V 50Hz	Mode 1 HDMI1	1.8m	1920*1080@180Hz	Landscape	External Speaker	HAS Stand-up	
2.			1.8m	1920*1080@60Hz	Landscape	External Speaker	HAS Stand-up	
3.			1.8m	1280*720@60Hz	Landscape	External Speaker	HAS Stand-up	
4.			1.8m	800*600@60Hz	Landscape	External Speaker	HAS Stand-up	
5.			1.5m	1920*1080@180Hz	Landscape	External Speaker	HAS Stand-up	
6.			1.2m	1920*1080@180Hz	Landscape	External Speaker	HAS Stand-up	
7.		Mode 2 HDMI2	1.8m	1920*1080@180Hz	Landscape	External Speaker	HAS Stand-up	
8.			1.8m	1920*1080@60Hz	Landscape	External Speaker	HAS Stand-up	
9.			1.8m	1280*720@60Hz	Landscape	External Speaker	HAS Stand-up	
10.			1.8m	800*600@60Hz	Landscape	External Speaker	HAS Stand-up	
11.			1.5m	1920*1080@180Hz	Landscape	External Speaker	HAS Stand-up	
12.			1.2m	1920*1080@180Hz	Landscape	External Speaker	HAS Stand-up	
13.		Mode 3 DP	HDMI1/2	1.8m	DVD	Landscape	External Speaker	HAS Stand-up
14.			1.8m	1920*1080@180Hz	Landscape	External Speaker	HAS Stand-up	
15.			1.8m	1920*1080@60Hz	Landscape	External Speaker	HAS Stand-up	
16.			1.8m	1280*720@60Hz	Landscape	External Speaker	HAS Stand-up	
17.			1.8m	800*600@60Hz	Landscape	External Speaker	HAS Stand-up	
18.			1.5m	1920*1080@180Hz	Landscape	External Speaker	HAS Stand-up	
19.			1.2m	1920*1080@180Hz	Landscape	External Speaker	HAS Stand-up	

20.		The worst case above with 1.5m power cord	Landscape	External Speaker	HAS Stand-up
21.		The worst case above with 1.2m power cord	Landscape	External Speaker	HAS Stand-up
22.		The worst case above with 1.8m power cord	Portrait (-90 degree)	External Speaker	HAS Stand-up
23.		The worst case above with 1.8m power cord	Portrait (-270 degree)	External Speaker	HAS Stand-up
24.		The worst case above with 1.8m power cord	Landscape	External Speaker	HAS Stand-down
25.		The worst case above with 1.8m power cord	Landscape	Headphone	HAS Stand-up
26.		The worst case above with 1.8m power cord	Landscape	Internal Speaker	HAS Stand-up
27.		The worst case above with 1.8m power cord with scrolling "H" pattern	Landscape	External Speaker	HAS Stand-up
28.		The worst mode 1920*1080@60Hz with 1.8m power cord	Landscape	Headphone	HAS Stand-up
29.		The worst mode 1920*1080@60Hz with 1.8m power cord	Landscape	Internal Speaker	HAS Stand-up
30.	110V 60Hz	The worst case above with 1.8m power cord	Landscape	External Speaker	HAS Stand-up

4.5 Test Specification and Limit

Class B

Frequency	Field Strengths Limits at 10m measuring distance dB(μ V)/m
30MHz to 230MHz	30
230MHz to 1000MHz	37

Note: (1) The smaller limit shall apply at the cross point between two frequency bands.

(2) Distance is the distance in meters between the measuring instrument, antenna and the closest point of any part of the device or system.

4.6 Test Result

Sample No.	Operation Mode	Remarks	Result
Y23103005-01	Mode 1	Final measurement , minimum margin 8.4 dB	Pass
Y23103005-01	Mode 2	Pre-scan measurement	Pass
Y23103005-01	Mode 3	Pre-scan measurement	Pass

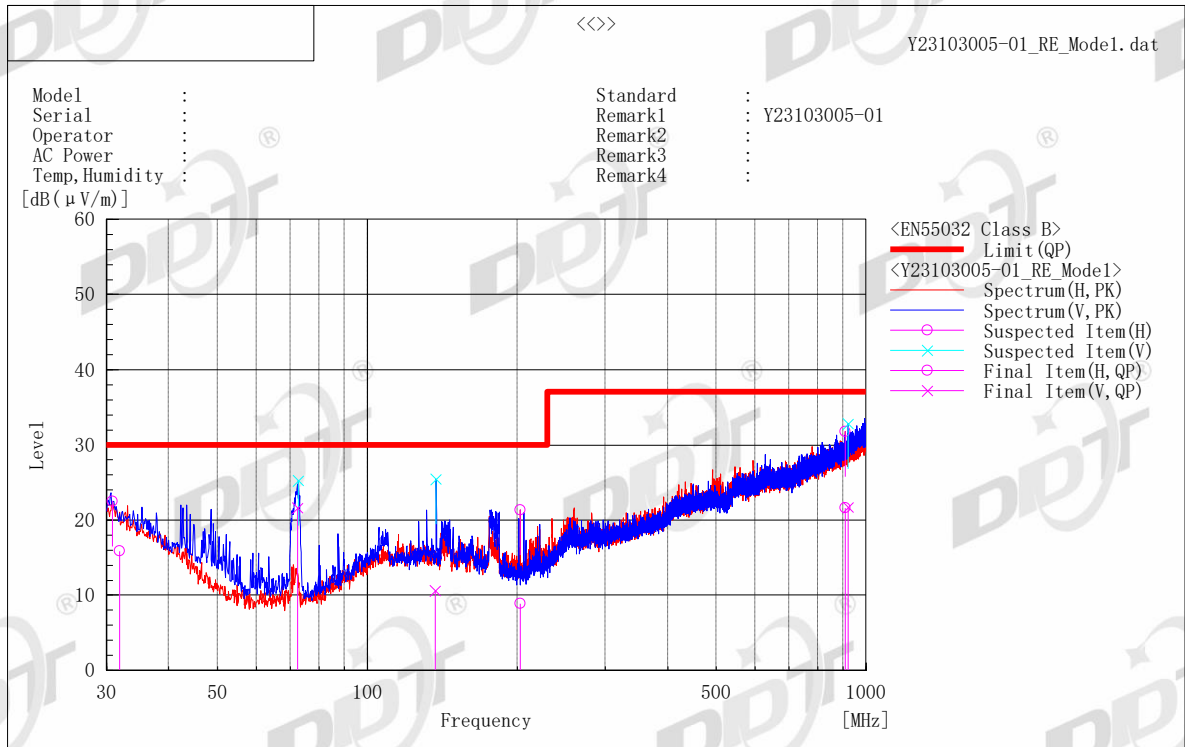

Final Result

No.	Frequency [MHz]	(P)	Reading QP [dB(μV)]	c.f [dB(1/m)]	Result QP [dB(μV/m)]	Limit QP [dB(μV/m)]	Margin QP [dB]	Height [cm]	Angle [°]	System	Remark
1	31.830	H	21.8	-5.9	15.9	30.0	14.1	321.0	329.1	1	
2	202.850	H	21.5	-12.6	8.9	30.0	21.1	376.0	201.4	1	
3	908.510	H	17.7	3.9	21.6	37.0	15.4	389.0	317.6	1	
4	72.330	V	38.7	-17.1	21.6	30.0	8.4	216.0	309.8	2	
5	136.865	V	22.0	-11.4	10.6	30.0	19.4	223.0	187.3	2	
6	920.522	V	16.6	5.1	21.7	37.0	15.3	210.0	191.2	2	

Note for test result

Note1): According pre-test, the worst test modes decided as below and reported. Only data of worst mode was reported in test result.

Note2) (P): Abbreviation of Antenna Polarity

Note3) Receiving antenna polarization: Horizontal and/or Vertical. Antenna Height: 1 m to 4 m

Note4) Level QP (Quasi-Peak) = Reading QP + Factor

Note5) Factor = Antenna Factor + Cable Loss - Amp. Gain

Note6) Margin = Limit - Level QP

5 Radiated Emissions (Above 1GHz)

5.1 General Information

Test date	Nov. 26, 2023	Test engineer	Dominic Du	
Climate condition	Ambient temperature	23.7°C	Relative humidity	34.5%
	Atmospheric pressure	101.9kPa		
Test place	10m Chamber			

5.2 Test Equipment

Equipment	Manufacturer	Model No.	Serial No.	Last Cal.	Cal. Interval
EMI Test Receiver	Rohde & Schwarz	ESU26	100244	Feb. 16, 2023	1 Year
Broadband Horn Antenna	TESEQ	BHA 9118	31754	Oct. 11, 2023	2 Year
Amplifier	COM-MW	DPA8 1000 18000-1012	09211739	Feb. 16, 2023	1 Year
Test Software	TOYO	EP5/RE	Ver 5.7.10	N/A	N/A

5.3 Reference Standard

EN 55032:2015,
EN 55032:2015/A11:2020,
EN 55032:2015/A1:2020

5.4 Test Arrangement

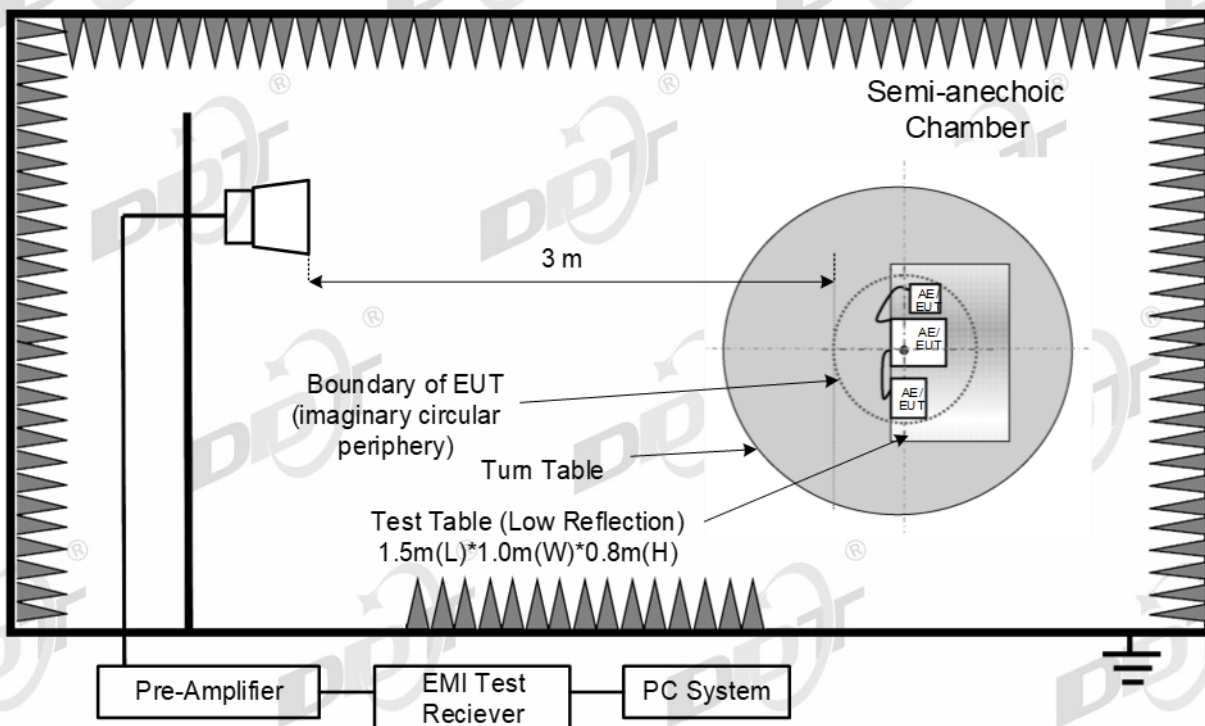

The highest internal source of an EUT is defined as the highest frequency generated or used within the EUT or on which the EUT operates or tunes.

If the highest frequency of the internal sources of the EUT is less than 108 MHz, the measurement shall only be made up to 1 GHz.

If the highest frequency of the internal sources of the EUT is between 108 MHz and 500 MHz, the measurement shall only be made up to 2 GHz.

If the highest frequency of the internal sources of the EUT is between 500 MHz and 1 GHz, the measurement shall only be made up to 5 GHz.

If the highest frequency of the internal sources of the EUT is above 1 GHz, the measurement shall be made up to 5 times the highest frequency or 6 GHz, whichever is less.

For emissions above 1GHz, both Peak and Average level were measured with Spectrum Analyzer, and the RBW is set at 1MHz.

Measurements within 20 dB of the limit were then maximized by adjusting turntable position.

Final measurements were made using an C/Average detector.

Results checked manually and points close to the limit line were re-measured.

Pre-scan measurements were performed in all operating mode or resolution. But final measurements were performed in worst cases based on pre-scan measurements.

The EUT with following test modes were pre-tested:

No.	Test Voltage	Operation Mode	Cable Length	Resolution	Rotation	Audio	Stand Position
1.	230V 50Hz	Mode 1 HDMI1	1.8m	1920*1080@180Hz	Landscape	External Speaker	HAS Stand-up
2.			1.8m	1920*1080@60Hz	Landscape	External Speaker	HAS Stand-up
3.			1.8m	1280*720@60Hz	Landscape	External Speaker	HAS Stand-up
4.			1.8m	800*600@60Hz	Landscape	External Speaker	HAS Stand-up
5.			1.5m	1920*1080@180Hz	Landscape	External Speaker	HAS Stand-up
6.			1.2m	1920*1080@180Hz	Landscape	External Speaker	HAS Stand-up
7.		Mode 2 HDMI2	1.8m	1920*1080@180Hz	Landscape	External Speaker	HAS Stand-up
8.			1.8m	1920*1080@60Hz	Landscape	External Speaker	HAS Stand-up
9.			1.8m	1280*720@60Hz	Landscape	External Speaker	HAS Stand-up
10.			1.8m	800*600@60Hz	Landscape	External Speaker	HAS Stand-up
11.			1.5m	1920*1080@180Hz	Landscape	External Speaker	HAS Stand-up
12.			1.2m	1920*1080@180Hz	Landscape	External Speaker	HAS Stand-up
13.		HDMI1/2	1.8m	DVD	Landscape	External Speaker	HAS Stand-up

14.		Mode 3 DP	1.8m	1920*1080@180Hz	Landscape	External Speaker	HAS Stand-up
15.			1.8m	1920*1080@60Hz	Landscape	External Speaker	HAS Stand-up
16.			1.8m	1280*720@60Hz	Landscape	External Speaker	HAS Stand-up
17.			1.8m	800*600@60Hz	Landscape	External Speaker	HAS Stand-up
18.			1.5m	1920*1080@180Hz	Landscape	External Speaker	HAS Stand-up
19.			1.2m	1920*1080@180Hz	Landscape	External Speaker	HAS Stand-up
20.		The worst case above with 1.5m power cord			Landscape	External Speaker	HAS Stand-up
21.		The worst case above with 1.2m power cord			Landscape	External Speaker	HAS Stand-up
22.		The worst case above with 1.8m power cord			Portrait (-90 degree)	External Speaker	HAS Stand-up
23.		The worst case above with 1.8m power cord			Portrait (-270 degree)	External Speaker	HAS Stand-up
24.		The worst case above with 1.8m power cord			Landscape	External Speaker	HAS Stand-down
25.		The worst case above with 1.8m power cord			Landscape	Headphone	HAS Stand-up
26.		The worst case above with 1.8m power cord			Landscape	Internal Speaker	HAS Stand-up
27.		The worst case above with 1.8m power cord with scrolling "H" pattern			Landscape	External Speaker	HAS Stand-up
28.		The worst mode 1920*1080@60Hz with 1.8m power cord			Landscape	Headphone	HAS Stand-up
29.		The worst mode 1920*1080@60Hz with 1.8m power cord			Landscape	Internal Speaker	HAS Stand-up
30.	110V 60Hz	The worst case above with 1.8m power cord			Landscape	External Speaker	HAS Stand-up

5.5 Test Specification and Limit

Class B

Frequency range Limits (GHz)	Limits of Class B, dB(μ V/m)	
	Peak	C/Average
1 ~ 3	70	50
3 ~ 6	74	54

Note: The lower limit shall apply at the transition frequency

5.6 Test Result

Sample No.	Operation Mode	Remarks	Result
Y23103005-01	Mode 1	Final measurement , minimum margin 16.8 dB	Pass
Y23103005-01	Mode 2	Pre-scan measurement	Pass
Y23103005-01	Mode 3	Pre-scan measurement	Pass

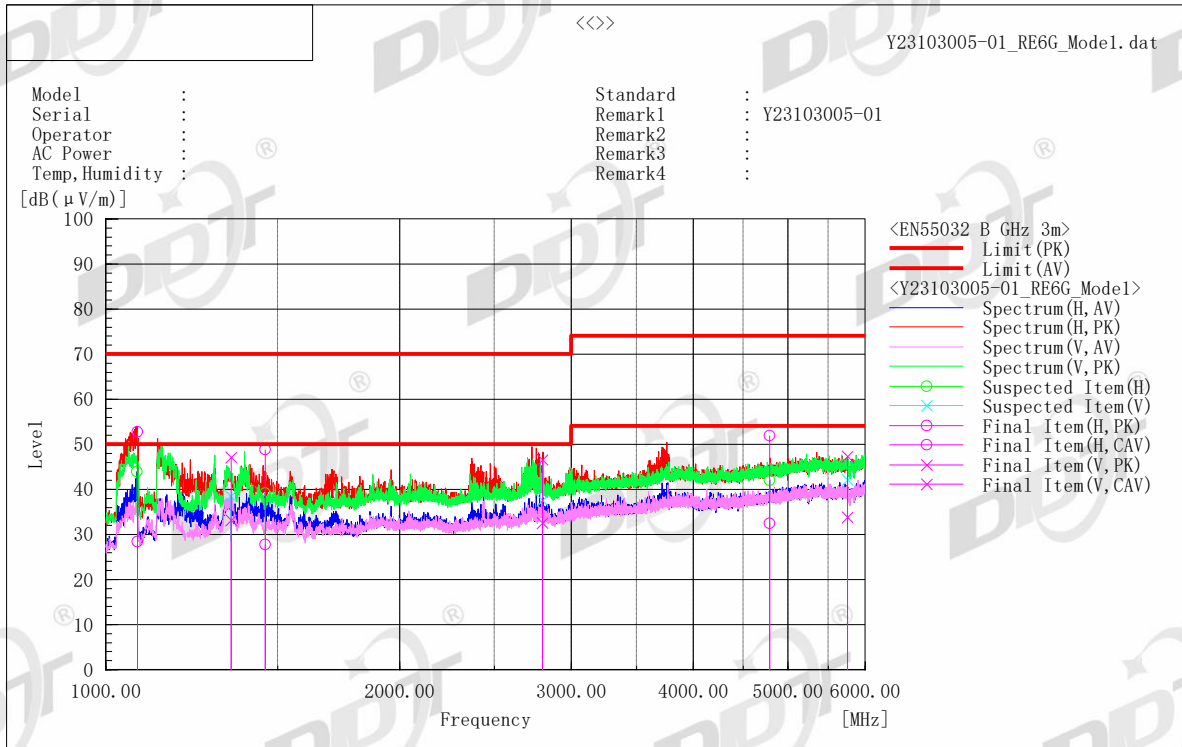

Final Result

No.	Frequency [MHz]	(P)	Reading PK [dB(µV)]	Reading CAV [dB(µV)]	c. f [dB(1/m)]	Result PK [dB(µV/m)]	Result CAV [dB(µV/m)]	Limit PK [dB(µV/m)]	Limit AV [dB(µV/m)]	Margin PK [dB]	Margin CAV [dB]	Height [cm]	Angle [°]	Remark
1	1077.204	H	78.5	54.1	-25.7	52.8	28.4	70.0	50.0	17.2	21.6	187.0	252.7	
2	1497.434	H	73.7	52.7	-24.9	48.8	27.8	70.0	50.0	21.2	22.2	143.0	98.1	
3	4789.681	H	66.7	47.3	-14.8	51.9	32.5	74.0	54.0	22.1	21.5	176.0	46.4	
4	1343.805	V	71.7	57.8	-24.6	47.1	33.2	70.0	50.0	22.9	16.8	128.0	153.0	
5	2800.184	V	67.5	53.5	-20.9	46.6	32.6	70.0	50.0	23.4	17.4	134.0	158.9	
6	5765.359	V	60.1	46.6	-12.8	47.3	33.8	74.0	54.0	26.7	20.2	112.0	8.5	

Note for test result

Note1): According pre-test, the worst test modes decided as below and reported. Only data of worst mode was reported in test result.

Note2) (P) : Abbreviation of Antenna Polarity

Note3) Reading PK / C/AV: Received raw Peak / C/Average signal

Note4) Level PK / C/AV = Reading PK / C/AV + Factor, Real signal Peak / C/Average level

Note5) Factor = Antenna factor + Cable loss – Amplifier gain

Note6) Margin PK / C/AV = Limit – Level PK / C/AV

6 Harmonic Current Emissions

6.1 General Information

Test date	Nov. 28, 2023	Test engineer	Sam Zhao	
Climate condition	Ambient temperature	23.1°C	Relative humidity	28.2%
	Atmospheric pressure	101.3kPa		
Test place	Shield Room 2#			

6.2 Test Equipment

Equipment	Manufacturer	Model No.	Serial No.	Last Cal.	Cal. Interval
High Performance Linear AC power sources	Pacific Power Source	360-AMX	1235	Feb. 15, 2023	1 Year
High Performance Linear AC power sources	Pacific Power Source	360-AMX	1234	Feb. 15, 2023	1 Year
IEC Reference Impedance Network	Voltech	IEC61000-3	IG164/2021	Nov. 16, 2023	1 Year
Harmonics and Flicker Analyzer	Newtons4th Ltd	PPA5511	162-04584	Nov. 16, 2023	1 Year
Test Software	N4L	IEC Soft	Ver 2.4e	N/A	N/A

6.3 Reference Standard

EN 61000-3-2:2014,
EN IEC 61000-3-2:2019/A1:2021

6.4 Test Arrangement

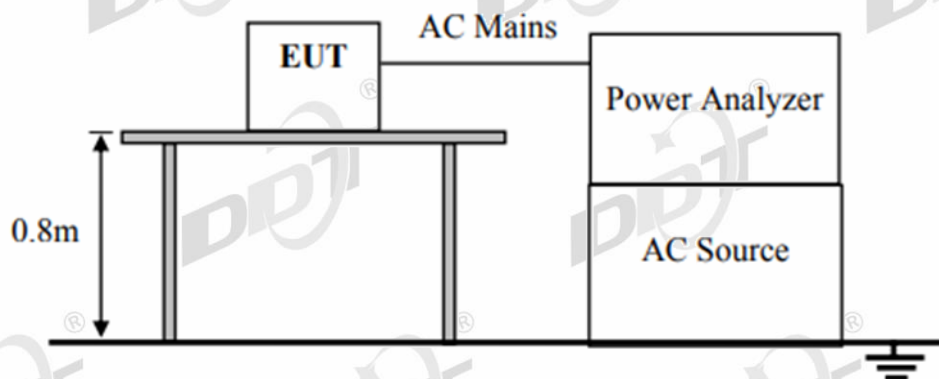

6.5 Test Specification and Limit

Limits for Class D equipment

Harmonic order	Maximum permissible harmonic current per watt	Maximum permissible harmonic current
n	mA/W	A
3	3.4	2.30
5	1.9	1.14
7	1.0	0.77
9	0.5	0.40
11	0.35	0.33
$13 \leq n \leq 39$ (odd harmonics only)	3.85/n	See Table 1

6.6 Test Result

Sample No.	Operation Mode	Remarks	Result
Y23103005-01	Mode 1	Rated Power < 75W	N/A

Test Settings		
Class	Class D	
Mode	Measure	
Equipment Under Test		
Brand	N/A	
Model	Y23103005-01	
Serial	N/A	
Impedance Network ID	N/A	
Test Conditions		
	User Entered	Measured
Rated Voltage	230.000 V	231.118 V
Rated Current	N/A	402.032 mA
Rated Frequency	50.000 Hz	50.000 Hz
Rated Power	N/A	43.473 W
Additional Test Information		
Measured Power Factor	0.4679	
Max Current THD	178.45%	
Max THC	0.3508A	
Max Power	43.485 W	
Max F.Current	196.740 mA	
Average F.Current	196.643 mA	
Minimum Current	100mA	
Test Duration	2.5 minutes	
Additional Test Details		
Operator	N/A	
Lab Name	N/A	
Location	N/A	
Notes		
Signature		
Results	Test – N/A. Rated Power < 75W	

7 Voltage Changes, Voltage Fluctuations and Flicker

7.1 General Information

Test date	Nov. 28, 2023	Test engineer	Sam Zhao	
Climate condition	Ambient temperature	23.1°C	Relative humidity	28.2%
	Atmospheric pressure	101.3kPa		
Test place	Shield Room 2#			

7.2 Test Equipment

Equipment	Manufacturer	Model No.	Serial No.	Last Cal.	Cal. Interval
High Performance Linear AC power sources	Pacific Power Source	360-AMX	1235	Feb. 15, 2023	1 Year
High Performance Linear AC power sources	Pacific Power Source	360-AMX	1234	Feb. 15, 2023	1 Year
IEC Reference Impedance Network	Voltech	IEC61000-3	IG164/2021	Nov. 16, 2023	1 Year
Harmonics and Flicker Analyzer	Newtons4th Ltd	PPA5511	162-04584	Nov. 16, 2023	1 Year
Test Software	N4L	IEC Soft	Ver 2.4e	N/A	N/A

7.3 Reference Standard

EN 61000-3-3:2013,
 EN 61000-3-3:2013/A1:2019,
 EN 61000-3-3:2013/A2:2021

7.4 Test Arrangement

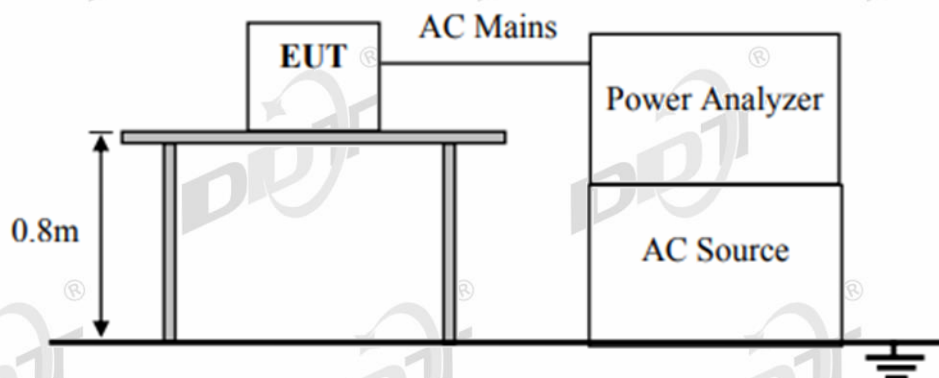

7.5 Test Specification and Limit

short-term flicker indicator, Pst	the relative steady-state voltage change, dc	the value of d(t) during a voltage change, d(t) >3.3 %	the maximum relative voltage change, dmax
1.0	3.3 %	500 ms	4 %

7.6 Test Result

Sample No.	Operation Mode	Remarks	Result
Y23103005-01	Mode 1	N/A	Pass

Test Settings		
Class	Voltage	
Mode	Normal - 4%	
Minimum Current	300mA	
PST	10.00 minutes	
PLT	1 PSTs	
Equipment Under Test		
Brand	N/A	
Model	Y23103005-01	
Serial	N/A	
Impedance Network ID	N/A	
Test Conditions		
	User Entered	Measured
Rated Voltage	230.000 V	231.069 V
Rated Current	N/A	N/A
Rated Frequency	50.000 Hz	50.000 Hz
Rated Power	N/A	N/A
D max	0.0537% (Limit: 4%)	
T max	0.0000 s (Limit: 0.5 s)	
DC max	0.0051% (Limit: 3.3%)	
Additional Test Details		
Operator	N/A	
Lab Name	N/A	
Location	N/A	
Notes		
Signature		
Results	Phase1: PASS	

8 Electrostatic Discharge Immunity

8.1 General Information

Test date	Nov. 30, 2023	Test engineer	Oliver Liu	
Climate condition	Ambient temperature	21.8°C	Relative humidity	31.8%
	Atmospheric pressure	103.4kPa		
Test place	Shield Room 3#			

8.2 Test Equipment

Equipment	Manufacturer	Model No.	Serial No.	Last Cal.	Cal. Interval
ESD Simulator	TESEQ	NSG 437	407	Jul. 12, 2023	1 Year
Discharge Network	TESEQ	INA 4380	0011	Jul. 12, 2023	1 Year

8.3 Reference Standard

EN 55035:2017,
EN 55035:2017/A11:2020,
IEC 61000-4-2:2008

8.4 Test Arrangement

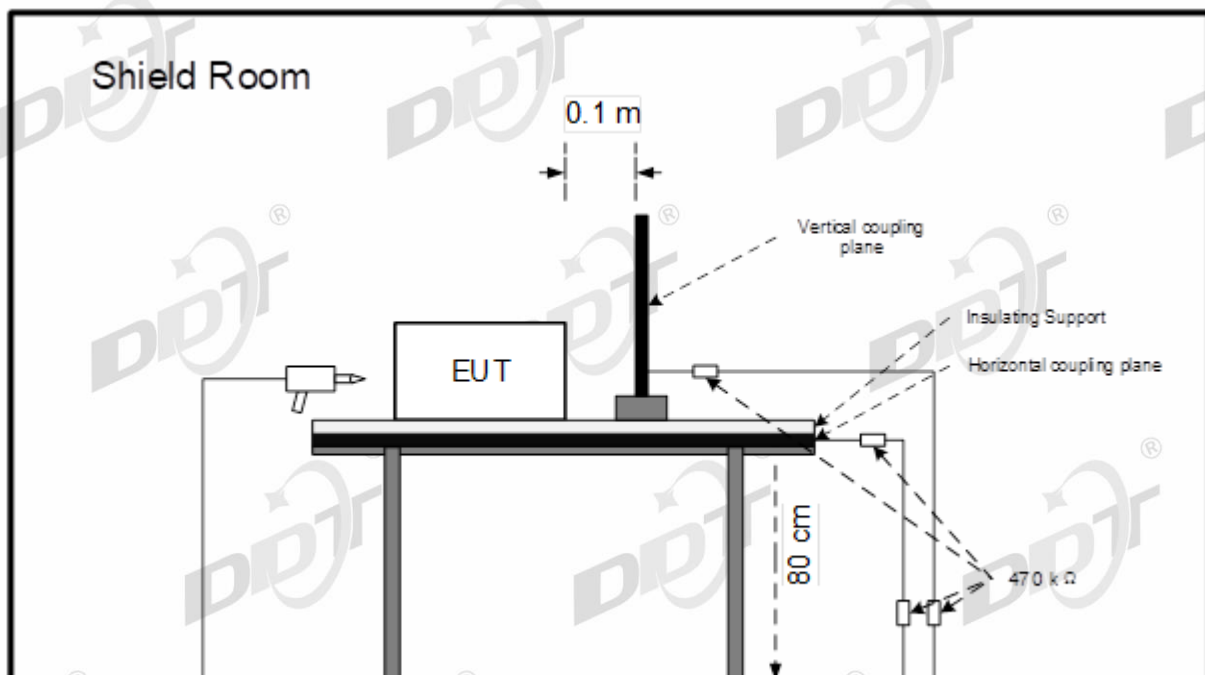

Air Discharge:

The test was applied on non-conductive surfaces of EUT. The round discharge tip of the discharge electrode was approached as fast as possible to touch the EUT. After each discharge, the discharge electrode was removed from the EUT. The generator was re-triggered for a new single discharge and repeated 20 times for each pre-selected test point. This procedure was repeated until all the air discharge completed.

Contact Discharge:

All the procedure was same as air discharge. Except that the generator was re-triggered for a new single discharge. The tip of the discharge electrode was touching the EUT before the discharge switch was operated.

Indirect discharge for horizontal coupling plane:

At least 20 single discharges were applied to the horizontal coupling plane, at points on each side of the EUT. The discharge electrode positions vertically at a distance of 0.1m from the EUT and with the discharge electrode touching the coupling plane.

Indirect discharge for vertical coupling plane:

At least 20 single discharges were applied to the center of one vertical edge of the coupling plane. The coupling plane, of dimensions 0.5m X 0.5m, was placed parallel to, and positioned at a distance of 0.1m from the EUT. Discharges were applied to the coupling plane, with this plane in sufficient different positions that the four faces of the EUT are completely illuminated.

8.5 Test Specification and Limit

Test Level		Performance Criteria
Air Discharge	±2kV, ±4kV, ±8kV	B
Contact Discharge	±4kV	

8.6 Test Result

Sample No. Y23103005-01						
Operation Mode	Discharge Method	Test Level	Test Point	Required	Observation	Result
Mode 1	Contact Discharge	±4 KV	9	B	B ⁽²⁾	Pass
Mode 1	Contact Discharge	±4 KV	Coupling Planes	B	A ⁽¹⁾	Pass
Mode 1	Air Discharge	±2 KV	1, 2, 3, 4, 5, 6, 7, 8	B	A ⁽¹⁾	Pass
Mode 1	Air Discharge	±4 KV	1, 2, 3, 4, 5, 6, 7, 8	B	A ⁽¹⁾	Pass
Mode 1	Air Discharge	±8 KV	1, 2, 3, 4, 5, 6, 7, 8	B	A ⁽¹⁾	Pass
Remark						
(1)	A: Operation as intend, no loss of function during test and after test.					
(2)	B: Temporary image flicker, when disturbance ceases, and recovers its normal performance, without operator intervention.					
Test Point						
No.	Description	No.	Description	No.	Description	
1	Panel	2	Button	3	Status Lamp	
4	HDMI 1 Port	5	HDMI 2 Port	6	DP Port	
7	Audio Port	8	Gap	9	Shield Cover	

Discharge Point Photo

Contact



Air

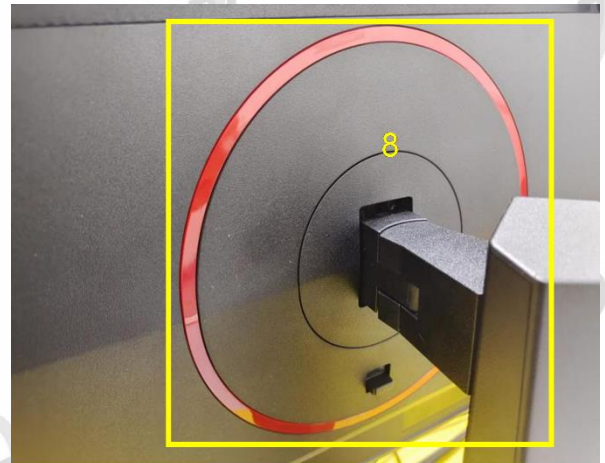
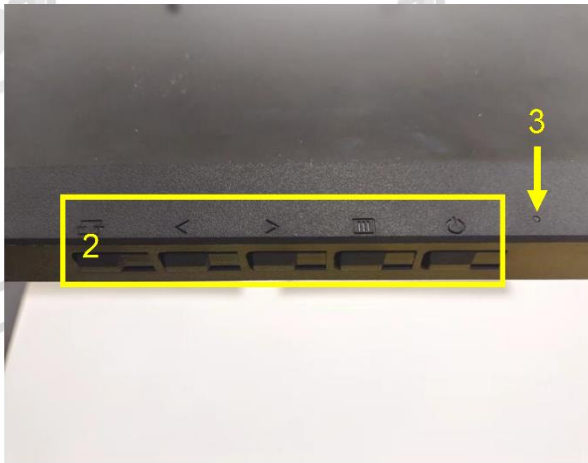
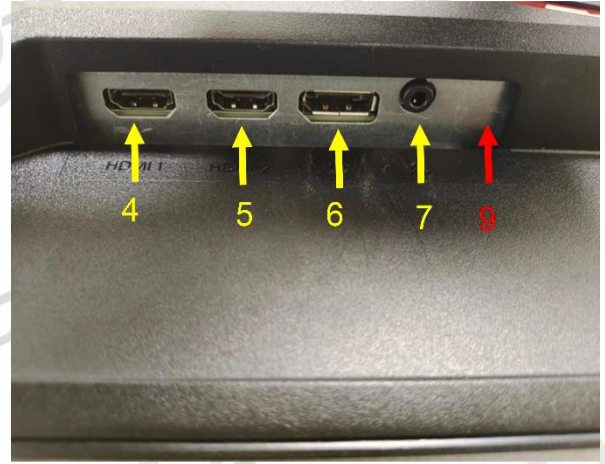

9 Radiated, Radio-frequency, Electromagnetic Field Immunity

9.1 General Information

Test date	Nov. 28, 2023	Test engineer	Joye Cao	
Climate condition	Ambient temperature	22.3°C	Relative humidity	36.1%
	Atmospheric pressure	101.1kPa		
Test place	3m Chamber 1#			

9.2 Test Equipment

Equipment	Manufacturer	Model No.	Serial No.	Last Cal.	Cal. Interval
Power Meter	Rohde & Schwarz	NRP	102424	Feb. 15, 2023	1 Year
Average Power Sensor	Rohde & Schwarz	NRP-Z91	100937	Feb. 15, 2023	1 Year
Average Power Sensor	Rohde & Schwarz	NRP-Z91	100938	Feb. 15, 2023	1 Year
Audio Analyzer	Rohde & Schwarz	UPV	101525	Feb. 15, 2023	1 Year
Stacked Logarithmic-Periodic Broadband Antenna	SCHWARZBECK	STLP 9149	9149-059	N/A	N/A
Microwave Signal Generator	Rohde & Schwarz	SMB100A	104909	Feb. 15, 2023	1 Year
Special - Stacked Log Periodic Antenna	SCHWARZBECK	STLP 9128 E special	9128ES-171	N/A	N/A
RF Switch for Radiated	SKET	RS_DC06G-AMC-3C	SK2020081901	N/A	N/A
Power Amplifier	SKET	HAP_01G032G-250W	202104178	Aug. 02, 2023	1 Year
Power Amplifier	SKET	HAP_03G06G-75W	SK202106221	Aug. 22, 2023	1 Year
Power Amplifier(Combiner)	SKET	HAP_80M200M/200M1G-2000/1000W	202102154	Aug. 02, 2023	1 Year
Test Software	SKET	EMC-S	V2.1.3.43	N/A	N/A

9.3 Reference Standard

EN 55035:2017,
EN 55035:2017/A11:2020,
IEC 61000-4-3:2020

9.4 Test Arrangement

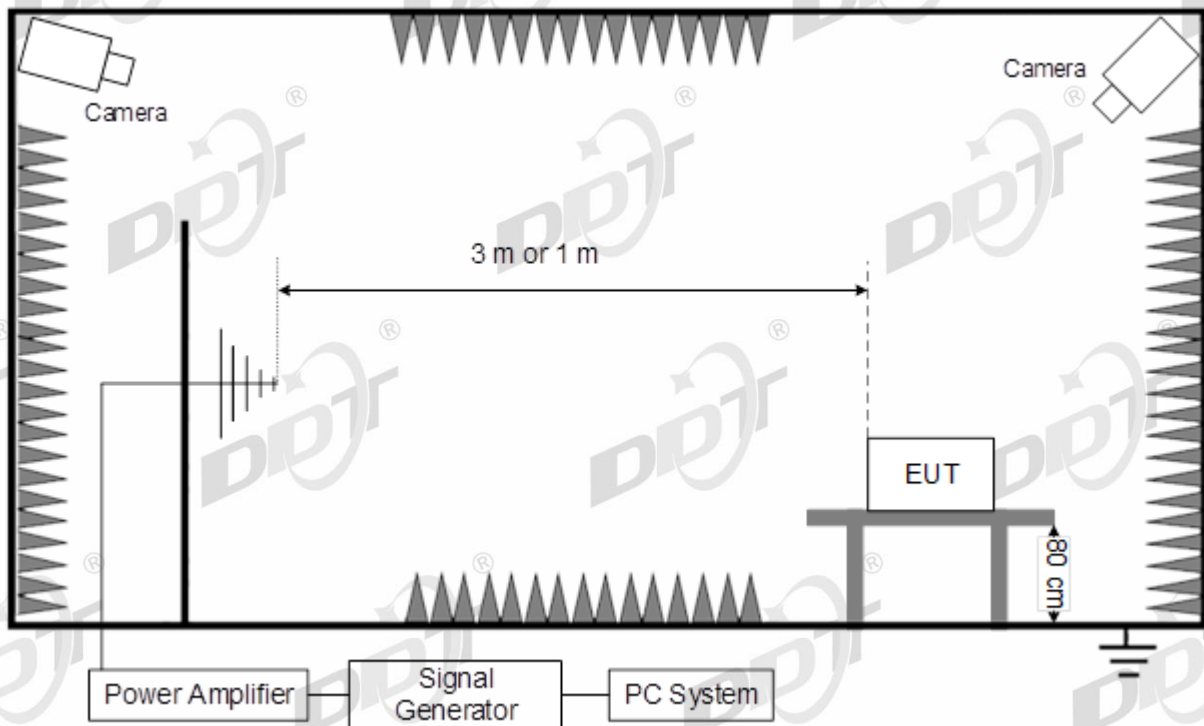

The EUT is initially placed with one face coincident with the calibration plane. The EUT face being illuminated shall be contained within the UFA unless partial illumination is being applied.

The frequency ranges to be considered are swept with the signal modulated, pausing to adjust the RF signal level or to switch oscillators and antennas as necessary.

Where the frequency range is swept incrementally, the step size shall not exceed 1 % of the preceding frequency value.

The dwell time of the amplitude modulated carrier at each frequency shall not be less than the time necessary for the EUT to be exercised and to respond, but shall in no case be less than 0,5 s. The sensitive frequencies (e.g., clock frequencies) shall be analyzed separately according to the requirements in product standards.

The test shall normally be performed with the generating antenna facing each side of the EUT.

When equipment can be used in different orientations (i.e. vertical or horizontal) all sides shall be exposed to the field during the test. When technically justified, some EUTs can be tested by exposing fewer faces to the generating antenna. In other cases, as determined for example by the type and size of EUT or the frequencies of test, more than four azimuths may need to be exposed.

The polarization of the field generated by each antenna necessitates testing each selected side twice, once with the antenna positioned vertically and again with the antenna positioned horizontally.

9.5 Test Specification and Limit

Swept frequency test		Performance Criteria
Frequency (MHz)	80 to 1000	A
Field Strength	3V/m rms voltage level of the unmodulated signal	
Modulation	AM modulated to a depth of 80% by a sine wave of 1kHz (note 1)	
Step Size	1% increments	
Dwell time	< 5 Sec.	

Spot frequency test		Performance Criteria
Frequency (MHz)	1800, 2600, 3500, 5000	A
Field Strength	3V/m rms voltage level of the unmodulated signal	
Modulation	AM modulated to a depth of 80% by a sine wave of 1kHz (note 1)	
Dwell time	< 5 Sec.	

Note 1: The 1kHz modulation may be replaced by a different audio modulation frequency more appropriate for a given EUT if, for example, 1kHz is not within the operating audio range of the EUT.

For audio output function (if applied):

Performance criterion A

During the test the audio output function shall be maintained. The measured acoustic interference ratio and/or the measured electrical interference ratio during the test shall be -20 dB or better.

9.6 Test Result

Sample No. Y23103005-01						
Steps: 1%		Dwell time: 1s		Modulation: 1KHz 80% AM		
Operation Mode	EUT Position	Antenna: Horizontal		Antenna: Vertical		Result
		Required	Observation	Required	Observation	
Mode 1	Front side	A	A ⁽¹⁾	A	A ⁽¹⁾	Pass
Mode 1	Back side	A	A ⁽¹⁾	A	A ⁽¹⁾	Pass
Mode 1	Left side	A	A ⁽¹⁾	A	A ⁽¹⁾	Pass
Mode 1	Right side	A	A ⁽¹⁾	A	A ⁽¹⁾	Pass
Remark						
(1) A: Operation as intend, no loss of function during test and after test.						

Audio output function result: <input type="checkbox"/> this device without audio output function.			
Method	Port	Acoustic interference ratio L1-L0 (dB) Required: ≤-20dB	Result
√acoustic measurement	Speaker	-36.81	Pass
√electrical measurement	Audio out	-39.31	Pass

10 Electrical Fast Transient/Burst Immunity

10.1 General Information

Test date	Nov. 30, 2023	Test engineer	Oliver Liu	
Climate condition	Ambient temperature	21.8°C	Relative humidity	31.8%
	Atmospheric pressure	103.4kPa		
Test place	Shield Room 3#			

10.2 Test Equipment

Equipment	Manufacturer	Model No.	Serial No.	Last Cal.	Cal. Interval
Automated single phase Coupling/Decoupling Networks	TESEQ	CDN 3061	210	Feb. 15, 2023	1 Year
Multifunction Generator Systems	TESEQ	NSG 3060	1338	Feb. 15, 2023	1 Year

10.3 Reference Standard

EN 55035:2017,
EN 55035:2017/A11:2020,
IEC 61000-4-4:2012

10.4 Test Arrangement

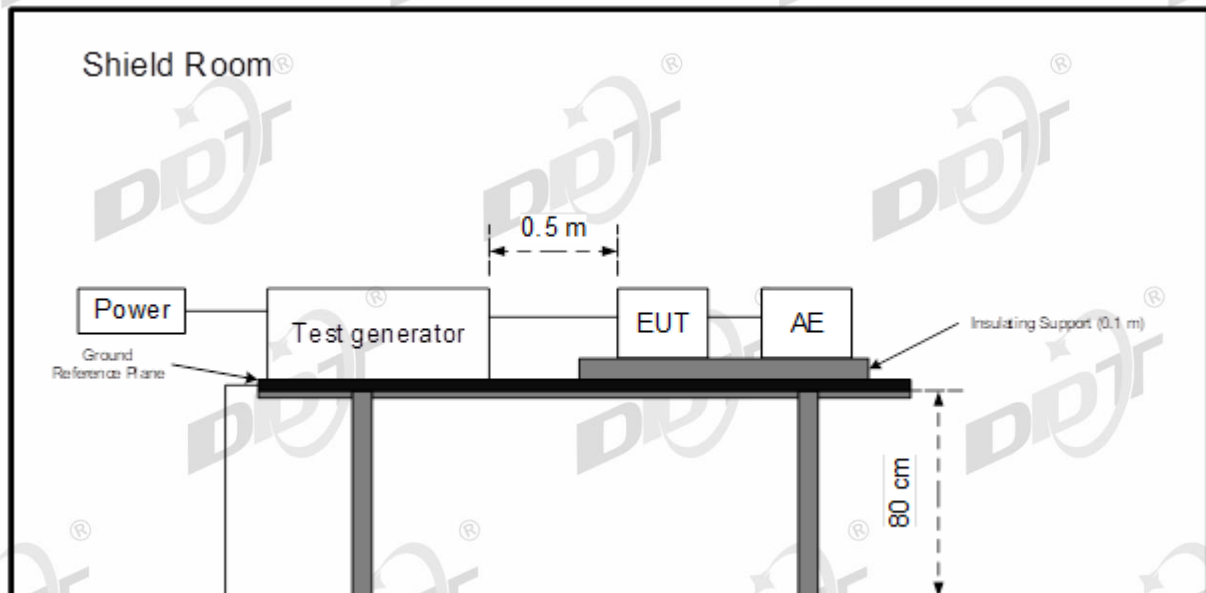

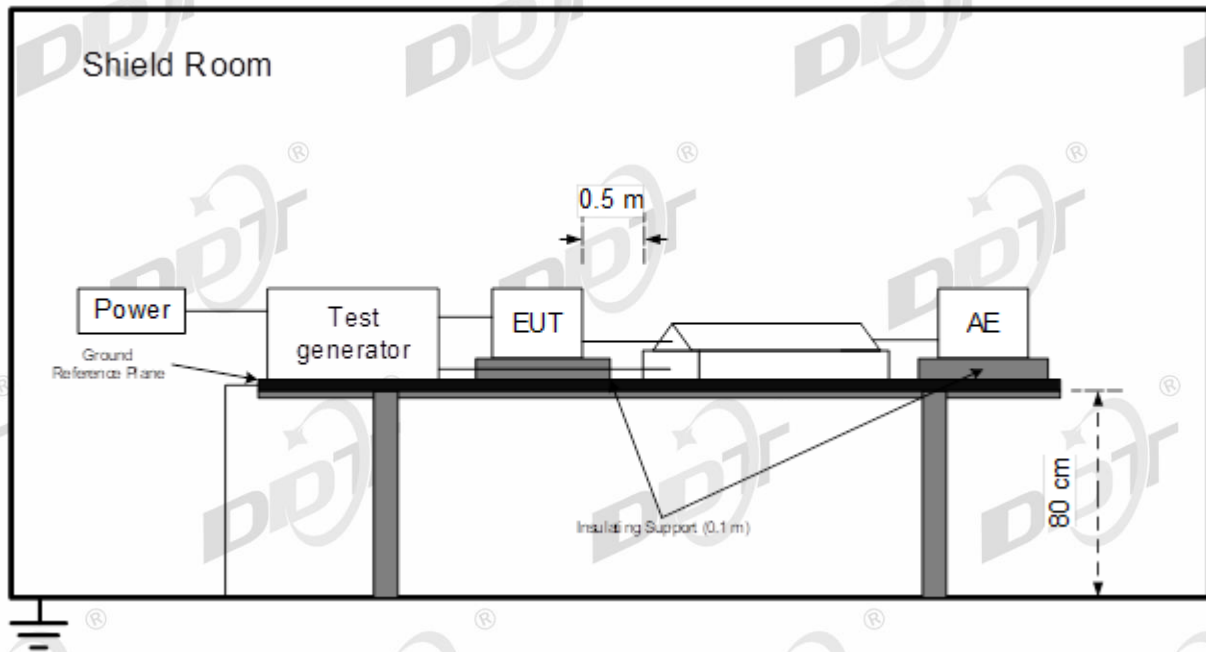

The EUT and its simulators were placed on the ground reference plane and were insulated from it by an insulating support $0.1\text{m} \pm 0.01\text{m}$ thick.

The minimum distance between the EUT and all other conductive structures (e.g. the walls of a shielded room), except the ground reference plane shall be more than 0,5 m.

All cables to the EUT shall be placed on the insulation support 0,1 m above the ground reference plane. Cables not subject to electrical fast transients shall be routed as far as possible from the cable under test to minimize the coupling between the cables.

10.5 Test Specification and Limit

Test Level		Performance Criteria
Test voltage	$\pm 1\text{kV}$ For AC mains Port	$\pm 0.5\text{kV}$ for DC input or signal Port
Repetition Frequency	5kHz	5kHz
Burst Duration	15ms	15ms
Burst Period	300ms	300ms
Inject Time(s)	120s	120s
Inject Method	Direct for AC mains port	Direct for signal port Direct for dc input port
Inject Line	AC Mains of adapter	DC input of adapter or Capacitive coupling clamp

Note: This test shall be additionally performed on analogue/digital data ports, and DC network power ports, of radio equipment and associated ancillary equipment, if the cables may be longer than 3 m.

10.6 Test Result

Sample No. Y23103005-01						
Injected Port	AC Mains		Coupling	Direct		
Burst Period:	300ms		Test Time:	120s		
Repetition Frequency	5KHz		Burst Durations	15ms		
Operation Mode	Line	Test Voltage	Required	Observation		Result
				Positive	Negative	
Mode 1	L	±1kV	B	A ⁽¹⁾	A ⁽¹⁾	Pass
Mode 1	N	±1kV	B	A ⁽¹⁾	A ⁽¹⁾	Pass
Mode 1	PE	±1kV	B	A ⁽¹⁾	A ⁽¹⁾	Pass
Mode 1	L-N	±1kV	B	A ⁽¹⁾	A ⁽¹⁾	Pass
Mode 1	L-PE	±1kV	B	A ⁽¹⁾	A ⁽¹⁾	Pass
Mode 1	N-PE	±1kV	B	A ⁽¹⁾	A ⁽¹⁾	Pass
Mode 1	L-N-PE	±1kV	B	A ⁽¹⁾	A ⁽¹⁾	Pass
Remark						
(1)	A: Operation as intend, no loss of function during test and after test.					

11 Surge Immunity

11.1 General Information

Test date	Nov. 30, 2023	Test engineer	Oliver Liu	
Climate condition	Ambient temperature	21.8°C	Relative humidity	31.8%
	Atmospheric pressure	103.4kPa		
Test place	Shield Room 3#			

11.2 Test Equipment

Equipment	Manufacturer	Model No.	Serial No.	Last Cal.	Cal. Interval
Automated single phase Coupling/Decoupling Networks	TESEQ	CDN 3061	210	Feb. 15, 2023	1 Year
Multifunction Generator Systems	TESEQ	NSG 3060	1338	Feb. 15, 2023	1 Year

11.3 Reference Standard

EN 55035:2017,
EN 55035:2017/A11:2020,
IEC 61000-4-5:2014/AMD1:2017

11.4 Test Arrangement

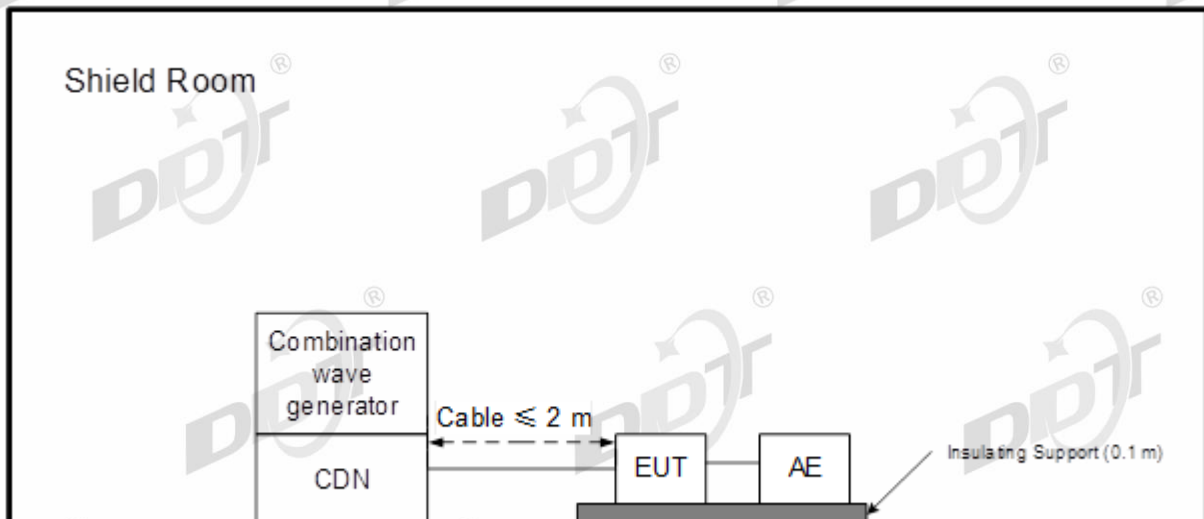

EUT should be configured in representative operating conditions.

At least 5 positive and 5 negative (polarity) tests with a maximum 1/min repetition rate are applied during test.

Different phase angles are done individually, if applied.

Record the EUT operating situation during compliance test and decide the EUT immunity criterion for above each test.

11.5 Test Specification and Limit

Test level for AC mains ports		Performance Criterion
Line to Line	1kV 1.2/50(8/20) μ s	B
Line to Ground	2kV 1.2/50(8/20) μ s	B
Analogue/digital data port, Port type: unshielded symmetrical		Performance Criterion
Line to Ground	1 kV and 4kV 10/700(5/320) μ s (used with the primary protection)	C
Line to Ground	1 kV 10/700(5/320) μ s (used without the primary protection)	C
Note: Applicable only to ports which, according to the manufacturer's specification, the cable lengths greater than 3m.		
Analogue/digital data port, Port type: coaxial or shielded		Performance Criterion
Shield to ground	0.5 kV 1.2/50(8/20) μ s	B
Note: Applicable only to ports which, according to the manufacturer's specification, the cable lengths greater than 3m.		
DC network power port		Performance Criterion
Line to reference ground	0.5 kV 1.2/50(8/20) μ s	B
<p>Note: Applicable only to ports which, according to the manufacturer's specification,</p> <p>(1) The cable lengths greater than 3m;</p> <p>(2) May connect directly to outdoor cables.</p> <p>(3) Where the surge coupling network for the 10/700 (5/320) μs waveform affects the functioning of high speed data ports, the test shall be carried out using a 1,2/50 (8/20) μs waveform and appropriate coupling network.</p> <p>(4) The number of pulses applied shall be as follows:</p> <p>Five positive pulses line-to-neutral at 90° phase</p> <p>Five negative pulses line-to-neutral at 270° phase</p> <p>The following additional pulses are required only if the EUT has an earth connection or if the EUT is earthed via any AE.</p> <p>Five positive pulses line-to-earth at 90° phase</p> <p>Five negative pulses line-to-earth at 270° phase</p> <p>Five negative pulses neutral-to-earth at 90° phase</p> <p>Five positive pulses neutral-to-earth at 270° phase</p>		

11.6 Test Result

Sample No. Y23103005-01						
Injected Port	AC Mains		Wave Type	1.2/50us-8/20us		
Pulse Interval	60s		Pulse times:	5 times at each polarity		
Operation Mode	Coupling Line	Level	Required	Observation		Result
				Positive	Negative	
Mode 1	L-N	±0.5kV	B	A ⁽¹⁾	A ⁽¹⁾	Pass
Mode 1	L-N	±1kV	B	A ⁽¹⁾	A ⁽¹⁾	Pass
Mode 1	L-PE	±0.5kV	B	A ⁽¹⁾	A ⁽¹⁾	Pass
Mode 1	L-PE	±1kV	B	A ⁽¹⁾	A ⁽¹⁾	Pass
Mode 1	L-PE	±2kV	B	A ⁽¹⁾	A ⁽¹⁾	Pass
Mode 1	N-PE	±0.5kV	B	A ⁽¹⁾	A ⁽¹⁾	Pass
Mode 1	N-PE	±1kV	B	A ⁽¹⁾	A ⁽¹⁾	Pass
Mode 1	N-PE	±2kV	B	A ⁽¹⁾	A ⁽¹⁾	Pass
Remark						
(1)	A: Operation as intend, no loss of function during test and after test.					

12 Immunity to Conducted Disturbances, Induced by Radio-frequency Fields

12.1 General Information

Test date	Nov. 30, 2023		Test engineer	Oliver Liu	
Climate condition	Ambient temperature	21.8°C	Relative humidity	31.8%	
	Atmospheric pressure	103.4kPa			
Test place	Shield Room 3#				

12.2 Test Equipment

Equipment	Manufacturer	Model No.	Serial No.	Last Cal.	Cal. Interval
Audio Analyzer	Rohde & Schwarz	UPV	101525	Feb. 15, 2023	1 Year
Microwave Signal Generator	Rohde & Schwarz	SMB100A	103231	Feb. 15, 2023	1 Year
COUPLING / DECOUPLING NETWORK	TESEQ	CDN M016	28987	Feb. 15, 2023	1 Year
RF Power Amplifiers	AR	75A250A	0332892	Feb. 15, 2023	1 Year
Directional Coupler	AR	DC2600M2	0333399	Feb. 15, 2023	1 Year
Power Meter	Rohde & Schwarz	NRVS	101785	Feb. 16, 2023	1 Year
Coaxial voltage measurement probe	Rohde & Schwarz	URV5-Z4	100215	Feb. 16, 2023	1 Year
COUPLING / DECOUPLING NETWORK	TESEQ	CDN M016	30436	Feb. 15, 2023	1 Year
Bi-Directional RF Attenuators	Bird	75-A-FFN-06	0751	N/A	N/A
Test Software	Rohde & Schwarz	EMC32	Ver 10.28.00	N/A	N/A

12.3 Reference Standard

EN 55035:2017,
EN 55035:2017/A11:2020,
IEC 61000-4-6:2013

12.4 Test Arrangement

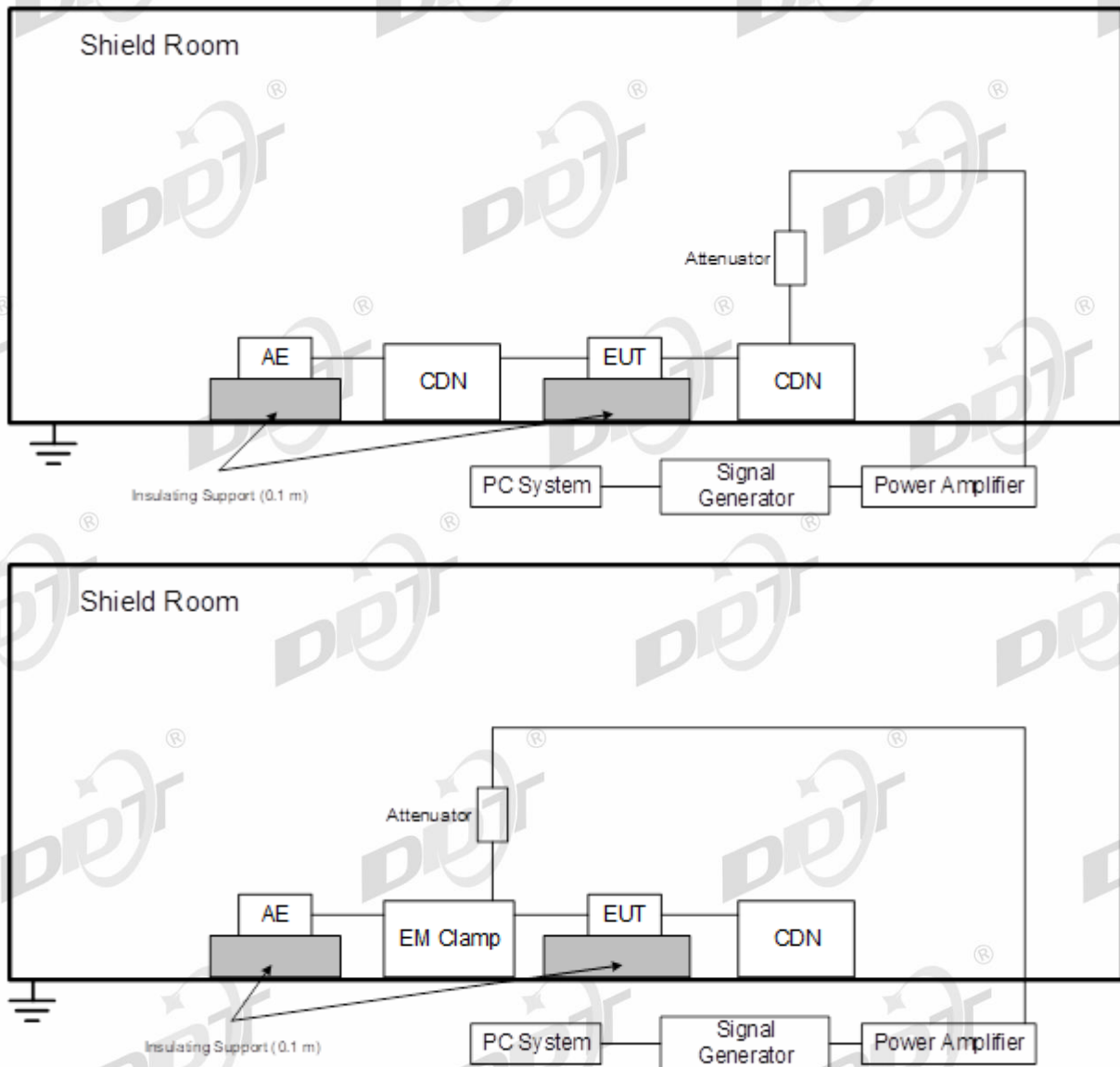

The EUT are placed on an insulating support 0.1m high above a ground reference plane. CDN (coupling and decoupling device) is placed on the ground plane at a distance 0.1 m to 0.3 m from EUT. Cables between CDN and EUT are as short as possible, and their height above the ground reference plane shall be at least 30 mm.

The disturbance signal described below is injected to EUT through CDN.

The EUT operates within its operational mode(s).

Recording the EUT operating situation during compliance testing and decide the EUT immunity criterion.

12.5 Test Specification and Limit

Test Level		Performance Criteria
Frequency and Field Strength	0.15MHz to 10MHz, 3V rms voltage level of the unmodulated signal	A
	10MHz to 30MHz, 3V to 1V rms voltage level of the unmodulated signal	
	30MHz to 80MHz, 1V rms voltage level of the unmodulated signal	
Modulation	AM modulated to a depth of 80% by a sine wave of 1kHz, (note 1)	
Step Size	1% increments	
Dwell time	< 5 Sec.	

Note 1: The 1kHz modulation may be replaced by a different audio modulation frequency more appropriate for a given EUT if, for example, 1kHz is not within the operating audio range of the EUT.

For audio output function (if applied):

Performance criterion A

During the test the audio output function shall be maintained. The measured acoustic interference ratio and/or the measured electrical interference ratio during the test shall be -20 dB or better.

12.6 Test Result

Sample No. Y23103005-01						
Steps: 1%		Dwell time: 1s		Modulation: 1KHz 80% AM		
Operation mode	Frequency Range	Injected Position	Level	Required	Observation	Result
Mode 1	0.15MHz ~ 10MHz	AC Mains	3V	A	A ⁽¹⁾	Pass
Mode 1	10MHz ~ 30MHz	AC Mains	3V ~ 1V	A	A ⁽¹⁾	Pass
Mode 1	30MHz ~ 80MHz	AC Mains	1V	A	A ⁽¹⁾	Pass
Remark						
(1) A: Operation as intend, no loss of function during test and after test.						

Audio output function result: <input type="checkbox"/> this device without audio output function.			
Method	Port	Acoustic interference ratio L1-L0 (dB) Required: ≤-20dB	Result
√acoustic measurement	Speaker	-36.05	Pass
√electrical measurement	Audio Out	-37.31	Pass

13 Power Frequency Magnetic Field Immunity

13.1 General Information

Test date	Nov. 30, 2023	Test engineer	Oliver Liu	
Climate condition	Ambient temperature	21.8°C	Relative humidity	31.8%
	Atmospheric pressure	103.4kPa		
Test place	Shield Room 3#			

13.2 Test Equipment

Equipment	Manufacturer	Model No.	Serial No.	Last Cal.	Cal. Interval
Automatic Power Line Frequency Magnetic Field Generator	TESEQ	MFO 6502	123	Feb. 16, 2023	1 Year
Multifunction Generator Systems	TESEQ	NSG 3060	1338	Feb. 15, 2023	1 Year
Automated single phase Coupling/Decoupling Networks	TESEQ	CDN 3061	210	Feb. 15, 2023	1 Year
Magnetic Field Coil	TESEQ	INA 702	199	Feb. 16, 2023	1 Year

13.3 Reference Standard

EN 55035:2017,
EN 55035:2017/A11:2020,
IEC 61000-4-8:2009

13.4 Test Arrangement

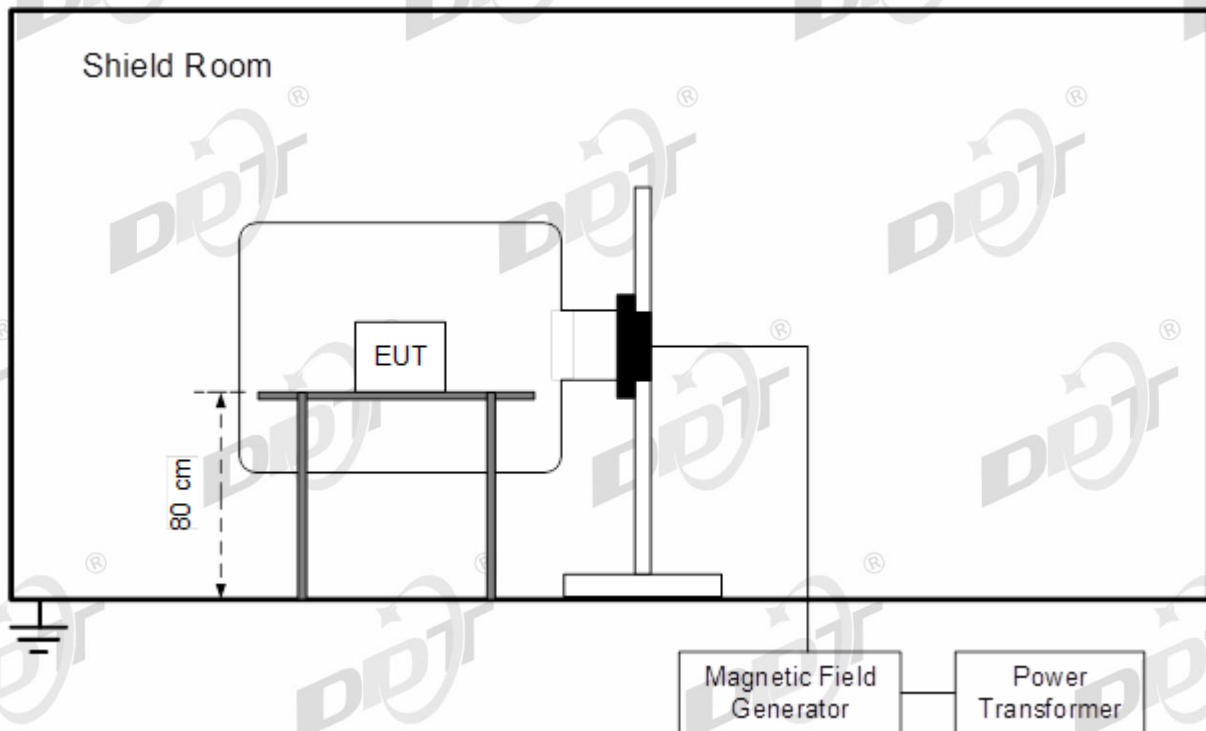

The EUT shall be subjected to the test magnetic field by using the induction coil of standard dimensions (1m*1m). Then induction coil shall then be rotated by 90° in order to expose the EUT to the test field with different orientations.

13.5 Test Specification and Limit

Magnetic Field Strength (A/m)	Performance Criterion
1	A

13.6 Test Result

Sample No. Y23103005-01					
Operation Mode	Test Level	Coil Orientation	Required	Observation	Result
Mode 1	1A/m	X	A	A ⁽¹⁾	Pass
Mode 1	1A/m	Y	A	A ⁽¹⁾	Pass
Mode 1	1A/m	Z	A	A ⁽¹⁾	Pass
Remark					
(1)	A: Operation as intend, no loss of function during test and after test.				

14 Voltage Dips, Short Interruptions and Voltage Variations Immunity

14.1 General Information

Test date	Nov. 30, 2023	Test engineer	Oliver Liu	
Climate condition	Ambient temperature	21.8°C	Relative humidity	31.8%
	Atmospheric pressure	103.4kPa		
Test place	Shield Room 3#			

14.2 Test Equipment

Equipment	Manufacturer	Model No.	Serial No.	Last Cal.	Cal. Interval
Automated single phase Coupling/Decoupling Networks	TESEQ	CDN 3061	210	Feb. 15, 2023	1 Year
Motorized single phase variac	TESEQ	VAR 3005-D16	094	Feb. 15, 2023	1 Year
Multifunction Generator Systems	TESEQ	NSG 3060	1338	Feb. 15, 2023	1 Year

14.3 Reference Standard

EN 55035:2017,
EN 55035:2017/A11:2020,
IEC 61000-4-11:2020

14.4 Test Arrangement

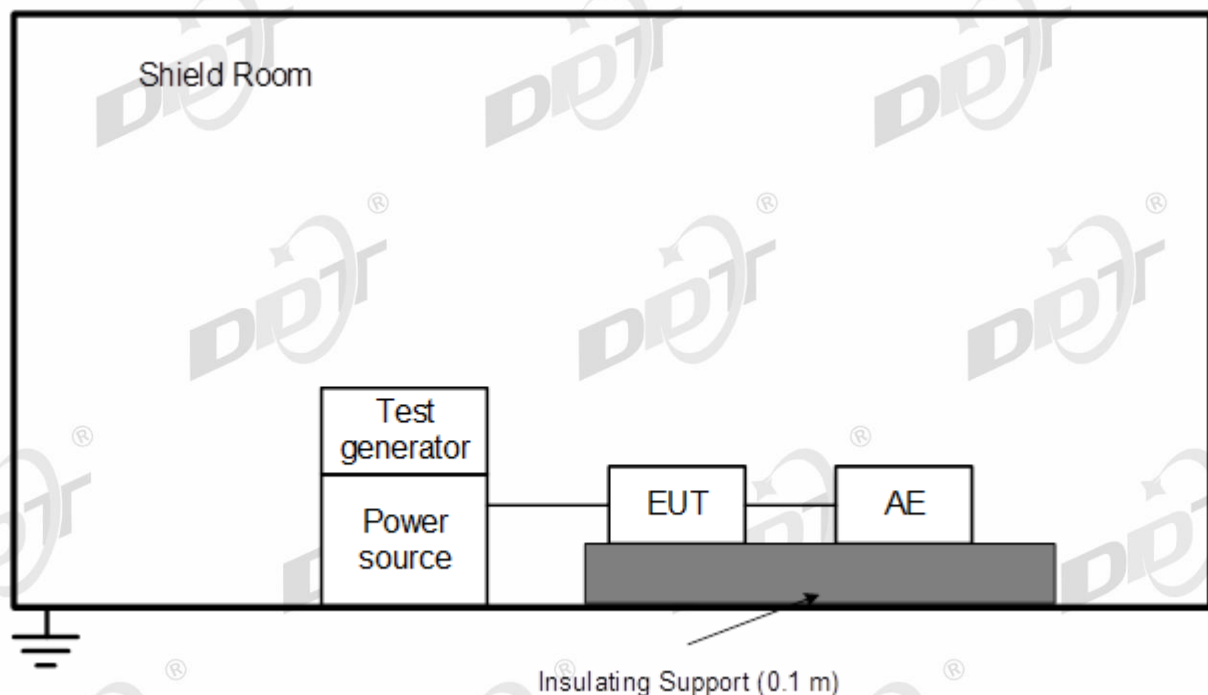

The EUT and test generator were setup as shown. The interruptions are introduced at selected phase angles with specified duration. Record any degradation of performance.

14.5 Test Specification and Limit

Test Level %UT	Duration (in period)	Performance Criterion
<5	0.5	B
70	25 for 50Hz/30 for 60Hz	C
<5	250 for 50Hz/300 for 60Hz	C

14.6 Test Result

Sample No. Y23103005-01							
Operation Mode	Operation Voltage	%Ur	Duration (in period)	Phase Angle	Required	Observation	Result
Mode 1	100V 60Hz	0	0.5P	0°,180°	B	A ⁽¹⁾	Pass
Mode 1	100V 60Hz	70	30P	0°,180°	C	A ⁽¹⁾	Pass
Mode 1	100V 60Hz	0	300P	0°,180°	C	B ⁽²⁾	Pass
Mode 1	240V 50Hz	0	0.5P	0°,180°	B	A ⁽¹⁾	Pass
Mode 1	240V 50Hz	70	25P	0°,180°	C	A ⁽¹⁾	Pass
Mode 1	240V 50Hz	0	250P	0°,180°	C	B ⁽²⁾	Pass
Remark							
(1)	A: Operation as intend, no loss of function during test and after test.						
(2)	B: Temporary loss of function or degradation of performance which ceases after the disturbance ceases, and from which the equipment under test recovers its normal performance, without operator intervention.						

Annex A. Test Setup Photos

A.1 Conducted Emissions (AC mains power ports)



A.2 Radiated Emissions (30MHz to 1GHz)



A.3 Radiated Emissions (Above 1GHz)



A.4 Harmonic Current Emissions



A.5 Voltage Changes, Voltage Fluctuations and Flicker



A.6 Electrostatic Discharge Immunity

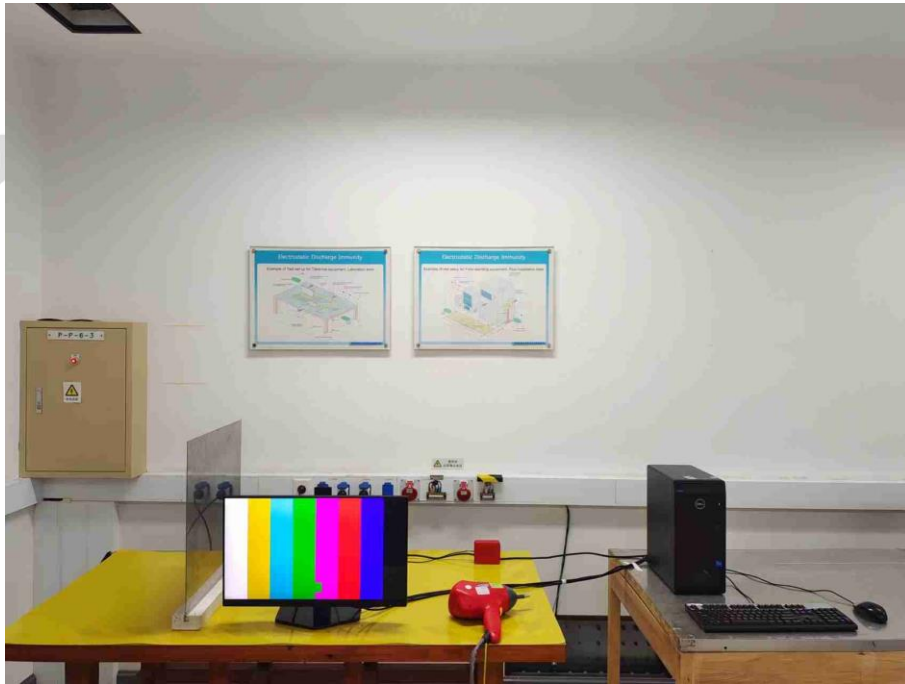

A.7 Radiated, Radio-frequency, Electromagnetic Field Immunity

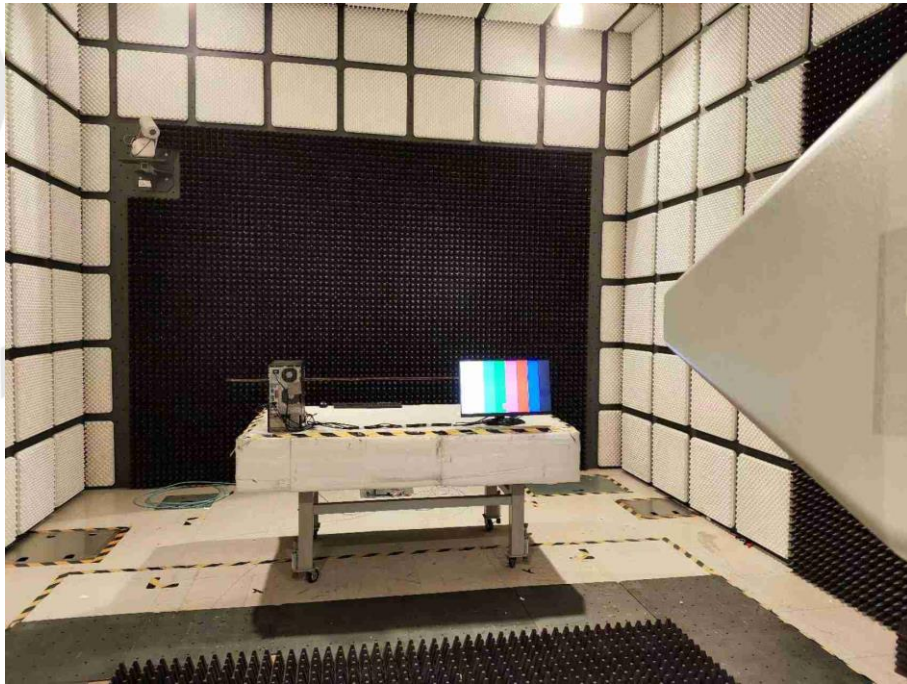

A.8 Electrical Fast Transient/Burst Immunity

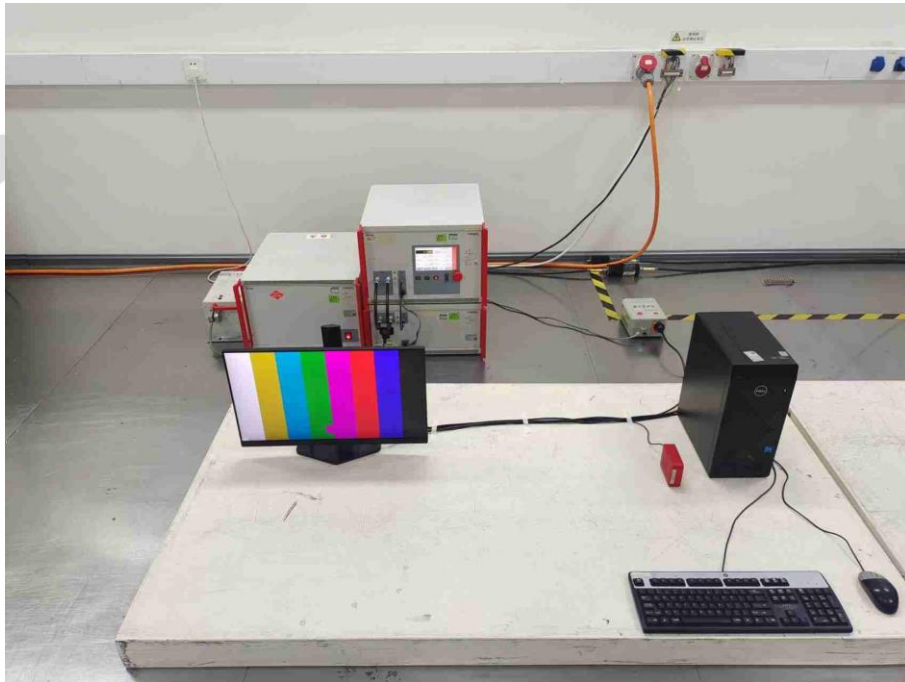

A.9 Surge Immunity

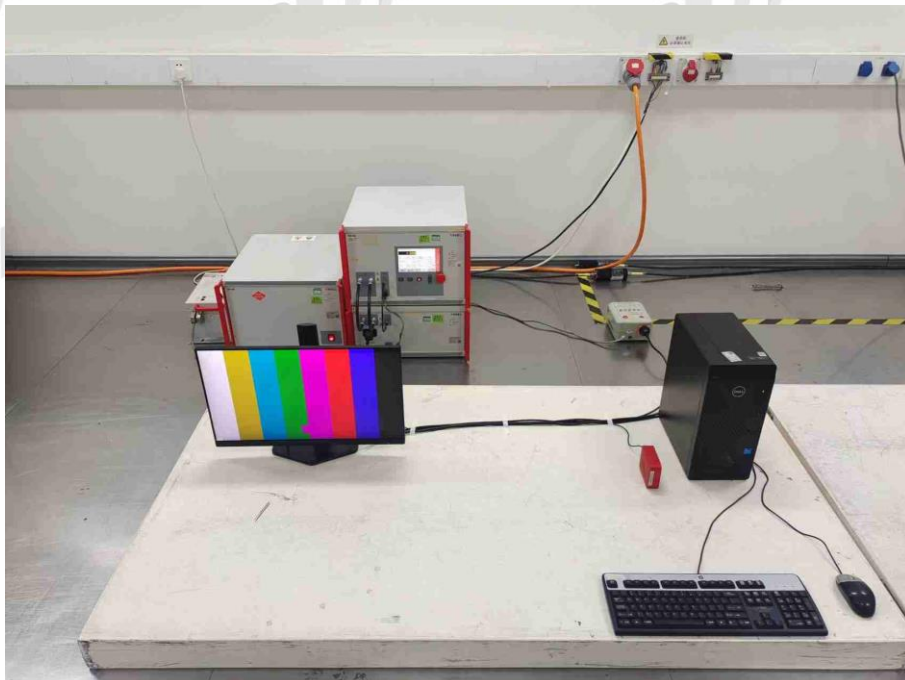

A.10 Immunity to Conducted Disturbances, Induced by Radio-frequency Fields

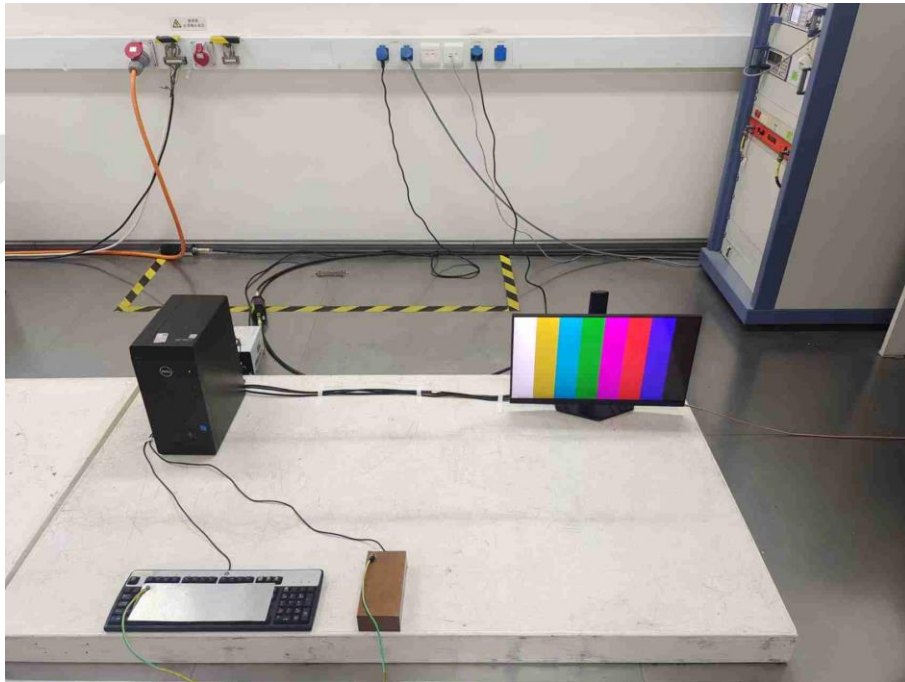

A.11 Power Frequency Magnetic Field Immunity

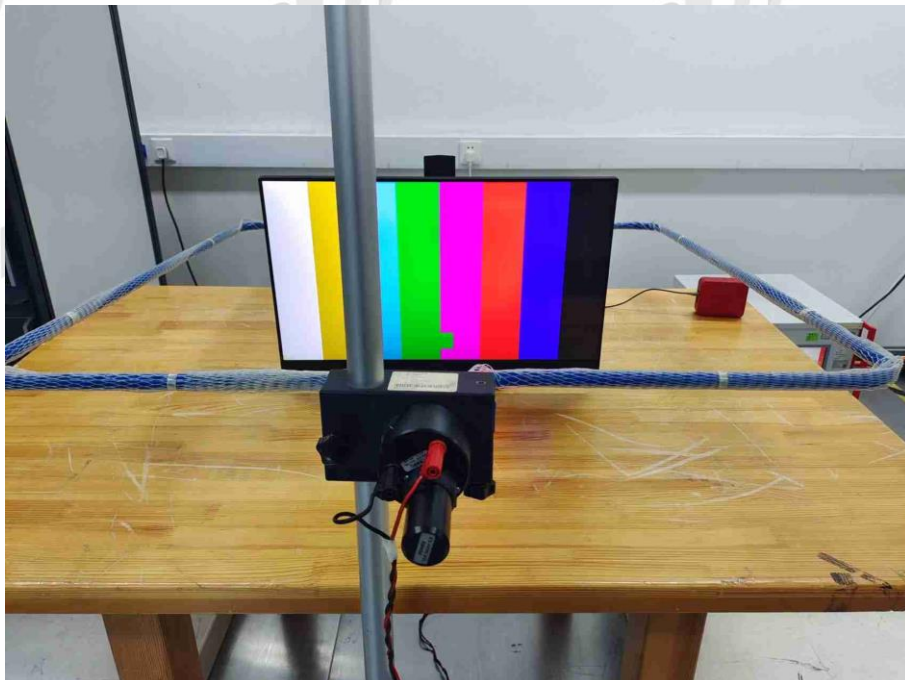

A.12 Voltage Dips, Short Interruptions and Voltage Variations Immunity

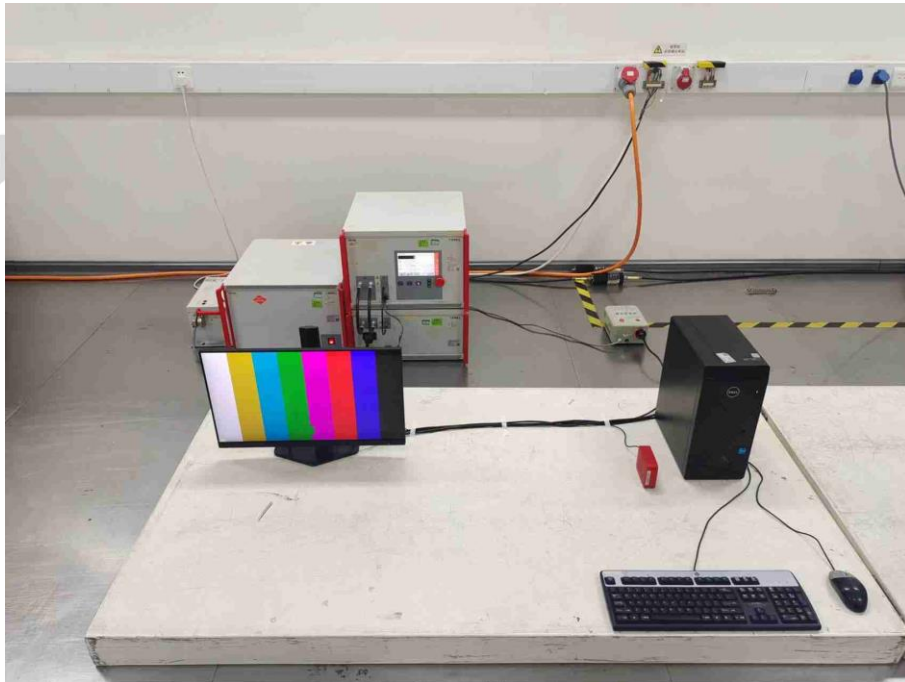

Statement

1. The report is invalid without the inspection and testing special seal of the company.
2. This report is invalid if altered.
3. This report is responsible for the conformance testing of sample(s) received.
4. This report shall not be reproduced, without the written approval of test laboratory. The copy of the report not stamped again with the inspection and testing special seal is invalid.
5. Item with “*” is not accredited by CNAS.
6. Item with “☆” was subcontracted to other laboratories.
7. The report without CMA mark has no effect on social proof.
8. Any objections must be raised to our company within 15 days on receiving the report, overdue will not be accepted.
9. The sample(s) must be collected within three months, overdue will be dealt with by our company.
10. The report is invalid without the signature of editor, reviewer, approver.

Test Laboratory: Tianjin Dongdian Testing Service Co., Ltd.

Address: Building D-1, No. 19, Weisi Road, Microelectronics Industrial Park Development Area, Tianjin, China.

Postcode: 300385

Tel: 022-58038033

Fax: 022-58038033

Website: <http://www.ddttest.com>

END OF REPORT