



中国认可
国际互认
检测
TESTING
CNAS L3163

CE&UKCA EMC Test Report

Project No. : 2310C021
Equipment : OLED Monitor
Brand Name : N/A
Test Model : PD49***** (*=0-9, A-Z, a-z, +, -, /, \ or blank)
Series Model : N/A
Applicant : TPV Electronics (Fujian) Co., Ltd.
Address : Rongqiao Economic and Technological Development Zone, Fuqing
City, Fujian Province, P.R. China
Date of Receipt : Oct. 10, 2023
Date of Test : Oct. 10, 2023 ~ Oct. 14, 2023
Issued Date : Oct. 16, 2023
Report Version : R00
Test Sample : Engineering Sample No.: DG2023101013
Standard(s) : Please refer to Page 2.

The above equipment has been tested and found compliance with the requirement of the relative standards by BTL Inc.(Dongguan).

Prepared by : Derek Tong
Derek Tong
Approved by : Kang Zhang
Kang Zhang

No.3, Jinshagang 1st Road, Dalang, Dongguan, Guangdong, China.

Tel: +86-769-8318-3000 Web: www.newbtl.com Service mail: btl_qa@newbtl.com

Standard(s) : EN 55032:2015, Class B
EN 55032:2015+A11:2020, Class B
EN 55032:2015+A1:2020, Class B
CISPR 32:2015+AMD1:2019
AS/NZS CISPR 32:2015+AMD1:2020
EN 61000-3-2:2014 , Class D
EN IEC 61000-3-2:2019+A1:2021, Class D
EN 61000-3-3:2013
EN 61000-3-3:2013+A1:2019
EN 61000-3-3:2013+A2:2021
EN 55035:2017/CISPR 35:2016
EN 55035:2017+A11:2020

BS EN 55032:2015, Class B
BS EN 55032:2015+A11:2020, Class B
BS EN 55032:2015+A1:2020, Class B
BS EN 61000-3-2:2014, Class D
BS EN IEC 61000-3-2:2019+A1:2021, Class D
BS EN 61000-3-3:2013
BS EN 61000-3-3:2013+A1:2019
BS EN 61000-3-3:2013+A2:2021
BS EN 55035:2017
BS EN 55035:2017+A11:2020

Declaration

BTL represents to the client that testing is done in accordance with standard procedures as applicable and that test instruments used has been calibrated with standards traceable to international standard(s) and/or national standard(s).

BTL's reports apply only to the specific samples tested under conditions. It is manufacture's responsibility to ensure that additional production units of this model are manufactured with the identical electrical and mechanical components. **BTL** shall have no liability for any declarations, inferences or generalizations drawn by the client or others from **BTL** issued reports.

The report must not be used by the client to claim product certification, approval, or endorsement by CNAS.

This report is the confidential property of the client. As a mutual protection to the clients, the public and ourselves, the test report shall not be reproduced, except in full, without our written approval.

BTL's laboratory quality assurance procedures are in compliance with the ISO/IEC 17025: 2017 requirements, and accredited by the conformity assessment authorities listed in this test report.

BTL is not responsible for the sampling stage, so the results only apply to the sample as received.

The information, data and test plan are provided by manufacturer which may affect the validity of results, so it is manufacturer's responsibility to ensure that the apparatus meets the essential requirements of applied standards and in all the possible configurations as representative of its intended use.

Limitation

For the use of the authority's logo is limited unless the Test Standard(s)/Scope(s)/Item(s) mentioned in this test report is (are) included in the conformity assessment authorities acceptance respective.

Please note that the measurement uncertainty is provided for informational purpose only and are not use in determining the Pass/Fail results.

Table of Contents	Page
REPORT ISSUED HISTORY	8
1 . SUMMARY OF TEST RESULTS	9
1.1 TEST FACILITY	11
1.2 MEASUREMENT UNCERTAINTY	11
1.3 TEST ENVIRONMENT CONDITIONS	13
2 . GENERAL INFORMATION	14
2.1 GENERAL DESCRIPTION OF EUT	14
2.2 DESCRIPTION OF TEST MODES	15
2.3 EUT OPERATING CONDITIONS	17
2.4 BLOCK DIAGRAM SHOWING THE CONFIGURATION OF SYSTEM TESTED	17
2.5 DESCRIPTION OF SUPPORT UNITS	18
3 . EMC EMISSION TEST- EN 55032:2015	19
3.1 RADIATED EMISSIONS UP TO 1 GHZ	19
3.1.1 LIMITS	19
3.1.2 MEASUREMENT INSTRUMENTS LIST	19
3.1.3 TEST PROCEDURE	20
3.1.4 DEVIATION FROM TEST STANDARD	20
3.1.5 TEST SETUP	20
3.1.6 MEASUREMENT DISTANCE	21
3.1.7 TEST RESULTS	22
3.2 RADIATED EMISSIONS ABOVE 1 GHZ	24
3.2.1 LIMITS	24
3.2.2 MEASUREMENT INSTRUMENTS LIST	24
3.2.3 TEST PROCEDURE	25
3.2.4 DEVIATION FROM TEST STANDARD	25
3.2.5 TEST SETUP	25
3.2.6 MEASUREMENT DISTANCE	26
3.2.7 TEST RESULTS	27
3.3 CONDUCTED EMISSION MEASUREMENT AT AC MAINS POWER PORTS	29
3.3.1 LIMITS	29
3.3.2 MEASUREMENT INSTRUMENTS LIST	29
3.3.3 TEST PROCEDURE	29
3.3.4 DEVIATION FROM TEST STANDARD	30
3.3.5 TEST SETUP	30
3.3.6 TEST RESULTS	31
4 . EMC EMISSION TEST- EN 55032:2015+A11:2020	33
4.1 RADIATED EMISSIONS UP TO 1 GHZ	33
4.1.1 LIMITS	33
4.1.2 MEASUREMENT INSTRUMENTS LIST	33

Table of Contents	Page
4.1.3 TEST PROCEDURE	34
4.1.4 DEVIATION FROM TEST STANDARD	34
4.1.5 TEST SETUP	34
4.1.6 MEASUREMENT DISTANCE	35
4.1.7 TEST RESULTS	36
4.2 RADIATED EMISSIONS ABOVE 1 GHZ	46
4.2.1 LIMITS	46
4.2.2 MEASUREMENT INSTRUMENTS LIST	46
4.2.3 TEST PROCEDURE	47
4.2.4 DEVIATION FROM TEST STANDARD	47
4.2.5 TEST SETUP	47
4.2.6 MEASUREMENT DISTANCE	48
4.2.7 TEST RESULTS	49
4.3 CONDUCTED EMISSION MEASUREMENT AT AC MAINS POWER PORTS	59
4.3.1 LIMITS	59
4.3.2 MEASUREMENT INSTRUMENTS LIST	59
4.3.3 TEST PROCEDURE	59
4.3.4 DEVIATION FROM TEST STANDARD	60
4.3.5 TEST SETUP	60
4.3.6 TEST RESULTS	61
4.4 ASYMMETRIC MODE CONDUCTED EMISSIONS TEST	69
4.4.1 LIMITS	69
4.4.2 MEASUREMENT INSTRUMENTS LIST	69
4.4.3 TEST PROCEDURE	70
4.4.4 DEVIATION FROM TEST STANDARD	70
4.4.5 TEST SETUP	70
4.4.6 TEST RESULTS	71
4.5 HARMONIC CURRENT EMISSIONS TEST	72
4.5.1 LIMITS	72
4.5.2 MEASUREMENT INSTRUMENTS LIST	72
4.5.3 TEST PROCEDURE	72
4.5.4 DEVIATION FROM TEST STANDARD	72
4.5.5 TEST SETUP	73
4.5.6 TEST RESULTS	74
4.6 VOLTAGE FLUCTUATIONS (FLICKER) TEST	77
4.6.1 LIMITS	77
4.6.2 MEASUREMENT INSTRUMENTS LIST	77
4.6.3 TEST PROCEDURE	77
4.6.4 DEVIATION FROM TEST STANDARD	77
4.6.5 TEST SETUP	78
4.6.6 TEST RESULTS	79
5 . EMC IMMUNITY TEST	80
5.1 STANDARD COMPLIANCE/SEVERITY LEVEL/CRITERIA	80

Table of Contents	Page
5.2 GENERAL PERFORMANCE CRITERIA	83
5.3 ANNEX D (NORMATIVE) - DISPLAY AND DISPLAY OUTPUT FUNCTION	84
5.3.1 PERFORMANCE CRITERIA	84
5.4 ANNEX G (NORMATIVE) - AUDIO OUTPUT FUNCTION	85
5.4.1 PERFORMANCE CRITERIA	85
5.5 ELECTROSTATIC DISCHARGE IMMUNITY TEST (ESD)	86
5.5.1 TEST SPECIFICATION	86
5.5.2 MEASUREMENT INSTRUMENTS	86
5.5.3 TEST PROCEDURE	86
5.5.4 DEVIATION FROM TEST STANDARD	87
5.5.5 TEST SETUP	87
5.5.6 TEST RESULTS	88
5.6 RADIATED, RADIO-FREQUENCY, ELECTROMAGNETIC FIELD IMMUNITY TEST (RS) 91	91
5.6.1 TEST SPECIFICATION	91
5.6.2 MEASUREMENT INSTRUMENTS	91
5.6.3 TEST PROCEDURE	91
5.6.4 DEVIATION FROM TEST STANDARD	92
5.6.5 TEST SETUP	92
5.6.6 TEST RESULTS	94
5.7 ELECTRICAL FAST TRANSIENT/BURST IMMUNITY TEST (EFT)	99
5.7.1 TEST SPECIFICATION	99
5.7.2 MEASUREMENT INSTRUMENTS	99
5.7.3 TEST PROCEDURE	99
5.7.4 DEVIATION FROM TEST STANDARD	99
5.7.5 TEST SETUP	100
5.7.6 TEST RESULTS	101
5.8 SURGE IMMUNITY TEST (SURGE)	102
5.8.1 TEST SPECIFICATION	102
5.8.2 MEASUREMENT INSTRUMENTS	102
5.8.3 TEST PROCEDURE	102
5.8.4 DEVIATION FROM TEST STANDARD	102
5.8.5 TEST SETUP	103
5.8.6 TEST RESULTS	104
5.9 IMMUNITY TO CONDUCTED DISTURBANCES, INDUCED BY RADIO-FREQUENCY	
FIELDS TEST (CS)	105
5.9.1 TEST SPECIFICATION	105
5.9.2 MEASUREMENT INSTRUMENTS	105
5.9.3 TEST PROCEDURE	105
5.9.4 DEVIATION FROM TEST STANDARD	106
5.9.5 TEST SETUP	106
5.9.6 TEST RESULTS	108
5.10 POWER FREQUENCY MAGNETIC FIELD IMMUNITY TEST (PFMF)	113
5.10.1 TEST SPECIFICATION	113

Table of Contents	Page
5.10.2 MEASUREMENT INSTRUMENTS	113
5.10.3 TEST PROCEDURE	113
5.10.4 DEVIATION FROM TEST STANDARD	113
5.10.5 TEST SETUP	114
5.10.6 TEST RESULTS	115
5.11 VOLTAGE DIPS, SHORT INTERRUPTIONS AND VOLTAGE VARIATIONS IMMUNITY	
TEST (DIPS)	116
5.11.1 TEST SPECIFICATION	116
5.11.2 MEASUREMENT INSTRUMENTS	116
5.11.3 TEST PROCEDURE	116
5.11.4 DEVIATION FROM TEST STANDARD	116
5.11.5 TEST SETUP	116
5.11.6 TEST RESULTS	117
6 . EUT TEST PHOTO	118

REPORT ISSUED HISTORY

Report No.	Version	Description	Issued Date	Note
BTL-EMC-1-2310C021	R00	Original Report.	Oct. 16, 2023	Valid

1. SUMMARY OF TEST RESULTS

Test procedures according to the technical standards:

Emission			
Standard(s)	Test Item	Result	
EN 55032:2015+A11:2020, Class B EN 55032:2015+A1:2020, Class B CISPR 32:2015+AMD1:2019 AS/NZS CISPR 32:2015+AMD1:2020 BS EN 55032:2015+A11:2020, Class B BS EN 55032:2015+A1:2020, Class B	Radiated emissions up to 1 GHz	PASS	
	Radiated emissions above 1 GHz	PASS	
	Radiated emissions from FM receivers	N/A	
	Conducted emissions AC mains power port	PASS	
	Asymmetric mode conducted emissions	AAN	PASS
		Current Probe	N/A
		CP+CVP	N/A
Conducted differential voltage emissions	N/A		

Standard(s)	Test Item	Result
EN 61000-3-2:2014, Class D EN IEC 61000-3-2:2019+A1:2021, Class D BS EN 61000-3-2:2014, Class D BS EN IEC 61000-3-2:2019+A1:2021, Class D	Harmonic current	PASS
EN 61000-3-3:2013 EN 61000-3-3:2013+A1:2019 EN 61000-3-3:2013+A2:2021 BS EN 61000-3-3:2013 BS EN 61000-3-3:2013+A1:2019 BS EN 61000-3-3:2013+A2:2021	Voltage fluctuations (Flicker)	PASS

Immunity			
Standard(s)	Ref Standard(s)	Test Item	Result
EN 55035:2017/CISPR 35:2016 EN 55035:2017+A11:2020 BS EN 55035:2017 BS EN 55035:2017+A11:2020	IEC 61000-4-2:2008 EN 61000-4-2:2009	ESD	PASS
	IEC 61000-4-3:2020 EN IEC 61000-4-3:2020	RS	PASS
	IEC 61000-4-4:2012 EN 61000-4-4:2012	EFT	PASS
	IEC 61000-4-5:2014+AMD1:2017 EN 61000-4-5:2014+A1:2017	Surge	PASS
	IEC 61000-4-6:2013 EN 61000-4-6:2014+AC:2015	CS	PASS
	IEC 61000-4-8:2009 EN 61000-4-8:2010	PFMF	PASS
	IEC 61000-4-11:2020 EN IEC 61000-4-11:2020	Dips	PASS

Standard(s)	Section	Test Item	Result
EN 55035:2017/CISPR 35:2016 EN 55035:2017+A11:2020	4.2.7	BIN-R	N/A
BS EN 55035:2017 BS EN 55035:2017+A11:2020	4.2.7	BIN-I	N/A

NOTE:

(1) "N/A" denotes test is not applicable to this device.

1.1 TEST FACILITY

The test facilities used to collect the test data in this report is at the location of No.3, Jinshagang 1st Road, Dalang, Dongguan, Guangdong, China.

1.2 MEASUREMENT UNCERTAINTY

Where relevant, the following measurement uncertainty levels have been estimated for tests performed on the EUT as specified in CISPR 16-4-2, The BTL measurement uncertainty is less than the CISPR 16-4-2 U_{CISPR} requirement.

The reported uncertainty of measurement $y \pm U$, where expanded uncertainty U is based on a standard uncertainty multiplied by a coverage factor of $k=2$, providing a level of confidence of approximately **95%**.

A. Radiated emissions up to 1 GHz measurement:

Test Site	Method	Measurement Frequency Range	Ant. H / V	U,(dB)
DG-CB08 (10m)	CISPR	30MHz ~ 200MHz	V	4.48
		30MHz ~ 200MHz	H	4.50
		200MHz ~ 1,000MHz	V	4.60
		200MHz ~ 1,000MHz	H	4.84

B. Radiated emissions above 1 GHz measurement:

Test Site	Method	Measurement Frequency Range	U,(dB)
DG-CB08 (3m)	CISPR	1GHz ~ 6GHz	4.24

C. Conducted emissions AC mains power port measurement:

Test Site	Method	Measurement Frequency Range	U,(dB)
DG-C01	CISPR	150kHz ~ 30MHz	2.98

D. Asymmetric mode conducted emissions measurement:

Test Site	Method	Measurement Frequency Range	U,(dB)
DG-C01	CISPR	AAN Cat.5 LCL = 65 ... 50 dB	4.12

E. Harmonic current / Voltage fluctuations (Flicker) measurement:

Test Site	Method	Item	U (%)
DG-C01	EN 61000-3-2 EN 61000-3-3	Current	0.757
		Voltage	0.592

F. Immunity Measurement:

Test Site	Method	Item	U
DG-SR02	IEC 61000-4-2	Rise time tr	7.00%
		Peak current Ip	6.50%
		Current at 30 ns	6.60%
		Current at 60 ns	6.80%
DG-CB05	IEC 61000-4-3 (80MHz~6GHz)	Electromagnetic field immunity test	2.2dB
		On-ear acoustic & Acoustic measurements on loudspeakers	2.24dB
DG-SR05	IEC 61000-4-4	Peak voltage (VP)	3.8%
		Rise time (tr)	4.4%
		Pulse width(tw)	4.2%
		Pulse Freq.(kHz)	0.7%
		Burst Duration(ms)	1.5%
		Burst Period(ms)	1.4%
		Peak voltage (VP)-with clamp	3.9%
		Rise time (tr) -with clamp	4.4%
		Pulse width(tw) -with clamp	4.2%
DG-SR05	IEC 61000-4-5	Open-Circuit Output Voltage (1.2/50us)	4.0%
		Open circuit front time (1.2/50us)	6.2%
		Open circuit time of half value (1.2/50us)	4.7%
DG-CB06	IEC 61000-4-6 (150kHz-80MHz)	CDN	1.28dB
		On-ear acoustic & Acoustic measurements on loudspeakers	1.36dB
DG-SR05	IEC 61000-4-8	Magnetic Field Strength	1.91%
DG-SR01	IEC 61000-4-11	DIP Amplitude	3.6%
		DIP Time Event	4.0%

Note: Unless specifically mentioned, the uncertainty of measurement has not been taken into account to declare the compliance or non-compliance to the specification.

1.3 TEST ENVIRONMENT CONDITIONS

Test Item	Temperature	Humidity	Tested By
Radiated emissions up to 1 GHz	26°C	51%	Bernie Wu
Radiated emissions above 1 GHz	26°C	51%	Bernie Wu
Conducted emissions AC mains power port	25°C	52%	Jeter Wang
Asymmetric mode conducted emissions	25°C	52%	Jeter Wang
Harmonic current	25°C	52%	Jeter Wang
Voltage fluctuations (Flicker)	25°C	52%	Jeter Wang

Test Item	Temperature	Humidity	Pressure	Tested By
ESD	25°C	48%	1008hPa	Ash Deng
RS	25°C	55%	/	Ash Deng
EFT	26°C	62%	/	Meers Zhang
Surge	26°C	62%	/	Meers Zhang
CS	25°C	61%	/	Farun Liang
PFMF	26°C	62%	/	Meers Zhang
Dips	24°C	62%	/	Oliver Wang

2. GENERAL INFORMATION

2.1 GENERAL DESCRIPTION OF EUT

Equipment	OLED Monitor
Brand Name	N/A
Test Model	PD49***** (*=0-9, A-Z, a-z, +, -, /, \ or blank)
Series Model	N/A
Model Difference(s)	Only differ in model name due to marketing purpose.
Power Source	AC Mains.
Power Rating	100-240V ~ 50/60Hz 4.5A
Connecting I/O Port(s)	1* AC port 2* HDMI port 1* Type-C port 1* DP port 5* USB port 1* Earphone port 1* LAN port
Classification of EUT	Class B
Highest Internal Frequency(Fx)	1.5GHz

Cable Type	Shielded Type	Ferrite Core	Length(m)	Note
AC Power Cord	Non-shielded	NO	1.8/1.5/1.2	1.8m is worst case Detachable
HDMI	Shielded	NO	1.8/1.5/1.2	-
DP	Shielded	NO	1.8/1.5/1.2	-
Type-C	Shielded	NO	1.8/1.5/1.2	-
USB	Shielded	NO	1.8/1.5/1.2	-

Note:

1. For a more detailed features description, please refer to the manufacturer's specifications or the user's manual.
2. Power cable 1.8m, 1.5m and 1.2m length, worst case is Power cable 1.8m with HDMI+DP+Type-C+USB length testing and recorded in test report.

2.2 DESCRIPTION OF TEST MODES

To investigate the maximum EMI emission characteristics generated from EUT, the test system was pre-scanning tested based on the consideration of following EUT operation mode or test configuration mode which possibly have effect on EMI emission level. Each of these EUT operation mode(s) or test configuration mode(s) mentioned above was evaluated respectively.

Pretest Mode	Description
Mode 1	HDMI 1 5120*1440/240Hz+Type-C(20V4.5A LOAD) 1.8m
Mode 2	HDMI 2 5120*1440/240Hz+Type-C(12V3A LOAD) 1.8m
Mode 3	DP 5120*1440/240Hz+Type-C(5V3A LOAD) 1.8m
Mode 4	Type-C 5120*1440/240Hz+USB 3.2Gen(5V1.5A) 1.8m
Mode 5	HDMI 1 2160P+Type-C(20V4.5A LOAD) 1.8m
Mode 6	HDMI 1 3840*2160/144+Type-C(20V4.5A LOAD) 1.8m
Mode 7	HDMI 1 640*480/120+Type-C(20V4.5A LOAD) 1.8m
Mode 8	HDMI 1 5120*1440/240Hz+Type-C(20V4.5A LOAD) 1.8m
Mode 9	HDMI 2 5120*1440/240Hz+Type-C(20V4.5A LOAD) 1.5m
Mode 10	DP 5120*1440/240Hz+Type-C(20V4.5A LOAD) 1.5m
Mode 11	Type-C 5120*1440/240Hz+USB 3.2Gen (5V1.5A) 1.5m
Mode 12	HDMI 1 5120*1440/240Hz+Type-C(20V4.5A LOAD) 1.2m
Mode 13	HDMI 2 5120*1440/240Hz+Type-C(20V4.5A LOAD) 1.2m
Mode 14	DP 5120*1440/240Hz+Type-C(20V4.5A LOAD) 1.2m
Mode 15	Type-C 5120*1440/240Hz+USB 3.2Gen(5V1.5A) 1.2m
Mode 16	HDMI 1 5120*1440/240Hz+Type-C(20V4.5A LOAD) 1.8m (Without Earphone)

Radiated emissions up to 1 GHz Test	
Final Test Mode	Description
Mode 1	HDMI 1 5120*1440/240Hz+Type-C(20V4.5A LOAD) 1.8m
Mode 2	HDMI 2 5120*1440/240Hz+Type-C(12V3A LOAD) 1.8m
Mode 5	HDMI 1 2160P+Type-C(20V4.5A LOAD) 1.8m
Mode 16	HDMI 1 5120*1440/240Hz+Type-C(20V4.5A LOAD) 1.8m (Without Earphone)

Radiated emissions Above 1 GHz Test	
Final Test Mode	Description
Mode 1	HDMI 1 5120*1440/240Hz+Type-C(20V4.5A LOAD) 1.8m
Mode 2	HDMI 2 5120*1440/240Hz+Type-C(12V3A LOAD) 1.8m
Mode 5	HDMI 1 2160P+Type-C(20V4.5A LOAD) 1.8m
Mode 16	HDMI 1 5120*1440/240Hz+Type-C(20V4.5A LOAD) 1.8m (Without Earphone)

Conducted emissions AC mains power port Test	
Final Test Mode	Description
Mode 1	HDMI 1 5120*1440/240Hz+Type-C(20V4.5A LOAD) 1.8m
Mode 2	HDMI 2 5120*1440/240Hz+Type-C(12V3A LOAD) 1.8m
Mode 5	HDMI 1 2160P+Type-C(20V4.5A LOAD) 1.8m

Asymmetric mode conducted emissions Test	
Final Test Mode	Description
Mode 1	HDMI 1 5120*1440/240Hz+Type-C(20V4.5A LOAD) 1.8m (LAN 1Gbps)

Harmonic current & Voltage fluctuations (Flicker) Test	
Final Test Mode	Description
Mode 1	HDMI 1 5120*1440/240Hz+Type-C(20V4.5A LOAD) 1.8m

Immunity Test	
Final Test Mode	Description
Mode 1	HDMI 1 5120*1440/240Hz+Type-C(20V4.5A LOAD) 1.8m
Mode 2	HDMI 2 5120*1440/240Hz+Type-C(12V3A LOAD) 1.8m
Mode 3	DP 5120*1440/240Hz+Type-C(5V3A LOAD) 1.8m
Mode 4	Type-C 5120*1440/240Hz+USB 3.2Gen(5V1.5A) 1.8m
Mode 5	HDMI 1 2160P+Type-C(20V4.5A LOAD) 1.8m
Mode 8	HDMI 1 5120*1440/240Hz+Type-C(20V4.5A LOAD) 1.8m
Mode 9	HDMI 2 5120*1440/240Hz+Type-C (20V4.5A LOAD) 1.5m
Mode 10	DP 5120*1440/240Hz+Type-C (20V4.5A LOAD) 1.5m
Mode 11	Type-C 5120*1440/240Hz+USB 3.2Gen (5V1.5A) 1.5m
Mode 12	HDMI 1 5120*1440/240Hz+Type-C (20V4.5A LOAD) 1.2m
Mode 13	HDMI 2 5120*1440/240Hz+Type-C (20V4.5A LOAD) 1.2m
Mode 14	DP 5120*1440/240Hz+Type-C (20V4.5A LOAD) 1.2m
Mode 15	Type-C 5120*1440/240Hz+USB 3.2Gen(5V1.5A) 1.2m

Note:

1. For EMI: the standard of EN 55032:2015+A11:2020 tested all the mode, and the EN 55032:2015 tested the worst case and recorded in the test report.
2. For radiated emission: Used the 1.8m cable evaluated the maximum resolution Mode 1-5. The worst case is Mode 1 and evaluated the middle and low resolution Mode 6-7. At last, evaluated the 1.5m, 1.2m cable(Mode 8-15) and Without Earphone(Mode 16). According to the client's requirement, choose Mode 1, Mode 2, Mode 5, Mode 16 and recorded in test report.
3. For Conducted emissions: Used the 1.8m cable evaluated the maximum resolution is evaluated Mode 1-5. The worst case is Mode 1 and evaluated the middle and low resolution Mode 6-7. At last, evaluated the 1.5m, 1.2m cable(Mode 8-15). According to the client's requirement, choose Mode 1, Mode 2, Mode 5 and recorded in test report.

4. RS: The Front, Rear, Left and Right were evaluated. The worst placement direction is Front and recorded in this report.
5. The audio output function of CS/RS is recorded the worst mode.

2.3 EUT OPERATING CONDITIONS

The EUT exercise program used during radiated and/or conducted emission measurement was designed to exercise the various system components in a manner similar to a typical use. The standard test signals and output signal as following:

1. EUT connected to PC via HDMI&DP&Type-C&USB Cable.
2. EUT connected to Earphone via Earphone Cable.
3. Mouse and Keyboard connected to PC via USB Cable.
4. EUT connected to USB3.0 Hard Disk(C&D&G&H) via USB Cable.
5. EUT connected to Notebook via RJ45 Cable.

2.4 BLOCK DIAGRAM SHOWING THE CONFIGURATION OF SYSTEM TESTED

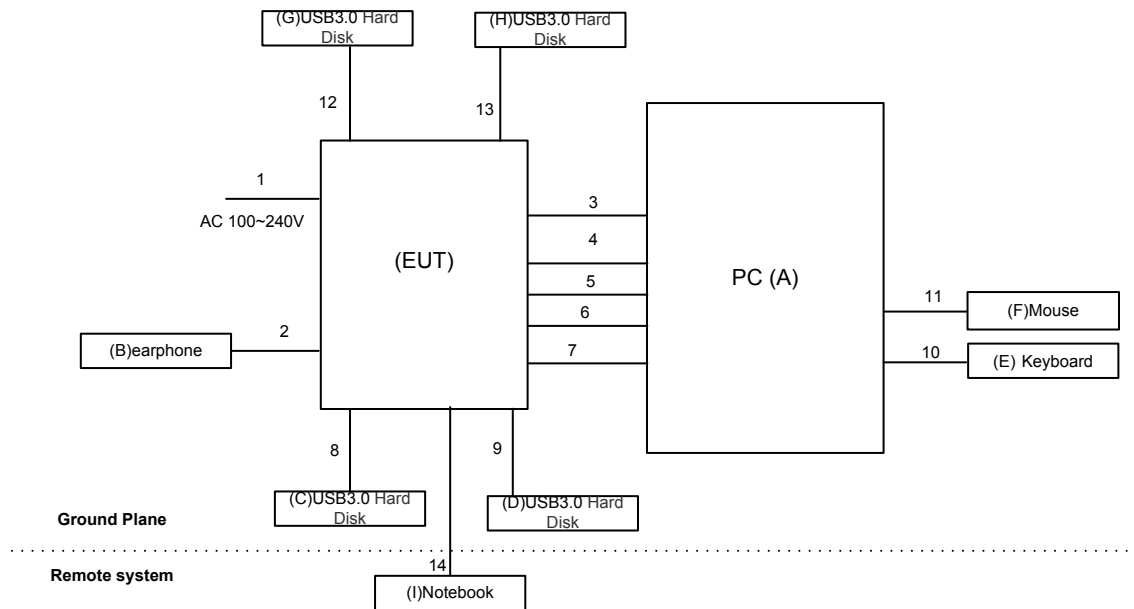

2.5 DESCRIPTION OF SUPPORT UNITS

The EUT has been tested as an independent unit together with other necessary accessories or support units. The following support units or accessories were used to form a representative test configuration during the tests.

Item	Equipment	Mfr/Brand	Model/Type No.	Series No.
A	PC	DELL	8920-D16N8S	GZS91L2
B	Earphone	apple	N/A	N/A
C	USB3.0 Hard Disk	LACIE	Lacie S.A	NL34BFER
D	USB3.0 Hard Disk	LACIE	Lacie S.A	NL34BJSM
E	Keyboard	DELL	KB212-B	CN0HTXH97158125004DXA01
F	Mouse	DELL	MS111-P	CN011D3V71581279OLOT
G	USB3.0 Hard Disk	LACIE	Lacie S.A	NL34BFER
H	USB3.0 Hard Disk	LACIE	Lacie S.A	NL34BJSM
I	Notebook	Lenovo	E445	MP-05Y56S

Item	Cable Type	Shielded Type	Ferrite Core	Length
1	AC Cable	NO	NO	1.8/1.5/1.2m
2	Earphone Cable	NO	NO	1.2m
3	USB Cable	YES	NO	1.8/1.5/1.2m
4	HDMI Cable	YES	NO	1.8/1.5/1.2m
5	HDMI Cable	YES	NO	1.8/1.5/1.2m
6	DP Cable	YES	NO	1.8/1.5/1.2m
7	Type-C Cable	YES	NO	1.8/1.5/1.2m
8	USB Cable	YES	NO	1m
9	USB Cable	YES	NO	1m
10	USB Cable	YES	NO	1.8m
11	USB Cable	YES	NO	1.8m
12	USB Cable	YES	NO	1m
13	USB Cable	YES	NO	1m
14	RJ45 Cable	NO	NO	10m

3. EMC EMISSION TEST- EN 55032:2015

3.1 RADIATED EMISSIONS UP TO 1 GHZ

3.1.1 LIMITS

Class B equipment up to 1 GHz

Frequency Range MHz	Measurement			Class B limits dB(μ V/m)
	Facility	Distance m	Detector type/ bandwidth	
30 - 230	SAC	10	Quasi peak / 120 kHz	30
230 - 1000				37

Notes:

- (1) The limit for radiated test was performed according to as following: EN 55032
- (2) The tighter limit applies at the band edges.
- (3) Emission level (dB μ V/m)=20log Emission level (μ V/m).
- (4) The test result calculated as following:
 Measurement Value = Reading Level + Correct Factor
 Correct Factor = Antenna Factor + Cable Loss - Amplifier Gain(if use)
 Margin Level = Measurement Value - Limit Value

3.1.2 MEASUREMENT INSTRUMENTS LIST

Item	Kind of Equipment	Manufacturer	Type No.	Serial No.	Calibrated until
1	Receiver	Keysight	N9038A	MY54450004	Jun. 16, 2024
2	Pre-Amplifier	EMC INSTRUMENT	EMC 9135	980284	Jun. 16, 2024
3	Pre-Amplifier	EMC INSTRUMENT	EMC 9135	980283	Jun. 16, 2024
4	Trilog-Broadband Antenna	Schwarzbeck	VULB9168	947	Nov. 01, 2023
5	Trilog-Broadband Antenna	Schwarzbeck	VULB9168	946	Aug. 10, 2024
6	Measurement Software	Farad	EZ-EMC Ver.BTL-2ANT-1	N/A	N/A
7	Multi-Device Controller	ETS-Lindgren	2090	N/A	N/A
8	Controller	MF	MF-7802	MF780208159	N/A
9	Attenuator	EMCI	EMCI-N-6-06	AT-N0671	Aug. 10, 2024
10	Attenuator	EMCI	EMCI-N-6-06	AT-N0670	Nov. 01, 2023
11	Cable	RW	LMR400-NMNM-10M	N/A	Dec. 05, 2023
12	Cable	RW	LMR400-NMNM-7M	N/A	Dec. 05, 2023
13	Cable	RW	LMR400-NMNM-3.5 M	N/A	Dec. 05, 2023
14	Cable	RW	LMR400-NMNM-8M	N/A	Dec. 05, 2023
15	Cable	RW	LMR400-NMNM-7M	N/A	Dec. 05, 2023
16	Cable	RW	LMR400-NMNM-3.5 M	N/A	Dec. 05, 2023
17	Receiver	Agilent	N9038A	MY52130039	Jan. 07, 2024

Remark: "N/A" denotes no model name, no serial no. or no calibration specified.

All calibration period of equipment list is one year.

3.1.3 TEST PROCEDURE

- The measuring distance of 10 m shall be used for measurements. The EUT was placed on the top of a rotating table 0.8 meter above the ground at a 10 meter semi-anechoic chamber. The table was rotated 360 degrees to determine the position of the highest radiation.
- The height of the equipment or of the substitution antenna shall be 0.8 m, the height of the test antenna shall vary between 1 m to 4 m. Both horizontal and vertical polarizations of the antenna are set to make the measurement.
- The initial step in collecting radiated emission data is a receiver peak detector mode pre-scanning the measurement frequency range. Significant peaks are then marked and then Quasi Peak detector mode re-measured.
- All readings are Peak unless otherwise stated QP in column of Note. Peak denotes that the Peak reading compliance with the QP Limits and then QP Mode measurement didn't perform.
- For the actual test configuration, please refer to the related Item - EUT Test Photos.

3.1.4 DEVIATION FROM TEST STANDARD

No deviation

3.1.5 TEST SETUP

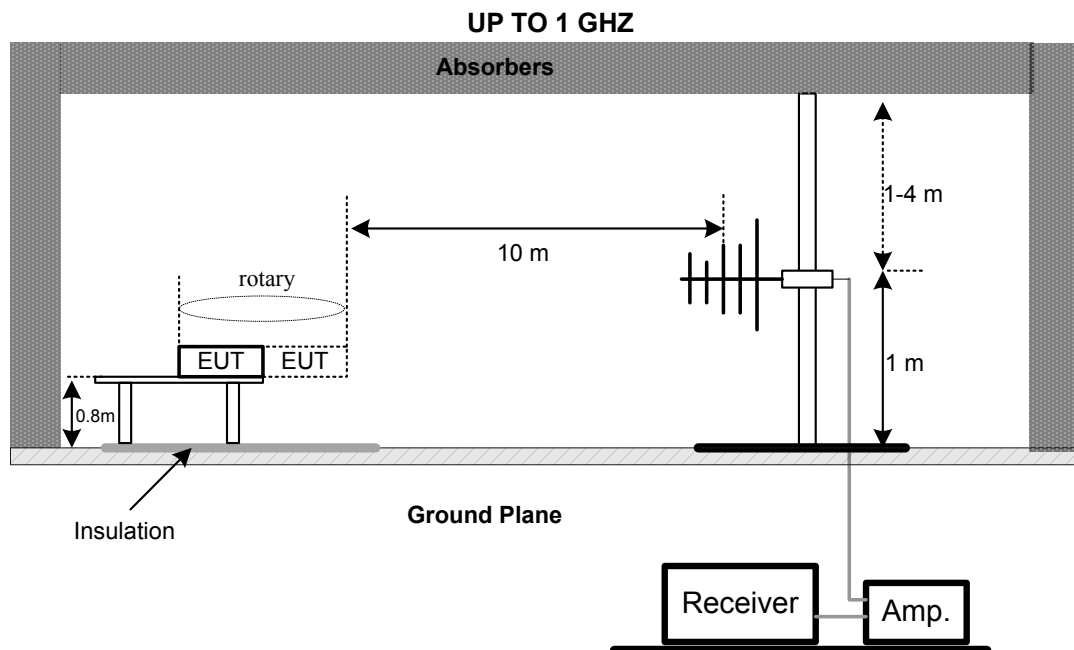

3.1.6 MEASUREMENT DISTANCE

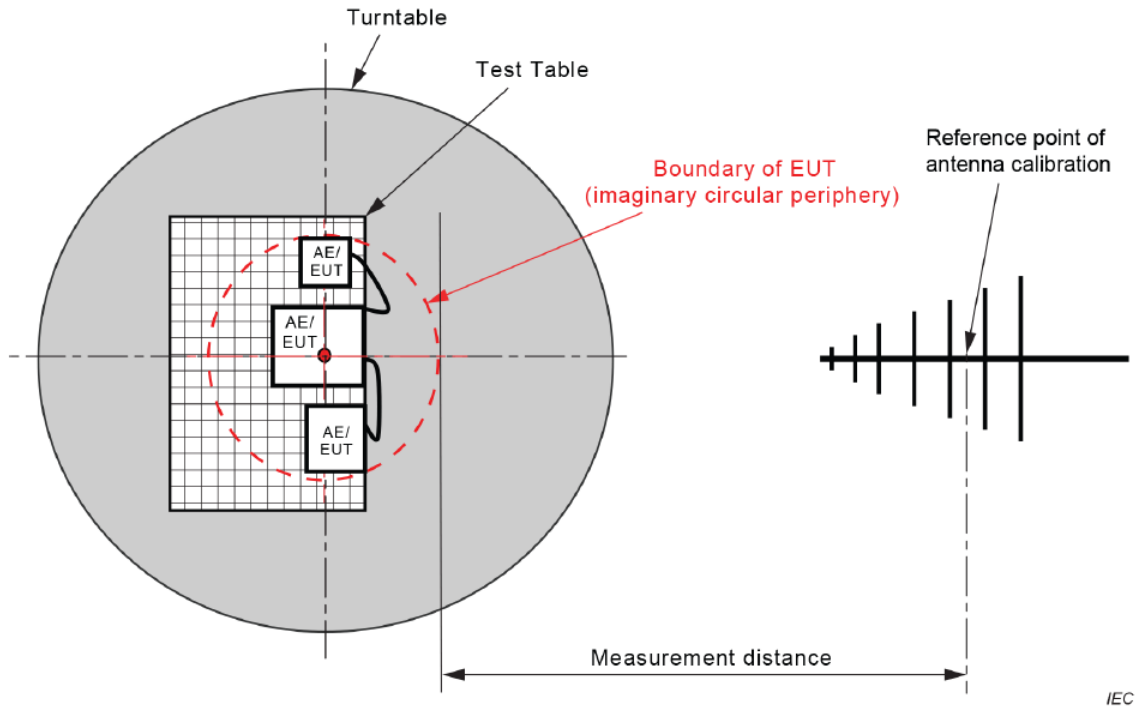

IEC

Figure C.1 – Measurement distance

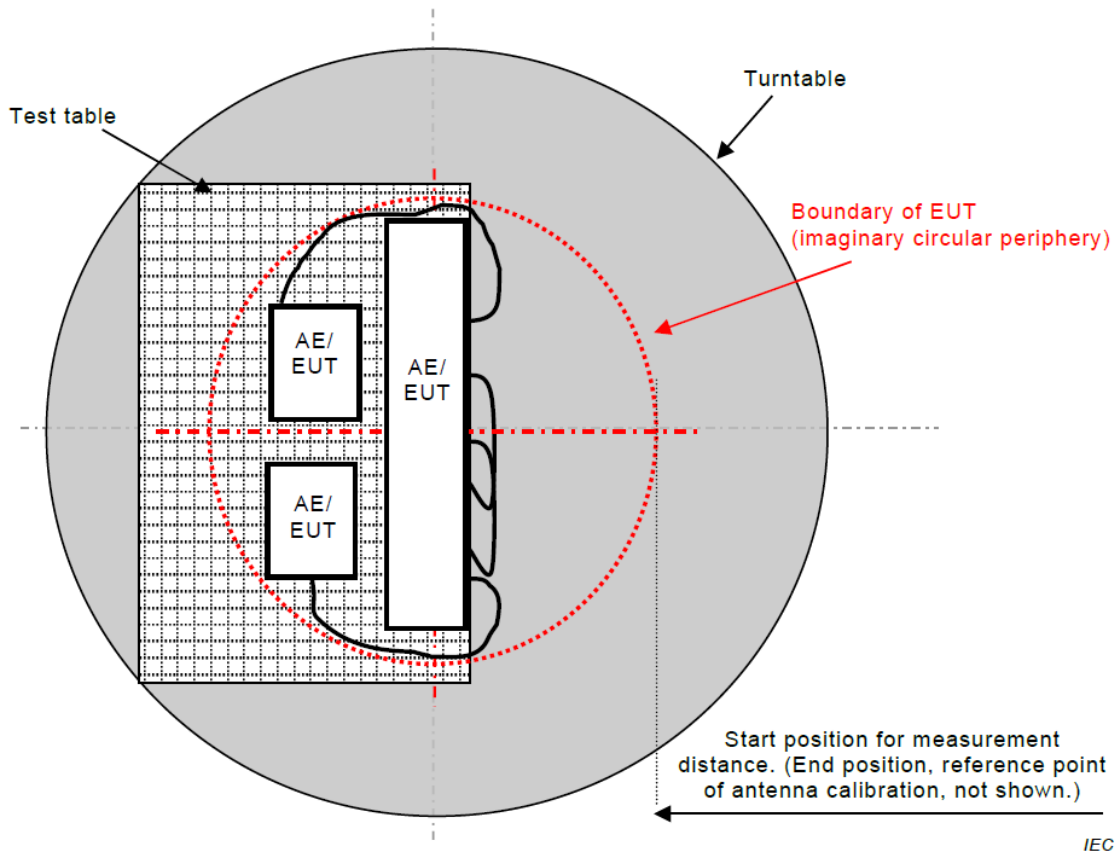

IEC

Figure C.2 – Boundary of EUT, Local AE and associated cabling

3.1.7 TEST RESULTS

Test Voltage	AC 230V/50Hz	Polarization	Vertical
Test Mode	Mode 1		

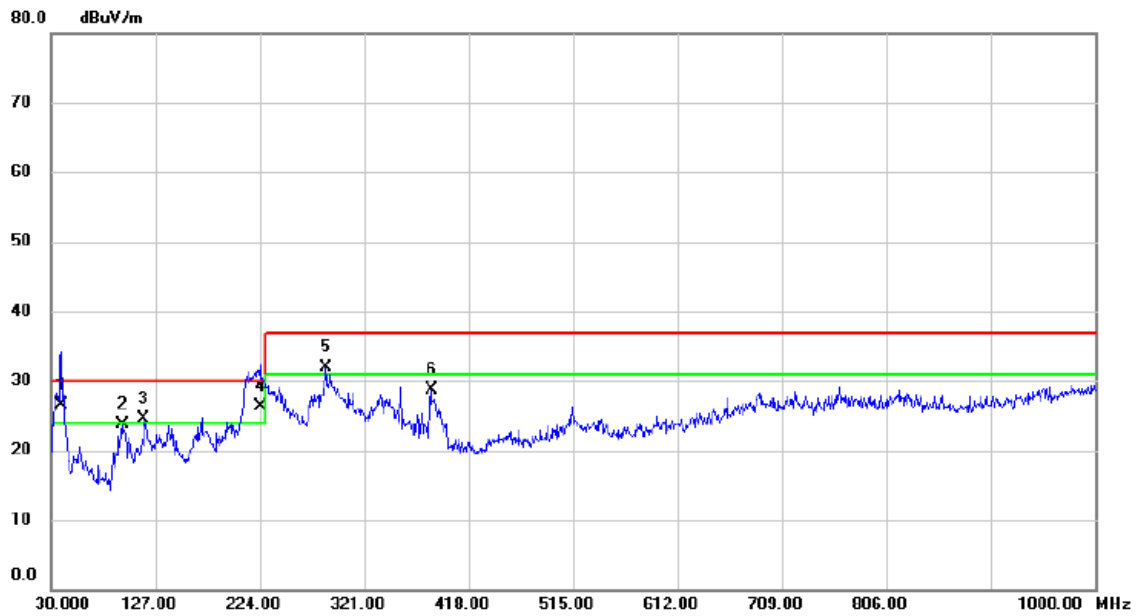

No.	Mk.	Freq. MHz	Reading Level dBuV	Correct Factor dB	Measure- ment dBuV/m	Limit dBuV/m	Margin dB	Detector	Comment
1	*	39.7000	44.75	-18.19	26.56	30.00	-3.44	QP	
2		95.9600	45.74	-22.13	23.61	30.00	-6.39	QP	
3	!	116.3300	43.35	-18.93	24.42	30.00	-5.58	QP	
4	!	224.0000	45.77	-19.45	26.32	30.00	-3.68	QP	
5	!	285.1100	48.30	-16.31	31.99	37.00	-5.01	QP	
6		383.0800	42.31	-13.61	28.70	37.00	-8.30	QP	

Test Voltage	AC 230V/50Hz	Polarization	Horizontal
Test Mode	Mode 1		

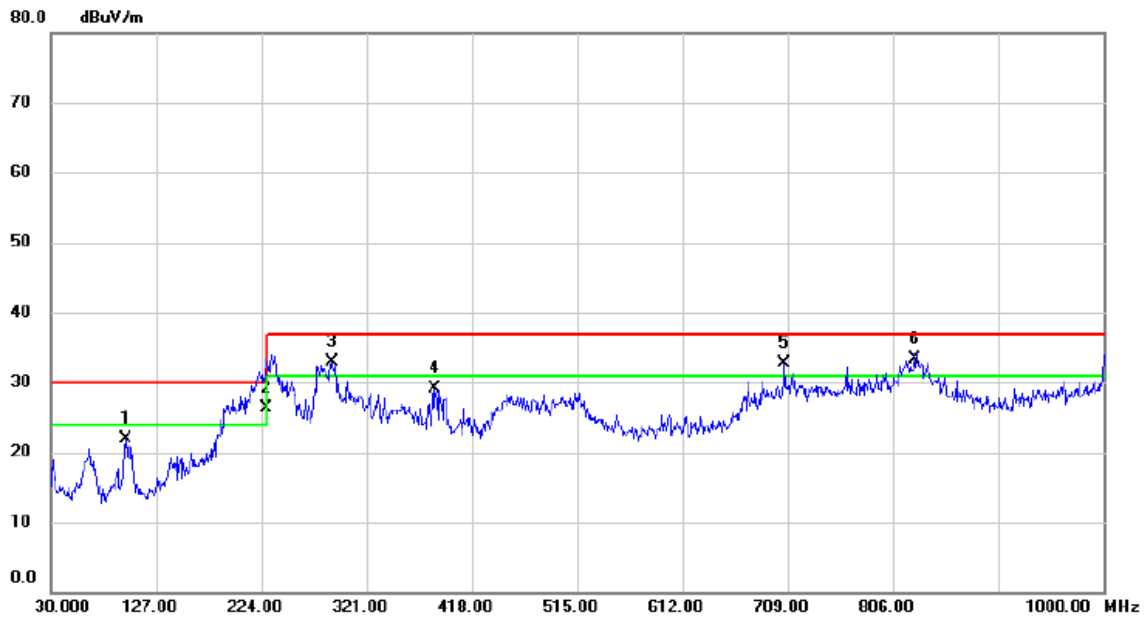

No. Mk.	Freq. MHz	Reading Level dBuV	Correct Factor dB	Measure- ment dBuV/m	Limit dBuV/m	Margin dB	Detector	Comment
1	98.8700	44.09	-22.14	21.95	30.00	-8.05	QP	
2 *	228.8500	45.01	-18.69	26.32	30.00	-3.68	QP	
3 !	288.9900	49.00	-16.12	32.88	37.00	-4.12	QP	
4	384.0500	42.63	-13.57	29.06	37.00	-7.94	QP	
5 !	706.0900	40.81	-8.20	32.61	37.00	-4.39	QP	
6 !	825.4000	40.57	-7.36	33.21	37.00	-3.79	QP	

3.2 RADIATED EMISSIONS ABOVE 1 GHZ

3.2.1 LIMITS

Class B equipment above 1 GHz

Frequency Range MHz	Measurement			Class B limits dB(μ V/m)
	Facility	Distance m	Detector type/bandwidth	
1000 - 3000	FSOATS	3	Average / 1 MHz	50
3000 - 6000				54
1000 - 3000			Peak / 1 MHz	70
3000 - 6000				74

Notes:

- (1) The limit for radiated test was performed according to as following: EN 55032
- (2) The tighter limit applies at the band edges.
- (3) Emission level (dB μ V/m)=20log Emission level (μ V/m).
- (4) The test result calculated as following:
 Measurement Value = Reading Level + Correct Factor
 Correct Factor = Antenna Factor + Cable Loss - Amplifier Gain(if use)
 Margin Level = Measurement Value - Limit Value

Required highest frequency for radiated measurement

Highest internal frequency (F_x)	Highest measured frequency
$F_x \leq 108$ MHz	1 GHz
$108 < F_x \leq 500$ MHz	2 GHz
$500 < F_x \leq 1000$ MHz	5 GHz
$F_x > 1$ GHz	5 x F_x up to a maximum of 6 GHz

3.2.2 MEASUREMENT INSTRUMENTS LIST

Item	Kind of Equipment	Manufacturer	Type No.	Serial No.	Calibrated until
1	Horn Antenna	EMCO	3115	9605-4803	Jun. 17, 2024
2	Amplifier	Agilent	8449B	3008A02333	Jan. 07, 2024
3	Measurement Software	Farad	EZ-EMC Ver.BTL-2ANT-1	N/A	N/A
4	Multi-Device Controller	ETS-Lindgren	2090	N/A	N/A
5	Controller	MF	MF-7802	MF780208159	N/A
6	Receiver	Agilent	N9038A	MY52130039	Jan. 07, 2024
7	Cable	RW	RWLP50-4.0A-N MRASM-4M	N/A	Jul. 30, 2024
8	Cable	RW	RWLP50-4.0A-N MRASM-12M	N/A	Jul. 30, 2024
9	Cable	RW	RWLP50-4.0A-N MRASM-1M	N/A	Jul. 30, 2024
10	Horn Antenna	EMCO	3115	9605-4803	Jun. 17, 2024

Remark: "N/A" denotes no model name, no serial no. or no calibration specified.

All calibration period of equipment list is one year.

3.2.3 TEST PROCEDURE

- The measuring distance of 3 m shall be used for measurements. The EUT was placed on the top of a rotating table 0.8 meter above the ground at a 10 meter semi-anechoic chamber. The table was rotated 360 degrees to determine the position of the highest radiation.
- The height of the equipment or of the substitution antenna shall be 0.8 m, the height of the test antenna shall vary between 1 m to 4 m. Both horizontal and vertical polarizations of the antenna are set to make the measurement.
- The initial step in collecting radiated emission data is a receiver peak detector mode pre-scanning the measurement frequency range. Significant peaks are then marked and then AVG detector mode re-measured.
- All readings are Peak Mode value unless otherwise stated AVG in column of Note. If the Peak Mode Measured value compliance with the Peak Limits and lower than AVG Limits, the EUT shall be deemed to meet both Peak & AVG Limits and then only Peak Mode was measured, but AVG Mode didn't perform.
- For the actual test configuration, please refer to the related Item - EUT Test Photos.

3.2.4 DEVIATION FROM TEST STANDARD

No deviation

3.2.5 TEST SETUP

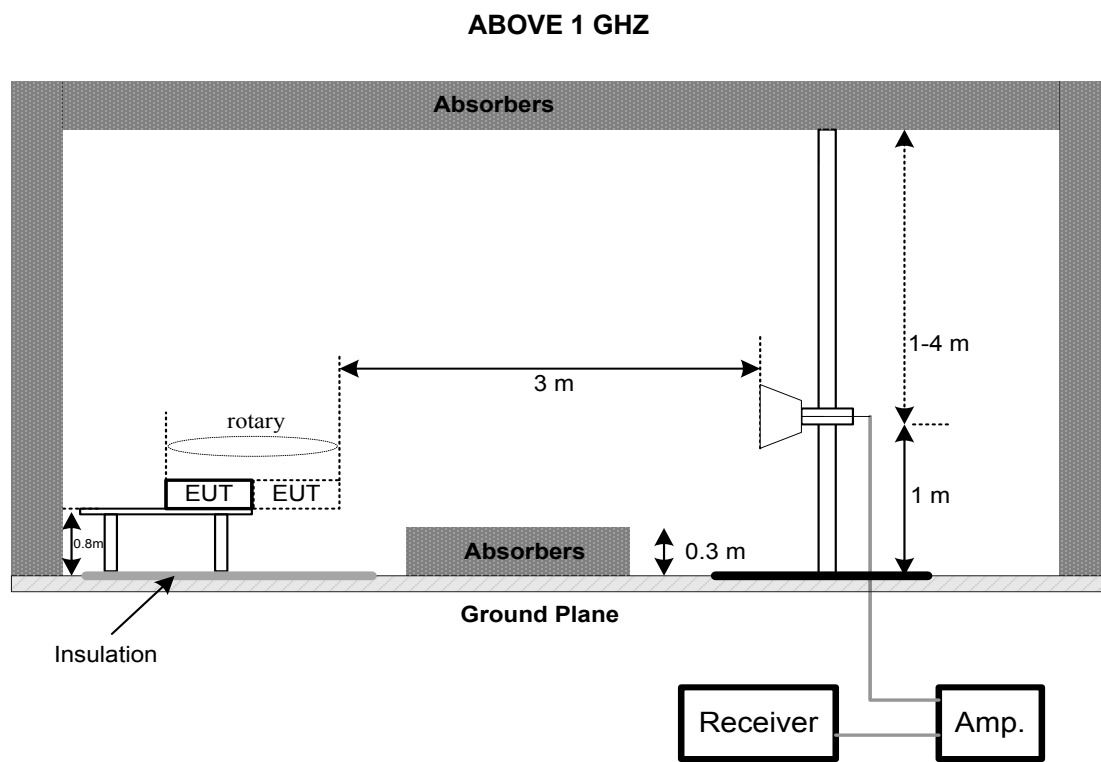

3.2.6 MEASUREMENT DISTANCE

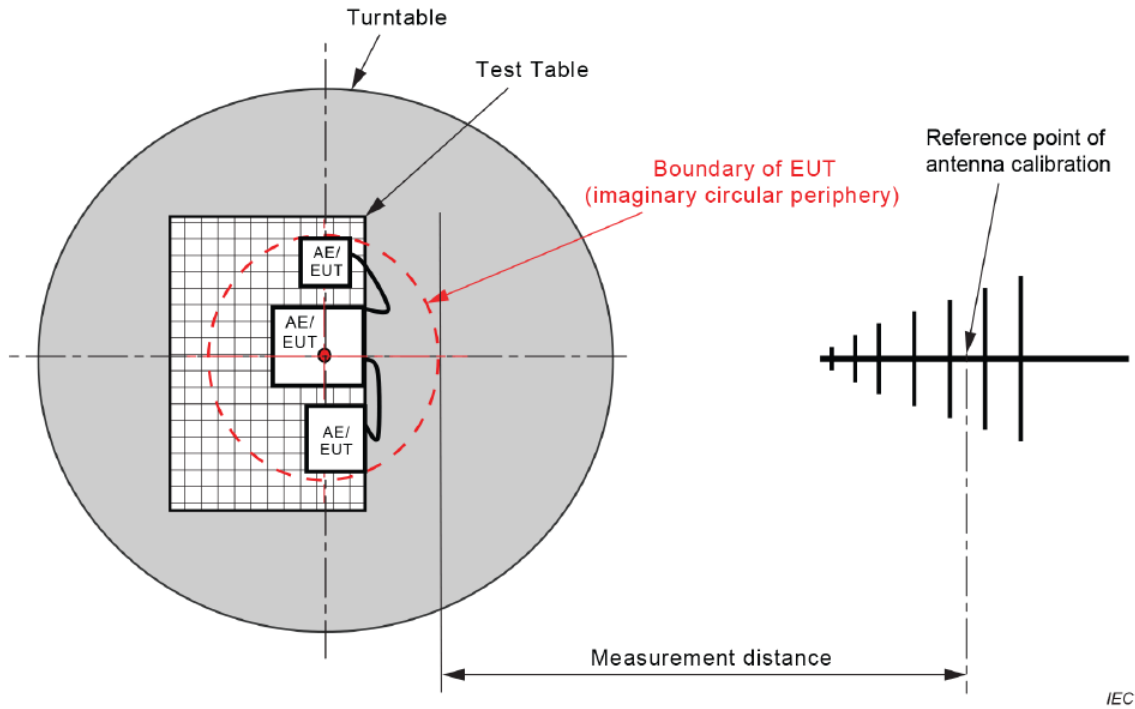

Figure C.1 – Measurement distance

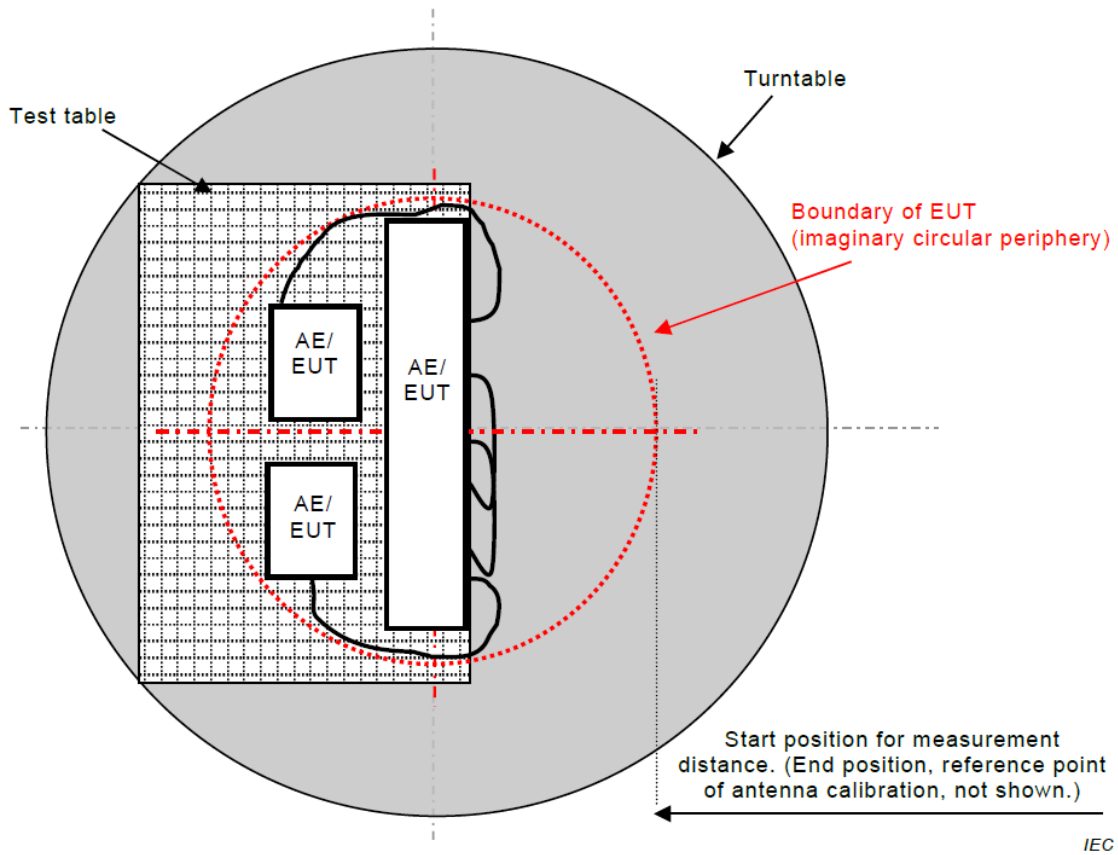
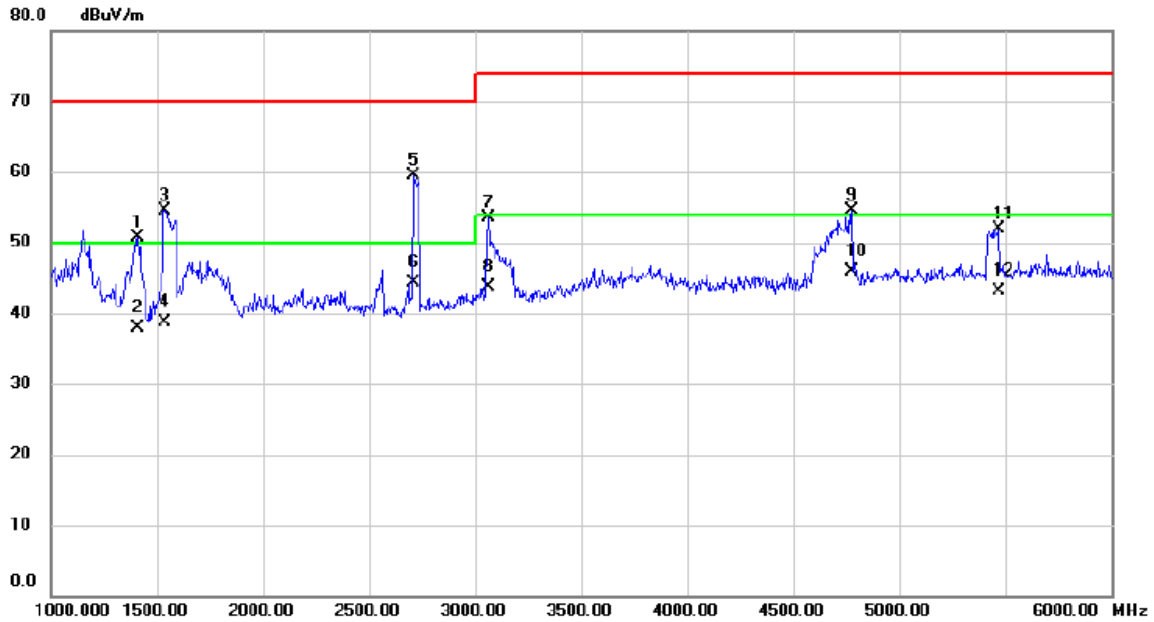

Figure C.2 – Boundary of EUT, Local AE and associated cabling

3.2.7 TEST RESULTS

Test Voltage	AC 230V/50Hz	Polarization	Vertical
Test Mode	Mode 1		



No.	Mk.	Freq. MHz	Reading Level dBuV	Correct Factor dB	Measure- ment dBuV/m	Limit dBuV/m	Margin dB	Detector	Comment
1		1410.000	53.59	-2.91	50.68	70.00	-19.32	peak	
2		1410.000	40.75	-2.91	37.84	50.00	-12.16	AVG	
3		1537.500	56.71	-2.12	54.59	70.00	-15.41	peak	
4		1537.500	40.77	-2.12	38.65	50.00	-11.35	AVG	
5		2707.500	56.29	3.16	59.45	70.00	-10.55	peak	
6	*	2707.500	41.07	3.16	44.23	50.00	-5.77	AVG	
7		3060.000	48.86	4.55	53.41	74.00	-20.59	peak	
8		3060.000	39.17	4.55	43.72	54.00	-10.28	AVG	
9		4775.000	45.34	9.15	54.49	74.00	-19.51	peak	
10		4775.000	36.72	9.15	45.87	54.00	-8.13	AVG	
11		5470.000	40.69	11.24	51.93	74.00	-22.07	peak	
12		5470.000	31.86	11.24	43.10	54.00	-10.90	AVG	

Test Voltage	AC 230V/50Hz	Polarization	Horizontal
Test Mode	Mode 1		

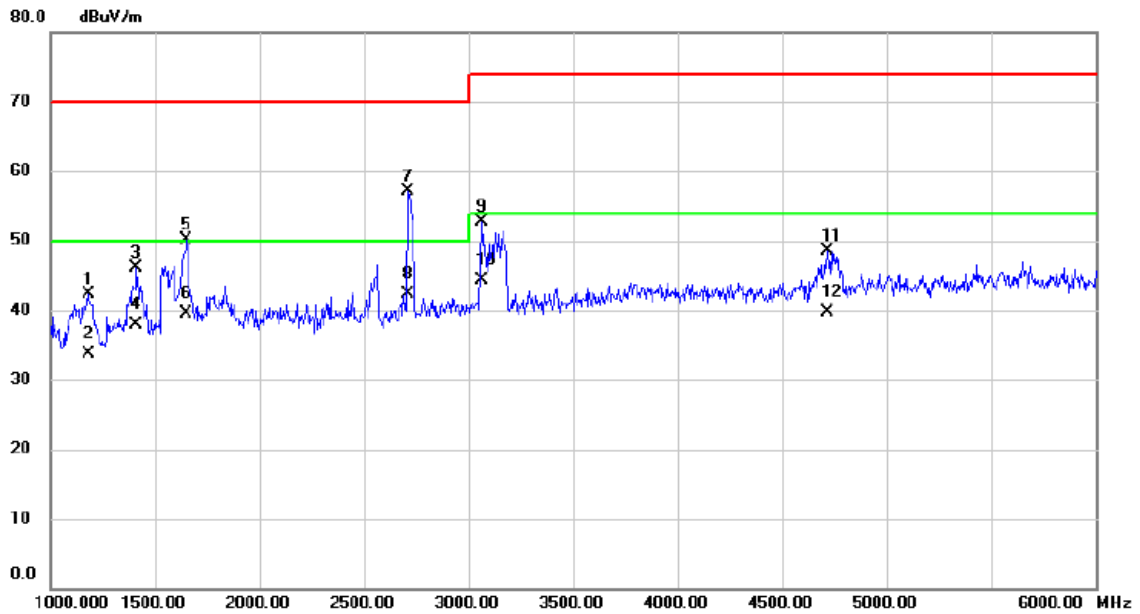

No.	Mk.	Freq. MHz	Reading Level dBuV	Correct Factor dB	Measure- ment dBuV/m	Limit dBuV/m	Margin dB	Detector	Comment
1		1180.000	46.57	-4.25	42.32	70.00	-27.68	peak	
2		1180.000	37.86	-4.25	33.61	50.00	-16.39	AVG	
3		1410.000	49.07	-2.91	46.16	70.00	-23.84	peak	
4		1410.000	40.72	-2.91	37.81	50.00	-12.19	AVG	
5		1650.000	51.40	-1.36	50.04	70.00	-19.96	peak	
6		1650.000	40.83	-1.36	39.47	50.00	-10.53	AVG	
7		2712.500	53.96	3.18	57.14	70.00	-12.86	peak	
8	*	2712.500	39.16	3.18	42.34	50.00	-7.66	AVG	
9		3060.000	48.15	4.55	52.70	74.00	-21.30	peak	
10		3060.000	39.72	4.55	44.27	54.00	-9.73	AVG	
11		4715.000	39.54	8.95	48.49	74.00	-25.51	peak	
12		4715.000	30.74	8.95	39.69	54.00	-14.31	AVG	

3.3 CONDUCTED EMISSION MEASUREMENT AT AC MAINS POWER PORTS

3.3.1 LIMITS

Requirements for conducted emissions from AC mains power ports of Class B equipment

Frequency Range MHz	Coupling Device	Detector Type / bandwidth	Class B Limits (dB(μV))
0.15 - 0.5	AMN	Quasi Peak / 9 kHz	66-56
0.5 - 5			56
5 - 30			60
0.15 - 0.5	AMN	Average / 9 kHz	56-46
0.5 - 5			46
5 - 30			50

NOTE:

(1) The test result calculated as following:

Measurement Value = Reading Level + Correct Factor

Correct Factor = Insertion Loss + Cable Loss + Attenuator Factor(if use)

Margin Level = Measurement Value – Limit Value

3.3.2 MEASUREMENT INSTRUMENTS LIST

Item	Kind of Equipment	Manufacturer	Type No.	Serial No.	Calibrated until
1	50Ω Terminator	SHX	TF2-3G-A	8122901	Jan. 07, 2024
2	TWO-LINE V-NETWORK	R&S	ENV216	100526	Jun. 16, 2024
3	EMI Test Receiver	R&S	ESR3	101862	Jan. 07, 2024
4	Cable	N/A	RG400	N/A(12m)	Sep. 13, 2024
5	Measurement Software	Farad	EZ-EMC Ver.NB-03A1-01	N/A	N/A
6	ISN	Teseq GmbH	ISN T8	30833	Jun. 16, 2024
7	Artificial-Mains Network	SCHWARZBECK	NSLK 8127	8127685	Jan. 07, 2024

Remark: "N/A" denotes no model name, no serial no. or no calibration specified.

All calibration period of equipment list is one year.

3.3.3 TEST PROCEDURE

- a. The EUT was placed 0.8 meters from the horizontal ground plane with EUT being connected to the power mains through a line impedance stabilization network (LISN). All other support equipment powered from additional LISN(s). The LISN provide 50 Ohm/ 50uH of coupling impedance for the measuring instrument.
- b. Interconnecting cables that hang closer than 40 cm to the ground plane shall be folded back and forth in the center forming a bundle 30 to 40 cm long.
- c. I/O cables that are not connected to a peripheral shall be bundled in the center. The end of the cable may be terminated, if required, using the correct terminating impedance. The overall length shall not exceed 1 m.
- d. LISN at least 80 cm from nearest part of EUT chassis.
- e. For the actual test configuration, please refer to the related Item –EUT Test Photos.

3.3.4 DEVIATION FROM TEST STANDARD

No deviation

3.3.5 TEST SETUP

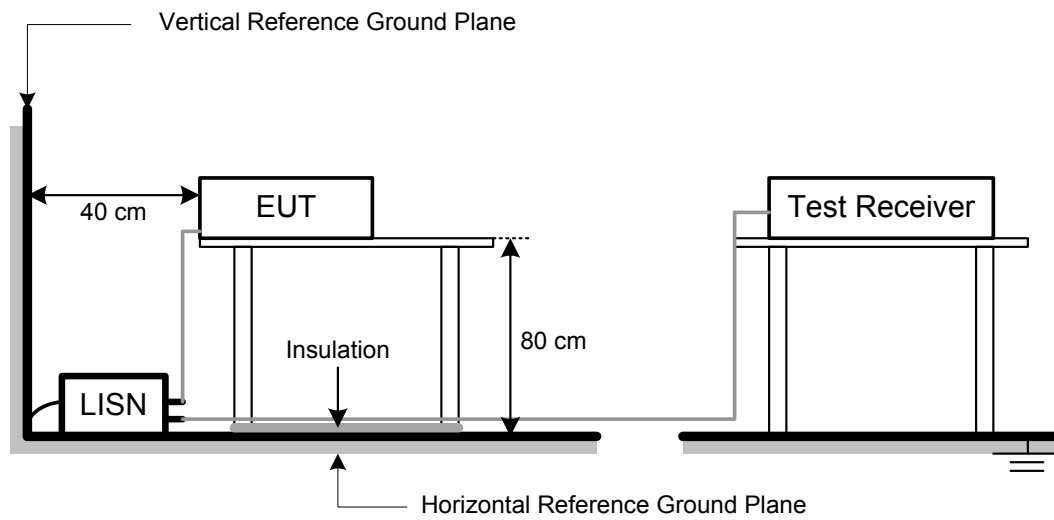

3.3.6 TEST RESULTS

Test Voltage	AC 230V/50Hz	Phase	Line
Test Mode	Mode 1		

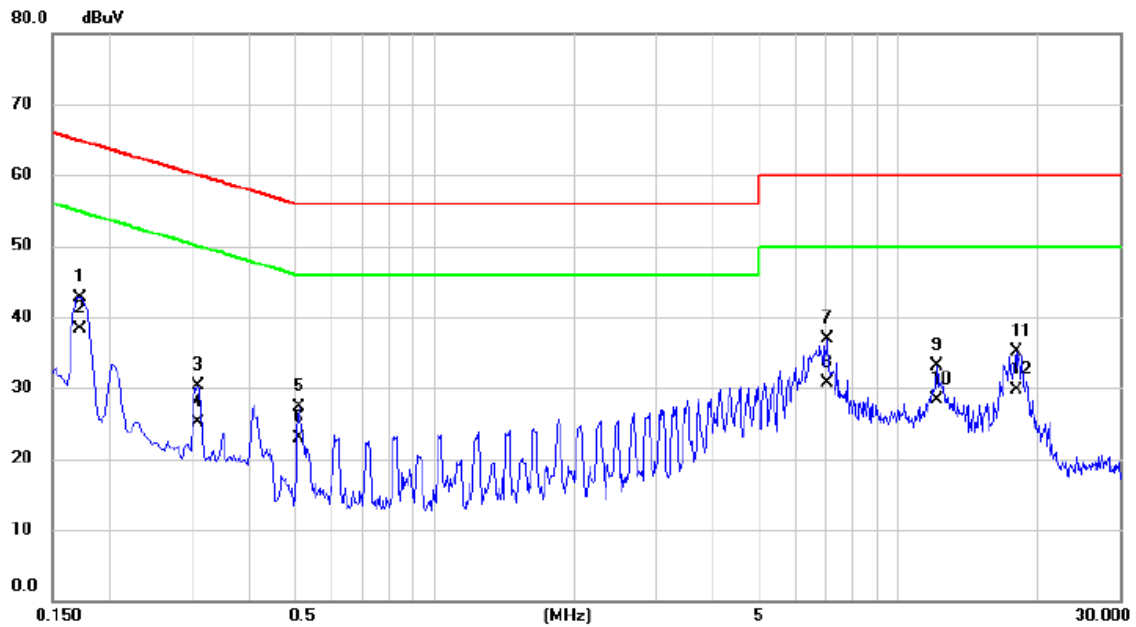

No. Mk.	Freq. MHz	Reading Level dBuV	Correct Factor dB	Measurement dBuV	Limit dBuV	Margin dB	Detector	Comment
1	0.1725	33.10	9.69	42.79	64.84	-22.05	QP	
2 *	0.1725	28.60	9.69	38.29	54.84	-16.55	AVG	
3	0.3097	20.67	9.71	30.38	59.98	-29.60	QP	
4	0.3097	15.40	9.71	25.11	49.98	-24.87	AVG	
5	0.5100	17.53	9.75	27.28	56.00	-28.72	QP	
6	0.5100	13.20	9.75	22.95	46.00	-23.05	AVG	
7	7.0260	26.76	10.22	36.98	60.00	-23.02	QP	
8	7.0260	20.40	10.22	30.62	50.00	-19.38	AVG	
9	12.1088	22.51	10.50	33.01	60.00	-26.99	QP	
10	12.1088	17.80	10.50	28.30	50.00	-21.70	AVG	
11	17.9408	24.16	10.86	35.02	60.00	-24.98	QP	
12	17.9408	18.90	10.86	29.76	50.00	-20.24	AVG	

Test Voltage	AC 230V/50Hz	Phase	Neutral
Test Mode	Mode 1		

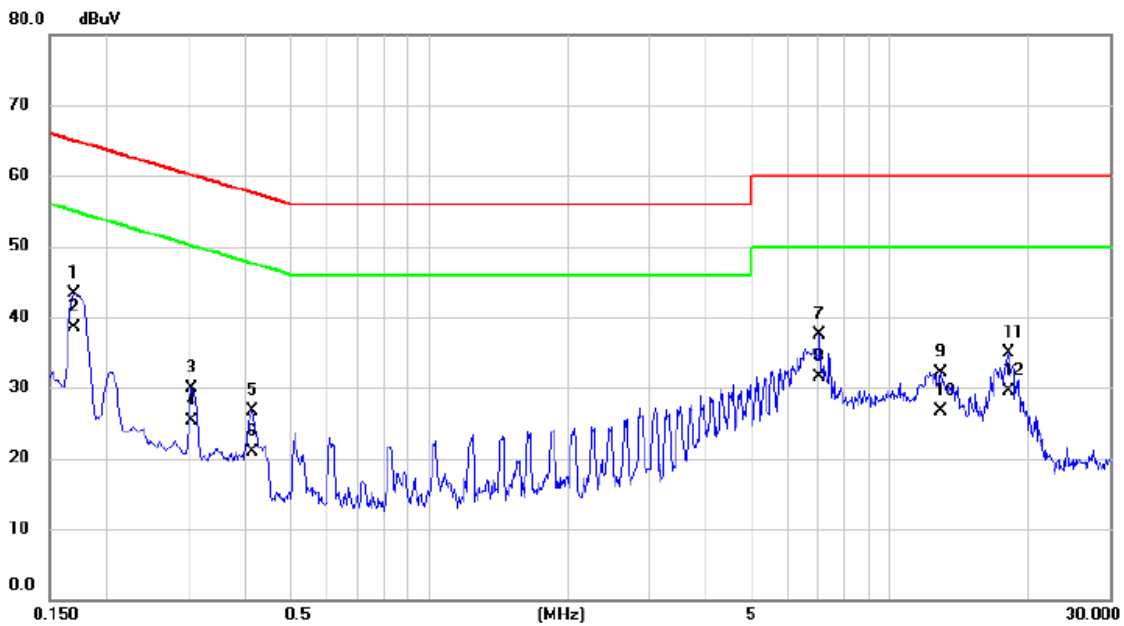

No.	Mk.	Freq. MHz	Reading Level dBuV	Correct Factor dB	Measure- ment dBuV	Limit dBuV	Margin dB	Detector	Comment
1		0.1703	33.60	9.69	43.29	64.95	-21.66	QP	
2	*	0.1703	28.90	9.69	38.59	54.95	-16.36	AVG	
3		0.3052	20.11	9.71	29.82	60.10	-30.28	QP	
4		0.3052	15.60	9.71	25.31	50.10	-24.79	AVG	
5		0.4132	16.89	9.75	26.64	57.58	-30.94	QP	
6		0.4132	11.20	9.75	20.95	47.58	-26.63	AVG	
7		7.0395	27.26	10.23	37.49	60.00	-22.51	QP	
8		7.0395	21.30	10.23	31.53	50.00	-18.47	AVG	
9		12.9008	21.50	10.56	32.06	60.00	-27.94	QP	
10		12.9008	16.20	10.56	26.76	50.00	-23.24	AVG	
11		18.1365	24.08	10.92	35.00	60.00	-25.00	QP	
12		18.1365	18.50	10.92	29.42	50.00	-20.58	AVG	

4. EMC EMISSION TEST- EN 55032:2015+A11:2020

4.1 RADIATED EMISSIONS UP TO 1 GHZ

4.1.1 LIMITS

Class B equipment up to 1 GHz

Frequency Range MHz	Measurement			Class B limits dB(μV/m)
	Facility	Distance m	Detector type/ bandwidth	
30 - 230	SAC	10	Quasi peak / 120 kHz	30
230 - 1000				37

Notes:

- (1) The limit for radiated test was performed according to as following: EN 55032
- (2) The tighter limit applies at the band edges.
- (3) Emission level (dBuV/m)=20log Emission level (uV/m).
- (4) The test result calculated as following:
 Measurement Value = Reading Level + Correct Factor
 Correct Factor = Antenna Factor + Cable Loss - Amplifier Gain(if use)
 Margin Level = Measurement Value - Limit Value

4.1.2 MEASUREMENT INSTRUMENTS LIST

Item	Kind of Equipment	Manufacturer	Type No.	Serial No.	Calibrated until
1	Receiver	Keysight	N9038A	MY54450004	Jun. 16, 2024
2	Pre-Amplifier	EMC INSTRUMENT	EMC 9135	980284	Jun. 16, 2024
3	Pre-Amplifier	EMC INSTRUMENT	EMC 9135	980283	Jun. 16, 2024
4	Trilog-Broadband Antenna	Schwarzbeck	VULB9168	947	Nov. 01, 2023
5	Trilog-Broadband Antenna	Schwarzbeck	VULB9168	946	Aug. 10, 2024
6	Measurement Software	Farad	EZ-EMC Ver.BTL-2ANT-1	N/A	N/A
7	Multi-Device Controller	ETS-Lindgren	2090	N/A	N/A
8	Controller	MF	MF-7802	MF780208159	N/A
9	Attenuator	EMCI	EMCI-N-6-06	AT-N0671	Aug. 10, 2024
10	Attenuator	EMCI	EMCI-N-6-06	AT-N0670	Nov. 01, 2023
11	Cable	RW	LMR400-NMNM-10M	N/A	Dec. 05, 2023
12	Cable	RW	LMR400-NMNM-7M	N/A	Dec. 05, 2023
13	Cable	RW	LMR400-NMNM-3.5 M	N/A	Dec. 05, 2023
14	Cable	RW	LMR400-NMNM-8M	N/A	Dec. 05, 2023
15	Cable	RW	LMR400-NMNM-7M	N/A	Dec. 05, 2023
16	Cable	RW	LMR400-NMNM-3.5 M	N/A	Dec. 05, 2023
17	Receiver	Agilent	N9038A	MY52130039	Jan. 07, 2024

Remark: "N/A" denotes no model name, no serial no. or no calibration specified.

All calibration period of equipment list is one year.

4.1.3 TEST PROCEDURE

- The measuring distance of 10 m shall be used for measurements. The EUT was placed on the top of a rotating table 0.8 meter above the ground at a 10 meter semi-anechoic chamber. The table was rotated 360 degrees to determine the position of the highest radiation.
- The height of the equipment or of the substitution antenna shall be 0.8 m, the height of the test antenna shall vary between 1 m to 4 m. Both horizontal and vertical polarizations of the antenna are set to make the measurement.
- The initial step in collecting radiated emission data is a receiver peak detector mode pre-scanning the measurement frequency range. Significant peaks are then marked and then Quasi Peak detector mode re-measured.
- All readings are Peak unless otherwise stated QP in column of Note. Peak denotes that the Peak reading compliance with the QP Limits and then QP Mode measurement didn't perform.
- For the actual test configuration, please refer to the related Item - EUT Test Photos.

4.1.4 DEVIATION FROM TEST STANDARD

No deviation

4.1.5 TEST SETUP

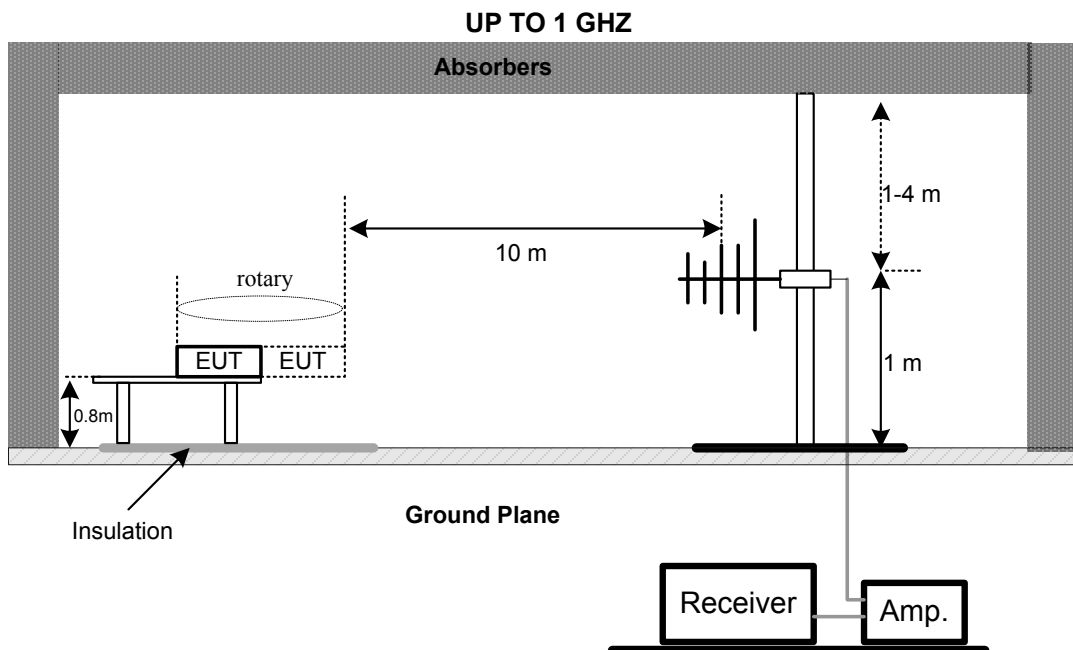

4.1.6 MEASUREMENT DISTANCE

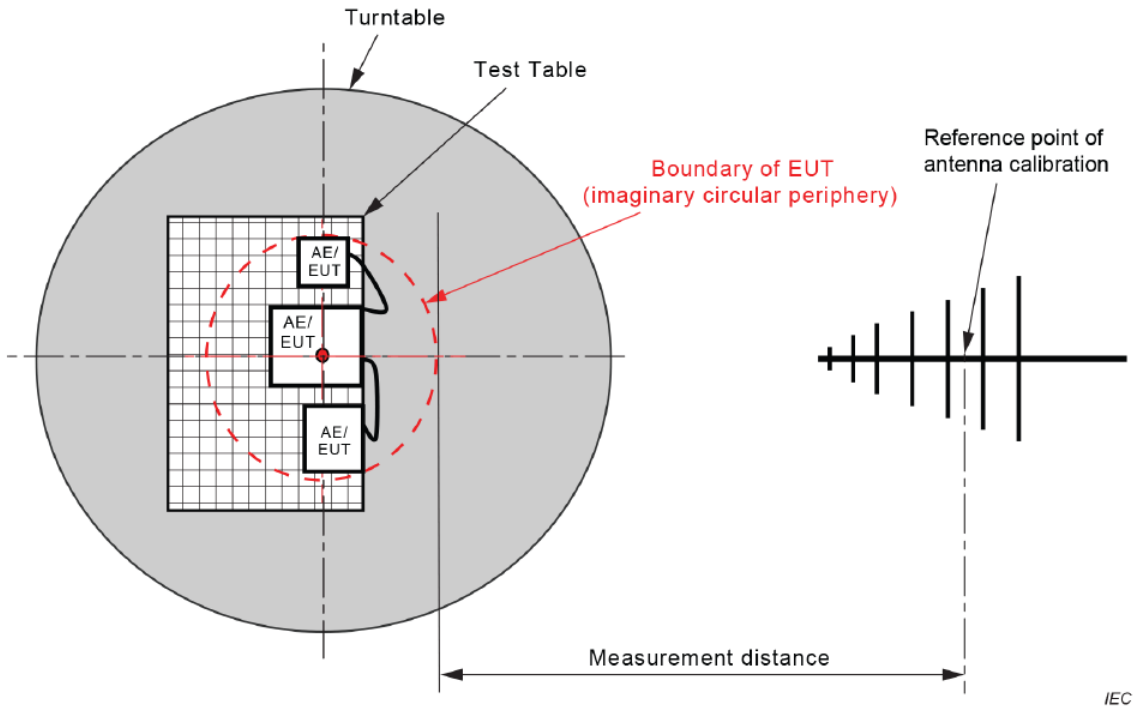

Figure C.1 – Measurement distance

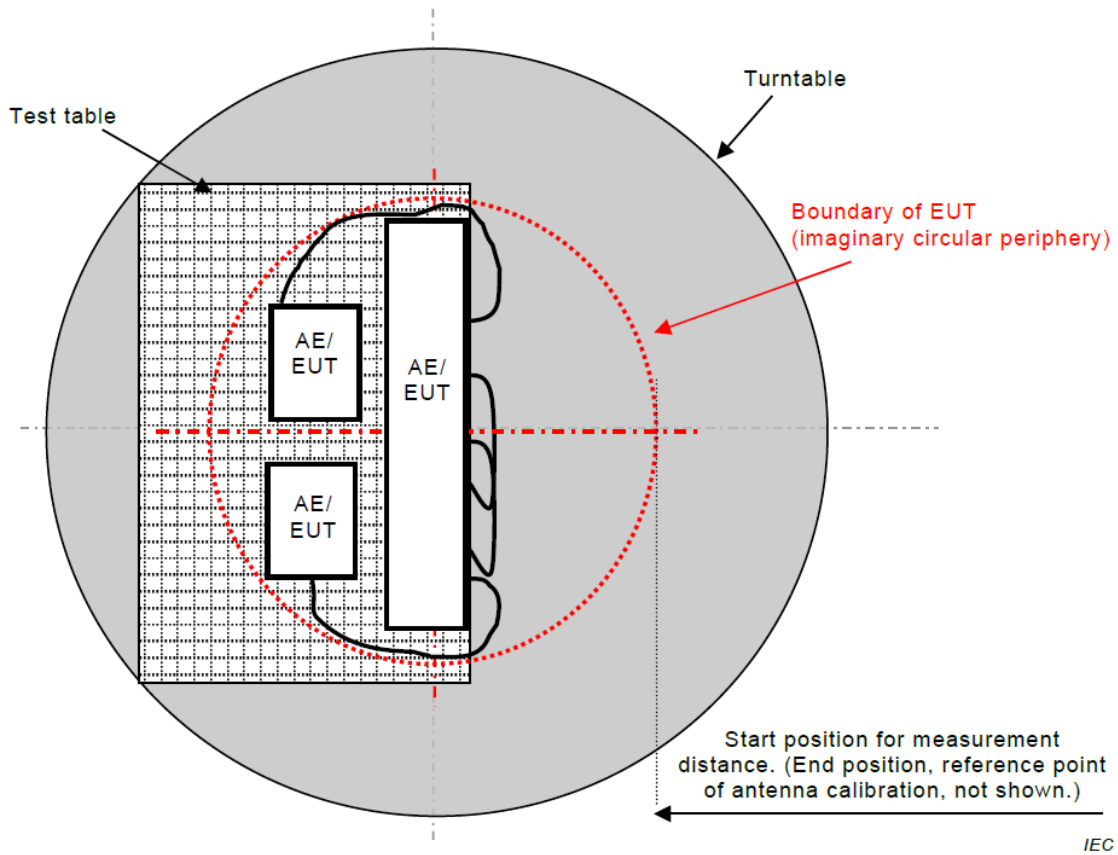
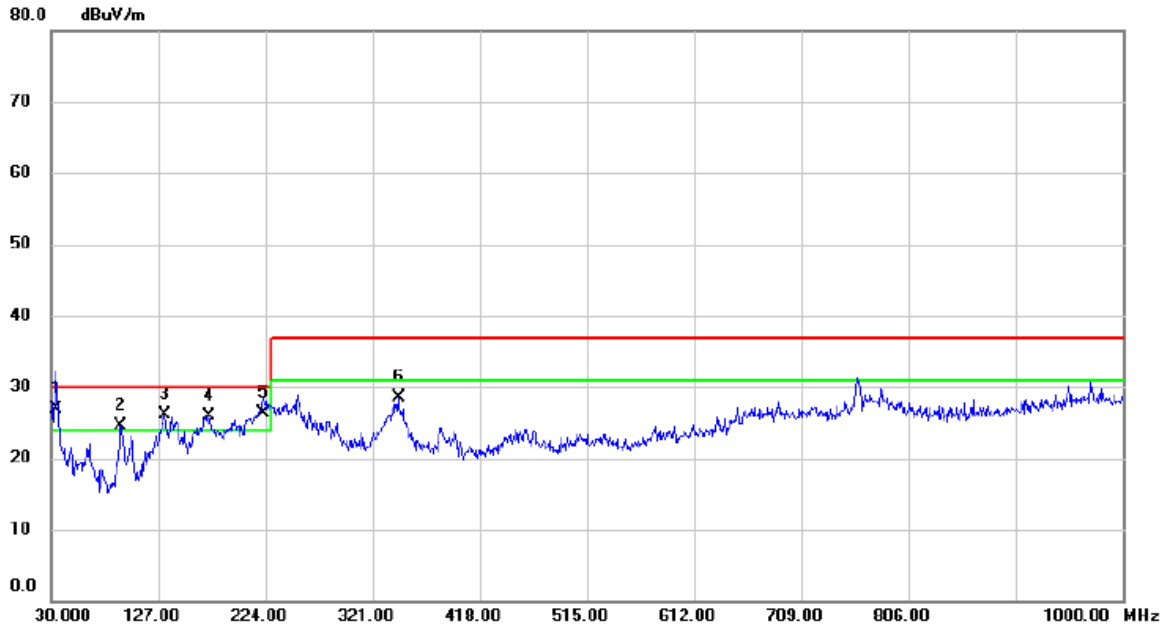

Figure C.2 – Boundary of EUT, Local AE and associated cabling

4.1.7 TEST RESULTS

Test Voltage	AC 230V/50Hz	Polarization	Vertical
Test Mode	Mode 1		



No.	Mk.	Freq. MHz	Reading Level dBuV	Correct Factor dB	Measure- ment dBuV/m	Limit dBuV/m	Margin dB	Detector	Comment
1	*	33.8800	44.91	-17.98	26.93	30.00	-3.07	QP	
2	!	93.0500	46.87	-22.28	24.59	30.00	-5.41	QP	
3	!	132.8200	44.46	-18.26	26.20	30.00	-3.80	QP	
4	!	172.5900	43.10	-17.15	25.95	30.00	-4.05	QP	
5	!	222.0600	45.93	-19.61	26.32	30.00	-3.68	QP	
6		344.2800	43.05	-14.59	28.46	37.00	-8.54	QP	

Test Voltage	AC 230V/50Hz	Polarization	Horizontal
Test Mode	Mode 1		

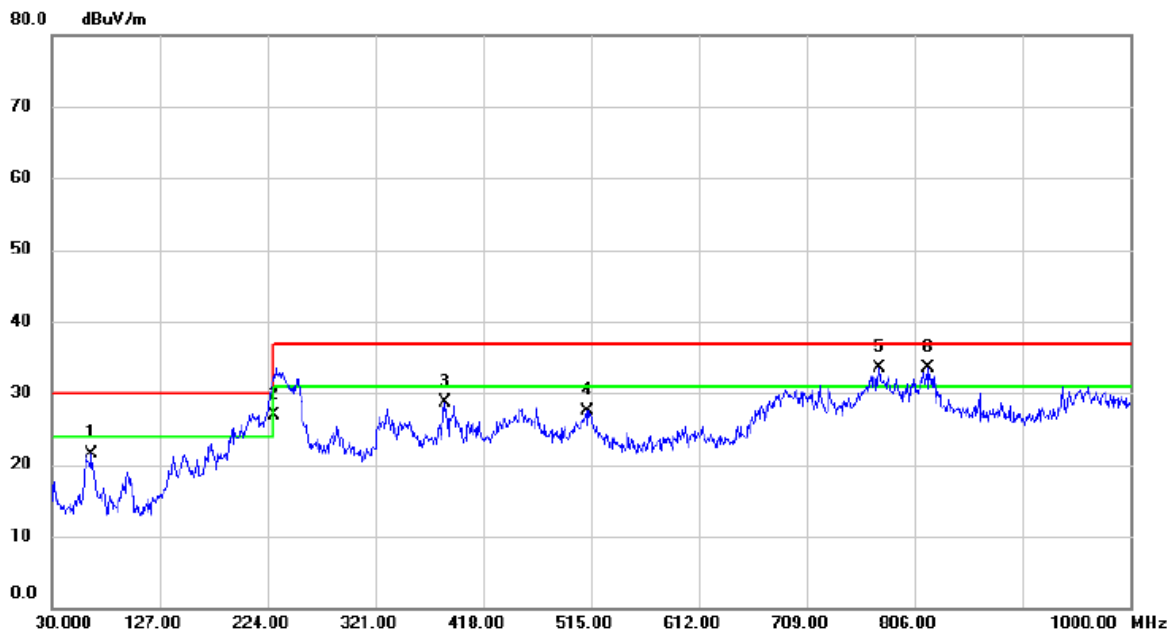

No.	Mk.	Freq. MHz	Reading Level dBuV	Correct Factor dB	Measure- ment dBuV/m	Limit dBuV/m	Margin dB	Detector	Comment
1		65.8900	40.85	-19.26	21.59	30.00	-8.41	QP	
2	*	230.0000	45.57	-18.62	26.95	30.00	-3.05	QP	
3		384.0500	42.19	-13.57	28.62	37.00	-8.38	QP	
4		511.1200	38.62	-11.05	27.57	37.00	-9.43	QP	
5	!	773.9900	41.05	-7.61	33.44	37.00	-3.56	QP	
6	!	817.6400	40.94	-7.45	33.49	37.00	-3.51	QP	

Test Voltage	AC 230V/50Hz	Polarization	Vertical
Test Mode	Mode 2		

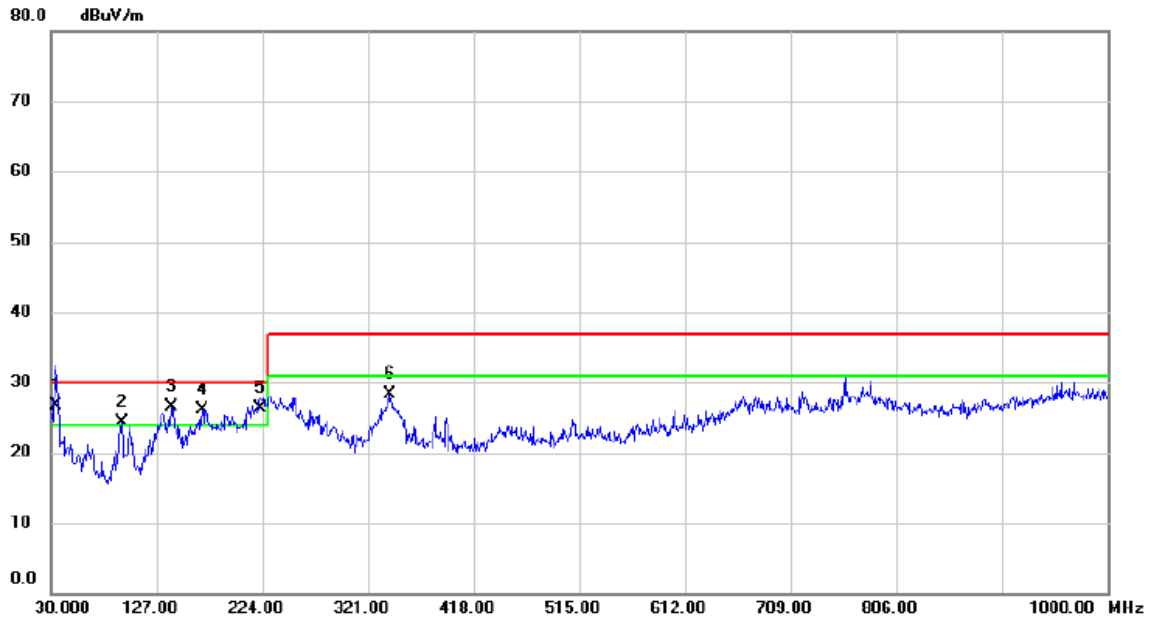

No.	Mk.	Freq. MHz	Reading Level dBuV	Correct Factor dB	Measure- ment dBuV/m	Limit dBuV/m	Margin dB	Detector	Comment
1	*	33.8800	44.63	-17.98	26.65	30.00	-3.35	QP	
2	!	94.9900	46.59	-22.29	24.30	30.00	-5.70	QP	
3	!	140.5800	44.54	-18.04	26.50	30.00	-3.50	QP	
4	!	168.7100	43.10	-16.94	26.16	30.00	-3.84	QP	
5	!	222.0600	45.96	-19.61	26.35	30.00	-3.65	QP	
6		340.4000	43.01	-14.64	28.37	37.00	-8.63	QP	

Test Voltage	AC 230V/50Hz	Polarization	Horizontal
Test Mode	Mode 2		

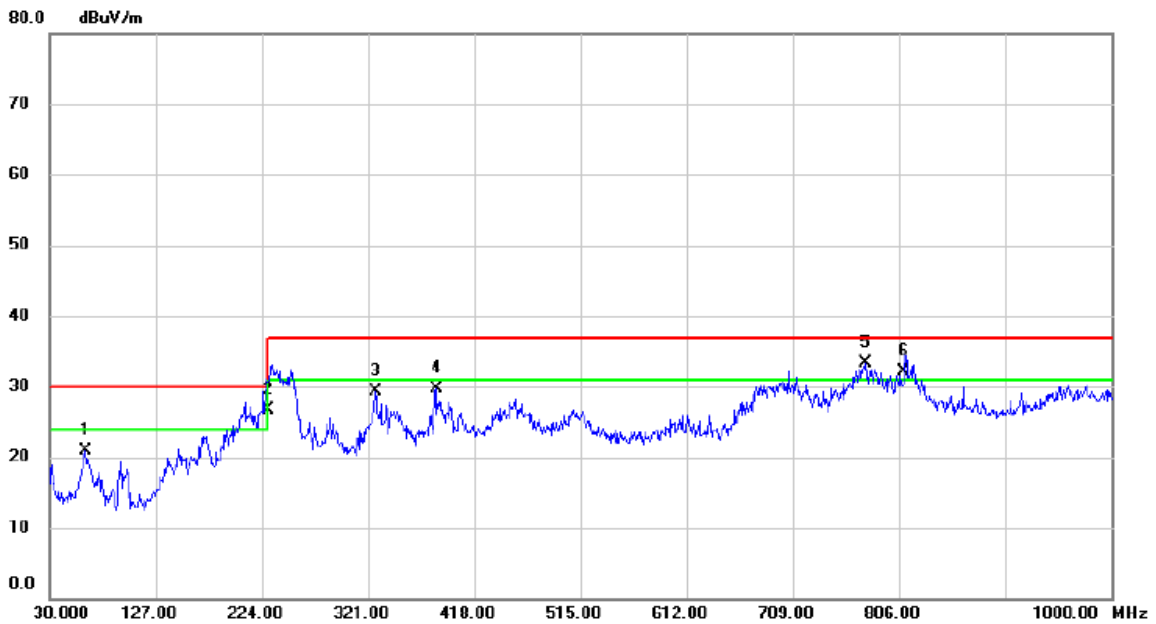

No.	Mk.	Freq. MHz	Reading Level dBuV	Correct Factor dB	Measure- ment dBuV/m	Limit dBuV/m	Margin dB	Detector	Comment
1		62.9800	39.81	-18.92	20.89	30.00	-9.11	QP	
2	*	230.0000	45.27	-18.62	26.65	30.00	-3.35	QP	
3		327.7900	44.11	-14.90	29.21	37.00	-7.79	QP	
4		383.0800	43.29	-13.60	29.69	37.00	-7.31	QP	
5	!	775.9300	40.96	-7.61	33.35	37.00	-3.65	QP	
6	!	810.8500	39.65	-7.51	32.14	37.00	-4.86	QP	

Test Voltage	AC 230V/50Hz	Polarization	Vertical
Test Mode	Mode 5		

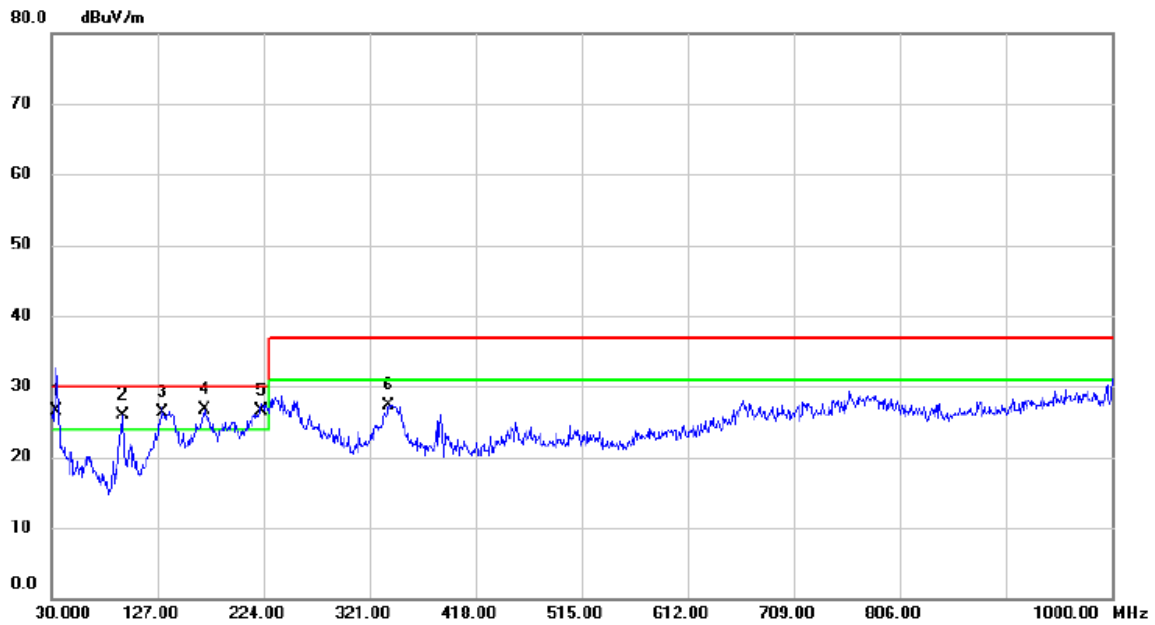

No.	Mk.	Freq. MHz	Reading Level dBuV	Correct Factor dB	Measure- ment dBuV/m	Limit dBuV/m	Margin dB	Detector	Comment
1	!	33.8800	44.51	-17.98	26.53	30.00	-3.47	QP	
2	!	94.9900	48.28	-22.29	25.99	30.00	-4.01	QP	
3	!	131.8500	44.64	-18.29	26.35	30.00	-3.65	QP	
4	*	169.6800	43.66	-16.93	26.73	30.00	-3.27	QP	
5	!	222.0600	46.14	-19.61	26.53	30.00	-3.47	QP	
6		338.4600	42.00	-14.69	27.31	37.00	-9.69	QP	

Test Voltage	AC 230V/50Hz	Polarization	Horizontal
Test Mode	Mode 5		

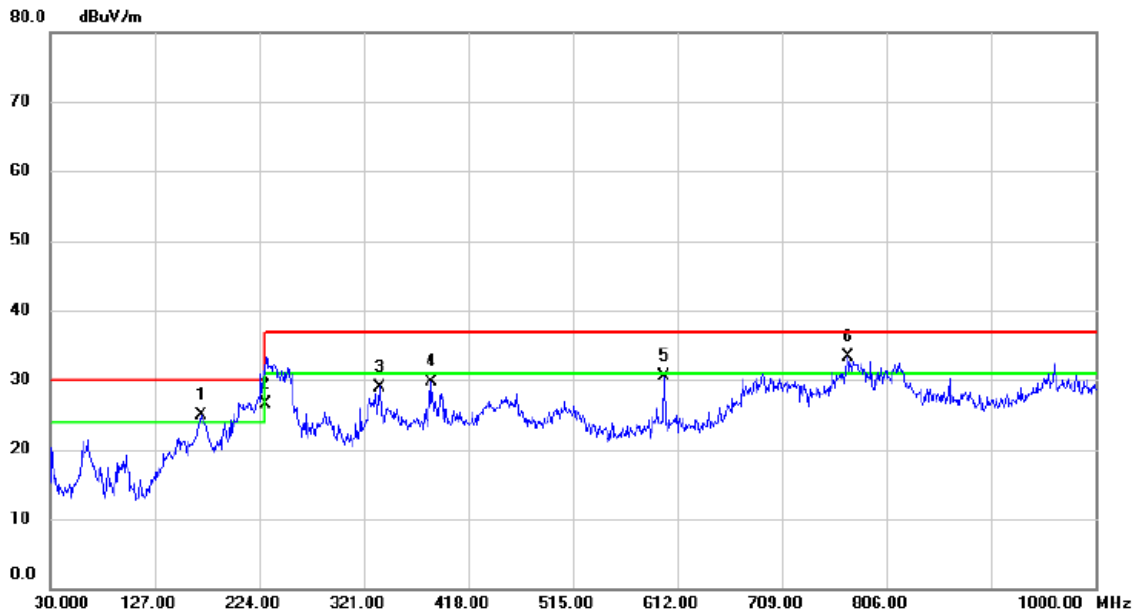

No.	Mk.	Freq. MHz	Reading Level dBuV	Correct Factor dB	Measure- ment dBuV/m	Limit dBuV/m	Margin dB	Detector	Comment
1	!	170.6500	41.31	-16.44	24.87	30.00	-5.13	QP	
2	*	230.0000	45.18	-18.62	26.56	30.00	-3.44	QP	
3		335.5500	43.72	-14.72	29.00	37.00	-8.00	QP	
4		383.0800	43.21	-13.60	29.61	37.00	-7.39	QP	
5		599.3900	39.61	-9.18	30.43	37.00	-6.57	QP	
6	!	770.1100	40.90	-7.60	33.30	37.00	-3.70	QP	

Test Voltage	AC 230V/50Hz	Polarization	Vertical
Test Mode	Mode 16		

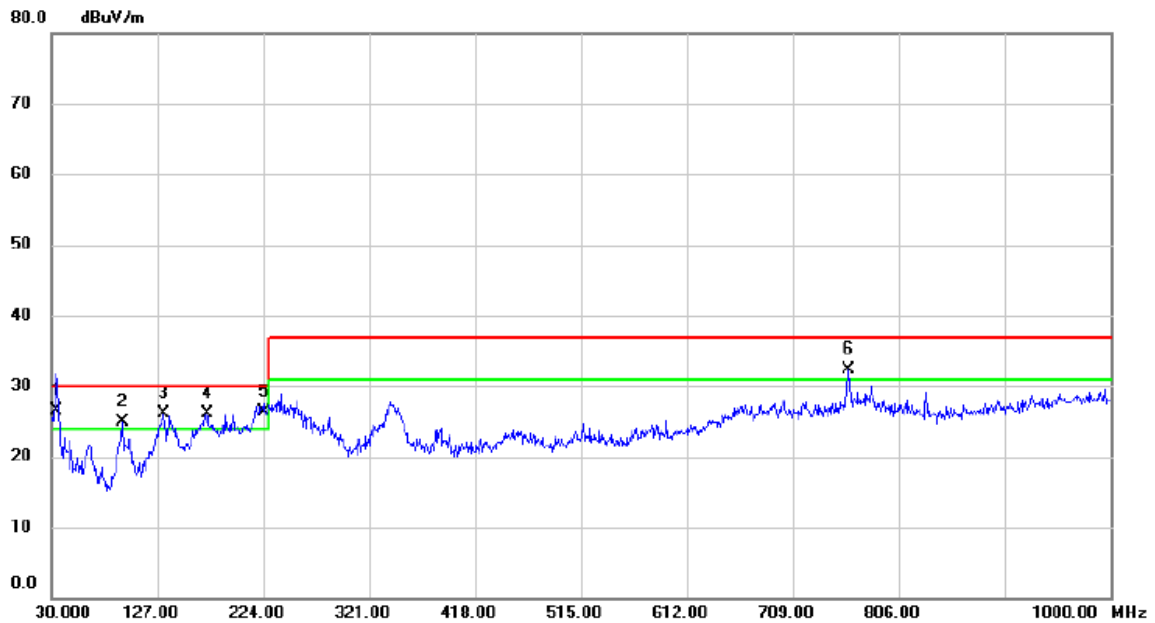

No.	Mk.	Freq. MHz	Reading Level dBuV	Correct Factor dB	Measure- ment dBuV/m	Limit dBuV/m	Margin dB	Detector	Comment
1	*	33.8800	44.51	-17.98	26.53	30.00	-3.47	QP	
2	!	94.9900	47.20	-22.29	24.91	30.00	-5.09	QP	
3	!	132.8200	44.44	-18.26	26.18	30.00	-3.82	QP	
4	!	172.5900	43.17	-17.15	26.02	30.00	-3.98	QP	
5	!	224.0000	45.75	-19.45	26.30	30.00	-3.70	QP	
6	!	760.4100	39.85	-7.50	32.35	37.00	-4.65	QP	

Test Voltage	AC 230V/50Hz	Polarization	Horizontal
Test Mode	Mode 16		

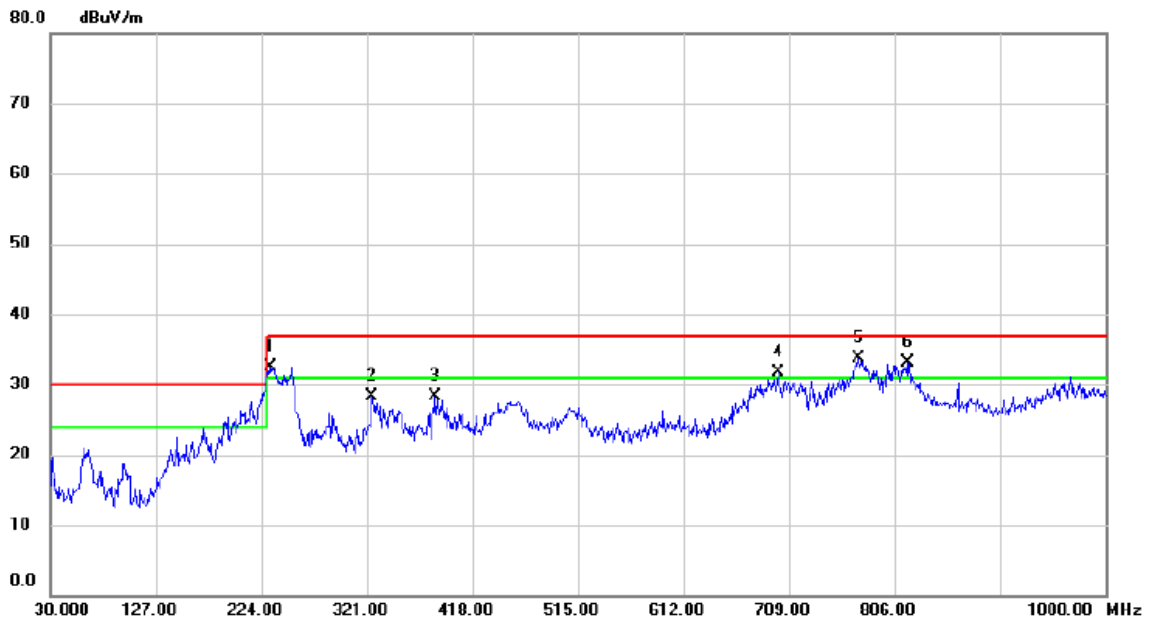

No.	Mk.	Freq. MHz	Reading Level dBuV	Correct Factor dB	Measure- ment dBuV/m	Limit dBuV/m	Margin dB	Detector	Comment
1	!	231.7600	50.92	-18.50	32.42	37.00	-4.58	QP	
2		325.8500	43.26	-14.93	28.33	37.00	-8.67	QP	
3		384.0500	41.91	-13.57	28.34	37.00	-8.66	QP	
4	!	699.3000	39.92	-8.30	31.62	37.00	-5.38	QP	
5	*	773.0200	41.37	-7.61	33.76	37.00	-3.24	QP	
6	!	817.6400	40.65	-7.45	33.20	37.00	-3.80	QP	

Test Voltage	AC 110V/60Hz	Polarization	Vertical
Test Mode	Mode 1		

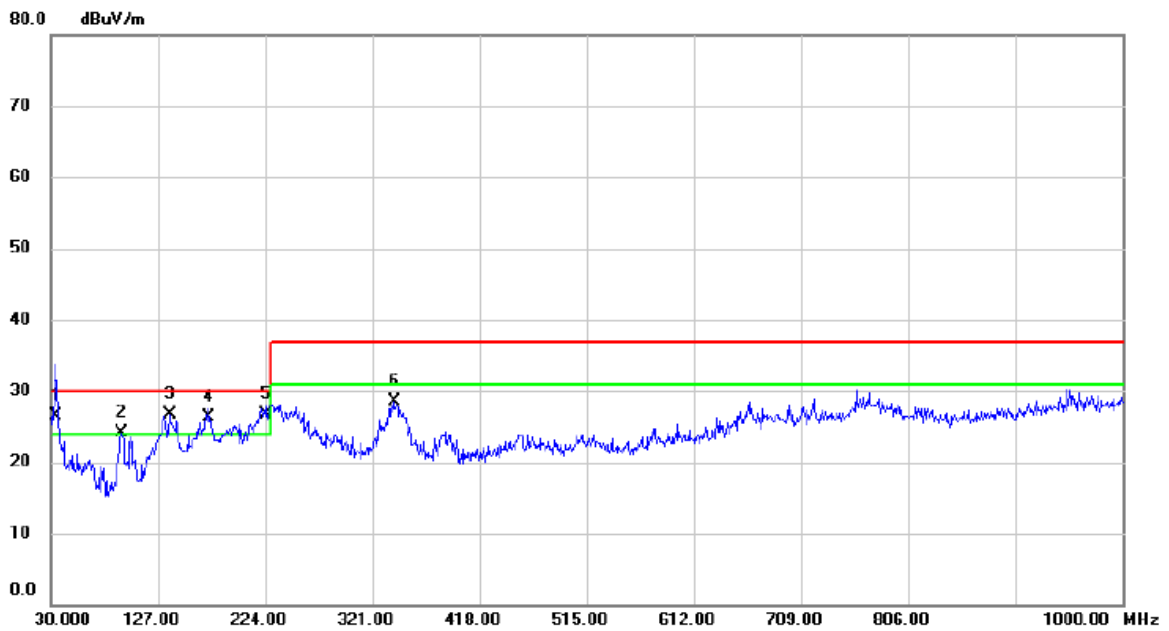

No.	Mk.	Freq. MHz	Reading Level dBuV	Correct Factor dB	Measure- ment dBuV/m	Limit dBuV/m	Margin dB	Detector	Comment
1	!	33.8800	44.54	-17.98	26.56	30.00	-3.44	QP	
2	!	94.0200	46.31	-22.28	24.03	30.00	-5.97	QP	
3	!	137.6700	44.77	-18.13	26.64	30.00	-3.36	QP	
4	!	172.5900	43.45	-17.15	26.30	30.00	-3.70	QP	
5	*	224.0000	46.11	-19.45	26.66	30.00	-3.34	QP	
6		340.4000	43.13	-14.64	28.49	37.00	-8.51	QP	

Test Voltage	AC 110V/60Hz	Polarization	Horizontal
Test Mode	Mode 1		

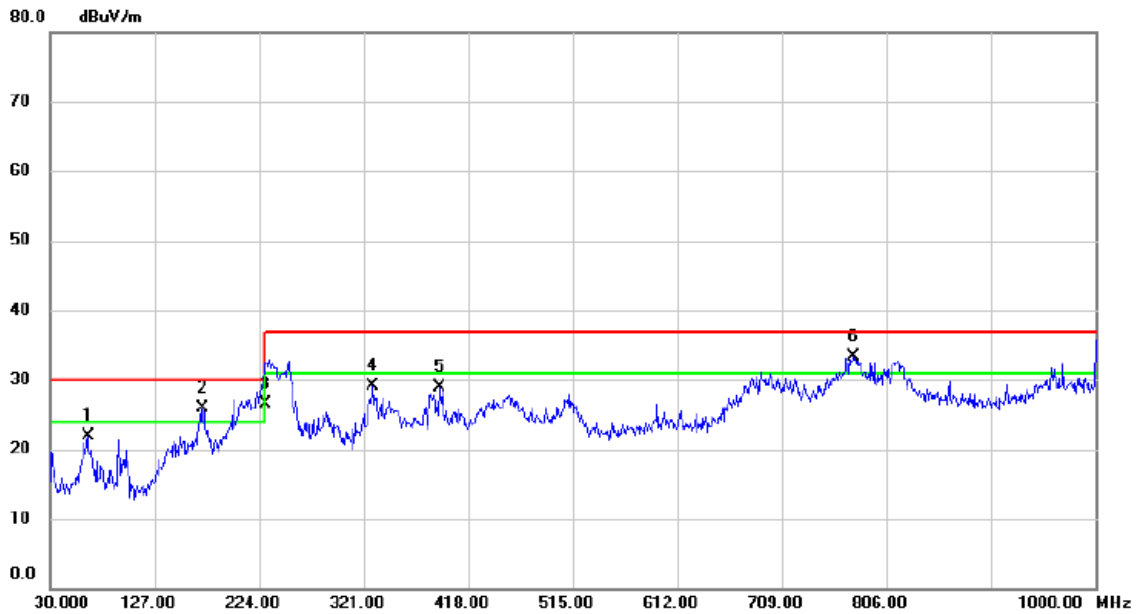

No.	Mk.	Freq. MHz	Reading Level dBuV	Correct Factor dB	Measure- ment dBuV/m	Limit dBuV/m	Margin dB	Detector	Comment
1		64.9200	41.05	-19.12	21.93	30.00	-8.07	QP	
2	!	172.1050	42.43	-16.54	25.89	30.00	-4.11	QP	
3	*	230.0000	45.18	-18.62	26.56	30.00	-3.44	QP	
4		329.7300	43.89	-14.85	29.04	37.00	-7.96	QP	
5		390.8400	42.21	-13.38	28.83	37.00	-8.17	QP	
6	!	775.9300	40.84	-7.61	33.23	37.00	-3.77	QP	

4.2 RADIATED EMISSIONS ABOVE 1 GHZ

4.2.1 LIMITS

Class B equipment above 1 GHz

Frequency Range MHz	Measurement			Class B limits dB(μ V/m)
	Facility	Distance m	Detector type/bandwidth	
1000 - 3000	FSOATS	3	Average / 1 MHz	50
3000 - 6000				54
1000 - 3000			Peak / 1 MHz	70
3000 - 6000				74

Notes:

- (1) The limit for radiated test was performed according to as following: EN 55032
- (2) The tighter limit applies at the band edges.
- (3) Emission level (dB μ V/m)=20log Emission level (μ V/m).
- (4) The test result calculated as following:
 Measurement Value = Reading Level + Correct Factor
 Correct Factor = Antenna Factor + Cable Loss - Amplifier Gain(if use)
 Margin Level = Measurement Value - Limit Value

Required highest frequency for radiated measurement

Highest internal frequency (F_x)	Highest measured frequency
$F_x \leq 108$ MHz	1 GHz
$108 < F_x \leq 500$ MHz	2 GHz
$500 < F_x \leq 1000$ MHz	5 GHz
$F_x > 1$ GHz	5 x F_x up to a maximum of 6 GHz

4.2.2 MEASUREMENT INSTRUMENTS LIST

Item	Kind of Equipment	Manufacturer	Type No.	Serial No.	Calibrated until
1	Horn Antenna	EMCO	3115	9605-4803	Jun. 17, 2024
2	Amplifier	Agilent	8449B	3008A02333	Jan. 07, 2024
3	Measurement Software	Farad	EZ-EMC Ver.BTL-2ANT-1	N/A	N/A
4	Multi-Device Controller	ETS-Lindgren	2090	N/A	N/A
5	Controller	MF	MF-7802	MF780208159	N/A
6	Receiver	Agilent	N9038A	MY52130039	Jan. 07, 2024
7	Cable	RW	RWLP50-4.0A-N MRASM-4M	N/A	Jul. 30, 2024
8	Cable	RW	RWLP50-4.0A-N MRASM-12M	N/A	Jul. 30, 2024
9	Cable	RW	RWLP50-4.0A-N MRASM-1M	N/A	Jul. 30, 2024
10	Horn Antenna	EMCO	3115	9605-4803	Jun. 17, 2024

Remark: "N/A" denotes no model name, no serial no. or no calibration specified.

All calibration period of equipment list is one year.

4.2.3 TEST PROCEDURE

- The measuring distance of 3 m shall be used for measurements. The EUT was placed on the top of a rotating table 0.8 meter above the ground at a 10 meter semi-anechoic chamber. The table was rotated 360 degrees to determine the position of the highest radiation.
- The height of the equipment or of the substitution antenna shall be 0.8 m, the height of the test antenna shall vary between 1 m to 4 m. Both horizontal and vertical polarizations of the antenna are set to make the measurement.
- The initial step in collecting radiated emission data is a receiver peak detector mode pre-scanning the measurement frequency range. Significant peaks are then marked and then AVG detector mode re-measured.
- All readings are Peak Mode value unless otherwise stated AVG in column of Note. If the Peak Mode Measured value compliance with the Peak Limits and lower than AVG Limits, the EUT shall be deemed to meet both Peak & AVG Limits and then only Peak Mode was measured, but AVG Mode didn't perform.
- For the actual test configuration, please refer to the related Item - EUT Test Photos.

4.2.4 DEVIATION FROM TEST STANDARD

The limit of the EN 55032:2015+A1:2020&AS/NZS CISPR 32:2015+AMD1:2020&CISPR 32:2015+AMD1:2019 standard deviates from the requirements, but the limit of the EN 55032:2015+A11:2020 standard is more stringent and can be covered, so the test data meets the EN 55032:2015+A1:2020 &AS/NZS CISPR 32:2015+AMD1:2020&CISPR 32:2015+AMD1:2019 standard.

4.2.5 TEST SETUP

ABOVE 1 GHZ

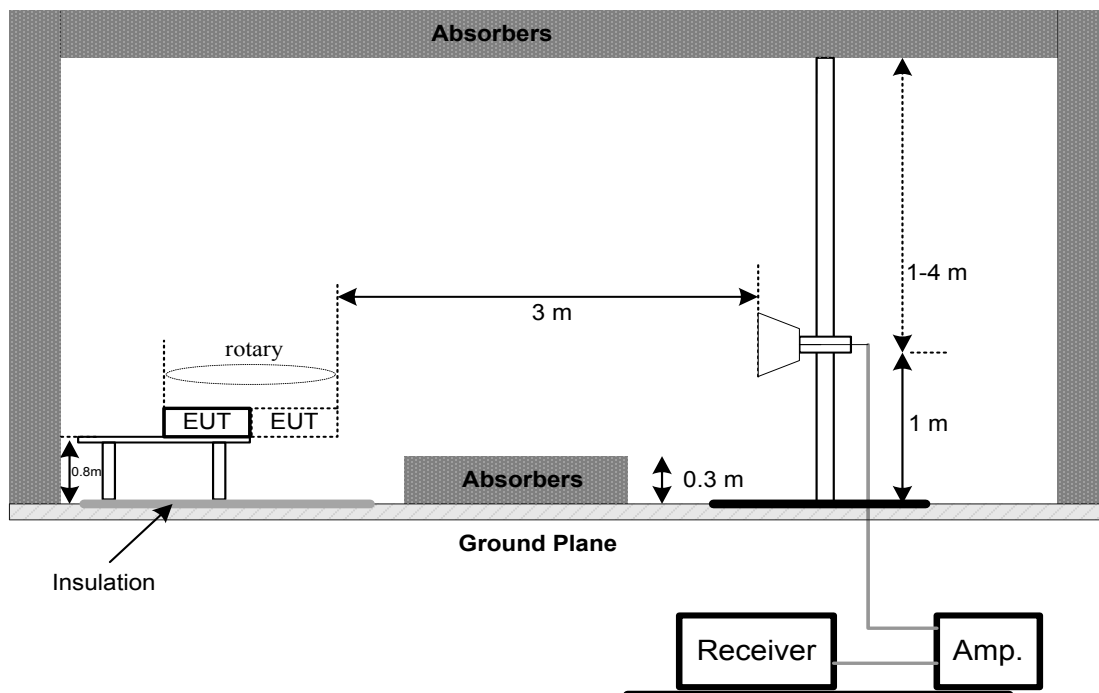

4.2.6 MEASUREMENT DISTANCE

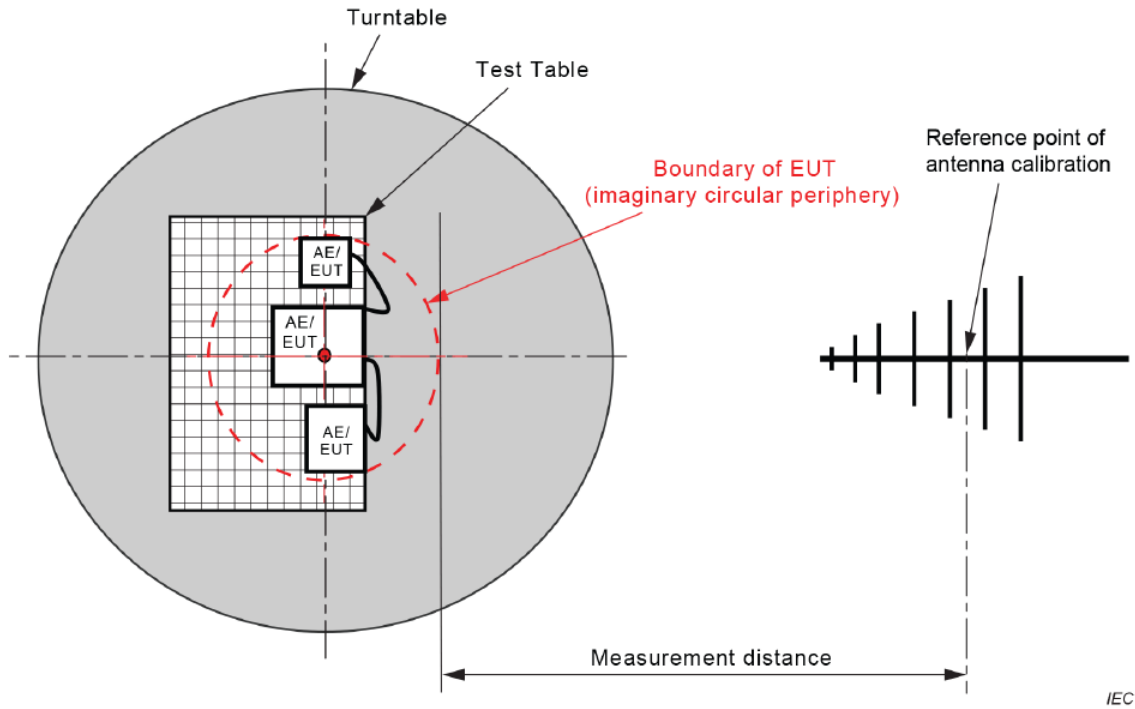

Figure C.1 – Measurement distance

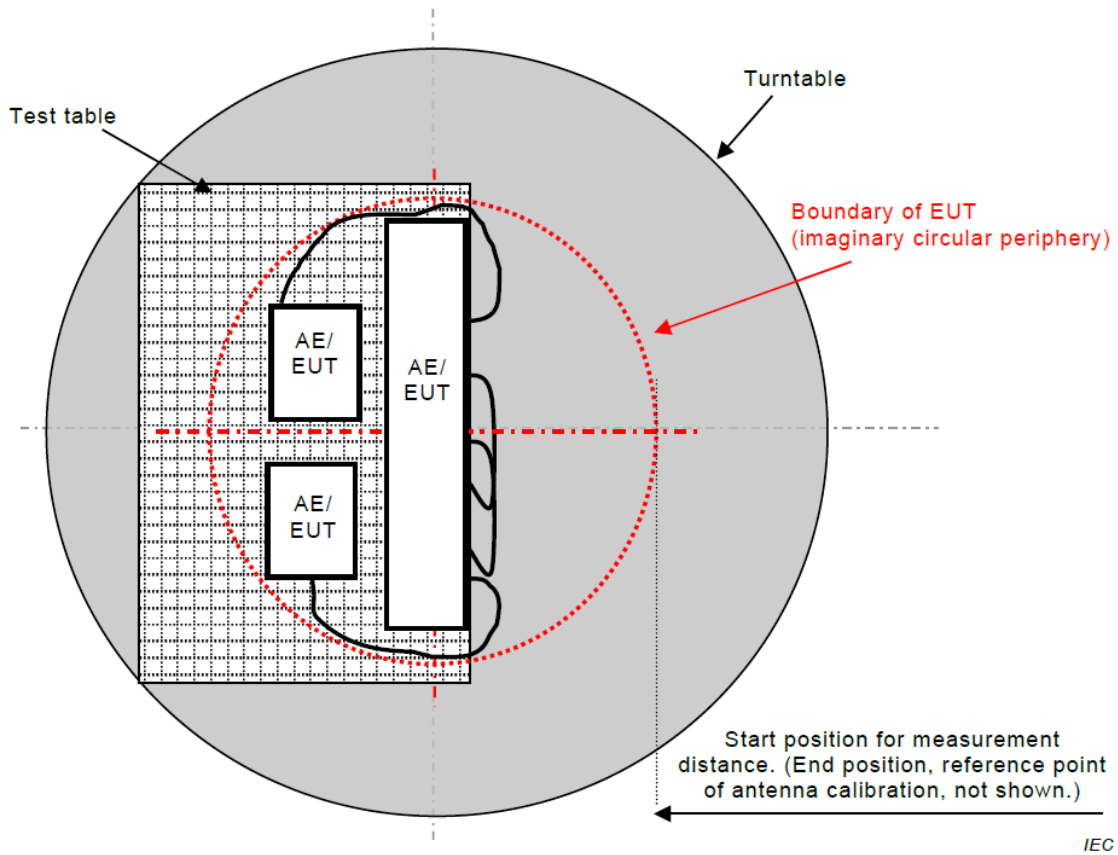
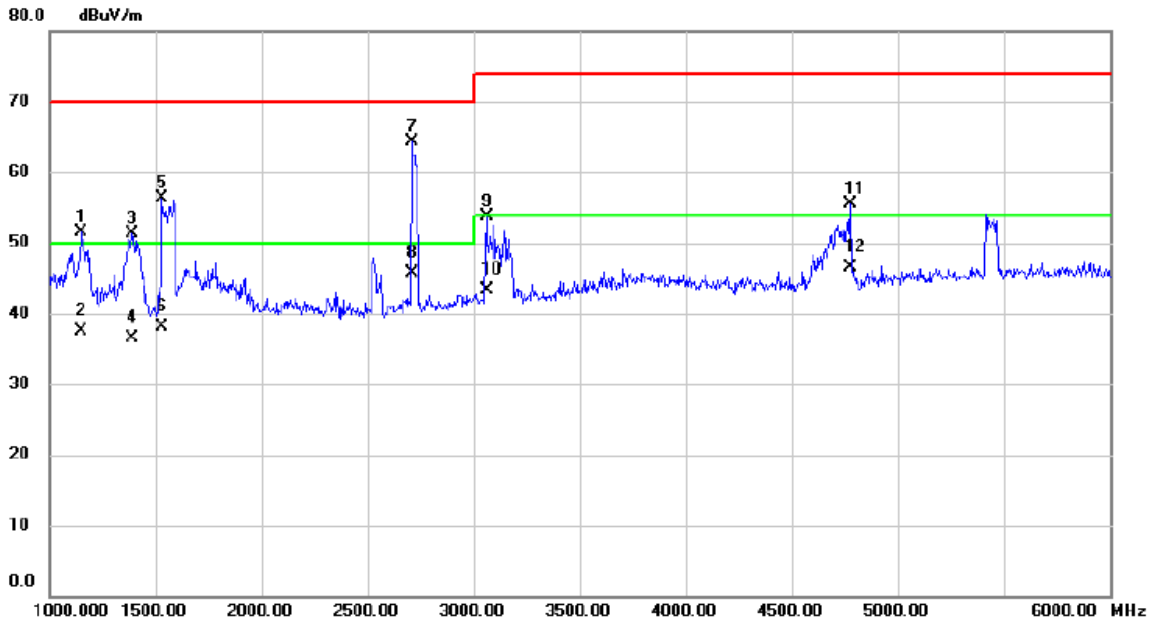

Figure C.2 – Boundary of EUT, Local AE and associated cabling

4.2.7 TEST RESULTS

Test Voltage	AC 230V/50Hz	Polarization	Vertical
Test Mode	Mode 1		



No.	Mk.	Freq. MHz	Reading Level dBuV	Correct Factor dB	Measure- ment dBuV/m	Limit dBuV/m	Margin dB	Detector	Comment
1		1152.500	55.90	-4.42	51.48	70.00	-18.52	peak	
2		1152.500	41.83	-4.42	37.41	50.00	-12.59	AVG	
3		1392.500	54.37	-3.00	51.37	70.00	-18.63	peak	
4		1392.500	39.50	-3.00	36.50	50.00	-13.50	AVG	
5		1530.000	58.41	-2.17	56.24	70.00	-13.76	peak	
6		1530.000	40.37	-2.17	38.20	50.00	-11.80	AVG	
7		2707.500	61.06	3.16	64.22	70.00	-5.78	peak	
8	*	2707.500	42.63	3.16	45.79	50.00	-4.21	AVG	
9		3060.000	49.09	4.55	53.64	74.00	-20.36	peak	
10		3060.000	38.72	4.55	43.27	54.00	-10.73	AVG	
11		4775.000	46.32	9.15	55.47	74.00	-18.53	peak	
12		4775.000	37.38	9.15	46.53	54.00	-7.47	AVG	

Test Voltage	AC 230V/50Hz	Polarization	Horizontal
Test Mode	Mode 1		

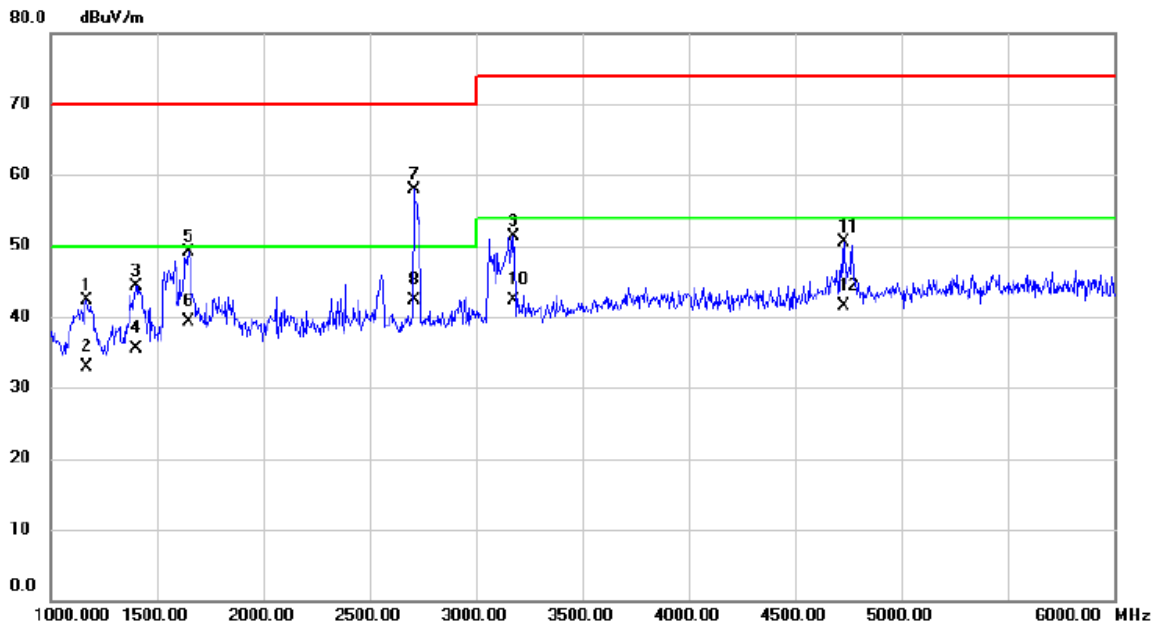

No.	Mk.	Freq. MHz	Reading Level dBuV	Correct Factor dB	Measure- ment dBuV/m	Limit dBuV/m	Margin dB	Detector	Comment
1		1172.500	46.55	-4.30	42.25	70.00	-27.75	peak	
2		1172.500	37.17	-4.30	32.87	50.00	-17.13	AVG	
3		1402.500	47.22	-2.95	44.27	70.00	-25.73	peak	
4		1402.500	38.47	-2.95	35.52	50.00	-14.48	AVG	
5		1650.000	50.38	-1.36	49.02	70.00	-20.98	peak	
6		1650.000	40.66	-1.36	39.30	50.00	-10.70	AVG	
7		2707.500	54.82	3.16	57.98	70.00	-12.02	peak	
8	*	2707.500	39.17	3.16	42.33	50.00	-7.67	AVG	
9		3175.000	46.40	4.98	51.38	74.00	-22.62	peak	
10		3175.000	37.26	4.98	42.24	54.00	-11.76	AVG	
11		4730.000	41.55	9.00	50.55	74.00	-23.45	peak	
12		4730.000	32.55	9.00	41.55	54.00	-12.45	AVG	

Test Voltage	AC 230V/50Hz	Polarization	Vertical
Test Mode	Mode 2		

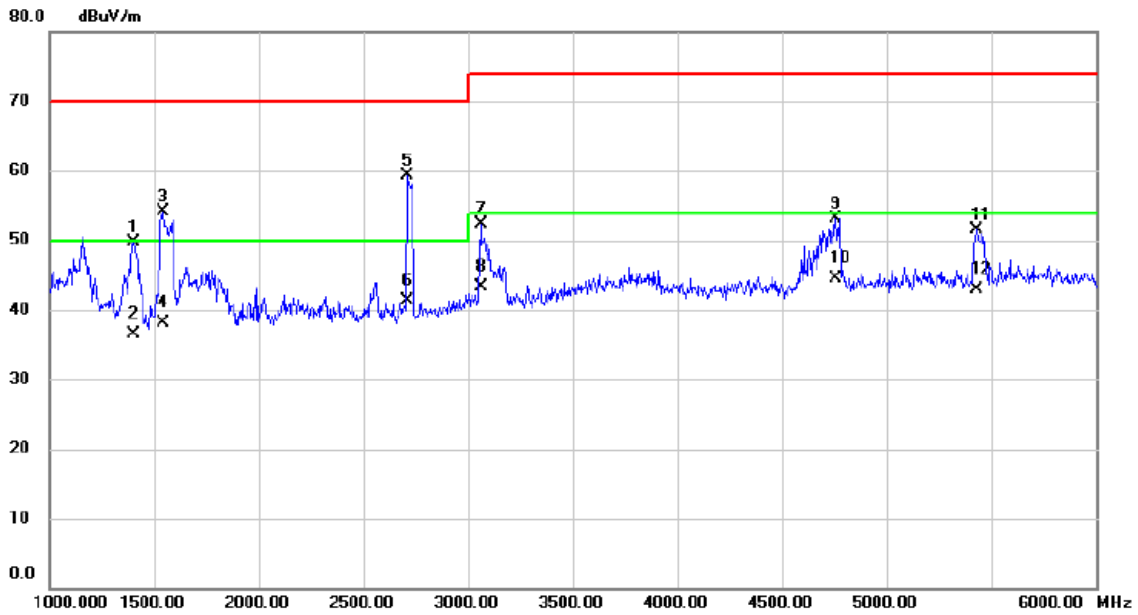

No. Mk.	Freq. MHz	Reading Level dBuV	Correct Factor dB	Measurement dBuV/m	Limit dBuV/m	Margin dB	Detector	Comment
1	1405.000	52.67	-2.93	49.74	70.00	-20.26	peak	
2	1405.000	39.42	-2.93	36.49	50.00	-13.51	AVG	
3	1545.000	56.21	-2.07	54.14	70.00	-15.86	peak	
4	1545.000	40.27	-2.07	38.20	50.00	-11.80	AVG	
5	2707.500	56.20	3.16	59.36	70.00	-10.64	peak	
6 *	2707.500	38.17	3.16	41.33	50.00	-8.67	AVG	
7	3060.000	47.79	4.55	52.34	74.00	-21.66	peak	
8	3060.000	38.74	4.55	43.29	54.00	-10.71	AVG	
9	4757.500	44.05	9.08	53.13	74.00	-20.87	peak	
10	4757.500	35.42	9.08	44.50	54.00	-9.50	AVG	
11	5432.500	40.47	11.13	51.60	74.00	-22.40	peak	
12	5432.500	31.71	11.13	42.84	54.00	-11.16	AVG	

Test Voltage	AC 230V/50Hz	Polarization	Horizontal
Test Mode	Mode 2		

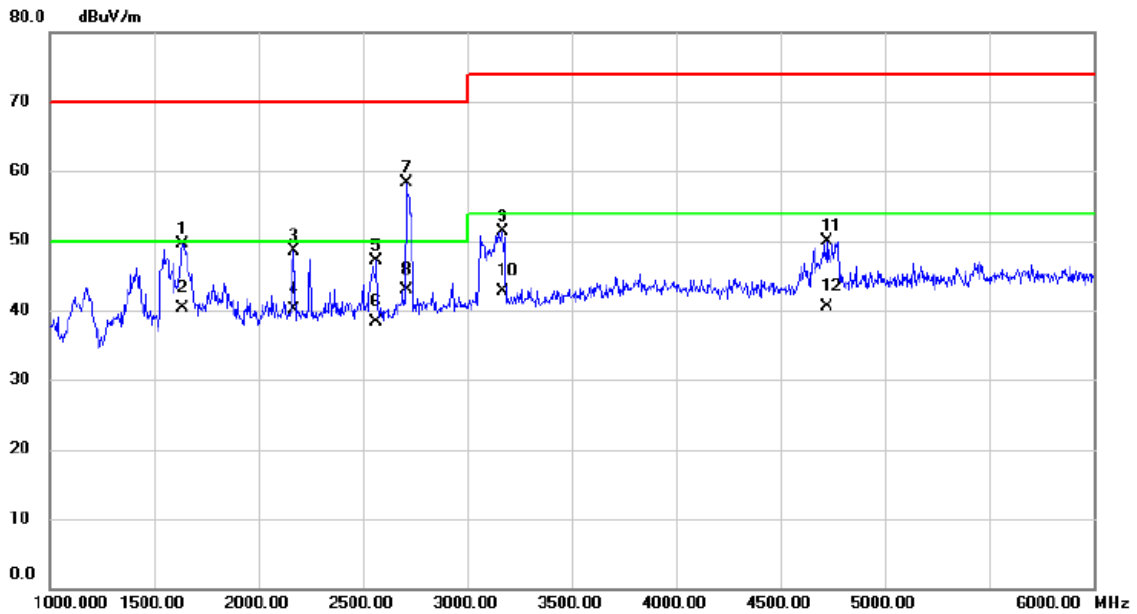

No. Mk.	Freq. MHz	Reading Level dBuV	Correct Factor dB	Measurement dBuV/m	Limit dBuV/m	Margin dB	Detector	Comment
1	1635.000	50.95	-1.47	49.48	70.00	-20.52	peak	
2	1635.000	41.73	-1.47	40.26	50.00	-9.74	AVG	
3	2172.500	47.02	1.46	48.48	70.00	-21.52	peak	
4	2172.500	38.72	1.46	40.18	50.00	-9.82	AVG	
5	2565.000	44.53	2.59	47.12	70.00	-22.88	peak	
6	2565.000	35.72	2.59	38.31	50.00	-11.69	AVG	
7	2707.500	55.17	3.16	58.33	70.00	-11.67	peak	
8 *	2707.500	39.82	3.16	42.98	50.00	-7.02	AVG	
9	3167.500	46.36	4.95	51.31	74.00	-22.69	peak	
10	3167.500	37.85	4.95	42.80	54.00	-11.20	AVG	
11	4725.000	40.87	8.98	49.85	74.00	-24.15	peak	
12	4725.000	31.53	8.98	40.51	54.00	-13.49	AVG	

Test Voltage	AC 230V/50Hz	Polarization	Vertical
Test Mode	Mode 5		

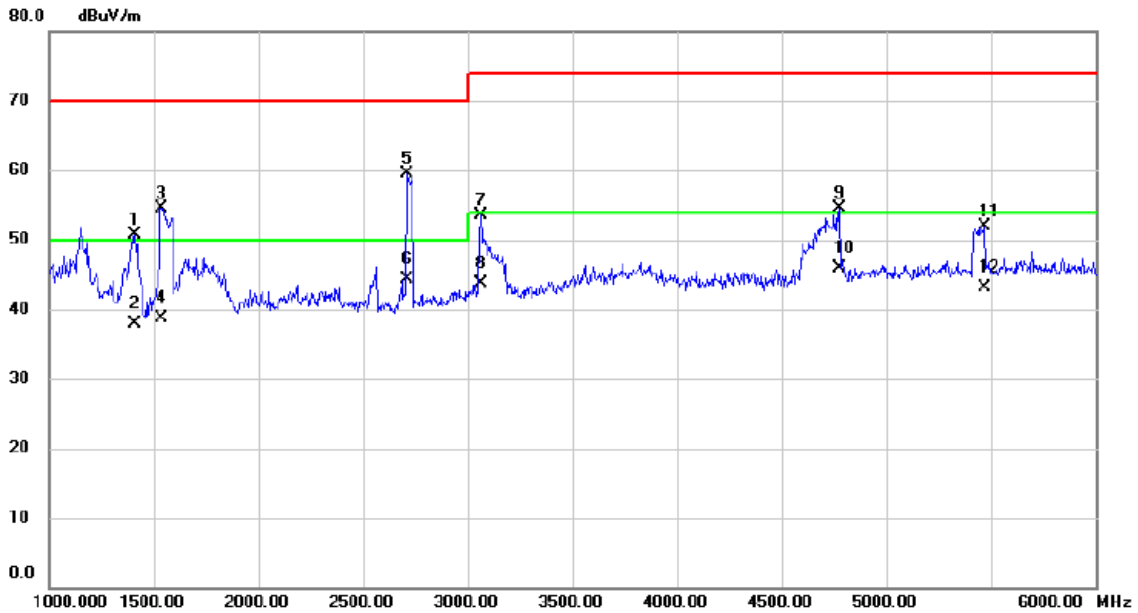

No.	Mk.	Freq. MHz	Reading Level dBuV	Correct Factor dB	Measure- ment dBuV/m	Limit dBuV/m	Margin dB	Detector	Comment
1		1410.000	53.59	-2.91	50.68	70.00	-19.32	peak	
2		1410.000	40.75	-2.91	37.84	50.00	-12.16	AVG	
3		1537.500	56.71	-2.12	54.59	70.00	-15.41	peak	
4		1537.500	40.77	-2.12	38.65	50.00	-11.35	AVG	
5		2707.500	56.29	3.16	59.45	70.00	-10.55	peak	
6	*	2707.500	41.07	3.16	44.23	50.00	-5.77	AVG	
7		3060.000	48.86	4.55	53.41	74.00	-20.59	peak	
8		3060.000	39.17	4.55	43.72	54.00	-10.28	AVG	
9		4775.000	45.34	9.15	54.49	74.00	-19.51	peak	
10		4775.000	36.72	9.15	45.87	54.00	-8.13	AVG	
11		5470.000	40.69	11.24	51.93	74.00	-22.07	peak	
12		5470.000	31.86	11.24	43.10	54.00	-10.90	AVG	

V

Test Voltage	AC 230V/50Hz	Polarization	Horizontal
Test Mode	Mode 5		

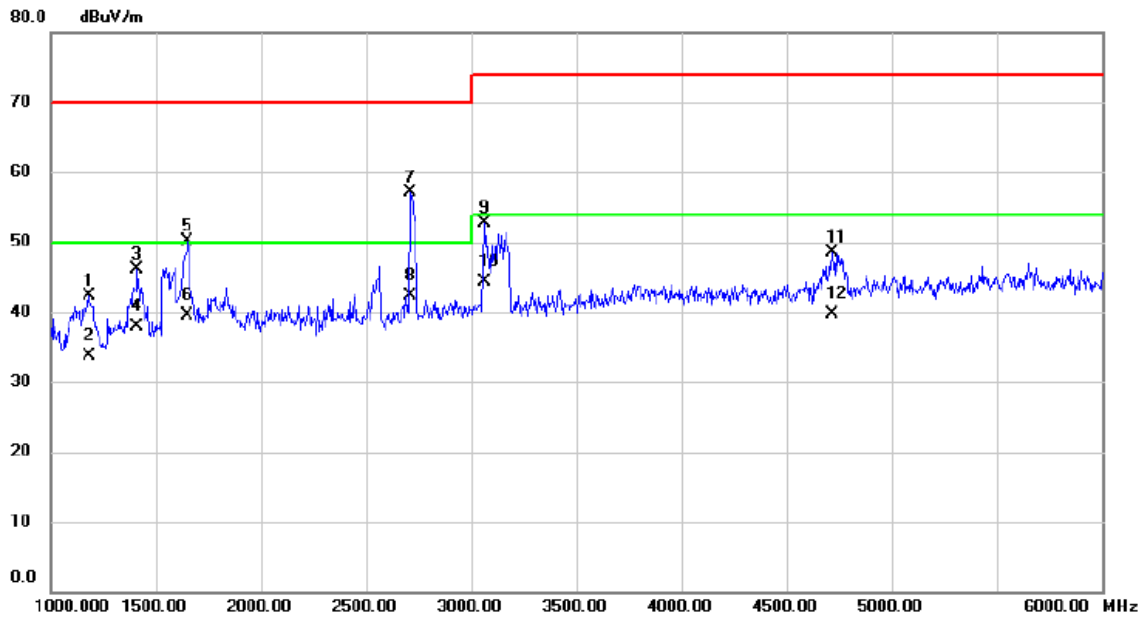

No. Mk.	Freq. MHz	Reading Level dBuV	Correct Factor dB	Measurement dBuV/m	Limit dBuV/m	Margin dB	Detector	Comment
1	1180.000	46.57	-4.25	42.32	70.00	-27.68	peak	
2	1180.000	37.86	-4.25	33.61	50.00	-16.39	AVG	
3	1410.000	49.07	-2.91	46.16	70.00	-23.84	peak	
4	1410.000	40.72	-2.91	37.81	50.00	-12.19	AVG	
5	1650.000	51.40	-1.36	50.04	70.00	-19.96	peak	
6	1650.000	40.83	-1.36	39.47	50.00	-10.53	AVG	
7	2712.500	53.96	3.18	57.14	70.00	-12.86	peak	
8 *	2712.500	39.16	3.18	42.34	50.00	-7.66	AVG	
9	3060.000	48.15	4.55	52.70	74.00	-21.30	peak	
10	3060.000	39.72	4.55	44.27	54.00	-9.73	AVG	
11	4715.000	39.54	8.95	48.49	74.00	-25.51	peak	
12	4715.000	30.74	8.95	39.69	54.00	-14.31	AVG	

Test Voltage	AC 230V/50Hz	Polarization	Vertical
Test Mode	Mode 16		

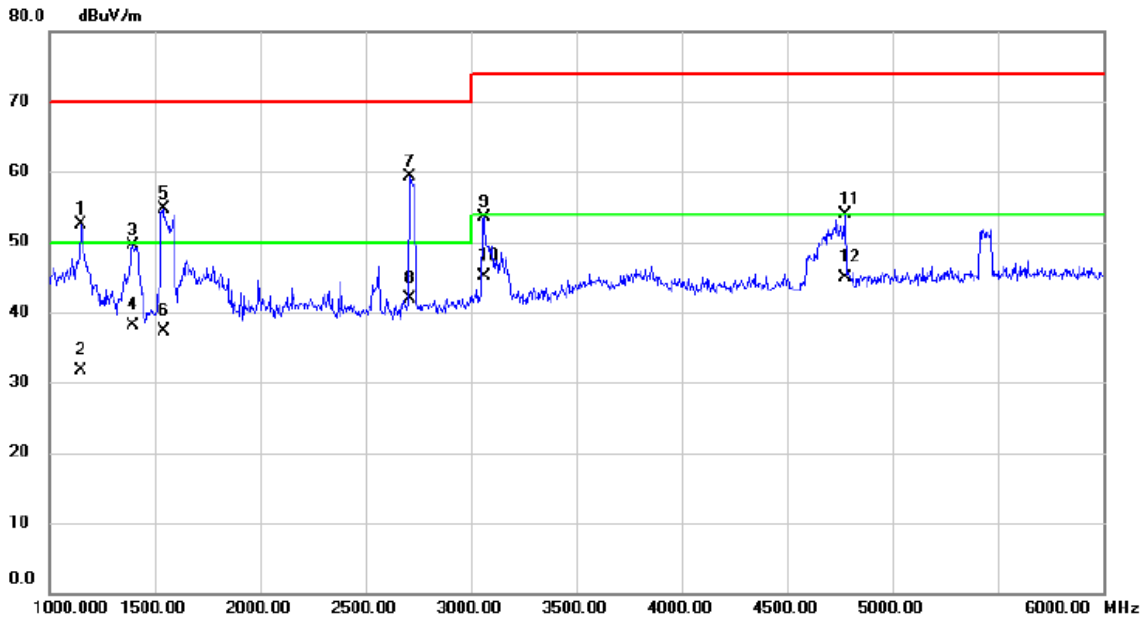

No.	Mk.	Freq. MHz	Reading Level dBuV	Correct Factor dB	Measure- ment dBuV/m	Limit dBuV/m	Margin dB	Detector	Comment
1		1152.500	56.94	-4.42	52.52	70.00	-17.48	peak	
2		1152.500	36.07	-4.42	31.65	50.00	-18.35	AVG	
3		1397.500	52.44	-2.98	49.46	70.00	-20.54	peak	
4		1397.500	41.07	-2.98	38.09	50.00	-11.91	AVG	
5		1542.500	56.77	-2.09	54.68	70.00	-15.32	peak	
6		1542.500	39.46	-2.09	37.37	50.00	-12.63	AVG	
7		2707.500	56.21	3.16	59.37	70.00	-10.63	peak	
8	*	2707.500	38.72	3.16	41.88	50.00	-8.12	AVG	
9		3060.000	49.01	4.55	53.56	74.00	-20.44	peak	
10		3060.000	40.57	4.55	45.12	54.00	-8.88	AVG	
11		4775.000	44.73	9.15	53.88	74.00	-20.12	peak	
12		4775.000	35.75	9.15	44.90	54.00	-9.10	AVG	

Test Voltage	AC 230V/50Hz	Polarization	Horizontal
Test Mode	Mode 16		

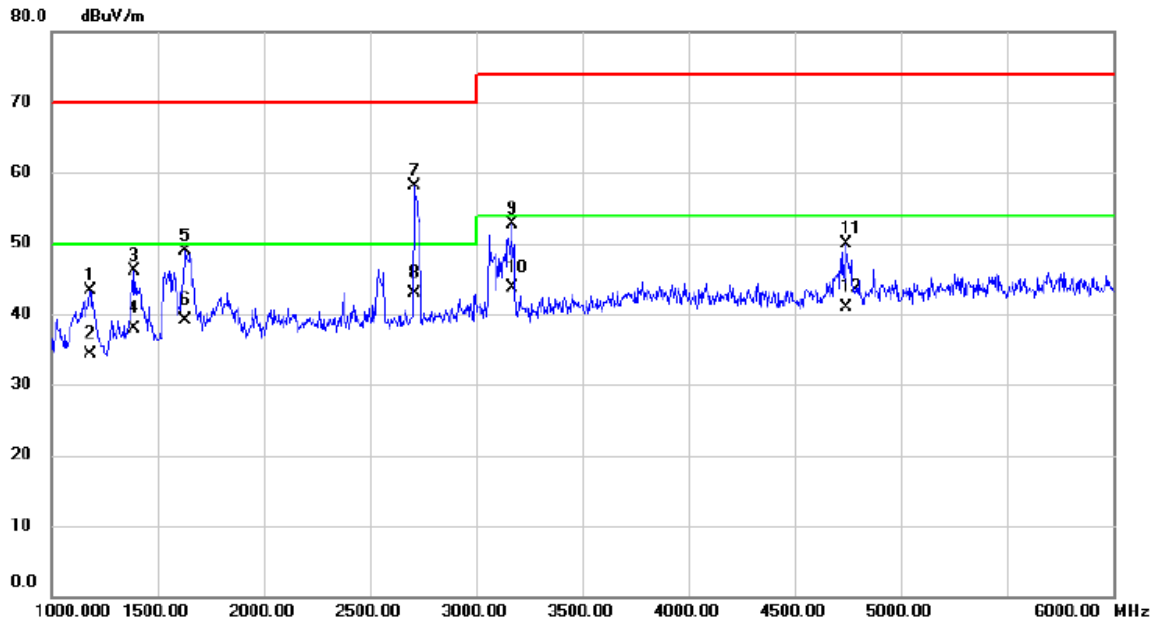

No.	Mk.	Freq. MHz	Reading Level dBuV	Correct Factor dB	Measure- ment dBuV/m	Limit dBuV/m	Margin dB	Detector	Comment
1		1182.500	47.53	-4.23	43.30	70.00	-26.70	peak	
2		1182.500	38.47	-4.23	34.24	50.00	-15.76	AVG	
3		1392.500	49.16	-3.00	46.16	70.00	-23.84	peak	
4		1392.500	40.83	-3.00	37.83	50.00	-12.17	AVG	
5		1632.500	50.47	-1.48	48.99	70.00	-21.01	peak	
6		1632.500	40.60	-1.48	39.12	50.00	-10.88	AVG	
7		2707.500	54.87	3.16	58.03	70.00	-11.97	peak	
8	*	2707.500	39.72	3.16	42.88	50.00	-7.12	AVG	
9		3167.500	47.71	4.95	52.66	74.00	-21.34	peak	
10		3167.500	38.72	4.95	43.67	54.00	-10.33	AVG	
11		4745.000	40.85	9.04	49.89	74.00	-24.11	peak	
12		4745.000	31.87	9.04	40.91	54.00	-13.09	AVG	

Test Voltage	AC 110V/60Hz	Polarization	Vertical
Test Mode	Mode 1		

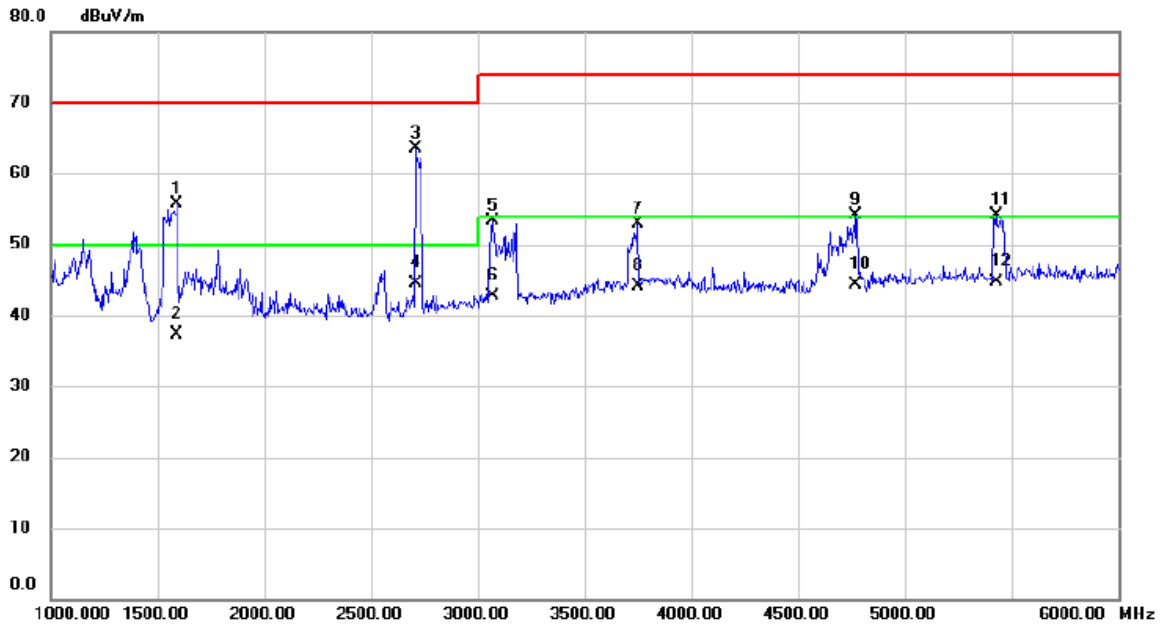

No. Mk.	Freq. MHz	Reading Level dBuV	Correct Factor dB	Measurement dBuV/m	Limit dBuV/m	Margin dB	Detector	Comment
1	1590.000	57.57	-1.77	55.80	70.00	-14.20	peak	
2	1590.000	39.17	-1.77	37.40	50.00	-12.60	AVG	
3	2707.500	60.26	3.16	63.42	70.00	-6.58	peak	
4 *	2707.500	41.27	3.16	44.43	50.00	-5.57	AVG	
5	3067.500	48.68	4.58	53.26	74.00	-20.74	peak	
6	3067.500	38.17	4.58	42.75	54.00	-11.25	AVG	
7	3750.000	46.04	6.94	52.98	74.00	-21.02	peak	
8	3750.000	37.13	6.94	44.07	54.00	-9.93	AVG	
9	4772.500	44.99	9.13	54.12	74.00	-19.88	peak	
10	4772.500	35.17	9.13	44.30	54.00	-9.70	AVG	
11	5427.500	42.89	11.12	54.01	74.00	-19.99	peak	
12	5427.500	33.66	11.12	44.78	54.00	-9.22	AVG	

Test Voltage	AC 110V/60Hz	Polarization	Horizontal
Test Mode	Mode 1		

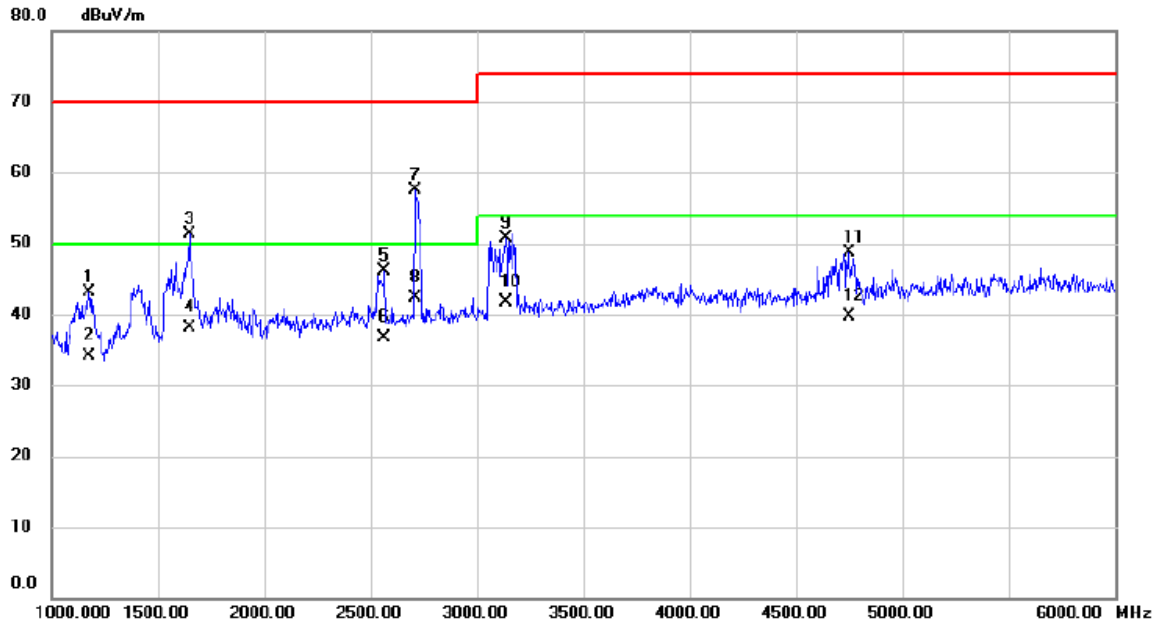

No. Mk.	Freq. MHz	Reading Level dBuV	Correct Factor dB	Measurement dBuV/m	Limit dBuV/m	Margin dB	Detector	Comment
1	1177.500	47.38	-4.26	43.12	70.00	-26.88	peak	
2	1177.500	38.46	-4.26	34.20	50.00	-15.80	AVG	
3	1647.500	52.78	-1.39	51.39	70.00	-18.61	peak	
4	1647.500	39.47	-1.39	38.08	50.00	-11.92	AVG	
5	2565.000	43.49	2.59	46.08	70.00	-23.92	peak	
6	2565.000	34.07	2.59	36.66	50.00	-13.34	AVG	
7	2707.500	54.41	3.16	57.57	70.00	-12.43	peak	
8 *	2707.500	39.17	3.16	42.33	50.00	-7.67	AVG	
9	3137.500	45.93	4.84	50.77	74.00	-23.23	peak	
10	3137.500	36.87	4.84	41.71	54.00	-12.29	AVG	
11	4747.500	39.61	9.05	48.66	74.00	-25.34	peak	
12	4747.500	30.72	9.05	39.77	54.00	-14.23	AVG	

4.3 CONDUCTED EMISSION MEASUREMENT AT AC MAINS POWER PORTS

4.3.1 LIMITS

Requirements for conducted emissions from AC mains power ports of Class B equipment

Frequency Range MHz	Coupling Device	Detector Type / bandwidth	Class B Limits (dB(μV))
0.15 - 0.5	AMN	Quasi Peak / 9 kHz	66-56
0.5 - 5			56
5 - 30			60
0.15 - 0.5	AMN	Average / 9 kHz	56-46
0.5 - 5			46
5 - 30			50

NOTE:

(1) The test result calculated as following:

Measurement Value = Reading Level + Correct Factor

Correct Factor = Insertion Loss + Cable Loss + Attenuator Factor(if use)

Margin Level = Measurement Value – Limit Value

4.3.2 MEASUREMENT INSTRUMENTS LIST

Item	Kind of Equipment	Manufacturer	Type No.	Serial No.	Calibrated until
1	50Ω Terminator	SHX	TF2-3G-A	8122901	Jan. 07, 2024
2	TWO-LINE V-NETWORK	R&S	ENV216	100526	Jun. 16, 2024
3	EMI Test Receiver	R&S	ESR3	101862	Jan. 07, 2024
4	Cable	N/A	RG400	N/A(12m)	Sep. 13, 2024
5	Measurement Software	Farad	EZ-EMC Ver.NB-03A1-01	N/A	N/A
6	ISN	Teseq GmbH	ISN T8	30833	Jun. 16, 2024
7	Artificial-Mains Network	SCHWARZBECK	NSLK 8127	8127685	Jan. 07, 2024

Remark: "N/A" denotes no model name, no serial no. or no calibration specified.

All calibration period of equipment list is one year.

4.3.3 TEST PROCEDURE

- a. The EUT was placed 0.8 meters from the horizontal ground plane with EUT being connected to the power mains through a line impedance stabilization network (LISN). All other support equipment powered from additional LISN(s). The LISN provide 50 Ohm/ 50uH of coupling impedance for the measuring instrument.
- b. Interconnecting cables that hang closer than 40 cm to the ground plane shall be folded back and forth in the center forming a bundle 30 to 40 cm long.
- c. I/O cables that are not connected to a peripheral shall be bundled in the center. The end of the cable may be terminated, if required, using the correct terminating impedance. The overall length shall not exceed 1 m.
- d. LISN at least 80 cm from nearest part of EUT chassis.
- e. For the actual test configuration, please refer to the related Item –EUT Test Photos.

4.3.4 DEVIATION FROM TEST STANDARD

No deviation

4.3.5 TEST SETUP

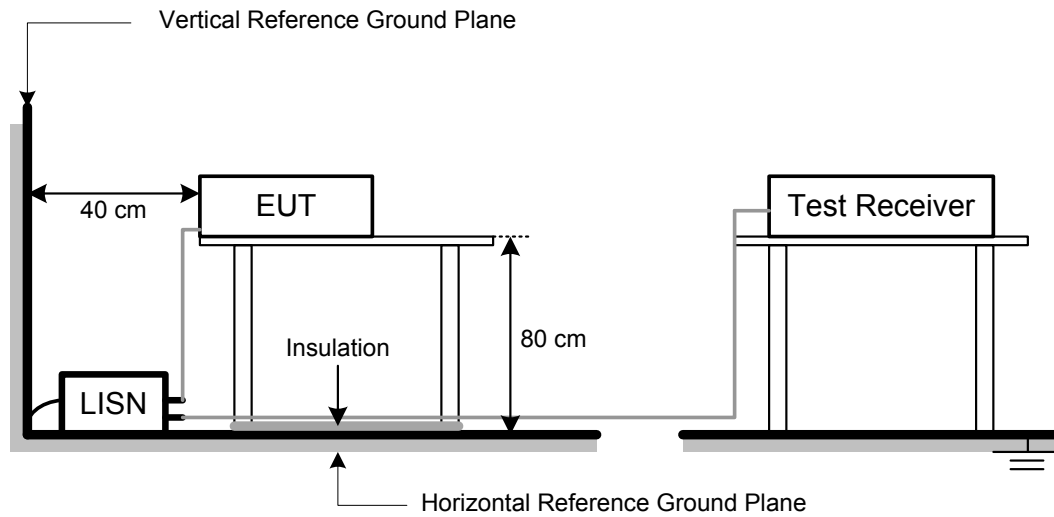

4.3.6 TEST RESULTS

Test Voltage	AC 230V/50Hz	Phase	Line
Test Mode	Mode 1		

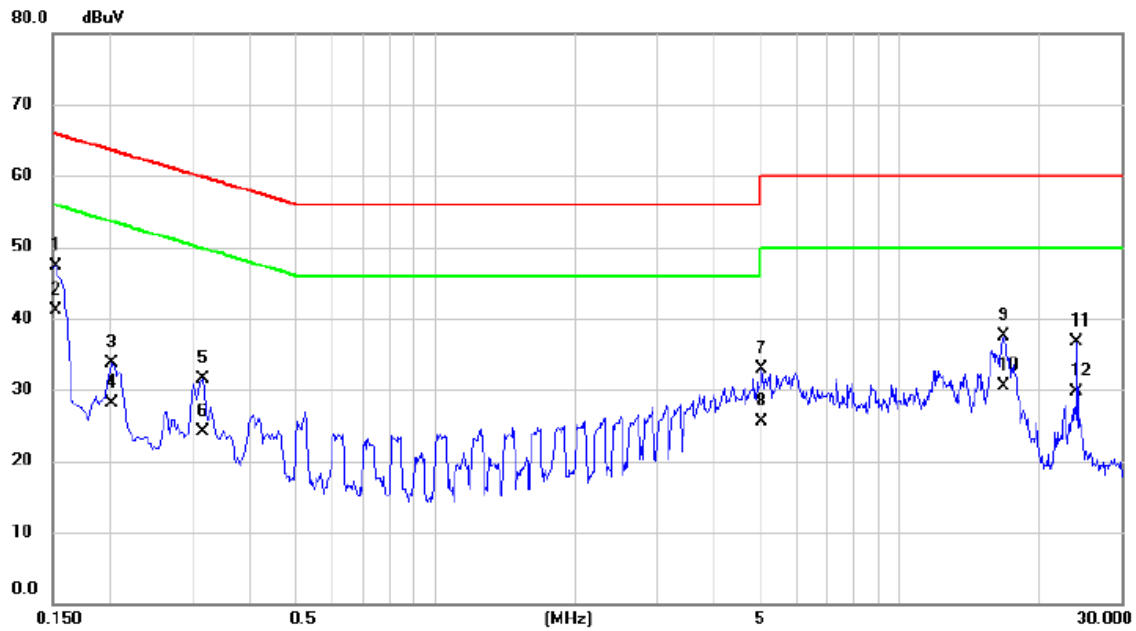

No.	Mk.	Freq. MHz	Reading Level dBuV	Correct Factor dB	Measure- ment dBuV	Limit dBuV	Margin dB	Detector	Comment
1		0.1522	37.53	9.68	47.21	65.88	-18.67	QP	
2	*	0.1522	31.40	9.68	41.08	55.88	-14.80	AVG	
3		0.2017	23.93	9.70	33.63	63.54	-29.91	QP	
4		0.2017	18.40	9.70	28.10	53.54	-25.44	AVG	
5		0.3165	21.81	9.71	31.52	59.80	-28.28	QP	
6		0.3165	14.30	9.71	24.01	49.80	-25.79	AVG	
7		5.0550	22.79	10.08	32.87	60.00	-27.13	QP	
8		5.0550	15.40	10.08	25.48	50.00	-24.52	AVG	
9		16.7123	26.66	10.77	37.43	60.00	-22.57	QP	
10		16.7123	19.70	10.77	30.47	50.00	-19.53	AVG	
11		24.0540	25.61	11.05	36.66	60.00	-23.34	QP	
12		24.0540	18.60	11.05	29.65	50.00	-20.35	AVG	

Test Voltage	AC 230V/50Hz	Phase	Neutral
Test Mode	Mode 1		

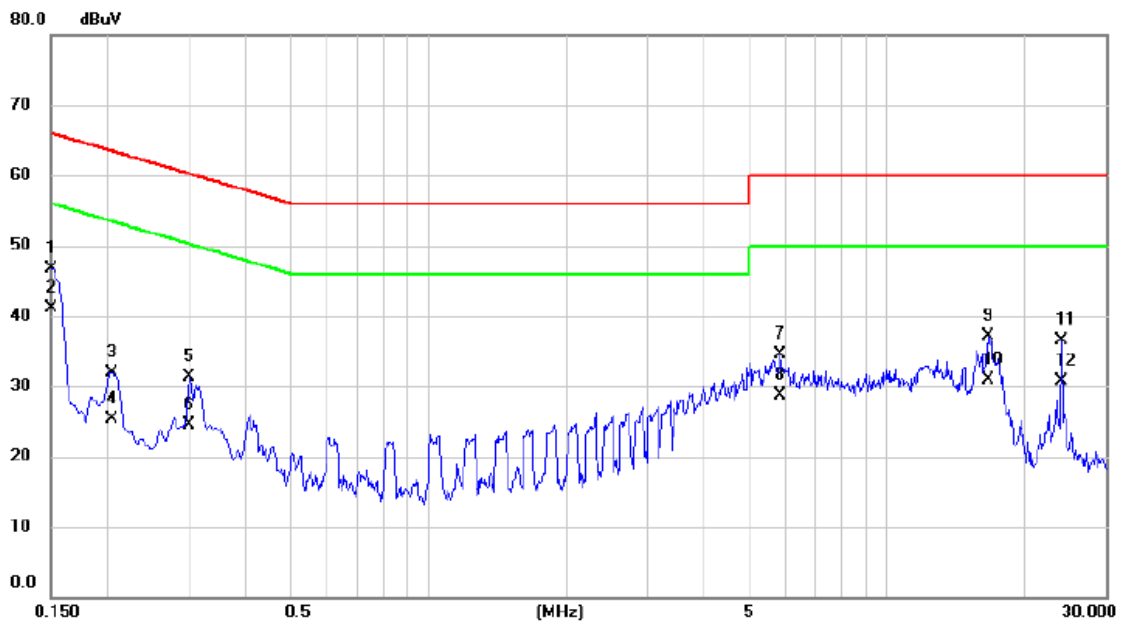

No.	Mk.	Freq. MHz	Reading Level dBuV	Correct Factor dB	Measure- ment dBuV	Limit dBuV	Margin dB	Detector	Comment
1		0.1500	37.12	9.68	46.80	66.00	-19.20	QP	
2	*	0.1500	31.50	9.68	41.18	56.00	-14.82	AVG	
3		0.2040	22.29	9.70	31.99	63.45	-31.46	QP	
4		0.2040	15.60	9.70	25.30	53.45	-28.15	AVG	
5		0.3007	21.58	9.71	31.29	60.22	-28.93	QP	
6		0.3007	14.80	9.71	24.51	50.22	-25.71	AVG	
7		5.8403	24.38	10.16	34.54	60.00	-25.46	QP	
8		5.8403	18.50	10.16	28.66	50.00	-21.34	AVG	
9		16.6695	26.35	10.81	37.16	60.00	-22.84	QP	
10		16.6695	20.10	10.81	30.91	50.00	-19.09	AVG	
11		24.0540	25.29	11.13	36.42	60.00	-23.58	QP	
12		24.0540	19.60	11.13	30.73	50.00	-19.27	AVG	

Test Voltage	AC 230V/50Hz	Phase	Line
Test Mode	Mode 2		

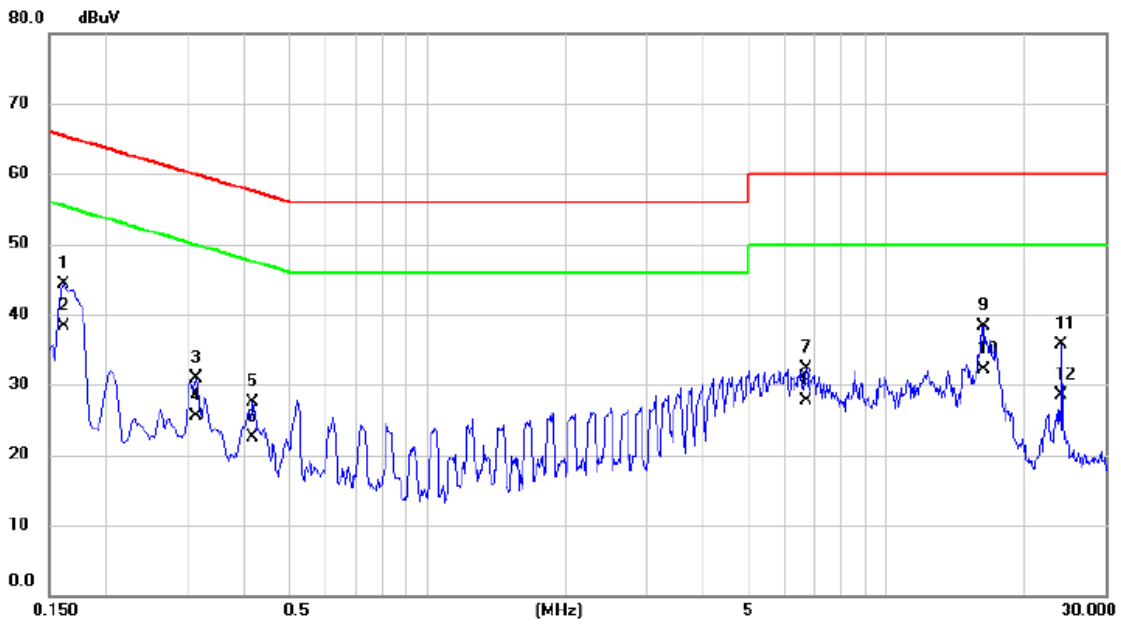

No.	Mk.	Freq. MHz	Reading Level dBuV	Correct Factor dB	Measure- ment dBuV	Limit dBuV	Margin dB	Detector	Comment
1		0.1613	34.56	9.69	44.25	65.40	-21.15	QP	
2	*	0.1613	28.60	9.69	38.29	55.40	-17.11	AVG	
3		0.3141	21.19	9.71	30.90	59.86	-28.96	QP	
4		0.3141	15.70	9.71	25.41	49.86	-24.45	AVG	
5		0.4177	17.76	9.75	27.51	57.49	-29.98	QP	
6		0.4177	12.70	9.75	22.45	47.49	-25.04	AVG	
7		6.6908	22.06	10.20	32.26	60.00	-27.74	QP	
8		6.6908	17.60	10.20	27.80	50.00	-22.20	AVG	
9		16.3185	27.49	10.74	38.23	60.00	-21.77	QP	
10		16.3185	21.30	10.74	32.04	50.00	-17.96	AVG	
11		24.0540	24.56	11.05	35.61	60.00	-24.39	QP	
12		24.0540	17.40	11.05	28.45	50.00	-21.55	AVG	

Test Voltage	AC 230V/50Hz	Phase	Neutral
Test Mode	Mode 2		

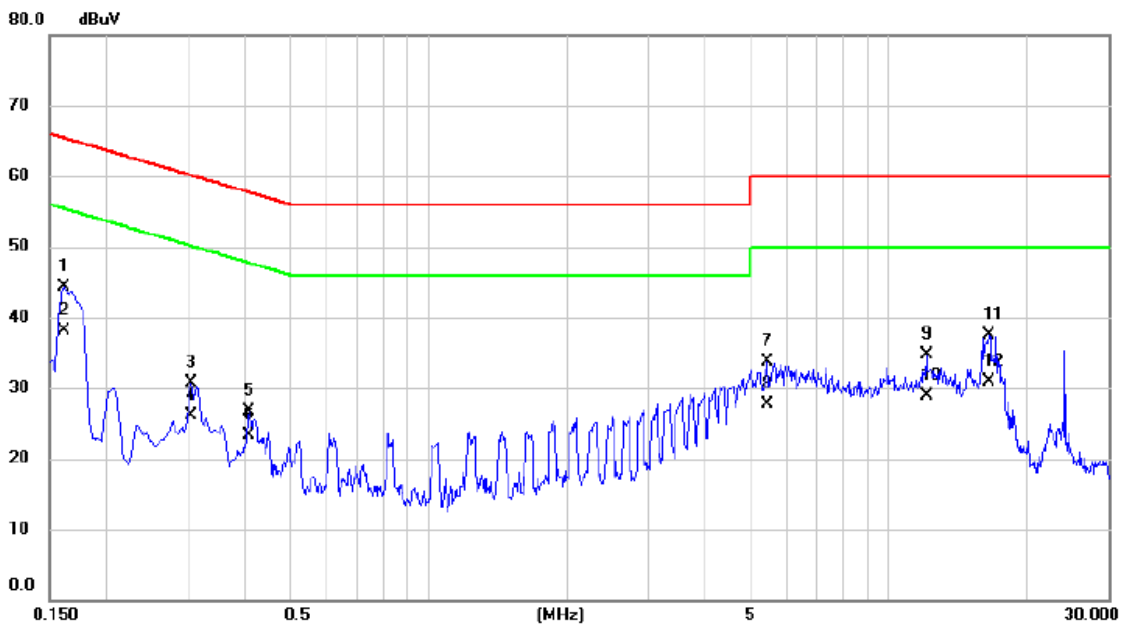

No.	Mk.	Freq. MHz	Reading Level dBuV	Correct Factor dB	Measure- ment dBuV	Limit dBuV	Margin dB	Detector	Comment
1		0.1612	34.62	9.69	44.31	65.40	-21.09	QP	
2	*	0.1612	28.50	9.69	38.19	55.40	-17.21	AVG	
3		0.3052	21.03	9.71	30.74	60.10	-29.36	QP	
4		0.3052	16.40	9.71	26.11	50.10	-23.99	AVG	
5		0.4063	17.02	9.75	26.77	57.72	-30.95	QP	
6		0.4063	13.50	9.75	23.25	47.72	-24.47	AVG	
7		5.4577	23.62	10.13	33.75	60.00	-26.25	QP	
8		5.4577	17.50	10.13	27.63	50.00	-22.37	AVG	
9		12.0862	24.27	10.53	34.80	60.00	-25.20	QP	
10		12.0862	18.30	10.53	28.83	50.00	-21.17	AVG	
11		16.5052	26.63	10.80	37.43	60.00	-22.57	QP	
12		16.5052	20.10	10.80	30.90	50.00	-19.10	AVG	

Test Voltage	AC 230V/50Hz	Phase	Line
Test Mode	Mode 5		

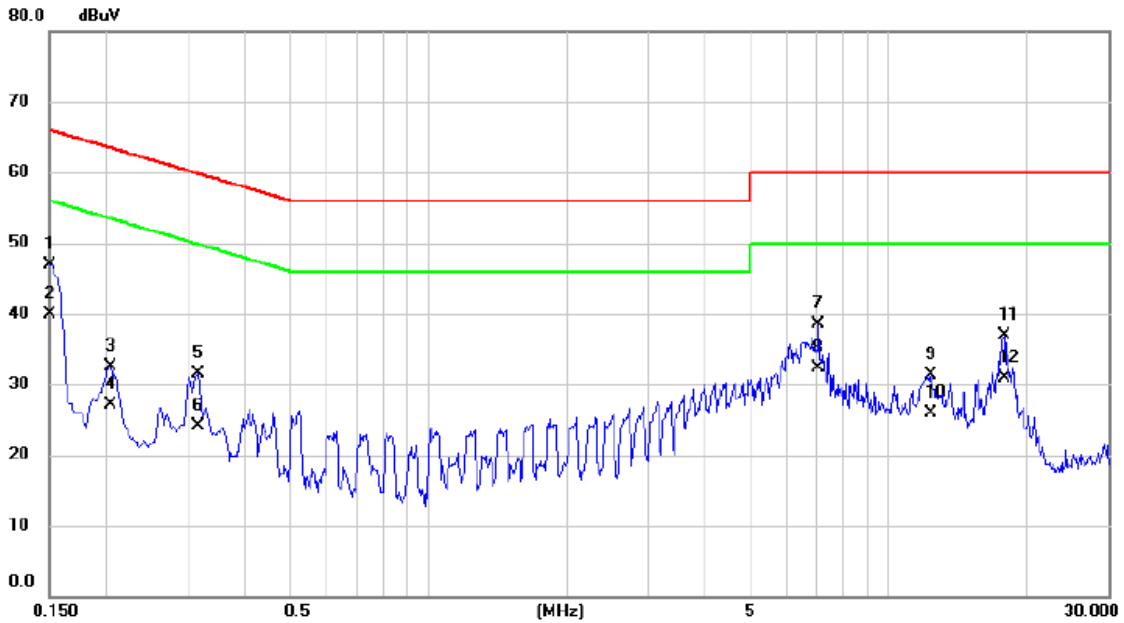

No.	Mk.	Freq. MHz	Reading Level dBuV	Correct Factor dB	Measure- ment dBuV	Limit dBuV	Margin dB	Detector	Comment
1		0.1500	37.25	9.68	46.93	66.00	-19.07	QP	
2	*	0.1500	30.20	9.68	39.88	56.00	-16.12	AVG	
3		0.2040	22.83	9.70	32.53	63.45	-30.92	QP	
4		0.2040	17.50	9.70	27.20	53.45	-26.25	AVG	
5		0.3165	21.86	9.71	31.57	59.80	-28.23	QP	
6		0.3165	14.30	9.71	24.01	49.80	-25.79	AVG	
7		7.0418	28.24	10.22	38.46	60.00	-21.54	QP	
8		7.0418	22.10	10.22	32.32	50.00	-17.68	AVG	
9		12.3450	20.79	10.51	31.30	60.00	-28.70	QP	
10		12.3450	15.40	10.51	25.91	50.00	-24.09	AVG	
11		17.8193	26.13	10.86	36.99	60.00	-23.01	QP	
12		17.8193	20.10	10.86	30.96	50.00	-19.04	AVG	

Test Voltage	AC 230V/50Hz	Phase	Neutral
Test Mode	Mode 5		

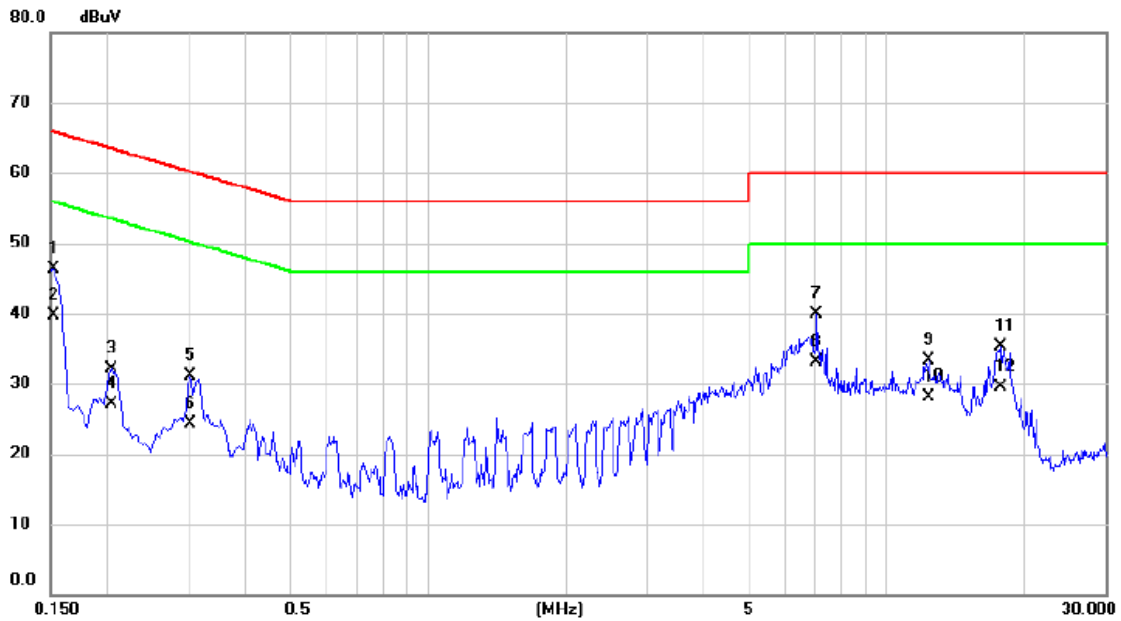

No.	Mk.	Freq. MHz	Reading Level dBuV	Correct Factor dB	Measure- ment dBuV	Limit dBuV	Margin dB	Detector	Comment
1		0.1522	36.59	9.68	46.27	65.88	-19.61	QP	
2	*	0.1522	30.10	9.68	39.78	55.88	-16.10	AVG	
3		0.2040	22.40	9.70	32.10	63.45	-31.35	QP	
4		0.2040	17.40	9.70	27.10	53.45	-26.35	AVG	
5		0.3030	21.48	9.71	31.19	60.16	-28.97	QP	
6		0.3030	14.50	9.71	24.21	50.16	-25.95	AVG	
7		7.0485	29.66	10.23	39.89	60.00	-20.11	QP	
8		7.0485	22.80	10.23	33.03	50.00	-16.97	AVG	
9		12.3405	22.72	10.53	33.25	60.00	-26.75	QP	
10		12.3405	17.50	10.53	28.03	50.00	-21.97	AVG	
11		17.6910	24.50	10.89	35.39	60.00	-24.61	QP	
12		17.6910	18.60	10.89	29.49	50.00	-20.51	AVG	

Test Voltage	AC 110V/60Hz	Phase	Line
Test Mode	Mode 1		

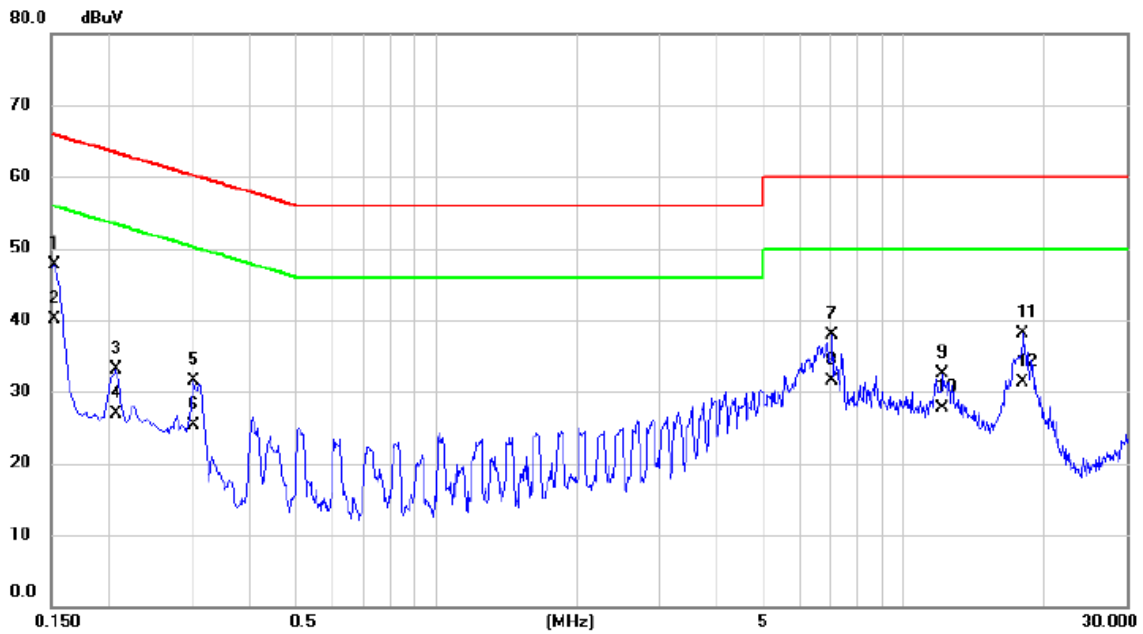

No.	Mk.	Freq. MHz	Reading Level dBuV	Correct Factor dB	Measure- ment dBuV	Limit dBuV	Margin dB	Detector	Comment
1		0.1522	37.98	9.68	47.66	65.88	-18.22	QP	
2	*	0.1522	30.40	9.68	40.08	55.88	-15.80	AVG	
3		0.2063	23.32	9.70	33.02	63.35	-30.33	QP	
4		0.2063	17.20	9.70	26.90	53.35	-26.45	AVG	
5		0.3030	21.84	9.71	31.55	60.16	-28.61	QP	
6		0.3030	15.60	9.71	25.31	50.16	-24.85	AVG	
7		7.0395	27.72	10.22	37.94	60.00	-22.06	QP	
8		7.0395	21.30	10.22	31.52	50.00	-18.48	AVG	
9		12.1268	22.07	10.50	32.57	60.00	-27.43	QP	
10		12.1268	17.20	10.50	27.70	50.00	-22.30	AVG	
11		17.9588	27.16	10.87	38.03	60.00	-21.97	QP	
12		17.9588	20.50	10.87	31.37	50.00	-18.63	AVG	

Test Voltage	AC 110V/60Hz	Phase	Neutral
Test Mode	Mode 1		

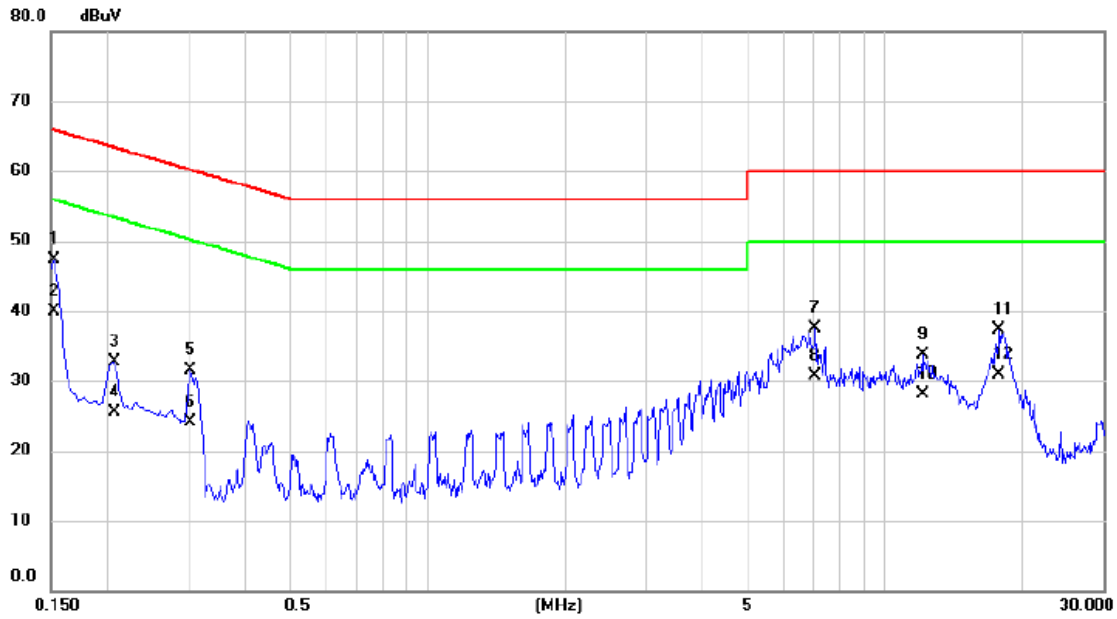

No.	Mk.	Freq. MHz	Reading Level dBuV	Correct Factor dB	Measure- ment dBuV	Limit dBuV	Margin dB	Detector	Comment
1		0.1522	37.65	9.68	47.33	65.88	-18.55	QP	
2	*	0.1522	30.20	9.68	39.88	55.88	-16.00	AVG	
3		0.2063	22.96	9.70	32.66	63.35	-30.69	QP	
4		0.2063	15.80	9.70	25.50	53.35	-27.85	AVG	
5		0.3030	21.75	9.71	31.46	60.16	-28.70	QP	
6		0.3030	14.30	9.71	24.01	50.16	-26.15	AVG	
7		7.0440	27.18	10.23	37.41	60.00	-22.59	QP	
8		7.0440	20.40	10.23	30.63	50.00	-19.37	AVG	
9		12.1088	23.20	10.53	33.73	60.00	-26.27	QP	
10		12.1088	17.60	10.53	28.13	50.00	-21.87	AVG	
11		17.7855	26.44	10.90	37.34	60.00	-22.66	QP	
12		17.7855	20.10	10.90	31.00	50.00	-19.00	AVG	

4.4 ASYMMETRIC MODE CONDUCTED EMISSIONS TEST

4.4.1 LIMITS

Requirements for asymmetric mode conducted emissions from Class B equipment

Frequency Range MHz	Coupling device	Detector type / Bandwidth	Class B voltage limits dB(μ V)	Class B current limits dB(μ A)
0.15 - 0.5	AAN	Quasi Peak / 9 kHz	84 - 74	n/a
0.5 - 30			74	
0.15 - 0.5	AAN	Average / 9 kHz	74 - 64	
0.5 - 30			64	

NOTE:

(1) The test result calculated as following:

Measurement Value = Reading Level + Correct Factor

Correct Factor = Insertion Loss + Cable Loss + Attenuator Factor(if use)

Margin Level = Measurement Value – Limit Value

4.4.2 MEASUREMENT INSTRUMENTS LIST

Item	Kind of Equipment	Manufacturer	Type No.	Serial No.	Calibrated until
1	Measurement Software	Farad	EZ-EMC Ver.NB-03A1-01	N/A	N/A
2	Cable	N/A	RG400	N/A(12m)	Sep. 13, 2024
3	ISN	Teseq GmbH	ISN T8	30833	Jun. 16, 2024
4	EMI Test Receiver	R&S	ESR3	101862	Jan. 07, 2024
5	Artificial-Mains Network	SCHWARZBECK	NSLK 8127	8127685	Jan. 07, 2024
6	TWO-LINE V-NETWORK	R&S	ENV216	100526	Jun. 16, 2024

Remark: "N/A" denotes no model name, no serial No. or no calibration specified.

All calibration period of equipment list is one year.

4.4.3 TEST PROCEDURE

- a. The EUT was placed 0.8 meters from the horizontal ground plane with EUT being connected to the power mains through a line impedance stabilization network (LISN). All other support equipment powered from additional LISN(s). The LISN provide 50 Ohm/ 50uH of coupling impedance for the measuring instrument.
- b. Interconnecting cables that hang closer than 40 cm to the ground plane shall be folded back and forth in the center forming a bundle 30 to 40 cm long.
- c. I/O cables that are not connected to a peripheral shall be bundled in the center. The end of the cable may be terminated, if required, using the correct terminating impedance. The overall length shall not exceed 1 m.
- d. For the actual test configuration, please refer to the related Item –EUT Test Photos.

NOTE:

- 1. The communication function of EUT was executed and AAN was connected between EUT and associated equipment and the AAN was connected directly to reference ground plane. Measure the voltage at the measurement port of the AAN Correct the measured voltage by adding the AAN voltage division factor Compare the corrected voltage with the limit.

4.4.4 DEVIATION FROM TEST STANDARD

No deviation

4.4.5 TEST SETUP

a) Cable Type: Balanced Unscreened, Screened or Coaxial

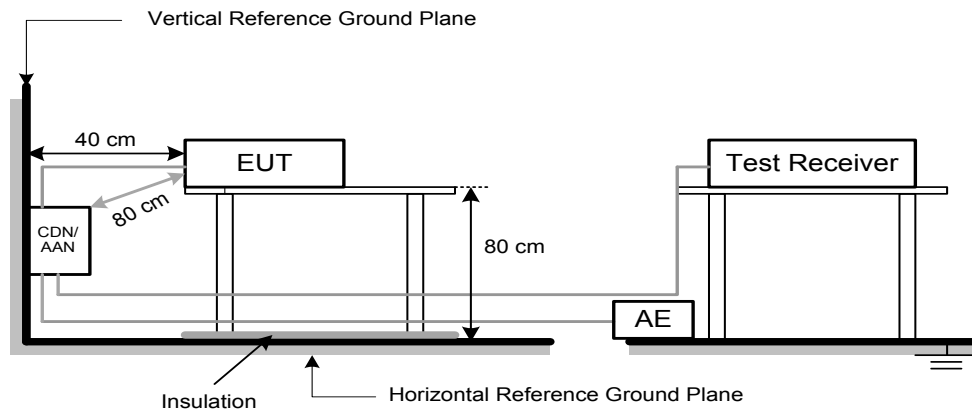

4.4.6 TEST RESULTS

Test Voltage	AC 230V/50Hz
Test Mode	Mode 1(LAN 1Gbps)

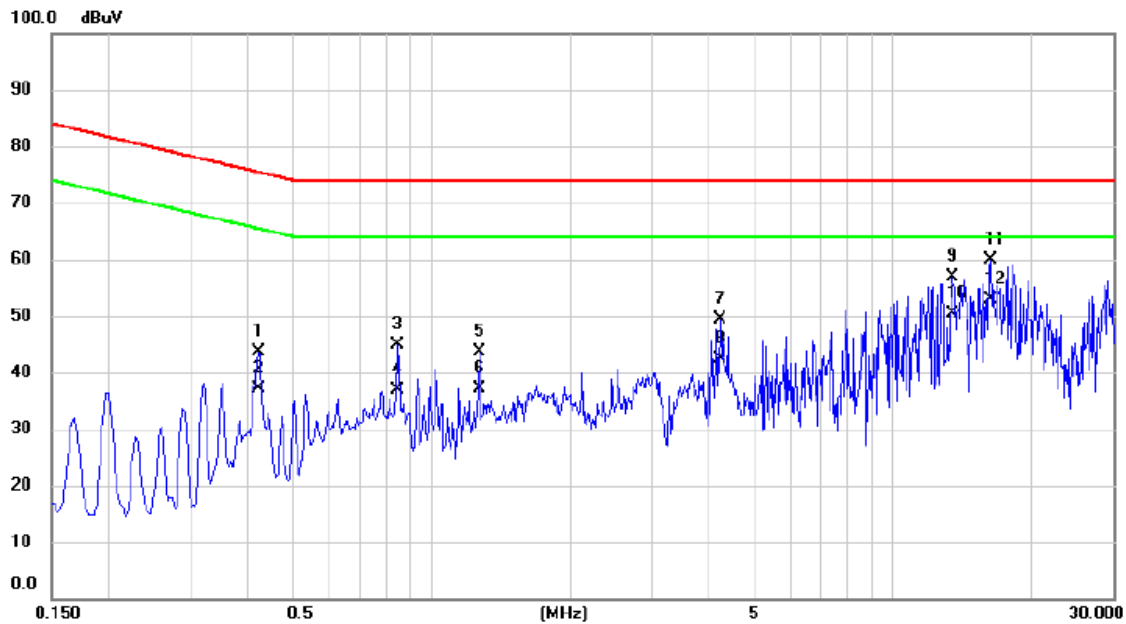

No. Mk.	Freq. MHz	Reading Level dBuV	Correct Factor dB	Measurement dBuV	Limit dBuV	Margin dB	Detector	Comment
1	0.4222	33.64	9.93	43.57	75.40	-31.83	QP	
2	0.4222	27.30	9.93	37.23	65.40	-28.17	AVG	
3	0.8452	34.88	9.96	44.84	74.00	-29.16	QP	
4	0.8452	26.90	9.96	36.86	64.00	-27.14	AVG	
5	1.2682	33.78	9.97	43.75	74.00	-30.25	QP	
6	1.2682	27.10	9.97	37.07	64.00	-26.93	AVG	
7	4.2247	39.27	9.99	49.26	74.00	-24.74	QP	
8	4.2247	32.40	9.99	42.39	64.00	-21.61	AVG	
9	13.4182	46.45	10.40	56.85	74.00	-17.15	QP	
10	13.4182	40.10	10.40	50.50	64.00	-13.50	AVG	
11	16.2285	49.41	10.48	59.89	74.00	-14.11	QP	
12 *	16.2285	42.30	10.48	52.78	64.00	-11.22	AVG	

4.5 HARMONIC CURRENT EMISSIONS TEST

4.5.1 LIMITS

EN 61000-3-2			
Equipment Category	Harmonic Order	Max. Permissible Harmonic Current	
		n	A
Class D	Odd Harmonics only		
	3	2.30	3.4
	5	1.14	1.9
	7	0.77	1.0
	9	0.40	0.5
	11	0.33	0.35
	13	0.21	0.30
	$15 \leq n \leq 39$	$0.15 \times 15/n$	$3.85/n$

4.5.2 MEASUREMENT INSTRUMENTS LIST

Item	Kind of Equipment	Manufacturer	Type No.	Serial No.	Calibrated until
1	Harmonics and Flicker Analyzer	California Instruments	PACS-1	72344	Jun. 16, 2024
2	3KVA AC Power source	California Instruments	3001ix	56309	Jun. 16, 2024
3	Measurement Software	California	CTS4.0 Version 4.29	N/A	N/A

Remark: "N/A" denotes no model name, no serial No. or no calibration specified.

All calibration period of equipment list is one year.

4.5.3 TEST PROCEDURE

- The EUT was placed on the top of a wooden table 0.8 meters above the ground and operated to produce the maximum harmonic components under normal operating conditions.
- The classification of EUT is according to of EN 61000-3-2. The EUT is classified as Class D.
- The correspondent test program of test instrument to measure the current harmonics emanated from EUT is chosen. The measure time shall be not less than the time necessary for the EUT to be exercised.

4.5.4 DEVIATION FROM TEST STANDARD

No deviation

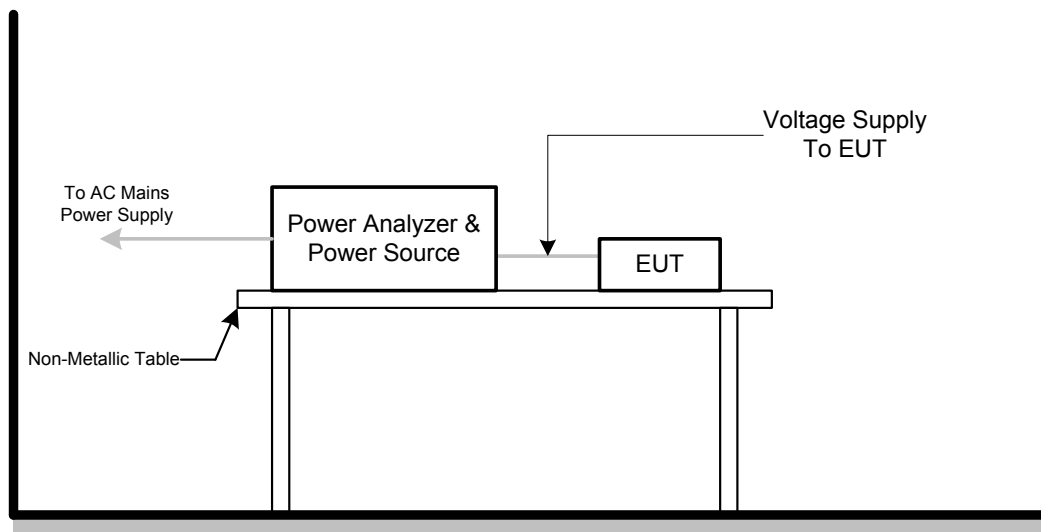
4.5.5 TEST SETUP

4.5.6 TEST RESULTS

Harmonics – Class-D	
Test Voltage	AC 230V/50Hz
Test Mode	Mode 1

Current & voltage waveforms

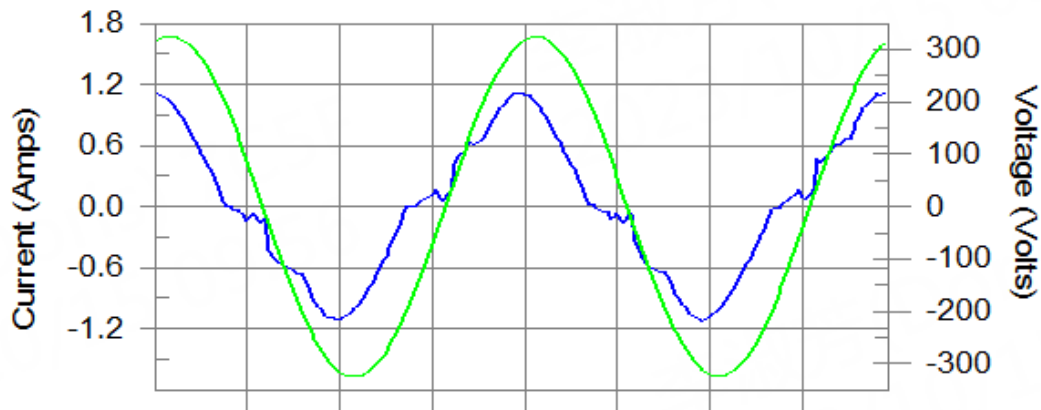

Harmonics and Class D limit line European Limits

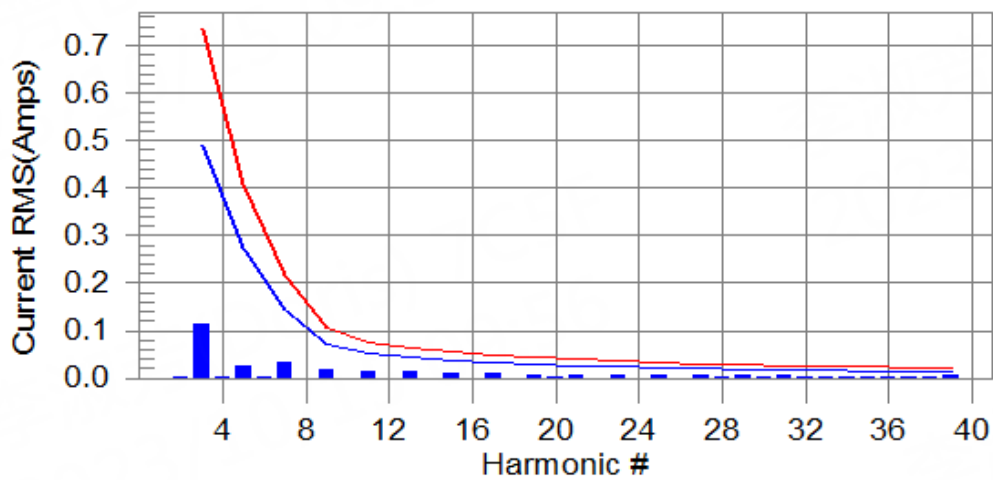

Test result: Pass Worst harmonics H31-25.3% of 150% limit, H31-35.8% of 100% limit

Current Test Result Summary (Run time)

Test Voltage	AC 230V/50Hz
Test Mode	Mode 1

Highest parameter values during test:

V _{RMS} (Volts):	229.98	Frequency(Hz):	50.00
I _{Peak} (Amps):	1.138	I _{RMS} (Amps):	0.686
I _{Fund} (Amps):	0.672	Crest Factor:	1.664
Power (Watts):	143.9	Power Factor:	0.915

Harm#	Harms(avg)	100%Limit	%of Limit	Harms(max)	150%Limit	%of Limit	Status
2	0.001	0.000	N/A	0.002	0.000	N/A	Pass
3	0.113	0.489	23.2	0.115	0.734	15.7	Pass
4	0.001	0.000	N/A	0.001	0.000	N/A	Pass
5	0.024	0.273	8.7	0.024	0.410	6.0	Pass
6	0.001	0.000	N/A	0.001	0.000	N/A	Pass
7	0.035	0.144	24.3	0.036	0.216	16.5	Pass
8	0.001	0.000	N/A	0.001	0.000	N/A	Pass
9	0.019	0.072	26.4	0.019	0.108	18.0	Pass
10	0.001	0.000	N/A	0.001	0.000	N/A	Pass
11	0.013	0.050	25.8	0.013	0.076	17.5	Pass
12	0.001	0.000	N/A	0.001	0.000	N/A	Pass
13	0.013	0.043	29.1	0.013	0.065	19.7	Pass
14	0.001	0.000	N/A	0.001	0.000	N/A	Pass
15	0.012	0.037	30.8	0.012	0.056	20.8	Pass
16	0.001	0.000	N/A	0.001	0.000	N/A	Pass
17	0.009	0.033	28.5	0.010	0.050	19.2	Pass
18	0.001	0.000	N/A	0.001	0.000	N/A	Pass
19	0.007	0.029	25.0	0.008	0.044	17.2	Pass
20	0.001	0.000	N/A	0.001	0.000	N/A	Pass
21	0.008	0.026	28.8	0.008	0.040	19.4	Pass
22	0.001	0.000	N/A	0.001	0.000	N/A	Pass
23	0.006	0.024	24.2	0.006	0.036	16.6	Pass
24	0.000	0.000	N/A	0.001	0.000	N/A	Pass
25	0.005	0.022	23.6	0.005	0.033	16.5	Pass
26	0.001	0.000	N/A	0.001	0.000	N/A	Pass
27	0.004	0.021	N/A	0.005	0.031	N/A	Pass
28	0.001	0.000	N/A	0.001	0.000	N/A	Pass
29	0.006	0.019	29.6	0.006	0.029	21.4	Pass
30	0.001	0.000	N/A	0.001	0.000	N/A	Pass
31	0.006	0.018	35.8	0.007	0.027	25.3	Pass
32	0.001	0.000	N/A	0.001	0.000	N/A	Pass
33	0.004	0.017	N/A	0.005	0.025	N/A	Pass
34	0.001	0.000	N/A	0.001	0.000	N/A	Pass
35	0.003	0.016	N/A	0.003	0.024	N/A	Pass
36	0.001	0.000	N/A	0.001	0.000	N/A	Pass
37	0.004	0.015	N/A	0.004	0.022	N/A	Pass
38	0.001	0.000	N/A	0.001	0.000	N/A	Pass
39	0.004	0.014	N/A	0.005	0.021	N/A	Pass
40	0.000	0.000	N/A	0.000	0.000	N/A	Pass

Voltage Source Verification Data (Run time)	
Test Voltage	AC 230V/50Hz
Test Mode	Mode 1

Highest parameter values during test:

Voltage (Vrms):	229.98	Frequency(Hz):	50.00
I _{Peak} (Amps):	1.138	I _{RMS} (Amps):	0.686
I _{Fund} (Amps):	0.672	Crest Factor:	1.664
Power (Watts):	143.9	Power Factor:	0.915

Harm#	Harmonics V-rms	Limit V-rms	% of Limit	Status
2	0.157	0.460	34.24	OK
3	0.562	2.069	27.14	OK
4	0.066	0.460	14.39	OK
5	0.060	0.920	6.54	OK
6	0.030	0.460	6.53	OK
7	0.034	0.690	4.92	OK
8	0.027	0.460	5.96	OK
9	0.041	0.460	8.84	OK
10	0.030	0.460	6.60	OK
11	0.021	0.230	8.97	OK
12	0.015	0.230	6.67	OK
13	0.027	0.230	11.57	OK
14	0.014	0.230	6.16	OK
15	0.020	0.230	8.64	OK
16	0.022	0.230	9.74	OK
17	0.013	0.230	5.64	OK
18	0.019	0.230	8.14	OK
19	0.014	0.230	6.02	OK
20	0.022	0.230	9.64	OK
21	0.014	0.230	6.28	OK
22	0.015	0.230	6.56	OK
23	0.011	0.230	4.95	OK
24	0.005	0.230	2.25	OK
25	0.011	0.230	4.89	OK
26	0.009	0.230	3.75	OK
27	0.009	0.230	3.81	OK
28	0.008	0.230	3.57	OK
29	0.011	0.230	4.75	OK
30	0.006	0.230	2.60	OK
31	0.007	0.230	3.18	OK
32	0.005	0.230	2.37	OK
33	0.009	0.230	3.86	OK
34	0.005	0.230	2.03	OK
35	0.006	0.230	2.59	OK
36	0.004	0.230	1.62	OK
37	0.006	0.230	2.82	OK
38	0.002	0.230	1.02	OK
39	0.006	0.230	2.66	OK
40	0.007	0.230	3.11	OK

4.6 VOLTAGE FLUCTUATIONS (FLICKER) TEST

4.6.1 LIMITS

Tests	Limits	Descriptions
	EN 61000-3-3	
Pst	≤ 1.0 , Tp= 10 min.	Short Term Flicker Indicator
Plt	≤ 0.65 , Tp=2 hr.	Long Term Flicker Indicator
dc	$\leq 3.3\%$	Relative Steady-State V-Chang
dmax	$\leq 4\%$	Maximum Relative V-change
d (t)	≤ 500 ms	Relative V-change characteristic

4.6.2 MEASUREMENT INSTRUMENTS LIST

Item	Kind of Equipment	Manufacturer	Type No.	Serial No.	Calibrated until
1	Harmonics and Flicker Analyzer	California Instruments	PACS-1	72344	Jun. 16, 2024
2	3KVA AC Power source	California Instruments	3001ix	56309	Jun. 16, 2024
3	Measurement Software	California	CTS4.0 Version 4.29	N/A	N/A

Remark: "N/A" denotes no model name, no serial No. or no calibration specified.

All calibration period of equipment list is one year.

4.6.3 TEST PROCEDURE

- a. Tests was performed according to the Test Conditions/Assessment of Voltage Fluctuations specified in EN 61000-3-3 depend on which standard adopted for compliance measurement.
- b. All types of harmonic current and/or voltage fluctuation in this report are assessed by direct measurement using flicker-meter.

4.6.4 DEVIATION FROM TEST STANDARD

No deviation

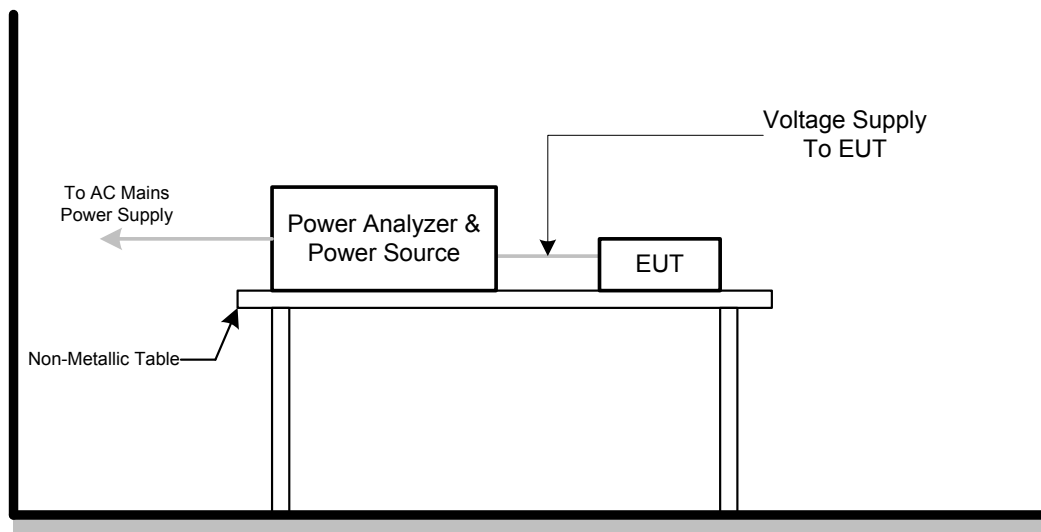
4.6.5 TEST SETUP

4.6.6 TEST RESULTS

Test Voltage	AC 230V/50Hz
Test Mode	Mode 1

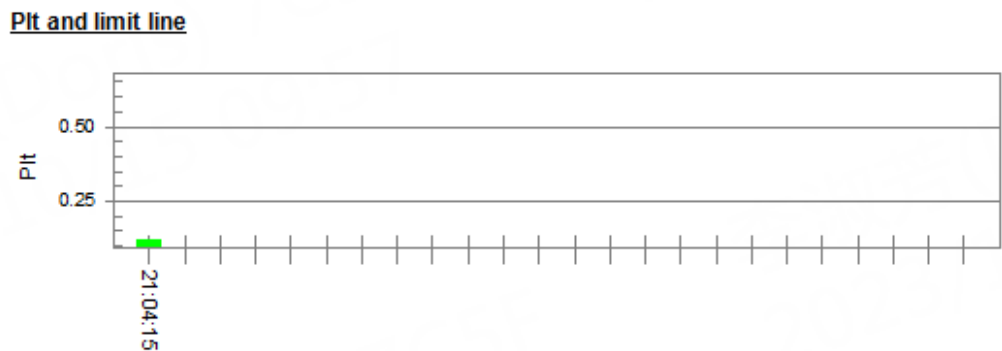
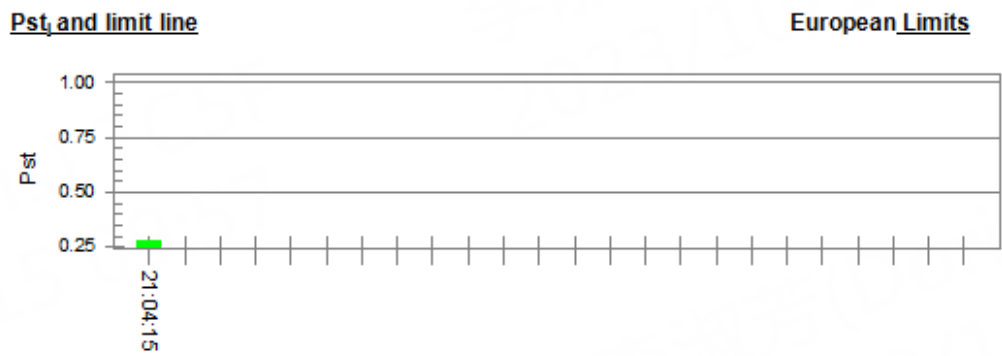

Parameter values recorded during the test:

Vrms at the end of test (Volt):	229.82		
Highest dt (%):		Test limit (%):	
T-max (mS):	0	Test limit (mS):	500.0 Pass
Highest dc (%):	0.00	Test limit (%):	3.30 Pass
Highest dmax (%):	0.00	Test limit (%):	4.00 Pass
Highest Pst (10 min. period):	0.280	Test limit:	1.000 Pass
Highest Plt (2 hr. period):	0.122	Test limit:	0.650 Pass

5. EMC IMMUNITY TEST

5.1 STANDARD COMPLIANCE/SEVERITY LEVEL/CRITERIA

Tests Standard No.	Test Specification Level / Test Mode	Test Ports	Criteria
Electrostatic discharge IEC 61000-4-2 (ESD)	±8kV air discharge ±4kV contact discharge (Direct Mode)	Enclosure	B
	±4kV HCP discharge ±4kV VCP discharge (Indirect Mode)	Enclosure	B
Continuous RF electromagnetic field disturbances,swept test IEC 61000-4-3 (RS)	80 MHz to 1000 MHz 3V/m(unmodulated, r.m.s), 1 kHz, 80%, AM modulated	Enclosure	A
Continuous RF electromagnetic field disturbances,spot test IEC 61000-4-3 (RS)	1800 MHz, 2600MHz, 3500 MHz, 5000MHz(±1 %) 3V/m(unmodulated, r.m.s), 1 kHz, 80%, AM modulated	Enclosure	A
Electrical fast transient/burst immunity IEC 61000-4-4 (EFT)	±0.5kV(peak) 5/50ns Tr/Th 5kHz Repetition Frequency (100kHz Repetition Frequency for xDSL port)	Analogue/digital data ports (NOTE 2)	B
	±0.5kV(peak) 5/50ns Tr/Th 5kHz Repetition Frequency	DC network power ports (NOTE 2)	B
	±1 kV(peak) 5/50ns Tr/Th 5kHz Repetition Frequency	AC mains power ports	B

Surge immunity IEC 61000-4-5 (Surge)	Port Type: unshielded symmetrical		
	Apply: lines to ground		
	Primary protection is Intended ±1 kV and ±4 kV 10/700(5/320)Tr/Th µs	Analogue/digital data ports (NOTE 1) & (NOTE 2)	C
	Primary protection is not Intended ±1 kV 10/700(5/320) Tr/Th µs		C
	Port type: coaxial or shielded		
	Apply: shield to ground		
±0.5 kV 1.2/50(8/20) Tr/Th µs	Analogue/digital data ports (NOTE 1) & (NOTE 2)	B	
line to reference ground for each individual line: ±0.5 kV(peak) 1.2/50(8/20) Tr/Th µs	DC network power ports (NOTE 2)	B	
±1 kV(peak) 1.2/50(8/20) Tr/Th µs (line to line) ±2 kV(peak) 1.2/50(8/20) Tr/Th µs (line to earth or ground)	AC mains power ports	B	
Continuous induced RF disturbances IEC 61000-4-6 (CS)	0.15 MHz to 10 MHz 3V(unmodulated, r.m.s), 10 MHz to 30 MHz 3V to 1V(unmodulated, r.m.s), 30 MHz to 80 MHz 1V(unmodulated, r.m.s), 1kHz 80%, AM 150Ω source impedance	Analogue/digital data ports (NOTE 2)	A
	0.15 MHz to 10 MHz 3V(unmodulated, r.m.s), 10 MHz to 30 MHz 3V to 1V(unmodulated, r.m.s), 30 MHz to 80 MHz 1V(unmodulated, r.m.s), 1kHz 80%, AM 150Ω source impedance	DC network power ports (NOTE 2)	A
	0.15 MHz to 10 MHz 3V(unmodulated, r.m.s), 10 MHz to 30 MHz 3V to 1V(unmodulated, r.m.s), 30 MHz to 80 MHz 1V(unmodulated, r.m.s), 1kHz 80%, AM 150Ω source impedance	AC mains power ports	A

Power frequency magnetic field immunity IEC 61000-4-8 (PFMF)	50 Hz or 60Hz, 1A/m(r.m.s)	Enclosure	A
Voltage dips, short interruptions and voltage variations immunity IEC 61000-4-11 (Dips)	Voltage dips: Residual voltage<5% 0.5 cycle Residual voltage<70% 25 cycle(50Hz), 30 cycle (60Hz) Voltage interruptions: Residual voltage<5% 250 cycle (50Hz), 300 cycle (60Hz)	AC Power Ports	B C C
Broadband impulse noise disturbances, repetitive (BIN-R)	0.15 MHz to 0.5 MHz 107 dBuV 0.5 MHz to 10 MHz 107 dBuV to 36 dBuV 10 MHz to 30 MHz 36 dBuV to 30 dBuV	Analogue/digital data ports (Applicable only to CPE xDSL ports)	A
	0.70 ms 8.3 ms(for 60Hz) 10 ms(for 50Hz)	Analogue/digital data ports (Apply period based on the AC mains frequency)	A
Broadband impulse noise disturbances, isolated (BIN-I)	0.15 MHz to 30 MHz 110 dBuV	Analogue/digital data ports (Applicable only to CPE xDSL ports)	B
	0.24 ms 10 ms 300 ms	Analogue/digital data ports (Apply all burst durations)	B

Note.

- 1) Applicable only to ports which, according to the manufacturer's specification, may connect directly to outdoor cables.
- 2) Applicable only to ports which, according to the manufacturer's specification, support cable lengths greater than 3 m.

5.2 GENERAL PERFORMANCE CRITERIA

According to **EN 55035** standards, the general performance criteria as following:

<p>Criterion A</p>	<p>The equipment shall continue to operate as intended without operator intervention. No degradation of performance, loss of function or change of operating state is allowed below a performance level specified by the manufacturer when the equipment is used as intended. The performance level may be replaced by a permissible loss of performance. If the minimum performance level or the permissible performance loss is not specified by the manufacturer, then either of these may be derived from the product description and documentation, and by what the user may reasonably expect from the equipment if used as intended.</p>
<p>Criterion B</p>	<p>During the application of the disturbance, degradation of performance is allowed. However, no unintended change of actual operating state or stored data is allowed to persist after the test. After the test, the equipment shall continue to operate as intended without operator intervention; no degradation of performance or loss of function is allowed, below a performance level specified by the manufacturer, when the equipment is used as intended. The performance level may be replaced by a permissible loss of performance. If the minimum performance level (or the permissible performance loss), or recovery time, is not specified by the manufacturer, then either of these may be derived from the product description and documentation, and by what the user may reasonably expect from the equipment if used as intended.</p>
<p>Criterion C</p>	<p>Loss of function is allowed, provided the function is self-recoverable, or can be restored by the operation of the controls by the user in accordance with the manufacturer's instructions. A reboot or re-start operation is allowed. Information stored in non-volatile memory, or protected by a battery backup, shall not be lost.</p>

5.3 ANNEX D (NORMATIVE) - DISPLAY AND DISPLAY OUTPUT FUNCTION

5.3.1 PERFORMANCE CRITERIA

Performance criterion A

for continuous radiated and conducted disturbances tests:

Apply criterion A as defined in GENERAL PERFORMANCE CRITERIA. Additionally, an increase in any degradation greater than just perceptible by observation of the image shall not occur as a consequence of the application of the test. Examples of such degradations are:

- superimposed patterning;
- positional disturbances due to synchronisation errors;
- geometric distortion;
- change of contrast or brightness;
- picture artefacts;
- freezing or disturbance of motion;
- image loss;
- video data or decoding errors.

Performance criterion A

for the power frequency magnetic field tests:

Alternative 1: A continuous magnetic field of 1 A/m:

The jitter (in mm) shall not exceed the value
$$\frac{(\text{character height in mm} + 0,3) \times 2,5}{33,3}$$

Performance criterion B:

Apply criterion B as defined in GENERAL PERFORMANCE CRITERIA.

Performance criterion C:

Apply criterion C as defined in GENERAL PERFORMANCE CRITERIA.

5.4 ANNEX G (NORMATIVE) - AUDIO OUTPUT FUNCTION

5.4.1 PERFORMANCE CRITERIA

Performance criterion A:

For devices that support telephony functions the limits of Table G.3 shall apply.

With respect to Table G.3:

- the interference ratio (electrical or acoustic) shall meet the limits in column 3; or,
- the acoustic level of the demodulated audio shall be less than the limits in column 4; or,
- the digitally coded level of demodulated audio shall be less than limits in column 5; or,
- the analogue level of the demodulated audio shall be less than the limits in column 6.

Table G.3 – Performance criterion A – Limits for devices supporting telephony

Type of immunity test	Frequency range MHz	Acoustic or electrical interference ratio	Equivalent direct measurement		
			dB (SPL)	Digital dBm0	Analogue dBm
Conducted	0,15 to 30	-20 dB	55	-50	-50
	30 to 80	-10 dB	65	-40	-40
Radiated	80 to 1000	0 dB	75	-30	-30

For terminals connected to digital wired network ports (such as Ethernet, ISDN), measurements of the demodulated 1 kHz may be performed on a remote AE, ideally of the same design.

For all other devices:

The measured acoustic interference ratio and/or the measured electrical interference ratio during the test shall be –20 dB or better.

Performance criterion B:

Use the general performance criterion B. See GENERAL PERFORMANCE CRITERIA.

Performance criterion C:

Use the general performance criterion C. See GENERAL PERFORMANCE CRITERIA.

5.5 ELECTROSTATIC DISCHARGE IMMUNITY TEST (ESD)

5.5.1 TEST SPECIFICATION

Basic Standard	IEC 61000-4-2
Discharge Impedance	330 ohm / 150 pF
Required Performance	B
Discharge Voltage	Air Discharge: $\pm 2\text{kV}$, $\pm 4\text{kV}$, $\pm 8\text{kV}$ Contact Discharge: $\pm 2\text{kV}$, $\pm 4\text{kV}$
Polarity	Positive & Negative
Number of Discharge	20 times at each test point
Discharge Mode	Single Discharge
Discharge Period	1 second

5.5.2 MEASUREMENT INSTRUMENTS

Item	Kind of Equipment	Manufacturer	Type No.	Serial No.	Calibrated until
1	ESD Generator	TESEQ AG	NSG 437	450	Nov. 13, 2023

Remark: "N/A" denotes no model name, no serial No. or no calibration specified.

All calibration period of equipment list is one year.

5.5.3 TEST PROCEDURE

The test generator necessary to perform direct and indirect application of discharges to the EUT in the following manner:

- a. The test shall be performed with single discharges. On each pre-selected point at least 10 single discharges (in the most sensitive polarity) shall be applied.

NOTE 1 The minimum number of discharges applied is depending on the EUT; for products with synchronized circuits the number of discharges should be larger.

For the time interval between successive single discharges an initial value of 1 s is recommended. Longer intervals may be necessary to determine whether a system failure has occurred.

NOTE 2 The points to which the discharges should be applied may be selected by means of an exploration carried out at a repetition rate of 20 discharges per second, or more.

Vertical Coupling Plane (VCP):

The coupling plane, of dimensions 0.5m x 0.5m, is placed parallel to, and positioned at a distance 0.1m from, the EUT, with the Discharge Electrode touching the coupling plane.

The four faces of the EUT will be performed with electrostatic discharge.

Horizontal Coupling Plane (HCP):

The coupling plane is placed under to the EUT. The generator shall be positioned vertically at a distance of 0.1m from the EUT, with the Discharge Electrode touching the coupling plane.

The four faces of the EUT will be performed with electrostatic discharge.

- b. For TABLE-TOP equipment:

The configuration consisted of a wooden table 0.8 meters high standing on the Ground Reference Plane. The GRP consisted of a sheet of aluminum at least 0.25mm thick, and 2.5 meters square connected to the protective grounding system. A Horizontal Coupling Plane (1.6m x 0.8m) was placed on the table and attached to the GRP by means of a cable with 940k total impedance. The equipment under test was installed in a representative system as described in IEC 61000-4-2, and its cables were placed on the HCP and isolated by an insulating support of 0.5mm thickness. A distance of 1-meter minimum was provided between the EUT and the walls of the laboratory and any other metallic structure.

5.5.4 DEVIATION FROM TEST STANDARD

No deviation

5.5.5 TEST SETUP

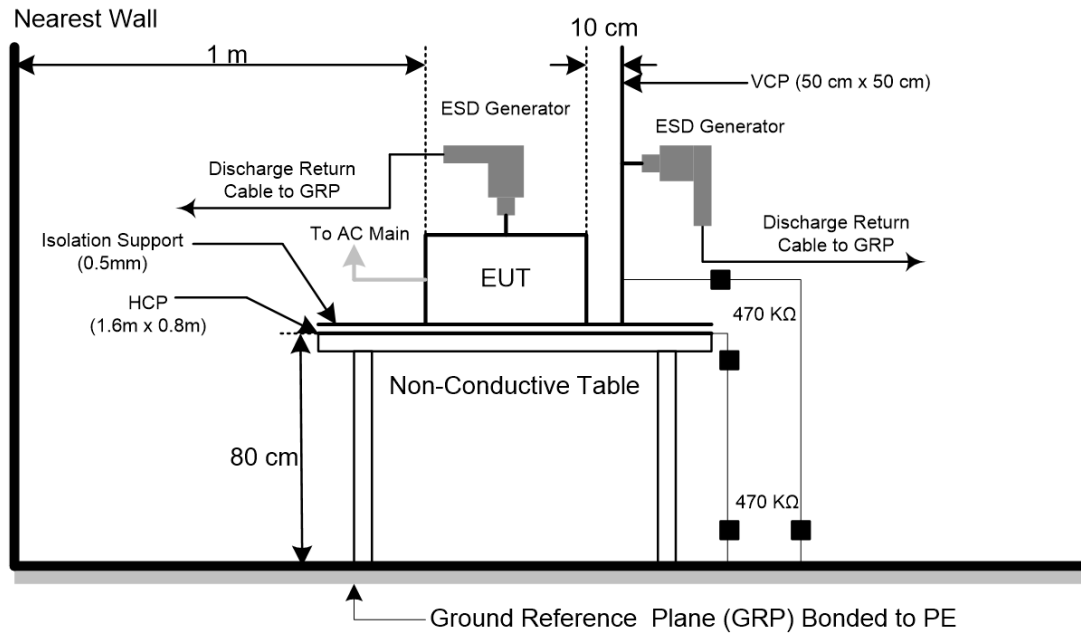

5.5.6 TEST RESULTS

Test Voltage	AC 230V/50Hz
Test Mode	Mode 1-5, 8-15

Mode	Air Discharge								Contact Discharge					
	2kV		4kV		8kV		- kV		2kV		4kV		- kV	
Location	P	N	P	N	P	N	P	N	P	N	P	N	P	N
1	A	A	A	A	B	B	-	-	A	A	B	B	-	-
2	A	A	A	A	B	B	-	-	A	A	B	B	-	-
3	A	A	A	A	A	A	-	-	A	A	B	B	-	-
4	A	A	A	A	A	A	-	-	-	-	-	-	-	-
Criteria	B						-		B					
Result	B						-		B					

Mode	HCP Contact Discharge						VCP Contact Discharge							
	2kV		4kV		- kV		2kV		4kV		- kV			
Location	P	N	P	N	P	N	P	N	P	N	P	N		
Left side	A	A	A	A	-	-	A	A	A	A	-	-		
Right side	A	A	A	A	-	-	A	A	A	A	-	-		
Front side	A	A	A	A	-	-	A	A	A	A	-	-		
Rear side	A	A	A	A	-	-	A	A	A	A	-	-		
Criteria	B						-		B					
Result	A						-		A					

Note:

- 1) P/N denotes the Positive/Negative polarity of the output voltage.
- 2) N/A - denotes test is not applicable in this test report

PHOTO(S) SHOWN THE LOCATION(S) OF ESD EVALUATED

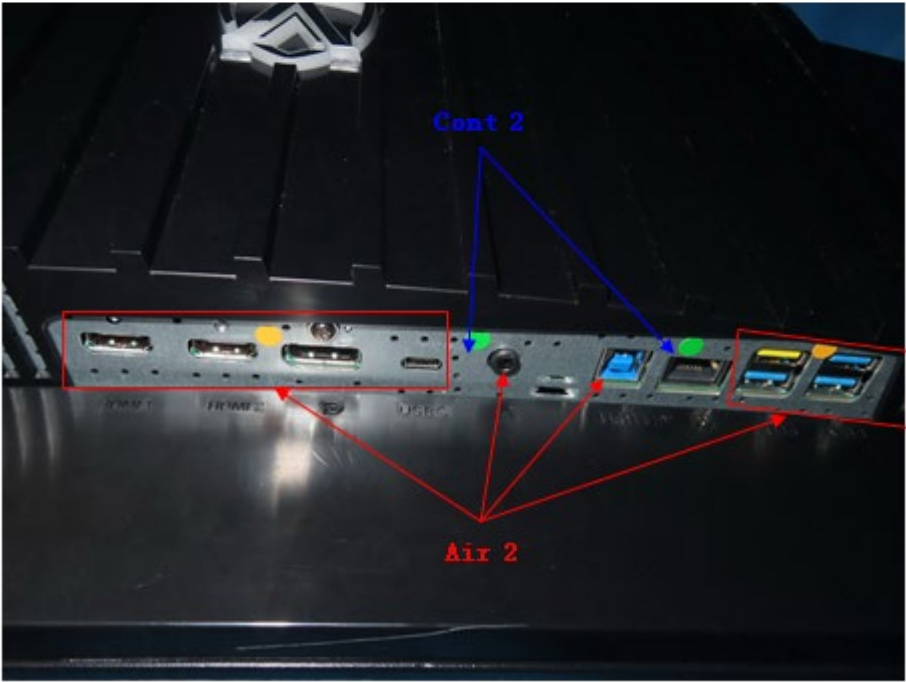
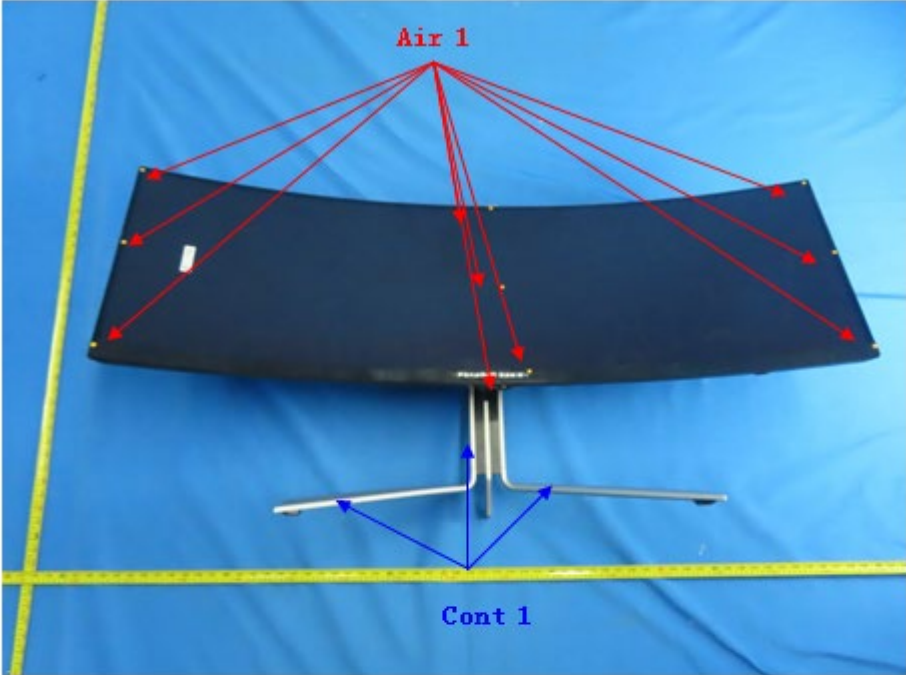

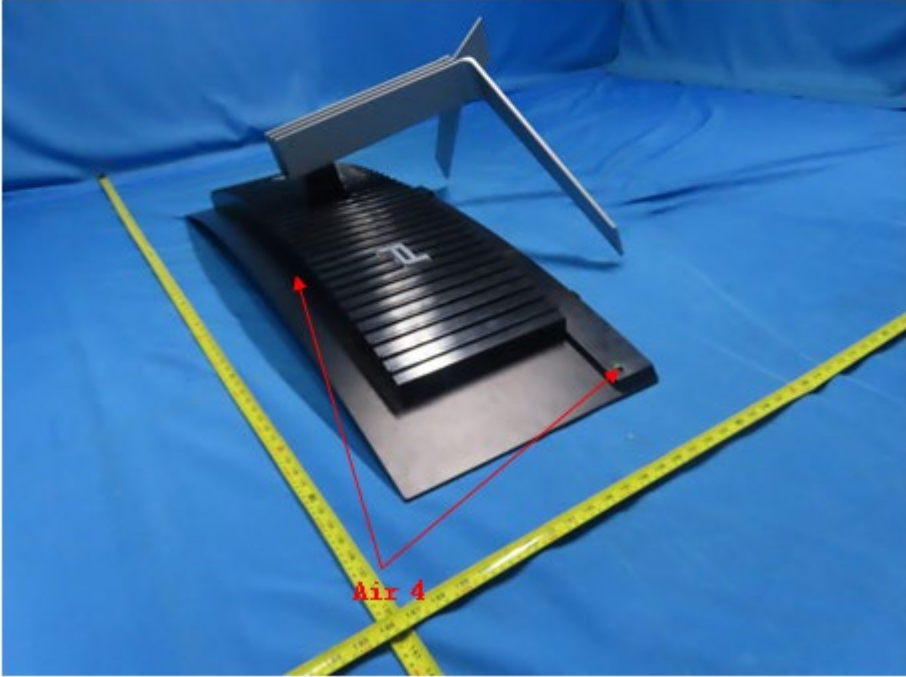
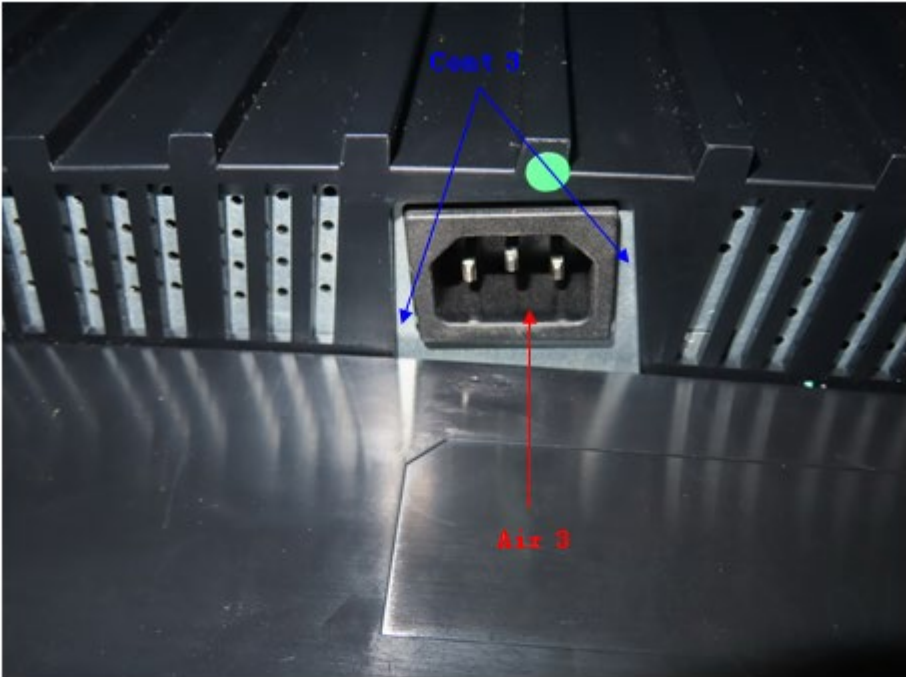

5.6 RADIATED, RADIO-FREQUENCY, ELECTROMAGNETIC FIELD IMMUNITY TEST (RS)

5.6.1 TEST SPECIFICATION

Basic Standard	IEC 61000-4-3
Required Performance	A
Frequency Range	80 MHz - 1000 MHz, 1800 MHz, 2600 MHz, 3500 MHz, 5000MHz ($\pm 1\%$)
Field Strength	3 V/m(unmodulated, r.m.s)
Modulation	1 kHz Sine Wave, 80%, AM Modulation
Frequency Step	1% of fundamental
Polarity of Antenna	Horizontal and Vertical
Test Distance	3 m
Antenna Height	1.55 m
Dwell Time	3 seconds

5.6.2 MEASUREMENT INSTRUMENTS

Item	Kind of Equipment	Manufacturer	Type No.	Serial No.	Calibrated until
1	Antenna	ETS	3142B	26419	Dec. 05, 2023
2	Amplifier	AR	50S1G4A	326720	Jan. 07, 2024
3	MXG Analog Signal Generator	Agilent	N5181A	MY49060710	Jun. 17, 2024
4	Conditioning Amplifier	B&K	_2690__0F2_	2723746	Jun. 11, 2024
5	Power amplifier	MILMEGA	AS1860-50	1064834	Jan. 07, 2024
6	Microwave Log.-Per. Antenna	Schwarzbeck	STLP 9149	9149-277	Apr. 14, 2024
7	Power amplifier	MILMEGA	80RF1000-250	1064833	Jan. 07, 2024
8	Measurement Software	Farad	(EZ-RS)V2.0.1.3	N/A	N/A
9	Free-field 1/2`Microphone	B&K	4190-L-001	2878077	Jun. 25, 2024
10	UPV Audio Analyzer	R&S	UPV	104259	Jan. 07, 2024

Remark: "N/A" denotes no model name, no serial No. or no calibration specified.

All calibration period of equipment list is one year.

5.6.3 TEST PROCEDURE

The EUT and support equipment are in a fully-anechoic chamber.

The testing distance from antenna to the EUT was 3 meters.

For TABLE-TOP equipment:

The EUT installed in a representative system as described in IEC 61000-4-3 was placed on a non-conductive table 0.8 meters in height. The system under test was connected to the power and signal wire according to relevant installation instructions.

- a. The field strength level was 3 V/m(unmodulated, r.m.s).
- b. The frequency range is swept from 80 MHz to 1000 MHz, with the signal 80%amplitude modulated with a 1 kHz sine wave. Where the frequency range is swept incrementally, the step size was 1% of fundamental.
- c. The dwell time at each frequency shall be not less than the time necessary for the EUT to be able to respond.
- d. The test was performed with the EUT exposed to both vertically and horizontally polarized fields on each of the four sides.

For Display and display output functions:

- a. The display quality evaluated by direct observation.
- b. For display output function evaluation, a suitable display device shall be connected. This device shall meet the immunity requirements for displays specified in this document. The screen size shall be typical for the display output. the diagonal screen size shall be at least 0,50 m.
- c. The display shall be observed under normal viewing conditions including viewing distance using a reduced ambient light level preferably in the range 15 lx to 20 lx. The viewing distance or settings of the video camera monitoring system shall be sufficient to provide visibility of the whole display. In the case of direct observation the selected viewing distance shall be recorded in the test report.

For Acoustic measurements:

- a. Apply an appropriate input signal to the EUT so that a sine wave (tone) at the frequency that will be used to modulate the applied disturbance (typically 1 kHz) is generated from the port under test at a level equal to the acoustic reference level.
- b. Record the resulting dB (SPL) level (or other appropriate dB unit) as the value of L_0 .
(BTL lab uses the software to take L_0 as the reference value and make it return to zero.)
- c. Change the input to the EUT so that the port under test is silent, or represents silence. This change shall not alter the terminating impedance at the EUT's input.
- d. Apply the RF disturbance to the applicable port of the EUT and record the resulting demodulated audio level in dB (SPL) (or other dB unit used in step d)) as the value of L_1 .
- e. Ensure that non-linear processing does not impact the measurements.
- f. Calculate the acoustic interference ratio using the following formula:
Acoustic interference ratio = $L_1 - L_0$.
(For step e-f, BTL lab proceeds the test with software and calculate Acoustic interference ratio = $L_1 - L_0$).

5.6.4 DEVIATION FROM TEST STANDARD

No deviation

5.6.5 TEST SETUP

- a) For Continuous induced RF disturbances

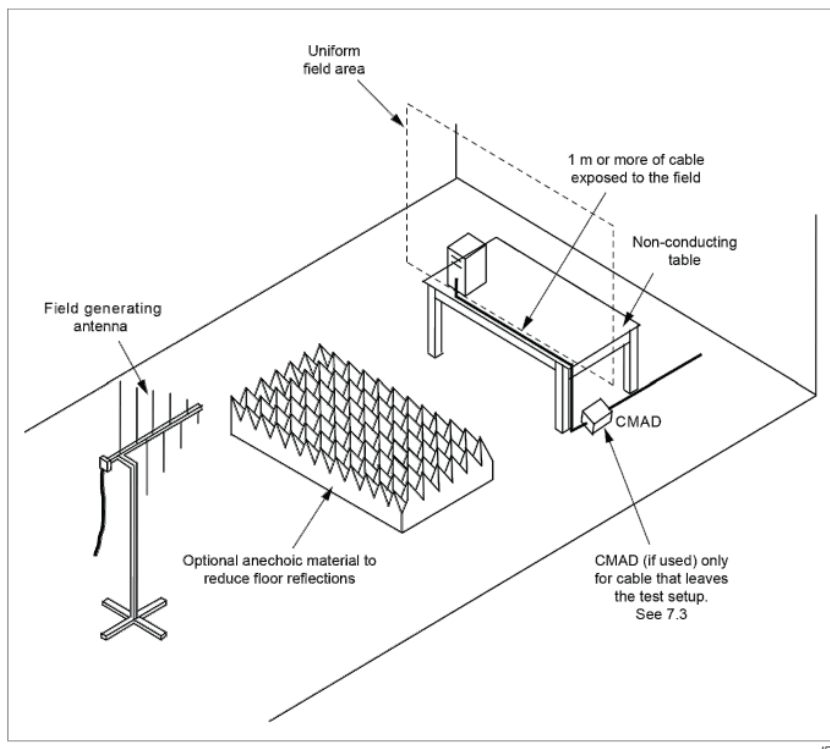

For Audio output function

(1) Audio output port

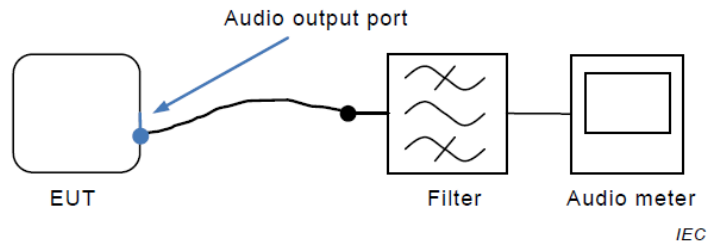

The filter is the audio filter specified in G.6.1 and is typically incorporated into the audio meter. Additional filtering might be necessary to ensure that the RF disturbance signal does not interfere with the measurement.

(2) Loudspeaker

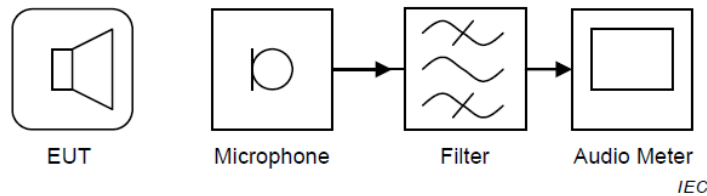

The filter is the audio filter specified in G.6.1 and is typically incorporated into the audio meter. Additional filtering might be necessary to ensure that the RF disturbance signal does not interfere with the measurement.

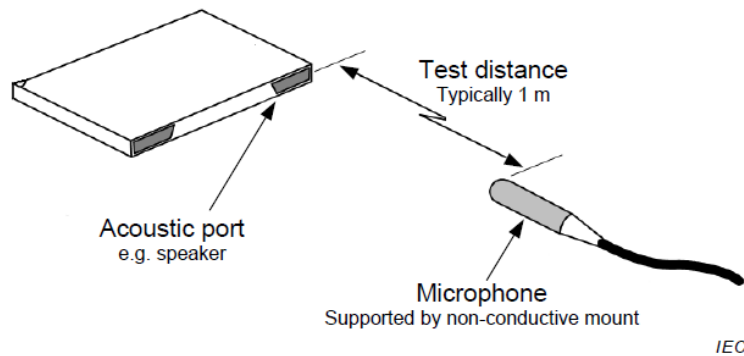

The microphone is connected via the cable to a suitable amplifier. Ensure that there is minimal acoustic loss between EUT and microphone.

5.6.6 TEST RESULTS

Test Voltage	AC 230V/50Hz
Test Mode	Mode 1-5, 8-15

Frequency Range (MHz)	RF Field Position	R.F. Field Strength	Modulation	Azimuth	Criterion	Result
80 - 1000	H / V	3V/m	AM Modulated 1000Hz, 80%	0	A	A
				90		
				180		
				270		
1800, 2600, 3500, 5000 (±1%)	H / V	3V/m	AM Modulated 1000Hz, 80%	0	A	A
				90		
				180		
				270		

For Audio output function

(1) For Audio output port:

Test Voltage	AC 230V/50Hz
Test Mode	Mode 1_Vertical_Front

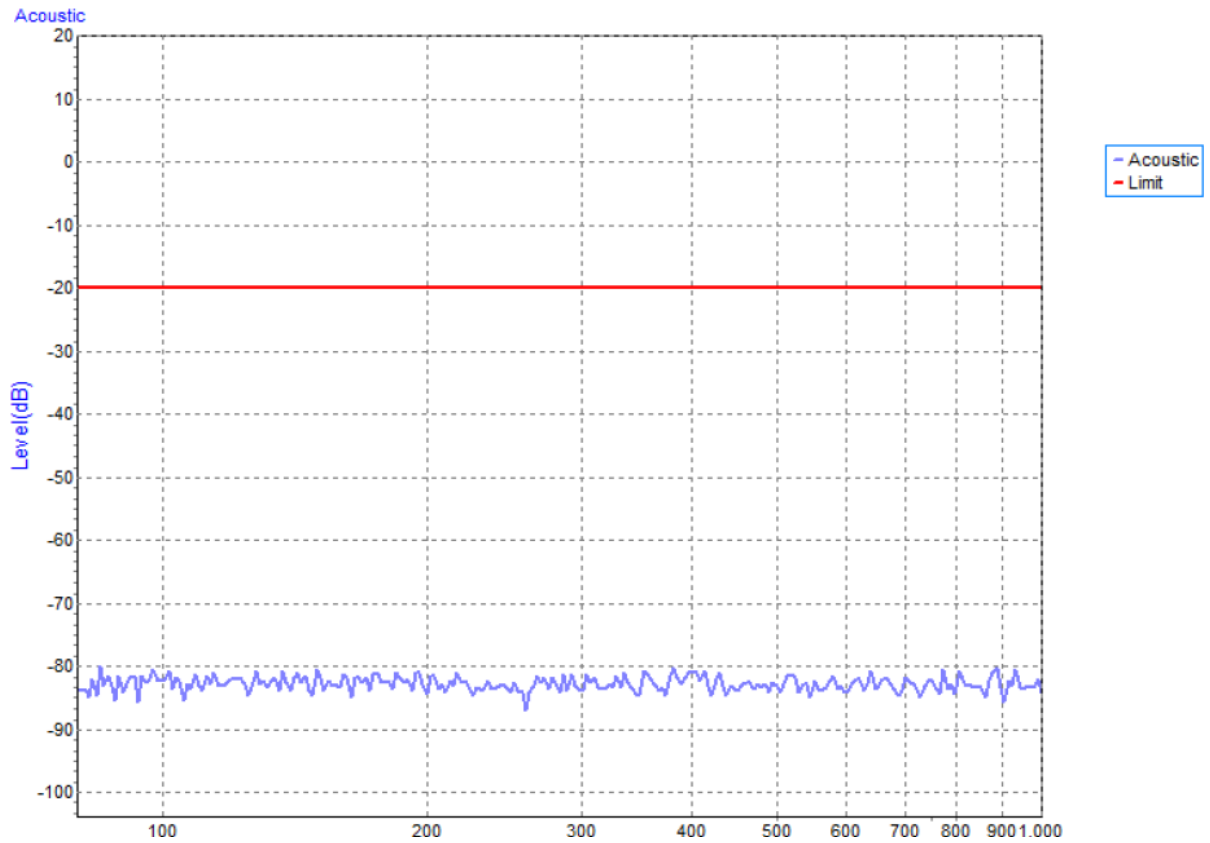

Test Voltage	AC 230V/50Hz
Test Mode	Mode 1_ Horizontal _Front

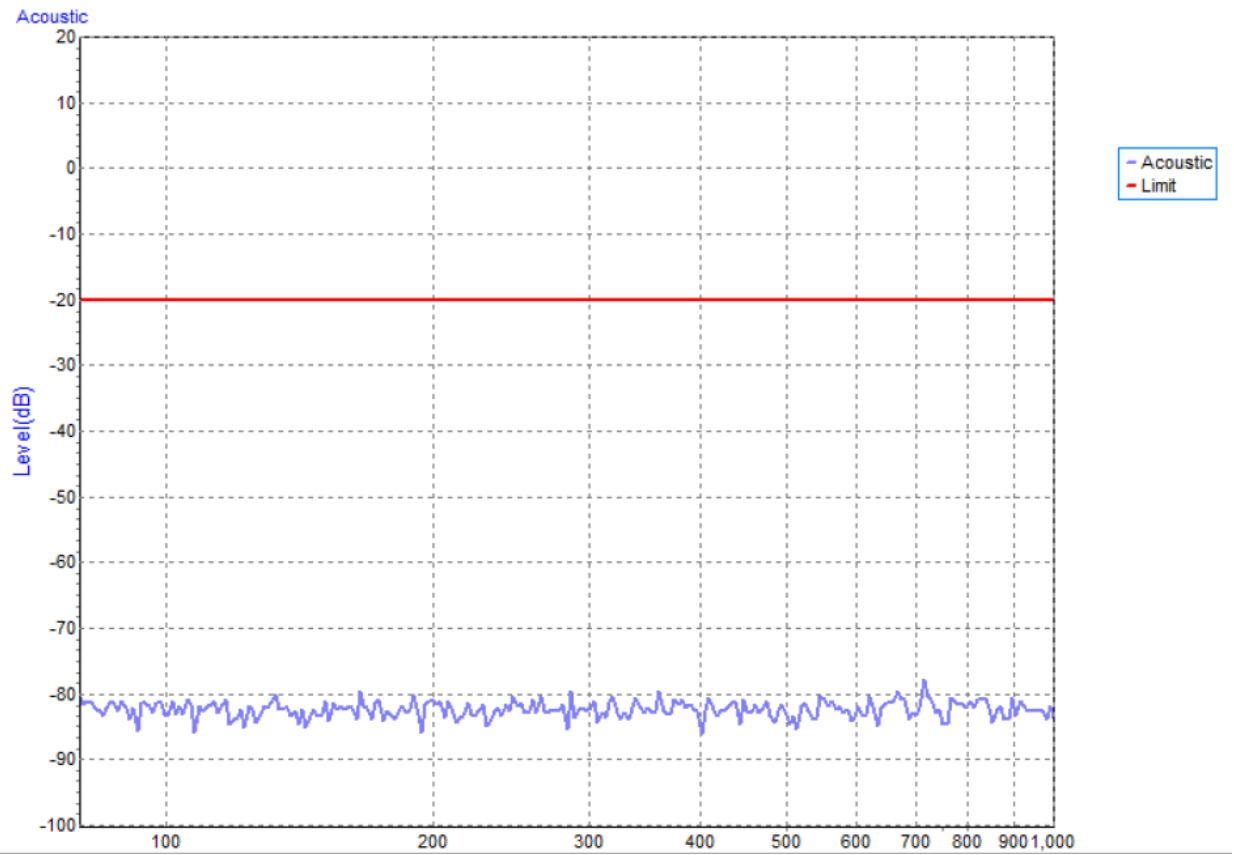

(2) For Loudspeaker:

Test Voltage	AC 230V/50Hz
Test Mode	Mode 1_Vertical_Front

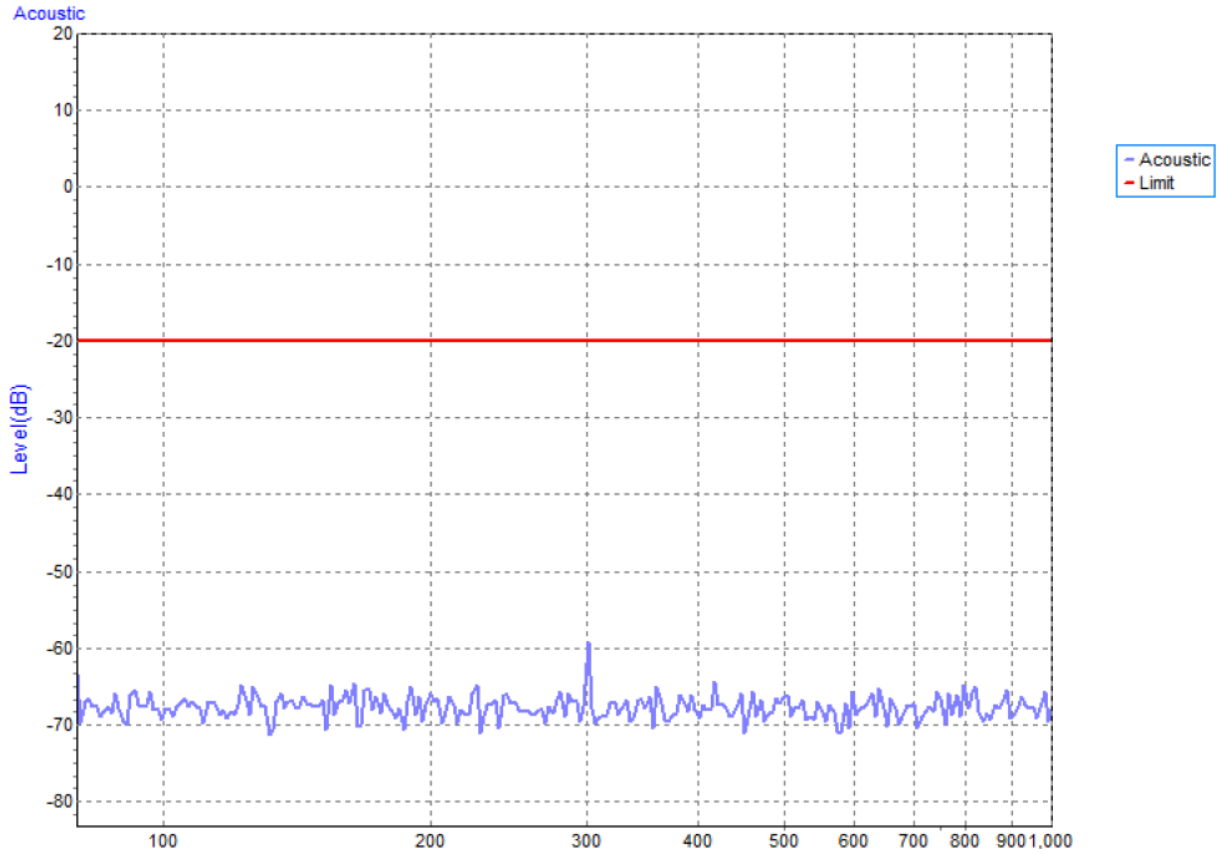

Test Voltage	AC 230V/50Hz
Test Mode	Mode 1_ Horizontal _Front

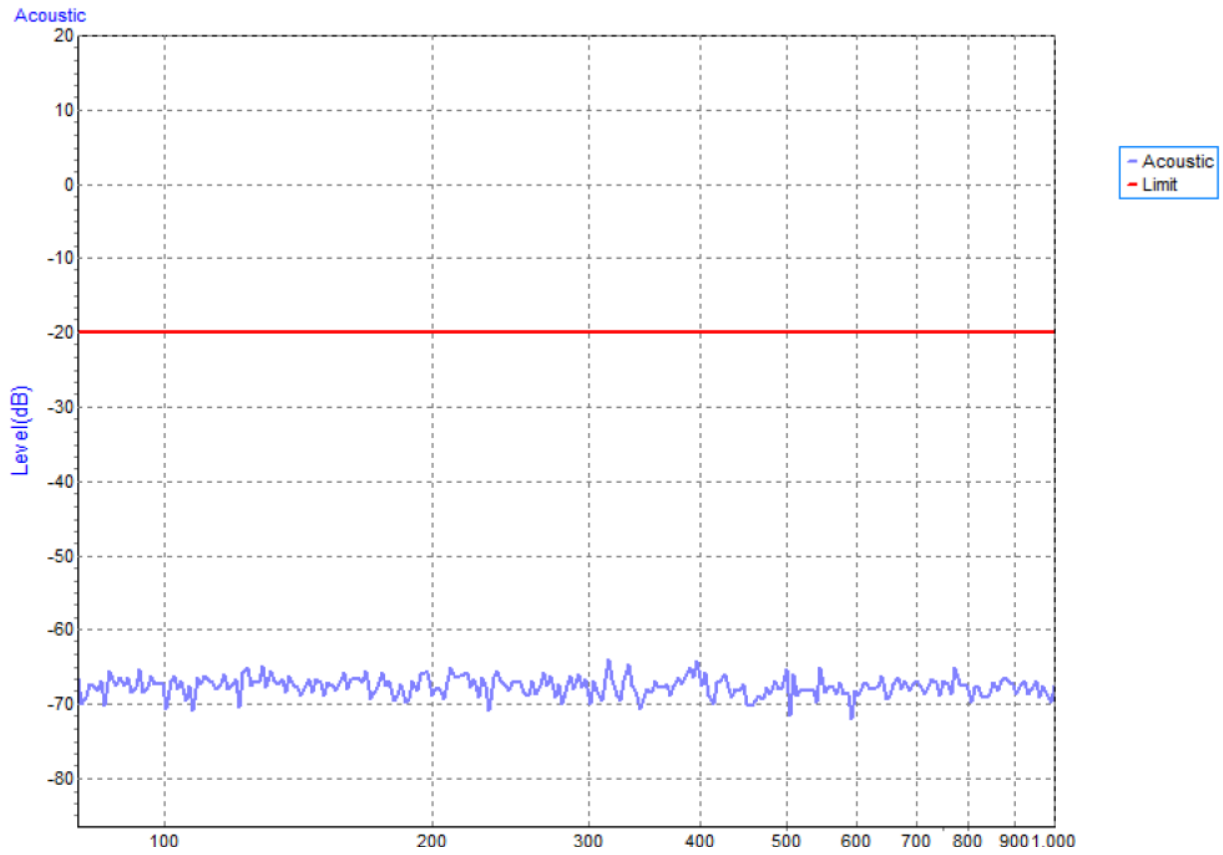

5.7 ELECTRICAL FAST TRANSIENT/BURST IMMUNITY TEST (EFT)

5.7.1 TEST SPECIFICATION

Basic Standard	IEC 61000-4-4
Required Performance	B
Test Voltage	AC mains power ports: ± 1 Kv Analogue/digital data ports: ± 0.5 kV
Polarity	Positive & Negative
Impulse Frequency	5 kHz
Impulse Wave shape	5/50 ns
Burst Duration	15 ms
Burst Period	300 ms
Test Duration	1 min.

5.7.2 MEASUREMENT INSTRUMENTS

Item	Kind of Equipment	Manufacturer	Type No.	Serial No.	Calibrated until
1	Fast Transient Burst Simulator	Prima	EFT61004TA	PR190741004	Jun. 16, 2024
2	Measurement Software	Prima	EFT_Series V1.0.0.0.20180710	N/A	N/A

Remark: "N/A" denotes no model name, no serial No. or no calibration specified.

All calibration period of equipment list is one year.

5.7.3 TEST PROCEDURE

For TABLE-TOP equipment:

The configuration consisted of a wooden table (0.8m high) standing on the Ground Reference Plane and should be located 0.1 m \pm 0.01m above the Ground Reference Plane. The GRP consisted of a sheet of aluminum (at least 0.25mm thick and 2.5m square) connected to the protective grounding system. A minimum distance of 0.5m was provided between the EUT and the walls of the laboratory or any other metallic structure.

- a. Both positive and negative polarity discharges were applied.
- b. The duration time of each test sequential was 1 minute.

5.7.4 DEVIATION FROM TEST STANDARD

No deviation

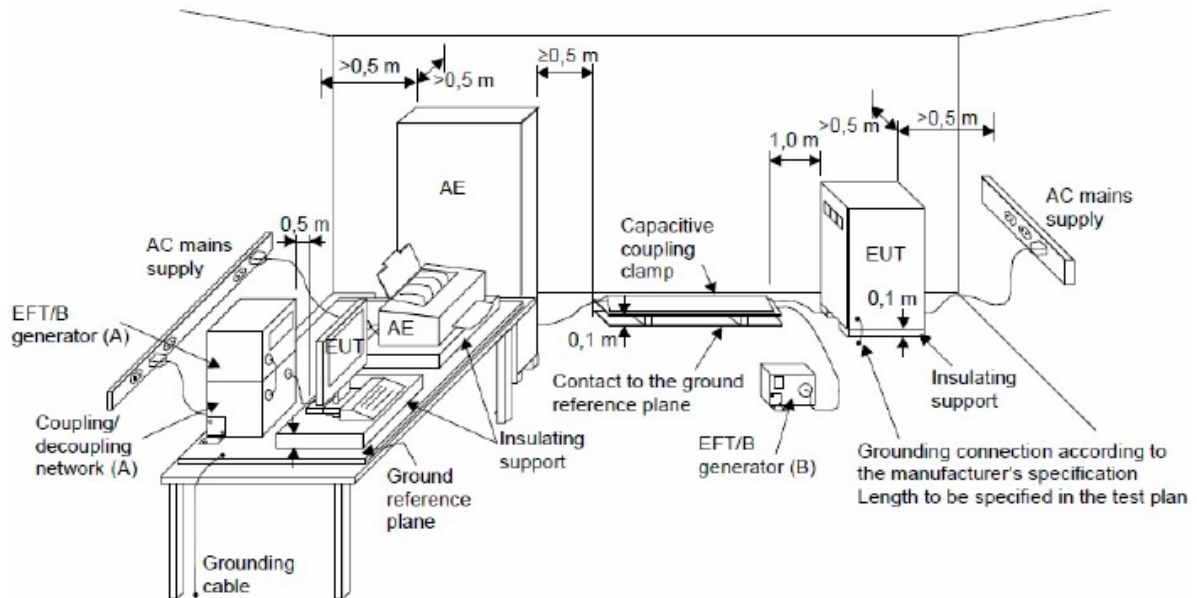
5.7.5 TEST SETUP

5.7.6 TEST RESULTS

Test Voltage	AC 230V/50Hz
Test Mode	Mode 1-5, 8-15

EUT Ports Tested		Polarity	Repetition Frequency	Test Level	Criterion	Result
				1kV		
AC Power Port	Line (L)	+	5 kHz	B	B	B
		-	5 kHz	B		
	Neutral (N)	+	5 kHz	B	B	B
		-	5 kHz	B		
	Ground (PE)	+	5 kHz	B	B	B
		-	5 kHz	B		
	L+N	+	5 kHz	B	B	B
		-	5 kHz	B		
	L+PE	+	5 kHz	B	B	B
		-	5 kHz	B		
	N+PE	+	5 kHz	B	B	B
		-	5 kHz	B		
	L+N+PE	+	5 kHz	B	B	B
		-	5 kHz	B		

EUT Ports Tested		Polarity	Repetition Frequency	Test Level	Criterion	Result
				0.5 kV		
Analogue/digital data ports	LAN	+	5 kHz	B	B	B
		-	5 kHz	B		

5.8 SURGE IMMUNITY TEST (SURGE)

5.8.1 TEST SPECIFICATION

Basic Standard	IEC 61000-4-5
Required Performance	B(AC mains power ports)
Wave-Shape	1.2/50(8/20) Tr/Th μ s combination wave
Test Voltage	AC mains power ports: ± 0.5 kV, ± 1 kV, ± 2 kV
Generator Source Impedance	2 Ω of the low-voltage power supply network. 12 Ω (10 Ω +2 Ω) of the low-voltage power supply network and ground.
Phase Angle, Polarity and Number of Tests	Five positive pulses line-to-neutral at 90°phase Five negative pulses line-to-neutral at 270°phase Five positive pulses line-to-earth at 90°phase Five negative pulses line-to-earth at 270°phase Five negative pulses neutral-to-earth at 90°phase Five positive pulses neutral-to-earth at 270°phase
Pulse Repetition Rate	1 time / min

5.8.2 MEASUREMENT INSTRUMENTS

Item	Kind of Equipment	Manufacturer	Type No.	Serial No.	Calibrated until
1	Lightning Surge Generator	Prima	SUG61005TB	PR190854067	Jun. 16, 2024
2	Measurement Software	Prima	SUG_Series V1.0.0.7.20190 827	N/A	N/A

Remark: "N/A" denotes no model name, no serial No. or no calibration specified.

All calibration period of equipment list is one year.

5.8.3 TEST PROCEDURE

a. For EUT power supply:

The surge is to be applied to the EUT power supply terminals via the capacitive coupling network. Decoupling networks are required in order to avoid possible adverse effects on equipment not under test that may be powered by the same lines, and to provide sufficient decoupling impedance to the surge wave. The power cord between the EUT and the coupling/decoupling networks shall be 2meters in length (or shorter).

b. For test applied to unshielded unsymmetrically operated interconnection lines of EUT :

The surge is applied to the lines via the capacitive coupling. The coupling /decoupling networks shall not influence the specified functional conditions of the EUT. The interconnection line between the EUT and the coupling/decoupling networks shall be 2 meters in length (or shorter).

c. For test applied to unshielded symmetrically operated interconnection /telecommunication lines of EUT :

The surge is applied to the lines via gas arrestors coupling. Test levels below the ignition point of the coupling arrestor cannot be specified. The interconnection line between the EUT and the coupling/decoupling networks shall be 2 meters in length (or shorter).

5.8.4 DEVIATION FROM TEST STANDARD

No deviation

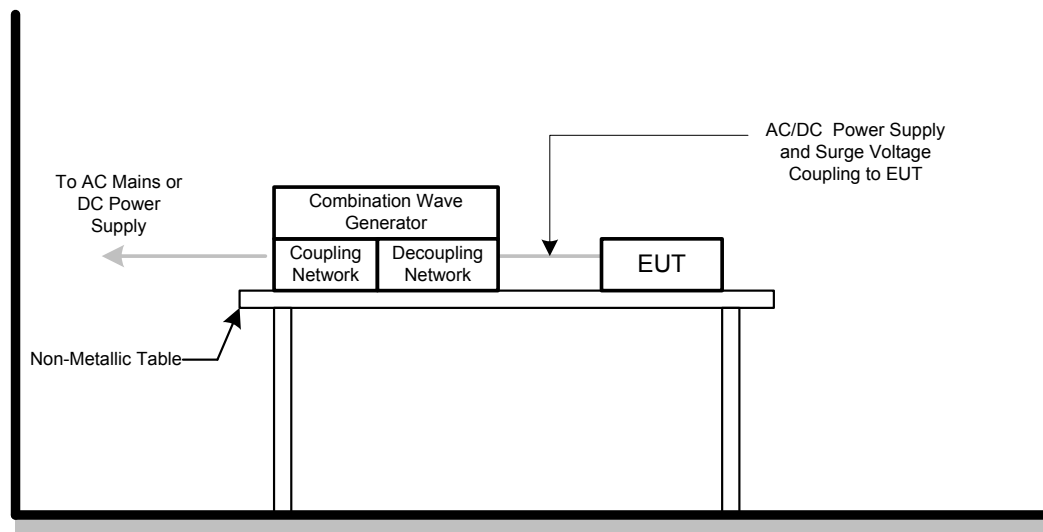
5.8.5 TEST SETUP

5.8.6 TEST RESULTS

Test Voltage	AC 230V/50Hz
Test Mode	Mode 1-5, 8-15

Wave Form EUT Ports Tested		1.2/50(8/20)Tr/Thµs						Criterion	Result
		Polarity	Phase	Voltage					
				0.5kV	1kV	-- kV	-- kV		
AC	L – N	+	90°	A	B	-	-	B	B
		-	270°	A	B	-	-		

Wave Form EUT Ports Tested		1.2/50(8/20)Tr/Thµs						Criterion	Result
		Polarity	Phase	Voltage					
				0.5kV	1kV	2kV	-- kV		
AC	L – PE	+	90°	A	A	B	-	B	B
		-	270°	A	A	B	-		
	N – PE	-	90°	A	A	B	-	B	B
		+	270°	A	A	B	-		

5.9 IMMUNITY TO CONDUCTED DISTURBANCES, INDUCED BY RADIO-FREQUENCY FIELDS TEST (CS)

5.9.1 TEST SPECIFICATION

Basic Standard	IEC 61000-4-6
Required Performance	A
Frequency Range&Field Strength	0.15 MHz - 10 MHz: 3V (unmodulated, r.m.s.) 10 MHz - 30 MHz: 3V to 1V (unmodulated, r.m.s.) 30 MHz - 80 MHz: 1V (unmodulated, r.m.s.)
Modulation	1 kHz Sine Wave, 80%, AM Modulation
Frequency Step	1% of fundamental
Dwell Time	3 seconds

5.9.2 MEASUREMENT INSTRUMENTS

Item	Kind of Equipment	Manufacturer	Type No.	Serial No.	Calibrated until
1	TEST SYSTEM FOR CONDUCTED AND RADIATED IMMUNITY	TESEQ	NSG 4070B	37513	Jun. 16, 2024
2	Attenuator	Teseq	100-SA-FFN-06	163357	Jun. 16, 2024
3	Measurement Software	Farad	EZ-CS (V2.0.1.4)	N/A	N/A
4	Power CDN	FCC	FCC-801-M2/M3-16A	100270	Jan. 07, 2024
5	Coupling Decoupling Network	Teseq GmbH	CDN M016	35834	Jun. 16, 2024
6	Coupling Decoupling Network	Teseq GmbH	CDN T8-10	40373	Jun. 16, 2024
7	UPV Audio Analyzer	R&S	UPV	104259	Jan. 07, 2024
8	Conditioning Amplifier	B&K	_2690__0F2_	2723746	Jun. 11, 2024
9	Free-field 1/2` Microphone	B&K	4190-L-001	2878077	Jun. 25, 2024

Remark: "N/A" denotes no model name, no serial No. or no calibration specified.

All calibration period of equipment list is one year.

5.9.3 TEST PROCEDURE

The EUT and support equipment, are placed on a table that is 0.8 meter above a metal ground plane measured 1m*1m min. and 0.65mm thick min.

The other condition as following manner:

- a. The field strength level was 3 V (unmodulated, r.m.s.)
- b. The frequency range is swept from 150 kHz to 80 MHz, with the signal 80%amplitude modulated with a 1 kHz sinewave. Where the frequency range is swept incrementally, the step size was 1% of fundamental.
- c. The dwell time at each frequency shall be not less than the time necessary for the EUT to be able to respond.

For Display and display output functions:

- a. The display quality evaluated by direct observation.
- b. For display output function evaluation, a suitable display device shall be connected. This device shall meet the immunity requirements for displays specified in this document. The screen size shall be typical for the display output. the diagonal screen size shall be at least 0,50 m.
- c. The display shall be observed under normal viewing conditions including viewing distance using a reduced ambient light level preferably in the range 15 lx to 20 lx. The viewing distance or settings of the video camera monitoring system shall be sufficient to provide visibility of the whole display. In the case of direct observation the selected viewing distance shall be recorded in the test report.

For Acoustic measurements:

- a. Apply an appropriate input signal to the EUT so that a sine wave (tone) at the frequency that will be used to modulate the applied disturbance (typically 1 kHz) is generated from the port under test at a level equal to the acoustic reference level.
- b. Record the resulting dB (SPL) level (or other appropriate dB unit) as the value of L_0 . (BTL lab uses the software to take L_0 as the reference value and make it return to zero.)
- c. Change the input to the EUT so that the port under test is silent, or represents silence. This change shall not alter the terminating impedance at the EUT's input.
- d. Apply the RF disturbance to the applicable port of the EUT and record the resulting demodulated audio level in dB (SPL) (or other dB unit used in step d)) as the value of L_1 .
- e. Ensure that non-linear processing does not impact the measurements.
- f. Calculate the acoustic interference ratio using the following formula:
 Acoustic interference ratio = $L_1 - L_0$.
 (For step e-f, BTL lab proceeds the test with software and calculate Acoustic interference ratio = $L_1 - L_0$).

5.9.4 DEVIATION FROM TEST STANDARD

No deviation

5.9.5 TEST SETUP

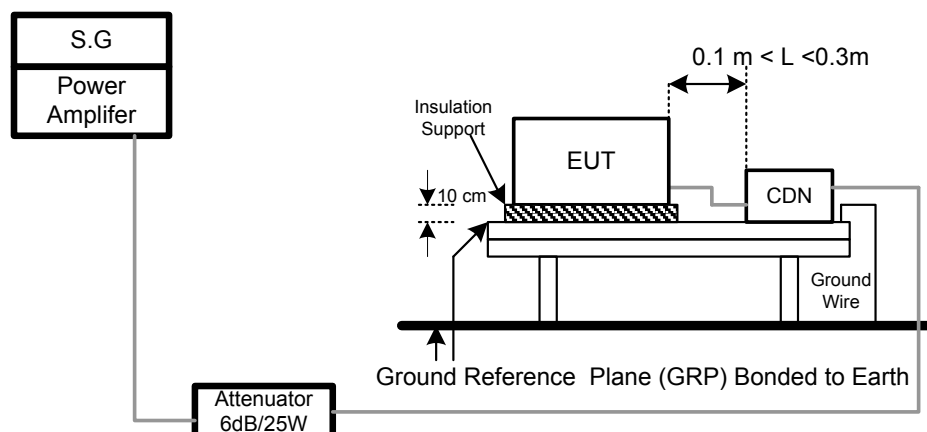

For Audio output function

(1) Audio output port

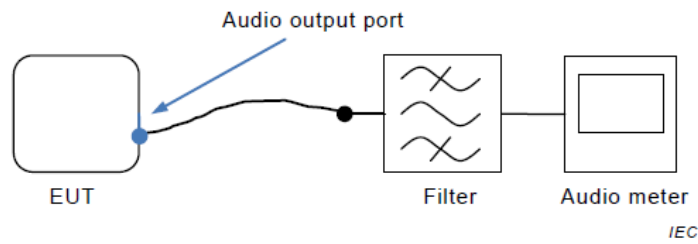

The filter is the audio filter specified in G.6.1 and is typically incorporated into the audio meter. Additional filtering might be necessary to ensure that the RF disturbance signal does not interfere with the measurement.

(2) Loudspeaker

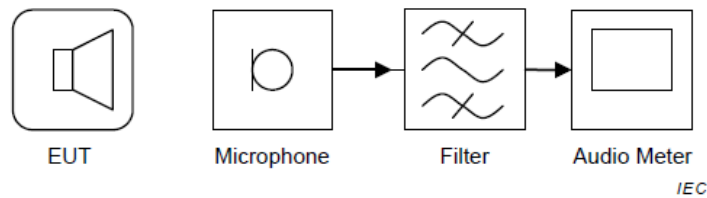

The filter is the audio filter specified in G.6.1 and is typically incorporated into the audio meter. Additional filtering might be necessary to ensure that the RF disturbance signal does not interfere with the measurement.

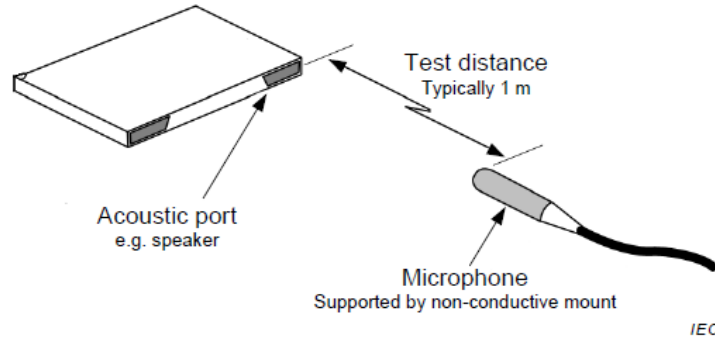

The microphone is connected via the cable to a suitable amplifier. Ensure that there is minimal acoustic loss between EUT and microphone.

5.9.6 TEST RESULTS

Test Voltage	AC 230V/50Hz
Test Mode	Mode 1-5, 8-15

Test Ports (Mode)	Freq.Range (MHz)	Field Strength	Modulation	Criteria	Results
AC mains power ports	0.15 - 10	3V	AM Modulated 1000Hz, 80%	A	A
	10 - 30	3V to 1V			
	30 - 80	1V			
Analogue/digital data ports (LAN)	0.15 - 10	3V	AM Modulated 1000Hz, 80%	A	A
	10 - 30	3V to 1V			
	30 - 80	1V			

For Audio output function

(1) For Audio output port:

Test Voltage	AC 230V/50Hz
Test Mode	Mode 1_CDN M3

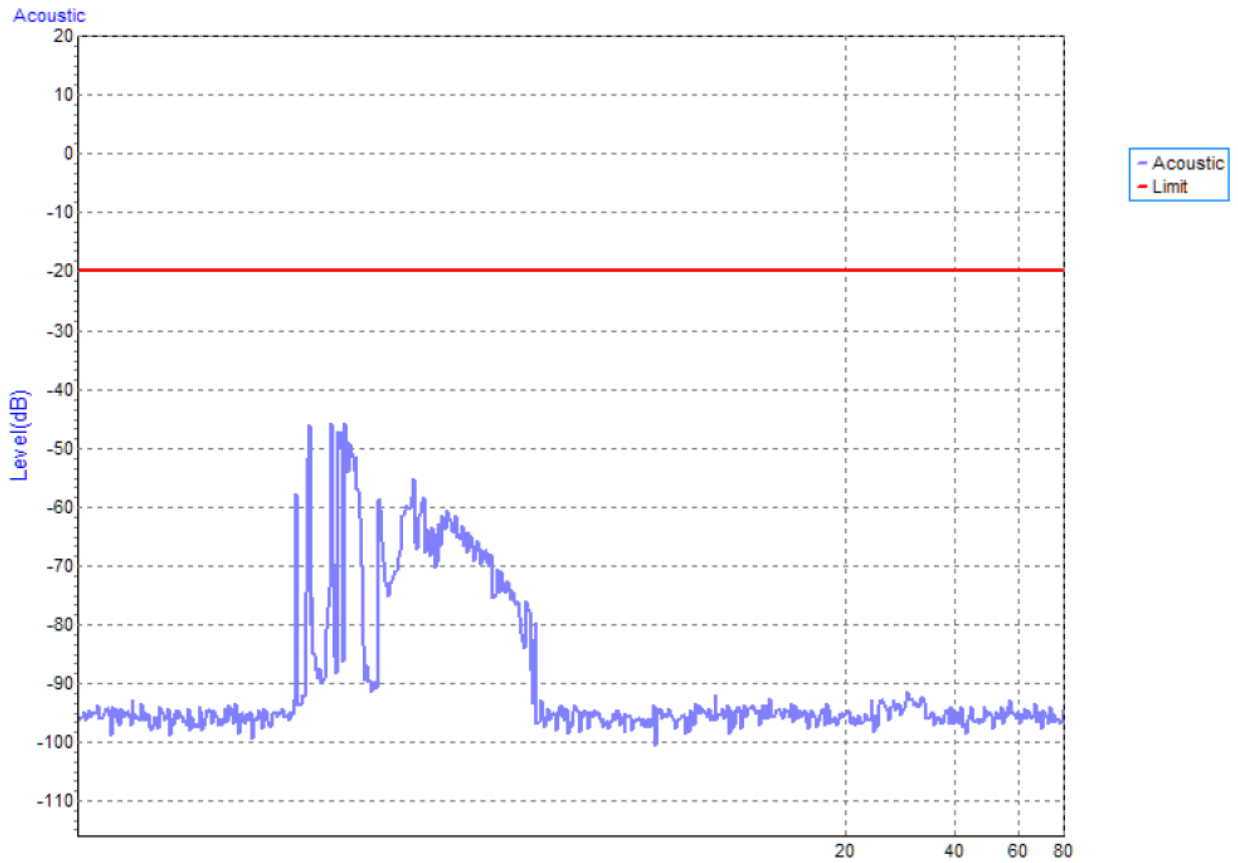

Test Voltage	AC 230V/50Hz
Test Mode	Mode 1_CDN T8

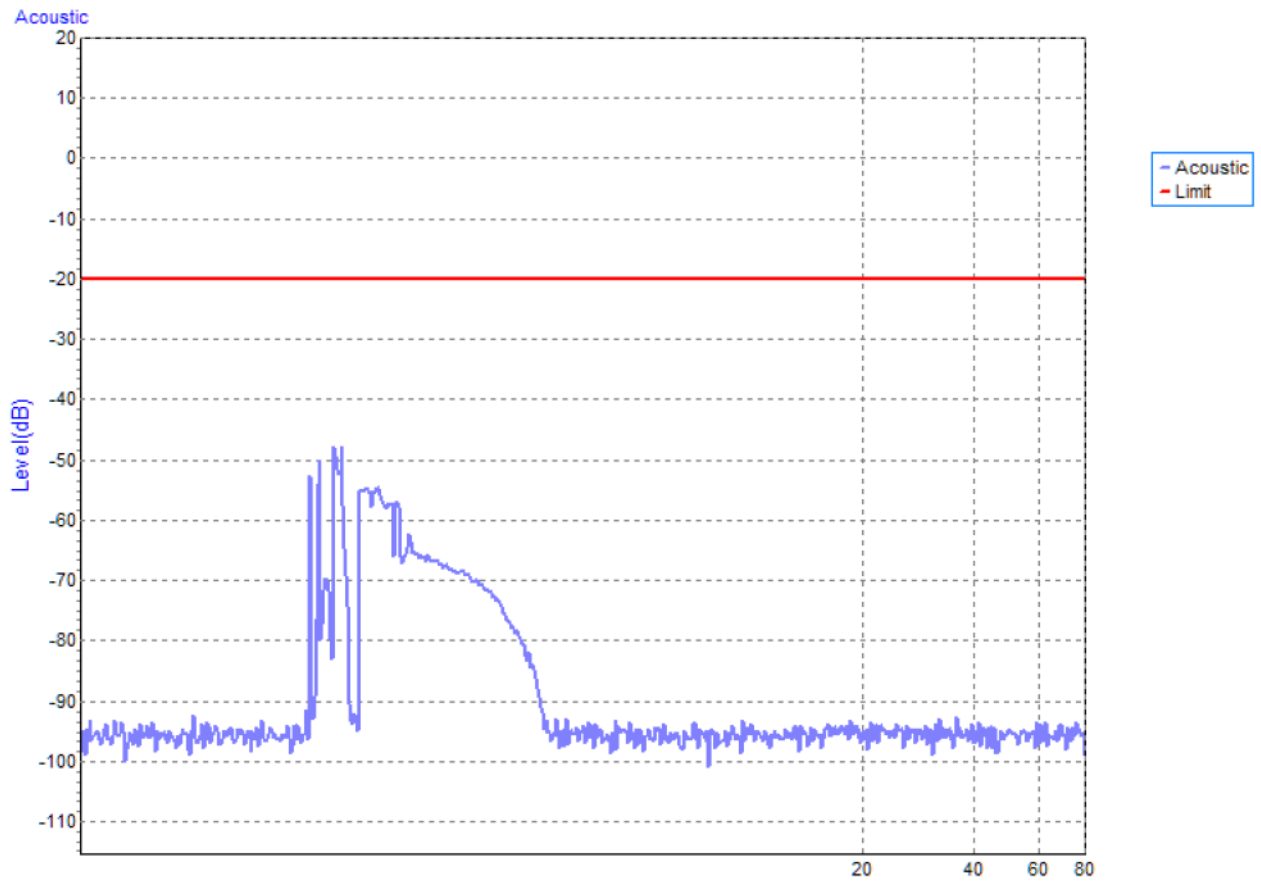

(2) For Loudspeaker:

Test Voltage	AC 230V/50Hz
Test Mode	Mode 1_CDN M3

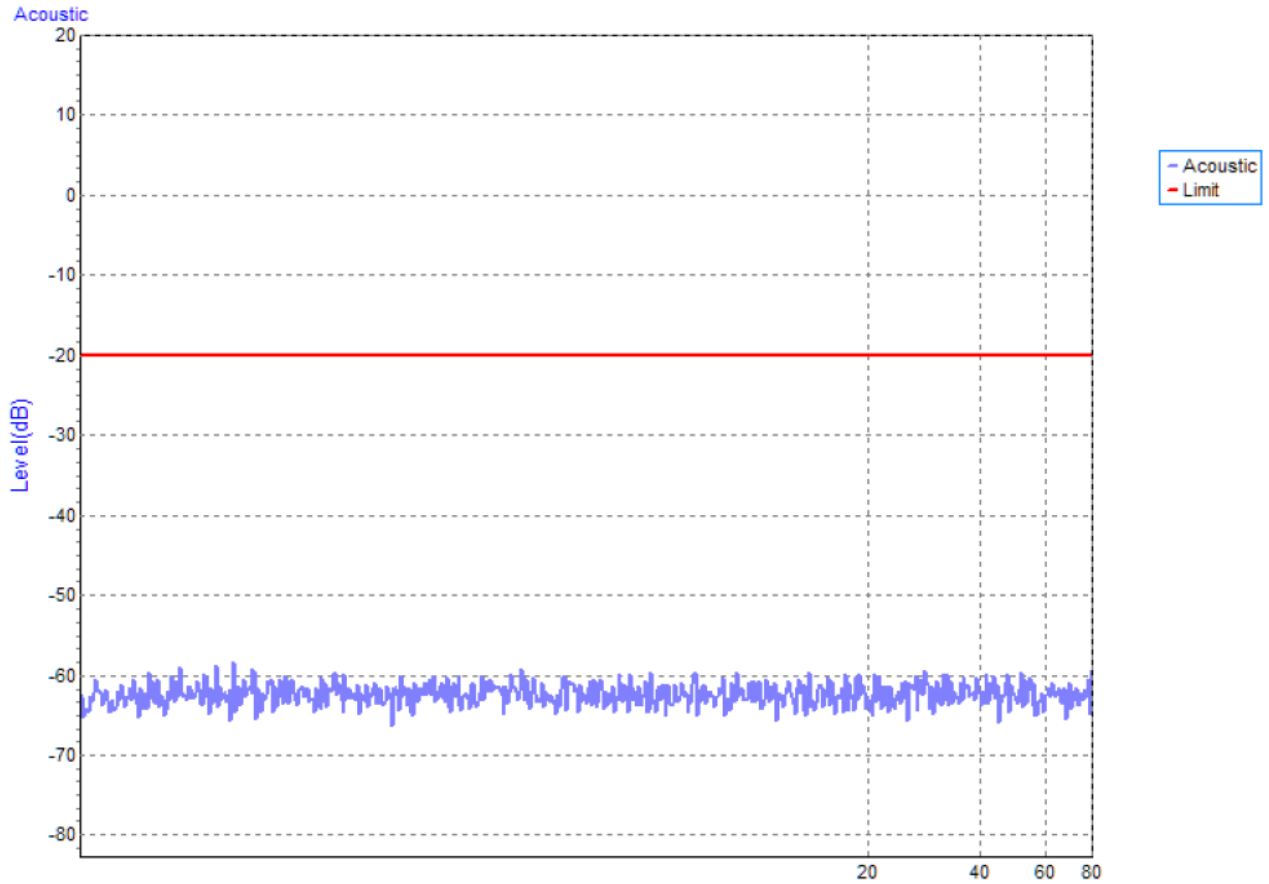

Test Voltage	AC 230V/50Hz
Test Mode	Mode 1_CDN T8

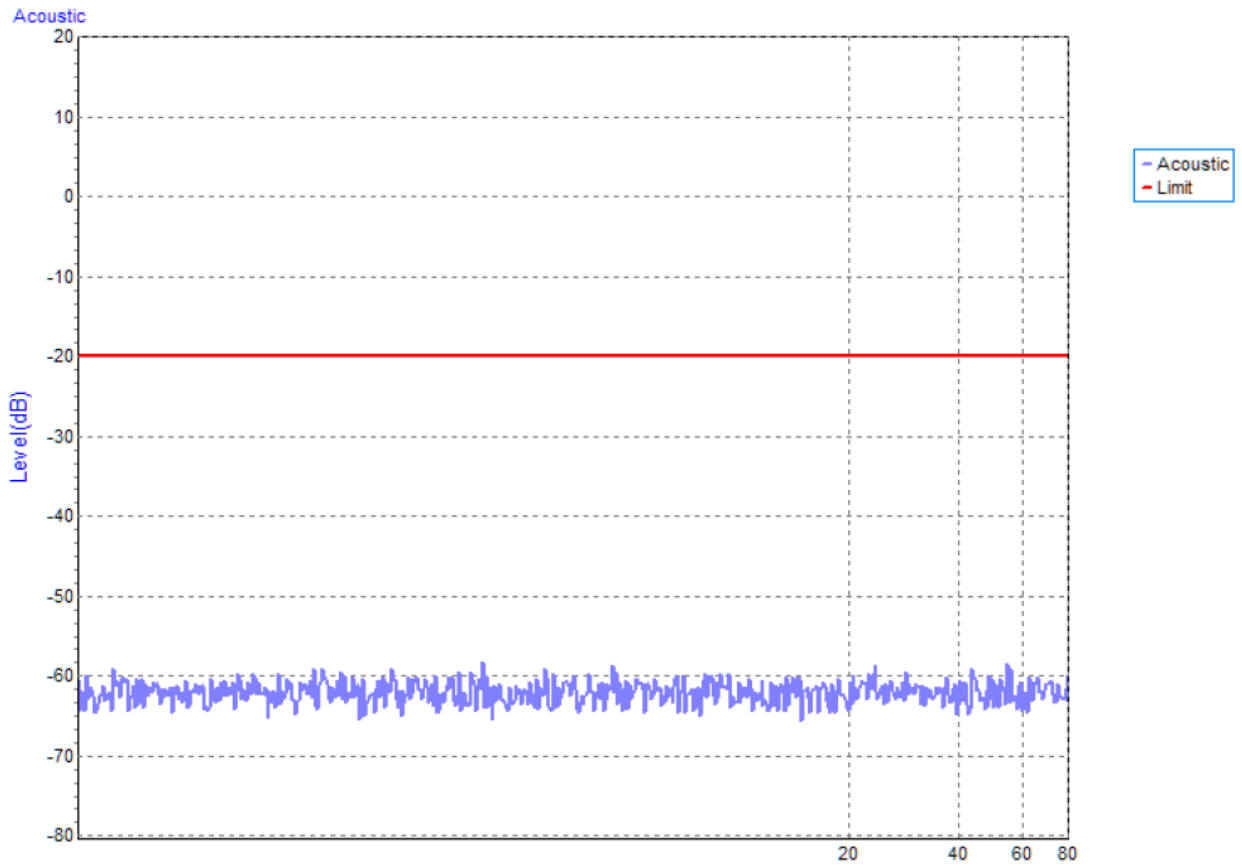

5.10 POWER FREQUENCY MAGNETIC FIELD IMMUNITY TEST (PFMF)

5.10.1 TEST SPECIFICATION

Basic Standard	IEC 61000-4-8
Required Performance	A
Frequency Range	50/60Hz
Field Strength	1 A/m
Observation Time	1 minute
Inductance Coil	Rectangular type, 1mx1m

5.10.2 MEASUREMENT INSTRUMENTS

Item	Kind of Equipment	Manufacturer	Type No.	Serial No.	Calibrated until
1	Magnetic Field test Generator	FCC	F-1000-4-8-G-125A	4032	Jan. 07, 2024
2	Magnetic Field immunity loop	Thermo KeyTek	F-1000-4-8/9/10-L-1M	4024	Jan. 07, 2024

Remark: "N/A" denotes no model name, no serial No. or no calibration specified.

All calibration period of equipment list is one year.

5.10.3 TEST PROCEDURE

For TABLE-TOP equipment:

The equipment shall be subjected to the test magnetic field by using the induction coil of standard dimension (1 m x 1 m). The induction coil shall then be rotated by 90 degrees in order to expose the EUT to the test field with different orientations.

The other condition as following manner:

- a. The equipment cabinets shall be connected to the safety earth directly on the GRP via the earth terminal of the EUT.
- b. The cables supplied or recommended by the equipment manufacturer shall be used. 1 meter of all cables used shall be exposed to the magnetic field.

5.10.4 DEVIATION FROM TEST STANDARD

No deviation

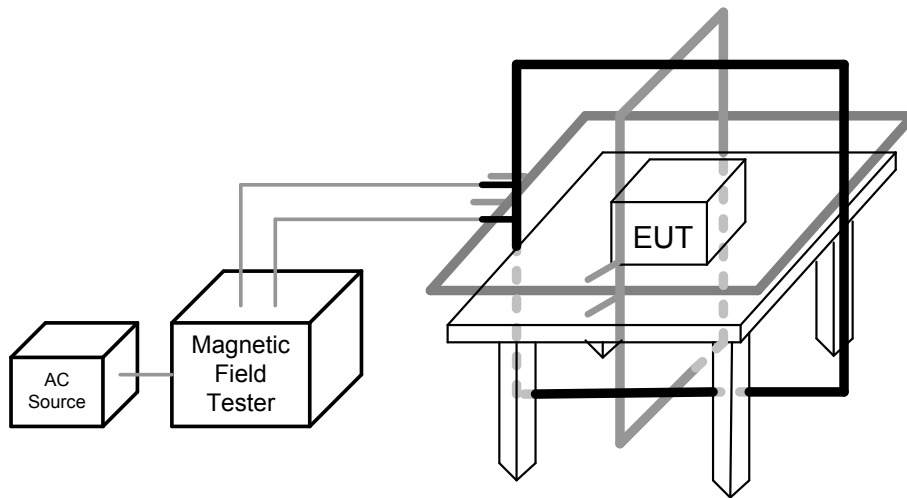
5.10.5 TEST SETUP

5.10.6 TEST RESULTS

Test Voltage	AC 230V/50Hz
Test Mode	Mode 1-5, 8-15

50Hz

Test Mode	Test Level	Antenna aspect	Duration	Criteria	Results
Enclosure	1 A/m	X	60s	A	A
Enclosure	1 A/m	Y	60s	A	A
Enclosure	1 A/m	Z	60s	A	A

60Hz

Test Mode	Test Level	Antenna aspect	Duration	Criteria	Results
Enclosure	1 A/m	X	60s	A	A
Enclosure	1 A/m	Y	60s	A	A
Enclosure	1 A/m	Z	60s	A	A

5.11 VOLTAGE DIPS, SHORT INTERRUPTIONS AND VOLTAGE VARIATIONS IMMUNITY TEST (DIPS)

5.11.1 TEST SPECIFICATION

Basic Standard	IEC 61000-4-11
Required Performance	Voltage dips: B (For <5% residual voltage, dips) C (For 70% residual voltage, dips) C (For <5% residual voltage, Interruptions)
Interval between Event	Ten seconds
Phase Angle	0°/180°
Test Cycle	3 times

5.11.2 MEASUREMENT INSTRUMENTS

Item	Kind of Equipment	Manufacturer	Type No.	Serial No.	Calibrated until
1	Cycle Sag Simulator	Prima	DRP61011TA	PR19076452	Jun. 16, 2024

Remark: "N/A" denotes no model name, no serial No. or no calibration specified.

All calibration period of equipment list is one year.

5.11.3 TEST PROCEDURE

The EUT shall be tested for each selected combination of test levels and duration with a sequence of three dips/interruptions with intervals of 10 s minimum (between each test event). Each representative mode of operation shall be tested. Abrupt changes in supply voltage shall occur at zero crossings of the voltage waveform.

5.11.4 DEVIATION FROM TEST STANDARD

No deviation

5.11.5 TEST SETUP

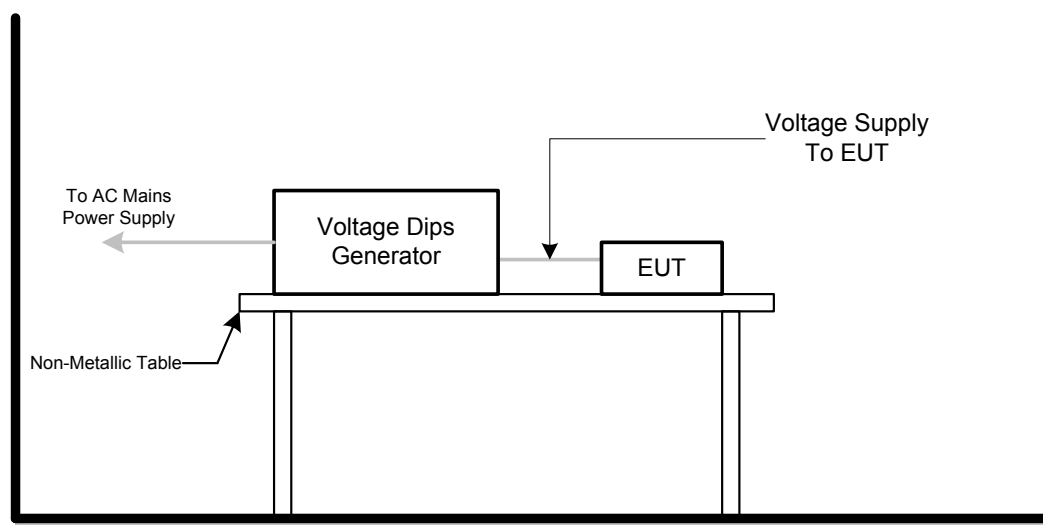

5.11.6 TEST RESULTS

Test Voltage	AC 100V/50Hz, AC 230V/50Hz, AC 240V/50Hz
Test Mode	Mode 1-5, 8-15

AC 100V/50Hz				
Item	Residual Voltage	Cycle	Criteria	Results
Voltage dips	<5%	0.5	B	A
Voltage dips	70%	25	C	A
Voltage Interruption	<5%	250	C	C

AC 230V/50Hz				
Item	Residual Voltage	Cycle	Criteria	Results
Voltage dips	<5%	0.5	B	A
Voltage dips	70%	25	C	A
Voltage Interruption	<5%	250	C	C

AC 240V/50Hz				
Item	Residual Voltage	Cycle	Criteria	Results
Voltage dips	<5%	0.5	B	A
Voltage dips	70%	25	C	A
Voltage Interruption	<5%	250	C	C

6. EUT TEST PHOTO

EN 55032:2015

Radiated emissions up to 1 GHz

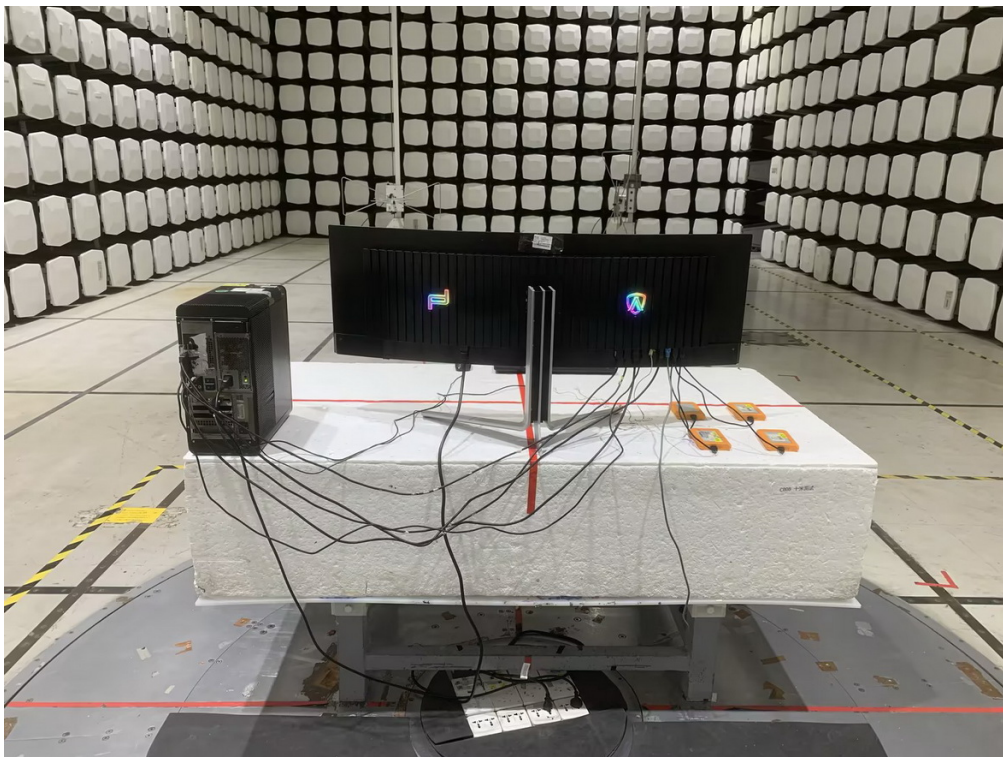
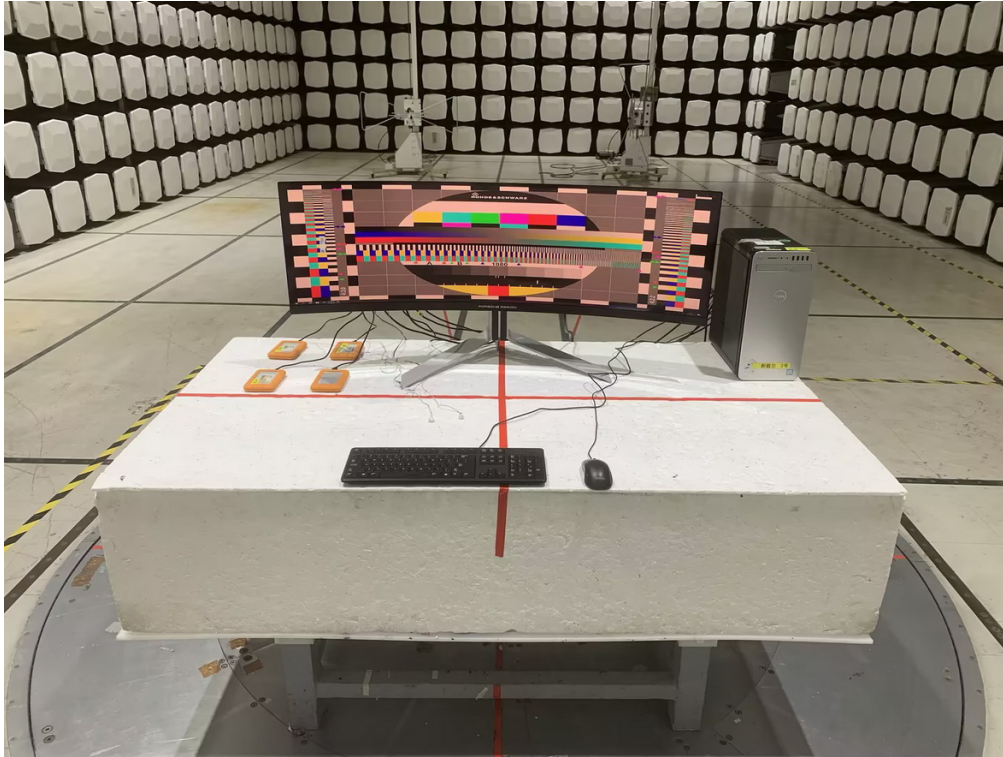

Radiated emissions above 1 GHz

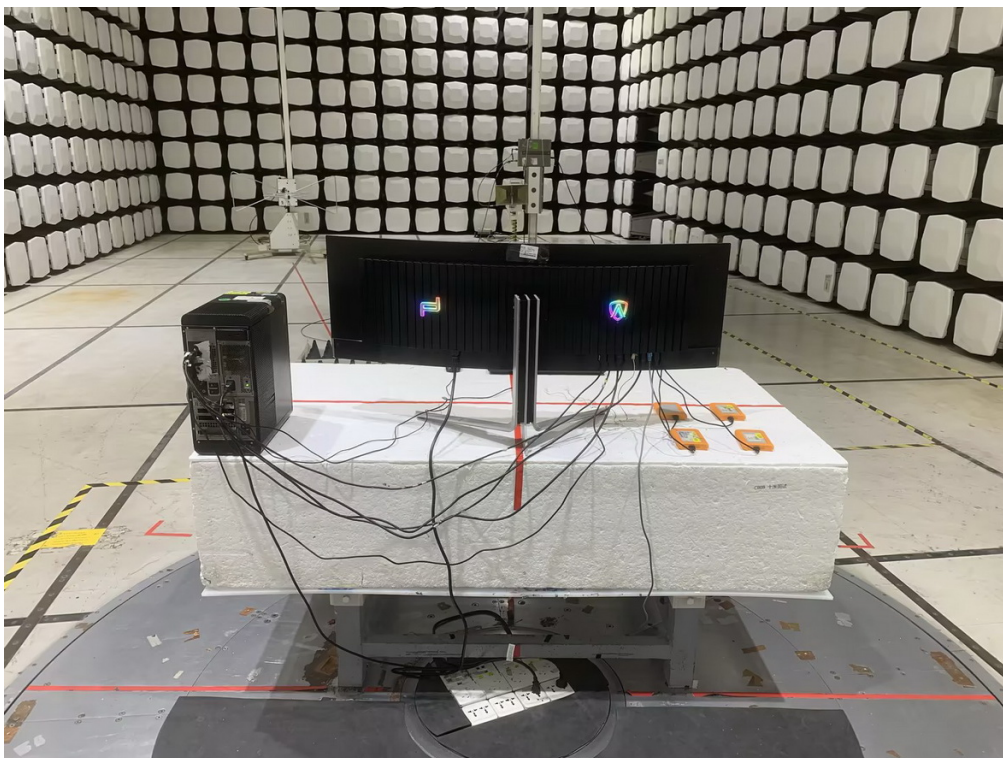
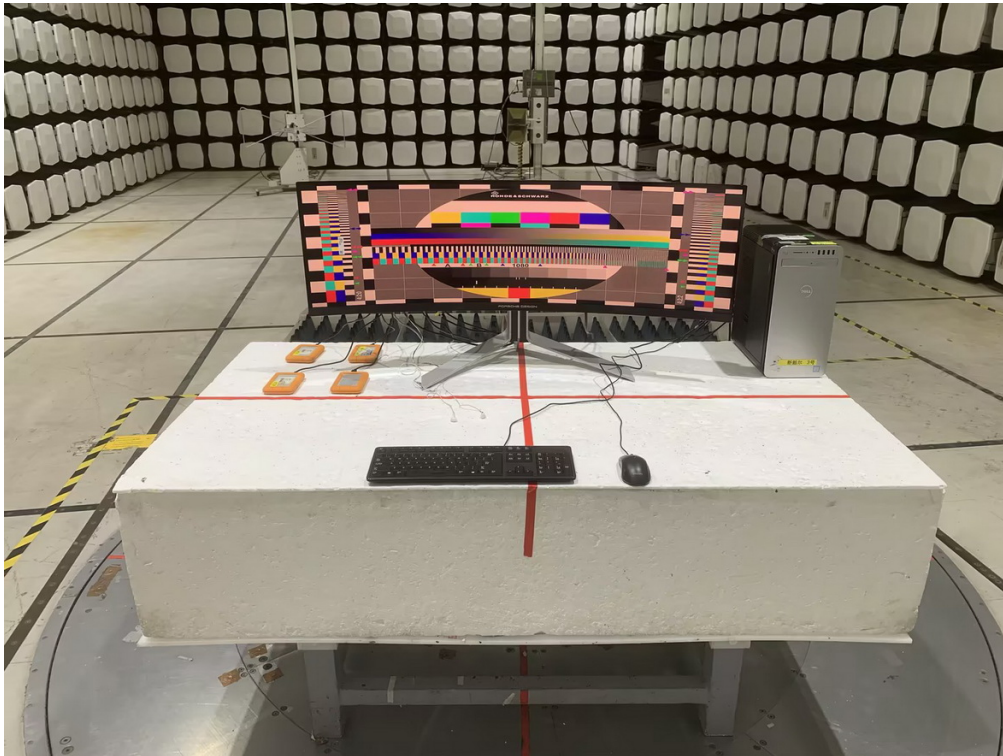

Conducted emissions AC mains power port

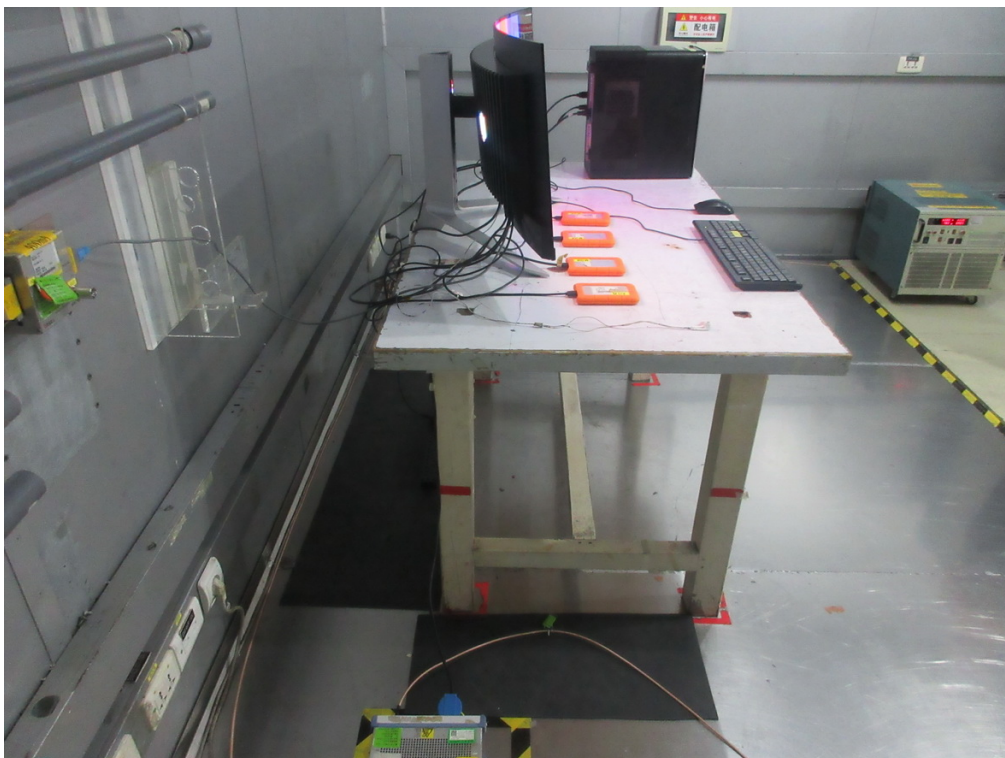
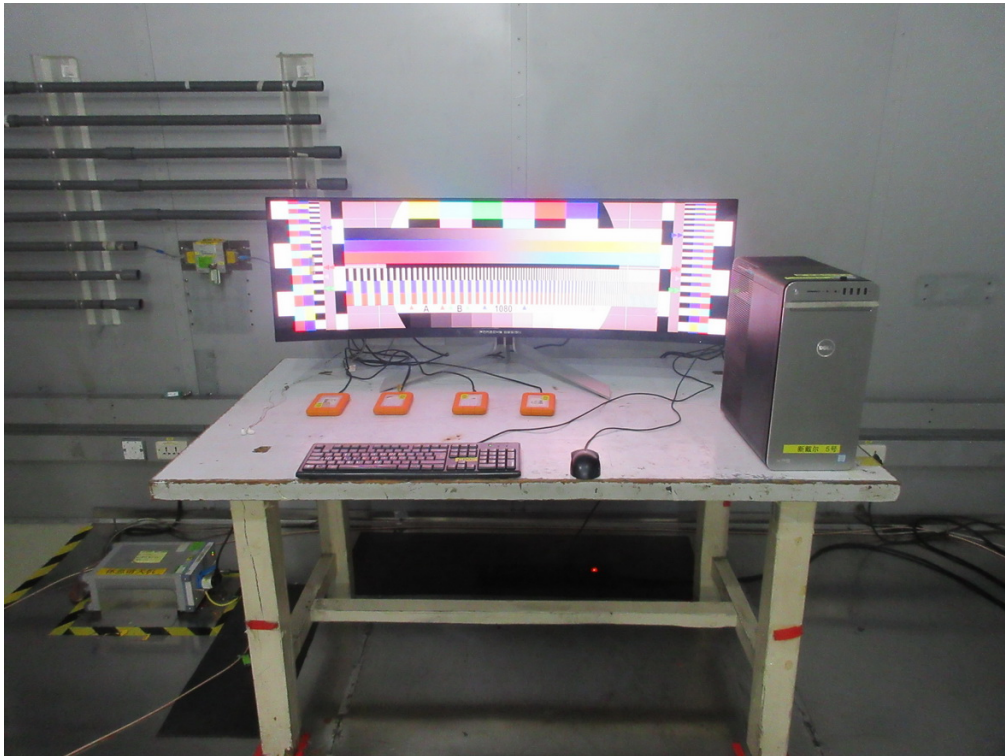

EN 55032:2015+A11:2020

Radiated emissions up to 1 GHz

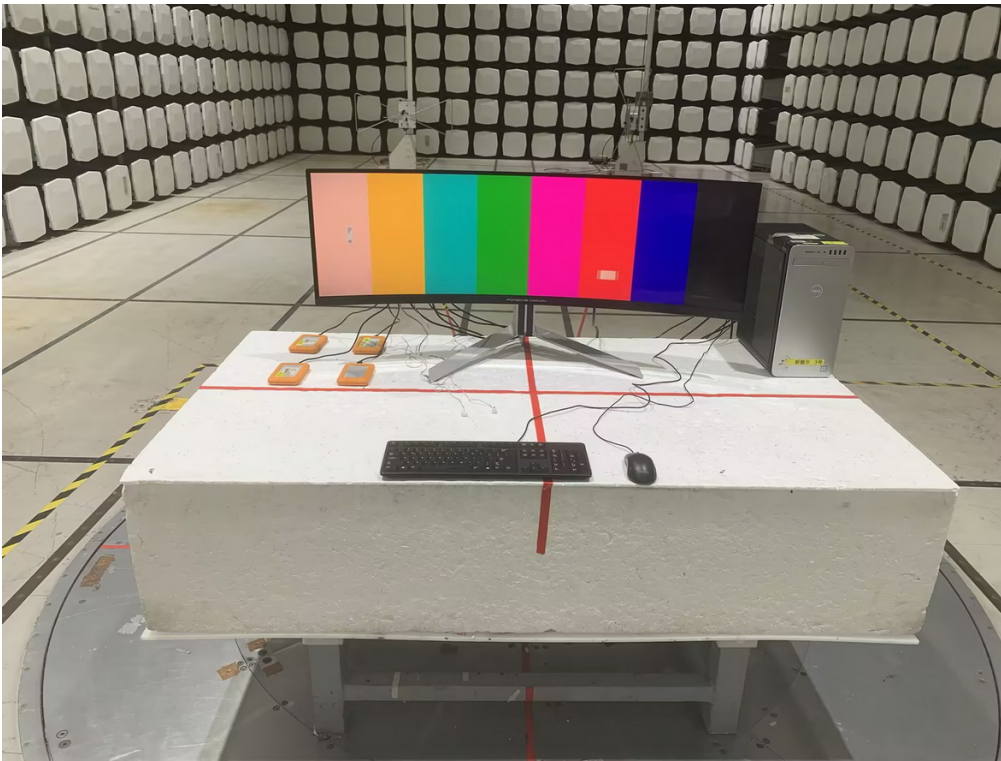

Radiated emissions above 1 GHz

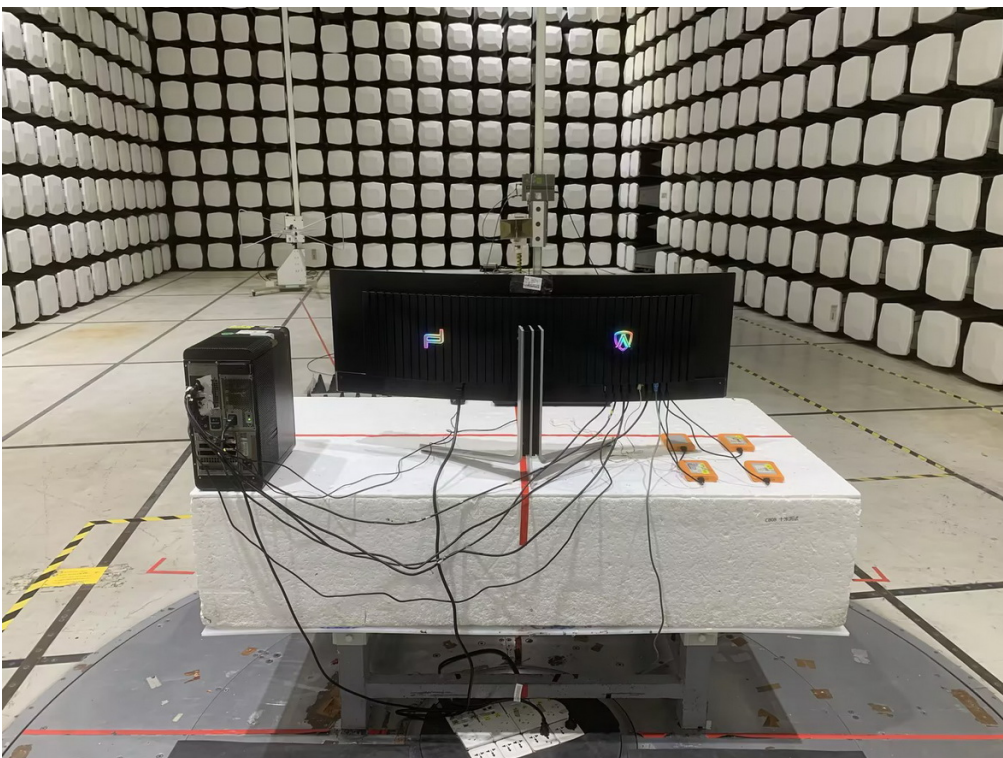
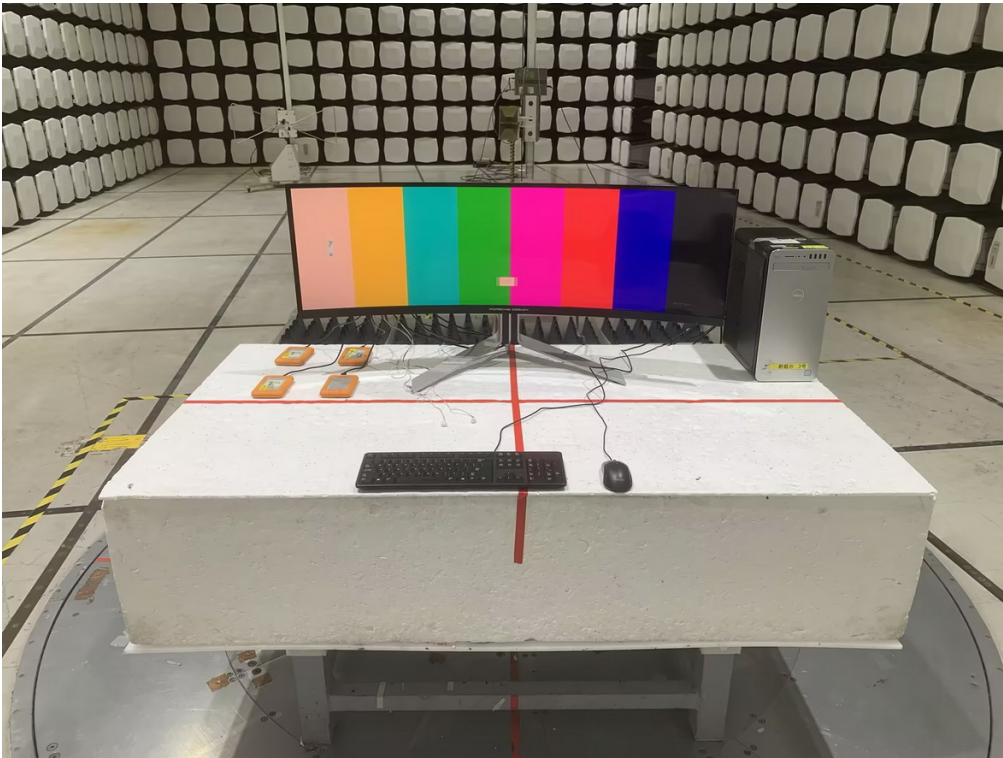

Conducted emissions AC mains power port

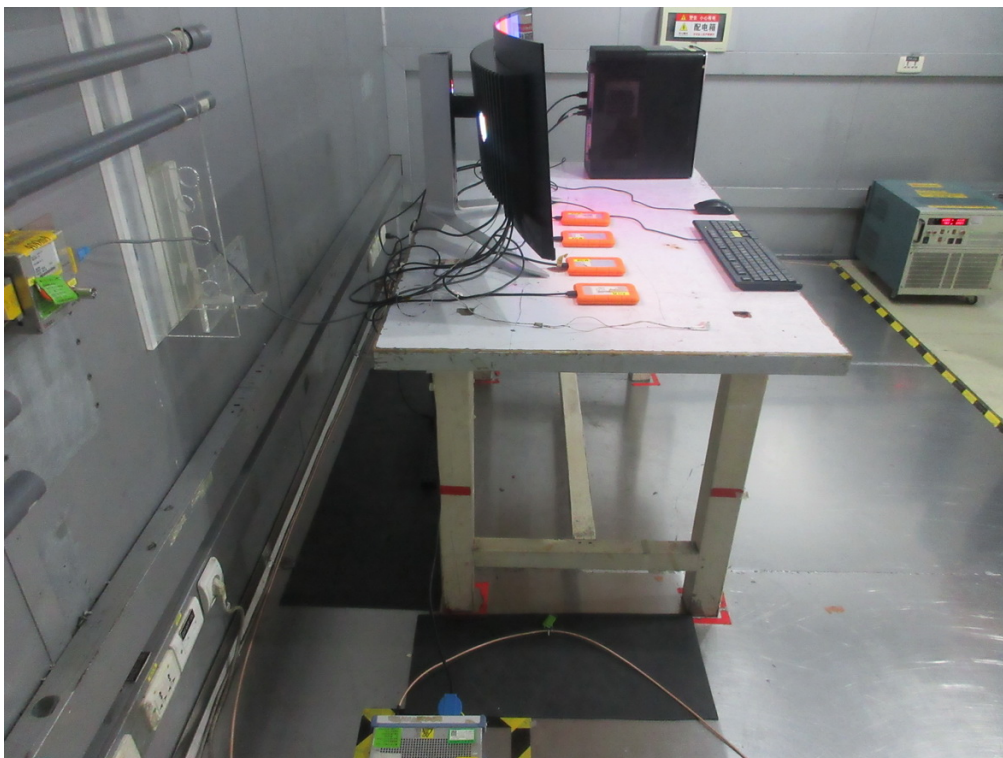

Asymmetric mode conducted emissions(LAN)

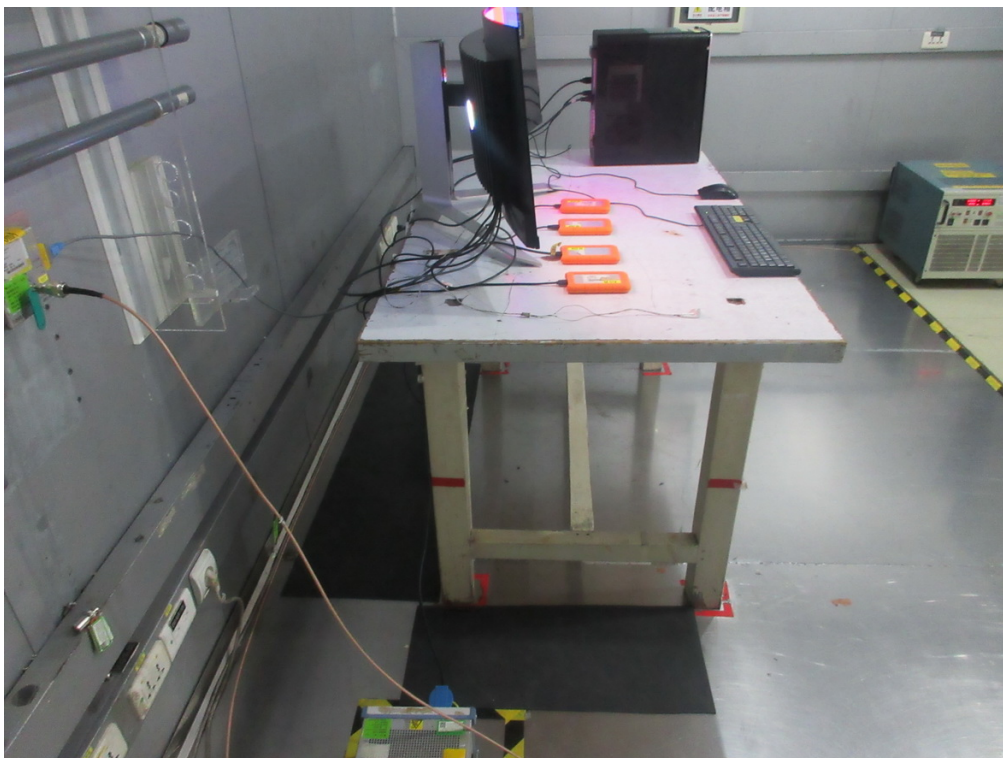

Harmonic current



Voltage fluctuations (Flicker)



Electrostatic discharge immunity



Radiated, radio-frequency, electromagnetic field immunity – Up to 1GHz

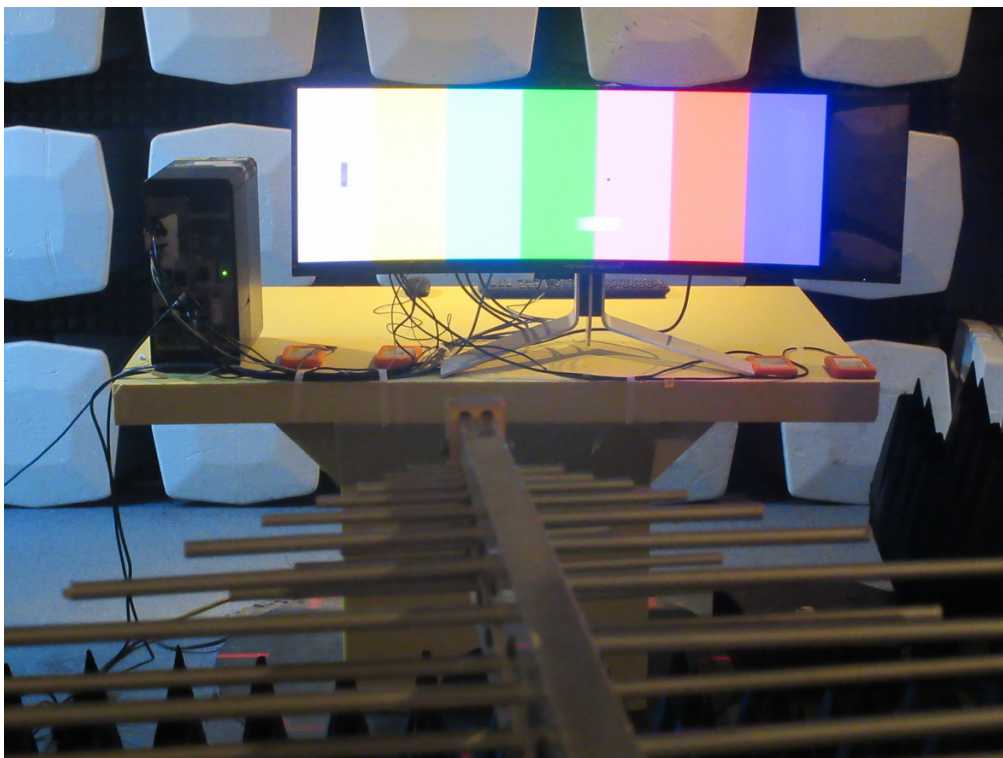

Radiated, radio-frequency, electromagnetic field immunity – Above 1GHz



Electrical fast transient/burst immunity - AC



Electrical fast transient/burst immunity(LAN)

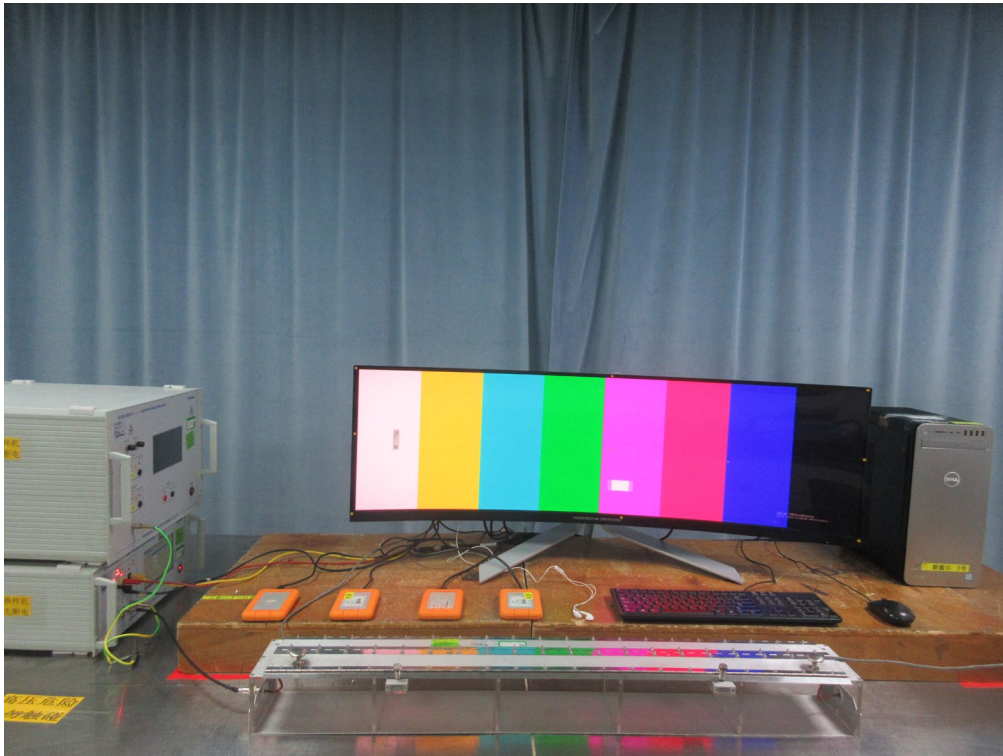

Surge immunity - AC



Immunity to conducted disturbances, induced by radio-frequency fields - AC



Immunity to conducted disturbances, induced by radio-frequency fields(LAN)



Power frequency magnetic field immunity

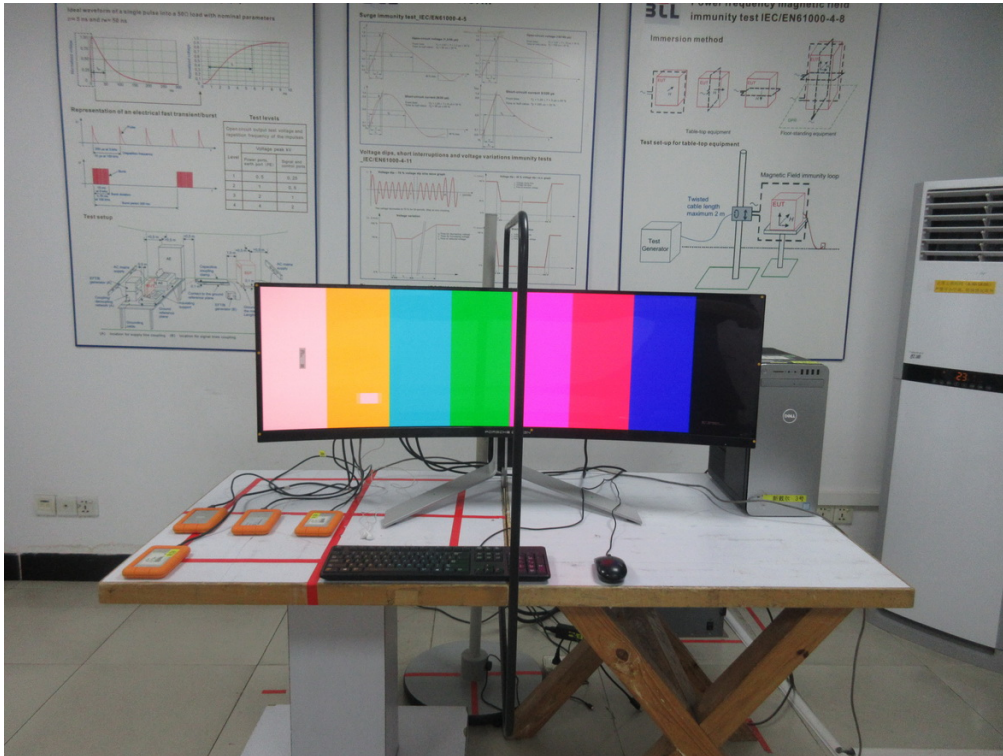

Voltage dips, short interruptions and voltage variations immunity



End of Test Report