

FCC&ISED EMC Test Report

Project No. : 1908C156
Equipment : LCD Monitor
Brand Name : N/A
Test Model : **34G2*****(*=A-Z,a-z,0-9,/, +,-,\ or blank)
Series Model : N/A
Applicant : TPV Electronics (Fujian) Co., Ltd.
Address : Rongqiao Economic and Technological Development Zone, Fuqing City,
Fujian Province, P.R. China
Date of Receipt : Aug. 22, 2019
Date of Test : Aug. 26, 2019 ~ Nov. 22, 2019
Issued Date : Dec. 05, 2019
Report Version : R00
Test Sample : Engineering Sample No.: DG19082261
Standard(s) : FCC Part 15, Subpart B
ICES-003 Issue 6:2016
ICES-003 Issue 6:2016 (updated April 2019)

The above equipment has been tested and found compliance with the requirement of the relative standards by BTL Inc.

Sam. Wang

Prepared by : Sam Wang

Kevin Li

Approved by : Kevin Li



Certificate #5123.02

Add: No.3, Jinshagang 1st Road, Shixia, Dalang Town, Dongguan, Guangdong, China.

Tel: +86-769-8318-3000

Web: www.newbtl.com

Declaration

BTL represents to the client that testing is done in accordance with standard procedures as applicable and that test instruments used has been calibrated with standards traceable to international standard(s) and/or national standard(s).

BTL's reports apply only to the specific samples tested under conditions. It is manufacture's responsibility to ensure that additional production units of this model are manufactured with the identical electrical and mechanical components. **BTL** shall have no liability for any declarations, inferences or generalizations drawn by the client or others from **BTL** issued reports.

The report must not be used by the client to claim product certification, approval, or endorsement by NIST, A2LA, or any agency of the U.S. Government.

This report is the confidential property of the client. As a mutual protection to the clients, the public and ourselves, the test report shall not be reproduced, except in full, without our written approval.

BTL's laboratory quality assurance procedures are in compliance with the **ISO/IEC 17025** requirements, and accredited by the conformity assessment authorities listed in this test report.

BTL is not responsible for the sampling stage, so the results only apply to the sample as received.

The information, data and test plan are provided by manufacturer which may affect the validity of results, so it is manufacturer's responsibility to ensure that the apparatus meets the essential requirements of applied standards and in all the possible configurations as representative of its intended use.

Limitation

For the use of the authority's logo is limited unless the Test Standard(s)/Scope(s)/Item(s) mentioned in this test report is (are) included in the conformity assessment authorities acceptance respective.

Please note that the measurement uncertainty is provided for informational purpose only and are not use in determining the Pass/Fail results.

Table of Contents	Page
REPORT ISSUED HISTORY	4
1 . SUMMARY OF TEST RESULTS	5
1.1 TEST FACILITY	6
1.2 MEASUREMENT UNCERTAINTY	6
1.3 TEST ENVIRONMENT CONDITIONS:	6
2 . GENERAL INFORMATION	7
2.1 GENERAL DESCRIPTION OF EUT	7
2.2 DESCRIPTION OF TEST MODES	8
2.3 EUT OPERATING CONDITIONS	9
2.4 BLOCK DIAGRAM SHOWING THE CONFIGURATION OF SYSTEM TESTED	9
2.5 DESCRIPTION OF SUPPORT UNITS	10
3 . EMC EMISSION TEST	11
3.1 AC POWER LINE CONDUCTED EMISSIONS TEST	11
3.1.2 MEASUREMENT INSTRUMENTS LIST	11
3.1.3 TEST PROCEDURE	12
3.1.4 DEVIATION FROM TEST STANDARD	12
3.1.5 TEST SETUP	12
3.1.6 TEST RESULTS	12
3.2 RADIATED EMISSIONS 30 MHZ TO 1 GHZ	19
3.2.1 LIMIT	19
3.2.2 MEASUREMENT INSTRUMENTS LIST	19
3.2.3 TEST PROCEDURE	20
3.2.4 DEVIATION FROM TEST STANDARD	20
3.2.5 TEST SETUP	20
3.2.6 TEST RESULTS-BELOW 1 GHZ	20
3.3 RADIATED EMISSIONS ABOVE 1 GHZ	27
3.3.1 LIMIT	27
3.3.2 MEASUREMENT INSTRUMENTS LIST	28
3.3.3 TEST PROCEDURE	28
3.3.4 DEVIATION FROM TEST STANDARD	28
3.3.5 TEST SETUP	29
3.3.6 TEST RESULTS-ABOVE 1 GHZ	29
4 . EUT TEST PHOTO	36

REPORT ISSUED HISTORY

Report Version	Description	Issued Date
R00	Original Issue.	Dec. 05, 2019

1. SUMMARY OF TEST RESULTS

Emission		
Ref Standard(s)	Test Item	Result
ANSI C63.4-2014	AC Power Line Conducted Emissions	PASS
	Radiated Emissions 30 MHz to 1 GHz	PASS
	Radiated Emissions Above 1 GHz	PASS

1.1 TEST FACILITY

The test facilities used to collect the test data in this report at the location of No.3, Jinshagang 1st Road, Shixia, Dalang Town, Dongguan, Guangdong, China.

BTL's Test Firm Registration Number for FCC: 357015

BTL's Designation Number for FCC: CN1240

BTL's Test Firm Registration Number for ISED: 4428B

1.2 MEASUREMENT UNCERTAINTY

ISO/IEC 17025 requires that an estimate of the measurement uncertainties associated with the emissions test results be included in the report. The measurement uncertainties given below are based on a 95% confidence level (based on a coverage factor (k=2))

The BTL measurement uncertainty as below table:

A. AC power line conducted emissions test:

Test Site	Method	Measurement Frequency Range	U, (dB)
DG-C02	CISPR	150 kHz~30 MHz	2.60

B. Radiated emissions test:

Test Site	Method	Measurement Frequency Range	Ant. H / V	U, (dB)
DG-CB08 (3m)	CISPR	30MHz ~ 200MHz	V	3.72
		30MHz ~ 200MHz	H	3.02
		200MHz ~ 1,000MHz	V	4.20
		200MHz ~ 1,000MHz	H	3.66

Test Site	Method	Measurement Frequency Range	U,(dB)
DG-CB08 (3m)	CISPR	1GHz ~ 6GHz	4.36

Note: Unless specifically mentioned, the uncertainty of measurement has not been taken into account to declare the compliance or non-compliance to the specification.

1.3 TEST ENVIRONMENT CONDITIONS:

Test Item	Temperature	Humidity	Tested By
AC Power Line Conducted Emissions	25°C	53%	Bang Liang
Radiated emissions 30 MHz to 1 GHz	25°C	60%	Promise Yin
Radiated emissions above 1 GHz	25°C	60%	Promise Yin

2. GENERAL INFORMATION

2.1 GENERAL DESCRIPTION OF EUT

Equipment	LCD Monitor
Brand Name	N/A
Test Model	**34G2*****(*=A-Z,a-z,0-9,/, +,-,\ or blank)
Series Model	N/A
Model Difference(s)	Only differ in model name due to marketing purpose.
Power Source	AC Mains.
Power Rating	100-240V~ 50-60Hz
Connecting I/O Port(s)	5* USB port 2* HDMI port 1* Display port 1* Earphone port 1* AC port
Classification Of EUT	Class B
Highest Internal Frequency(Fx)	600 MHz

Cable Type	Shielded Type	Ferrite Core	Length(m)	Note
HDMI	Shielded	NO	1.8/1.5	/
Display	Shielded	NO	1.8/1.5	/
USB	Shielded	NO	1.8/1.5	/
AC Power Cord	Non-shielded	NO	1.8/1.5	1.8m is worst case Detachable (3 Pin)

Note:

1. For a more detailed features description, please refer to the manufacturer's specifications or the user's manual.
2. Power cable 1.8m, 1.5m length, worst case is Power cable 1.8m with HDMI+Display+USB 1.8m length testing and recording in test report.

2.2 DESCRIPTION OF TEST MODES

To investigate the maximum EMI emission characteristics generated from EUT, the test system was pre-scanning tested based on the consideration of following EUT operation mode or test configuration mode which possibly have effect on EMI emission level. Each of these EUT operation mode(s) or test configuration mode(s) mentioned above was evaluated respectively.

Pretest Mode	Description
Mode 1	HDMI1 3440*1440/100Hz
Mode 2	HDMI2 3440*1440/100Hz
Mode 3	HDMI1 2160P
Mode 4	HDMI2 2160P
Mode 5	DP 3440*1440/144Hz
Mode 6	HDMI1 1280*1024/75Hz
Mode 7	HDMI1 640*480/75Hz

AC Power Line Conducted Emissions test	
Final Test Mode	Description
Mode 1	HDMI1 3440*1440/100Hz
Mode 3	HDMI1 2160P
Mode 5	DP 3440*1440/144Hz

Radiated emissions 30 MHz to 1 GHz test	
Final Test Mode	Description
Mode 1	HDMI1 3440*1440/100Hz
Mode 3	HDMI1 2160P
Mode 5	DP 3440*1440/144Hz

Radiated emissions Above 1 GHz test	
Final Test Mode	Description
Mode 1	HDMI1 3440*1440/100Hz
Mode 3	HDMI1 2160P
Mode 5	DP 3440*1440/144Hz

Evaluation description:

1. The maximum resolution is evaluated Mode 1-5. The worst case is Mode 1 and evaluated the middle and low resolution Mode 6 and Mode 7.
2. According to the client's requirement, choose Mode 1, Mode 3, Mode 5 and recorded in test report.

2.3 EUT OPERATING CONDITIONS

The EUT exercise program used during radiated and/or conducted emission measurement was designed to exercise the various system components in a manner similar to a typical use. The standard test signals and output signal as following:

1. EUT connected to PC via HDMI & Display & USB cable.
2. PC connected to Mouse and Keyboard via USB cable.
3. EUT connected to Earphone via Earphone cable.
4. EUT connected to HDD via USB cable.
5. PC connected to Printer via Parallel cable.
6. PC connected to Modem via RS232 cable.

2.4 BLOCK DIAGRAM SHOWING THE CONFIGURATION OF SYSTEM TESTED

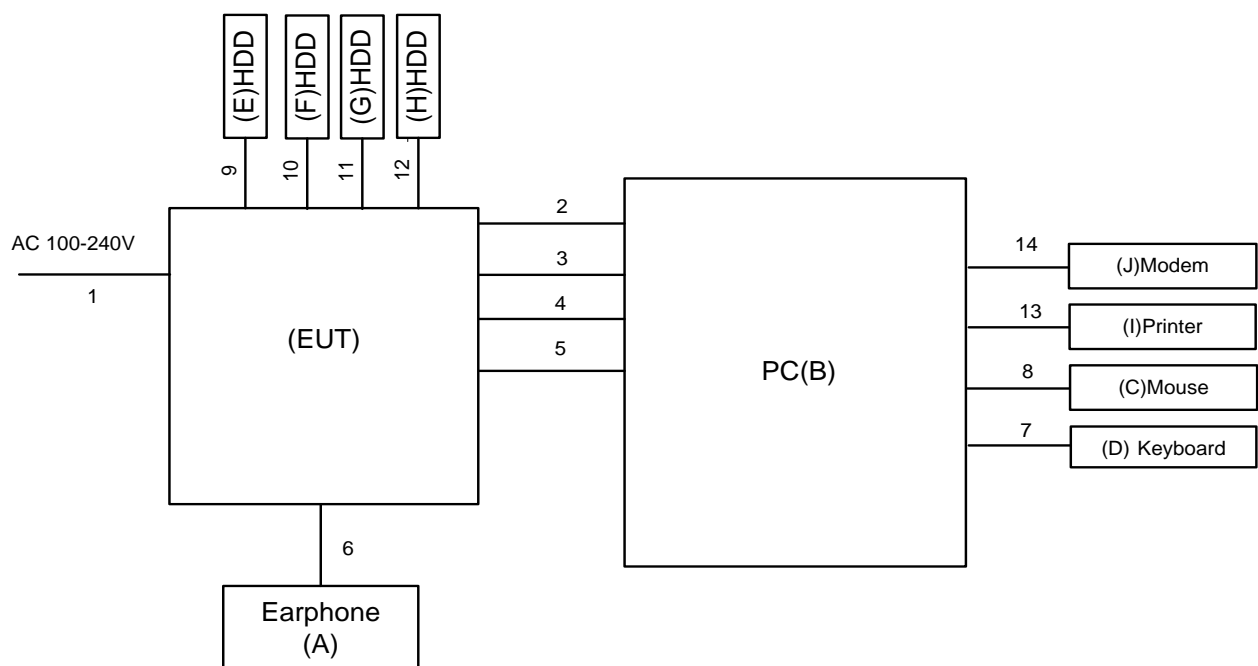

2.5 DESCRIPTION OF SUPPORT UNITS

The EUT has been tested as an independent unit together with other necessary accessories or support units. The following support units or accessories were used to form a representative test configuration during the tests.

Item	Equipment	Mfr/Brand	Model/Type No.	Series No.
A	Earphone	Apple	N/A	N/A
B	PC	DELL	Vostro 470	28747261333
C	Mouse	DELL	MS111-P	CN011D3V71581279OLOT
D	Keyboard	DELL	KB212-B	CN0HTXH97158125004DXA01
E	HDD	WD	WDBLUZ5000ASL	WJ1E74X7D92
F	HDD	WD	WDBLUZ5000ASL	WX51AB3N8785
G	HDD	WD	WDBLUZ5000ASL	WXX1E7405LYS
H	HDD	WD	WDBBLW5000AAL	WXM1A81M8113
I	Printer	SII	DPU-414	3018507 B
J	Modem	ACEEX	DM-1414V	0603002131

Item	Cable Type	Shielded Type	Ferrite Core	Length
1	AC Cable	NO	NO	1.8m/1.5m
2	HDMI Cable	YES	NO	1.8m/1.5m
3	HDMI Cable	YES	NO	1.8m/1.5m
4	DP Cable	YES	NO	1.8m/1.5m
5	USB Cable	YES	NO	1.8m/1.5m
6	Earphone Cable	NO	NO	1.2m
7	USB Cable	YES	NO	1.8m
8	USB Cable	YES	NO	1.8m
9	USB Cable	YES	NO	1.0m
10	USB Cable	YES	NO	1.0m
11	USB Cable	YES	NO	1.0m
12	USB Cable	YES	NO	1.0m
13	Parallel Cable	YES	NO	1.8m
14	RS232 Cable	YES	NO	1.8m

3. EMC EMISSION TEST

3.1 AC POWER LINE CONDUCTED EMISSIONS TEST

3.1.1 LIMIT

Frequency of Emission (MHz)	Class B (dBuV)	
	Quasi-peak	Average
0.15 - 0.5	66 - 56 *	56 - 46 *
0.5 - 5.0	56.00	46.00
5.0 - 30.0	60.00	50.00

Note:

- (1) The tighter limit applies at the band edges.
- (2) The limit of " * " marked band means the limitation decreases linearly with the logarithm of the frequency in the range.
- (3) The test result calculated as following:
 Measurement Value = Reading Level + Correct Factor
 Correct Factor = Insertion Loss + Cable Loss + Attenuator Factor(if use)
 Margin Level = Measurement Value - Limit Value

3.1.2 MEASUREMENT INSTRUMENTS LIST

Item	Kind of Equipment	Manufacturer	Type No.	Serial No.	Calibrated until
1	EMI Test Receiver	R&S	ESCI	100382	Mar. 10, 2020
2	LISN	EMCO	3816/2	52765	Mar. 10, 2020
3	TWO-LINE V-NETWORK	R&S	ENV216	101447	May. 19, 2020
4	50Ω Terminator	SHX	TF5-3	15041305	Mar. 10, 2020
5	Measurement Software	Farad	EZ-EMC Ver.NB-03A1- 01	N/A	N/A
6	Cable	N/A	RG223	12m	Mar. 12, 2020

Remark: "N/A" denotes no model name, serial no. or calibration specified.

All calibration period of equipment list is one year.

3.1.3 TEST PROCEDURE

- a. The EUT was placed 0.8 meters from the horizontal ground plane with EUT being connected to the power mains through a line impedance stabilization network (LISN). All other support equipment powered from additional LISN(s). The LISN provide 50 Ohm/ 50uH of coupling impedance for the measuring instrument.
- b. Interconnecting cables that hang closer than 40 cm to the ground plane shall be folded back and forth in the center forming a bundle 30 to 40 cm long.
- c. I/O cables that are not connected to a peripheral shall be bundled in the center. The end of the cable may be terminated, if required, using the correct terminating impedance. The overall length shall not exceed 1 m.
- d. LISN at least 80 cm from nearest part of EUT chassis.
- e. For the actual test configuration, please refer to the related Item –EUT Test Photos.
- f. Measuring frequency range from 150KHz to 30MHz.

3.1.4 DEVIATION FROM TEST STANDARD

No deviation

3.1.5 TEST SETUP

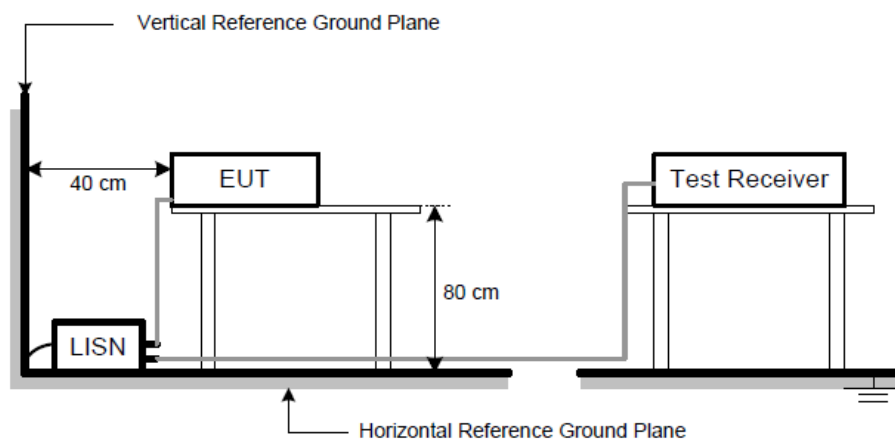

3.1.6 TEST RESULTS

Remark

- (1) Reading in which marked as QP means measurements by using are Quasi-Peak Mode with Detector BW=9 kHz; SPA setting in RBW=10 kHz, VBW =10 kHz, Swp. Time = 0.3 sec./MHz. Reading in which marked as AV means measurements by using are Average Mode with instrument setting in RBW=10 kHz, VBW=10 kHz, Swp. Time =0.3 sec./MHz.
- (2) All readings are QP Mode value unless otherwise stated AVG in column of 『Note』 . If the QP Mode Measured value compliance with the QP Limits and lower than AVG Limits, the EUT shall be deemed to meet both QP & AVG Limits and then only QP Mode was measured, but AVG Mode didn't perform. In this case, a “ * ” marked in AVG Mode column of Interference Voltage Measured.

Test Voltage	AC 120V/60Hz	Phase	Line
Test Mode	HDMI1 3440*1440/100Hz		

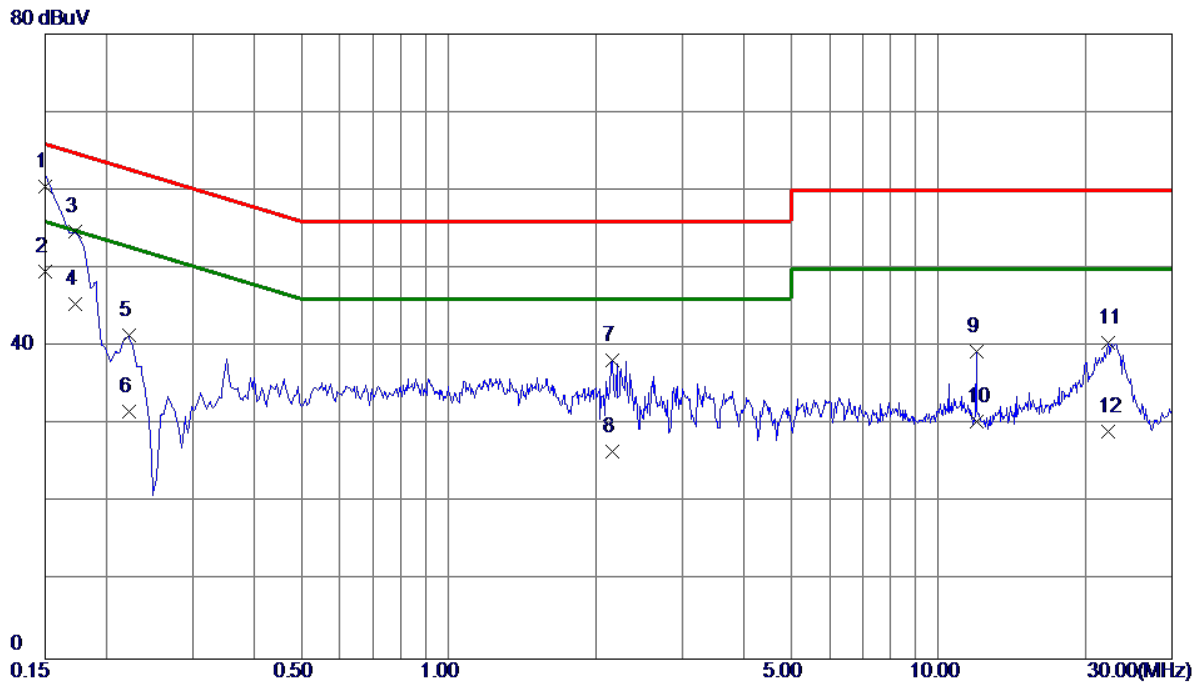

No.	Freq. MHz	Reading Level dBuV	Correct Factor dB	Measure ment dBuV	Limit dBuV	Margin dB	Detector
1 *	0.1500	50.60	9.82	60.42	66.00	-5.58	QP
2	0.1500	39.70	9.82	49.52	56.00	-6.48	AVG
3	0.1725	44.83	9.82	54.65	64.84	-10.19	QP
4	0.1725	35.60	9.82	45.42	54.84	-9.42	AVG
5	0.2220	31.65	9.82	41.47	62.74	-21.27	QP
6	0.2220	21.90	9.82	31.72	52.74	-21.02	AVG
7	2.1570	28.28	10.01	38.29	56.00	-17.71	QP
8	2.1570	16.54	10.01	26.55	46.00	-19.45	AVG
9	11.9895	28.82	10.60	39.42	60.00	-20.58	QP
10	11.9895	19.80	10.60	30.40	50.00	-19.60	AVG
11	22.1640	29.34	11.16	40.50	60.00	-19.50	QP
12	22.1640	18.03	11.16	29.19	50.00	-20.81	AVG

Test Voltage	AC 120V/60Hz	Phase	Neutral
Test Mode	HDMI1 3440*1440/100Hz		

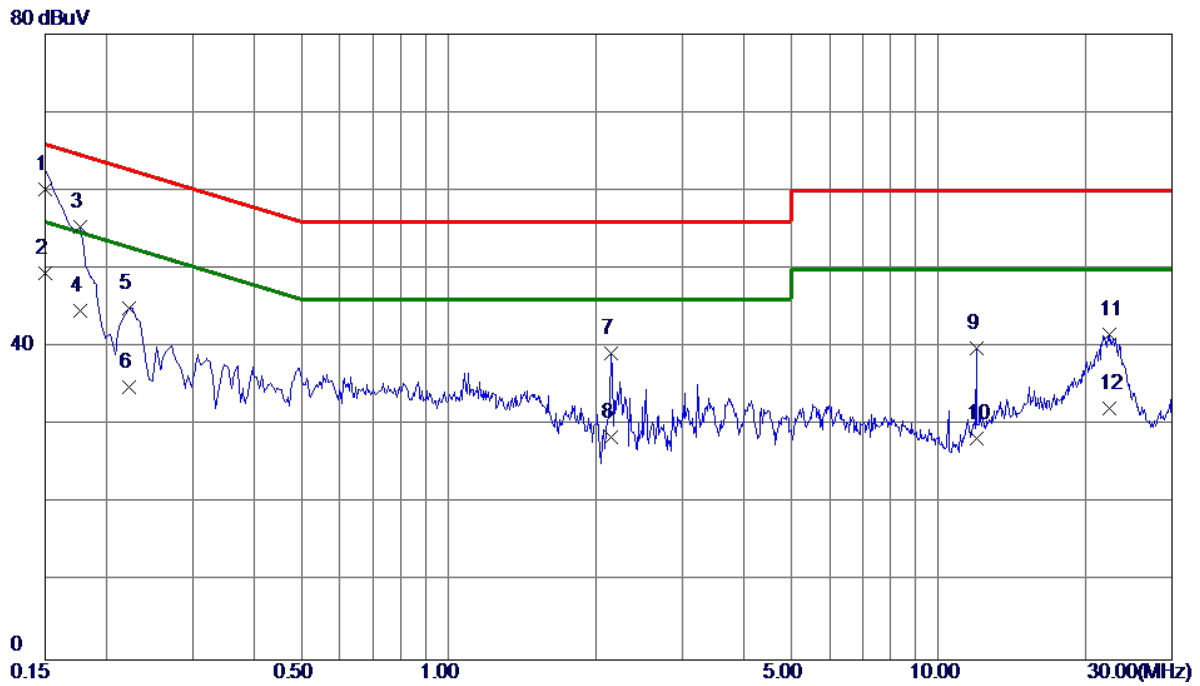

No.	Freq. MHz	Reading Level dBuV	Correct Factor dB	Measure ment dBuV	Limit dBuV	Margin dB	Detector
1 *	0.1500	50.30	9.91	60.21	66.00	-5.79	QP
2	0.1500	39.60	9.91	49.51	56.00	-6.49	AVG
3	0.1770	45.41	9.91	55.32	64.63	-9.31	QP
4	0.1770	34.70	9.91	44.61	54.63	-10.02	AVG
5	0.2220	35.08	9.91	44.99	62.74	-17.75	QP
6	0.2220	24.90	9.91	34.81	52.74	-17.93	AVG
7	2.1525	29.06	10.20	39.26	56.00	-16.74	QP
8	2.1525	18.30	10.20	28.50	46.00	-17.50	AVG
9	11.9895	28.94	10.88	39.82	60.00	-20.18	QP
10	11.9895	17.49	10.88	28.37	50.00	-21.63	AVG
11	22.2990	30.11	11.48	41.59	60.00	-18.41	QP
12	22.2990	20.62	11.48	32.10	50.00	-17.90	AVG

Test Voltage	AC 120V/60Hz	Phase	Line
Test Mode	HDMI1 2160P		

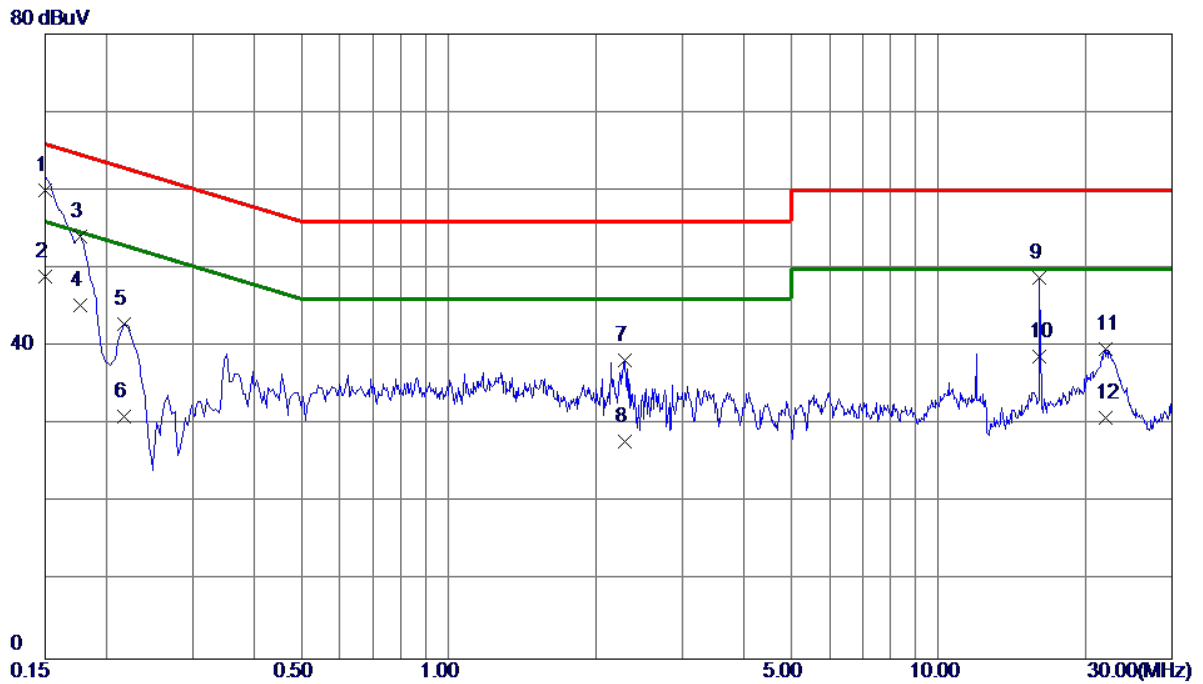

No.	Freq. MHz	Reading Level dBuV	Correct Factor dB	Measure ment dBuV	Limit dBuV	Margin dB	Detector
1 *	0.1500	50.12	9.82	59.94	66.00	-6.06	QP
2	0.1500	39.20	9.82	49.02	56.00	-6.98	AVG
3	0.1770	44.34	9.82	54.16	64.63	-10.47	QP
4	0.1770	35.40	9.82	45.22	54.63	-9.41	AVG
5	0.2175	33.04	9.82	42.86	62.91	-20.05	QP
6	0.2175	21.29	9.82	31.11	52.91	-21.80	AVG
7	2.2875	28.20	10.01	38.21	56.00	-17.79	QP
8	2.2875	17.90	10.01	27.91	46.00	-18.09	AVG
9	16.0710	37.97	10.84	48.81	60.00	-11.19	QP
10	16.0710	27.84	10.84	38.68	50.00	-11.32	AVG
11	21.9165	28.58	11.17	39.75	60.00	-20.25	QP
12	21.9165	19.70	11.17	30.87	50.00	-19.13	AVG

Test Voltage	AC 120V/60Hz	Phase	Neutral
Test Mode	HDMI1 2160P		

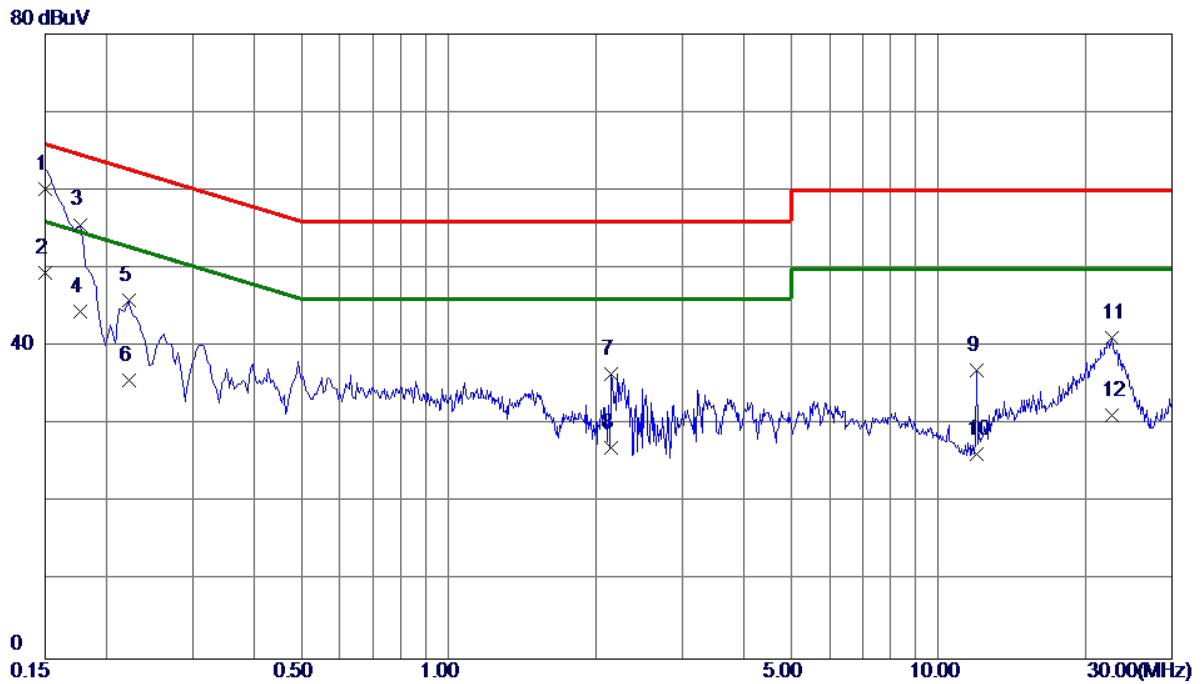

No.	Freq. MHz	Reading Level dBuV	Correct Factor dB	Measure ment dBuV	Limit dBuV	Margin dB	Detector
1 *	0.1500	50.23	9.91	60.14	66.00	-5.86	QP
2	0.1500	39.50	9.91	49.41	56.00	-6.59	AVG
3	0.1770	45.69	9.91	55.60	64.63	-9.03	QP
4	0.1770	34.60	9.91	44.51	54.63	-10.12	AVG
5	0.2220	36.07	9.91	45.98	62.74	-16.76	QP
6	0.2220	25.70	9.91	35.61	52.74	-17.13	AVG
7	2.1525	26.29	10.20	36.49	56.00	-19.51	QP
8	2.1525	16.80	10.20	27.00	46.00	-19.00	AVG
9	11.9895	26.04	10.88	36.92	60.00	-23.08	QP
10	11.9895	15.40	10.88	26.28	50.00	-23.72	AVG
11	22.5600	29.65	11.48	41.13	60.00	-18.87	QP
12	22.5600	19.70	11.48	31.18	50.00	-18.82	AVG

Test Voltage	AC 120V/60Hz	Phase	Line
Test Mode	DP 3440*1440/144Hz		

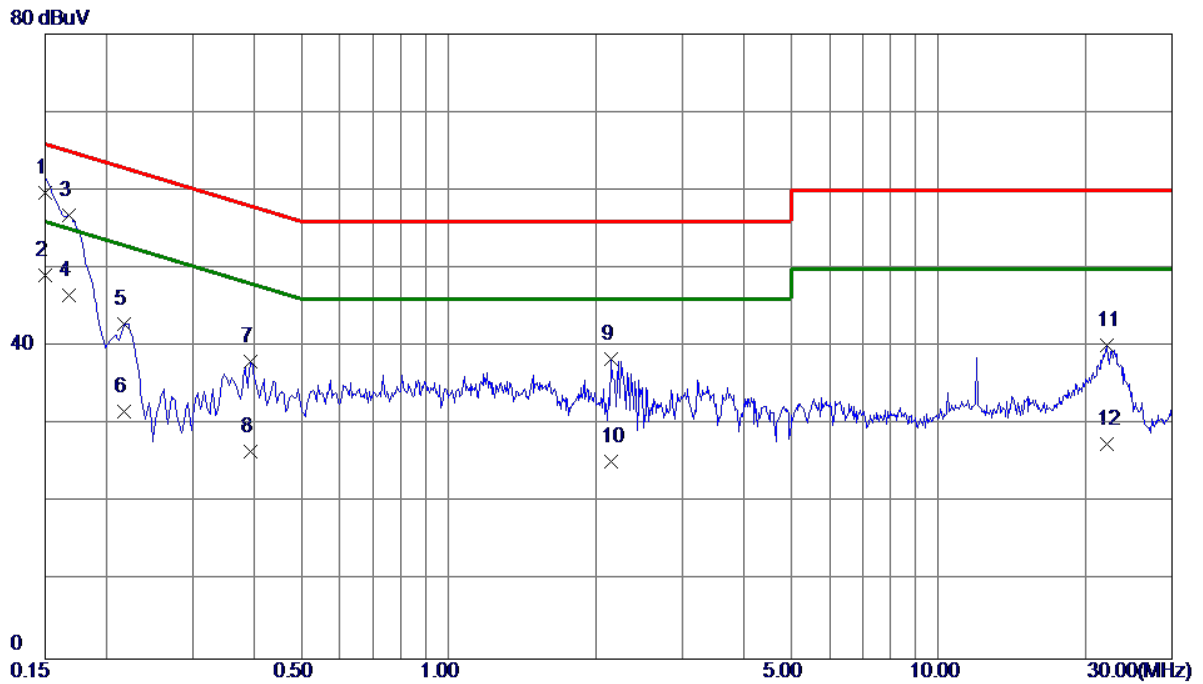

No.	Freq. MHz	Reading Level dBuV	Correct Factor dB	Measure ment dBuV	Limit dBuV	Margin dB	Detector
1 *	0.1500	49.87	9.82	59.69	66.00	-6.31	QP
2	0.1500	39.30	9.82	49.12	56.00	-6.88	AVG
3	0.1680	47.00	9.82	56.82	65.06	-8.24	QP
4	0.1680	36.80	9.82	46.62	55.06	-8.44	AVG
5	0.2175	33.07	9.82	42.89	62.91	-20.02	QP
6	0.2175	21.89	9.82	31.71	52.91	-21.20	AVG
7	0.3930	28.29	9.86	38.15	58.00	-19.85	QP
8	0.3930	16.71	9.86	26.57	48.00	-21.43	AVG
9	2.1435	28.38	10.01	38.39	56.00	-17.61	QP
10	2.1435	15.20	10.01	25.21	46.00	-20.79	AVG
11	22.0244	28.93	11.17	40.10	60.00	-19.90	QP
12	22.0244	16.29	11.17	27.46	50.00	-22.54	AVG

Test Voltage	AC 120V/60Hz	Phase	Neutral
Test Mode	DP 3440*1440/144Hz		

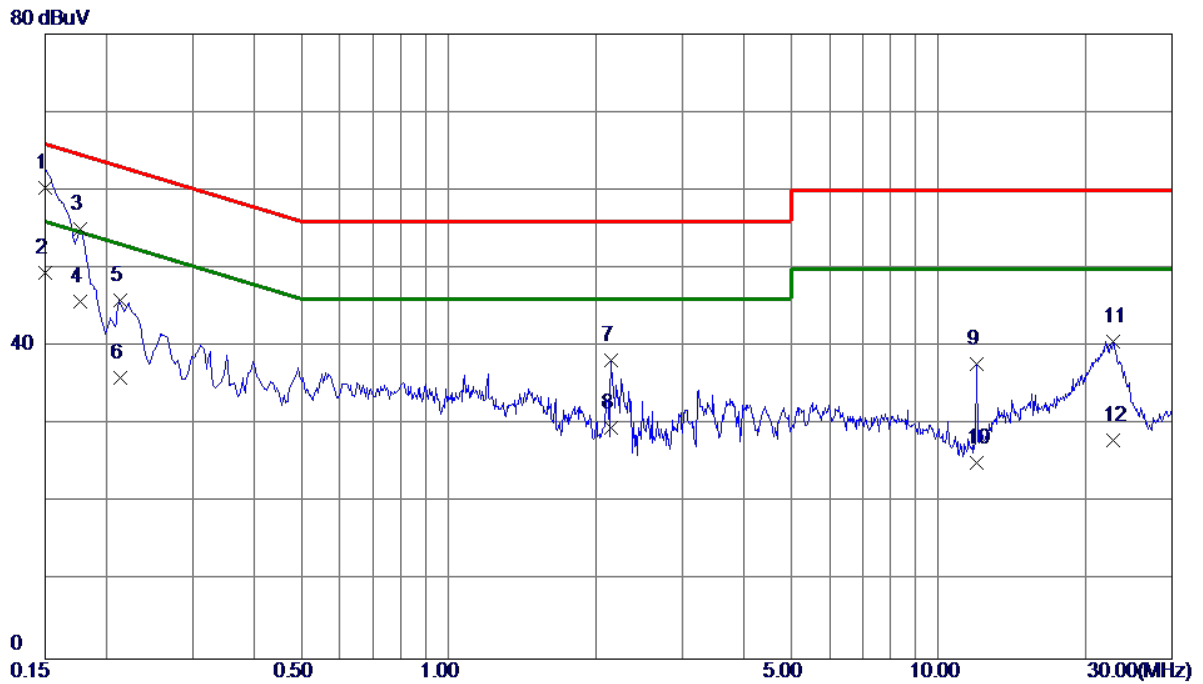

No.	Freq. MHz	Reading Level dBuV	Correct Factor dB	Measure ment dBuV	Limit dBuV	Margin dB	Detector
1 *	0.1500	50.40	9.91	60.31	66.00	-5.69	QP
2	0.1500	39.60	9.91	49.51	56.00	-6.49	AVG
3	0.1770	45.11	9.91	55.02	64.63	-9.61	QP
4	0.1770	35.80	9.91	45.71	54.63	-8.92	AVG
5	0.2130	36.05	9.91	45.96	63.09	-17.13	QP
6	0.2130	26.10	9.91	36.01	53.09	-17.08	AVG
7	2.1480	28.01	10.20	38.21	56.00	-17.79	QP
8	2.1480	19.40	10.20	29.60	46.00	-16.40	AVG
9	11.9895	26.81	10.88	37.69	60.00	-22.31	QP
10	11.9895	14.30	10.88	25.18	50.00	-24.82	AVG
11	22.6904	29.16	11.48	40.64	60.00	-19.36	QP
12	22.6904	16.52	11.48	28.00	50.00	-22.00	AVG

3.2 RADIATED EMISSIONS 30 MHZ TO 1 GHZ

3.2.1 LIMIT

30 MHz to 1 GHz

Frequency (MHz)	Class B (at 3m)	
	(uV/m) Field strength	(dBuV/m) Field strength
30 - 88	100	40
88 - 216	150	43.5
216 - 960	200	46
Above 960	500	54

NOTE:

- (1) The tighter limit applies at the band edges.
- (2) Emission level (dBuV/m) = 20log Emission level (uV/m).
3m Emission level = 10m Emission level + 20log(10m/3m).
- (3) The test result calculated as following:
Measurement Value = Reading Level + Correct Factor
Correct Factor = Antenna Factor + Cable Loss - Amplifier Gain(if use)
Margin Level = Measurement Value - Limit Value

3.2.2 MEASUREMENT INSTRUMENTS LIST

Item	Kind of Equipment	Manufacturer	Type No.	Serial No.	Calibrated until
1	Receiver	Keysight	N9038A	MY54450004	Aug. 03, 2020
2	MXE EMI Receiver	Agilent	N9038A	MY53220133	Mar. 10, 2020
3	Pre-Amplifier	EMC INSTRUMENT	EMC 9135	980284	Mar. 10, 2020
4	Pre-Amplifier	EMC INSTRUMENT	EMC 9135	980283	Mar. 10, 2020
5	Trilog-Broadband Antenna	Schwarzbeck	VULB9168	946	Oct. 26, 2020
6	Trilog-Broadband Antenna	Schwarzbeck	VULB9168	947	Oct. 26, 2020
7	Cable	emci	LMR-400(5m+11m+15m)	N/A	Aug. 06, 2020
8	Cable	emci	LMR-400(5m+8m+8m)	N/A	Aug. 06, 2020
9	Measurement Software	Farad	EZ-EMC Ver.BTL-2ANT-1	N/A	N/A
10	Multi-Device Controller	ETS-Lindgren	2090	N/A	N/A
11	Attenuator	EMCI	EMCI-N-6-06	N0670	Oct. 26, 2020
12	Attenuator	EMCI	EMCI-N-6-06	N0671	Oct. 26, 2020

Remark: "N/A" denotes no model name, no serial no. or no calibration specified.

All calibration period of equipment list is one year.

3.2.3 TEST PROCEDURE

- The measuring distance of 3 m shall be used for measurements. The EUT was placed on the top of a rotating table 0.8 meter above the ground at a 10 meter semi-anechoic chamber. The table was rotated 360 degrees to determine the position of the highest radiation.
- The height of the equipment or of the substitution antenna shall be 0.8 m, the height of the test antenna shall vary between 1 m to 4 m. Both horizontal and vertical polarizations of the antenna are set to make the measurement.
- For each suspected emission, the EUT was arranged to its worst case and then the antenna was tuned to heights find the maximum reading (used Bore sight function).
- The initial step in collecting radiated emission data is a receiver peak detector mode pre-scanning the measurement frequency range. Significant peaks are then marked and then Quasi Peak detector mode re-measured.
- All readings are Peak unless otherwise stated QP in column of Note. Peak denotes that the Peak reading compliance with the QP Limits and then QP Mode measurement didn't perform.
- For the actual test configuration, please refer to the related Item - Block Diagram of system tested.

3.2.4 DEVIATION FROM TEST STANDARD

No deviation

3.2.5 TEST SETUP

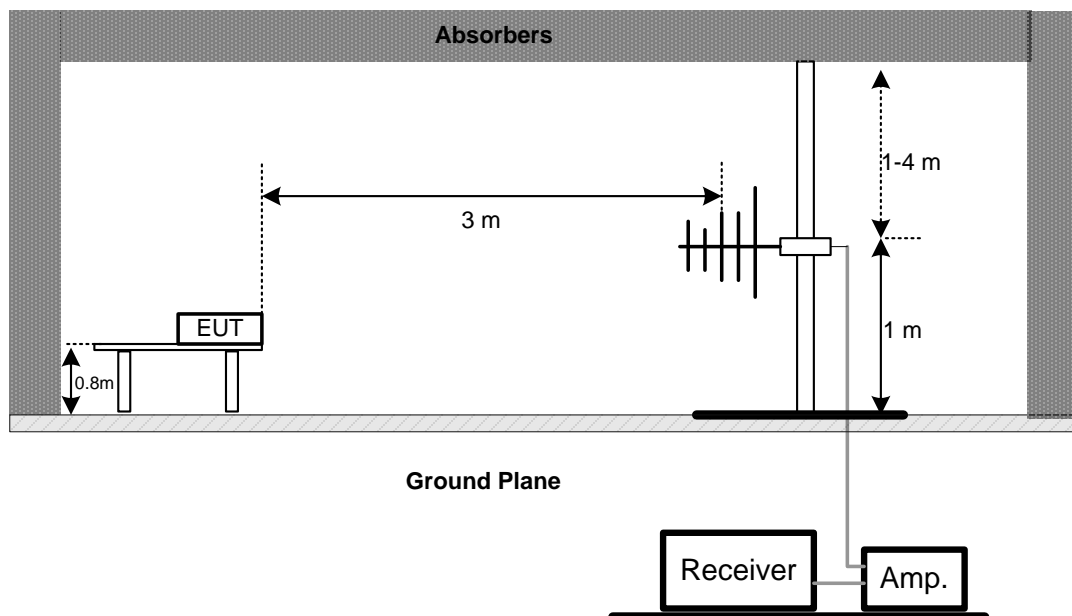

3.2.6 TEST RESULTS-BELOW 1 GHZ

Remark :

- Measuring frequency range from 30 MHz to 1000 MHz
- If the peak scan value lower limit more than 20 dB, then this signal data does not show in table.

Test Voltage	AC 120V/60Hz	Polarization	Vertical
Test Mode	HDMI1 3440*1440/100Hz		

80 dBuV/m

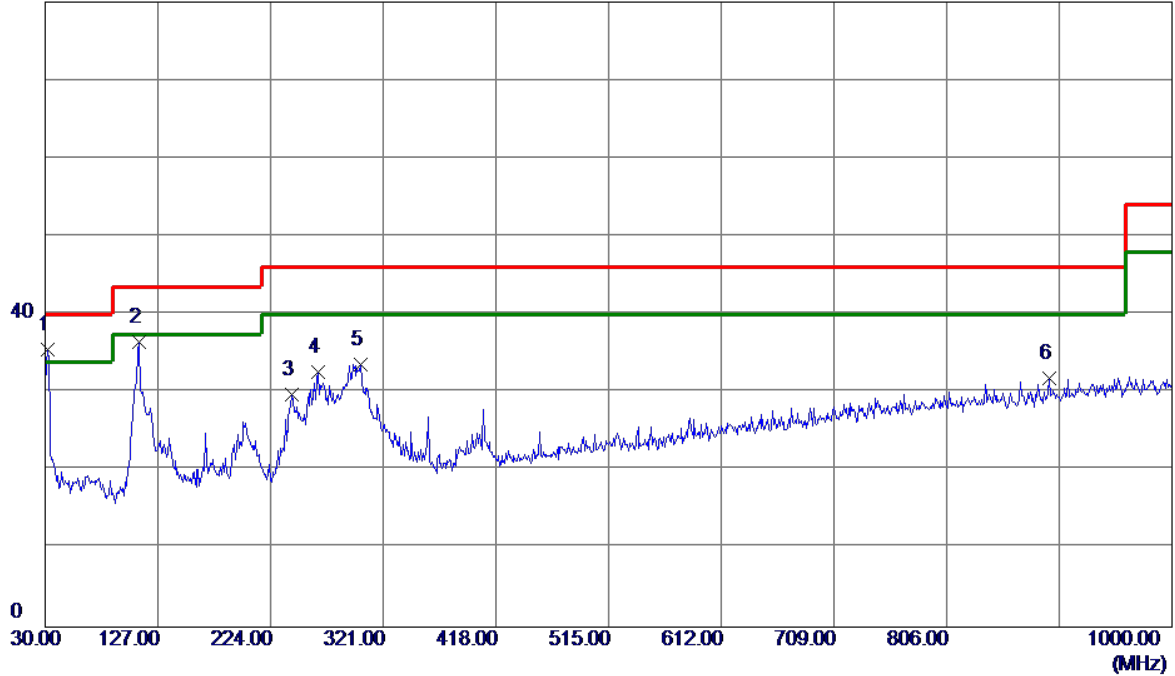

No.	Freq. MHz	Reading Level dBuV/m	Correct Factor dB	Measure ment dBuV/m	Limit dBuV/m	Margin dB	Detector
1 *	31.9400	53.99	-18.45	35.54	40.00	-4.46	QP
2	110.5100	55.88	-19.47	36.41	43.50	-7.09	QP
3	242.4300	47.02	-17.32	29.70	46.00	-16.30	QP
4	264.7400	49.06	-16.47	32.59	46.00	-13.41	QP
5	301.6000	48.64	-15.05	33.59	46.00	-12.41	QP
6	894.2700	36.35	-4.54	31.81	46.00	-14.19	QP

Test Voltage	AC 120V/60Hz	Polarization	Horizontal
Test Mode	HDMI1 3440*1440/100Hz		

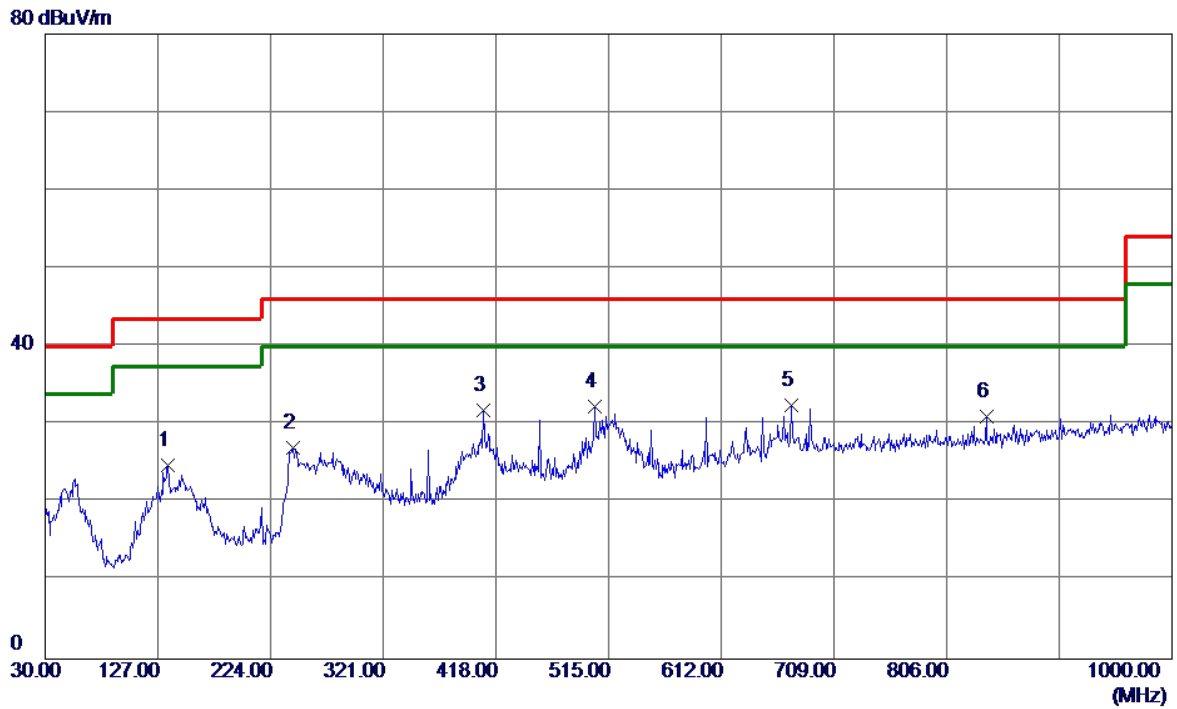

No.	Freq. MHz	Reading Level dBuV/m	Correct Factor dB	Measure ment dBuV/m	Limit dBuV/m	Margin dB	Detector
1	135.7300	41.70	-16.95	24.75	43.50	-18.75	QP
2	243.4000	44.19	-17.17	27.02	46.00	-18.98	QP
3	407.3299	44.44	-12.63	31.81	46.00	-14.19	QP
4	503.3600	42.84	-10.47	32.37	46.00	-13.63	QP
5 *	672.1400	39.99	-7.51	32.48	46.00	-13.52	QP
6	839.9500	36.38	-5.37	31.01	46.00	-14.99	QP

Test Voltage	AC 120V/60Hz	Polarization	Vertical
Test Mode	HDMI1 2160P		

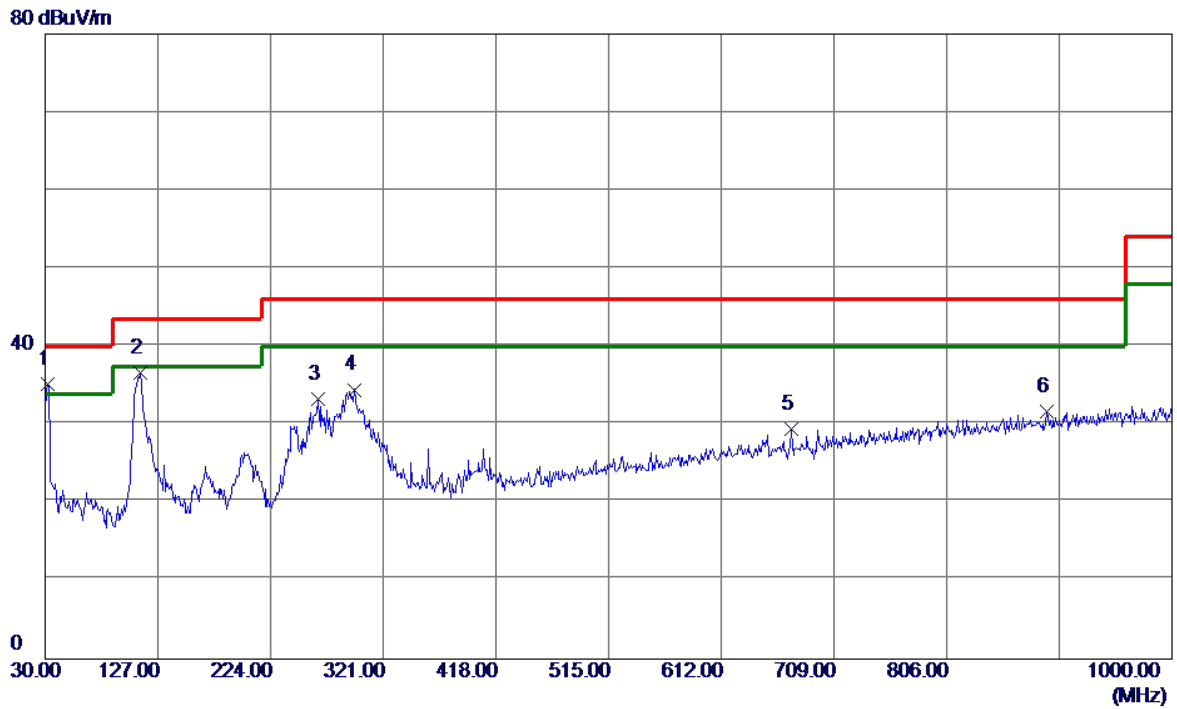

No.	Freq. MHz	Reading Level dBuV/m	Correct Factor dB	Measure ment dBuV/m	Limit dBuV/m	Margin dB	Detector
1 *	31.9400	53.65	-18.45	35.20	40.00	-4.80	QP
2	111.4800	55.96	-19.38	36.58	43.50	-6.92	QP
3	265.2250	49.70	-16.44	33.26	46.00	-12.74	QP
4	295.7800	49.72	-15.24	34.48	46.00	-11.52	QP
5	672.1400	36.93	-7.53	29.40	46.00	-16.60	QP
6	892.3300	36.18	-4.57	31.61	46.00	-14.39	QP

Test Voltage	AC 120V/60Hz	Polarization	Horizontal
Test Mode	HDMI1 2160P		

80 dBuV/m

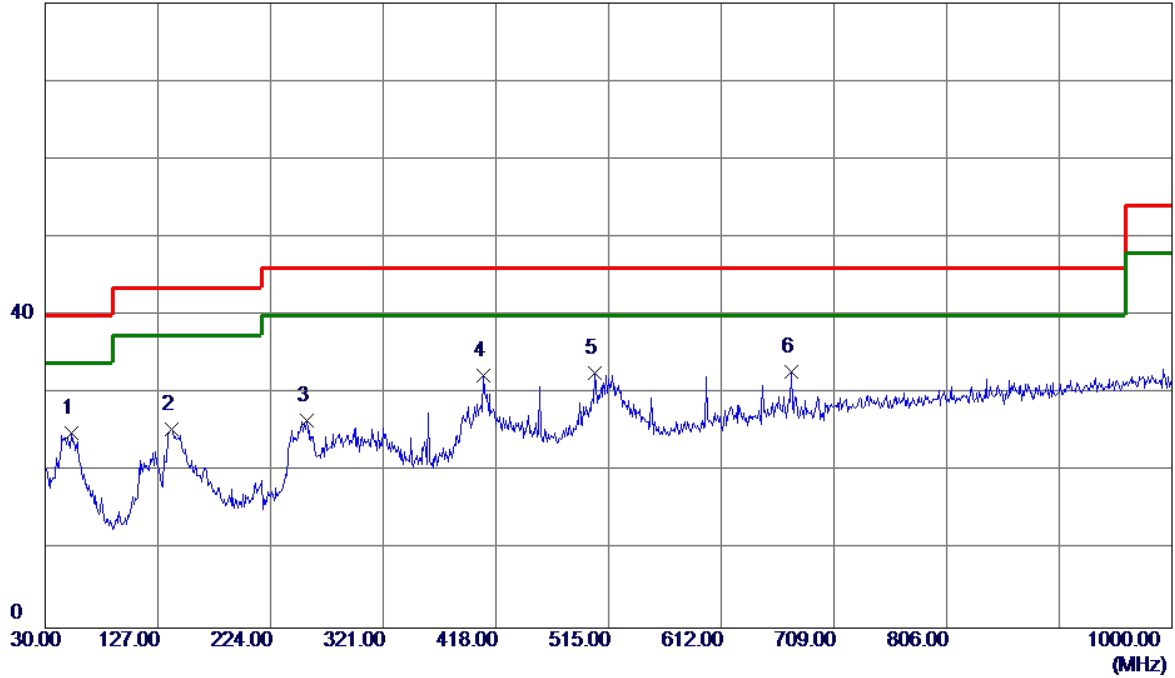

No.	Freq. MHz	Reading Level dBuV/m	Correct Factor dB	Measure ment dBuV/m	Limit dBuV/m	Margin dB	Detector
1	52.3100	41.58	-16.65	24.93	40.00	-15.07	QP
2	138.6400	42.02	-16.59	25.43	43.50	-18.07	QP
3	255.0400	43.38	-16.83	26.55	46.00	-19.45	QP
4	407.3299	44.88	-12.63	32.25	46.00	-13.75	QP
5	503.3600	43.08	-10.47	32.61	46.00	-13.39	QP
6 *	672.1400	40.38	-7.51	32.87	46.00	-13.13	QP

Test Voltage	AC 120V/60Hz	Polarization	Vertical
Test Mode	DP 3440*1440/144Hz		

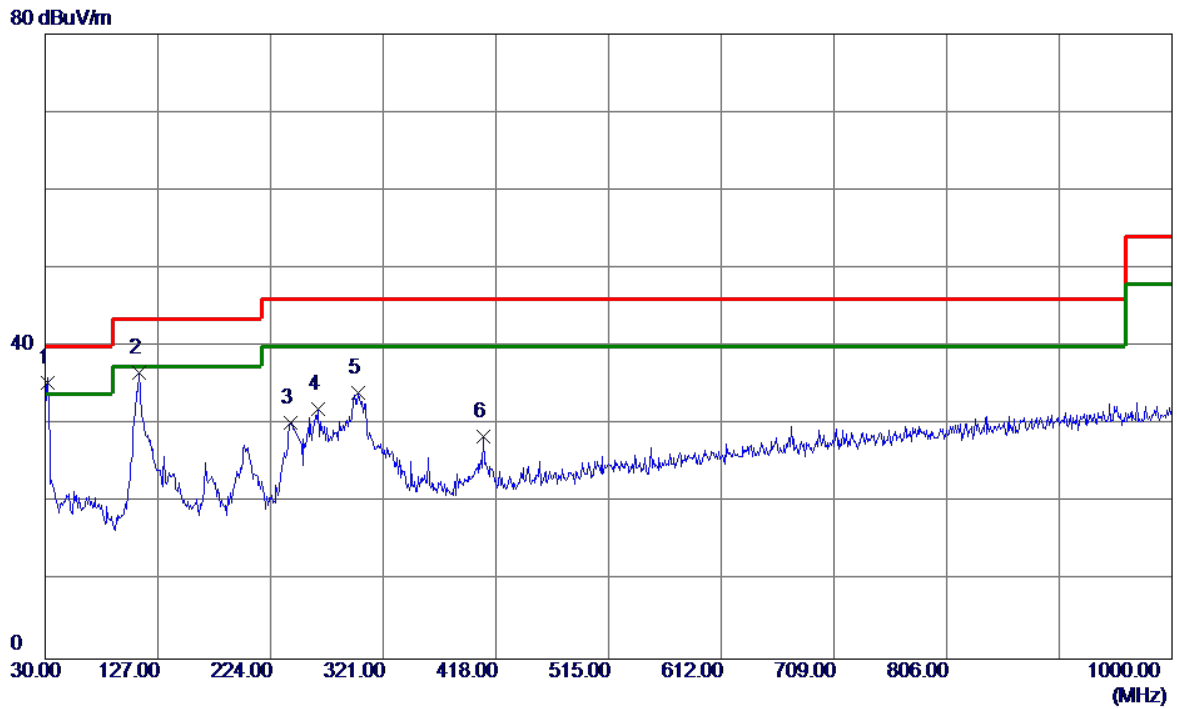

No.	Freq. MHz	Reading Level dBuV/m	Correct Factor dB	Measure ment dBuV/m	Limit dBuV/m	Margin dB	Detector
1 *	31.9400	53.81	-18.45	35.36	40.00	-4.64	QP
2	110.5100	56.06	-19.47	36.59	43.50	-6.91	QP
3	241.4600	47.61	-17.35	30.26	46.00	-15.74	QP
4	264.7400	48.53	-16.47	32.06	46.00	-13.94	QP
5	299.6600	49.22	-15.12	34.10	46.00	-11.90	QP
6	407.3299	41.22	-12.70	28.52	46.00	-17.48	QP

Test Voltage	AC 120V/60Hz	Polarization	Horizontal
Test Mode	DP 3440*1440/144Hz		

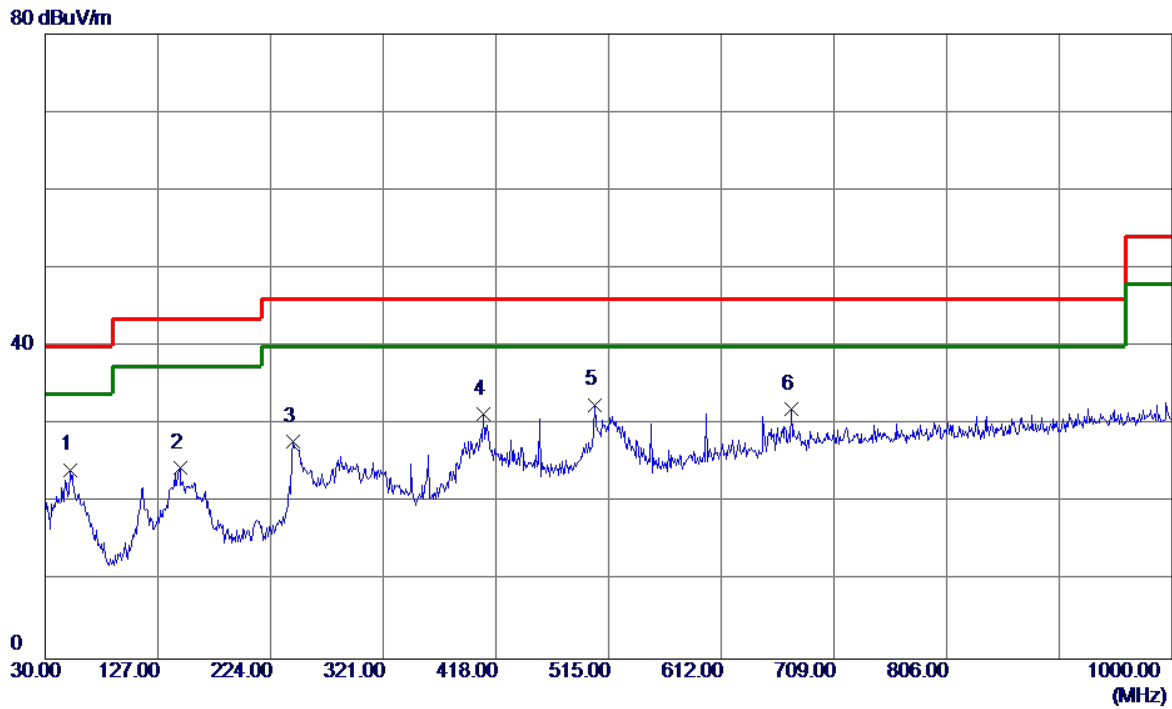

No.	Freq. MHz	Reading Level dBuV/m	Correct Factor dB	Measure ment dBuV/m	Limit dBuV/m	Margin dB	Detector
1	51.3400	40.86	-16.62	24.24	40.00	-15.76	QP
2	145.9149	40.62	-16.11	24.51	43.50	-18.99	QP
3	243.4000	44.99	-17.17	27.82	46.00	-18.18	QP
4	407.3299	44.06	-12.63	31.43	46.00	-14.57	QP
5 *	503.3600	43.03	-10.47	32.56	46.00	-13.44	QP
6	672.1400	39.50	-7.51	31.99	46.00	-14.01	QP

3.3 RADIATED EMISSIONS ABOVE 1 GHZ

3.3.1 LIMIT

Above 1 GHz

Frequency (MHz)	Class B	
	(dBuV/m) (at 3m)	
	Peak	Average
Above 1000	74	54

FREQUENCY RANGE OF RADIATED MEASUREMENT (FOR UNINTENTIONAL RADIATORS)

Highest frequency generated or Upper frequency of measurement used in the device or on which the device operates or tunes (MHz)	Range (MHz)
Below 1.705	30
1.705 - 108	1000
108 - 500	2000
500 - 1000	5000
Above 1000	5 th harmonic of the highest frequency or 40 GHz, whichever is lower

NOTE:

- (1) The tighter limit applies at the band edges.
- (2) Emission level (dBuV/m) = 20log Emission level (uV/m).
3m Emission level = 10m Emission level + 20log(10m/3m).
- (3) The test result calculated as following:
Measurement Value = Reading Level + Correct Factor
Correct Factor = Antenna Factor + Cable Loss - Amplifier Gain(if use)
Margin Level = Measurement Value - Limit Value

3.3.2 MEASUREMENT INSTRUMENTS LIST

Item	Kind of Equipment	Manufacturer	Type No.	Serial No.	Calibrated until
1	Horn Antenna	EMCO	3115	9605-4803	Mar. 23, 2020
2	Amplifier	Agilent	8449B	3008A02584	Aug. 03, 2020
3	MXE EMI Receiver	Agilent	N9038A	MY53220133	Mar. 10, 2020
4	Measurement Software	Farad	EZ-EMC Ver.BTL-2ANT-1	N/A	N/A
5	Multi-Device Controller	ETS-Lindgren	2090	N/A	N/A
6	Controller	MF	MF-7802	MF780208159	N/A
7	Cable	Mlcable Inc.	B10-01-01-5M	18047123	Mar. 01, 2020
8	Cable	Mlcable Inc.	B10-01-01-10M	18072746	Mar. 01, 2020
9	Cable	N/A	A50-3.5M3.5M-1.5M-AT	18041824	Mar. 01, 2020

Remark: "N/A" denotes no model name, no serial no. or no calibration specified.

All calibration period of equipment list is one year.

3.3.3 TEST PROCEDURE

- a. The measuring distance of 3 m shall be used for measurements. The EUT was placed on the top of a rotating table 0.8 meter above the ground at a 10 meter semi-anechoic chamber. The table was rotated 360 degrees to determine the position of the highest radiation.
- b. The height of the equipment or of the substitution antenna shall be 0.8 m, the height of the test antenna shall vary between 1 m to 4 m. Both horizontal and vertical polarizations of the antenna are set to make the measurement.
- c. For each suspected emission, the EUT was arranged to its worst case and then the antenna was tuned to heights find the maximum reading (used Bore sight function).
- d. The initial step in collecting radiated emission data is a receiver peak detector mode pre-scanning the measurement frequency range. Significant peaks are then marked and then Quasi Peak detector mode re-measured.
- e. The receiver system was set to peak and average detect function and specified bandwidth with maximum hold mode when the test frequency is above 1 GHz.
- f. All readings are Peak Mode value unless otherwise stated AVG in column of Note. If the Peak Mode Measured value compliance with the Peak Limits and lower than AVG Limits, the EUT shall be deemed to meet both Peak & AVG Limits and then only Peak Mode was measured, but AVG Mode didn't perform.
- g. For the actual test configuration, please refer to the related Item - Block Diagram of system tested.

3.3.4 DEVIATION FROM TEST STANDARD

No deviation

3.3.5 TEST SETUP

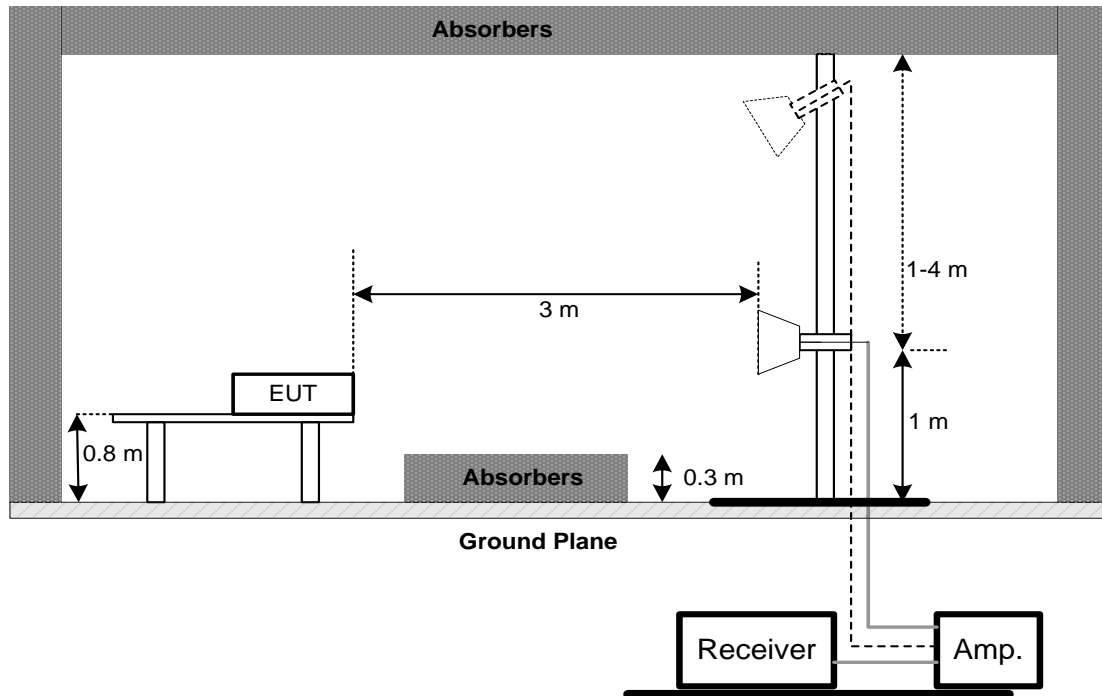

3.3.6 TEST RESULTS-ABOVE 1 GHZ

Remark :

- (1) Radiated emissions measured in frequency range above 1000 MHz were made with an instrument using Peak detector mode and AV detector mode of the emission.
- (2) Data of measurement within this frequency range shown “*” in the table above means the reading of emissions are attenuated more than 20 dB below the permissible limits or the field strength is too small to be measured.
- (3) A preamp and high pass filter were used for this test in order to provide sufficient measurement sensitivity.

Test Voltage	AC 120V/60Hz	Polarization	Vertical
Test Mode	HDMI1 3440*1440/100Hz		

86.9 dBuV/m

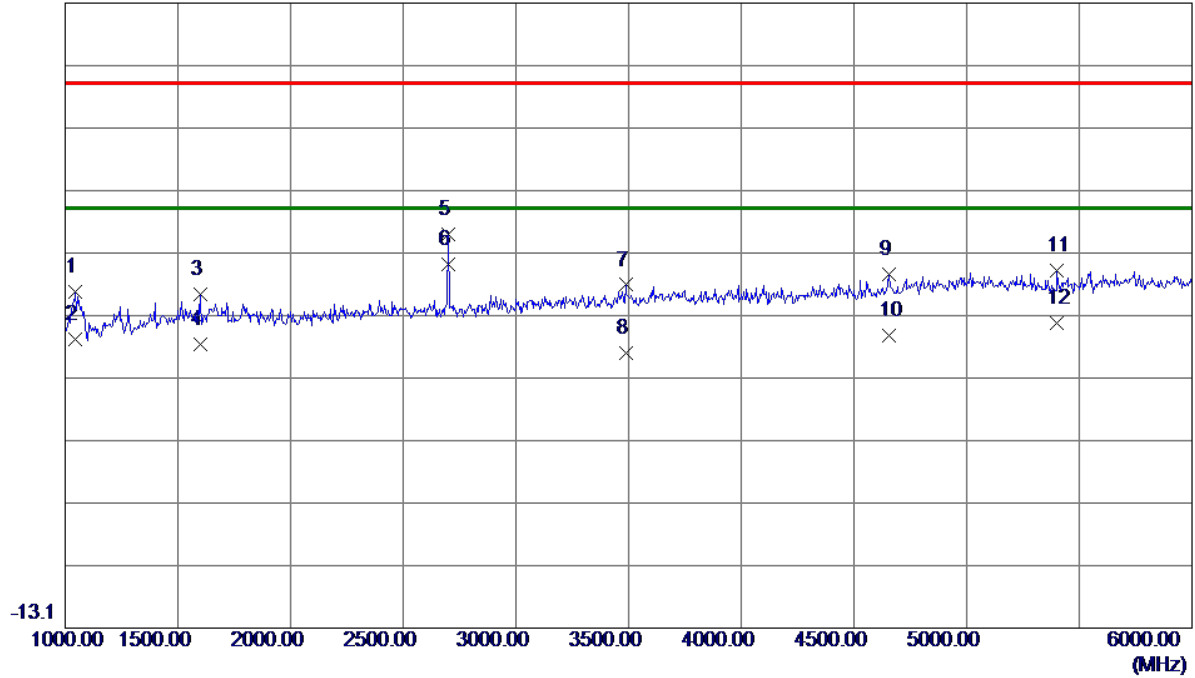

No.	Freq. MHz	Reading Level dBuV/m	Correct Factor dB	Measure ment dBuV/m	Limit dBuV/m	Margin dB	Detector
1	1045.0000	47.47	-6.74	40.73	74.00	-33.27	Peak
2	1045.0000	39.80	-6.74	33.06	54.00	-20.94	AVG
3	1597.5000	43.55	-3.23	40.32	74.00	-33.68	Peak
4	1597.5000	35.52	-3.23	32.29	54.00	-21.71	AVG
5	2700.0000	49.18	0.75	49.93	74.00	-24.07	Peak
6 *	2700.0000	44.35	0.75	45.10	54.00	-8.90	AVG
7	3487.5000	38.57	3.23	41.80	74.00	-32.20	Peak
8	3487.5000	27.75	3.23	30.98	54.00	-23.02	AVG
9	4655.0000	37.25	6.28	43.53	74.00	-30.47	Peak
10	4655.0000	27.46	6.28	33.74	54.00	-20.26	AVG
11	5400.0000	36.11	8.05	44.16	74.00	-29.84	Peak
12	5400.0000	27.60	8.05	35.65	54.00	-18.35	AVG

Test Voltage	AC 120V/60Hz	Polarization	Horizontal
Test Mode	HDMI1 3440*1440/100Hz		

86.9 dBuV/m

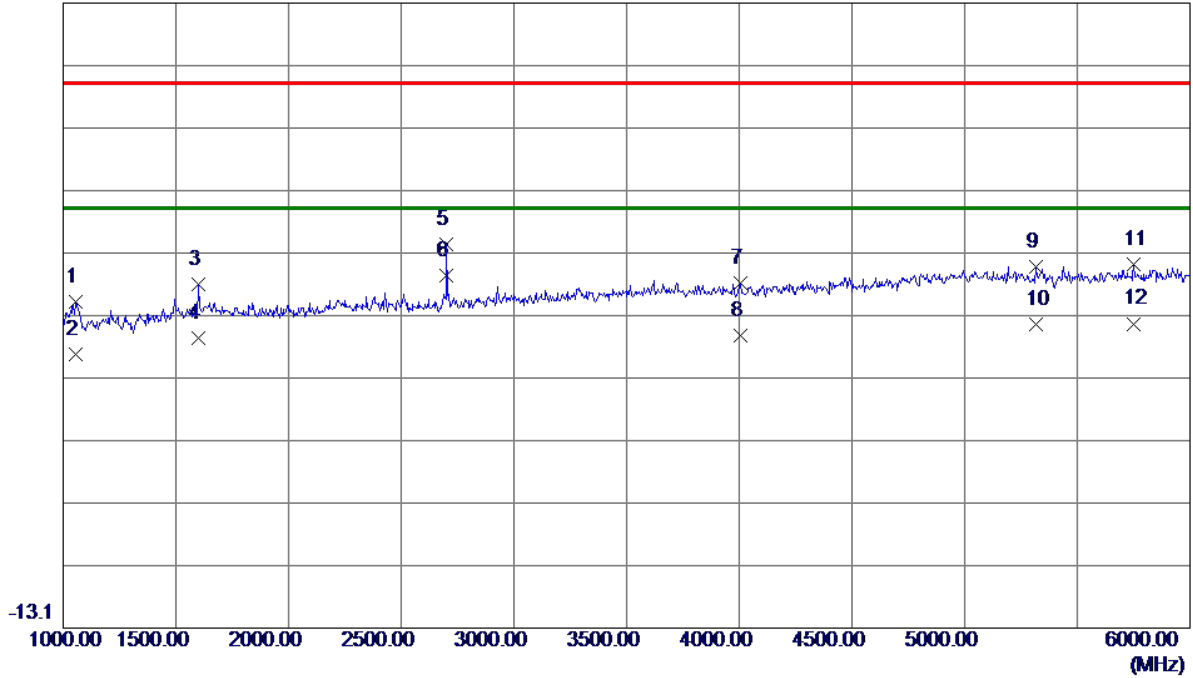

No.	Freq. MHz	Reading Level dBuV/m	Correct Factor dB	Measure ment dBuV/m	Limit dBuV/m	Margin dB	Detector
1	1055.0000	45.73	-6.67	39.06	74.00	-34.94	Peak
2	1055.0000	37.28	-6.67	30.61	54.00	-23.39	AVG
3	1600.0000	45.05	-3.22	41.83	74.00	-32.17	Peak
4	1600.0000	36.61	-3.22	33.39	54.00	-20.61	AVG
5	2700.0000	47.57	0.75	48.32	74.00	-25.68	Peak
6 *	2700.0000	42.48	0.75	43.23	54.00	-10.77	AVG
7	4007.5000	37.38	4.77	42.15	74.00	-31.85	Peak
8	4007.5000	29.01	4.77	33.78	54.00	-20.22	AVG
9	5317.5000	36.82	7.97	44.79	74.00	-29.21	Peak
10	5317.5000	27.57	7.97	35.54	54.00	-18.46	AVG
11	5750.0000	36.46	8.57	45.03	74.00	-28.97	Peak
12	5750.0000	27.03	8.57	35.60	54.00	-18.40	AVG

Test Voltage	AC 120V/60Hz	Polarization	Vertical
Test Mode	HDMI1 2160P		

86.9 dBuV/m

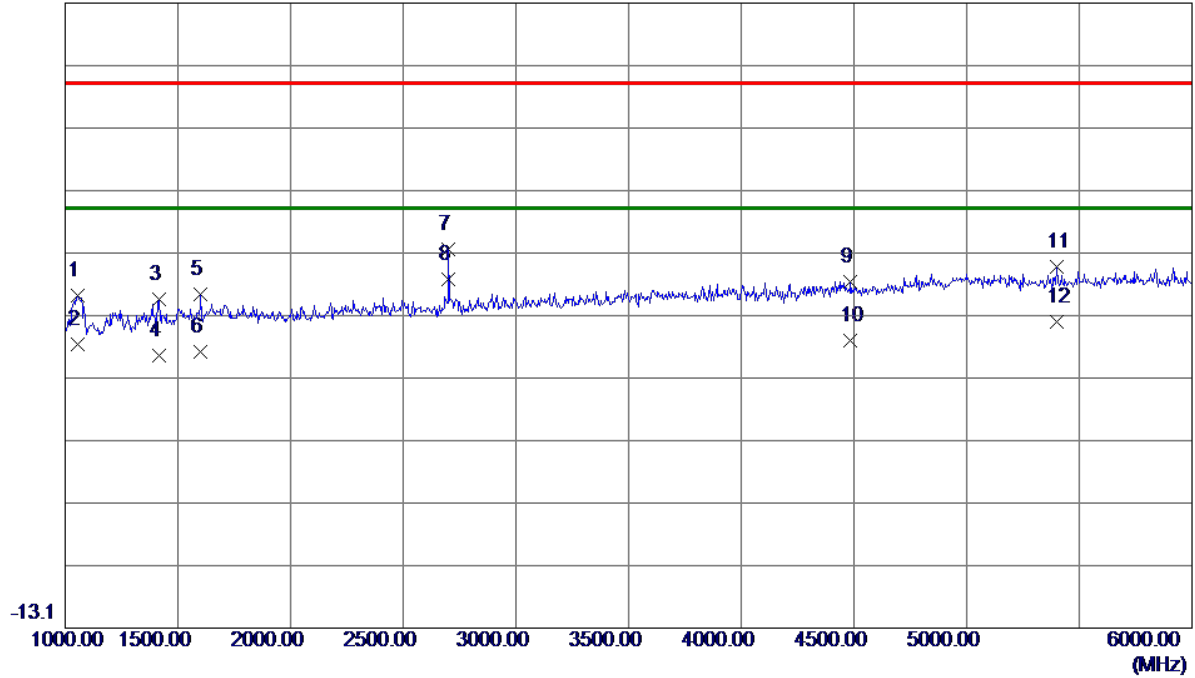

No.	Freq. MHz	Reading Level dBuV/m	Correct Factor dB	Measure ment dBuV/m	Limit dBuV/m	Margin dB	Detector
1	1055.0000	46.74	-6.67	40.07	74.00	-33.93	Peak
2	1055.0000	38.91	-6.67	32.24	54.00	-21.76	AVG
3	1415.0000	43.61	-4.15	39.46	74.00	-34.54	Peak
4	1415.0000	34.74	-4.15	30.59	54.00	-23.41	AVG
5	1600.0000	43.52	-3.22	40.30	74.00	-33.70	Peak
6	1600.0000	34.30	-3.22	31.08	54.00	-22.92	AVG
7	2700.0000	46.84	0.75	47.59	74.00	-26.41	Peak
8 *	2700.0000	41.90	0.75	42.65	54.00	-11.35	AVG
9	4485.0000	36.70	5.63	42.33	74.00	-31.67	Peak
10	4485.0000	27.20	5.63	32.83	54.00	-21.17	AVG
11	5400.0000	36.59	8.05	44.64	74.00	-29.36	Peak
12	5400.0000	27.77	8.05	35.82	54.00	-18.18	AVG

Test Voltage	AC 120V/60Hz	Polarization	Horizontal
Test Mode	HDMI1 2160P		

86.9 dBuV/m

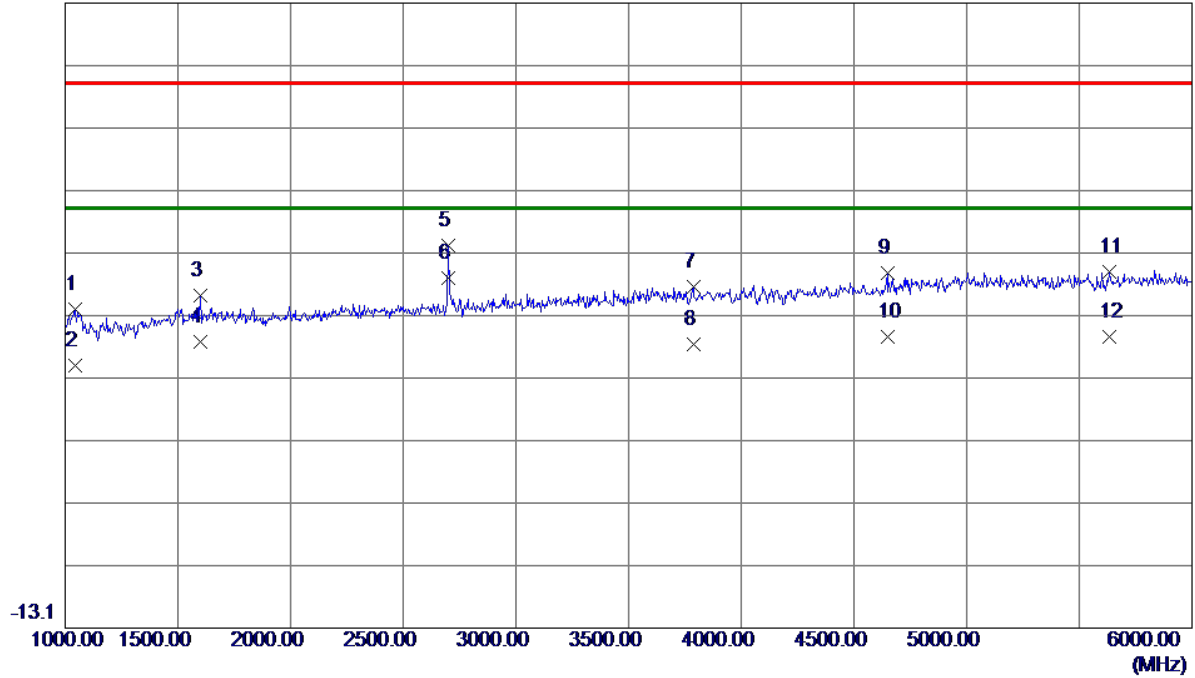

No.	Freq. MHz	Reading Level dBuV/m	Correct Factor dB	Measure ment dBuV/m	Limit dBuV/m	Margin dB	Detector
1	1042.5000	44.65	-6.75	37.90	74.00	-36.10	Peak
2	1042.5000	35.64	-6.75	28.89	54.00	-25.11	AVG
3	1600.0000	43.33	-3.22	40.11	74.00	-33.89	Peak
4	1600.0000	35.83	-3.22	32.61	54.00	-21.39	AVG
5	2700.0000	47.39	0.75	48.14	74.00	-25.86	Peak
6 *	2700.0000	42.16	0.75	42.91	54.00	-11.09	AVG
7	3787.5000	37.39	4.13	41.52	74.00	-32.48	Peak
8	3787.5000	28.15	4.13	32.28	54.00	-21.72	AVG
9	4647.5000	37.43	6.25	43.68	74.00	-30.32	Peak
10	4647.5000	27.18	6.25	33.43	54.00	-20.57	AVG
11	5635.0000	35.52	8.37	43.89	74.00	-30.11	Peak
12	5635.0000	25.16	8.37	33.53	54.00	-20.47	AVG

Test Voltage	AC 120V/60Hz	Polarization	Vertical
Test Mode	DP 3440*1440/144Hz		

86.9 dBuV/m

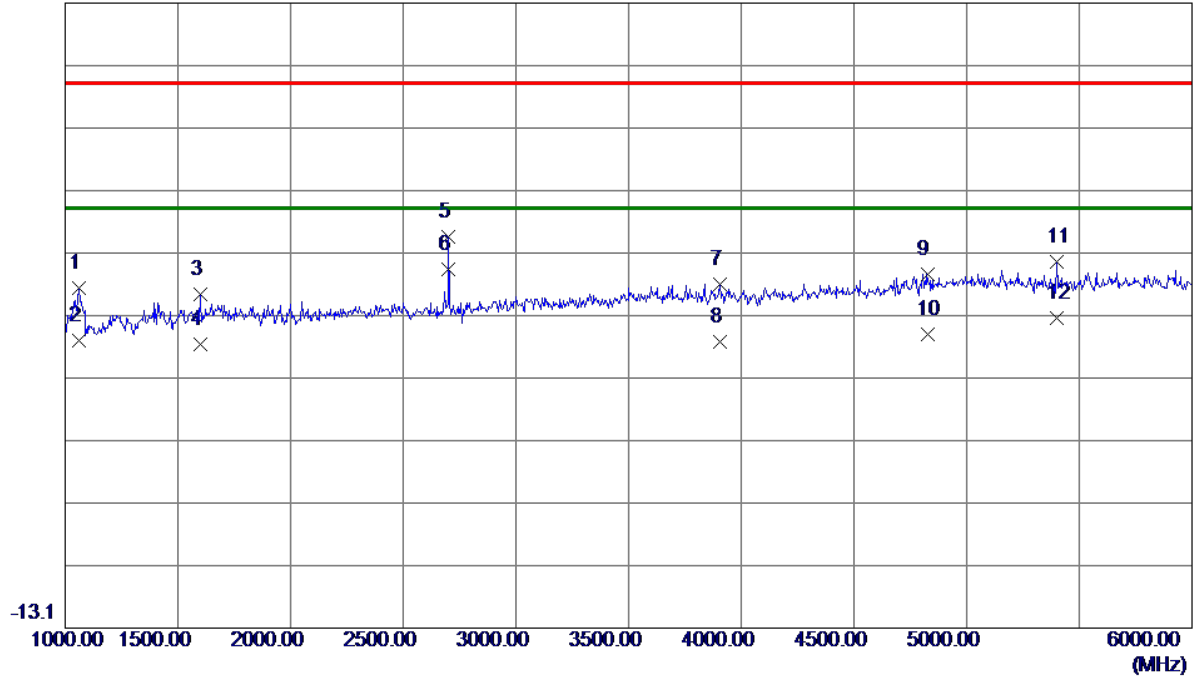

No.	Freq. MHz	Reading Level dBuV/m	Correct Factor dB	Measure ment dBuV/m	Limit dBuV/m	Margin dB	Detector
1	1062.5000	47.87	-6.61	41.26	74.00	-32.74	Peak
2	1062.5000	39.52	-6.61	32.91	54.00	-21.09	AVG
3	1597.5000	43.45	-3.23	40.22	74.00	-33.78	Peak
4	1597.5000	35.47	-3.23	32.24	54.00	-21.76	AVG
5	2700.0000	48.70	0.75	49.45	74.00	-24.55	Peak
6 *	2700.0000	43.56	0.75	44.31	54.00	-9.69	AVG
7	3905.0000	37.50	4.48	41.98	74.00	-32.02	Peak
8	3905.0000	28.24	4.48	32.72	54.00	-21.28	AVG
9	4825.0000	36.55	6.97	43.52	74.00	-30.48	Peak
10	4825.0000	26.89	6.97	33.86	54.00	-20.14	AVG
11	5400.0000	37.49	8.05	45.54	74.00	-28.46	Peak
12	5400.0000	28.51	8.05	36.56	54.00	-17.44	AVG

Test Voltage	AC 120V/60Hz	Polarization	Horizontal
Test Mode	DP 3440*1440/144Hz		

86.9 dBuV/m

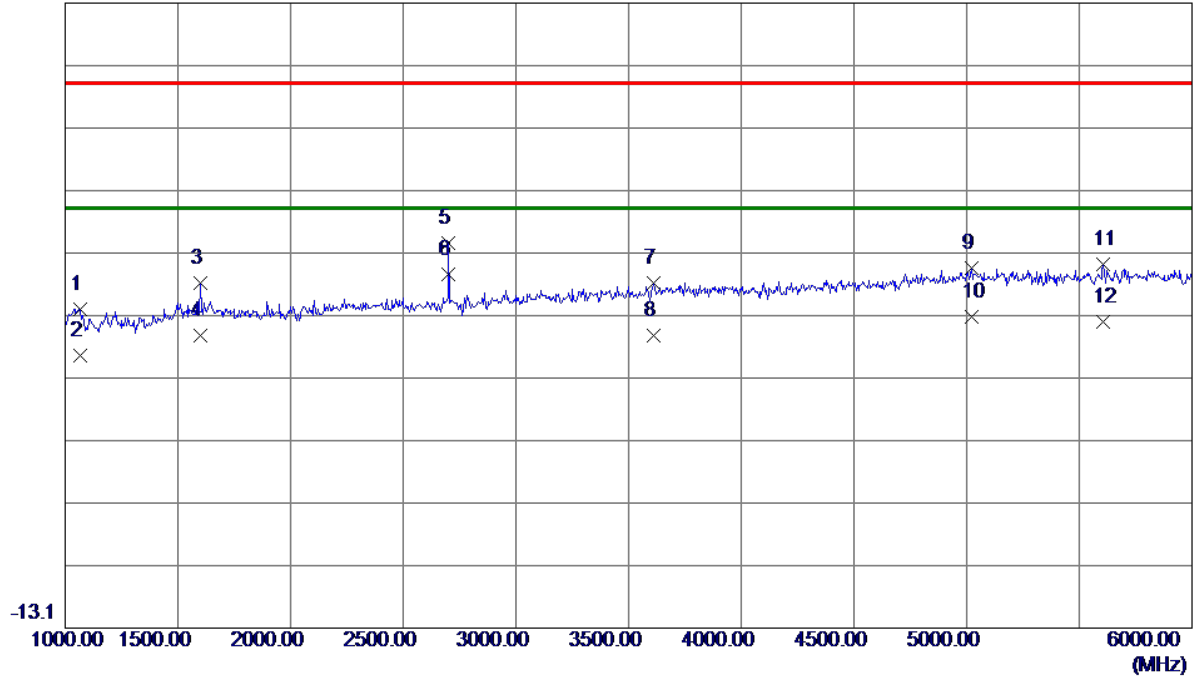

No.	Freq. MHz	Reading Level dBuV/m	Correct Factor dB	Measure ment dBuV/m	Limit dBuV/m	Margin dB	Detector
1	1065.0000	44.53	-6.60	37.93	74.00	-36.07	Peak
2	1065.0000	37.05	-6.60	30.45	54.00	-23.55	AVG
3	1597.5000	45.39	-3.23	42.16	74.00	-31.84	Peak
4	1597.5000	36.92	-3.23	33.69	54.00	-20.31	AVG
5	2700.0000	47.77	0.75	48.52	74.00	-25.48	Peak
6 *	2700.0000	42.69	0.75	43.44	54.00	-10.56	AVG
7	3612.5000	38.54	3.61	42.15	74.00	-31.85	Peak
8	3612.5000	30.17	3.61	33.78	54.00	-20.22	AVG
9	5022.5000	36.81	7.69	44.50	74.00	-29.50	Peak
10	5022.5000	28.93	7.69	36.62	54.00	-17.38	AVG
11	5607.5000	36.71	8.32	45.03	74.00	-28.97	Peak
12	5607.5000	27.64	8.32	35.96	54.00	-18.04	AVG

4. EUT TEST PHOTO

AC Power Line Conducted Emissions

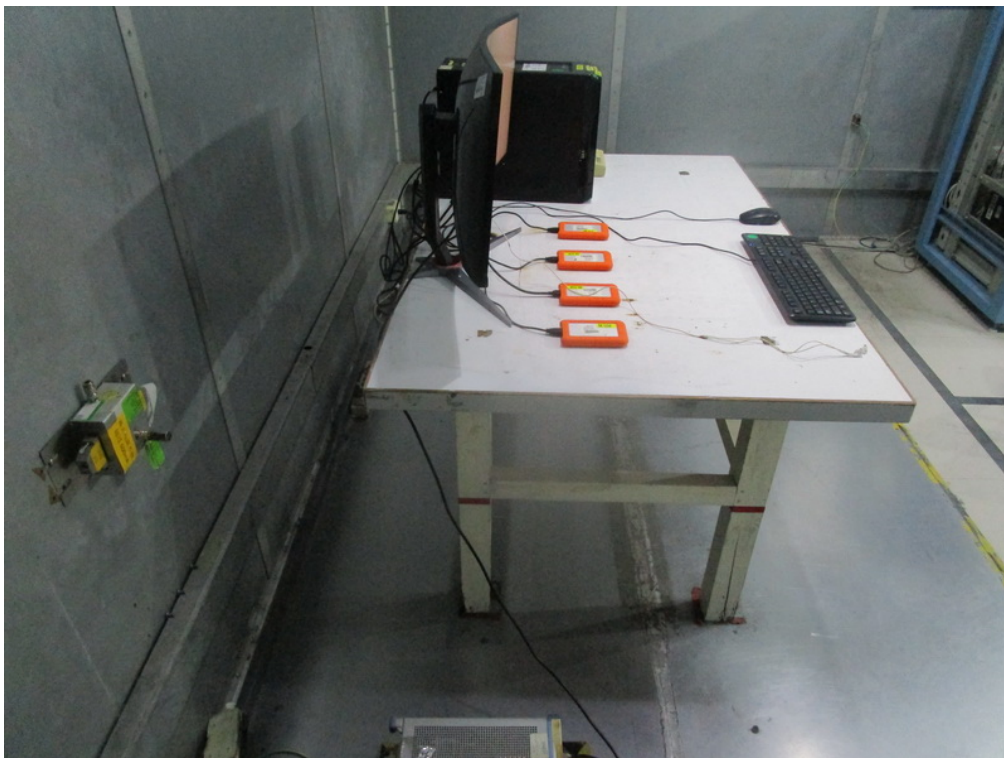

Radiated Emissions 30 MHz to 1 GHz

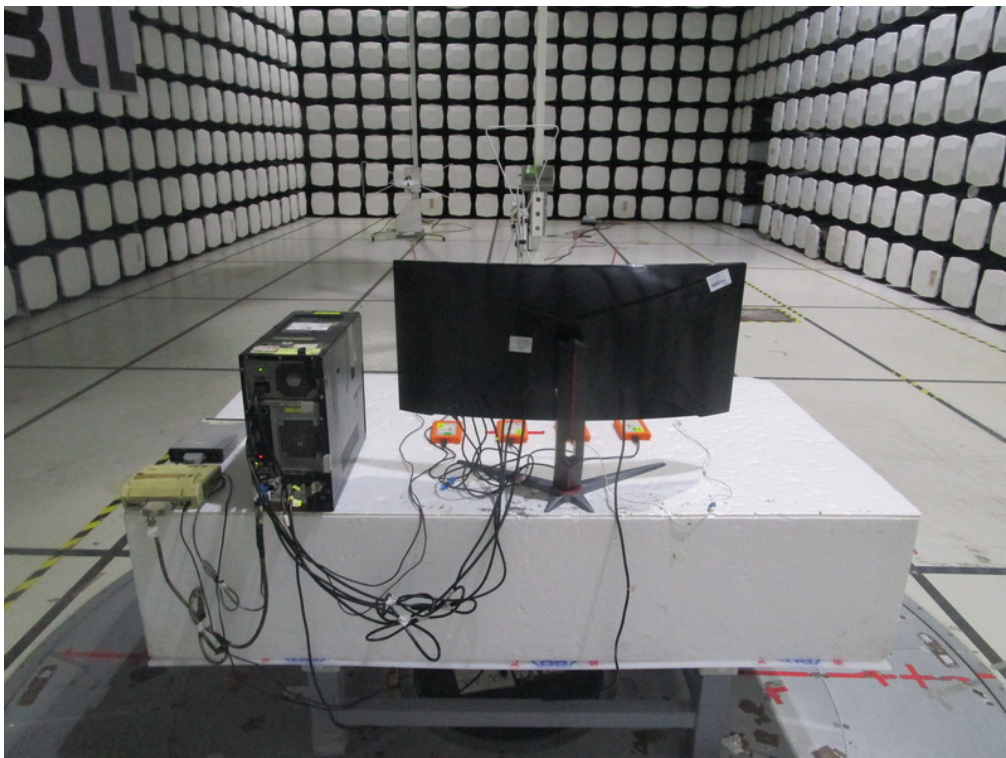
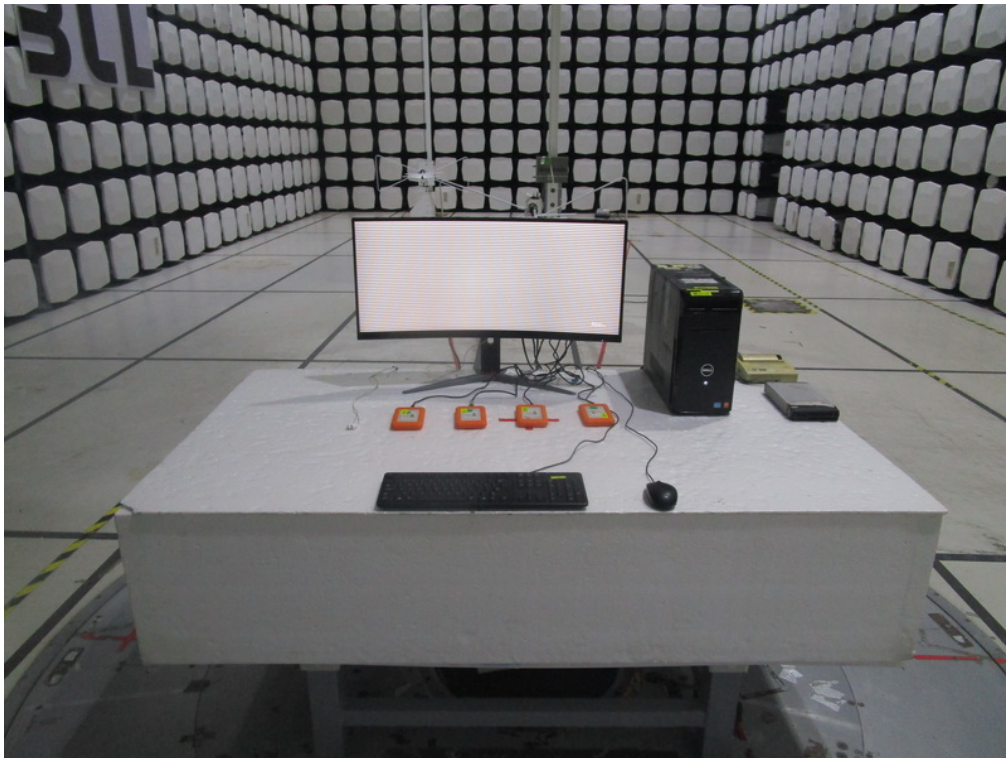

Radiated Emissions Above 1 GHz

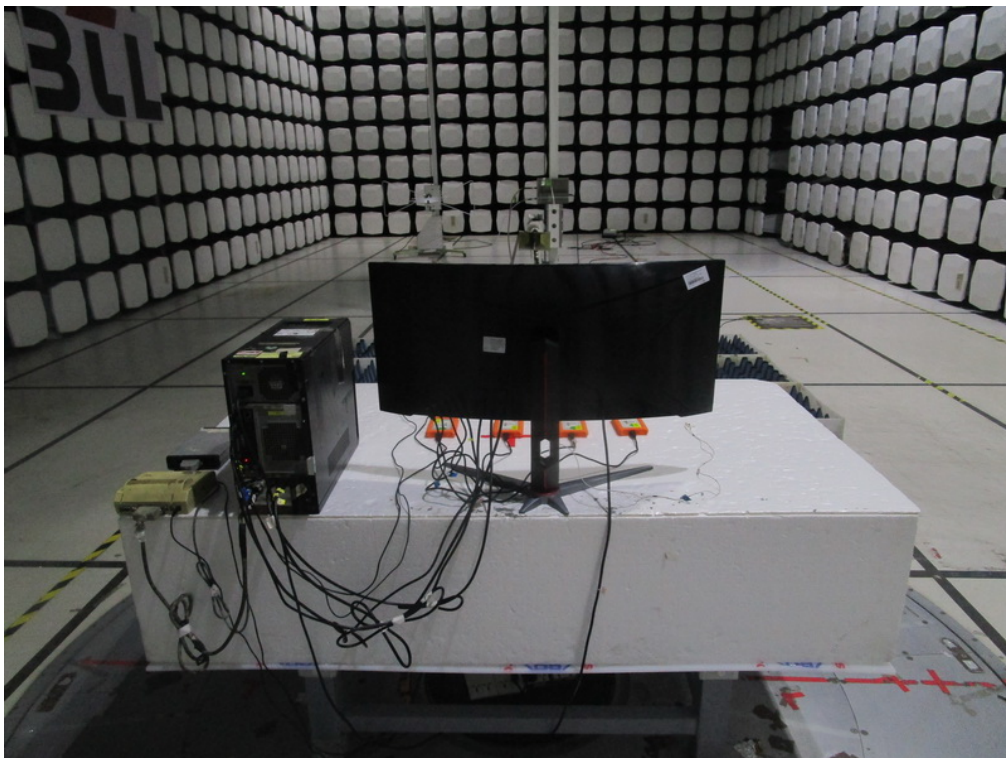
**End of Test Report**