

CE EMC Test Report

Project No. : 1908C156
Equipment : LCD Monitor
Brand Name : N/A
Test Model : **34G2*****(*=A-Z,a-z,0-9,/, +,-,\ or blank)
Series Model : N/A
Applicant : TPV Electronics (Fujian) Co., Ltd.
Address : Rongqiao Economic and Technological Development Zone, Fuqing City,
Fujian Province, P.R. China
Date of Receipt : Aug. 22, 2019
Date of Test : Aug. 26, 2019 ~ Nov. 22, 2019
Issued Date : Dec. 05, 2019
Report Version : R00
Test Sample : Engineering Sample No.: DG19082261
Standard(s) : EN 55032:2012+AC:2013
EN 55032:2015
EN 55032:2015+AC:2016
IEC 61000-3-2:2014 / EN 61000-3-2:2014
IEC 61000-3-3:2013 / EN 61000-3-3:2013
EN 55024:2010
EN 55024:2010+A1:2015

The above equipment has been tested and found compliance with the requirement of the relative standards by BTL Inc.

Sam. Wang

Prepared by : Sam Wang

Kevin Li

Approved by : Kevin Li



Certificate #5123.02

Add: No.3, Jinshagang 1st Road, Shixia, Dalang Town, Dongguan, Guangdong, China.

Tel: +86-769-8318-3000

Web: www.newbtl.com

Declaration

BTL represents to the client that testing is done in accordance with standard procedures as applicable and that test instruments used has been calibrated with standards traceable to international standard(s) and/or national standard(s).

BTL's reports apply only to the specific samples tested under conditions. It is manufacture's responsibility to ensure that additional production units of this model are manufactured with the identical electrical and mechanical components. **BTL** shall have no liability for any declarations, inferences or generalizations drawn by the client or others from **BTL** issued reports.

The report must not be used by the client to claim product certification, approval, or endorsement by NVLAP, NIST, A2LA, or any agency of the U.S. Government.

This report is the confidential property of the client. As a mutual protection to the clients, the public and ourselves, the test report shall not be reproduced, except in full, without our written approval.

BTL's laboratory quality assurance procedures are in compliance with the **ISO/IEC 17025** requirements, and accredited by the conformity assessment authorities listed in this test report.

BTL is not responsible for the sampling stage, so the results only apply to the sample as received.

The information, data and test plan are provided by manufacturer which may affect the validity of results, so it is manufacturer's responsibility to ensure that the apparatus meets the essential requirements of applied standards and in all the possible configurations as representative of its intended use.

Limitation

For the use of the authority's logo is limited unless the Test Standard(s)/Scope(s)/Item(s) mentioned in this test report is (are) included in the conformity assessment authorities acceptance respective.

Please note that the measurement uncertainty is provided for informational purpose only and are not use in determining the Pass/Fail results.

Table of Contents	Page
REPORT ISSUED HISTORY	7
1 . SUMMARY OF TEST RESULTS	8
1.1 TEST FACILITY	9
1.2 MEASUREMENT UNCERTAINTY	9
1.3 TEST ENVIRONMENT CONDITIONS	11
2 . GENERAL INFORMATION	12
2.1 GENERAL DESCRIPTION OF EUT	12
2.2 DESCRIPTION OF TEST MODES	13
2.3 EUT OPERATING CONDITIONS	14
2.4 BLOCK DIAGRAM SHOWING THE CONFIGURATION OF SYSTEM TESTED	14
2.5 DESCRIPTION OF SUPPORT UNITS	15
3 . EMC EMISSION TEST- EN55032:2012+AC:2013 & 2015	16
3.1 RADIATED EMISSION UP TO 1 GHZ	16
3.1.1 LIMITS	16
3.1.2 MEASUREMENT INSTRUMENTS LIST	16
3.1.3 TEST PROCEDURE	17
3.1.4 DEVIATION FROM TEST STANDARD	17
3.1.5 TEST SETUP	17
3.1.6 MEASUREMENT DISTANCE	18
3.1.7 TEST RESULTS (UP TO 1 GHZ)	19
3.2 RADIATED EMISSION ABOVE 1 GHZ	27
3.2.1 LIMITS	27
3.2.2 MEASUREMENT INSTRUMENTS LIST	28
3.2.3 TEST PROCEDURE	28
3.2.4 DEVIATION FROM TEST STANDARD	29
3.2.5 TEST SETUP	29
3.2.6 MEASUREMENT DISTANCE	30
3.2.7 TEST RESULTS (ABOVE 1 GHZ)	31
3.3 CONDUCTED EMISSION MEASUREMENT AT AC MAINS POWER PORTS	39
3.3.1 LIMITS	39
3.3.2 MEASUREMENT INSTRUMENTS LIST	39
3.3.3 TEST PROCEDURE	40
3.3.4 DEVIATION FROM TEST STANDARD	40
3.3.5 TEST SETUP	40
3.3.6 TEST RESULTS	41
4 . EMC EMISSION TEST- EN 55032:2015+AC:2016	49

Table of Contents	Page
4.1 RADIATED EMISSIONS UP TO 1 GHZ	49
4.1.1 LIMITS	49
4.1.2 MEASUREMENT INSTRUMENTS LIST	49
4.1.3 TEST PROCEDURE	50
4.1.4 DEVIATION FROM TEST STANDARD	50
4.1.5 TEST SETUP	50
4.1.6 MEASUREMENT DISTANCE	51
4.1.7 TEST RESULTS (UP TO 1 GHZ)	52
4.2 RADIATED EMISSIONS ABOVE 1 GHZ	54
4.2.1 LIMITS	54
4.2.2 TEST PROCEDURE	55
4.2.3 DEVIATION FROM TEST STANDARD	55
4.2.4 TEST SETUP	56
4.2.5 MEASUREMENT DISTANCE	57
4.2.6 TEST RESULTS (ABOVE 1 GHZ)	58
4.3 CONDUCTED EMISSION MEASUREMENT AT AC MAINS POWER PORTS	60
4.3.1 LIMITS	60
4.3.2 MEASUREMENT INSTRUMENTS LIST	60
4.3.3 TEST PROCEDURE	61
4.3.4 DEVIATION FROM TEST STANDARD	61
4.3.5 TEST SETUP	61
4.3.6 TEST RESULTS	62
5 . HARMONIC AND FLICKER TEST	64
5.1 HARMONIC CURRENT EMISSIONS	64
5.1.1 LIMITS	64
5.1.2 MEASUREMENT INSTRUMENTS LIST	64
5.1.3 TEST PROCEDURE	64
5.1.4 DEVIATION FROM TEST STANDARD	64
5.1.5 TEST SETUP	64
5.1.6 TEST RESULTS	65
5.2 VOLTAGE CHANGES, VOLTAGE FLUCTUATIONS AND FLICKER TEST	68
5.2.1 LIMITS	68
5.2.2 MEASUREMENT INSTRUMENTS LIST	68
5.2.3 TEST PROCEDURE	68
5.2.4 DEVIATION FROM TEST STANDARD	68
5.2.5 TEST SETUP	69
5.2.6 TEST RESULTS	70
6 . EMC IMMUNITY TEST	71
6.1 STANDARD COMPLIANCE/SEVERITY LEVEL/CRITERIA	71
6.2 GENERAL PERFORMANCE CRITERIA	73

Table of Contents	Page
6.3 ELECTROSTATIC DISCHARGE IMMUNITY TEST (ESD)	74
6.3.1 TEST SPECIFICATION	74
6.3.2 MEASUREMENT INSTRUMENTS	74
6.3.3 TEST PROCEDURE	74
6.3.4 DEVIATION FROM TEST STANDARD	75
6.3.5 TEST SETUP	75
6.3.6 TEST RESULTS	76
6.4 RADIATED, RADIO-FREQUENCY, ELECTROMAGNETIC FIELD IMMUNITY TEST (RS)	80
6.4.1 TEST SPECIFICATION	80
6.4.2 MEASUREMENT INSTRUMENTS	80
6.4.3 TEST PROCEDURE	80
6.4.4 DEVIATION FROM TEST STANDARD	80
6.4.5 TEST SETUP	81
6.4.6 TEST RESULTS	82
6.5 ELECTRICAL FAST TRANSIENT/BURST IMMUNITY TEST (EFT/BURST)	83
6.5.1 TEST SPECIFICATION	83
6.5.2 MEASUREMENT INSTRUMENTS	83
6.5.3 TEST PROCEDURE	83
6.5.4 DEVIATION FROM TEST STANDARD	83
6.5.5 TEST SETUP	84
6.5.6 TEST RESULTS	85
6.6 SURGE IMMUNITY TEST	86
6.6.1 TEST SPECIFICATION	86
6.6.2 MEASUREMENT INSTRUMENTS	86
6.6.3 TEST PROCEDURE	86
6.6.4 DEVIATION FROM TEST STANDARD	87
6.6.5 TEST SETUP	87
6.6.6 TEST RESULTS	88
6.7 IMMUNITY TO CONDUCTED DISTURBANCES, INDUCED BY RADIO-FREQUENCY FIELDS TEST (CS)	89
6.7.1 TEST SPECIFICATION	89
6.7.2 MEASUREMENT INSTRUMENTS	89
6.7.3 TEST PROCEDURE	89
6.7.4 DEVIATION FROM TEST STANDARD	89
6.7.5 TEST SETUP	90
6.7.6 TEST RESULTS	91
6.8 POWER FREQUENCY MAGNETIC FIELD IMMUNITY TEST (PFMF)	92
6.8.1 TEST SPECIFICATION	92
6.8.2 MEASUREMENT INSTRUMENTS	92
6.8.3 TEST PROCEDURE	92

Table of Contents	Page
6.8.4 DEVIATION FROM TEST STANDARD	92
6.8.5 TEST SETUP	93
6.8.6 TEST RESULTS	94
6.9 VOLTAGE DIPS, SHORT INTERRUPTIONS AND VOLTAGE VARIATIONS	
IMMUNITY TEST	95
6.9.1 TEST SPECIFICATION	95
6.9.2 MEASUREMENT INSTRUMENTS	95
6.9.3 TEST PROCEDURE	95
6.9.4 DEVIATION FROM TEST STANDARD	95
6.9.5 TEST SETUP	96
6.9.6 TEST RESULTS	97
7 . EUT TEST PHOTO	98

REPORT ISSUED HISTORY

Report Version	Description	Issued Date
R00	Original Issue.	Dec. 05, 2019

1. SUMMARY OF TEST RESULTS

Test procedures according to the technical standards:

Emission			
Standard(s)	Test Item	Result	
EN 55032:2012+AC:2013 EN 55032:2015 EN 55032:2015+AC:2016	Radiated emissions up to 1 GHz	PASS	
	Radiated emissions above 1 GHz	PASS	
	Radiated emissions from FM receivers	N/A	
	Conducted emissions AC mains power port	PASS	
	Asymmetric mode conducted emissions	AAN	N/A
		Current Probe	N/A
		CP+CVP	N/A
Conducted differential voltage emissions	N/A		

Standard(s)	Test Item	Result
IEC 61000-3-2:2014 EN 61000-3-2:2014	Harmonic current	PASS
IEC 61000-3-3:2013 EN 61000-3-3:2013	Voltage fluctuations (Flicker)	PASS

Immunity			
Standard(s)	Ref Standard(s)	Test Item	Result
EN 55024: 2010/ EN 55024:2010+A1:2015	IEC 61000-4-2:2008 / EN 61000-4-2:2009	ESD	PASS
	IEC 61000-4-3: 2006+A1:2007+A2:2010 / EN 61000-4-3: 2006+A1:2008+A2:2010	RS	PASS
	IEC 61000-4-4:2012 / EN 61000-4-4:2012	EFT	PASS
	IEC 61000-4-5: 2014+A1:2017 / EN 61000-4-5:2014+A1:2017	Surge	PASS
	IEC 61000-4-6:2013 / EN 61000-4-6:2014+AC:2015	CS	PASS
	IEC 61000-4-8:2009 / EN 61000-4-8:2010	PFMF	PASS
	IEC 61000-4-11: 2004+A1:2017 / EN 61000-4-11: 2004+A1:2017	Dip	PASS

NOTE:

- (1) "N/A" denotes test is not applicable to this device.

1.1 TEST FACILITY

The test facilities used to collect the test data in this report is at the location of No.3, Jinshagang 1st Road, Shixia, Dalang Town, Dongguan, Guangdong, China.

1.2 MEASUREMENT UNCERTAINTY

Where relevant, the following measurement uncertainty levels have been estimated for tests performed on the EUT as specified in CISPR 16-4-2, The BTL measurement uncertainty is less than the CISPR 16-4-2 U_{cispr} requirement.

The reported uncertainty of measurement $y \pm U$, where expanded uncertainty U is based on a standard uncertainty multiplied by a coverage factor of $k=2$, providing a level of confidence of approximately **95%**.

A. Radiated emissions up to 1 GHz measurement:

Test Site	Method	Measurement Frequency Range	Ant. H / V	U,(dB)
DG-CB08 (10m)	CISPR	30MHz ~ 200MHz	V	4.44
		30MHz ~ 200MHz	H	3.44
		200MHz ~ 1,000MHz	V	4.28
		200MHz ~ 1,000MHz	H	3.52

B. Radiated emissions above 1 GHz measurement:

Test Site	Method	Measurement Frequency Range	U,(dB)
DG-CB08 (3m)	CISPR	1GHz ~ 6GHz	4.36

C. Conducted emissions AC mains power port measurement:

Test Site	Method	Measurement Frequency Range	U,(dB)
DG-C02	CISPR	150kHz ~ 30MHz	2.60

D. Harmonic current emissions / Voltage fluctuations (Flicker) measurement:

Test Site	Method	Item	U(%)
DG-C01	EN 61000-3-2	Current	0.593
	EN 61000-3-3	Voltage	0.595

E. Immunity Measurement:

Test Site	Method	Item	U
DG-SR02	IEC 61000-4-2	Rise time tr	6.80%
		Peak current Ip	6.30%
		Current at 30 ns	6.50%
		Current at 60 ns	6.90%
DG-CB05	IEC 61000-4-3	Electromagnetic field immunity test	2.38dB
DG-SR05	IEC 61000-4-4	Peak voltage (V _P)	3.7%
		Rise time (tr)	4.4%
		Pulse width(tw)	4.1%
		Pulse Freq.(kHz)	0.8%
		Burst Duration(ms)	1.4%
		Burst Period(ms)	1.4%
		Peak voltage (V _P)-with clamp	3.7%
		Rise time (tr) -with clamp	5.0%
DG-SR01	IEC 61000-4-5	Open-Circuit Output Voltage (1.2/50us)	3.8%
		Open circuit front time (1.2/50us)	6.3%
		Open circuit time of half value (1.2/50us)	4.6%
DG-CB06	IEC 61000-4-6	CDN	1.32dB
		EM clamp	3.16dB
DG-SR05	IEC 61000-4-8	Magnetic Field Level	3.787 %
DG-SR05	IEC 61000-4-11	DIP Amplitude	0.5%
		DIP Time Event	3%

Note: Unless specifically mentioned, the uncertainty of measurement has not been taken into account to declare the compliance or non-compliance to the specification.

1.3 TEST ENVIRONMENT CONDITIONS

Test Item	Temperature	Humidity	Tested By
Radiated emissions up to 1 GHz	25°C	60%	Promise Yin
Radiated emissions above 1 GHz	25°C	60%	Promise Yin
Conducted emissions AC mains power port	25°C	53%	Bang Liang
Harmonic current	25°C	55%	Bang Liang
Voltage fluctuations (Flicker)	25°C	55%	Bang Liang

Test Item	Temperature	Humidity	Pressure	Tested By
ESD	25°C	48%	1010hPa	Rich Ye
RS	25°C	52%	/	Hunter Xu
EFT	25°C	50%	/	Celina Lai
Surge	25°C	50%	/	Celina Lai
CS	25°C	52%	/	Daniel Li
PFMF	25°C	50%	/	Celina Lai
Dip	25°C	50%	/	Celina Lai

2. GENERAL INFORMATION

2.1 GENERAL DESCRIPTION OF EUT

Equipment	LCD Monitor
Brand Name	N/A
Test Model	**34G2*****(*=A-Z,a-z,0-9,/, +,-,\ or blank)
Series Model	N/A
Model Difference(s)	Only differ in model name due to marketing purpose.
Power Source	AC Mains.
Power Rating	100-240V~ 50-60Hz
Connecting I/O Port(s)	5* USB port 2* HDMI port 1* Display port 1* Earphone port 1* AC port
Classification Of EUT	Class B
Highest Internal Frequency(Fx)	600 MHz

Cable Type	Shielded Type	Ferrite Core	Length(m)	Note
HDMI	Shielded	NO	1.8/1.5	/
Display	Shielded	NO	1.8/1.5	/
USB	Shielded	NO	1.8/1.5	/
AC Power Cord	Non-shielded	NO	1.8/1.5	1.8m is worst case Detachable (3 Pin)

Note:

1. For a more detailed features description, please refer to the manufacturer's specifications or the user's manual.
2. Power cable 1.8m, 1.5m length, worst case is Power cable 1.8m with HDMI+Display+USB 1.8m length testing and recording in test report.

2.2 DESCRIPTION OF TEST MODES

To investigate the maximum EMI emission characteristics generated from EUT, the test system was pre-scanning tested based on the consideration of following EUT operation mode or test configuration mode which possibly have effect on EMI emission level. Each of these EUT operation mode(s) or test configuration mode(s) mentioned above was evaluated respectively.

Pretest Mode	Description
Mode 1	HDMI1 3440*1440/100Hz
Mode 2	HDMI2 3440*1440/100Hz
Mode 3	HDMI1 2160P
Mode 4	HDMI2 2160P
Mode 5	DP 3440*1440/144Hz
Mode 6	HDMI1 1280*1024/75Hz
Mode 7	HDMI1 640*480/75Hz

Radiated emissions up to 1 GHz test	
Final Test Mode	Description
Mode 1	HDMI1 3440*1440/100Hz
Mode 3	HDMI1 2160P
Mode 5	DP 3440*1440/144Hz

Radiated emissions Above 1 GHz test	
Final Test Mode	Description
Mode 1	HDMI1 3440*1440/100Hz
Mode 3	HDMI1 2160P
Mode 5	DP 3440*1440/144Hz

Conducted emissions AC mains power port test	
Final Test Mode	Description
Mode 1	HDMI1 3440*1440/100Hz
Mode 3	HDMI1 2160P
Mode 5	DP 3440*1440/144Hz

Harmonic current & Voltage fluctuations (Flicker) Test	
Final Test Mode	Description
Mode 1	HDMI1 3440*1440/100Hz

Immunity Test	
Final Test Mode	Description
Mode 1	HDMI1 3440*1440/100Hz

Evaluation description:

1. The maximum resolution is evaluated Mode 1-5. The worst case is Mode 1 and evaluated the middle and low resolution Mode 6 and Mode 7.
2. According to the client's requirement, choose Mode 1, Mode 3, Mode 5 and recorded in test report.

2.3 EUT OPERATING CONDITIONS

The EUT exercise program used during radiated and/or conducted emission measurement was designed to exercise the various system components in a manner similar to a typical use. The standard test signals and output signal as following:

1. EUT connected to PC via HDMI & Display & USB cable.
2. PC connected to Mouse and Keyboard via USB cable.
3. EUT connected to Earphone via Earphone cable.
4. EUT connected to HDD via USB cable.

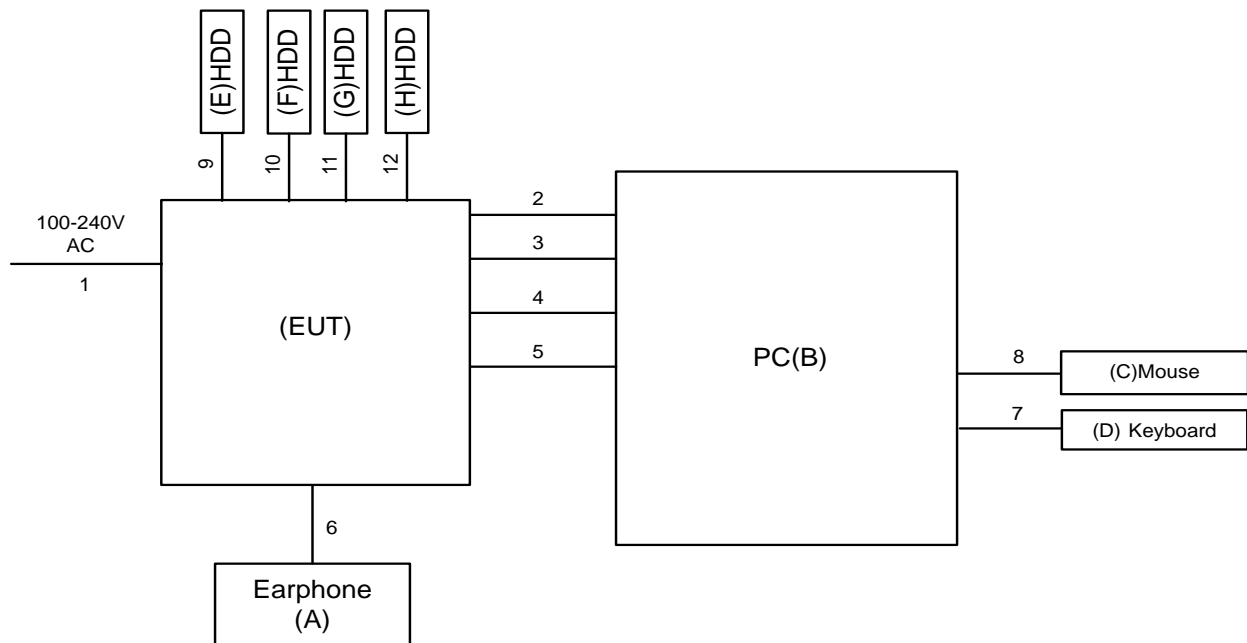
2.4 BLOCK DIAGRAM SHOWING THE CONFIGURATION OF SYSTEM TESTED

2.5 DESCRIPTION OF SUPPORT UNITS

The EUT has been tested as an independent unit together with other necessary accessories or support units. The following support units or accessories were used to form a representative test configuration during the tests.

Item	Equipment	Mfr/Brand	Model/Type No.	Series No.
A	Earphone	Apple	N/A	N/A
B	PC	DELL	Vostro 470	28747261333
C	Mouse	DELL	MS111-P	CN011D3V71581279OLOT
D	Keyboard	DELL	KB212-B	CN0HTXH97158125004DXA01
E	HDD	WD	WDBLUZ5000ASL	WJ1E74X7D92
F	HDD	WD	WDBLUZ5000ASL	WX51AB3N8785
G	HDD	WD	WDBLUZ5000ASL	WXX1E7405LYS
H	HDD	WD	WDBLUZ5000AAL	WXM1A81M8113

Item	Cable Type	Shielded Type	Ferrite Core	Length
1	AC Cable	NO	NO	1.8m/1.5m
2	HDMI Cable	YES	NO	1.8m/1.5m
3	HDMI Cable	YES	NO	1.8m/1.5m
4	DP Cable	YES	NO	1.8m/1.5m
5	USB Cable	YES	NO	1.8m/1.5m
6	Earphone Cable	NO	NO	1.2m
7	USB Cable	YES	NO	1.8m
8	USB Cable	YES	NO	1.8m
9	USB Cable	YES	NO	1.0m
10	USB Cable	YES	NO	1.0m
11	USB Cable	YES	NO	1.0m
12	USB Cable	YES	NO	1.0m

3. EMC EMISSION TEST- EN55032:2012+AC:2013 & 2015

3.1 RADIATED EMISSION UP TO 1 GHZ

3.1.1 LIMITS

Class B equipment up to 1000MHz

Frequency MHz	Measurement		Class B limit dB(uV/m)
	Distance m	Detector type/bandwidth	SAC
30-230	10	Quasi peak / 120 kHz	30
230-1000			37

Notes:

- (1) The limit for radiated test was performed according to as following: EN 55032
- (2) The tighter limit applies at the band edges.
- (3) Emission level (dBuV/m)=20log Emission level (uV/m).
- (4) The test result calculated as following:
 Measurement Value = Reading Level + Correct Factor
 Correct Factor = Antenna Factor + Cable Loss - Amplifier Gain(if use)
 Margin Level = Measurement Value - Limit Value

3.1.2 MEASUREMENT INSTRUMENTS LIST

Up to 1GHz:

Item	Kind of Equipment	Manufacturer	Type No.	Series Model	Calibrated until
1	Receiver	Keysight	N9038A	MY54450004	Aug. 03, 2020
2	MXE EMI Receiver	Agilent	N9038A	MY53220133	Mar. 10, 2020
3	Pre-Amplifier	EMC INSTRUMENT	EMC 9135	980284	Mar. 10, 2020
4	Pre-Amplifier	EMC INSTRUMENT	EMC 9135	980283	Mar. 10, 2020
5	Trilog-Broadband Antenna	Schwarzbeck	VULB9168	946	Oct. 26, 2020
6	Trilog-Broadband Antenna	Schwarzbeck	VULB9168	947	Oct. 26, 2020
7	Cable	emci	LMR-400(5m+1 1m+15m)	N/A	Aug. 06, 2020
8	Cable	emci	LMR-400(5m+8 m+8m)	N/A	Aug. 06, 2020
9	Measurement Software	Farad	EZ-EMC Ver.BTL-2ANT-1	N/A	N/A
10	Multi-Device Controller	ETS-Lindgren	2090	N/A	N/A
11	Attenuator	EMCI	EMCI-N-6-06	N0670	Oct. 26, 2020
12	Attenuator	EMCI	EMCI-N-6-06	N0671	Oct. 26, 2020

Remark: "N/A" denotes no model no., no serial no. or no calibration specified.

All calibration period of equipment list is one year.

3.1.3 TEST PROCEDURE

- a. The measuring distance of 10 m shall be used for measurements. The EUT was placed on the top of a rotating table 0.8 meter above the ground at a 10 meter semi-anechoic chamber. The table was rotated 360 degrees to determine the position of the highest radiation.(below 1GHz).
- c. The height of the equipment or of the substitution antenna shall be 0.8 m, the height of the test antenna shall vary between 1 m to 4 m. Both horizontal and vertical polarizations of the antenna are set to make the measurement.
- d. The initial step in collecting radiated emission data is a receiver peak detector mode pre-scanning the measurement frequency range. Significant peaks are then marked and then Quasi Peak detector mode re-measured.
- e. All readings are Peak unless otherwise stated QP in column of Note. Peak denotes that the Peak reading compliance with the QP Limits and then QP Mode measurement didn't perform.
(below 1GHz)
- g. For the actual test configuration, please refer to the related Item - Block Diagram of system tested.

3.1.4 DEVIATION FROM TEST STANDARD

No deviation

3.1.5 TEST SETUP

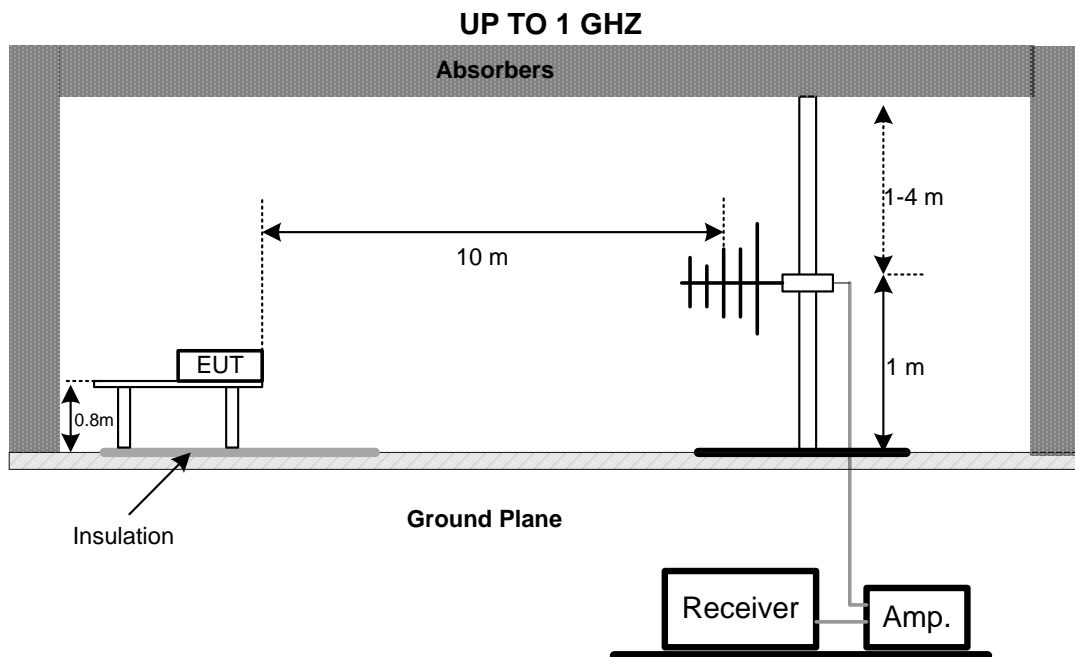

Note: The antenna can be moved between 1 to 4 meters above the ground.

3.1.6 MEASUREMENT DISTANCE

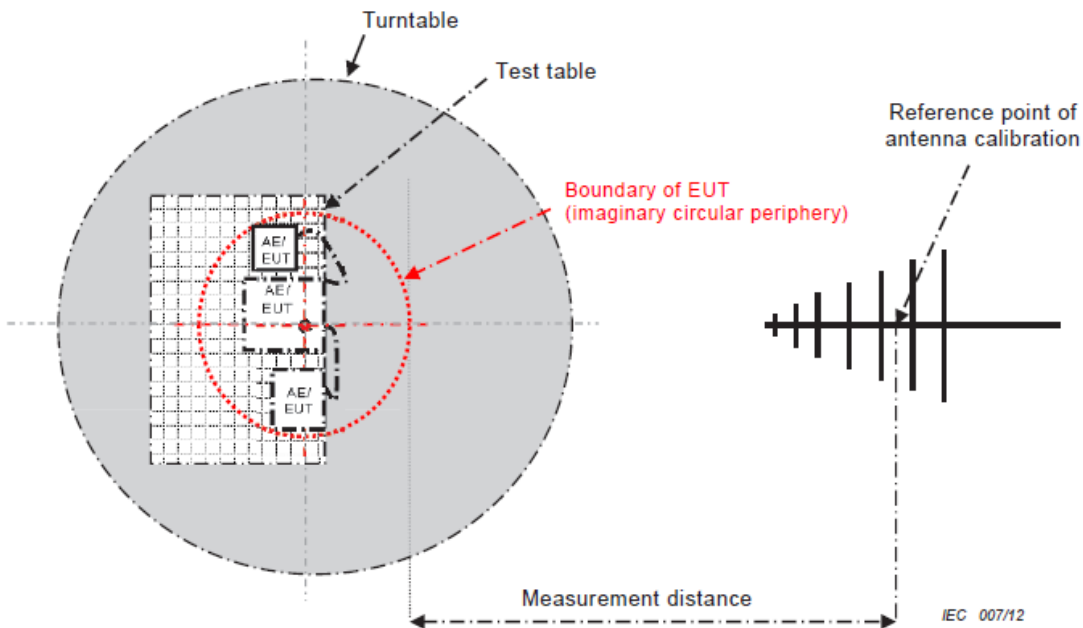

- 34 -

CISPR 32 © IEC:2012

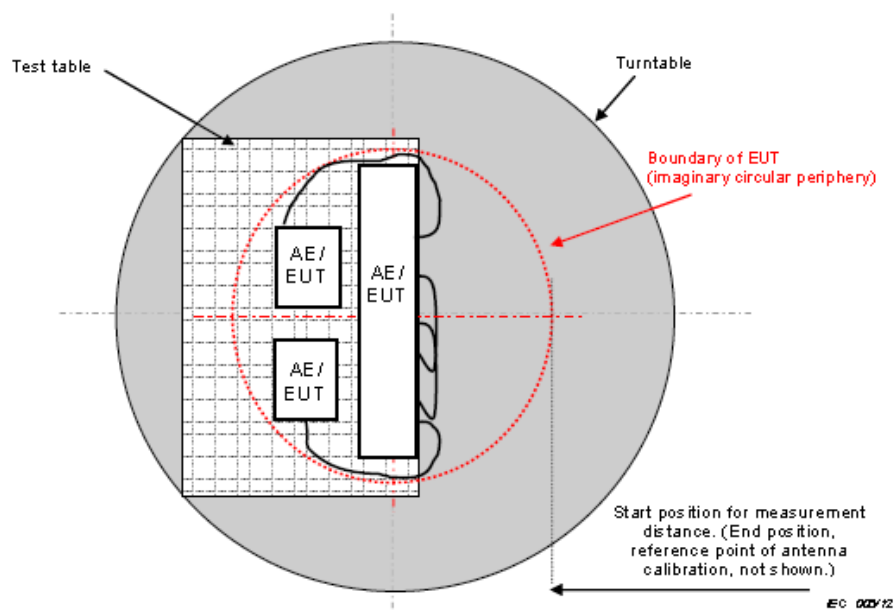
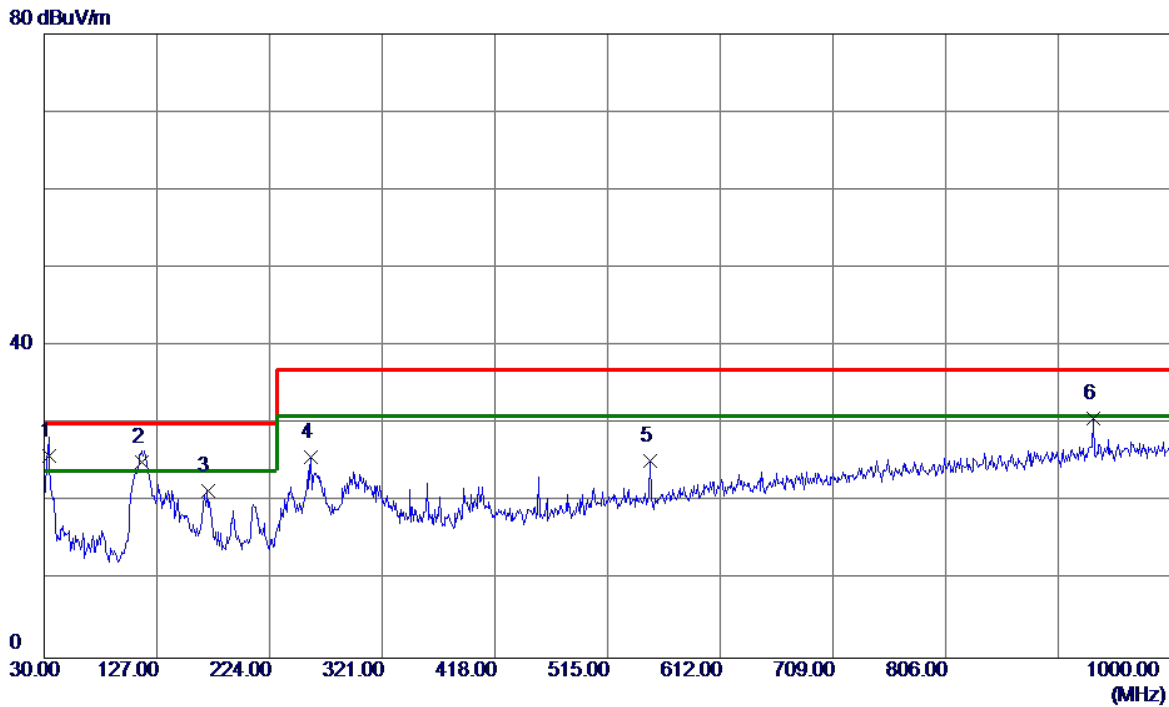

Figure C.2 – Boundary of EUT, Local AE and associated cabling

3.1.7 TEST RESULTS (UP TO 1 GHZ)

Test Voltage	AC 230V/50Hz	Polarization	Vertical
Test Mode	HDMI1 3440*1440/100Hz		



No.	Freq. MHz	Reading Level dBuV/m	Correct Factor dB	Measure ment dBuV/m	Limit dBuV/m	Margin dB	Detector
1 *	33.8800	44.19	-18.32	25.87	30.00	-4.13	QP
2	114.3900	44.26	-19.12	25.14	30.00	-4.86	QP
3	170.6500	37.83	-16.41	21.42	30.00	-8.58	QP
4	259.8900	42.45	-16.70	25.75	37.00	-11.25	QP
5	551.8600	35.16	-9.84	25.32	37.00	-11.68	QP
6	933.0700	34.63	-3.84	30.79	37.00	-6.21	QP

Test Voltage	AC 230V/50Hz	Polarization	Horizontal
Test Mode	HDMI1 3440*1440/100Hz		

80 dBuV/m

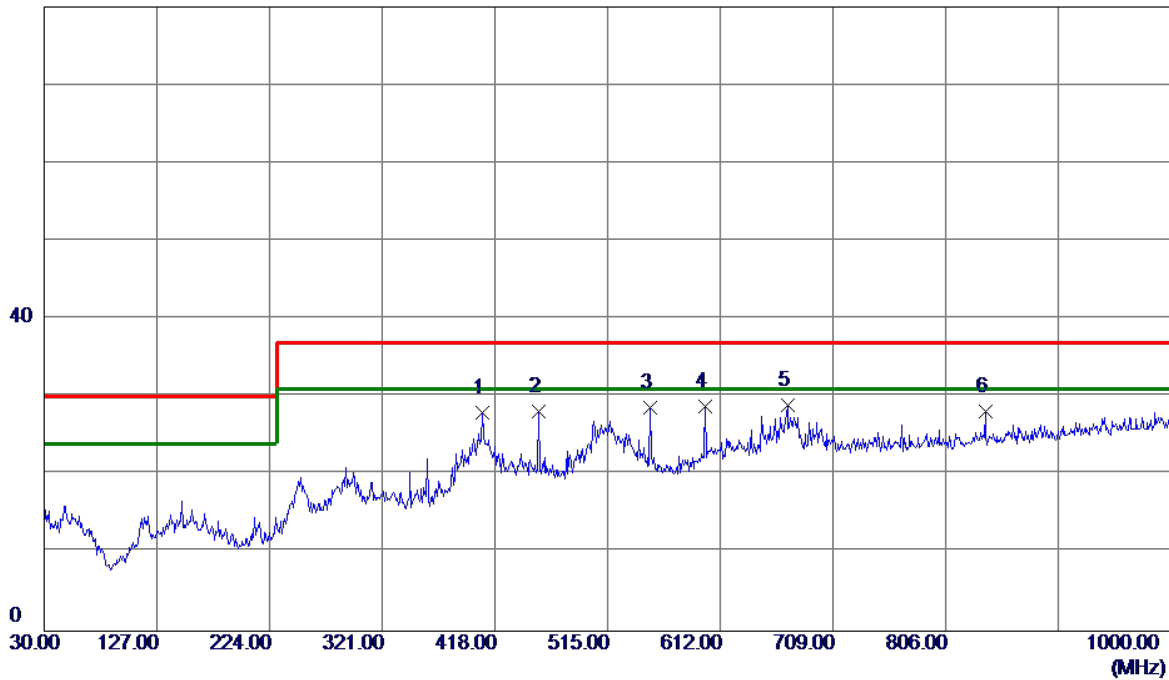

No.	Freq. MHz	Reading Level dBuV/m	Correct Factor dB	Measure ment dBuV/m	Limit dBuV/m	Margin dB	Detector
1	407.3299	40.61	-12.63	27.98	37.00	-9.02	QP
2	455.8300	39.47	-11.30	28.17	37.00	-8.83	QP
3	551.8600	38.30	-9.64	28.66	37.00	-8.34	QP
4	599.3900	37.24	-8.46	28.78	37.00	-8.22	QP
5 *	669.7150	36.56	-7.55	29.01	37.00	-7.99	QP
6	839.9500	33.55	-5.37	28.18	37.00	-8.82	QP

Test Voltage	AC 230V/50Hz	Polarization	Vertical
Test Mode	HDMI1 2160P		

80 dBuV/m

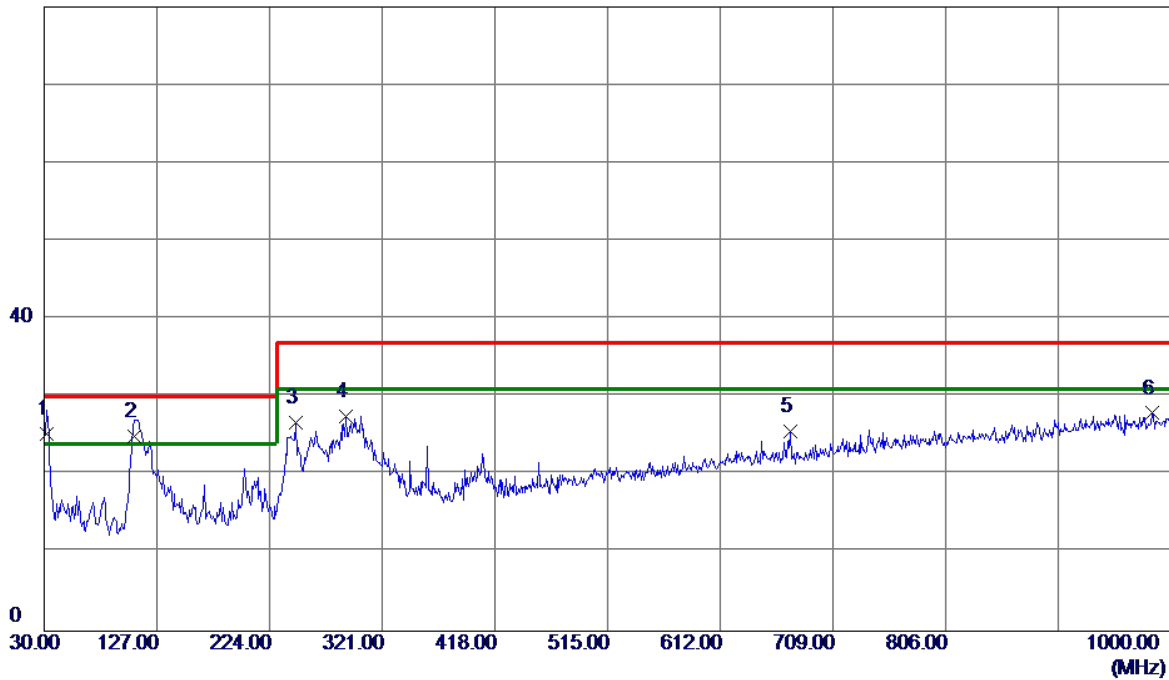

No.	Freq. MHz	Reading Level dBuV/m	Correct Factor dB	Measure ment dBuV/m	Limit dBuV/m	Margin dB	Detector
1 *	31.9400	43.70	-18.45	25.25	30.00	-4.75	QP
2	107.6000	44.84	-19.87	24.97	30.00	-5.03	QP
3	246.3100	43.94	-17.19	26.75	37.00	-10.25	QP
4	289.9600	42.97	-15.42	27.55	37.00	-9.45	QP
5	672.1400	33.17	-7.53	25.64	37.00	-11.36	QP
6	983.5100	31.05	-3.13	27.92	37.00	-9.08	QP

Test Voltage	AC 230V/50Hz	Polarization	Horizontal
Test Mode	HDMI1 2160P		

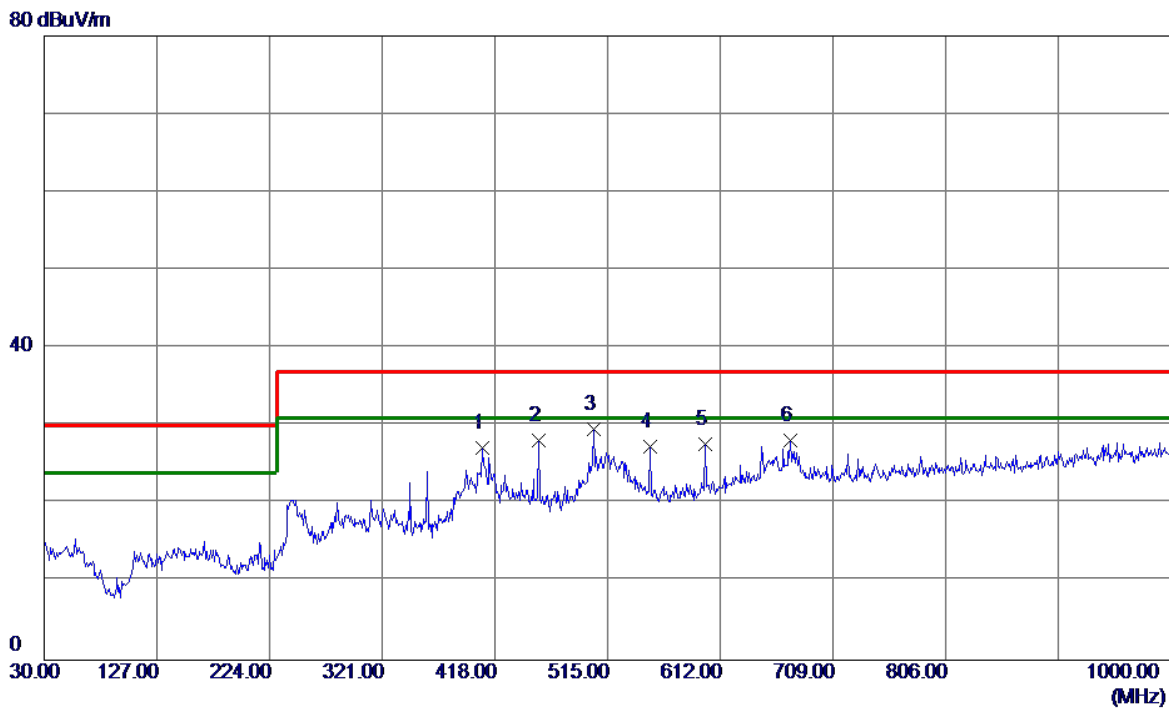

No.	Freq. MHz	Reading Level dBuV/m	Correct Factor dB	Measure ment dBuV/m	Limit dBuV/m	Margin dB	Detector
1	407.3299	39.84	-12.63	27.21	37.00	-9.79	QP
2	455.8300	39.53	-11.30	28.23	37.00	-8.77	QP
3 *	503.3600	40.11	-10.47	29.64	37.00	-7.36	QP
4	551.8600	37.02	-9.64	27.38	37.00	-9.62	QP
5	599.3900	36.19	-8.46	27.73	37.00	-9.27	QP
6	672.1400	35.71	-7.51	28.20	37.00	-8.80	QP

Test Voltage	AC 230V/50Hz	Polarization	Vertical
Test Mode	DP 3440*1440/144Hz		

80 dBuV/m

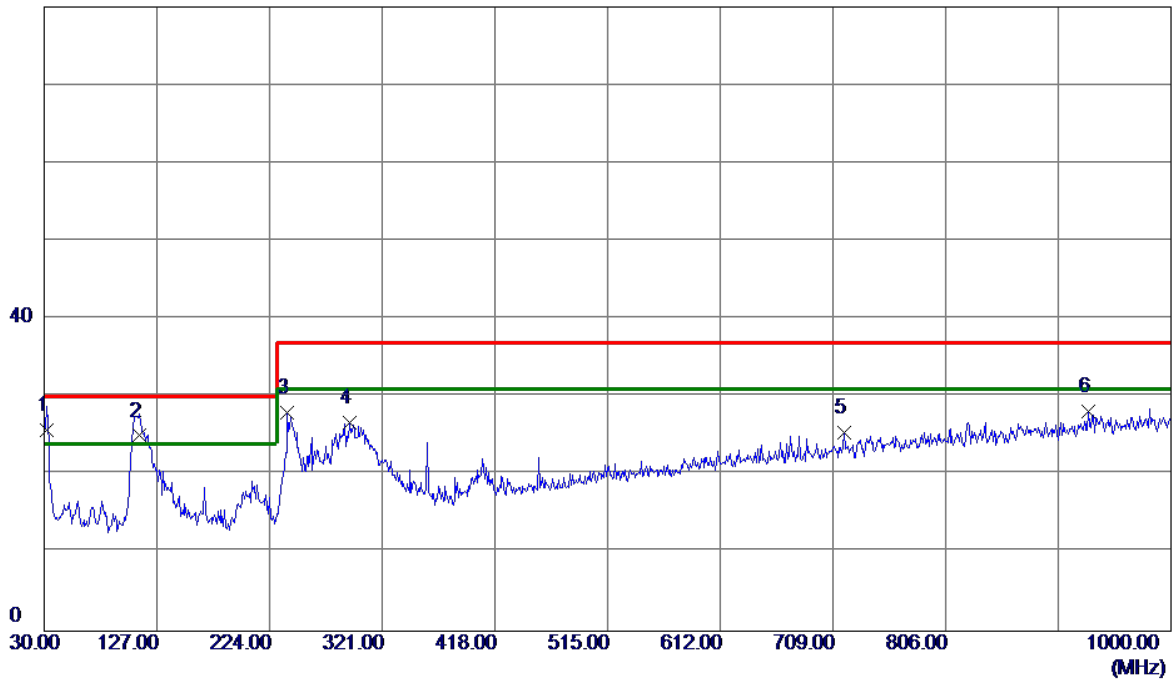

No.	Freq. MHz	Reading Level dBuV/m	Correct Factor dB	Measure ment dBuV/m	Limit dBuV/m	Margin dB	Detector
1 *	31.9400	44.15	-18.45	25.70	30.00	-4.30	QP
2	111.4800	44.42	-19.38	25.04	30.00	-4.96	QP
3	239.5200	45.45	-17.44	28.01	37.00	-8.99	QP
4	292.8700	42.08	-15.33	26.75	37.00	-10.25	QP
5	719.1850	32.27	-6.86	25.41	37.00	-11.59	QP
6	929.1900	32.13	-3.91	28.22	37.00	-8.78	QP

Test Voltage	AC 230V/50Hz	Polarization	Horizontal
Test Mode	DP 3440*1440/144Hz		

80 dBuV/m

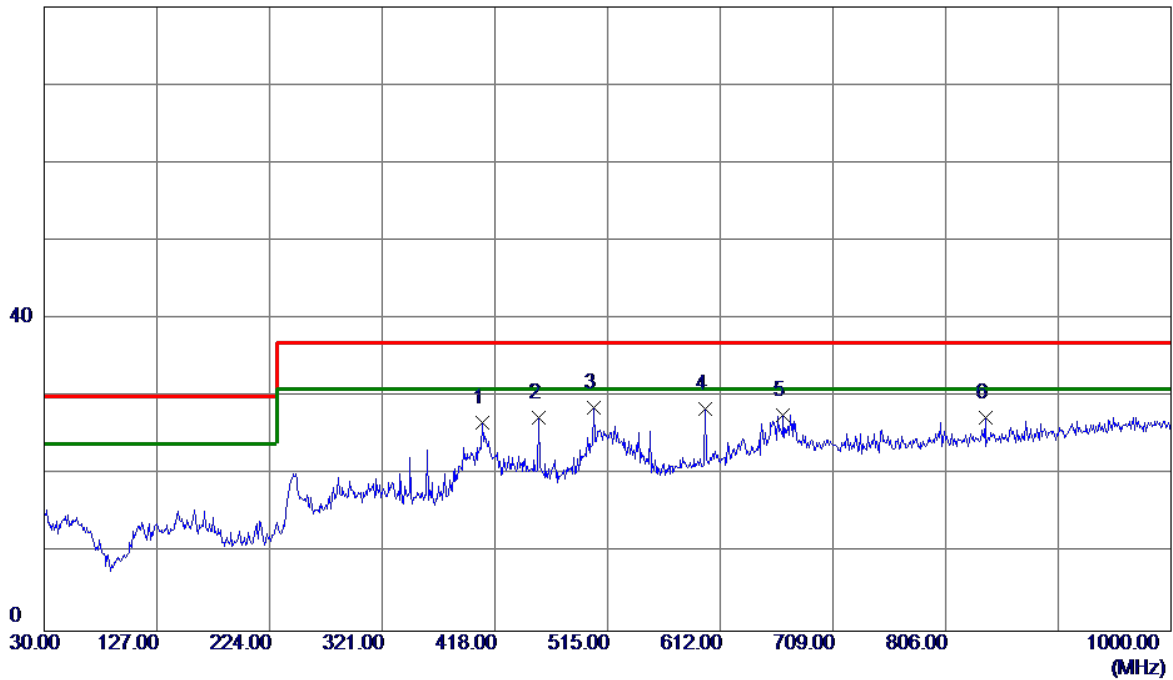

No.	Freq. MHz	Reading Level dBuV/m	Correct Factor dB	Measure ment dBuV/m	Limit dBuV/m	Margin dB	Detector
1	407.3299	39.31	-12.63	26.68	37.00	-10.32	QP
2	455.8300	38.59	-11.30	27.29	37.00	-9.71	QP
3 *	503.3600	39.13	-10.47	28.66	37.00	-8.34	QP
4	599.3900	36.88	-8.46	28.42	37.00	-8.58	QP
5	666.3200	35.35	-7.60	27.75	37.00	-9.25	QP
6	839.9500	32.77	-5.37	27.40	37.00	-9.60	QP

Test Voltage	AC 110V/60Hz	Polarization	Vertical
Test Mode	HDMI1 3440*1440/100Hz		

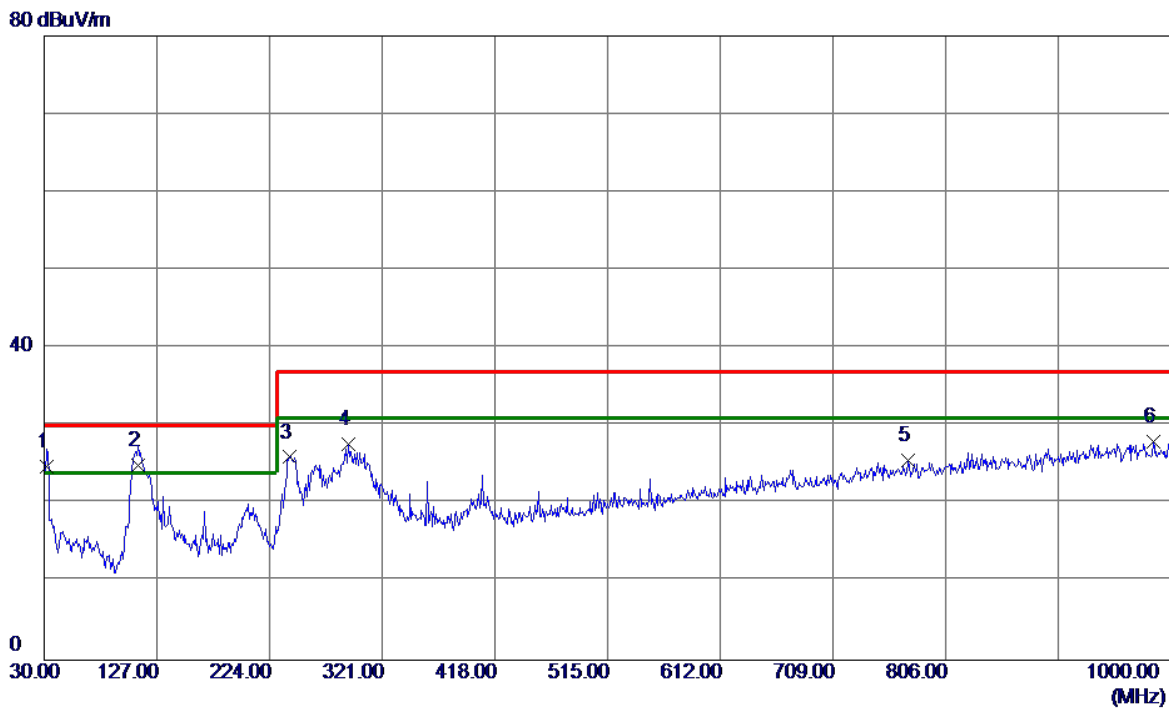

No.	Freq. MHz	Reading Level dBuV/m	Correct Factor dB	Measure ment dBuV/m	Limit dBuV/m	Margin dB	Detector
1	31.9400	43.25	-18.45	24.80	30.00	-5.20	QP
2 *	110.5100	44.49	-19.47	25.02	30.00	-4.98	QP
3	241.4600	43.35	-17.35	26.00	37.00	-11.00	QP
4	291.9000	43.02	-15.36	27.66	37.00	-9.34	QP
5	773.9900	31.67	-6.00	25.67	37.00	-11.33	QP
6	984.4800	31.12	-3.12	28.00	37.00	-9.00	QP

Test Voltage	AC 110V/60Hz	Polarization	Horizontal
Test Mode	HDMI1 3440*1440/100Hz		

80 dBuV/m

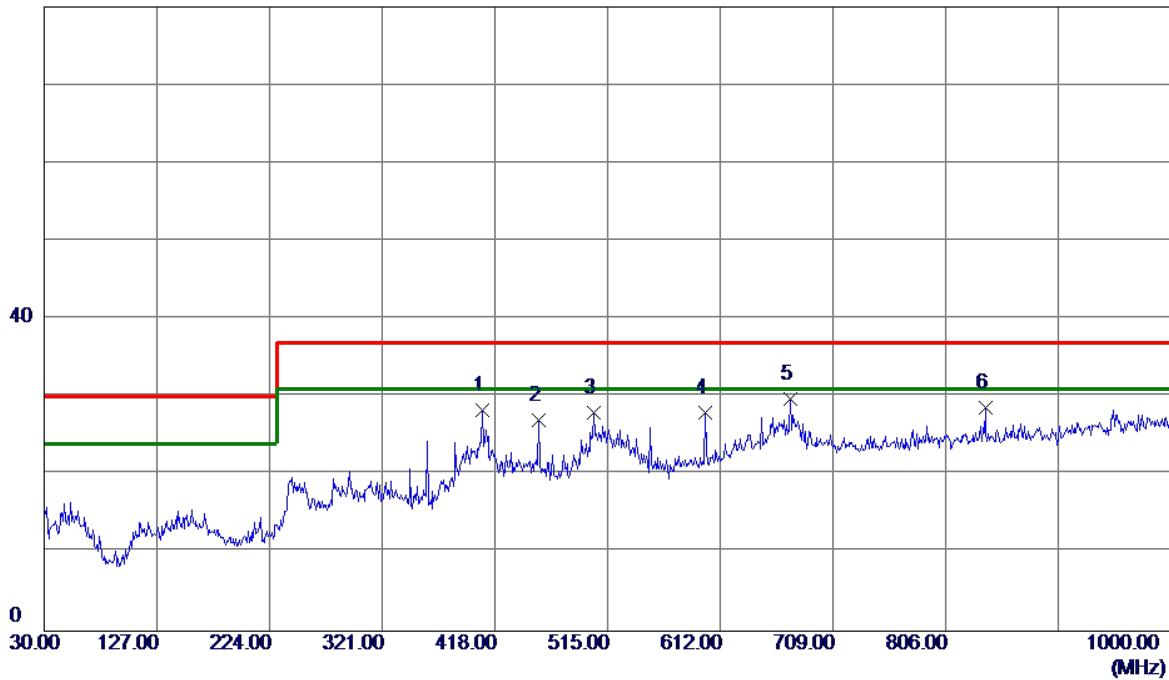

No.	Freq. MHz	Reading Level dBuV/m	Correct Factor dB	Measure ment dBuV/m	Limit dBuV/m	Margin dB	Detector
1	407.3299	41.01	-12.63	28.38	37.00	-8.62	QP
2	455.8300	38.39	-11.30	27.09	37.00	-9.91	QP
3	503.3600	38.51	-10.47	28.04	37.00	-8.96	QP
4	599.3900	36.42	-8.46	27.96	37.00	-9.04	QP
5 *	672.1400	37.27	-7.51	29.76	37.00	-7.24	QP
6	839.9500	33.94	-5.37	28.57	37.00	-8.43	QP

3.2 RADIATED EMISSION ABOVE 1 GHZ

3.2.1 LIMITS

Class B equipment above 1000MHz

Frequency MHz	Measurement		Class B limit dB(uV/m)
	Distance m	Detector type/bandwidth	FSOATS
1000-3000	3	Average / 1 MHz	50
3000-6000			54
1000-3000		Peak / 1 MHz	70
3000-6000			74

Notes:

- (1) The limit for radiated test was performed according to as following: EN 55032
- (2) The tighter limit applies at the band edges.
- (3) Emission level (dBuV/m)=20log Emission level (uV/m).
- (4) The test result calculated as following:
 Measurement Value = Reading Level + Correct Factor
 Correct Factor = Antenna Factor + Cable Loss - Amplifier Gain(if use)
 Margin Level = Measurement Value - Limit Value

Required highest frequency for radiated measurement

Highest internal frequency (F_x) MHz	Highest measured frequency MHz
$F_x \leq 108$	1000
$108 < F_x \leq 500$	2000
$500 < F_x \leq 1000$	5000
$F_x > 1000$	5 th up to a maximum 6 GHz,

Note for FM and TV broadcast receiver, F_x is determined from the highest frequency generated or used excluding the local oscillator and tuned frequencies.

3.2.2 MEASUREMENT INSTRUMENTS LIST

Above 1GHz:

Item	Kind of Equipment	Manufacturer	Type No.	Series Model	Calibrated until
1	Horn Antenna	EMCO	3115	9605-4803	Mar. 23, 2020
2	Amplifier	Agilent	8449B	3008A02584	Aug. 03, 2020
3	MXE EMI Receiver	Agilent	N9038A	MY53220133	Mar. 10, 2020
4	Measurement Software	Farad	EZ-EMC Ver.BTL-2ANT-1	N/A	N/A
5	Multi-Device Controller	ETS-Lindgren	2090	N/A	N/A
6	Controller	MF	MF-7802	MF780208159	N/A
7	Cable	Mlcable Inc.	B10-01-01-5M	18047123	Mar. 01, 2020
8	Cable	Mlcable Inc.	B10-01-01-10 M	18072746	Mar. 01, 2020
9	Cable	N/A	A50-3.5M3.5M -1.5M-AT	18041824	Mar. 01, 2020

Remark: "N/A" denotes no model no., no serial no. or no calibration specified.

All calibration period of equipment list is one year.

3.2.3 TEST PROCEDURE

- a. The measuring distance of 3 m shall be used for measurements. The EUT was placed on the top of a rotating table 0.8 meter above the ground at a 10 meter semi-anechoic chamber. The table was rotated 360 degrees to determine the position of the highest radiation.(above 1GHz)
- b. The height of the equipment or of the substitution antenna shall be 0.8 m, the height of the test antenna shall vary between 1 m to 4 m. Both horizontal and vertical polarizations of the antenna are set to make the measurement.
- c. The initial step in collecting radiated emission data is a receiver peak detector mode pre-scanning the measurement frequency range. Significant peaks are then marked and then Quasi Peak detector mode re-measured.
- d. All readings are Peak Mode value unless otherwise stated AVG in column of Note. If the Peak Mode Measured value compliance with the Peak Limits and lower than AVG Limits, the EUT shall be deemed to meet both Peak & AVG Limits and then only Peak Mode was measured, but AVG Mode didn't perform. (above 1GHz)
- f. For the actual test configuration, please refer to the related Item - Block Diagram of system tested.

3.2.4 DEVIATION FROM TEST STANDARD

No deviation

3.2.5 TEST SETUP

ABOVE 1 GHZ

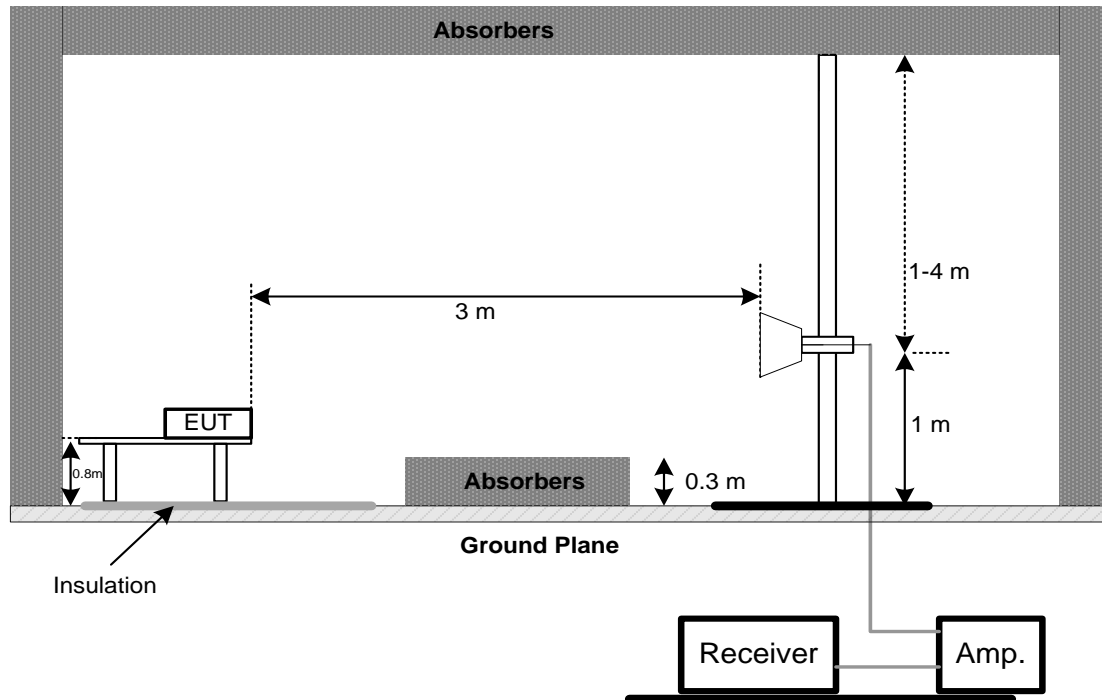

3.2.6 MEASUREMENT DISTANCE

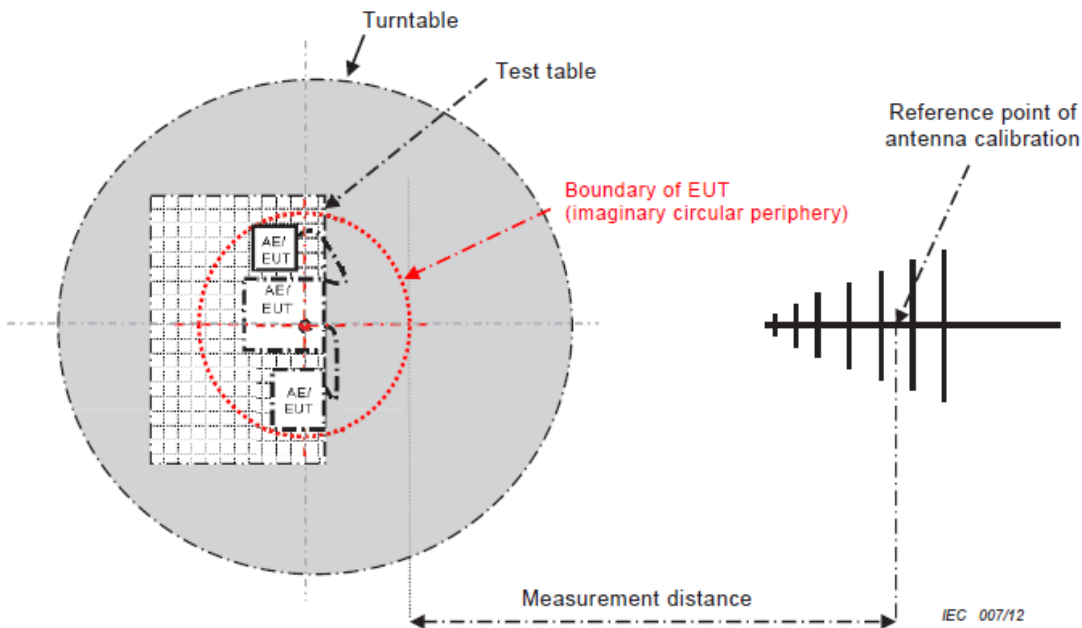

- 34 -

CISPR 32 © IEC:2012

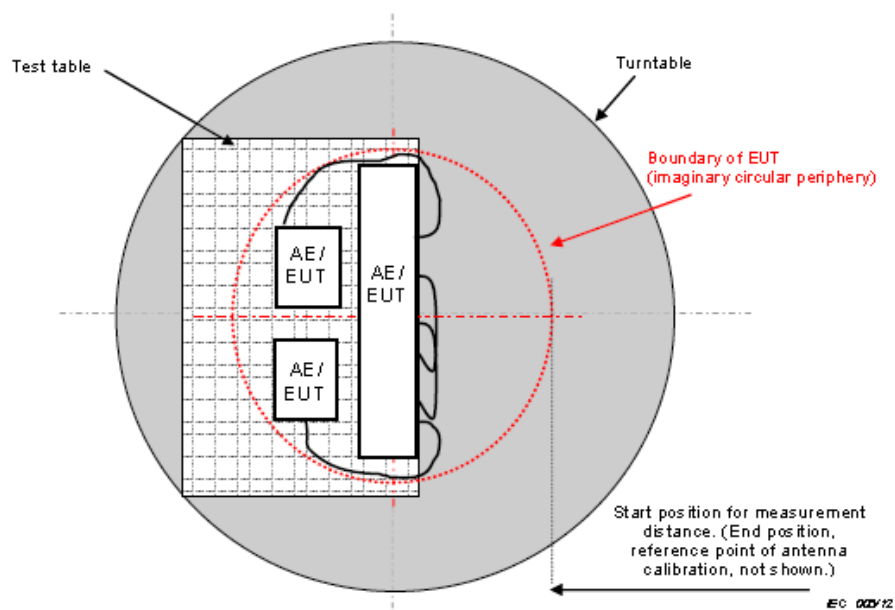
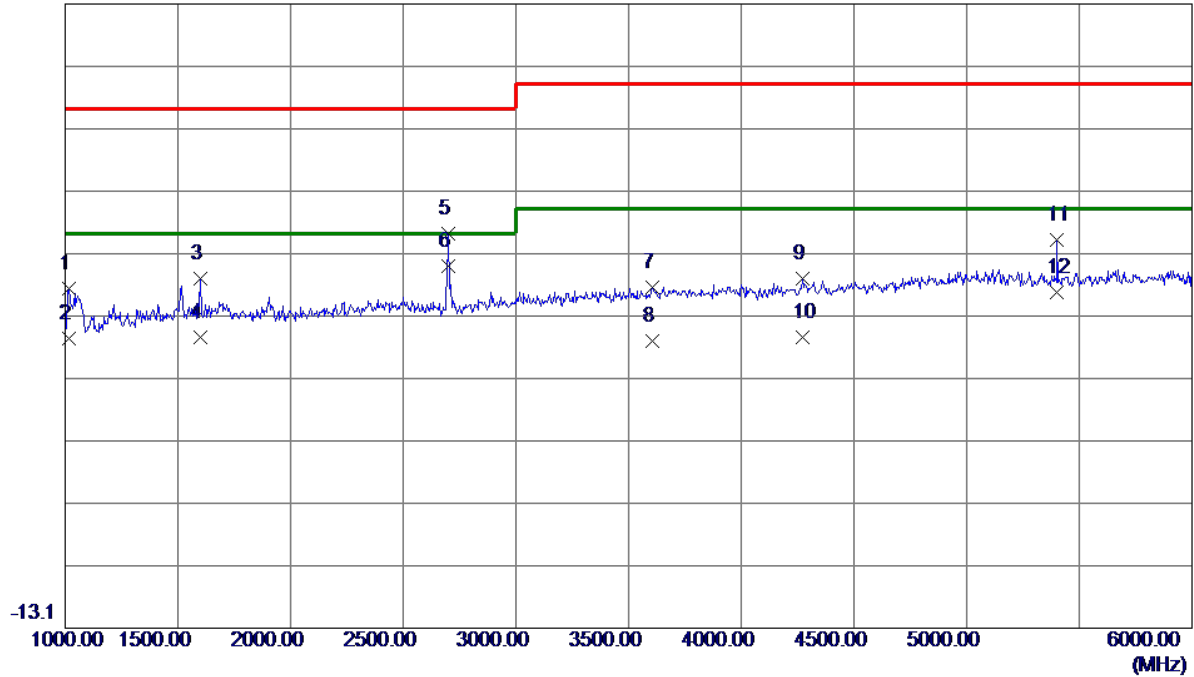

Figure C.2 – Boundary of EUT, Local AE and associated cabling

3.2.7 TEST RESULTS (ABOVE 1 GHZ)

Test Voltage	AC 230V/50Hz	Polarization	Vertical
Test Mode	HDMI1 3440*1440/100Hz		

86.9 dBuV/m



No.	Freq. MHz	Reading Level dBuV/m	Correct Factor dB	Measure ment dBuV/m	Limit dBuV/m	Margin dB	Detector
1	1015.0000	48.27	-6.95	41.32	70.00	-28.68	Peak
2	1015.0000	40.31	-6.95	33.36	50.00	-16.64	AVG
3	1600.0000	46.11	-3.22	42.89	70.00	-27.11	Peak
4	1600.0000	36.81	-3.22	33.59	50.00	-16.41	AVG
5	2700.0000	49.34	0.75	50.09	70.00	-19.91	Peak
6 *	2700.0000	44.20	0.75	44.95	50.00	-5.05	AVG
7	3607.5000	37.95	3.59	41.54	74.00	-32.46	Peak
8	3607.5000	29.23	3.59	32.82	54.00	-21.18	AVG
9	4270.0000	37.58	5.25	42.83	74.00	-31.17	Peak
10	4270.0000	28.34	5.25	33.59	54.00	-20.41	AVG
11	5400.0000	41.01	8.05	49.06	74.00	-24.94	Peak
12	5400.0000	32.66	8.05	40.71	54.00	-13.29	AVG

Test Voltage	AC 230V/50Hz	Polarization	Horizontal
Test Mode	HDMI1 3440*1440/100Hz		

86.9 dBuV/m

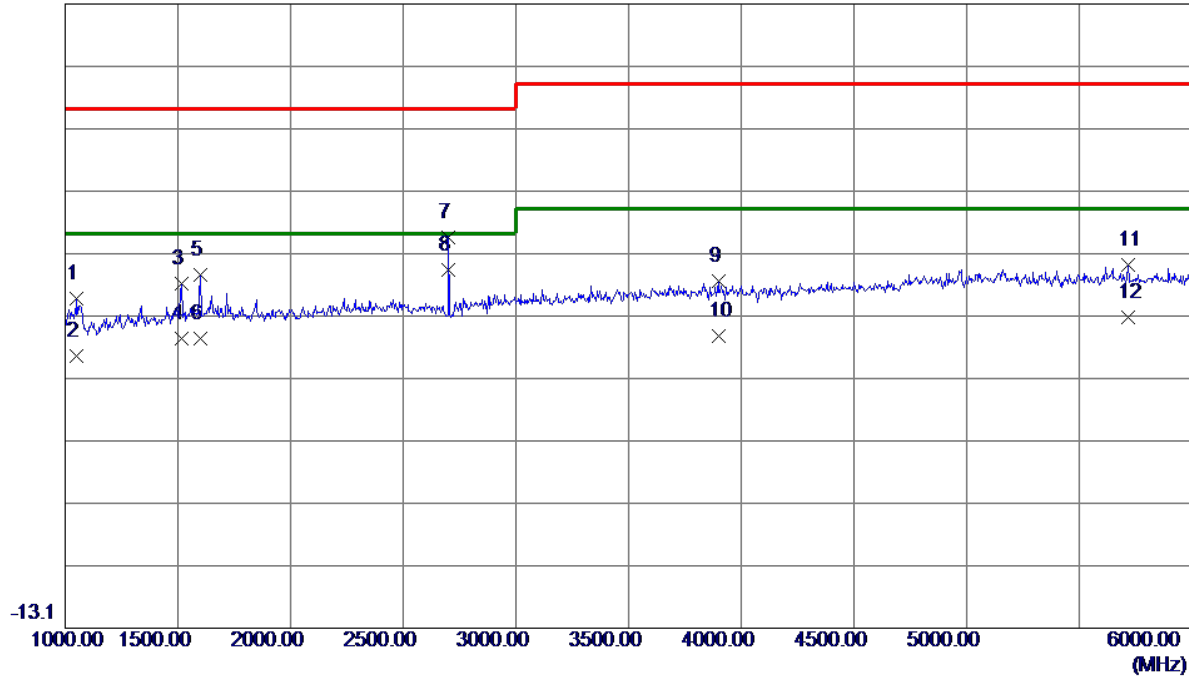

No.	Freq. MHz	Reading Level dBuV/m	Correct Factor dB	Measure ment dBuV/m	Limit dBuV/m	Margin dB	Detector
1	1052.5000	46.36	-6.68	39.68	70.00	-30.32	Peak
2	1052.5000	37.20	-6.68	30.52	50.00	-19.48	AVG
3	1515.0000	45.70	-3.51	42.19	70.00	-27.81	Peak
4	1515.0000	36.89	-3.51	33.38	50.00	-16.62	AVG
5	1600.0000	46.70	-3.22	43.48	70.00	-26.52	Peak
6	1600.0000	36.61	-3.22	33.39	50.00	-16.61	AVG
7	2700.0000	48.78	0.75	49.53	70.00	-20.47	Peak
8 *	2700.0000	43.51	0.75	44.26	50.00	-5.74	AVG
9	3897.5000	38.14	4.45	42.59	74.00	-31.41	Peak
10	3897.5000	29.31	4.45	33.76	54.00	-20.24	AVG
11	5715.0000	36.58	8.51	45.09	74.00	-28.91	Peak
12	5715.0000	28.10	8.51	36.61	54.00	-17.39	AVG

Test Voltage	AC 230V/50Hz	Polarization	Vertical
Test Mode	HDMI1 2160P		

86.9 dBuV/m

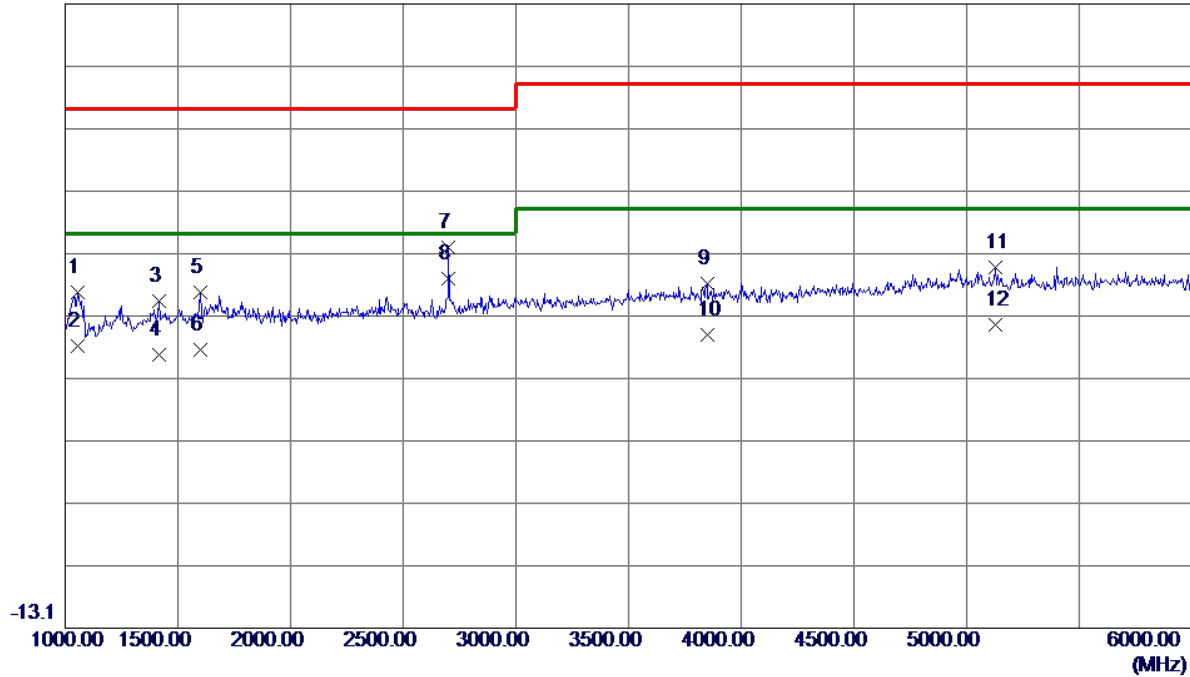

No.	Freq. MHz	Reading Level dBuV/m	Correct Factor dB	Measure ment dBuV/m	Limit dBuV/m	Margin dB	Detector
1	1055.0000	47.41	-6.67	40.74	70.00	-29.26	Peak
2	1055.0000	38.83	-6.67	32.16	50.00	-17.84	AVG
3	1415.0000	43.45	-4.15	39.30	70.00	-30.70	Peak
4	1415.0000	34.84	-4.15	30.69	50.00	-19.31	AVG
5	1597.5000	43.92	-3.23	40.69	70.00	-29.31	Peak
6	1597.5000	34.82	-3.23	31.59	50.00	-18.41	AVG
7	2700.0000	47.09	0.75	47.84	70.00	-22.16	Peak
8 *	2700.0000	42.12	0.75	42.87	50.00	-7.13	AVG
9	3847.5000	37.85	4.31	42.16	74.00	-31.84	Peak
10	3847.5000	29.52	4.31	33.83	54.00	-20.17	AVG
11	5127.5000	36.88	7.79	44.67	74.00	-29.33	Peak
12	5127.5000	27.75	7.79	35.54	54.00	-18.46	AVG

Test Voltage	AC 230V/50Hz	Polarization	Horizontal
Test Mode	HDMI1 2160P		

86.9 dBuV/m

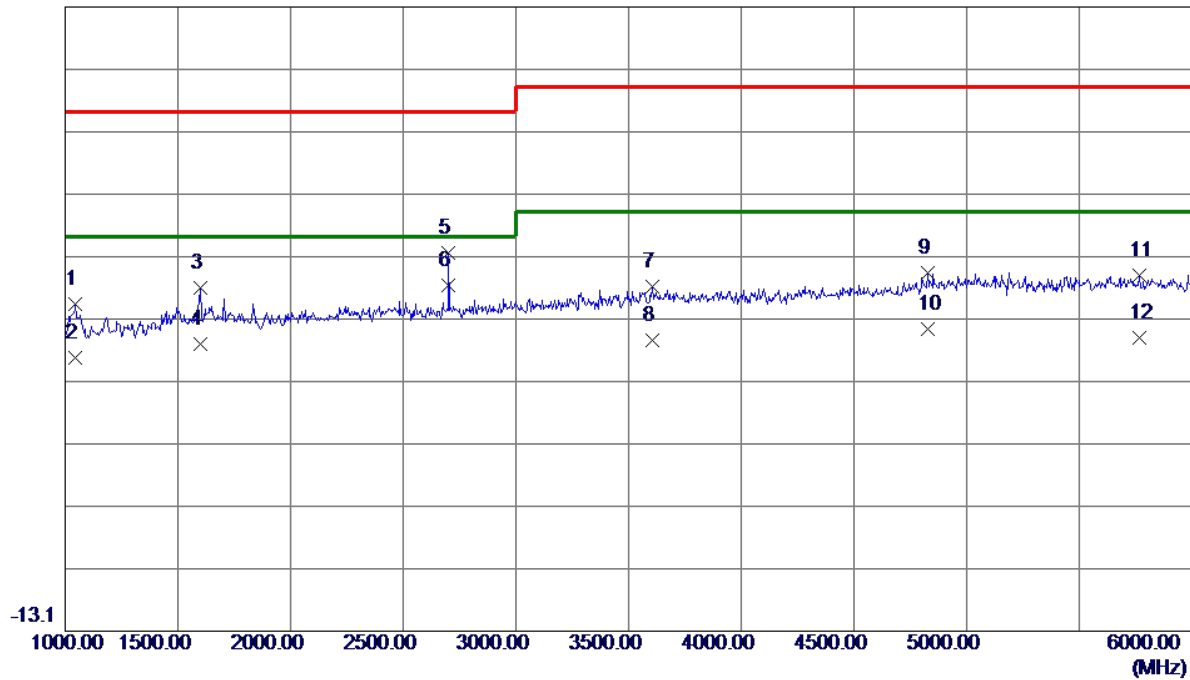

No.	Freq. MHz	Reading Level dBuV/m	Correct Factor dB	Measure ment dBuV/m	Limit dBuV/m	Margin dB	Detector
1	1045.0000	46.01	-6.74	39.27	70.00	-30.73	Peak
2	1045.0000	37.41	-6.74	30.67	50.00	-19.33	AVG
3	1600.0000	45.07	-3.22	41.85	70.00	-28.15	Peak
4	1600.0000	36.07	-3.22	32.85	50.00	-17.15	AVG
5	2700.0000	46.77	0.75	47.52	70.00	-22.48	Peak
6 *	2700.0000	41.56	0.75	42.31	50.00	-7.69	AVG
7	3607.5000	38.47	3.59	42.06	74.00	-31.94	Peak
8	3607.5000	29.94	3.59	33.53	54.00	-20.47	AVG
9	4827.5000	37.29	6.98	44.27	74.00	-29.73	Peak
10	4827.5000	28.27	6.98	35.25	54.00	-18.75	AVG
11	5765.0000	35.28	8.60	43.88	74.00	-30.12	Peak
12	5765.0000	25.23	8.60	33.83	54.00	-20.17	AVG

Test Voltage	AC 230V/50Hz	Polarization	Vertical
Test Mode	DP 3440*1440/144Hz		

86.9 dBuV/m

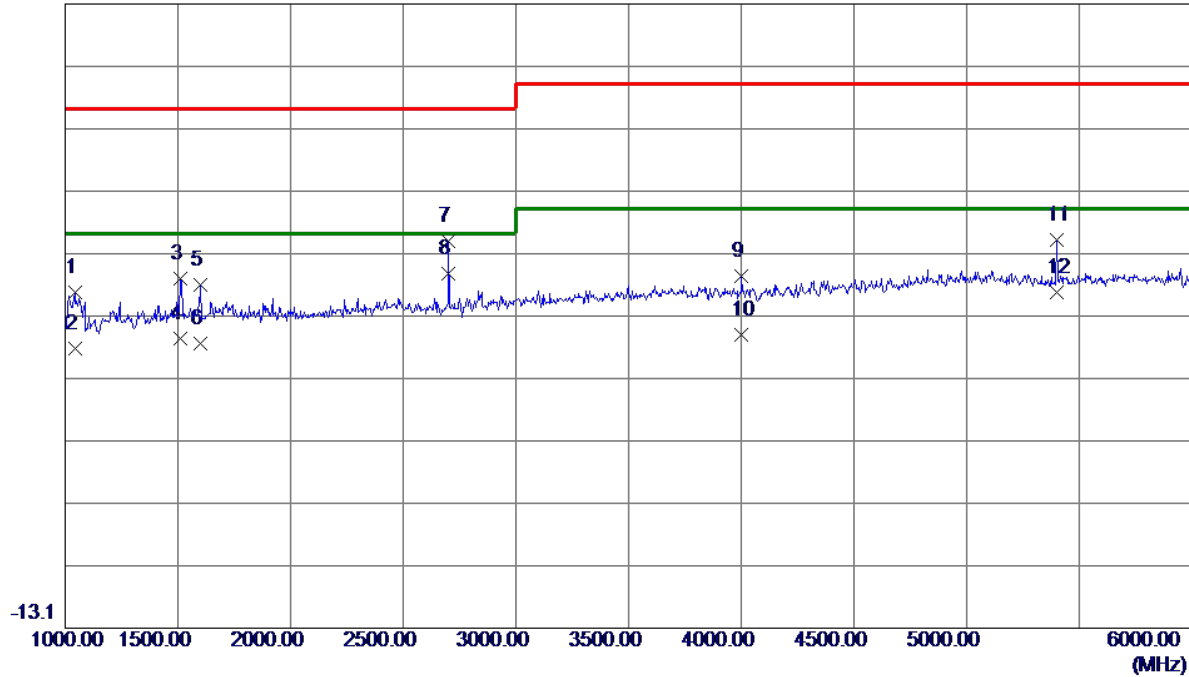

No.	Freq. MHz	Reading Level dBuV/m	Correct Factor dB	Measure ment dBuV/m	Limit dBuV/m	Margin dB	Detector
1	1042.5000	47.50	-6.75	40.75	70.00	-29.25	Peak
2	1042.5000	38.46	-6.75	31.71	50.00	-18.29	AVG
3	1512.5000	46.40	-3.52	42.88	70.00	-27.12	Peak
4	1512.5000	36.75	-3.52	33.23	50.00	-16.77	AVG
5	1600.0000	45.08	-3.22	41.86	70.00	-28.14	Peak
6	1600.0000	35.70	-3.22	32.48	50.00	-17.52	AVG
7	2700.0000	48.11	0.75	48.86	70.00	-21.14	Peak
8 *	2700.0000	42.86	0.75	43.61	50.00	-6.39	AVG
9	4000.0000	38.56	4.76	43.32	74.00	-30.68	Peak
10	4000.0000	29.16	4.76	33.92	54.00	-20.08	AVG
11	5400.0000	41.08	8.05	49.13	74.00	-24.87	Peak
12	5400.0000	32.63	8.05	40.68	54.00	-13.32	AVG

Test Voltage	AC 230V/50Hz	Polarization	Horizontal
Test Mode	DP 3440*1440/144Hz		

86.9 dBuV/m

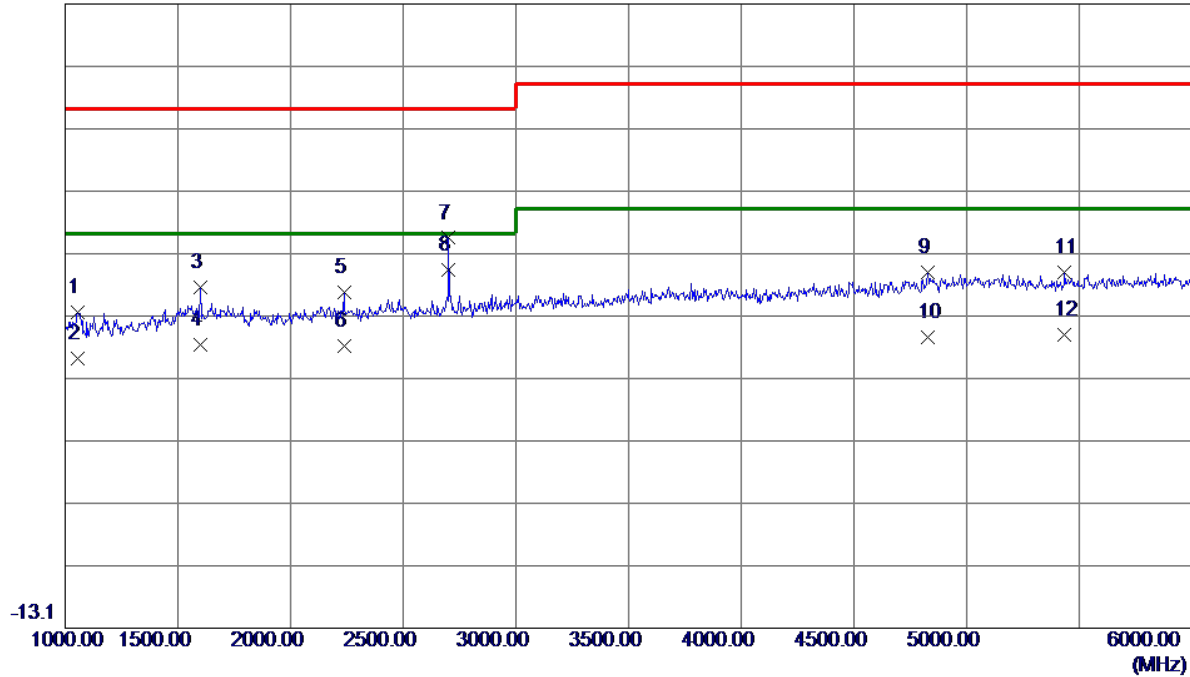

No.	Freq. MHz	Reading Level dBuV/m	Correct Factor dB	Measure ment dBuV/m	Limit dBuV/m	Margin dB	Detector
1	1055.0000	44.10	-6.67	37.43	70.00	-32.57	Peak
2	1055.0000	36.76	-6.67	30.09	50.00	-19.91	AVG
3	1600.0000	44.80	-3.22	41.58	70.00	-28.42	Peak
4	1600.0000	35.48	-3.22	32.26	50.00	-17.74	AVG
5	2237.5000	41.56	-0.88	40.68	70.00	-29.32	Peak
6	2237.5000	33.04	-0.88	32.16	50.00	-17.84	AVG
7	2700.0000	48.65	0.75	49.40	70.00	-20.60	Peak
8 *	2700.0000	43.59	0.75	44.34	50.00	-5.66	AVG
9	4827.5000	36.87	6.98	43.85	74.00	-30.15	Peak
10	4827.5000	26.56	6.98	33.54	54.00	-20.46	AVG
11	5435.0000	35.88	8.08	43.96	74.00	-30.04	Peak
12	5435.0000	25.74	8.08	33.82	54.00	-20.18	AVG

Test Voltage	AC 110V/60Hz	Polarization	Vertical
Test Mode	HDMI1 3440*1440/100Hz		

86.9 dBuV/m

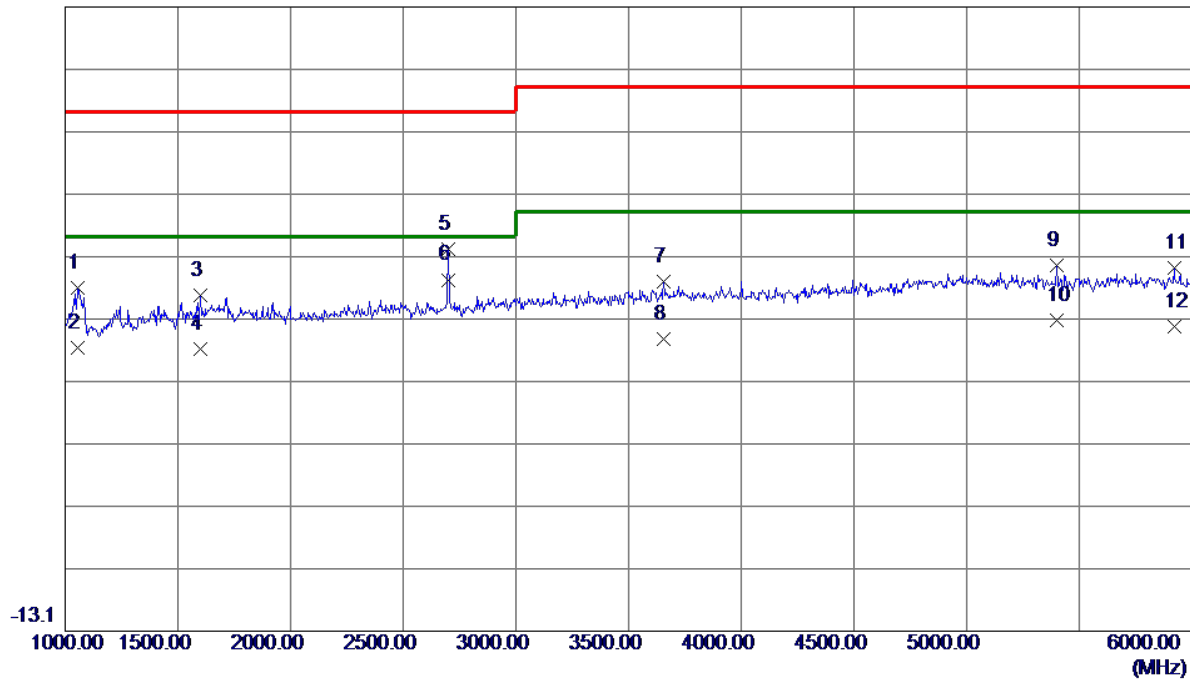

No.	Freq. MHz	Reading Level dBuV/m	Correct Factor dB	Measure ment dBuV/m	Limit dBuV/m	Margin dB	Detector
1	1055.0000	48.58	-6.67	41.91	70.00	-28.09	Peak
2	1055.0000	38.90	-6.67	32.23	50.00	-17.77	AVG
3	1597.5000	43.84	-3.23	40.61	70.00	-29.39	Peak
4	1597.5000	35.37	-3.23	32.14	50.00	-17.86	AVG
5	2700.0000	47.34	0.75	48.09	70.00	-21.91	Peak
6 *	2700.0000	42.45	0.75	43.20	50.00	-6.80	AVG
7	3655.0000	39.16	3.73	42.89	74.00	-31.11	Peak
8	3655.0000	29.95	3.73	33.68	54.00	-20.32	AVG
9	5400.0000	37.47	8.05	45.52	74.00	-28.48	Peak
10	5400.0000	28.67	8.05	36.72	54.00	-17.28	AVG
11	5920.0000	36.27	8.86	45.13	74.00	-28.87	Peak
12	5920.0000	26.79	8.86	35.65	54.00	-18.35	AVG

Test Voltage	AC 110V/60Hz	Polarization	Horizontal
Test Mode	HDMI1 3440*1440/100Hz		

86.9 dBuV/m

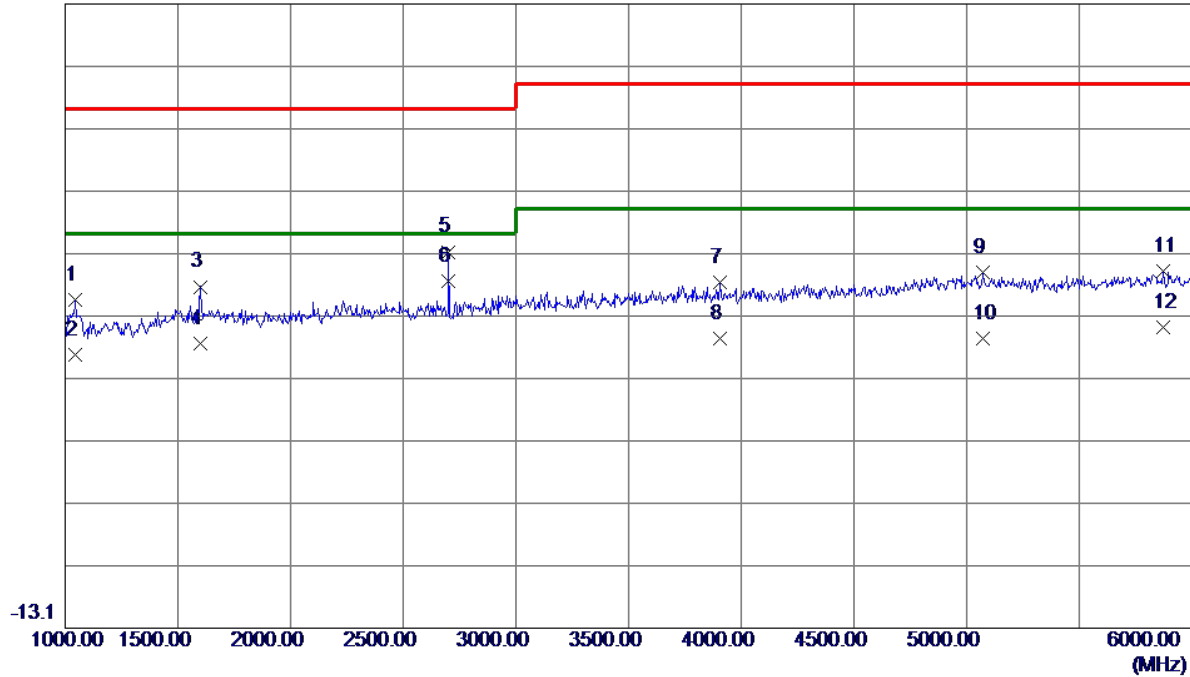

No.	Freq. MHz	Reading Level dBuV/m	Correct Factor dB	Measure ment dBuV/m	Limit dBuV/m	Margin dB	Detector
1	1045.0000	46.27	-6.74	39.53	70.00	-30.47	Peak
2	1045.0000	37.40	-6.74	30.66	50.00	-19.34	AVG
3	1597.5000	44.83	-3.23	41.60	70.00	-28.40	Peak
4	1597.5000	35.82	-3.23	32.59	50.00	-17.41	AVG
5	2700.0000	46.45	0.75	47.20	70.00	-22.80	Peak
6 *	2700.0000	41.83	0.75	42.58	50.00	-7.42	AVG
7	3907.5000	37.79	4.48	42.27	74.00	-31.73	Peak
8	3907.5000	28.89	4.48	33.37	54.00	-20.63	AVG
9	5070.0000	36.25	7.74	43.99	74.00	-30.01	Peak
10	5070.0000	25.54	7.74	33.28	54.00	-20.72	AVG
11	5870.0000	35.34	8.78	44.12	74.00	-29.88	Peak
12	5870.0000	26.41	8.78	35.19	54.00	-18.81	AVG

3.3 CONDUCTED EMISSION MEASUREMENT AT AC MAINS POWER PORTS

3.3.1 LIMITS

Requirements for conducted emissions from AC mains power ports of Class B equipment

Frequency Range MHz	Coupling Device	Detector Type / bandwidth	Class B Limits (dB(μV))
0.15 - 0.5	AMN	Quasi Peak / 9 kHz	66-56
0.5 - 5			56
5 - 30			60
0.15 - 0.5	AMN	Average / 9 kHz	56-46
0.5 - 5			46
5 - 30			50

NOTE:

(1) The test result calculated as following:

Measurement Value = Reading Level + Correct Factor

Correct Factor = Insertion Loss + Cable Loss + Attenuator Factor(if use)

Margin Level = Measurement Value – Limit Value

3.3.2 MEASUREMENT INSTRUMENTS LIST

Item	Kind of Equipment	Manufacturer	Type No.	Series Model	Calibrated until
1	EMI Test Receiver	R&S	ESCI	100382	Mar. 10, 2020
2	LISN	EMCO	3816/2	52765	Mar. 10, 2020
3	TWO-LINE V-NETWORK	R&S	ENV216	101447	May. 19, 2020
4	50Ω Terminator	SHX	TF5-3	15041305	Mar. 10, 2020
5	Measurement Software	Farad	EZ-EMC Ver.NB-03A1 -01	N/A	N/A
6	Cable	N/A	RG223	12m	Mar. 12, 2020

Remark: "N/A" denotes no model name, serial no. or calibration specified.

All calibration period of equipment list is one year.

3.3.3 TEST PROCEDURE

- a. The EUT was placed 0.8 meters from the horizontal ground plane with EUT being connected to the power mains through a line impedance stabilization network (LISN). All other support equipments powered from additional LISN(s). The LISN provide 50 Ohm/ 50uH of coupling impedance for the measuring instrument.
- b. Interconnecting cables that hang closer than 40 cm to the ground plane shall be folded back and forth in the center forming a bundle 30 to 40 cm long.
- c. I/O cables that are not connected to a peripheral shall be bundled in the center. The end of the cable may be terminated, if required, using the correct terminating impedance. The overall length shall not exceed 1 m.
- d. LISN at least 80 cm from nearest part of EUT chassis.
- e. For the actual test configuration, please refer to the related Item –EUT Test Photos.

3.3.4 DEVIATION FROM TEST STANDARD

No deviation

3.3.5 TEST SETUP

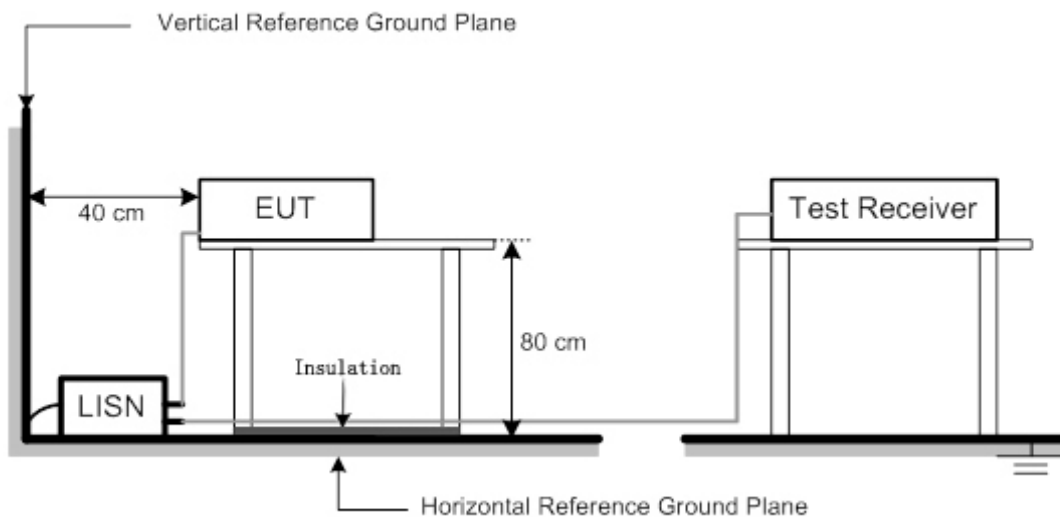

3.3.6 TEST RESULTS

Test Voltage	AC 230V/50Hz	Phase	Line
Test Mode	HDMI1 3440*1440/100Hz		

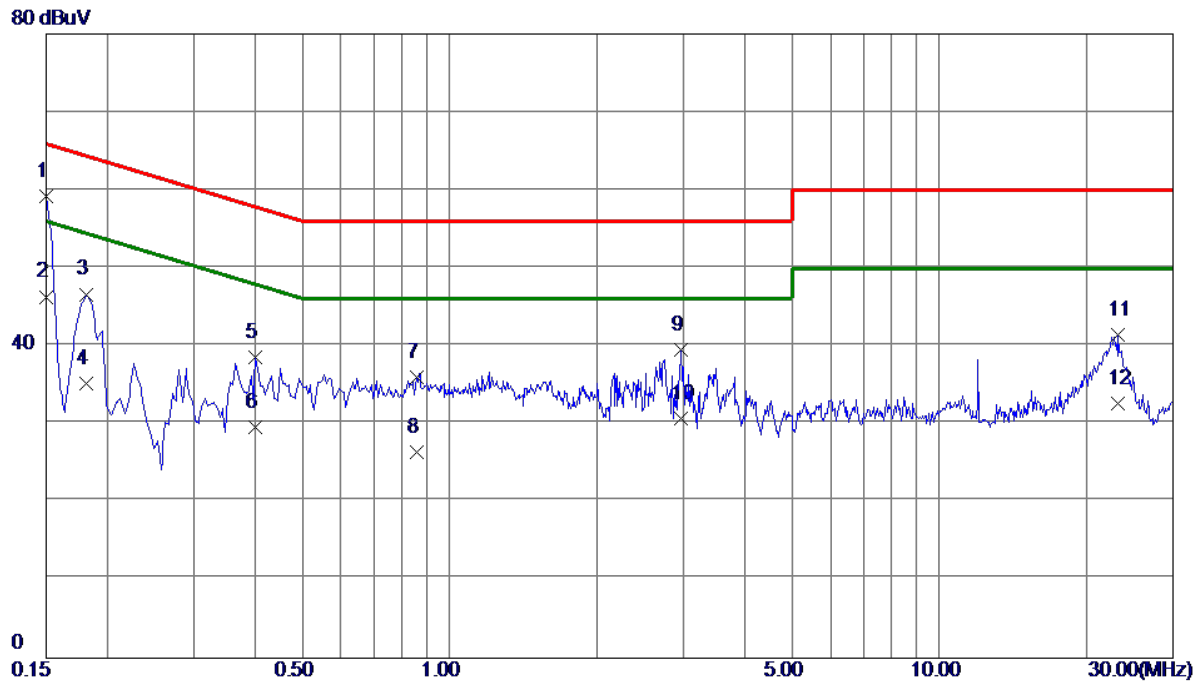

No.	Freq. MHz	Reading Level dBuV	Correct Factor dB	Measure ment dBuV	Limit dBuV	Margin dB	Detector
1 *	0.1500	49.38	9.82	59.20	66.00	-6.80	QP
2	0.1500	36.50	9.82	46.32	56.00	-9.68	AVG
3	0.1815	36.82	9.82	46.64	64.42	-17.78	QP
4	0.1815	25.40	9.82	35.22	54.42	-19.20	AVG
5	0.4020	28.67	9.87	38.54	57.81	-19.27	QP
6	0.4020	19.80	9.87	29.67	47.81	-18.14	AVG
7	0.8565	26.05	9.91	35.96	56.00	-20.04	QP
8	0.8565	16.50	9.91	26.41	46.00	-19.59	AVG
9	2.9670	29.46	10.06	39.52	56.00	-16.48	QP
10	2.9670	20.60	10.06	30.66	46.00	-15.34	AVG
11	23.1405	30.28	11.15	41.43	60.00	-18.57	QP
12	23.1405	21.50	11.15	32.65	50.00	-17.35	AVG

Test Voltage	AC 230V/50Hz	Phase	Neutral
Test Mode	HDMI1 3440*1440/100Hz		

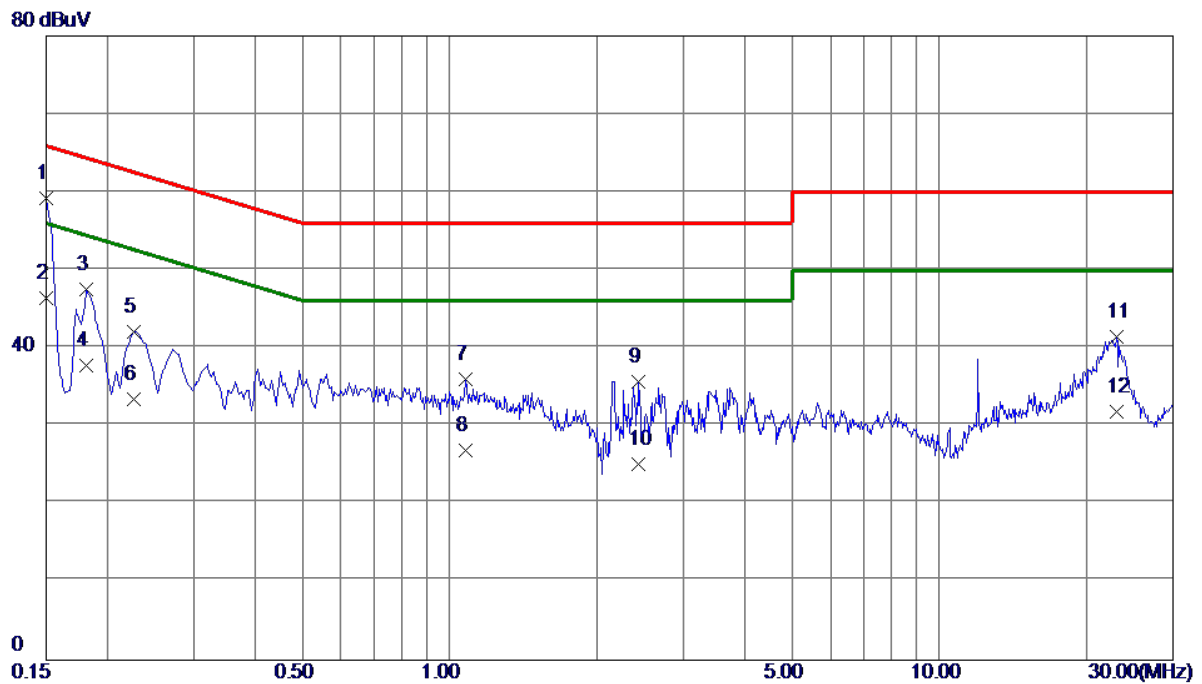

No.	Freq. MHz	Reading Level dBuV	Correct Factor dB	Measure ment dBuV	Limit dBuV	Margin dB	Detector
1 *	0.1500	49.22	9.91	59.13	66.00	-6.87	QP
2	0.1500	36.50	9.91	46.41	56.00	-9.59	AVG
3	0.1815	37.56	9.91	47.47	64.42	-16.95	QP
4	0.1815	27.80	9.91	37.71	54.42	-16.71	AVG
5	0.2265	32.20	9.91	42.11	62.58	-20.47	QP
6	0.2265	23.60	9.91	33.51	52.58	-19.07	AVG
7	1.0770	25.92	10.13	36.05	56.00	-19.95	QP
8	1.0770	16.70	10.13	26.83	46.00	-19.17	AVG
9	2.4360	25.54	10.21	35.75	56.00	-20.25	QP
10	2.4360	14.90	10.21	25.11	46.00	-20.89	AVG
11	23.0009	30.00	11.48	41.48	60.00	-18.52	QP
12	23.0009	20.30	11.48	31.78	50.00	-18.22	AVG

Test Voltage	AC 230V/50Hz	Phase	Line
Test Mode	HDMI1 2160P		

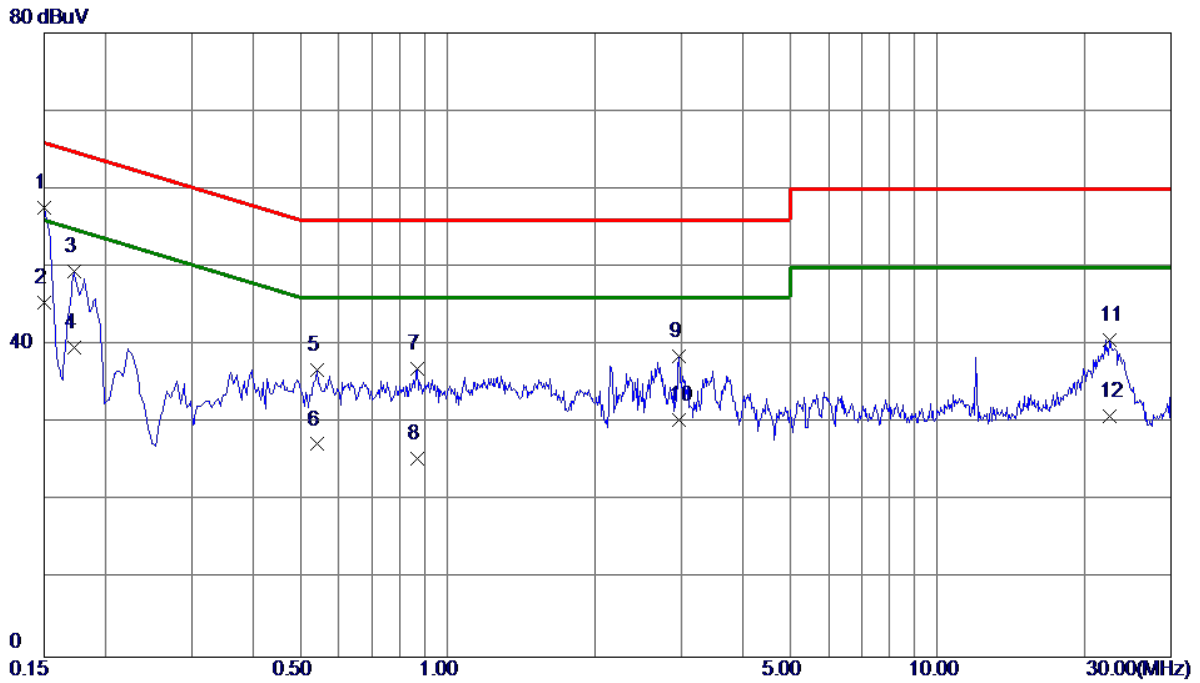

No.	Freq. MHz	Reading Level dBuV	Correct Factor dB	Measure ment dBuV	Limit dBuV	Margin dB	Detector
1 *	0.1500	47.78	9.82	57.60	66.00	-8.40	QP
2	0.1500	35.60	9.82	45.42	56.00	-10.58	AVG
3	0.1725	39.56	9.82	49.38	64.84	-15.46	QP
4	0.1725	29.80	9.82	39.62	54.84	-15.22	AVG
5	0.5414	26.98	9.88	36.86	56.00	-19.14	QP
6	0.5414	17.40	9.88	27.28	46.00	-18.72	AVG
7	0.8654	27.09	9.91	37.00	56.00	-19.00	QP
8	0.8654	15.60	9.91	25.51	46.00	-20.49	AVG
9	2.9670	28.49	10.06	38.55	56.00	-17.45	QP
10	2.9670	20.40	10.06	30.46	46.00	-15.54	AVG
11	22.4475	29.53	11.16	40.69	60.00	-19.31	QP
12	22.4475	19.70	11.16	30.86	50.00	-19.14	AVG

Test Voltage	AC 230V/50Hz	Phase	Neutral
Test Mode	HDMI1 2160P		

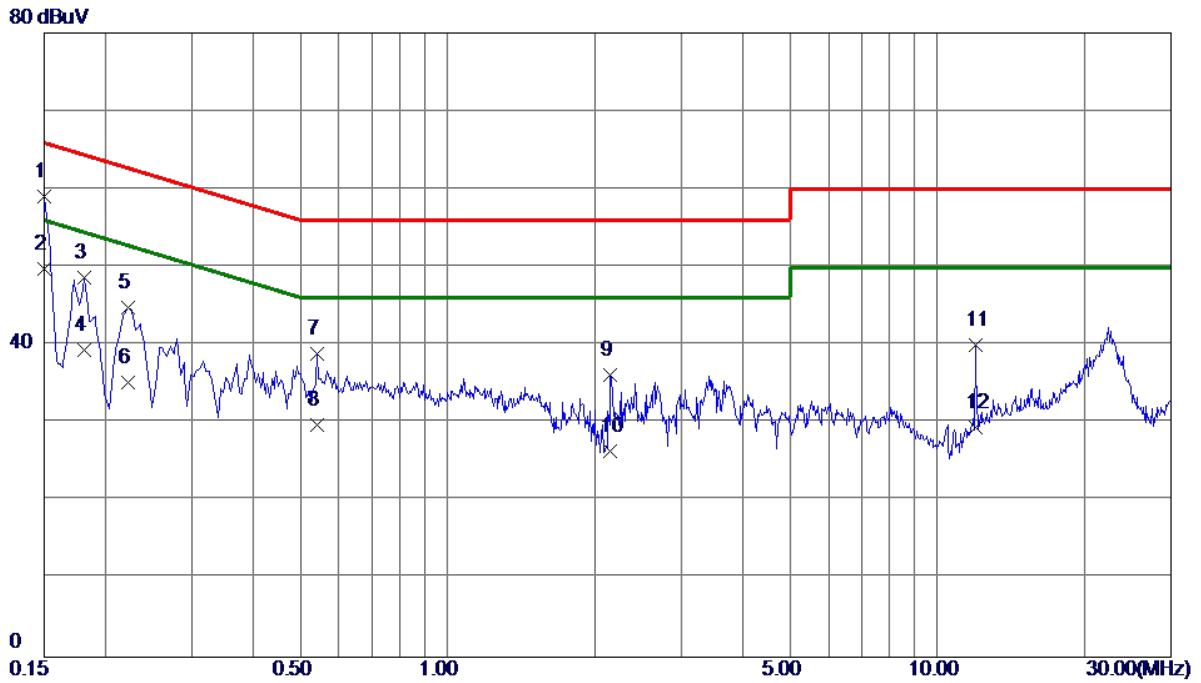

No.	Freq. MHz	Reading Level dBuV	Correct Factor dB	Measure ment dBuV	Limit dBuV	Margin dB	Detector
1	0.1500	49.10	9.91	59.01	66.00	-6.99	QP
2 *	0.1500	39.80	9.91	49.71	56.00	-6.29	AVG
3	0.1815	38.75	9.91	48.66	64.42	-15.76	QP
4	0.1815	29.40	9.91	39.31	54.42	-15.11	AVG
5	0.2220	34.91	9.91	44.82	62.74	-17.92	QP
6	0.2220	25.30	9.91	35.21	52.74	-17.53	AVG
7	0.5415	28.89	10.03	38.92	56.00	-17.08	QP
8	0.5415	19.70	10.03	29.73	46.00	-16.27	AVG
9	2.1525	25.97	10.20	36.17	56.00	-19.83	QP
10	2.1525	16.20	10.20	26.40	46.00	-19.60	AVG
11	11.9940	29.11	10.88	39.99	60.00	-20.01	QP
12	11.9940	18.50	10.88	29.38	50.00	-20.62	AVG

Test Voltage	AC 230V/50Hz	Phase	Line
Test Mode	DP 3440*1440/144Hz		

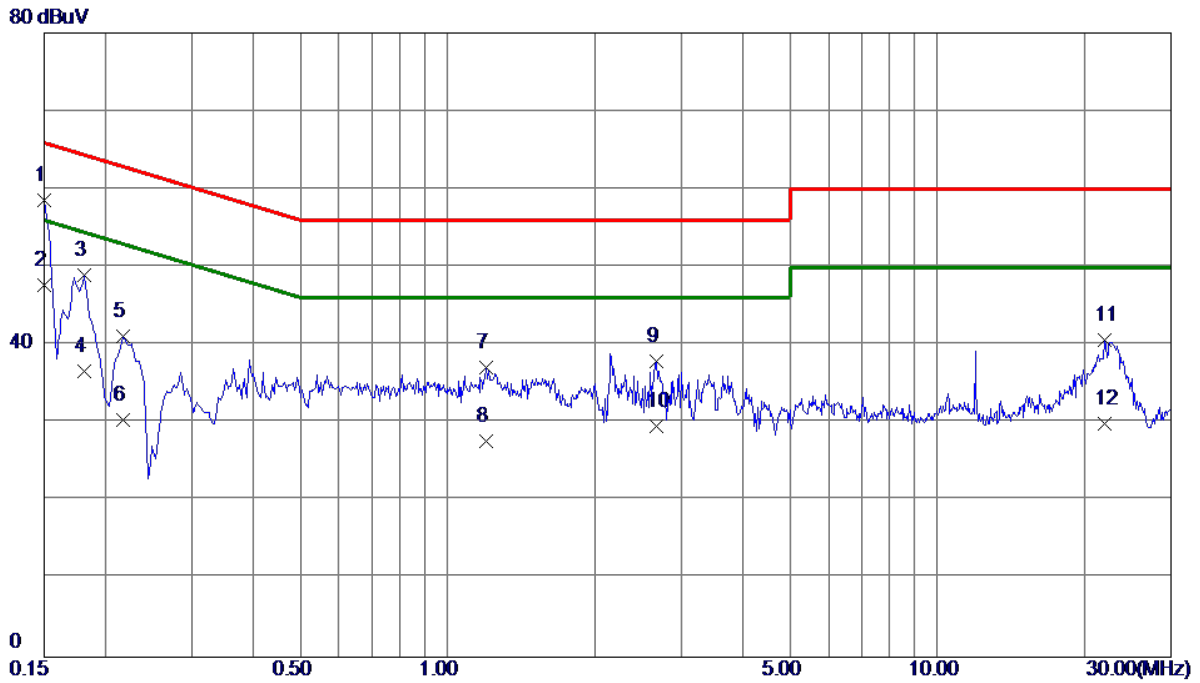

No.	Freq. MHz	Reading Level dBuV	Correct Factor dB	Measure ment dBuV	Limit dBuV	Margin dB	Detector
1 *	0.1500	48.78	9.82	58.60	66.00	-7.40	QP
2	0.1500	37.86	9.82	47.68	56.00	-8.32	AVG
3	0.1815	39.06	9.82	48.88	64.42	-15.54	QP
4	0.1815	26.78	9.82	36.60	54.42	-17.82	AVG
5	0.2175	31.29	9.82	41.11	62.91	-21.80	QP
6	0.2175	20.53	9.82	30.35	52.91	-22.56	AVG
7	1.1985	27.26	9.93	37.19	56.00	-18.81	QP
8	1.1985	17.80	9.93	27.73	46.00	-18.27	AVG
9	2.6655	27.93	10.04	37.97	56.00	-18.03	QP
10	2.6655	19.59	10.04	29.63	46.00	-16.37	AVG
11	21.9030	29.49	11.17	40.66	60.00	-19.34	QP
12	21.9030	18.70	11.17	29.87	50.00	-20.13	AVG

Test Voltage	AC 230V/50Hz	Phase	Neutral
Test Mode	DP 3440*1440/144Hz		

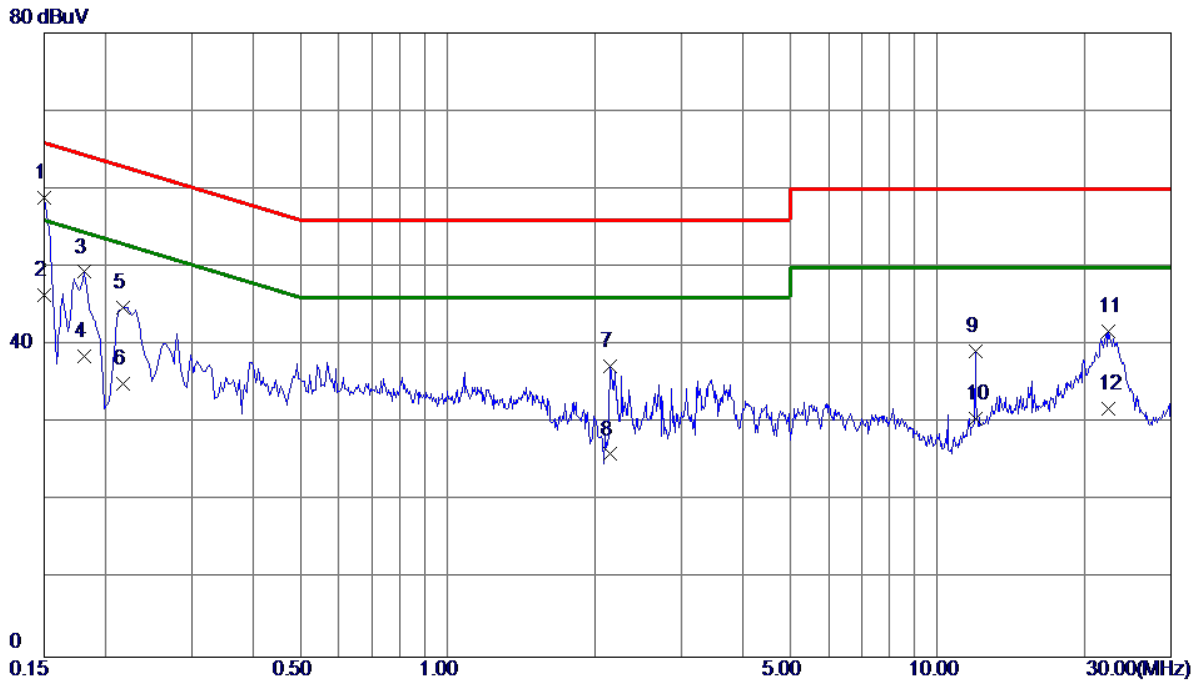

No.	Freq. MHz	Reading Level dBuV	Correct Factor dB	Measure ment dBuV	Limit dBuV	Margin dB	Detector
1 *	0.1500	48.91	9.91	58.82	66.00	-7.18	QP
2	0.1500	36.47	9.91	46.38	56.00	-9.62	AVG
3	0.1815	39.45	9.91	49.36	64.42	-15.06	QP
4	0.1815	28.61	9.91	38.52	54.42	-15.90	AVG
5	0.2175	34.89	9.91	44.80	62.91	-18.11	QP
6	0.2175	25.10	9.91	35.01	52.91	-17.90	AVG
7	2.1480	27.15	10.20	37.35	56.00	-18.65	QP
8	2.1480	15.80	10.20	26.00	46.00	-20.00	AVG
9	11.9895	28.37	10.88	39.25	60.00	-20.75	QP
10	11.9895	19.70	10.88	30.58	50.00	-19.42	AVG
11	22.3035	30.26	11.48	41.74	60.00	-18.26	QP
12	22.3035	20.41	11.48	31.89	50.00	-18.11	AVG

Test Voltage	AC 110V/60Hz	Phase	Line
Test Mode	HDMI1 3440*1440/100Hz		

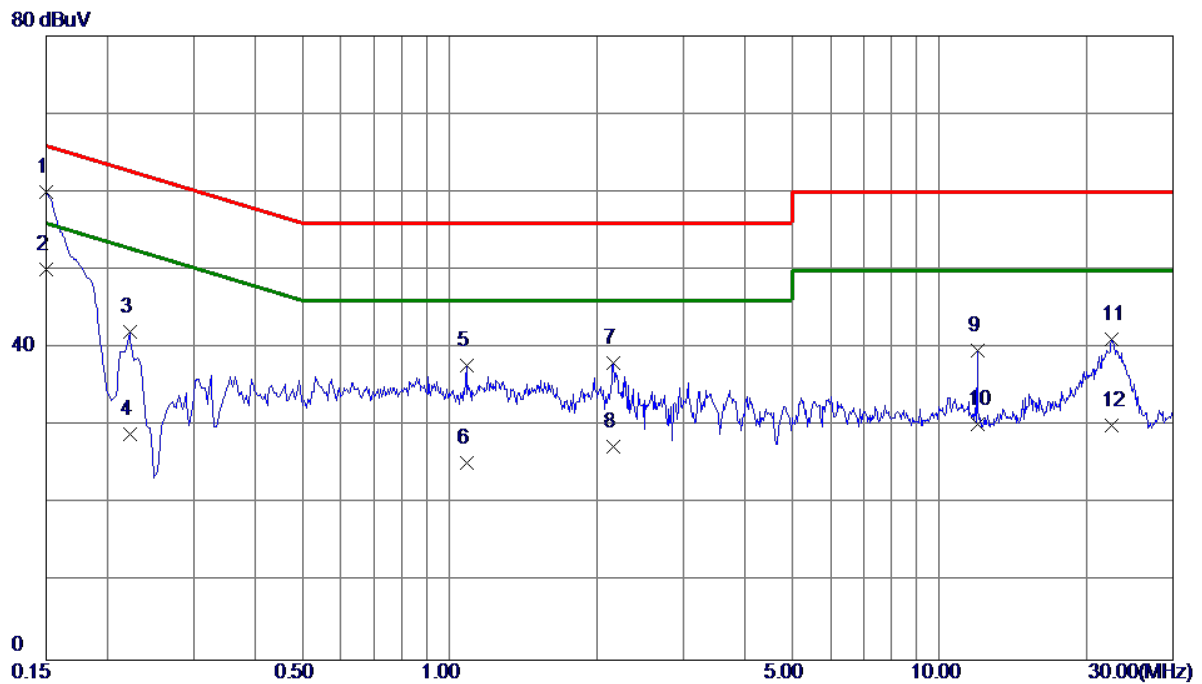

No.	Freq. MHz	Reading Level dBuV	Correct Factor dB	Measure ment dBuV	Limit dBuV	Margin dB	Detector
1	0.1500	50.13	9.82	59.95	66.00	-6.05	QP
2 *	0.1500	40.20	9.82	50.02	56.00	-5.98	AVG
3	0.2220	32.31	9.82	42.13	62.74	-20.61	QP
4	0.2220	19.07	9.82	28.89	52.74	-23.85	AVG
5	1.0814	27.90	9.93	37.83	56.00	-18.17	QP
6	1.0814	15.40	9.93	25.33	46.00	-20.67	AVG
7	2.1570	28.02	10.01	38.03	56.00	-17.97	QP
8	2.1570	17.30	10.01	27.31	46.00	-18.69	AVG
9	11.9895	29.13	10.60	39.73	60.00	-20.27	QP
10	11.9895	19.70	10.60	30.30	50.00	-19.70	AVG
11	22.4295	29.92	11.16	41.08	60.00	-18.92	QP
12	22.4295	18.90	11.16	30.06	50.00	-19.94	AVG

Test Voltage	AC 110V/60Hz	Phase	Neutral
Test Mode	HDMI1 3440*1440/100Hz		

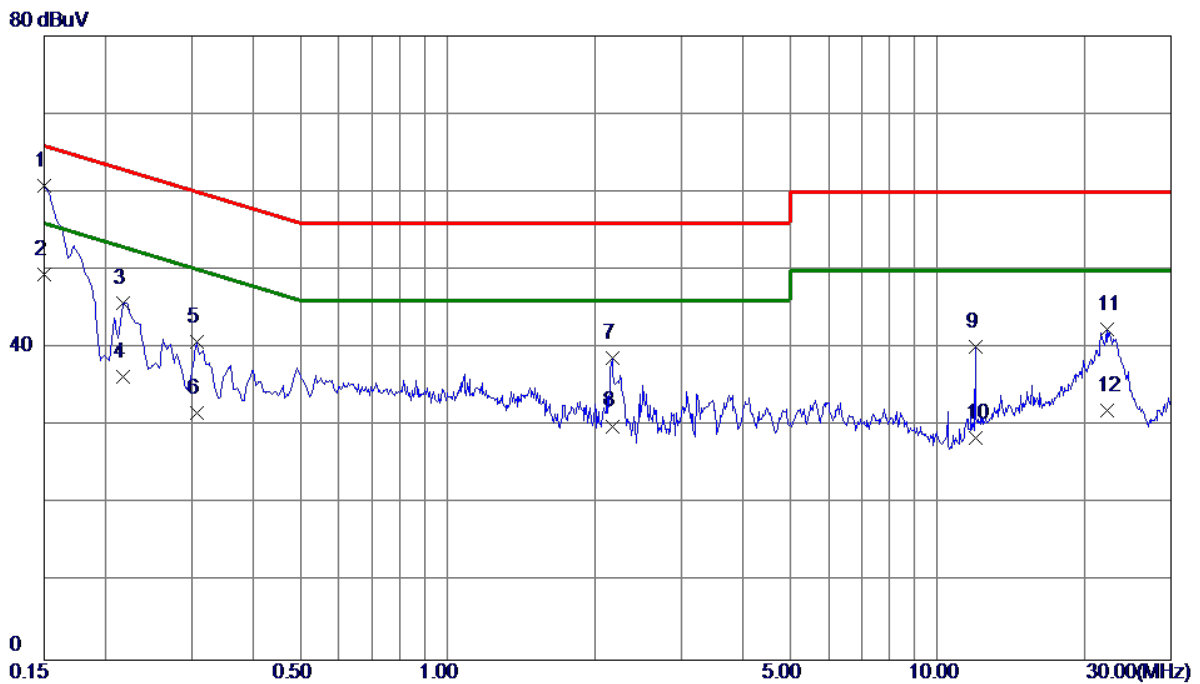

No.	Freq. MHz	Reading Level dBuV	Correct Factor dB	Measure ment dBuV	Limit dBuV	Margin dB	Detector
1 *	0.1500	50.94	9.91	60.85	66.00	-5.15	QP
2	0.1500	39.50	9.91	49.41	56.00	-6.59	AVG
3	0.2175	35.89	9.91	45.80	62.91	-17.11	QP
4	0.2175	26.40	9.91	36.31	52.91	-16.60	AVG
5	0.3075	30.81	9.96	40.77	60.04	-19.27	QP
6	0.3075	21.69	9.96	31.65	50.04	-18.39	AVG
7	2.1660	28.58	10.20	38.78	56.00	-17.22	QP
8	2.1660	19.80	10.20	30.00	46.00	-16.00	AVG
9	11.9895	29.23	10.88	40.11	60.00	-19.89	QP
10	11.9895	17.60	10.88	28.48	50.00	-21.52	AVG
11	22.1640	30.89	11.48	42.37	60.00	-17.63	QP
12	22.1640	20.50	11.48	31.98	50.00	-18.02	AVG

4. EMC EMISSION TEST- EN 55032:2015+AC:2016

4.1 RADIATED EMISSIONS UP TO 1 GHZ

4.1.1 LIMITS

Class B equipment up to 1000MHz

Frequency Range MHz	Measurement			Class B limits dB(μV/m)
	Facility	Distance m	Detector type/ bandwidth	
30 - 230	SAC	10	Quasi peak / 120 kHz	30
230 - 1000				37

Notes:

- (1) The limit for radiated test was performed according to as following: EN 55032
- (2) The tighter limit applies at the band edges.
- (3) Emission level (dBuV/m)=20log Emission level (uV/m).
- (4) The test result calculated as following:
 Measurement Value = Reading Level + Correct Factor
 Correct Factor = Antenna Factor + Cable Loss - Amplifier Gain(if use)
 Margin Level = Measurement Value - Limit Value

4.1.2 MEASUREMENT INSTRUMENTS LIST

Up to 1GHz:

Item	Kind of Equipment	Manufacturer	Type No.	Series Model	Calibrated until
1	Receiver	Keysight	N9038A	MY54450004	Aug. 03, 2020
2	MXE EMI Receiver	Agilent	N9038A	MY53220133	Mar. 10, 2020
3	Pre-Amplifier	EMC INSTRUMENT	EMC 9135	980284	Mar. 10, 2020
4	Pre-Amplifier	EMC INSTRUMENT	EMC 9135	980283	Mar. 10, 2020
5	Trilog-Broadband Antenna	Schwarzbeck	VULB9168	946	Oct. 26, 2020
6	Trilog-Broadband Antenna	Schwarzbeck	VULB9168	947	Oct. 26, 2020
7	Cable	emci	LMR-400(5m+11 m+15m)	N/A	Aug. 06, 2020
8	Cable	emci	LMR-400(5m+8m +8m)	N/A	Aug. 06, 2020
9	Measurement Software	Farad	EZ-EMC Ver.BTL-2ANT-1	N/A	N/A
10	Multi-Device Controller	ETS-Lindgren	2090	N/A	N/A
11	Attenuator	EMCI	EMCI-N-6-06	N0670	Oct. 26, 2020
12	Attenuator	EMCI	EMCI-N-6-06	N0671	Oct. 26, 2020

Remark: "N/A" denotes no model no., no serial no. or no calibration specified.

All calibration period of equipment list is one year.

4.1.3 TEST PROCEDURE

- The measuring distance of 10 m shall be used for measurements. The EUT was placed on the top of a rotating table 0.8 meter above the ground at a 10 meter semi-anechoic chamber. The table was rotated 360 degrees to determine the position of the highest radiation.(below 1GHz).
- The height of the equipment or of the substitution antenna shall be 0.8 m, the height of the test antenna shall vary between 1 m to 4 m. Both horizontal and vertical polarizations of the antenna are set to make the measurement.
- The initial step in collecting radiated emission data is a receiver peak detector mode pre-scanning the measurement frequency range. Significant peaks are then marked and then Quasi Peak detector mode re-measured.
- All readings are Peak unless otherwise stated QP in column of Note. Peak denotes that the Peak reading compliance with the QP Limits and then QP Mode measurement didn't perform.
(below 1GHz)
- For the actual test configuration, please refer to the related Item - Block Diagram of system tested.

4.1.4 DEVIATION FROM TEST STANDARD

No deviation

4.1.5 TEST SETUP

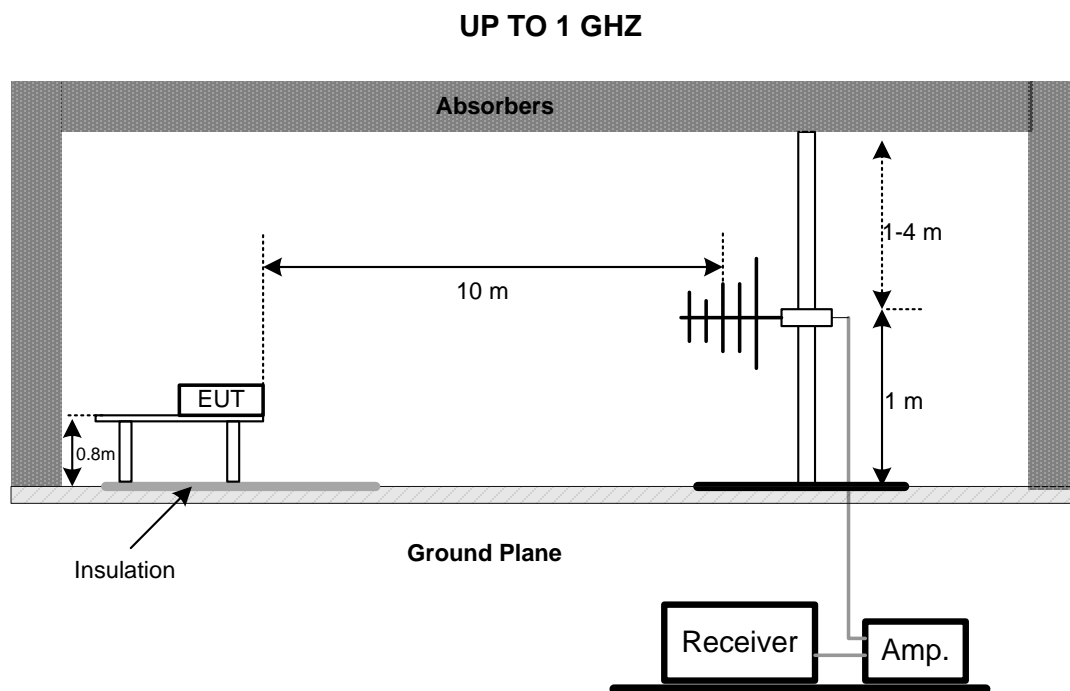

Note: The antenna can be moved between 1 to 4 meters above the ground.

4.1.6 MEASUREMENT DISTANCE

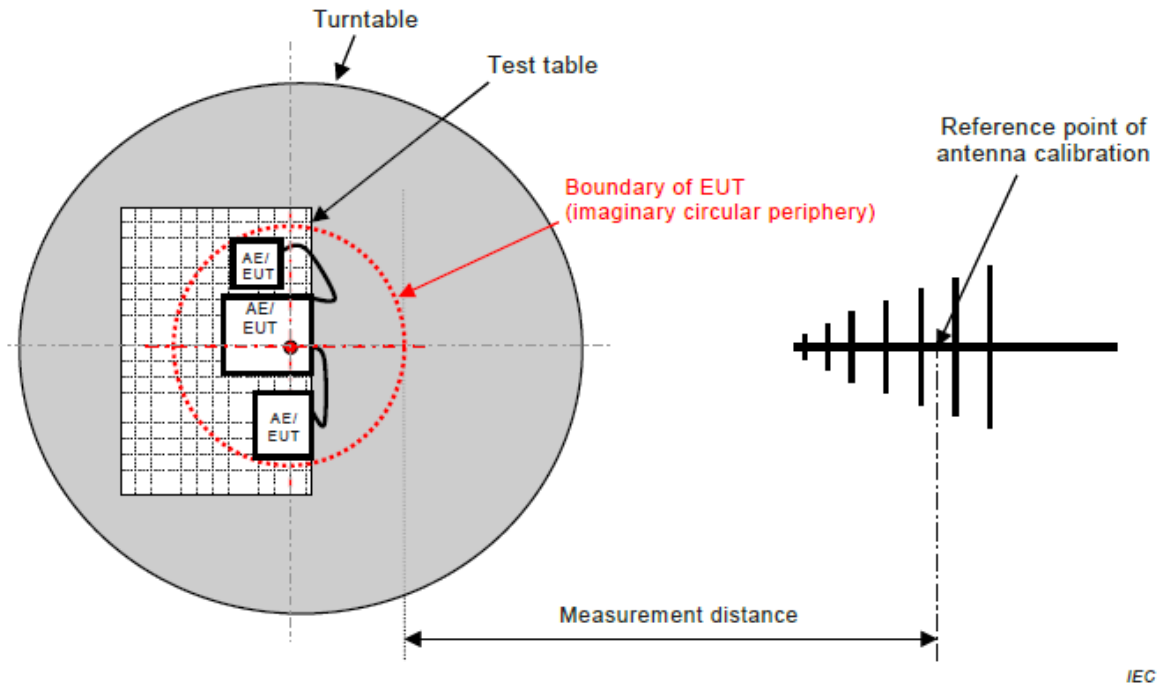

IEC

Figure C.1 – Measurement distance

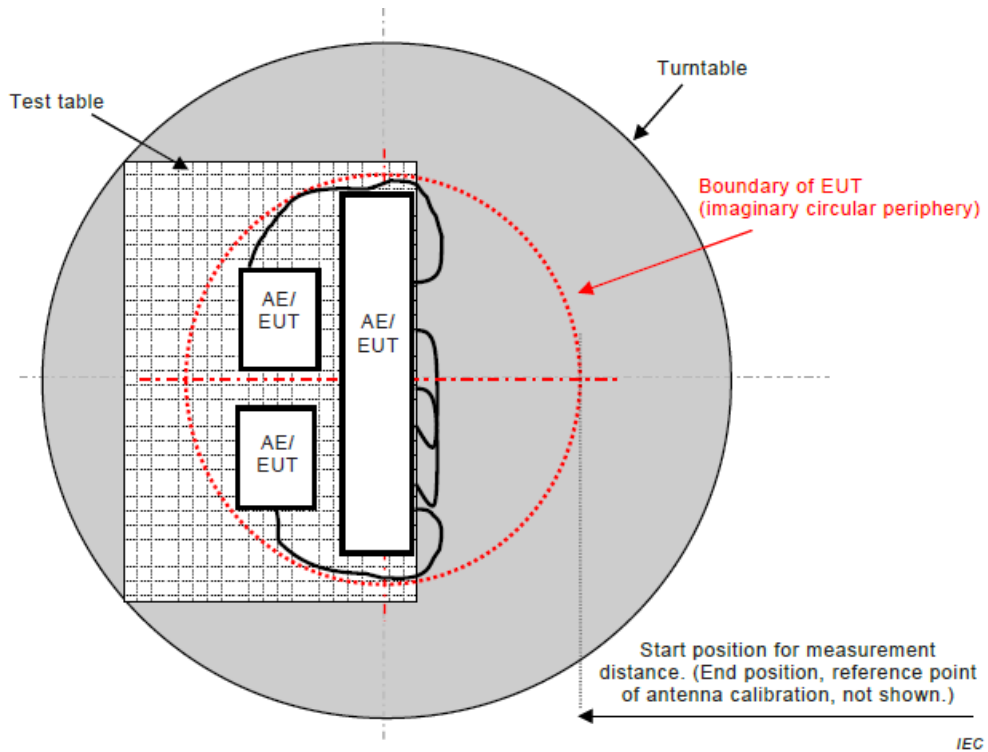

IEC

Figure C.2 – Boundary of EUT, Local AE and associated cabling

4.1.7 TEST RESULTS (UP TO 1 GHZ)

Test Voltage	AC 230V/50Hz	Polarization	Vertical
Test Mode	HDMI1 3440*1440/100Hz		

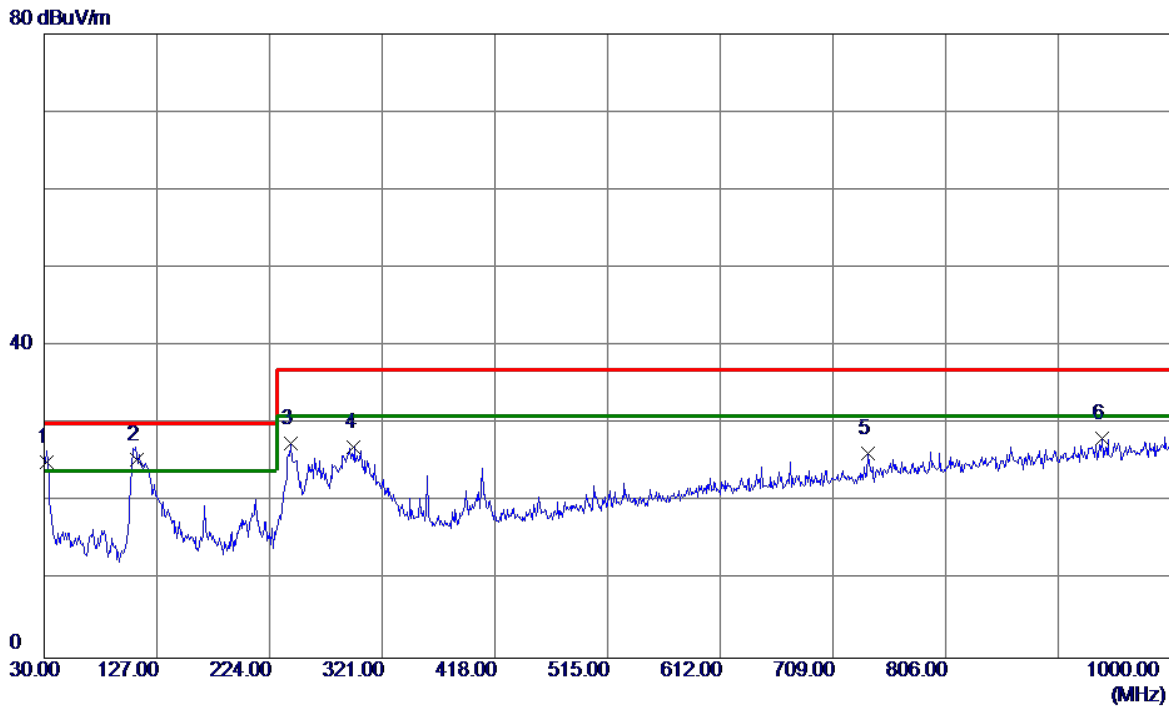

No.	Freq. MHz	Reading Level dBuV/m	Correct Factor dB	Measure ment dBuV/m	Limit dBuV/m	Margin dB	Detector
1	31.9400	43.59	-18.45	25.14	30.00	-4.86	QP
2 *	109.5400	44.98	-19.59	25.39	30.00	-4.61	QP
3	242.4300	44.89	-17.32	27.57	37.00	-9.43	QP
4	296.7500	42.21	-15.21	27.00	37.00	-10.00	QP
5	739.0700	32.67	-6.47	26.20	37.00	-10.80	QP
6	940.8300	31.82	-3.70	28.12	37.00	-8.88	QP

Test Voltage	AC 230V/50Hz	Polarization	Horizontal
Test Mode	HDMI1 3440*1440/100Hz		

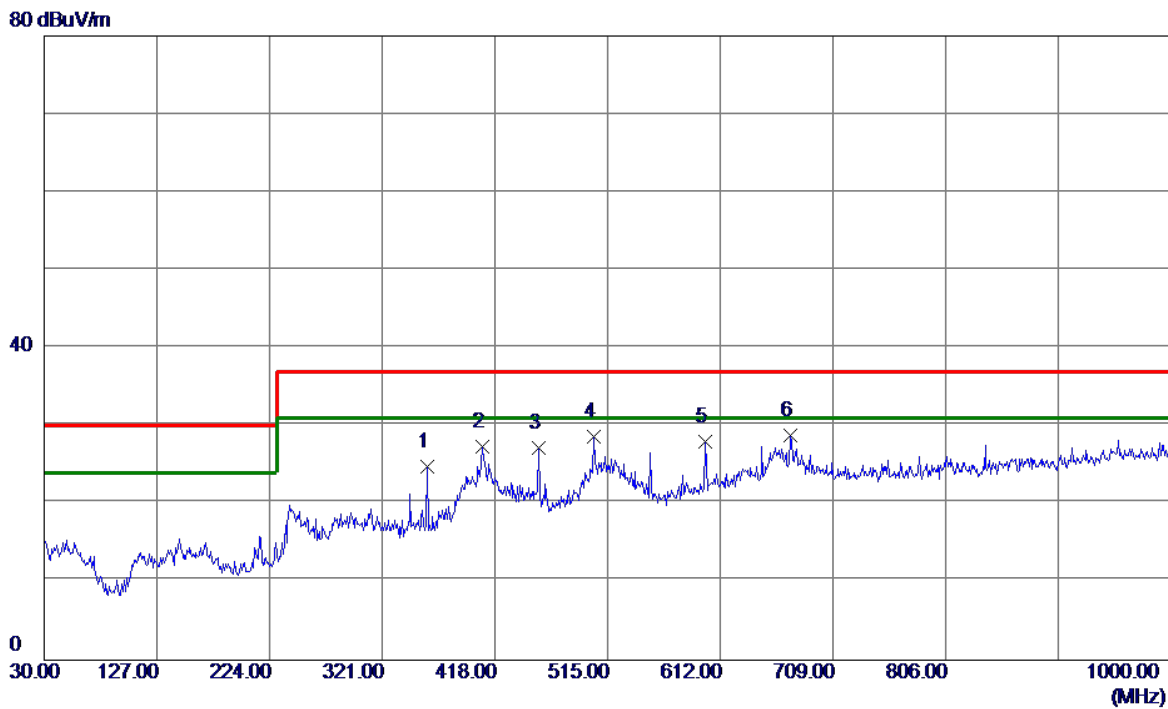

No.	Freq. MHz	Reading Level dBuV/m	Correct Factor dB	Measure ment dBuV/m	Limit dBuV/m	Margin dB	Detector
1	359.8000	38.45	-13.71	24.74	37.00	-12.26	QP
2	407.3299	39.96	-12.63	27.33	37.00	-9.67	QP
3	455.8300	38.45	-11.30	27.15	37.00	-9.85	QP
4	503.3600	39.09	-10.47	28.62	37.00	-8.38	QP
5	599.3900	36.52	-8.46	28.06	37.00	-8.94	QP
6 *	672.1400	36.33	-7.51	28.82	37.00	-8.18	QP

4.2 RADIATED EMISSIONS ABOVE 1 GHZ

4.2.1 LIMITS

Class B equipment above 1000MHz

Frequency Range MHz	Measurement			Class B limits dB(μV/m)
	Facility	Distance m	Detector type/bandwidth	
1000 - 3000	FSOATS	3	Average / 1 MHz	50
3000 - 6000				54
1000 - 3000			Peak / 1 MHz	70
3000 - 6000				74

Notes:

- (1) The limit for radiated test was performed according to as following: EN 55032
- (2) The tighter limit applies at the band edges.
- (3) Emission level (dBuV/m)=20log Emission level (uV/m).
- (4) The test result calculated as following:
 Measurement Value = Reading Level + Correct Factor
 Correct Factor = Antenna Factor + Cable Loss - Amplifier Gain(if use)
 Margin Level = Measurement Value - Limit Value

Required highest frequency for radiated measurement

Highest internal frequency (F_x) MHz	Highest measured frequency MHz
$F_x \leq 108$	1000
$108 < F_x \leq 500$	2000
$500 < F_x \leq 1000$	5000
$F_x > 1000$	5 th up to a maximum 6 GHz,

Note for FM and TV broadcast receiver, F_x is determined from the highest frequency generated or used excluding the local oscillator and tuned frequencies.

Above 1GHz:

Item	Kind of Equipment	Manufacturer	Type No.	Series Model	Calibrated until
1	Horn Antenna	EMCO	3115	9605-4803	Mar. 23, 2020
2	Amplifier	Agilent	8449B	3008A02584	Aug. 03, 2020
3	MXE EMI Receiver	Agilent	N9038A	MY53220133	Mar. 10, 2020
4	Measurement Software	Farad	EZ-EMC Ver.BTL-2ANT-1	N/A	N/A
5	Multi-Device Controller	ETS-Lindgren	2090	N/A	N/A
6	Controller	MF	MF-7802	MF780208159	N/A
7	Cable	Mlcable Inc.	B10-01-01-5M	18047123	Mar. 01, 2020
8	Cable	Mlcable Inc.	B10-01-01-10 M	18072746	Mar. 01, 2020
9	Cable	N/A	A50-3.5M3.5M -1.5M-AT	18041824	Mar. 01, 2020

Remark: "N/A" denotes no model no., no serial no. or no calibration specified.

All calibration period of equipment list is one year.

4.2.2 TEST PROCEDURE

- a. The measuring distance of 3 m shall be used for measurements. The EUT was placed on the top of a rotating table 0.8 meter above the ground at a 10 meter semi-anechoic chamber. The table was rotated 360 degrees to determine the position of the highest radiation.
- b. The height of the equipment or of the substitution antenna shall be 0.8 m, the height of the test antenna shall vary between 1 m to 4 m. Both horizontal and vertical polarizations of the antenna are set to make the measurement.
- c. The initial step in collecting radiated emission data is a receiver peak detector mode pre-scanning the measurement frequency range. Significant peaks are then marked and then Quasi Peak detector mode re-measured.
- d. All readings are Peak Mode value unless otherwise stated AVG in column of Note. If the Peak Mode Measured value compliance with the Peak Limits and lower than AVG Limits, the EUT shall be deemed to meet both Peak & AVG Limits and then only Peak Mode was measured, but AVG Mode didn't perform. (above 1GHz)
- e. For the actual test configuration, please refer to the related Item - Block Diagram of system tested.

4.2.3 DEVIATION FROM TEST STANDARD

No deviation

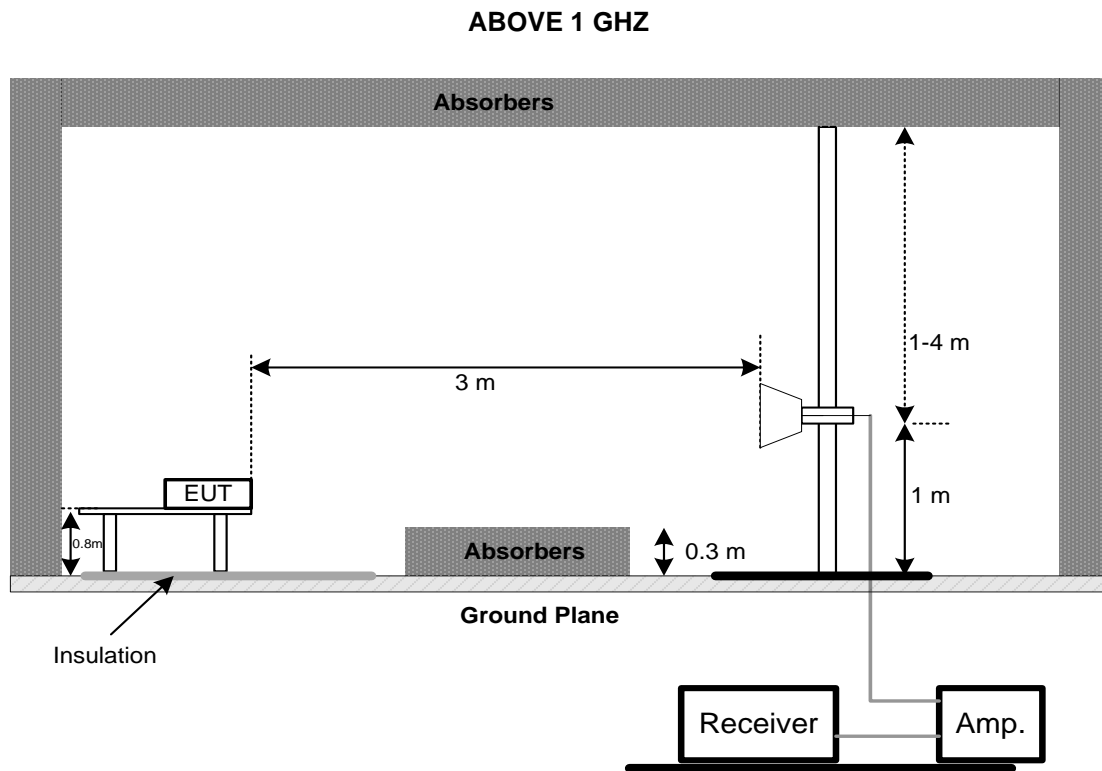
4.2.4 TEST SETUP

4.2.5 MEASUREMENT DISTANCE

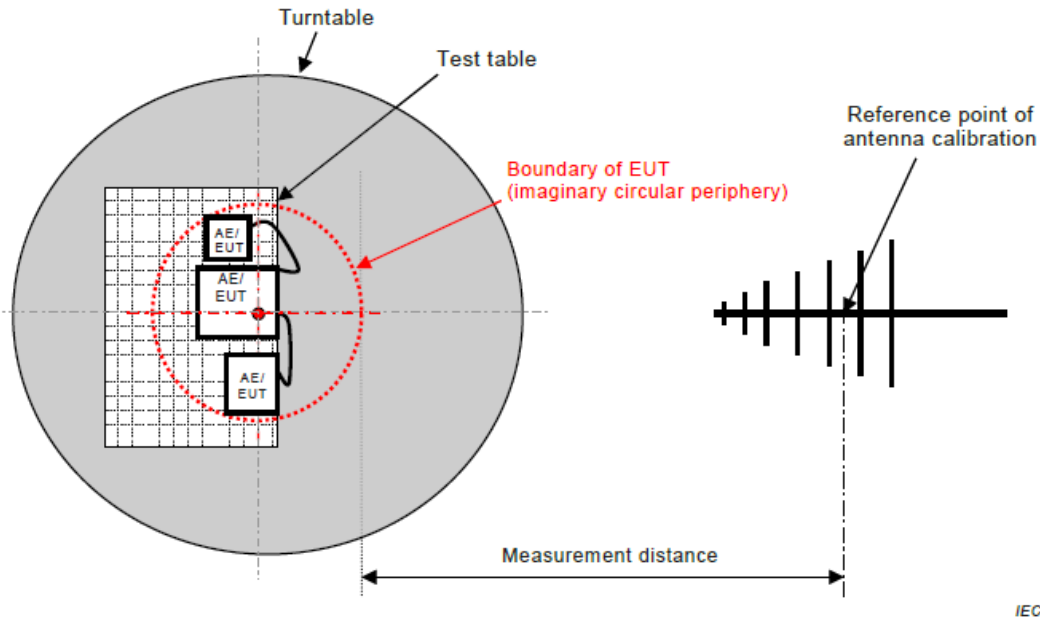

Figure C.1 – Measurement distance

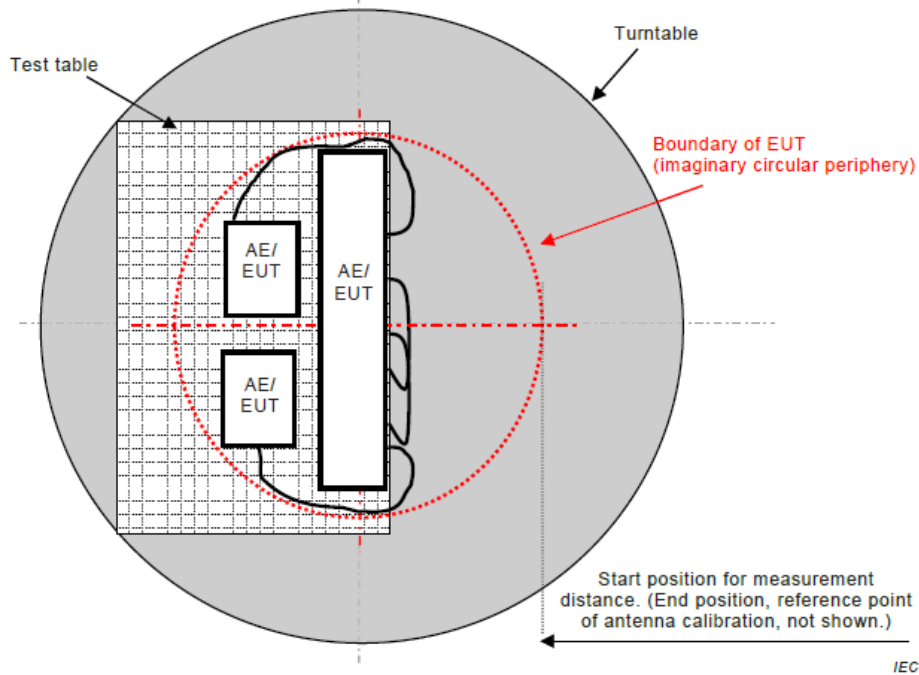
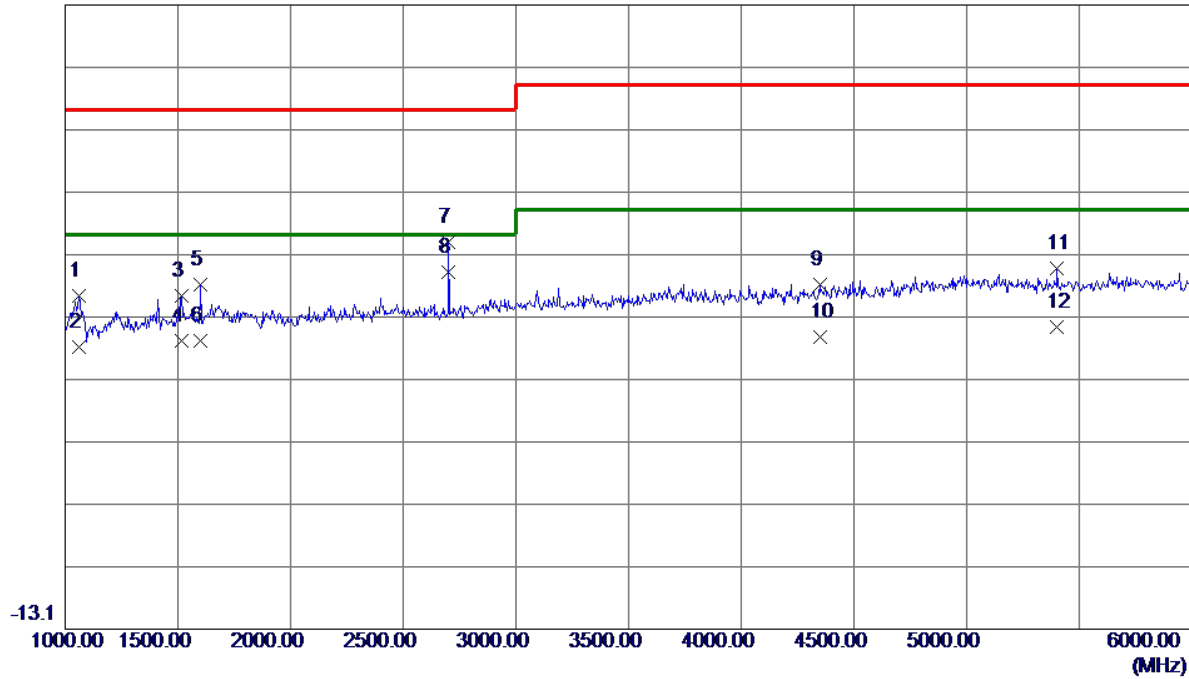

Figure C.2 – Boundary of EUT, Local AE and associated cabling

4.2.6 TEST RESULTS (ABOVE 1 GHZ)

Test Voltage	AC 230V/50Hz	Polarization	Vertical
Test Mode	HDMI1 3440*1440/100Hz		

86.9 dBuV/m



No.	Freq. MHz	Reading Level dBuV/m	Correct Factor dB	Measure ment dBuV/m	Limit dBuV/m	Margin dB	Detector
1	1060.0000	46.96	-6.63	40.33	70.00	-29.67	Peak
2	1060.0000	38.79	-6.63	32.16	50.00	-17.84	AVG
3	1515.0000	43.77	-3.51	40.26	70.00	-29.74	Peak
4	1515.0000	36.55	-3.51	33.04	50.00	-16.96	AVG
5	1600.0000	45.30	-3.22	42.08	70.00	-27.92	Peak
6	1600.0000	36.31	-3.22	33.09	50.00	-16.91	AVG
7	2700.0000	48.21	0.75	48.96	70.00	-21.04	Peak
8 *	2700.0000	43.32	0.75	44.07	50.00	-5.93	AVG
9	4347.5000	36.77	5.39	42.16	74.00	-31.84	Peak
10	4347.5000	28.28	5.39	33.67	54.00	-20.33	AVG
11	5400.0000	36.71	8.05	44.76	74.00	-29.24	Peak
12	5400.0000	27.30	8.05	35.35	54.00	-18.65	AVG

Test Voltage	AC 230V/50Hz	Polarization	Horizontal
Test Mode	HDMI1 3440*1440/100Hz		

86.9 dBuV/m

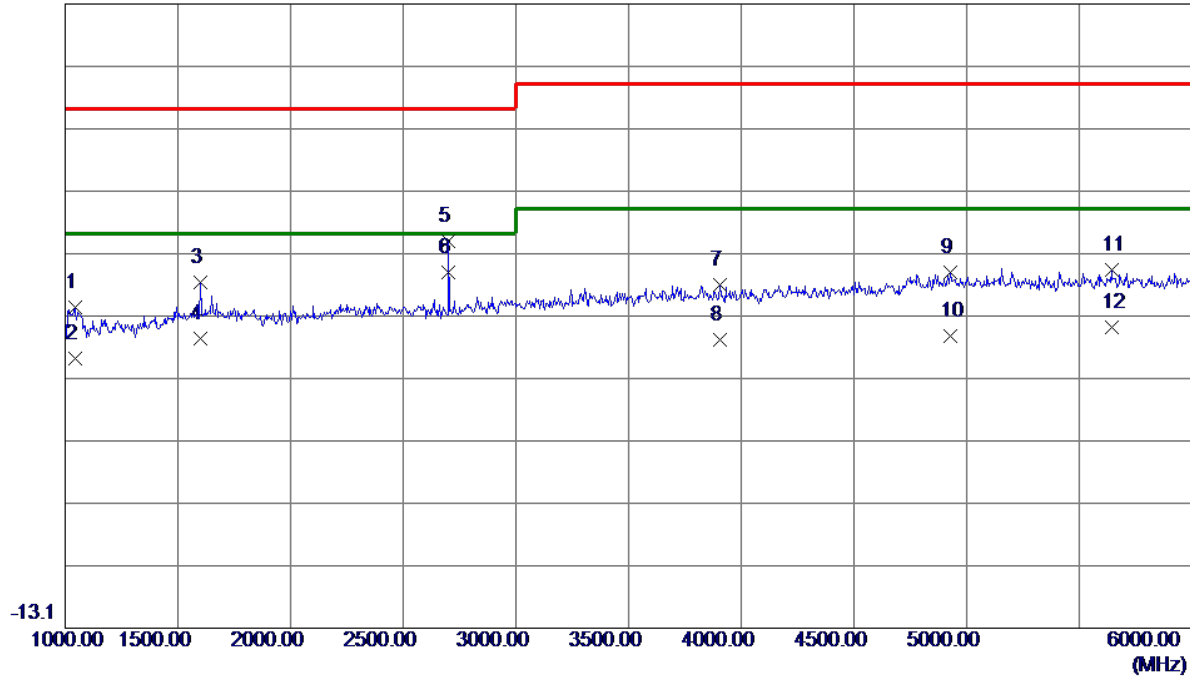

No.	Freq. MHz	Reading Level dBuV/m	Correct Factor dB	Measure ment dBuV/m	Limit dBuV/m	Margin dB	Detector
1	1042.5000	45.00	-6.75	38.25	70.00	-31.75	Peak
2	1042.5000	36.87	-6.75	30.12	50.00	-19.88	AVG
3	1597.5000	45.44	-3.23	42.21	70.00	-27.79	Peak
4	1597.5000	36.52	-3.23	33.29	50.00	-16.71	AVG
5	2700.0000	48.16	0.75	48.91	70.00	-21.09	Peak
6 *	2700.0000	43.21	0.75	43.96	50.00	-6.04	AVG
7	3905.0000	37.34	4.48	41.82	74.00	-32.18	Peak
8	3905.0000	28.60	4.48	33.08	54.00	-20.92	AVG
9	4930.0000	36.55	7.39	43.94	74.00	-30.06	Peak
10	4930.0000	26.26	7.39	33.65	54.00	-20.35	AVG
11	5642.5000	35.92	8.39	44.31	74.00	-29.69	Peak
12	5642.5000	26.78	8.39	35.17	54.00	-18.83	AVG

4.3 CONDUCTED EMISSION MEASUREMENT AT AC MAINS POWER PORTS

4.3.1 LIMITS

Requirements for conducted emissions from AC mains power ports of Class B equipment

Frequency Range MHz	Coupling Device	Detector Type / bandwidth	Class B Limits (dB(μV))
0.15 - 0.5	AMN	Quasi Peak / 9 kHz	66-56
0.5 - 5			56
5 - 30			60
0.15 - 0.5	AMN	Average / 9 kHz	56-46
0.5 - 5			46
5 - 30			50

NOTE:

(1) The test result calculated as following:

Measurement Value = Reading Level + Correct Factor

Correct Factor = Insertion Loss + Cable Loss + Attenuator Factor(if use)

Margin Level = Measurement Value – Limit Value

4.3.2 MEASUREMENT INSTRUMENTS LIST

Item	Kind of Equipment	Manufacturer	Type No.	Series Model	Calibrated until
1	EMI Test Receiver	R&S	ESCI	100382	Mar. 10, 2020
2	LISN	EMCO	3816/2	52765	Mar. 10, 2020
3	TWO-LINE V-NETWORK	R&S	ENV216	101447	May. 19, 2020
4	50Ω Terminator	SHX	TF5-3	15041305	Mar. 10, 2020
5	Measurement Software	Farad	EZ-EMC Ver.NB-03A1-01	N/A	N/A
6	Cable	N/A	RG223	12m	Mar. 12, 2020

Remark: "N/A" denotes no model name, serial no. or calibration specified.

All calibration period of equipment list is one year.

4.3.3 TEST PROCEDURE

- a. The EUT was placed 0.8 meters from the horizontal ground plane with EUT being connected to the power mains through a line impedance stabilization network (LISN). All other support equipments powered from additional LISN(s). The LISN provide 50 Ohm/ 50uH of coupling impedance for the measuring instrument.
- b. Interconnecting cables that hang closer than 40 cm to the ground plane shall be folded back and forth in the center forming a bundle 30 to 40 cm long.
- c. I/O cables that are not connected to a peripheral shall be bundled in the center. The end of the cable may be terminated, if required, using the correct terminating impedance. The overall length shall not exceed 1 m.
- d. LISN at least 80 cm from nearest part of EUT chassis.
- e. For the actual test configuration, please refer to the related Item –EUT Test Photos.

4.3.4 DEVIATION FROM TEST STANDARD

No deviation

4.3.5 TEST SETUP

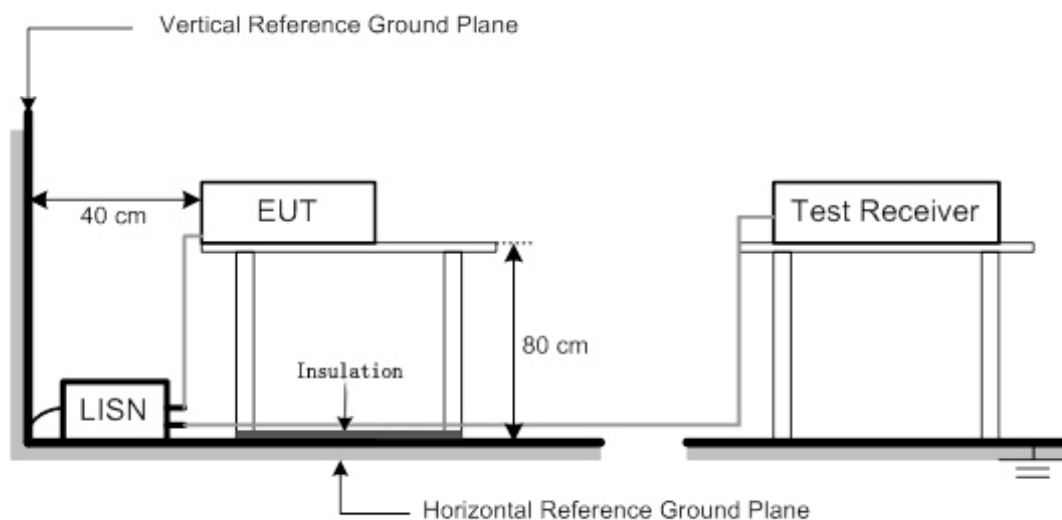

4.3.6 TEST RESULTS

Test Voltage	AC 230V/50Hz	Phase	Line
Test Mode	HDMI1 3440*1440/100Hz		

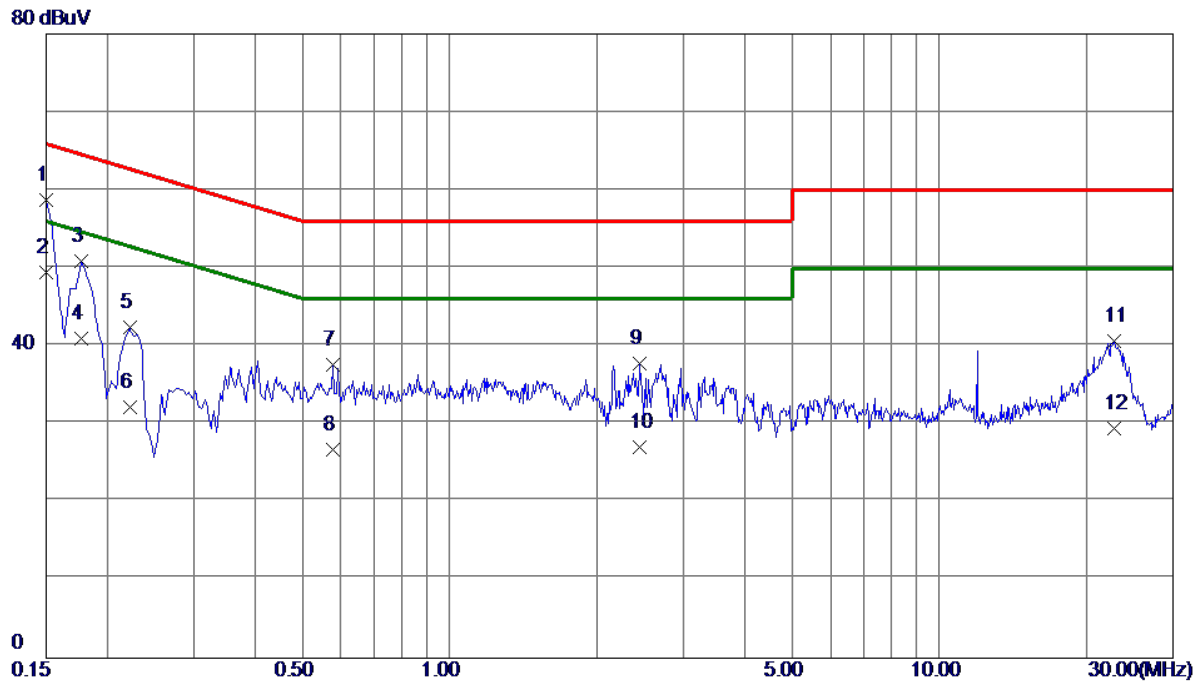

No.	Freq. MHz	Reading Level dBuV	Correct Factor dB	Measure ment dBuV	Limit dBuV	Margin dB	Detector
1	0.1500	48.84	9.82	58.66	66.00	-7.34	QP
2 *	0.1500	39.60	9.82	49.42	56.00	-6.58	AVG
3	0.1770	40.99	9.82	50.81	64.63	-13.82	QP
4	0.1770	31.20	9.82	41.02	54.63	-13.61	AVG
5	0.2220	32.51	9.82	42.33	62.74	-20.41	QP
6	0.2220	22.39	9.82	32.21	52.74	-20.53	AVG
7	0.5775	27.64	9.89	37.53	56.00	-18.47	QP
8	0.5775	16.90	9.89	26.79	46.00	-19.21	AVG
9	2.4450	27.79	10.02	37.81	56.00	-18.19	QP
10	2.4450	17.00	10.02	27.02	46.00	-18.98	AVG
11	22.6995	29.54	11.16	40.70	60.00	-19.30	QP
12	22.6995	18.29	11.16	29.45	50.00	-20.55	AVG

Test Voltage	AC 230V/50Hz	Phase	Neutral
Test Mode	HDMI1 3440*1440/100Hz		

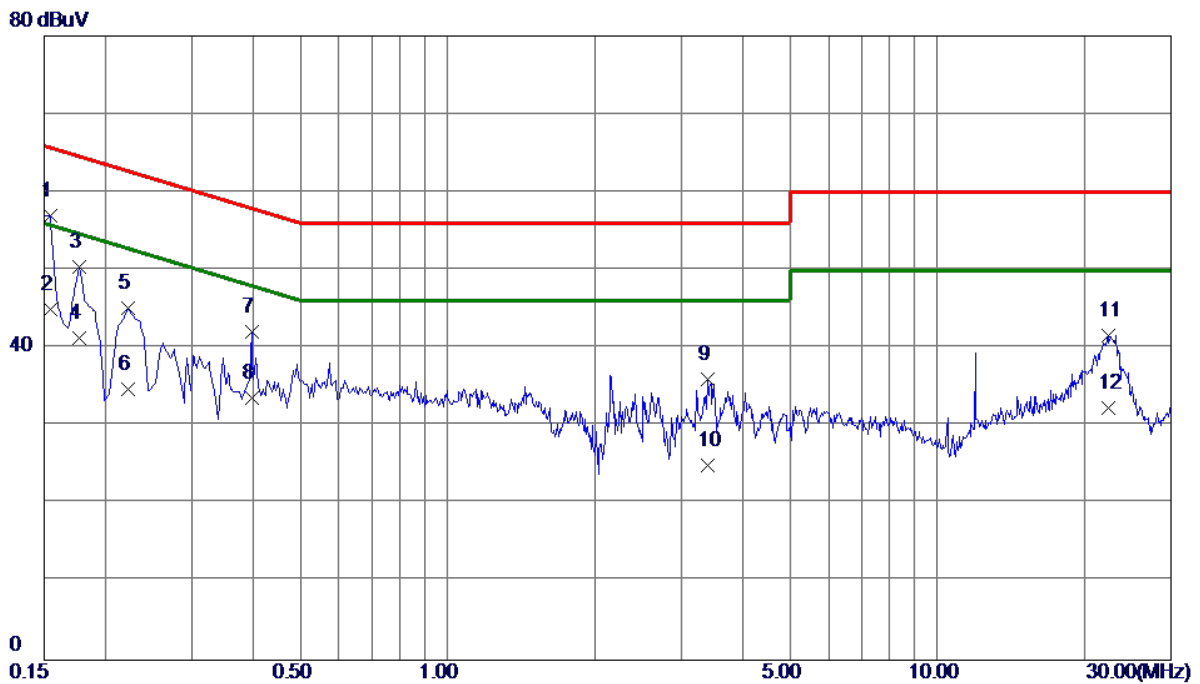

No.	Freq. MHz	Reading Level dBuV	Correct Factor dB	Measure ment dBuV	Limit dBuV	Margin dB	Detector
1 *	0.1545	47.11	9.91	57.02	65.75	-8.73	QP
2	0.1545	35.10	9.91	45.01	55.75	-10.74	AVG
3	0.1770	40.50	9.91	50.41	64.63	-14.22	QP
4	0.1770	31.40	9.91	41.31	54.63	-13.32	AVG
5	0.2220	35.27	9.91	45.18	62.74	-17.56	QP
6	0.2220	24.80	9.91	34.71	52.74	-18.03	AVG
7	0.3975	32.14	10.01	42.15	57.91	-15.76	QP
8	0.3975	23.60	10.01	33.61	47.91	-14.30	AVG
9	3.3945	25.70	10.28	35.98	56.00	-20.02	QP
10	3.3945	14.70	10.28	24.98	46.00	-21.02	AVG
11	22.2945	30.19	11.48	41.67	60.00	-18.33	QP
12	22.2945	20.91	11.48	32.39	50.00	-17.61	AVG

5. HARMONIC AND FLICKER TEST

5.1 HARMONIC CURRENT EMISSIONS

5.1.1 LIMITS

The power consumption is less than 75W, there is no limit applied.

5.1.2 MEASUREMENT INSTRUMENTS LIST

Item	Kind of Equipment	Manufacturer	Type No.	Series Model	Calibrated until
1	Harmonics and Flicker Analyzer	California Instruments	PACS-1	72344	Aug. 03, 2020
2	3KVA AC Power source	California Instruments	3001ix	56309	Aug. 03, 2020
3	Measurement Software	California	CTS4.0 Version 4.21	N/A	N/A

Remark: "N/A" denotes no model no., no serial No. or no calibration specified.

All calibration period of equipment list is one year.

5.1.3 TEST PROCEDURE

- a. The EUT was placed on the top of a wooden table 0.8 meters above the ground and operated to produce the maximum harmonic components under normal operating conditions.
- b. The correspondent test program of test instrument to measure the current harmonics emanated from EUT is chosen. The measure time shall be not less than the time necessary for the EUT to be exercised.

5.1.4 DEVIATION FROM TEST STANDARD

No deviation

5.1.5 TEST SETUP

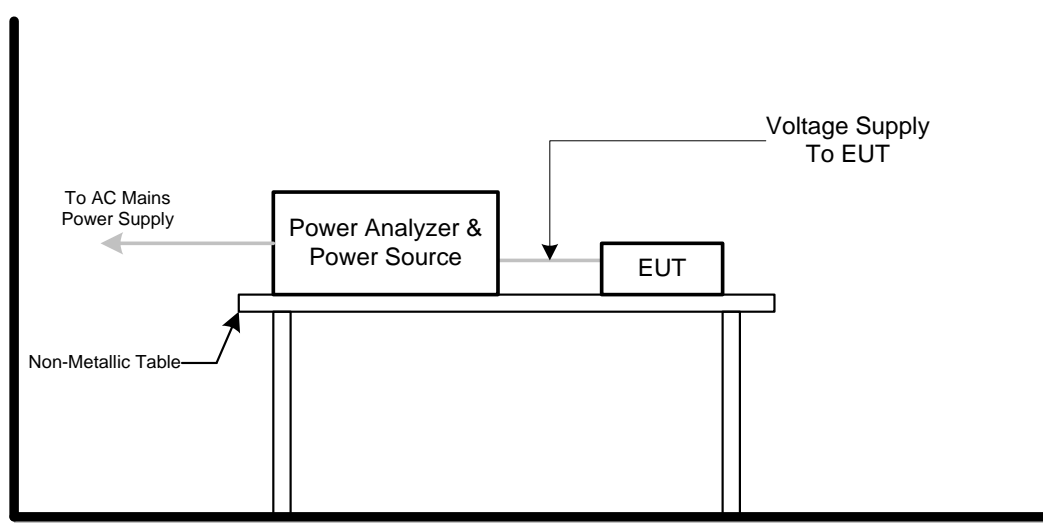

5.1.6 TEST RESULTS

Harmonic - Class D	
Test Voltage	AC 230V/50Hz
Test Mode	HDMI1 3440*1440/100Hz

Current & voltage waveforms

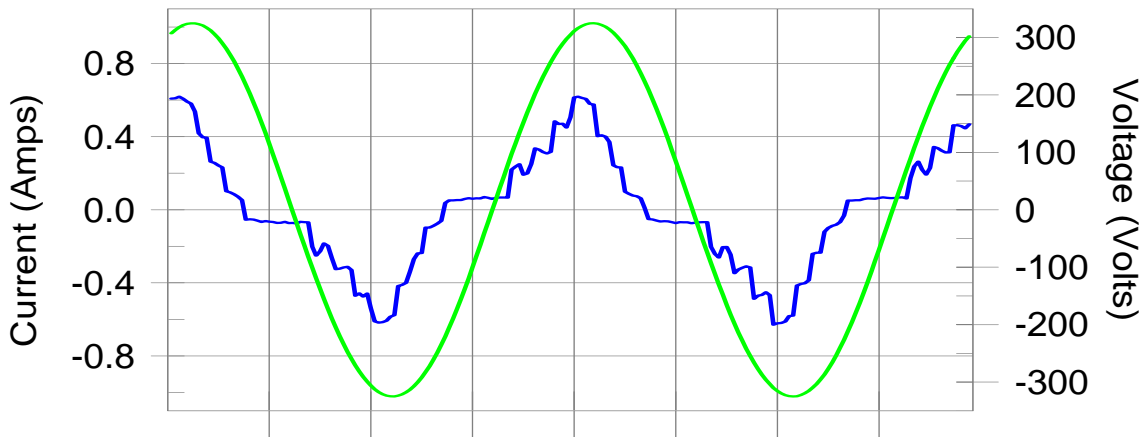

Harmonics and Class D limit line European Limits

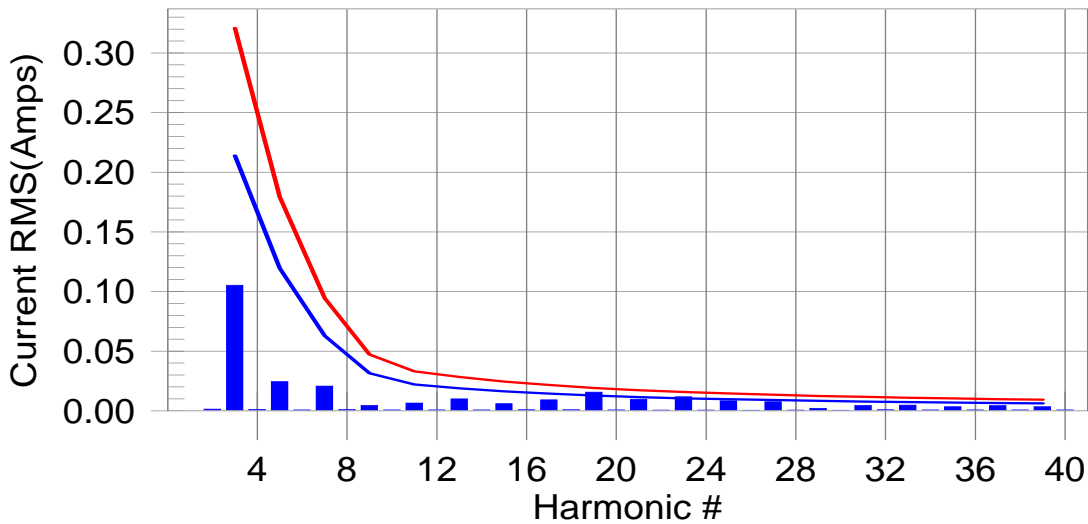

Test result: N/L Worst harmonics H0-0.0% of 150% limit, H0-0% of 100% limit

Current Test Result Summary (Run time)	
Test Voltage	AC 230V/50Hz
Test Mode	HDMI1 3440*1440/100Hz

Highest parameter values during test:

V_RMS (Volts): 230.05	Frequency(Hz): 50.00
I_Peak (Amps): 0.658	I_RMS (Amps): 0.319
I_Fund (Amps): 0.296	Crest Factor: 2.096
Power (Watts): 62.9	Power Factor: 0.861

Harm#	Harms(avg)	100%Limit	%of Limit	Harms(max)	150%Limit	%of Limit	Status
2	0.002	0.000	N/A	0.002	0.000	N/A	N/L
3	0.105	0.214	N/A	0.108	0.321	N/A	N/L
4	0.001	0.000	N/A	0.002	0.000	N/A	N/L
5	0.025	0.120	N/A	0.025	0.179	N/A	N/L
6	0.001	0.000	N/A	0.001	0.000	N/A	N/L
7	0.021	0.063	N/A	0.021	0.094	N/A	N/L
8	0.001	0.000	N/A	0.001	0.000	N/A	N/L
9	0.005	0.031	N/A	0.005	0.047	N/A	N/L
10	0.001	0.000	N/A	0.001	0.000	N/A	N/L
11	0.007	0.022	N/A	0.007	0.033	N/A	N/L
12	0.001	0.000	N/A	0.001	0.000	N/A	N/L
13	0.010	0.019	N/A	0.010	0.028	N/A	N/L
14	0.001	0.000	N/A	0.001	0.000	N/A	N/L
15	0.006	0.016	N/A	0.006	0.025	N/A	N/L
16	0.001	0.000	N/A	0.001	0.000	N/A	N/L
17	0.009	0.014	N/A	0.010	0.022	N/A	N/L
18	0.001	0.000	N/A	0.001	0.000	N/A	N/L
19	0.016	0.013	N/A	0.016	0.019	N/A	N/L
20	0.001	0.000	N/A	0.001	0.000	N/A	N/L
21	0.010	0.012	N/A	0.010	0.017	N/A	N/L
22	0.001	0.000	N/A	0.001	0.000	N/A	N/L
23	0.012	0.011	N/A	0.012	0.016	N/A	N/L
24	0.001	0.000	N/A	0.001	0.000	N/A	N/L
25	0.008	0.010	N/A	0.009	0.015	N/A	N/L
26	0.001	0.000	N/A	0.001	0.000	N/A	N/L
27	0.008	0.009	N/A	0.008	0.013	N/A	N/L
28	0.001	0.000	N/A	0.001	0.000	N/A	N/L
29	0.002	0.008	N/A	0.002	0.013	N/A	N/L
30	0.001	0.000	N/A	0.001	0.000	N/A	N/L
31	0.005	0.008	N/A	0.005	0.012	N/A	N/L
32	0.001	0.000	N/A	0.001	0.000	N/A	N/L
33	0.005	0.007	N/A	0.005	0.011	N/A	N/L
34	0.001	0.000	N/A	0.001	0.000	N/A	N/L
35	0.003	0.007	N/A	0.004	0.010	N/A	N/L
36	0.001	0.000	N/A	0.001	0.000	N/A	N/L
37	0.004	0.007	N/A	0.005	0.010	N/A	N/L
38	0.001	0.000	N/A	0.001	0.000	N/A	N/L
39	0.003	0.006	N/A	0.004	0.009	N/A	N/L
40	0.001	0.000	N/A	0.001	0.000	N/A	N/L

Note: The EUT power level is below 75.0 Watts and therefore has no defined limits

Voltage Source Verification Data (Run time)	
Test Voltage	AC 230V/50Hz
Test Mode	HDMI1 3440*1440/100Hz

Highest parameter values during test:

Voltage (Vrms): 230.05	Frequency(Hz): 50.00
I_Peak (Amps): 0.658	I_RMS (Amps): 0.319
I_Fund (Amps): 0.296	Crest Factor: 2.096
Power (Watts): 62.9	Power Factor: 0.861

Harm#	Harmonics	V-rms	Limit V-rms	% of Limit	Status
2		0.112	0.460	24.34	OK
3		0.562	2.070	27.14	OK
4		0.060	0.460	12.98	OK
5		0.064	0.920	6.96	OK
6		0.021	0.460	4.51	OK
7		0.031	0.690	4.51	OK
8		0.023	0.460	5.04	OK
9		0.042	0.460	9.02	OK
10		0.021	0.460	4.48	OK
11		0.024	0.230	10.56	OK
12		0.019	0.230	8.33	OK
13		0.016	0.230	6.85	OK
14		0.016	0.230	6.81	OK
15		0.020	0.230	8.85	OK
16		0.015	0.230	6.53	OK
17		0.014	0.230	5.92	OK
18		0.012	0.230	5.10	OK
19		0.014	0.230	6.15	OK
20		0.015	0.230	6.32	OK
21		0.012	0.230	5.29	OK
22		0.012	0.230	5.29	OK
23		0.019	0.230	8.33	OK
24		0.007	0.230	2.91	OK
25		0.017	0.230	7.28	OK
26		0.009	0.230	4.01	OK
27		0.017	0.230	7.36	OK
28		0.009	0.230	3.87	OK
29		0.012	0.230	5.22	OK
30		0.007	0.230	2.87	OK
31		0.008	0.230	3.68	OK
32		0.007	0.230	2.88	OK
33		0.011	0.230	4.66	OK
34		0.004	0.230	1.66	OK
35		0.009	0.230	3.75	OK
36		0.004	0.230	1.86	OK
37		0.012	0.230	5.25	OK
38		0.005	0.230	2.04	OK
39		0.006	0.230	2.70	OK
40		0.007	0.230	2.86	OK

5.2 VOLTAGE CHANGES, VOLTAGE FLUCTUATIONS AND FLICKER TEST

5.2.1 LIMITS

Tests	Limits	Descriptions
	EN 61000-3-3	
Pst	≤ 1.0 , $T_p=10$ min.	Short Term Flicker Indicator
Plt	≤ 0.65 , $T_p=2$ hr.	Long Term Flicker Indicator
dc	$\leq 3.3\%$	Relative Steady-State V-Chang
dmax	$\leq 4\%$	Maximum Relative V-change
d (t)	≤ 500 ms	Relative V-change characteristic

5.2.2 MEASUREMENT INSTRUMENTS LIST

Item	Kind of Equipment	Manufacturer	Type No.	Series Model	Calibrated until
1	Harmonics and Flicker Analyzer	California Instruments	PACS-1	72344	Aug. 03, 2020
2	3KVA AC Power source	California Instruments	3001ix	56309	Aug. 03, 2020
3	Measurement Software	California	CTS4.0 Version 4.21	N/A	N/A

Remark: "N/A" denotes no model no., no serial No. or no calibration specified.

All calibration period of equipment list is one year.

5.2.3 TEST PROCEDURE

- a. Tests was performed according to the Test Conditions/Assessment of Voltage Fluctuations specified in EN 61000-3-3 depend on which standard adopted for compliance measurement.
- b. All types of harmonic current and/or voltage fluctuation in this report are assessed by direct measurement using flicker-meter.

5.2.4 DEVIATION FROM TEST STANDARD

No deviation

5.2.5 TEST SETUP

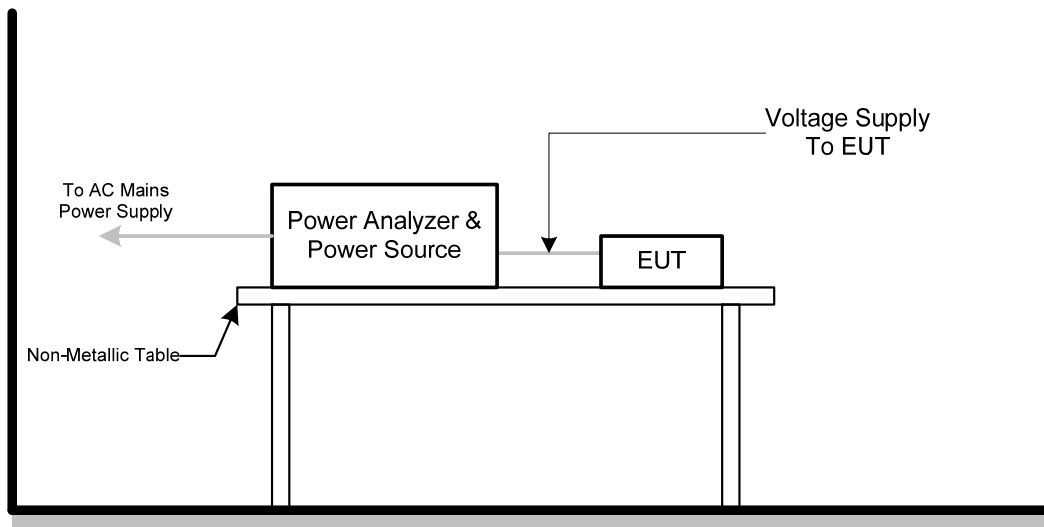

5.2.6 TEST RESULTS

Test Voltage	AC 230V/50Hz
Test Mode	HDMI1 3440*1440/100Hz

Psti and limit line

European Limits

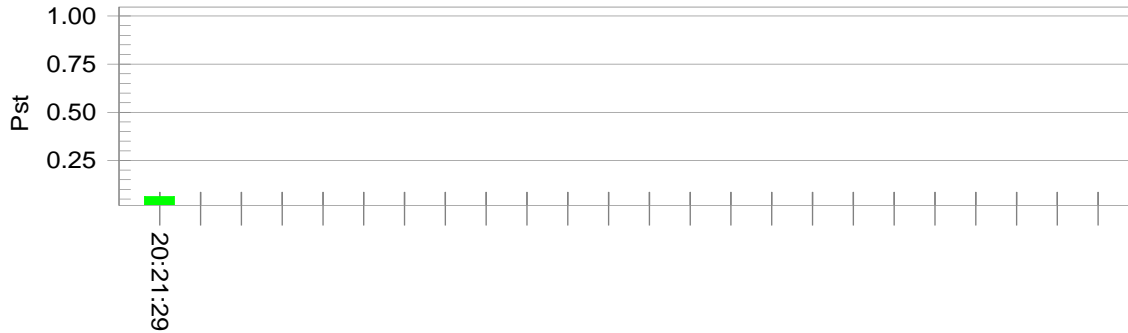

Plt and limit line

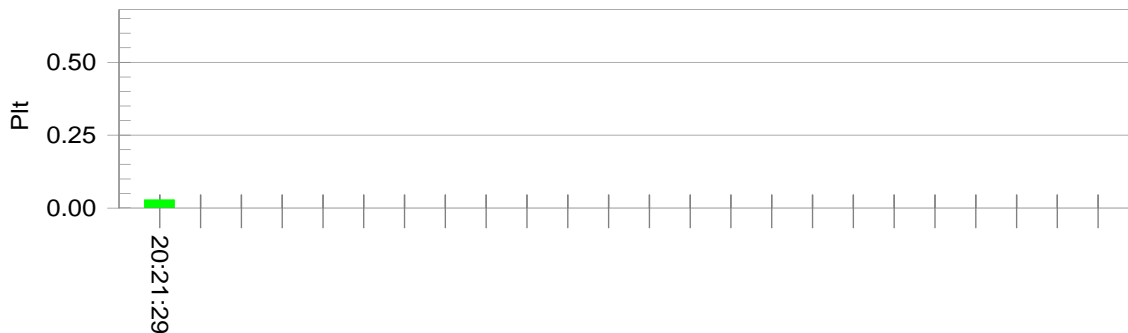
Parameter values recorded during the test:

Vrms at the end of test (Volt):	229.90		
T-max (mS):	0	Test limit (mS):	500.0 Pass
Highest dc (%):	0.00	Test limit (%):	3.30 Pass
Highest dmax (%):	0.00	Test limit (%):	4.00 Pass
Highest Pst (10 min. period):	0.064	Test limit:	1.000 Pass
Highest Plt (2 hr. period):	0.028	Test limit:	0.650 Pass

6. EMC IMMUNITY TEST

6.1 STANDARD COMPLIANCE/SEVERITY LEVEL/CRITERIA

Tests Standard No.	Test Specification Level	Test Ports	Criteria
Electrostatic discharge IEC 61000-4-2 (ESD)	±8 kV air discharge ±4 kV contact discharge (Direct Mode)	Enclosure	B
	±4kV HCP discharge ±4kV VCP discharge (Indirect Mode)	Enclosure	B
Radiated, radio-frequency, electromagnetic field immunity IEC 61000-4-3 (RS)	80 MHz to 1000 MHz 3V/m(unmodulated, r.m.s), 1 kHz, 80% AM modulated	Enclosure	A
Electrical fast transient/burst immunity IEC 61000-4-4 (EFT)	±0.5kV(peak) 5/50ns Tr/Th 5kHz Repetition Frequency (100kHz Repetition Frequency for xDSL ports)	Signal ports and telecommunication ports (Only applicable to cable length>3 m)	B
	±0.5kV(peak) 5/50ns Tr/Th 5kHz Repetition Frequency	DC Power Ports	B
	±1 kV(peak) 5/50ns Tr/Th 5kHz Repetition Frequency	AC Power Ports	B
Surge immunity IEC 61000-4-5 (Surge)	±1 kV(peak) 10/700 Tr/Th μs (without primary protection)	Signal ports and telecommunication ports (applicable only to ports connect directly to outdoor cables)	C
	±4 kV(peak) 10/700 Tr/Th μs (with primary protectors fitted)		C
	±0.5 kV(peak) 1.2/50(8/20) Tr/Th μs	DC Power Ports (applicable only to ports connect directly to outdoor cables)	B
	±1 kV(peak) 1.2/50(8/20) Tr/Th μs (line to line)	AC Power Ports	B
	±2 kV(peak) 1.2/50(8/20) Tr/Th μs (line to earth or ground)		B

Immunity to conducted disturbances, induced by radio-frequency fields IEC 61000-4-6 (CS)	0.15 MHz to 80 MHz 3V(unmodulated, r.m.s), 1kHz 80%, AM 150Ω source impedance	Signal ports and telecommunication ports (Only applicable to cable length>3 m)	A
	0.15 MHz to 80 MHz 3V(unmodulated, r.m.s), 1kHz 80%, AM 150Ω source impedance	DC Power Ports	A
	0.15 MHz to 80 MHz 3V(unmodulated, r.m.s), 1kHz 80%, AM 150Ω source impedance	AC Power Ports	A
Power frequency magnetic field immunity IEC 61000-4-8 (PFMF)	50 Hz or 60Hz, 1A/m(r.m.s)	Enclosure	A
Voltage dips, short interruptions and voltage variations immunity IEC 61000-4-11 (Dip)	Voltage reduction > 95% 0.5 cycle Voltage reduction 30% 25 cycle Voltage reduction > 95% 250 cycle	AC Power Ports	B C C

6.2 GENERAL PERFORMANCE CRITERIA

According to **EN55024** standard, the general performance criteria as following:

<p>Criterion A</p>	<p>The equipment shall continue to operate as intended without operator intervention. No degradation of performance or loss of function is allowed below a performance level specified by the manufacturer when the equipment is used as intended. The performance level may be replaced by a permissible loss of performance. If the minimum performance level or the permissible performance loss is not specified by the manufacturer, then either of these may be derived from the product description and documentation, and by what the user product description and documentation, and by what the user may reasonably expect from the equipment if used as intended.</p>
<p>Criterion B</p>	<p>After the test, the equipment shall continue to operate as intended without operator Intervention. No degradation of performance or loss of function is allowed, after the application of the phenomenon below a performance level specified by the manufacturer, when the equipment is used as intended. The performance level may be replaced by a permissible loss of performance. During the test, degradation of performance is allowed. However, no change of operating state if stored data allowed to persist after the test. If the minimum performance level (or the permissible performance loss) is not specified by the manufacturer, then either of these may be derived from the product description and documentation, and by what the user may reasonably expect from the equipment if used as intended.</p>
<p>Criterion C</p>	<p>Loss of function is allowed, provided the function is self-recoverable, or can be restored by the operation of the controls by the user in accordance with the manufacturer's instructions. Functions, and/or information stored in non-volatile memory, or protected by a battery backup, shall not be lost.</p>

6.3 ELECTROSTATIC DISCHARGE IMMUNITY TEST (ESD)

6.3.1 TEST SPECIFICATION

Basic Standard	IEC 61000-4-2
Discharge Impedance	330 ohm / 150 pF
Required Performance	B
Discharge Voltage	Air Discharge: ± 2 kV, ± 4 kV, ± 8 kV Contact Discharge: ± 2 kV, ± 4 kV
Polarity	Positive & Negative
Number of Discharge	Air Discharge: min. 20 times at each test point Contact Discharge: min. 200 times in total
Discharge Mode	Single Discharge
Discharge Period	1 second

6.3.2 MEASUREMENT INSTRUMENTS

Item	Kind of Equipment	Manufacturer	Type No.	Series Model	Calibrated until
1	ESD Generator	TESEQ AG	NSG 437	450	Sep. 07, 2020

Remark: "N/A" denotes no model no., no serial No. or no calibration specified.

All calibration period of equipment list is one year.

6.3.3 TEST PROCEDURE

The test generator necessary to perform direct and indirect application of discharges to the EUT in the following manner:

- a. Contact discharge was applied to conductive surfaces (Direct) and coupling planes (Indirect) of the EUT.

During the test, it was performed with single discharges. For the single discharge time between successive single discharges was at least 1 second. The EUT shall be exposed to at least 200 discharges, 100 each at negative and positive polarity, at a minimum of four test points. One of the test points shall be subjected to at least 50 indirect discharges to the center of the front edge of the horizontal coupling plane. The remaining three test points shall each receive at least 50 direct contact discharges.

If no direct contact test points are available, then at least 200 indirect discharges shall be applied in the indirect mode. Test shall be performed at a maximum repetition rate of one discharge per second.

Vertical Coupling Plane (VCP):

The coupling plane, of dimensions 0.5m x 0.5m, is placed parallel to, and positioned at a distance 0.1m from, the EUT, with the Discharge Electrode touching the coupling plane.

The four faces of the EUT will be performed with electrostatic discharge.

Horizontal Coupling Plane (HCP):

The coupling plane is placed under to the EUT. The generator shall be positioned vertically at a distance of 0.1m from the EUT, with the Discharge Electrode touching the coupling plane.

The four faces of the EUT will be performed with electrostatic discharge.

- b. Air discharges at insulation surfaces of the EUT.

It was at least ten single discharges with positive and negative at the same selected point.

c. For TABLE-TOP equipment:

The configuration consisted of a wooden table 0.8 meters high standing on the Ground Reference Plane. The GRP consisted of a sheet of aluminum at least 0.25mm thick, and 2.5 meters square connected to the protective grounding system. A Horizontal Coupling Plane (1.6m x 0.8m) was placed on the table and attached to the GRP by means of a cable with 940k total impedance. The equipment under test was installed in a representative system as described in IEC 61000-4-2, and its cables were placed on the HCP and isolated by an insulating support of 0.5mm thickness. A distance of 1-meter minimum was provided between the EUT and the walls of the laboratory and any other metallic structure.

6.3.4 DEVIATION FROM TEST STANDARD

No deviation

6.3.5 TEST SETUP

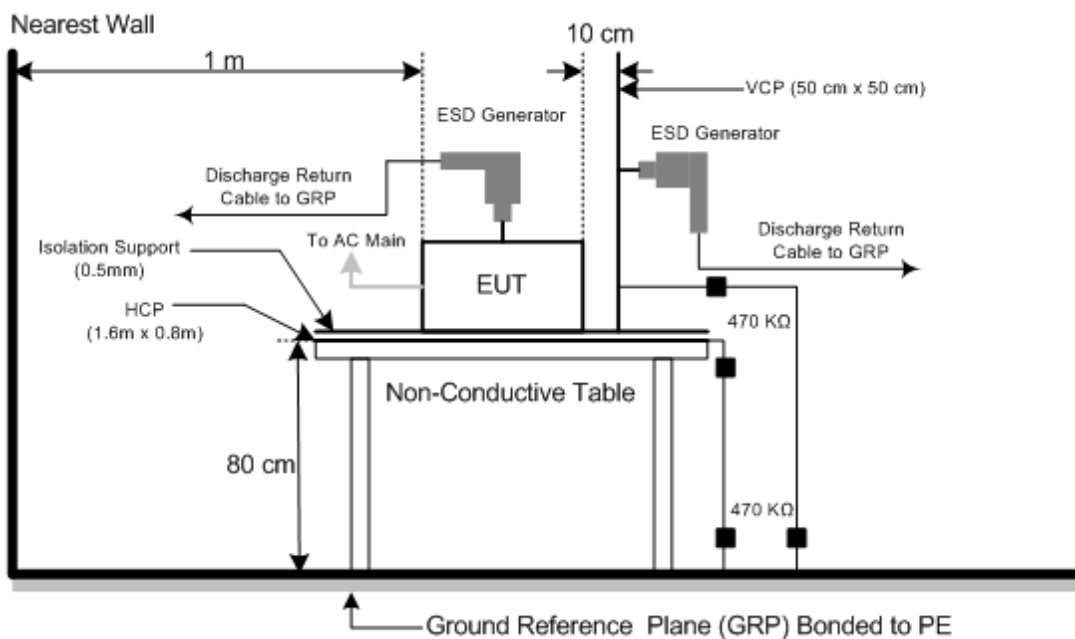

6.3.6 TEST RESULTS

Test Voltage	AC 230V/50Hz
Test Mode	HDMI1 3440*1440/100Hz

Mode	Air Discharge								Contact Discharge					
	2kV		4kV		8kV		- kV		2kV		4kV		- kV	
Location	P	N	P	N	P	N	P	N	P	N	P	N	P	N
1	A	A	A	A	B	B	-	-	A	A	A	A	-	-
2	A	A	A	A	A	A	-	-	A	A	B	B	-	-
3	A	A	A	A	A	A	-	-	A	A	B	B	-	-
4	A	A	A	A	A	A	-	-	-	-	-	-	-	-
5	A	A	A	A	B	B	-	-	-	-	-	-	-	-
6	A	A	A	A	B	B	-	-	-	-	-	-	-	-
7	A	A	A	A	A	A	-	-	-	-	-	-	-	-
Criteria	B						-		B				-	
Result	B						-		B				-	

Mode	HCP Contact Discharge						VCP Contact Discharge					
	2kV		4kV		- kV		2kV		4kV		- kV	
Location	P	N	P	N	P	N	P	N	P	N	P	N
Left side	A	A	A	A	-	-	A	A	A	A	-	-
Right side	A	A	A	A	-	-	A	A	A	A	-	-
Front side	A	A	A	A	-	-	A	A	A	A	-	-
Rear side	A	A	A	A	-	-	A	A	A	A	-	-
Criteria	B				-		B				-	
Result	A				-		A				-	

Note:

- 1) P/N denotes the Positive/Negative polarity of the output voltage.
- 2) N/A - denotes test is not applicable in this test report

PHOTO(S) SHOWN THE LOCATION(S) OF ESD EVALUATED

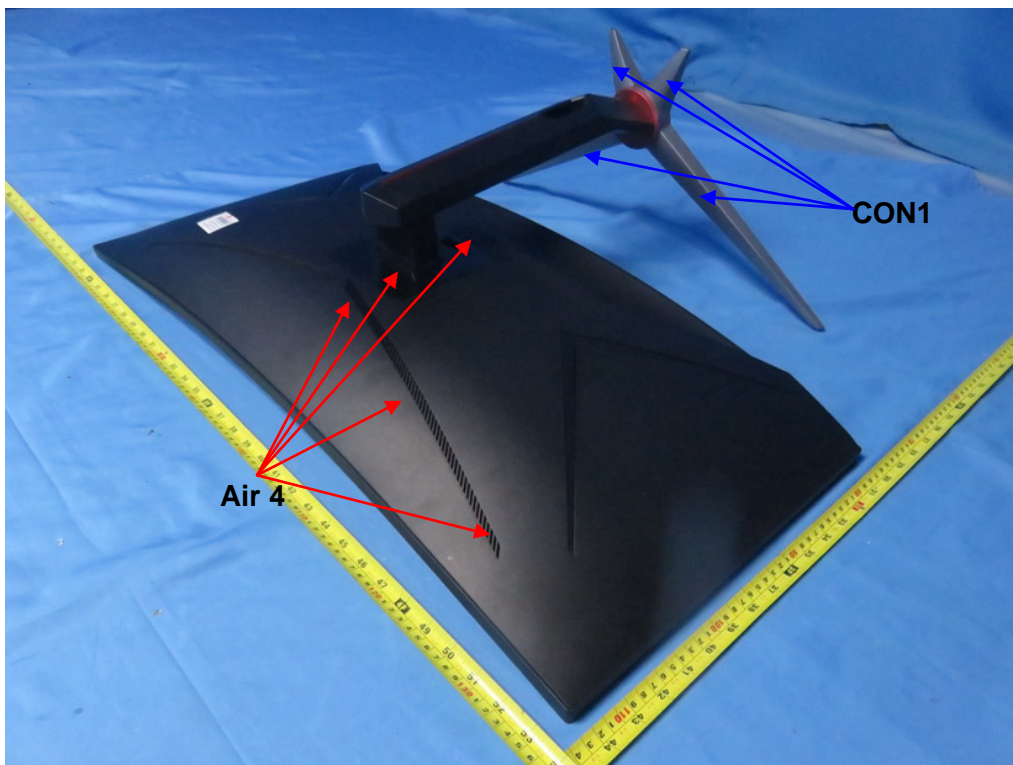
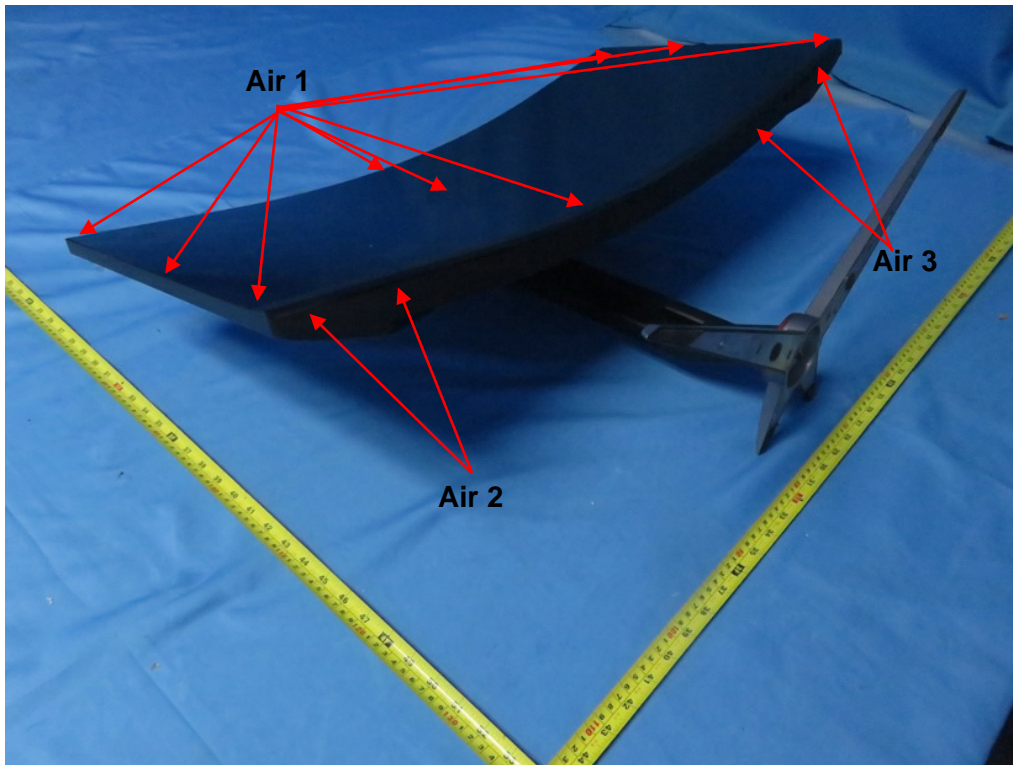

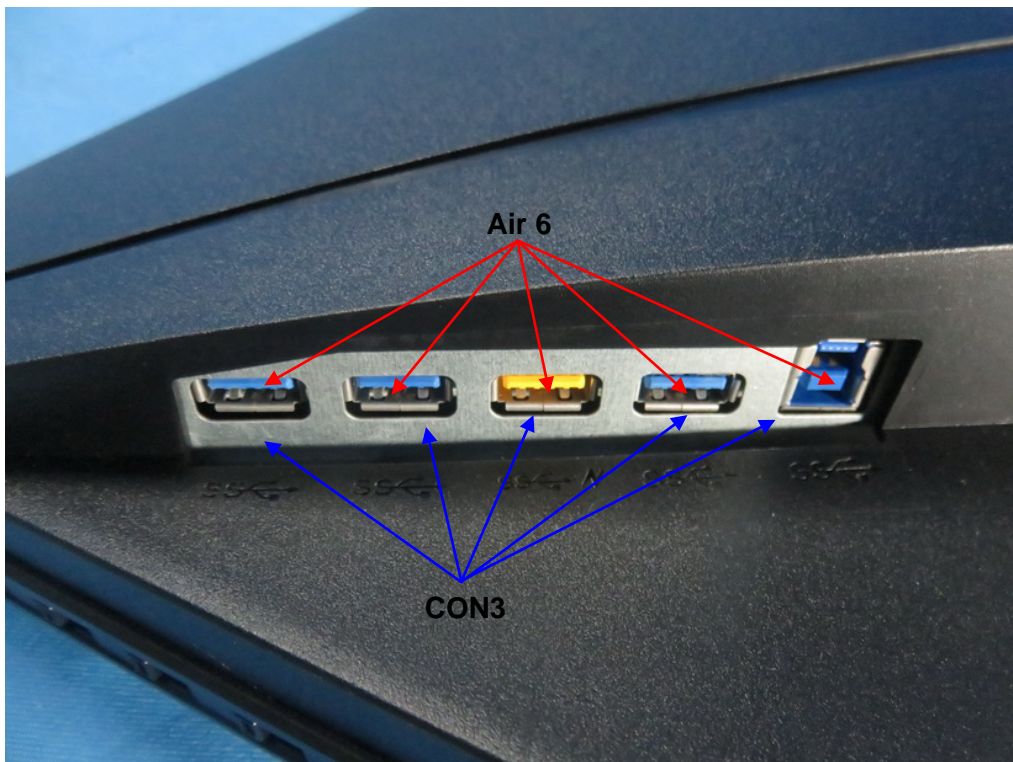
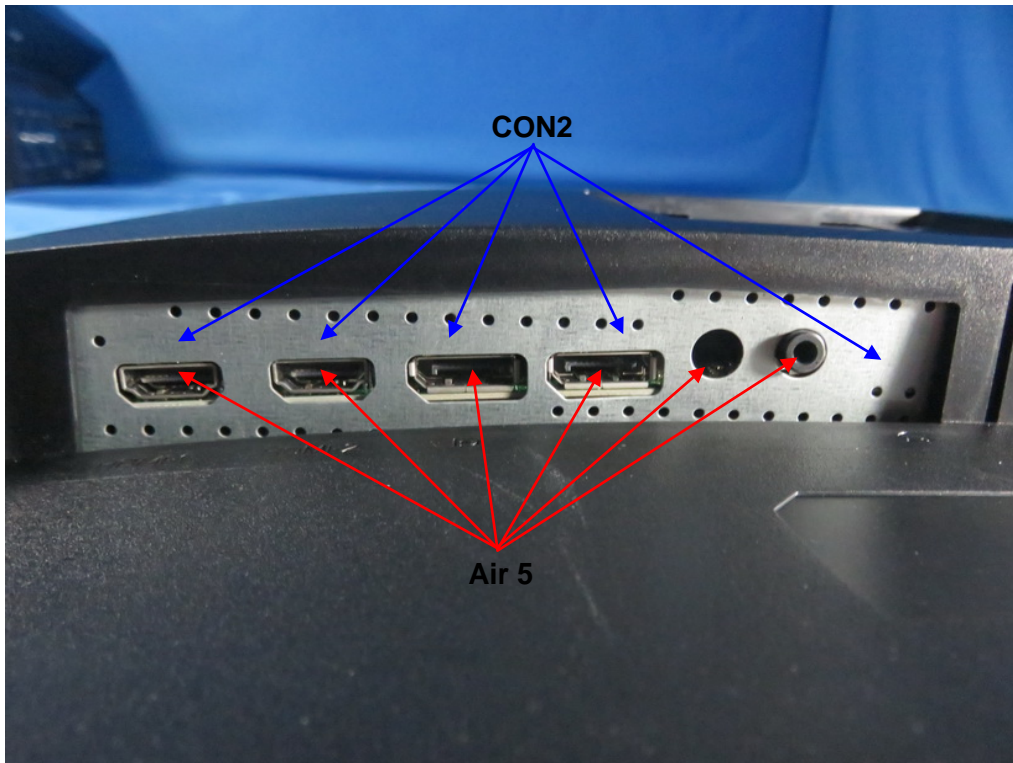

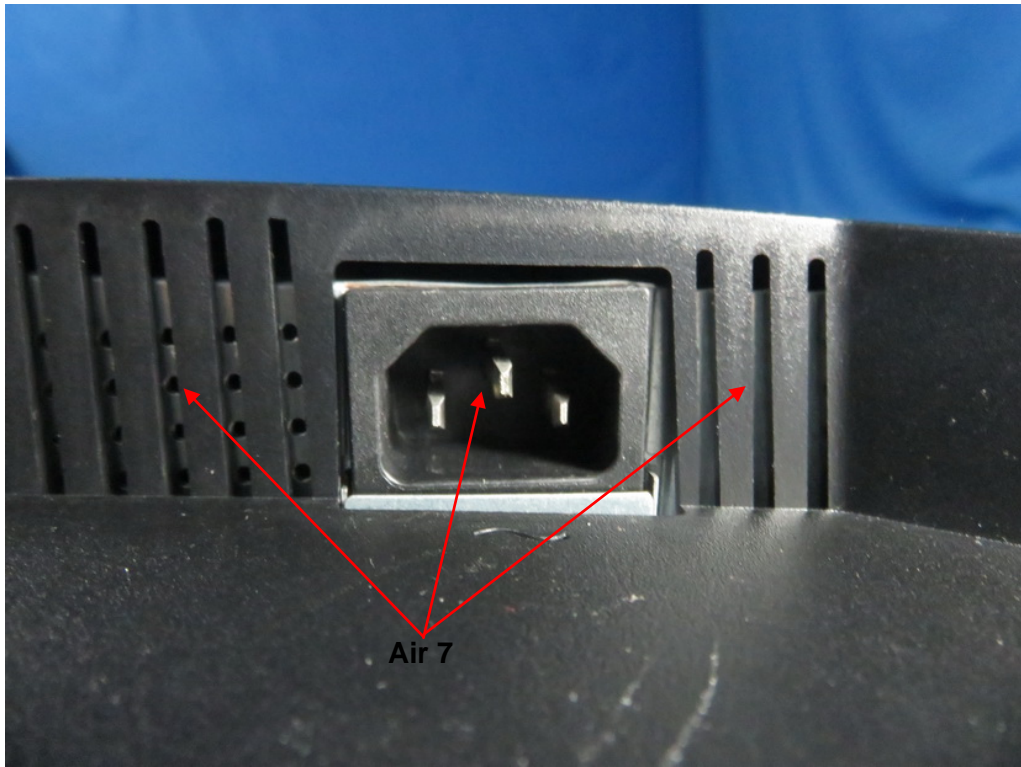

6.4 RADIATED, RADIO-FREQUENCY, ELECTROMAGNETIC FIELD IMMUNITY TEST (RS)

6.4.1 TEST SPECIFICATION

Basic Standard	IEC 61000-4-3
Required Performance	A
Frequency Range	80 MHz - 1000 MHz
Field Strength	3 V/m(unmodulated, r.m.s)
Modulation	1 kHz Sine Wave, 80%, AM Modulation
Frequency Step	1% of fundamental
Polarity of Antenna	Horizontal and Vertical
Test Distance	3 m
Antenna Height	1.55 m
Dwell Time	3 seconds

6.4.2 MEASUREMENT INSTRUMENTS

Item	Kind of Equipment	Manufacturer	Type No.	Series Model	Calibrated until
1	MXG Analog Signal Generator	Agilent	N5181A	MY49060710	Aug. 03, 2020
2*	Power amplifier	MILMEGA	80RF1000-250	1064833	Aug. 20, 2020
3	Antenna	ETS	3142C	47662	Mar. 23, 2020
4	Measurement Software	TOYO	IM5/RS Ver 3.8.050	N/A	N/A

Remark: "N/A" denotes no model no., no serial No. or no calibration specified.

"*" calibration period of equipment list is three year.

Except * item, all calibration period of equipment list is one year.

6.4.3 TEST PROCEDURE

The EUT and support equipment are in a fully-anechoic chamber.

The testing distance from antenna to the EUT was 3 meters.

For TABLE-TOP equipment:

The EUT installed in a representative system as described in IEC 61000-4-3 was placed on a non-conductive table 0.8 meters in height. The system under test was connected to the power and signal wire according to relevant installation instructions.

The other condition as following manner:

- a. The field strength level was 3 V/m(unmodulated, r.m.s).
- b. The frequency range is swept from 80 MHz to 1000 MHz, with the signal 80%amplitude modulated with a 1 kHz sine wave. The rate of sweep did not exceed 1.5×10^{-3} decade/s. Where the frequency range is swept incrementally, the step size was 1% of fundamental.
- c. The dwell time at each frequency shall be not less than the time necessary for the EUT to be able to respond.
- d. The test was performed with the EUT exposed to both vertically and horizontally polarized fields on each of the four sides.

6.4.4 DEVIATION FROM TEST STANDARD

No deviation

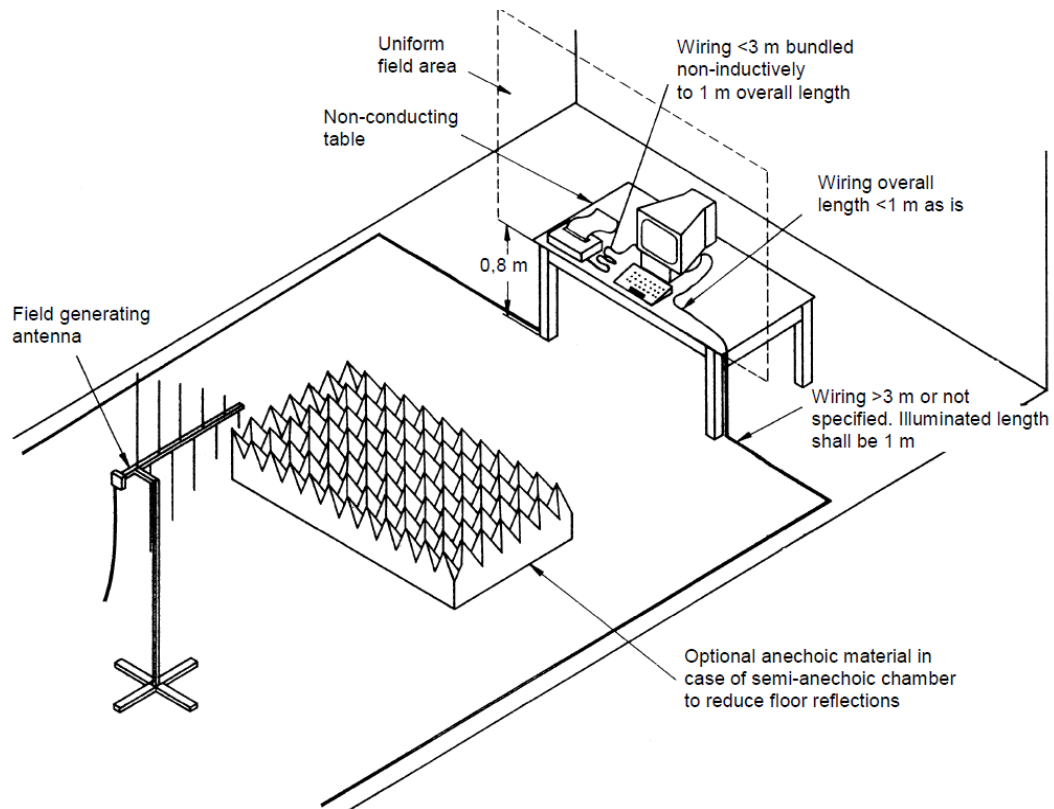
6.4.5 TEST SETUP

6.4.6 TEST RESULTS

Test Voltage	AC 230V/50Hz
Test Mode	HDMI1 3440*1440/100Hz

Frequency Range (MHz)	RF Field Position	R.F. Field Strength	Modulation	Azimuth	Criterion	Result
80 - 1000	H / V	3V/m	AM Modulated 1000Hz, 80%	0	A	A
				90		
				180		
				270		

6.5 ELECTRICAL FAST TRANSIENT/BURST IMMUNITY TEST (EFT/BURST)

6.5.1 TEST SPECIFICATION

Basic Standard	IEC 61000-4-4
Required Performance	B
Test Voltage	AC Power Ports:±1 kV
Polarity	Positive & Negative
Impulse Frequency	5 kHz: except for xDSL ports.
Impulse Wave shape	5/50 ns
Burst Duration	15 ms
Burst Period	300 ms
Test Duration	1 min.

6.5.2 MEASUREMENT INSTRUMENTS

Item	Kind of Equipment	Manufacturer	Type No.	Series Model	Calibrated until
1	THE MODULAR SOLUTION FOR 6 KV APPLICATIONS	Teseq	NSG 3060	1423	Aug. 03, 2020

Remark: "N/A" denotes no model no., no serial No. or no calibration specified.

All calibration period of equipment list is one year.

6.5.3 TEST PROCEDURE

For TABLE-TOP equipment:

The configuration consisted of a wooden table (0.8m high) standing on the Ground Reference Plane and should be located 0.1 m+/- 0.01m above the Ground Reference Plane. The GRP consisted of a sheet of aluminum (at least 0.25mm thick and 2.5m square) connected to the protective grounding system. A minimum distance of 0.5m was provided between the EUT and the walls of the laboratory or any other metallic structure.

The other condition as following manner:

- a. Both positive and negative polarity discharges were applied.
- b. The duration time of each test sequential was 1 minute

6.5.4 DEVIATION FROM TEST STANDARD

No deviation

6.5.5 TEST SETUP

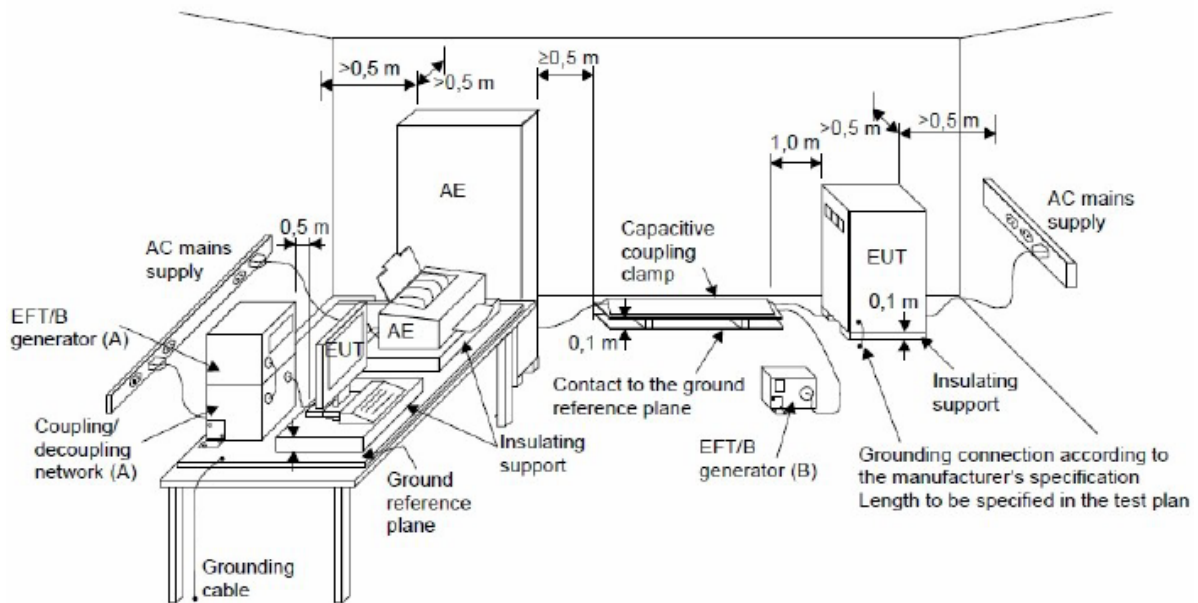

6.5.6 TEST RESULTS

Test Voltage	AC 230V/50Hz
Test Mode	HDMI1 3440*1440/100Hz

EUT Ports Tested		Polarity	Repetition Frequency	Test Level	Criterion	Result
				1kV		
AC Power Port	Line (L)	+	5 kHz	B	B	B
		-	5 kHz	B		
	Neutral (N)	+	5 kHz	B	B	B
		-	5 kHz	B		
	Ground (PE)	+	5 kHz	B	B	B
		-	5 kHz	B		
	L+N	+	5 kHz	B	B	B
		-	5 kHz	B		
	L+PE	+	5 kHz	B	B	B
		-	5 kHz	B		
	N+PE	+	5 kHz	B	B	B
		-	5 kHz	B		
	L+N+PE	+	5 kHz	B	B	B
		-	5 kHz	B		

6.6 SURGE IMMUNITY TEST

6.6.1 TEST SPECIFICATION

Basic Standard	IEC 61000-4-5
Required Performance	B (For AC/DC Power Ports)
Wave-Shape	1.2/50(8/20) Tr/Th μ s combination wave
Test Voltage	AC Power Port: ± 0.5 kV, ± 1 kV, ± 2 kV
Generator Source Impedance	2 Ω of the low-voltage power supply network. 12 Ω (10 Ω +2 Ω) of the low-voltage power supply network and ground.
Number of Tests & Polarity	5 positive and 5 negative at selected points
Phase Angle	AC Power Port: 0°/90°/180°/270°
Pulse Repetition Rate	1 time / min.

6.6.2 MEASUREMENT INSTRUMENTS

Item	Kind of Equipment	Manufacturer	Type No.	Series Model	Calibrated until
1	THE MODULAR SOLUTION FOR 6 KV APPLICATIONS	Teseq	NSG 3060	1423	Aug. 03, 2020

Remark: "N/A" denotes no model no., no serial No. or no calibration specified.

All calibration period of equipment list is one year.

6.6.3 TEST PROCEDURE

a. For EUT power supply:

The surge is to be applied to the EUT power supply terminals via the capacitive coupling network. Decoupling networks are required in order to avoid possible adverse effects on equipment not under test that may be powered by the same lines, and to provide sufficient decoupling impedance to the surge wave. The power cord between the EUT and the coupling/decoupling networks shall be 2meters in length (or shorter).

b. For test applied to unshielded unsymmetrically operated interconnection lines of EUT :

The surge is applied to the lines via the capacitive coupling. The coupling /decoupling networks shall not influence the specified functional conditions of the EUT. The interconnection line between the EUT and the coupling/decoupling networks shall be 2 meters in length (or shorter).

c. For test applied to unshielded symmetrically operated interconnection /telecommunication lines of EUT :

The surge is applied to the lines via gas arrestors coupling. Test levels below the ignition point of the coupling arrester cannot be specified. The interconnection line between the EUT and the coupling/decoupling networks shall be 2 meters in length (or shorter).

6.6.4 DEVIATION FROM TEST STANDARD

No deviation

6.6.5 TEST SETUP

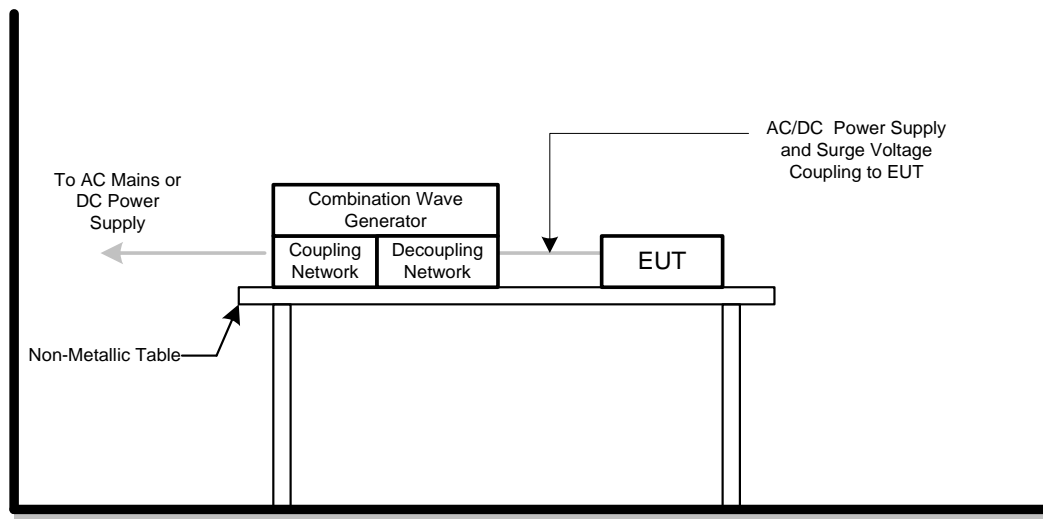

6.6.6 TEST RESULTS

Test Voltage	AC 230V/50Hz
Test Mode	HDMI1 3440*1440/100Hz

Wave Form EUT Ports Tested		1.2/50(8/20)Tr/Thµs						Criterion	Result
		Polarity	Phase	Voltage					
				0.5kV	1kV	-- kV	-- kV		
AC	L – N	+/-	0°	A	A	-	-	B	A
		+/-	90°	A	A	-	-		
		+/-	180°	A	A	-	-		
		+/-	270°	A	A	-	-		

Wave Form EUT Ports Tested		1.2/50(8/20)Tr/Thµs						Criterion	Result
		Polarity	Phase	Voltage					
				0.5kV	1kV	2kV	-- kV		
AC	L – PE	+/-	0°	A	A	A	-	B	A
		+/-	90°	A	A	A	-		
		+/-	180°	A	A	A	-		
		+/-	270°	A	A	A	-		
	N – PE	+/-	0°	A	A	A	-	B	A
		+/-	90°	A	A	A	-		
		+/-	180°	A	A	A	-		
		+/-	270°	A	A	A	-		

6.7 IMMUNITY TO CONDUCTED DISTURBANCES, INDUCED BY RADIO-FREQUENCY FIELDS TEST (CS)

6.7.1 TEST SPECIFICATION

Basic Standard	IEC 61000-4-6
Required Performance	A
Frequency Range	0.15 MHz - 80 MHz
Field Strength	3 V (unmodulated, r.m.s.)
Modulation	1 kHz Sine Wave, 80%, AM Modulation
Frequency Step	1% of fundamental
Dwell Time	3 seconds

6.7.2 MEASUREMENT INSTRUMENTS

Item	Kind of Equipment	Manufacturer	Type No.	Series Model	Calibrated until
1	Power CDN	FCC	FCC-801-M2 /M3-16A	100270	Mar. 10, 2020
2	TEST SYSTEM FOR CONDUCTED AND RADIATED IMMUNITY	TESEQ	NSG 4070B	37513	Aug. 03, 2020
3	Measurement Software	Farad	EZ-CS(V2.0.1.2)	N/A	N/A

Remark: "N/A" denotes no model no., no serial No. or no calibration specified.

All calibration period of equipment list is one year.

6.7.3 TEST PROCEDURE

The equipment to be tested is placed on an insulating support of 0.1m height above a reference ground plane. All cables exiting the EUT shall be supported at a height of at least 30 mm above the reference ground plane. All relevant cables shall be provided with the appropriate coupling and decoupling devices at a distance between 0.1 meters and 0.3 meters from the projected geometry of the EUT on the ground reference plane.

The other condition as following manner:

- a. The field strength level was 3 V (unmodulated, r.m.s.)
- b. The frequency range is swept from 150 kHz to 80 MHz, with the signal 80%amplitude modulated with a 1 kHz sine wave. The rate of sweep did not exceed 1.5×10^{-3} decade/s. Where the frequency range is swept incrementally, the step size was 1% of fundamental.
- c. The dwell time at each frequency shall be not less than the time necessary for the EUT to be able to respond.

6.7.4 DEVIATION FROM TEST STANDARD

No deviation

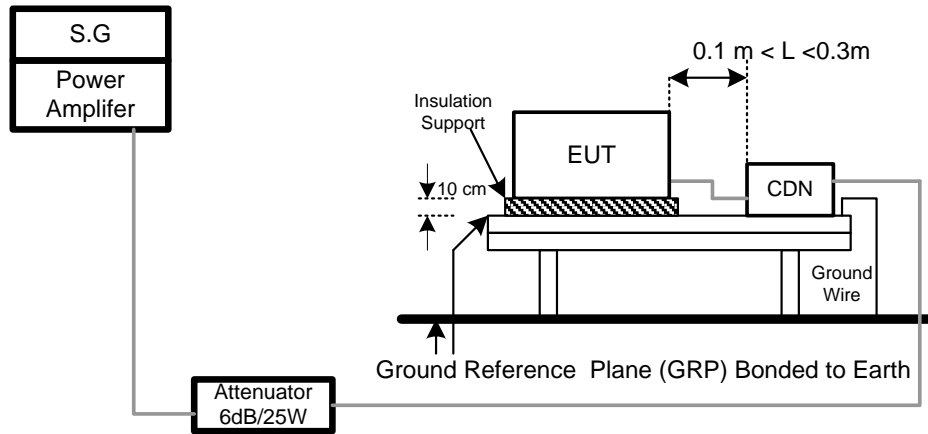
6.7.5 TEST SETUP

6.7.6 TEST RESULTS

Test Voltage	AC 230V/50Hz
Test Mode	HDMI1 3440*1440/100Hz

Test Ports (Mode)	Frequency Range (MHz)	Field Strength	Modulation	Criteria	Results
Input/ Output AC.Power Port	0.15 ---80	3V	AM Modulated 1000Hz, 80%	A	A

6.8 POWER FREQUENCY MAGNETIC FIELD IMMUNITY TEST (PFMF)

6.8.1 TEST SPECIFICATION

Basic Standard	IEC 61000-4-8
Required Performance	A
Frequency Range	50/60 Hz
Field Strength	1 A/m
Observation Time	1 minute
Inductance Coil	Rectangular type, 1mx1m

6.8.2 MEASUREMENT INSTRUMENTS

Item	Kind of Equipment	Manufacturer	Type No.	Series Model	Calibrated until
1	Magnetic Field test Generator	FCC	F-1000-4-8-G-125A	04032	Mar. 10, 2020
2	Magnetic Field immunity loop	Thermo KeyTek	F-1000-4-8/9/10-L-1M	04024	Mar. 10, 2020

Remark: "N/A" denotes no model no., no serial No. or no calibration specified.

All calibration period of equipment list is one year.

6.8.3 TEST PROCEDURE

For TABLE-TOP equipment:

The equipment shall be subjected to the test magnetic field by using the induction coil of standard dimension (1 m x 1 m). The induction coil shall then be rotated by 90 degrees in order to expose the EUT to the test field with different orientations.

The other condition as following manner:

- a. The equipment cabinets shall be connected to the safety earth directly on the GRP via the earth terminal of the EUT.
- b. The cables supplied or recommended by the equipment manufacturer shall be used. 1 meter of all cables used shall be exposed to the magnetic field.

6.8.4 DEVIATION FROM TEST STANDARD

No deviation

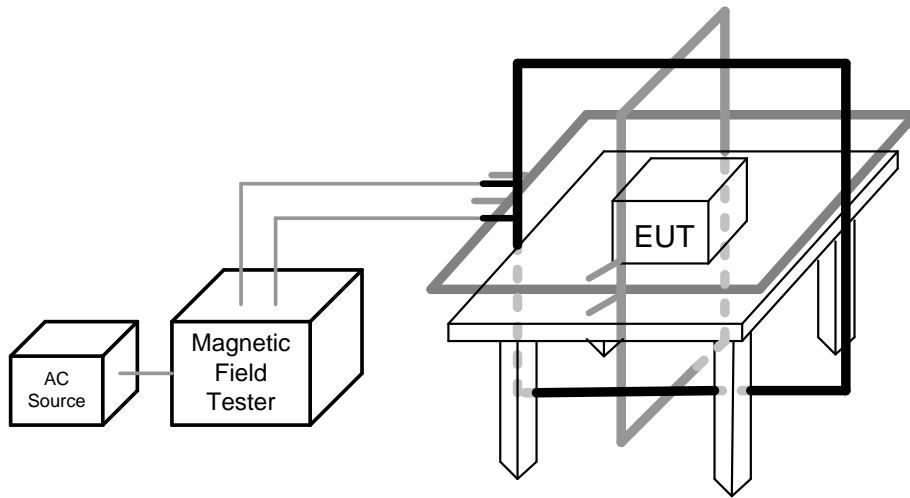
6.8.5 TEST SETUP

6.8.6 TEST RESULTS

Test Voltage	AC 230V/50Hz
Test Mode	HDMI1 3440*1440/100Hz

50Hz

Test Mode	Test Level	Antenna aspect	Duration (s)	Criteria	Results
Enclosure	1 A/m	X	60	A	A
Enclosure	1 A/m	Y	60	A	A
Enclosure	1 A/m	Z	60	A	A

60Hz

Test Mode	Test Level	Antenna aspect	Duration (s)	Criteria	Results
Enclosure	1 A/m	X	60	A	A
Enclosure	1 A/m	Y	60	A	A
Enclosure	1 A/m	Z	60	A	A

6.9 VOLTAGE DIPS, SHORT INTERRUPTIONS AND VOLTAGE VARIATIONS IMMUNITY TEST

6.9.1 TEST SPECIFICATION

Basic Standard	IEC 61000-4-11
Required Performance	B (For >95% Voltage Dips) C (For 30% Voltage Dips) C (For >95% Voltage Interruptions)
Interval between Event	Ten seconds
Phase Angle	0°/180°
Test Cycle	3 times

6.9.2 MEASUREMENT INSTRUMENTS

Item	Kind of Equipment	Manufacturer	Type No.	Series Model	Calibrated until
1	THE MODULAR SOLUTION FOR 6 KV APPLICATIONS	Teseq	NSG 3060	1423	Aug. 03, 2020

Remark: "N/A" denotes no model no., no serial No. or no calibration specified.

All calibration period of equipment list is one year.

6.9.3 TEST PROCEDURE

The EUT shall be tested for each selected combination of test levels and duration with a sequence of three dips/interruptions with intervals of 10 s minimum (between each test event). Each representative mode of operation shall be tested. Abrupt changes in supply voltage shall occur at zero crossings of the voltage waveform.

6.9.4 DEVIATION FROM TEST STANDARD

No deviation

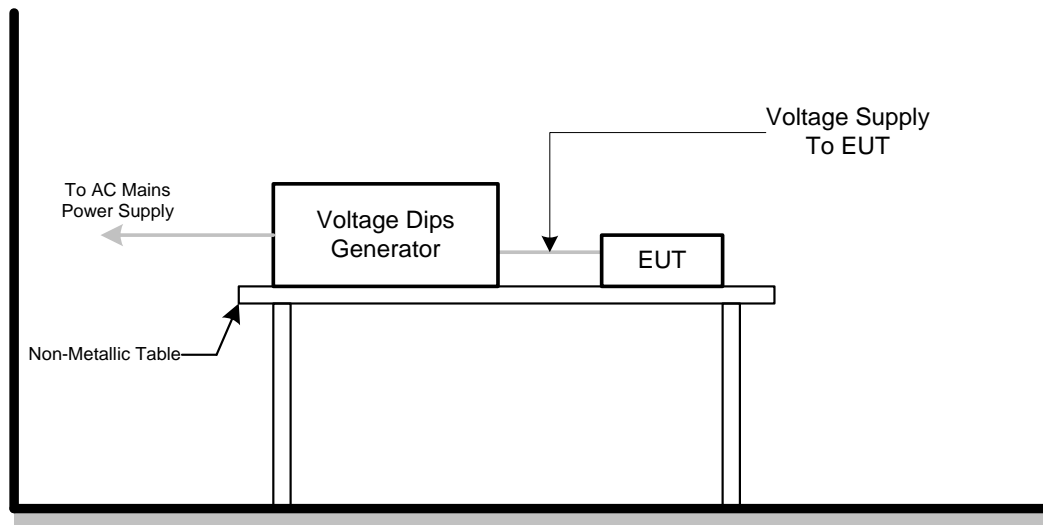
6.9.5 TEST SETUP

6.9.6 TEST RESULTS

Test Voltage	AC 100V/50Hz, AC 230V/50Hz, AC 240V/50Hz
Test Mode	HDMI1 3440*1440/100Hz

AC 100V/50Hz				
Item	Residual Voltage	Cycle	Criteria	Results
Voltage dips	>95%	0.5	B	A
Voltage dips	30%	25	C	A
Voltage Interruption	>95%	250	C	C

AC 230V/50Hz				
Item	Residual Voltage	Cycle	Criteria	Results
Voltage dips	>95%	0.5	B	A
Voltage dips	30%	25	C	A
Voltage Interruption	>95%	250	C	C

AC 240V/50Hz				
Item	Residual Voltage	Cycle	Criteria	Results
Voltage dips	>95%	0.5	B	A
Voltage dips	30%	25	C	A
Voltage Interruption	>95%	250	C	C

7. EUT TEST PHOTO

EN 55032:2012+AC:2013 &2015

Radiated emissions up to 1 GHz

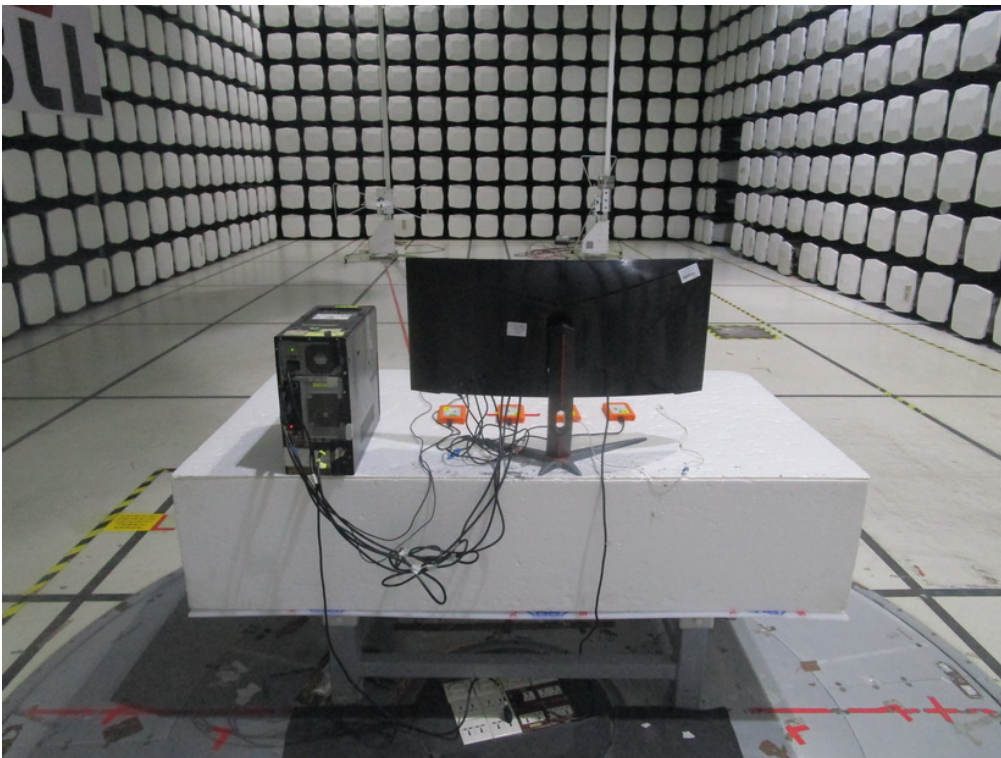
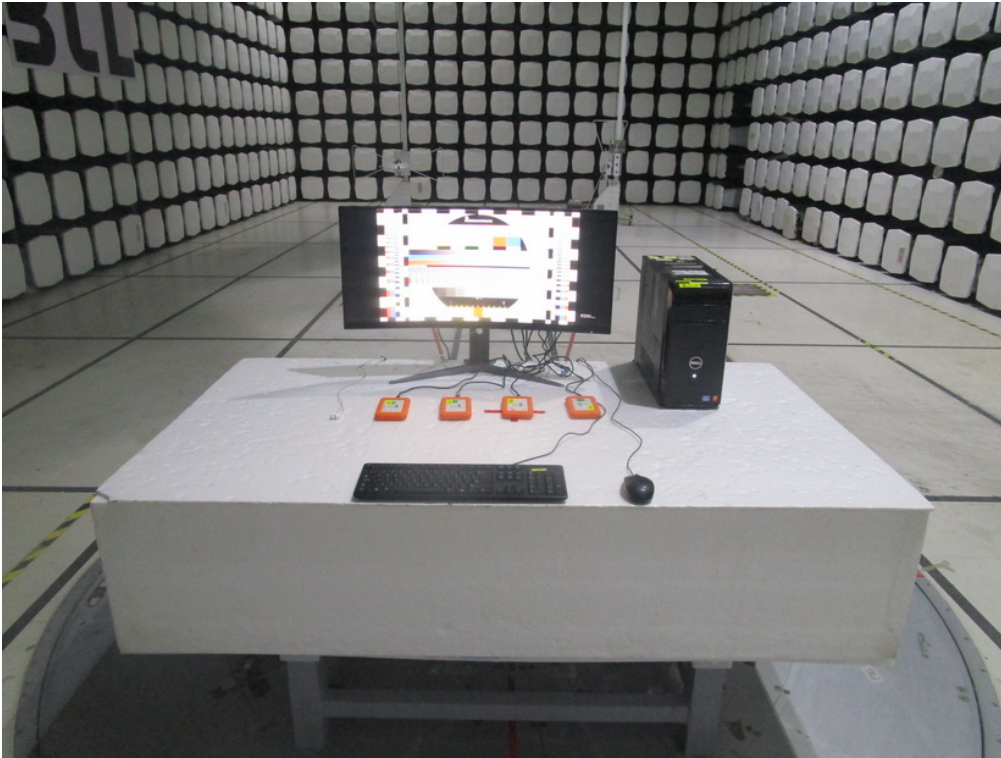

Radiated emissions above 1 GHz

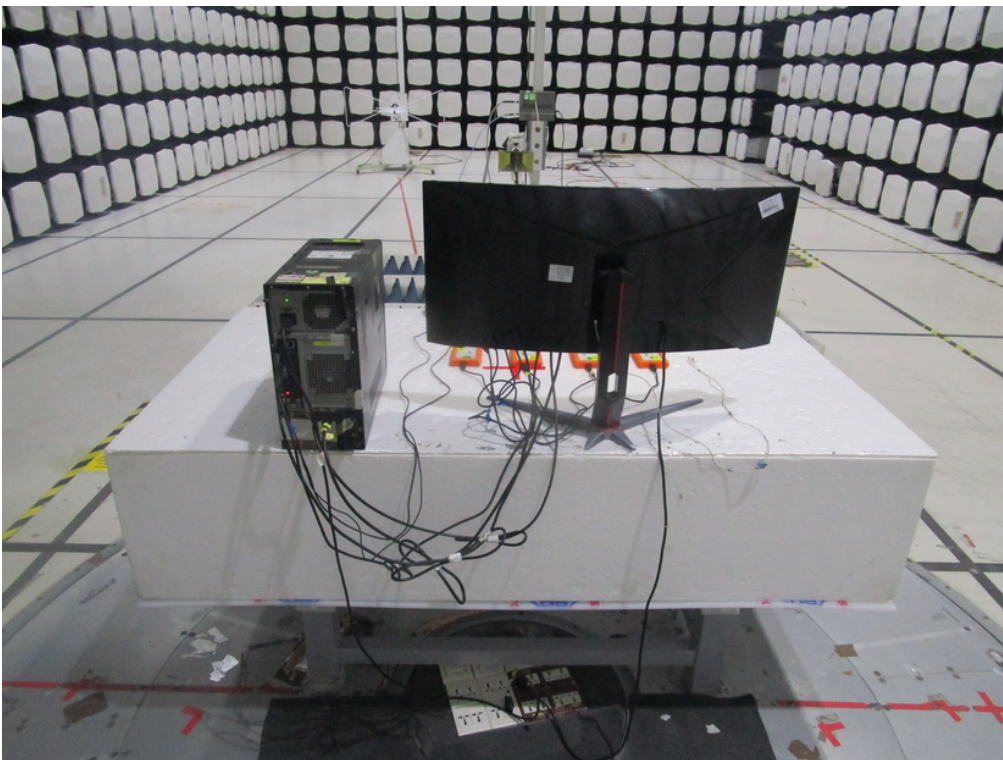
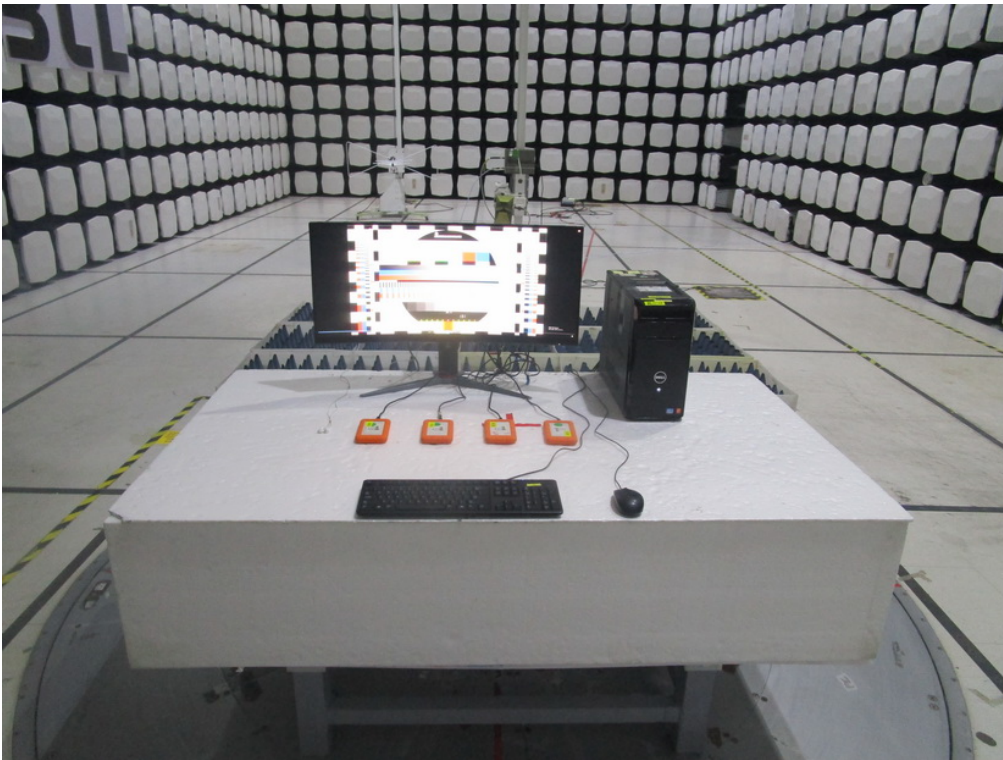

Conducted emissions AC mains power port

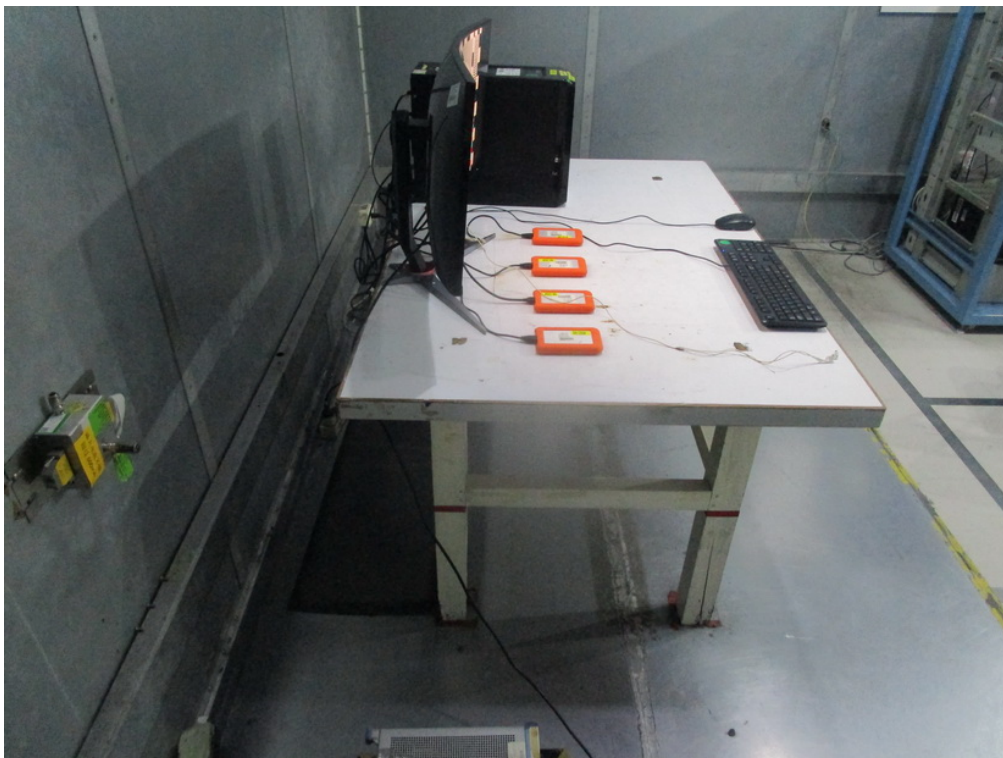

EN 55032:2015+AC:2016

Radiated emissions up to 1 GHz

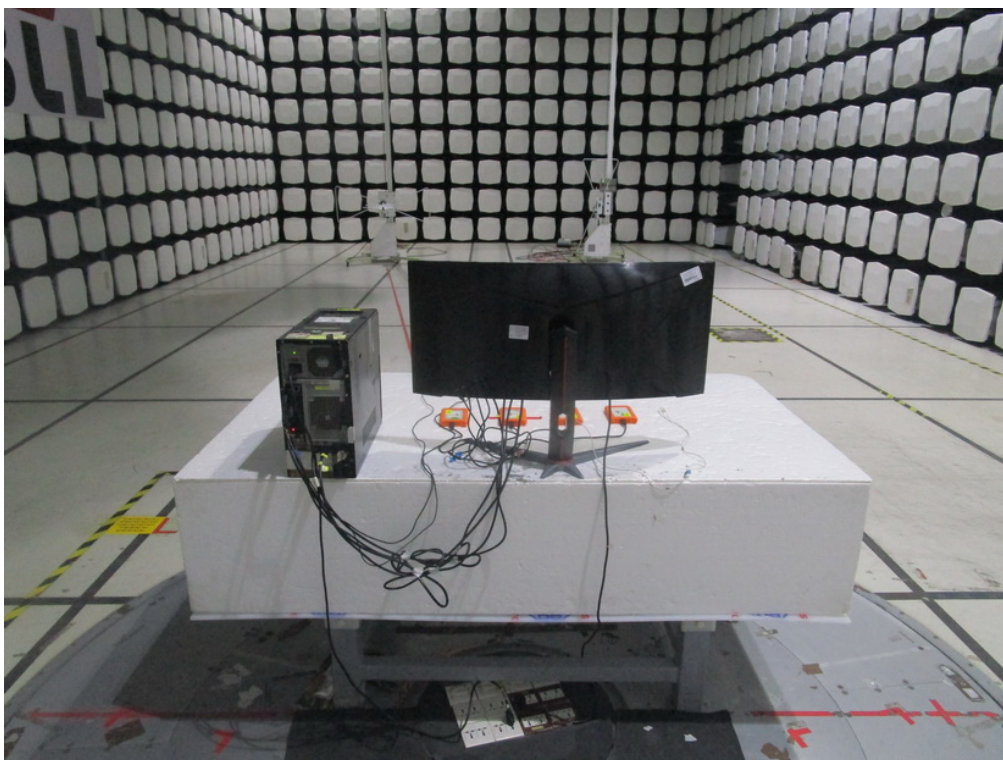
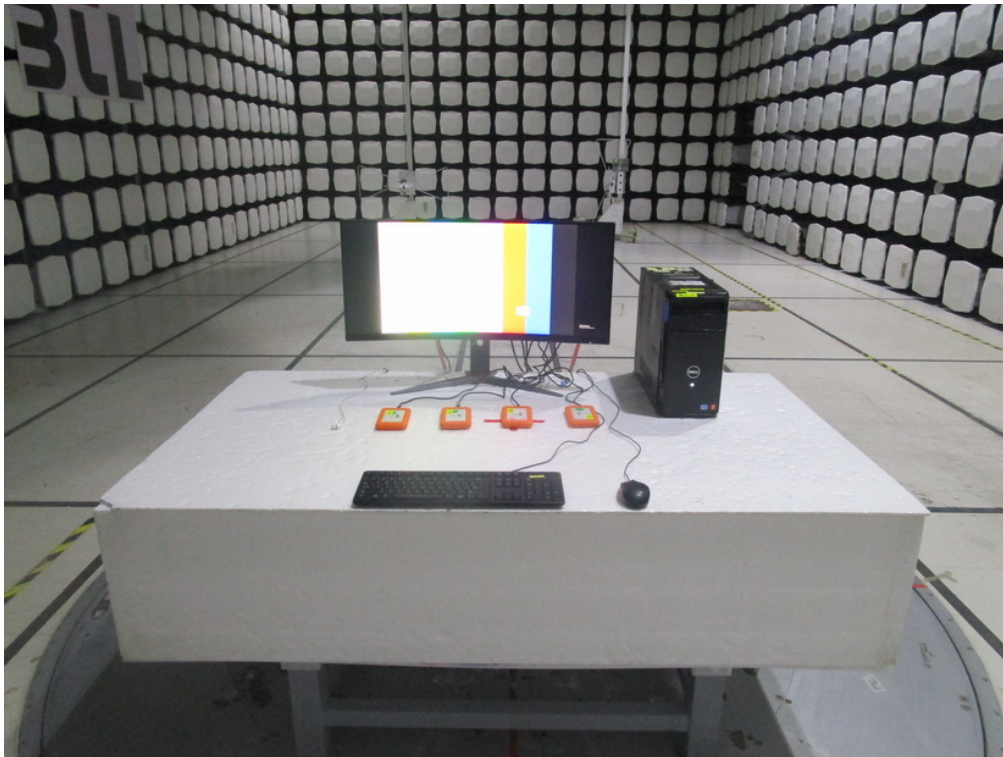

Radiated emissions above 1 GHz

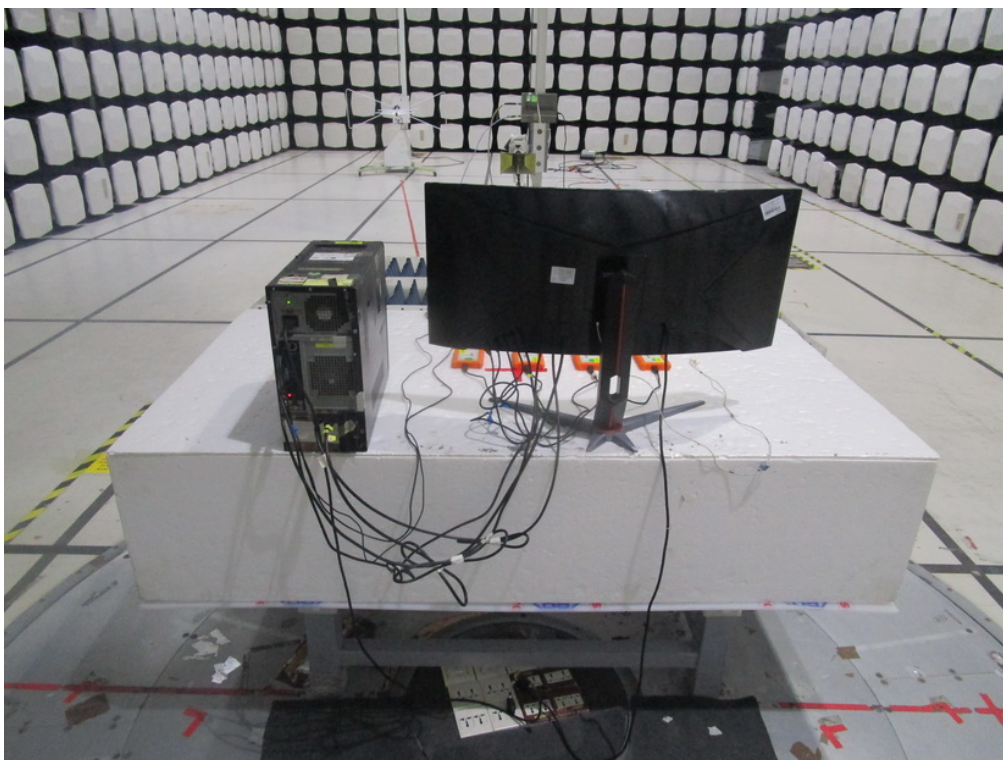
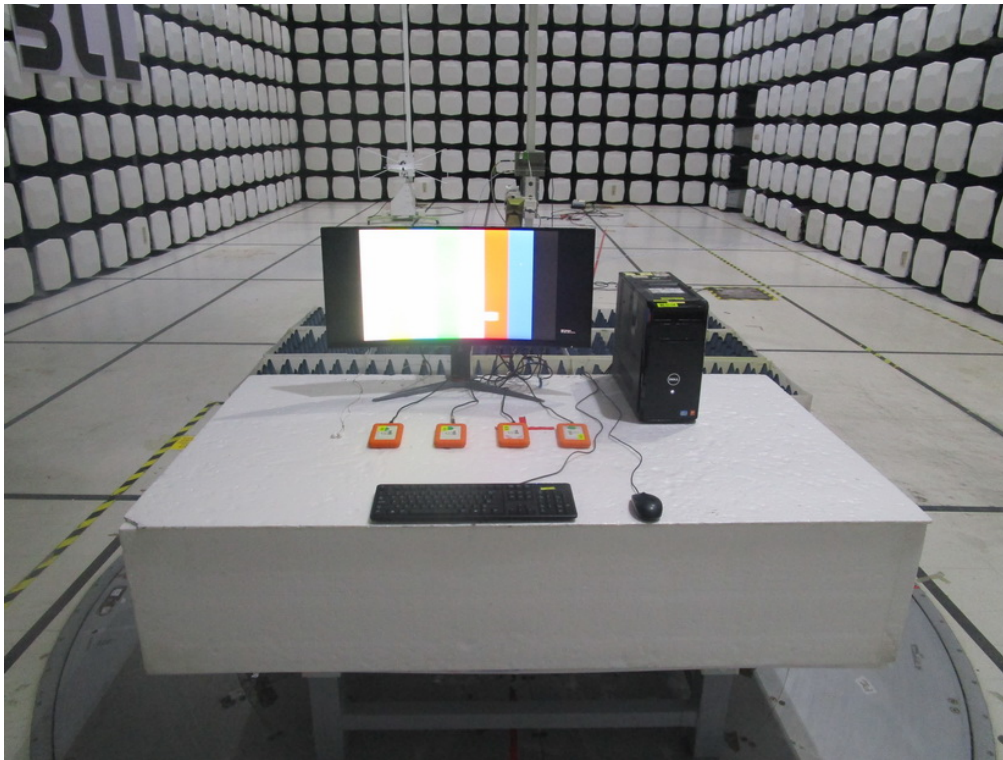

Conducted emissions AC mains power port

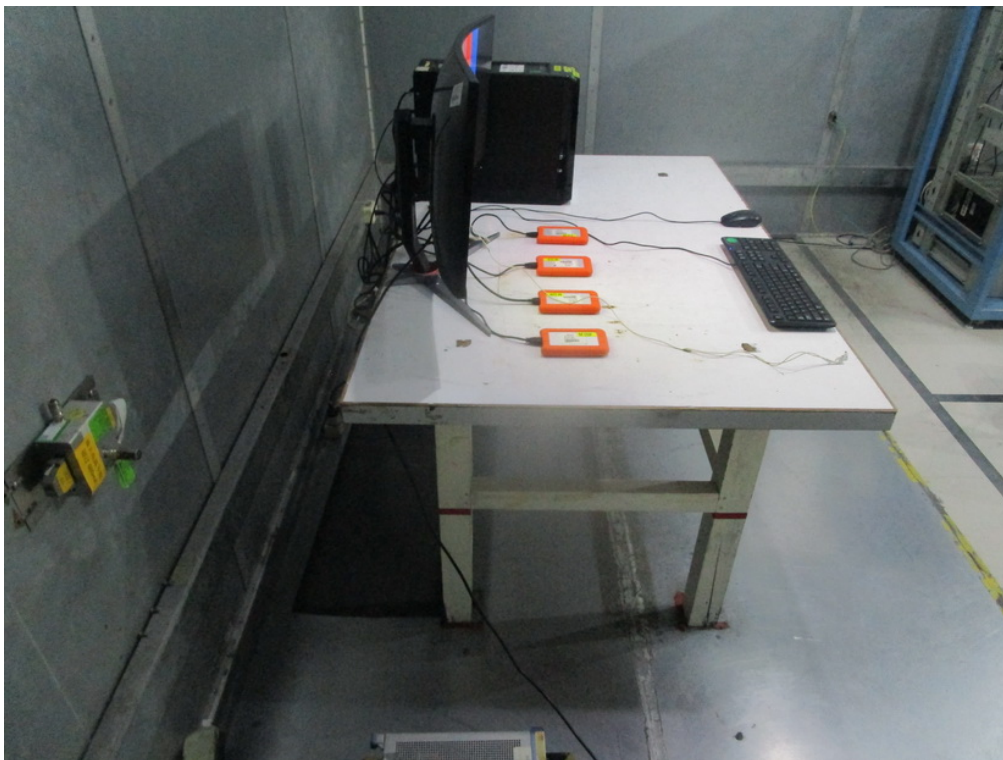

Harmonic current emissions



Voltage fluctuations (Flicker)

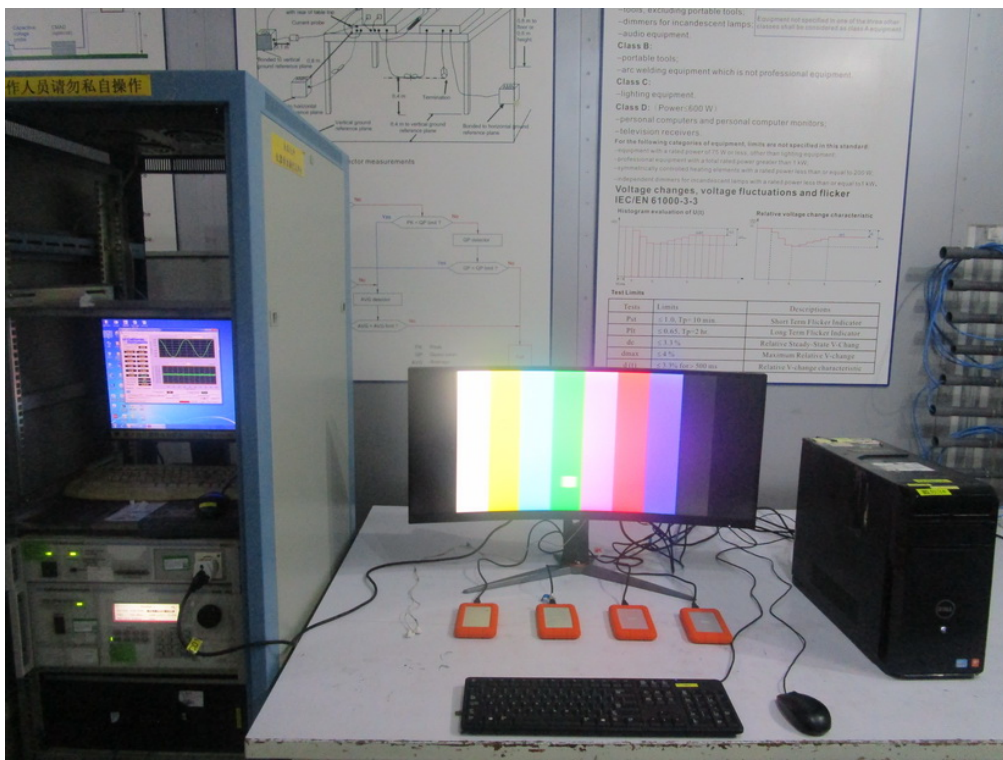

Electrostatic discharge immunity



Radiated, radio-frequency, electromagnetic field immunity



Electrical fast transient/burst immunity



Surge immunity



Immunity to conducted disturbances, induced by radio-frequency fields



Power frequency magnetic field immunity



Voltage dips, short interruptions and voltage variations immunity

**End of Test Report**