

TPV Electronics (Fujian) Co., Ltd.  
Mr. Xinliang Wu  
RD-SE  
Rongqiao Economic and  
Technological Development Zone  
Fuqing City, Fujian Province  
P. R. China

Date : 09.10.2019  
Our ref. : WangAn SZ  
Your ref.: 168123373

**Ref : CB Certificate Japan**

Type of Equipment : LCD MONITOR  
Model Designation : See Certificate  
Certificate No. : JPTUV-101092  
Report No. : 50298194 001

Dear Mr. Xinliang Wu,

Thank you very much for your interest in our services.

Please find enclosed your certification documents.

We appreciate your support and would like to offer our assistance in the approval of your future products through our extensive range of technical services.

Please feel free to contact us whatever your requirements may be.

With kind regards,

Certification Body

Aegean Li



Enclosure

证书的详细资料请登陆[www.certipedia.com](http://www.certipedia.com)查阅,或拨打我司客服热线800 999 3668 / 400 883 1300咨询



Ref. Certif. No.

JPTUV-101092

IEC SYSTEM FOR MUTUAL RECOGNITION OF TEST  
CERTIFICATES FOR ELECTRICAL EQUIPMENT  
(IECEE) CB SCHEME

SYSTEME CEI D'ACCEPTATION MUTUELLE DE  
CERTIFICATS D ESSAIS DES EQUIPEMENTS  
ELECTRIQUES (IECEE) METHODE OC

## CB TEST CERTIFICATE

## CERTIFICAT D'ESSAI OC

Product  
Produit

LCD MONITOR

Name and address of the applicant  
Nom et adresse du demandeur

TPV Electronics (Fujian) Co., Ltd.  
Rongqiao Economic and  
Technological Development Zone, Fuqing City, Fujian Province, P. R.  
China

Name and address of the manufacturer  
Nom et adresse du fabricant

TPV Electronics (Fujian) Co., Ltd.  
Rongqiao Economic and  
Technological Development Zone, Fuqing City, Fujian Province, P. R.  
China

Name and address of the factory  
Nom et adresse de l'usine

See additional page(s)

Ratings and principal characteristics  
Valeurs nominales et caractéristiques principales

AC 100-240V; 50/60Hz; 1.5A; Class I

Trademark (if any)  
Marque de fabrique (si elle existe)

AOC

Type of Manufacturer's Testing Laboratories used  
Type de programme du laboratoire d'essais constructeur

N/A

Model / Type Ref.  
Ref. de type

34G2, 34G2X, \*\*34G2\*\*\*\*\*  
(\* can be 0-9, A-Z, a-z, -, \, /, + or blank)

Additional information (if necessary may also be  
reported on page 2)  
Les informations complémentaires (si nécessaire,  
peuvent être indiqués sur la 2<sup>ème</sup> page)

For model differences, refer to the test report.

A sample of the product was tested and found  
to be in conformity with  
Un échantillon de ce produit a été essayé et a été  
considéré conforme à la

IEC 60950-1:2005+A1+A2  
See Test Report for National Differences

As shown in the Test Report Ref. No. which forms part  
of this Certificate  
Comme indiqué dans le Rapport d'essais numéro de  
référence qui constitue partie de ce Certificat

50298194 001

This CB Test Certificate is issued by the National Certification Body  
Ce Certificat d'essai OC est établi par l'Organisme National de Certification



TÜV Rheinland Japan Ltd.  
Global Technology Assessment Center  
4-25-2 Kita-Yamata, Tsuzuki-ku  
Yokohama 224-0021 Japan  
Phone + 81 45 914-3888  
Fax + 81 45 914-3354  
Mail: info@jpn.tuv.com  
Web: www.tuv.com

Date: 09.10.2019

Signature:

Aegean Li

1. TPV Display Technology (Wuhan) Co., Ltd.  
Unique No. 11, Zhuankou Development District of Economic Technological Development Zone, Wuhan City 430056, P. R. China
2. TPV Electronics (Fujian) Co., Ltd.  
Shangzheng, Yuan Hong Road  
Fuqing City, Fujian Province  
P. R. China
3. L&T Display Technology (Fujian) Ltd.  
Optoelectronic Park, Rongqiao Economic and Technological Development Zone  
Fuqing, Fujian 350301, P. R. China
4. TPV Electronics (Fujian) Co., Ltd.  
Rongqiao Economic and Technological Development Zone  
Fuqing City, Fujian Province  
P. R. China
5. Trend Smart CE Mexico S de RL de CV  
Avenida Sor Juana Ines de la Cruz de 19602 Nueva Tijuana,  
22435 Tijuana Baja California  
MEXICO
6. TPV Display Technology (Beihai) Co., Ltd.  
China Electronic Beihai Industry Park, Northeast of the Crossing Between Taiwan Road and Jilin Road, Beihai City, Guangxi, P. R. China
7. TPV Technology (Qingdao) Co., Ltd.  
No.99 Huoju Road, High-tech Industrial Development Zone  
Qingdao City, Shandong Province, P. R. China
8. TPV Display Technology (China) Co., Ltd.  
No. 106 Jinghai 3 Rd., BDA  
Beijing City 100176  
P. R. China
9. TPV Electronics (Fujian) Co., Ltd.  
Optoelectronic Park,  
Rongqiao Economic and Technological Development Zone,  
Fuqing City, Fujian Province 350301, P. R. China

**Additional information (if necessary)**  
**Information complémentaire (si nécessaire)**

Report Ref. No.: 50298194 001

Date: 09.10.2019

Signature:



Aegean Li

10. Envision Indústria de Produtos Eletrônicos Ltda.  
Av. Torquato Tapajós, 2236,  
Flores - CEP 69058-830 - Manaus/AM  
Brazil
11. Pro Concept Manufacturer Co., Ltd  
88/1 Moo 12, Soi  
Phetkasem120, Phetkasem  
Road, Omnoi, Krathumbaen,  
Samutsakhon 74130, Thailand
12. Treeview Co., Ltd.  
106/29 Moo 8, Sukhumvit Road, T.Banglamung,  
A.Banglamung, Chonburi 20150  
Thailand
13. TPV Technology (Thailand) Co., Ltd.  
Tambon Tha Turn,  
Amphoe Si Maha Phot,  
Chang Wat Prachin Buri 25140  
Thailand

**Additional information (if necessary)**  
**Information complémentaire (si nécessaire)**

Report Ref. No.: 50298194 001



Date: 09.10.2019

Signature:

Aegean Li



Test Report issued under the responsibility of:



**TEST REPORT**  
**IEC 60950-1**  
**Information technology equipment – Safety –**  
**Part 1: General requirements**

**Report Number** .....: 50298194 001  
**Date of issue** .....: 06.Oct.2019  
**Total number of pages**.....: 63 pages

**Name of Testing Laboratory preparing the Report**.....: TÜV Rheinland (Shenzhen) Co., Ltd.

**Applicant’s name** .....: TPV Electronics (Fujian) Co., Ltd.  
**Address** .....: Rongqiao Economic and Technological Development Zone, Fuqing City, Fujian Province, P.R. China

**Test specification:**  
**Standard** .....: IEC 60950-1:2005, AMD1:2009, AMD2:2013

**Test procedure**.....: CB Scheme  
**Non-standard test method**.....: N/A

**Test Report Form No**.....: IEC60950\_1G  
**Test Report Form(s) Originator**.....: SGS Fimko Ltd  
**Master TRF** .....: Dated 2019-07-02



**Copyright © 2019 IEC System of Conformity Assessment Schemes for Electrotechnical Equipment and Components (IECEE System). All rights reserved.**

This publication may be reproduced in whole or in part for non-commercial purposes as long as the IECEE is acknowledged as copyright owner and source of the material. IECEE takes no responsibility for and will not assume liability for damages resulting from the reader's interpretation of the reproduced material due to its placement and context.

If this Test Report Form is used by non-IECEE members, the IECEE/IEC logo and the reference to the CB Scheme procedure shall be removed.

**This report is not valid as a CB Test Report unless signed by an approved CB Testing Laboratory and appended to a CB Test Certificate issued by an NCB in accordance with IECEE 02.**

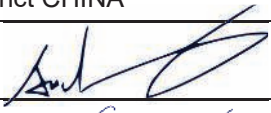
**General disclaimer:**  
The test results presented in this report relate only to the object tested.  
This report shall not be reproduced, except in full, without the written approval of the Issuing CB Testing Laboratory. The authenticity of this Test Report and its contents can be verified by contacting the NCB, responsible for this Test Report.

<b>Test item description</b> .....		LCD MONITOR	
<b>Trade Mark</b> .....		AOC	
<b>Manufacturer</b> .....		Same as applicant.	
<b>Model/Type reference</b> .....		34G2, 34G2X, **34G2***** (* can be 0-9, A-Z, a-z, -, \, /, + or blank, represent different enclosure colour for marketing purpose)	
<b>Ratings</b> .....		I/P: 100-240V~, 50/60Hz, 1.5A.	
<b>Responsible Testing Laboratory (as applicable), testing procedure and testing location(s):</b>			
<input checked="" type="checkbox"/>	<b>CB Testing Laboratory:</b>	TÜV Rheinland (Shenzhen) Co., Ltd.	
<b>Testing location/ address</b> .....		East of F/1, F/2~F/4, Building 1, Cybio Technology Building No. 6 Langshan No.2 Road, North Hi-tech Industry Park 518057 Shenzhen Nanshan District CHINA	
<b>Tested by (name, function, signature)</b> .....		Anderson Wang Senior Project Manager	
<b>Approved by (name, function, signature)</b> ..		Steven Lin Technical Reviewer	
<input type="checkbox"/>	<b>Testing procedure: CTF Stage 1:</b>		
<b>Testing location/ address</b> .....			
<b>Tested by (name, function, signature)</b> .....			
<b>Approved by (name, function, signature)</b> ..			
<input type="checkbox"/>	<b>Testing procedure: CTF Stage 2:</b>		
<b>Testing location/ address</b> .....			
<b>Tested by (name + signature)</b> .....			
<b>Witnessed by (name, function, signature)</b> .			
<b>Approved by (name, function, signature)</b> ..			
<input type="checkbox"/>	<b>Testing procedure: CTF Stage 3:</b>		
<input type="checkbox"/>	<b>Testing procedure: CTF Stage 4:</b>		
<b>Testing location/ address</b> .....			
<b>Tested by (name, function, signature)</b> .....			
<b>Witnessed by (name, function, signature)</b> .			
<b>Approved by (name, function, signature)</b> ..			
<b>Supervised by (name, function, signature)</b> :			

**List of Attachments (including a total number of pages in each attachment):**

- Photo documentation (8 Pages)
- National Differences (68 Pages)
- Measurement Section (2 Pages)

**Summary of testing:****Tests performed (name of test and test clause):**

name of test	test clause number
Input Current Test	1.6.2
Durability of Marking Test	1.7.11
Access to energized parts	2.1.1.1
Energy hazard in Operator Access Area	2.1.1.5
Discharge of Capacitors	2.1.1.7
SELV limits for Normal Conditions	2.2.2
SELV limits for Abnormal Conditions	2.2.3
Limited current circuit	2.4
Limited power source	2.5
Resistance of Earthing Circuit	2.6.3.4
Humidity Conditioning	2.9.2
Working Voltage over Insulation	2.10.2
Clearance and creepage distance measurements	2.10.3 & 2.10.4
Steady force test, 10 N	4.2.2
Steady Force Test, 30N	4.2.3
Steady Force Test, 250N	4.2.4
Impact Test	4.2.5
Stress Relief Test	4.2.7
Wall mounting test	4.2.10
Maximum Temperature Test	4.5.2
Ball pressure test	4.5.5
Openings in enclosures	4.6
Touch current and protective conductor current	5.1.6
Electric Strength Test	5.2
Fault Condition Test	5.3

The EUT passed the test.

**Testing location:**

All tests as described in Test Case and Measurement Sections were performed at the laboratory described on page 2.

**Summary of compliance with National Differences (List of countries addressed):**

EU Group Differences, EU Special National Conditions, EU A-Deviations, AT, AU, BE, CA, CH, CN, CZ, DE, DK, FI, FR, GB, GR, HU, IT, IL\*, JP, KR\*, NL, NO, PL, SE, SI, SK, US

Explanation of used codes: AT=Austria, AU=Australia, BE=Belgium, CA=Canada, CH=Switzerland, CN=China, CZ=Czech Republic, DE=Germany, DK=Denmark, FI=Finland, FR=France, GB=United Kingdom, GR=Greece, HU=Hungary, IT=Italy, IL=Israel, JP=Japan, KR=Korea, NL=The Netherlands, NO=Norway, PL=Poland, SE=Sweden, SI=Slovenia, SK=Slovakia, US=United States of America

For National Differences see end of this test report.

\* National differences to IEC 60950-1:2005 (Second Edition) + Am 1:2009 evaluated.

The product fulfils the requirements of EN 60950-1:2006 + A11:2009 + A1:2010 + A12:2011 + A2:2013.

**Copy of marking plate**

The artwork below may be only a draft. The use of certification marks on a product must be authorized by the respective NCBs that own these marks.

**AOC** LCD MONITOR (LED backlight)  
/ ЖК-МОНИТОР

Product No.: **CU34G2**

Model No./модель номер: **34G2**

Power Rating/Тегangan/Входная мощность:  
100-240V ~ 50/60Hz 1.5A  
www.aoc.com Made in China/Сделано в Китае  
CAN ICES-3(B)/NMB-3(B)  
Laitte on liitettävä suojakoskettimilla varustettuun pistorasiaan  
Apparalet må tilkoples jordet stikkontakt  
Apparalet skal anslutas til jordet uttag  
Apparalets stikprop skal tilsluttes en stikkontakt med jord.  
Som gver forbindelse til stikproppens jord  
The equipment must be connected to an earthed mains socket-outlet.  
L'appareil doit être branché sur une prise de courant munie d'une mise à la terre.  
Q40G034N-03A

TPV Electronics (Fujian) Co., Ltd.

Envision Peripherals, Inc.  
47490 Seabridge Drive  
Fremont, CA 94538  
USA

AOC International Europe B.V.  
Amstelgebouw, 6th floor  
Prins Bernhardplein 200  
1097 JB Amsterdam  
The Netherlands

Warning: Shock Hazard, Do Not Open.  
Pour éviter une électrocution, ne retirez pas le couvercle!

XXXXXXXXXXXXXX  
Serial/No.: XXXXXXXXXXXXXXXX

Manufactured: 201X-XX-XX

---

**AOC** LCD MONITOR (LED backlight)  
/ ЖК-МОНИТОР

Product No.: **CU34G2X**

Model No./модель номер: **34G2X**

Power Rating/Тегangan/Входная мощность:  
100-240V ~ 50/60Hz 1.5A  
www.aoc.com Made in China/Сделано в Китае  
CAN ICES-3(B)/NMB-3(B)  
Laitte on liitettävä suojakoskettimilla varustettuun pistorasiaan  
Apparalet må tilkoples jordet stikkontakt  
Apparalet skal anslutas til jordet uttag  
Apparalets stikprop skal tilsluttes en stikkontakt med jord.  
Som gver forbindelse til stikproppens jord  
The equipment must be connected to an earthed mains socket-outlet.  
L'appareil doit être branché sur une prise de courant munie d'une mise à la terre.  
Q40G034N-03A

TPV Electronics (Fujian) Co., Ltd.

Envision Peripherals, Inc.  
47490 Seabridge Drive  
Fremont, CA 94538  
USA

AOC International Europe B.V.  
Amstelgebouw, 6th floor  
Prins Bernhardplein 200  
1097 JB Amsterdam  
The Netherlands

Warning: Shock Hazard, Do Not Open.  
Pour éviter une électrocution, ne retirez pas le couvercle!

XXXXXXXXXXXXXX  
Serial/No.: XXXXXXXXXXXXXXXX

Manufactured: 201X-XX-XX

Notes: The above label represents labels for model names other than above covered by the model name.

TRF No. IEC60950\_1G



<b>Test item particulars</b> .....:	
<b>Equipment mobility</b> .....:	<input checked="" type="checkbox"/> movable (for unit with base stand) <input type="checkbox"/> hand-held <input type="checkbox"/> transportable <input checked="" type="checkbox"/> stationary (for unit without base stand) <input type="checkbox"/> for building-in <input type="checkbox"/> direct plug-in
<b>Connection to the mains</b> .....	<input checked="" type="checkbox"/> pluggable equipment <input checked="" type="checkbox"/> type A <input type="checkbox"/> type B <input type="checkbox"/> permanent connection <input checked="" type="checkbox"/> detachable power supply cord <input type="checkbox"/> non-detachable power supply cord <input type="checkbox"/> not directly connected to the mains
<b>Operating condition</b> .....:	<input checked="" type="checkbox"/> continuous <input type="checkbox"/> rated operating / resting time:
<b>Access location</b> .....	<input checked="" type="checkbox"/> operator accessible <input type="checkbox"/> restricted access location
<b>Over voltage category (OVC)</b> .....	<input type="checkbox"/> OVC I <input checked="" type="checkbox"/> OVC II <input type="checkbox"/> OVC III <input type="checkbox"/> OVC IV <input type="checkbox"/> other:
<b>Mains supply tolerance (%) or absolute mains supply values</b> .....	$\pm 10\%$ (requested by client)
<b>Tested for IT power systems</b> .....	<input checked="" type="checkbox"/> Yes <input type="checkbox"/> No
<b>IT testing, phase-phase voltage (V)</b> .....	230 for Norway
<b>Class of equipment</b> .....	<input checked="" type="checkbox"/> Class I <input type="checkbox"/> Class II <input type="checkbox"/> Class III <input type="checkbox"/> Not classified
<b>Considered current rating of protective device as part of the building installation (A)</b> .....	16A (20A for North America)
<b>Pollution degree (PD)</b> .....	<input type="checkbox"/> PD 1 <input checked="" type="checkbox"/> PD 2 <input type="checkbox"/> PD 3
<b>IP protection class</b> .....	IP20
<b>Altitude during operation (m)</b> .....	$\leq 5000$
<b>Altitude of test laboratory (m)</b> .....	$< 2000$
<b>Mass of equipment (kg)</b> .....	Whole unit with base: 8.02kg; Base weight: 1.51kg
<b>Possible test case verdicts:</b>	
- test case does not apply to the test object .....	N/A
- test object does meet the requirement .....	P (Pass)
- test object does not meet the requirement .....	F (Fail)
<b>Testing</b> .....:	
<b>Date of receipt of test item</b> .....:	12.Jul.2019
<b>Date(s) of performance of tests</b> .....	01.Aug.2019 – 26.Sep.2019
<b>General remarks:</b>	
"(see Enclosure #)" refers to additional information appended to the report. "(see appended table)" refers to a table appended to the report.	
Throughout this report a <input type="checkbox"/> comma / <input checked="" type="checkbox"/> point is used as the decimal separator.	

**Manufacturer's Declaration per sub-clause 4.2.5 of IECEE 02:**

The application for obtaining a CB Test Certificate includes more than one factory location and a declaration from the Manufacturer stating that the sample(s) submitted for evaluation is (are) representative of the products from each factory has been provided .....:  **Yes**  
 **Not applicable**

**When differences exist; they shall be identified in the General product information section.**

**Name and address of factory (ies)..... :**

- 1 TPV Display Technology (Wuhan) Co., Ltd.  
Unique No. 11, Zhuankou Development District of Economic Technological Development Zone, Wuhan City 430056, P.R. China
- 2 TPV Electronics (Fujian) Co., Ltd.  
Shangzheng, Yuan Hong Road, Fuqing City, Fujian Province, P.R. China
- 3 L&T Display Technology (Fujian) Ltd.  
Optoelectronic Park, Rongqiao Economic and Technological, Development Zone, Fuqing, Fujian 350301, P.R. China
- 4 TPV Electronics (Fujian) Co., Ltd.  
Rongqiao Economic and Technological Development Zone, Fuqing City, Fujian Province, P.R. China
- 5 Trend Smart CE Mexico S de RL de CV  
Avenida Sor Juana Ines de la Cruz de 19602 Nueva Tijuana, 22435 Tijuans Baja California, MEXICO
- 6 TPV Display Technology (Beihai) Co., Ltd.  
China Electronic Beihai Industry Park, Northeast of the Crossing Between Taiwan Road and Jilin Road, Beihai City, Guangxi, P.R. China
- 7 TPV Technology (Qingdao) Co., Ltd.  
No.99 Huoju Road, High-tech Industrial Development Zone, Qingdao City, Shandong Province, P.R. China
- 8 TPV Display Technology (China) Co., Ltd.  
No.106 Jinghai 3 Rd., BDA, Beijing City 100176, P.R. China.
- 9 TPV Electronics (Fujian) Co., Ltd.  
Optoelectronic Park, Rongqiao Economic and Technological Development Zone, Fuqing City, Fujian Province, P.R. China
- 10 Envision Indústria de Produtos Eletrônicos Ltda.  
Av. Torquato Tapajós, 2236, Flores - CEP 69058-830 - Manaus/AM Brasil
- 11 Pro Concept Manufacturer Co., Ltd.  
88/1 Moo 12, Soi Phetkasem 120, Phetkasem Road, Omnoi, Krathumbaen, Samutsakhon 74130, Thailand
- 12 Treeview Co., Ltd.  
106/29 Moo 8, Sukhumvit Road, T.Banglamung, A.Banglamung, Chonburi 20150 Thailand
- 13 TPV Technology (Thailand) Co., Ltd.  
Tambon Tha Turn, Amphoe Si Maha Phot, Chang Wat Prachin Buri 25140 Thailand

**General product information:**

The models are LCD MONITOR intended for general office use and information technology equipment with following features:

1. LCD Type: 34.0 inch curve TFT LCD with LED backlight;
2. Building-in power supply board 715GA649;
3. Main board 715GA732 with HDMI\*1, DisplayPort\*2, USB 3.0 type C\*1, USB 3.0 type A\*2 ports;
4. Extend USB board 715GA629;
5. The internal metal chassis is considered as fire enclosure and mechanical enclosure, and the external plastic enclosure is regarded as electrical enclosure and mechanical enclosure, made of min. HB material;
6. Maximum declared ambient: 40°C.
7. All models are identical except for mode designation.

**Additional information:**

1. The manufacturer declared that the product also fulfilled of the requirements of SANS 60950-1: 2014 (Edition 2.2) / IEC 60950-1: 2013 (Edition 2.2).

Other comments:

Declaration of the manufacturer: the sample(s) submitted for evaluation is (are) representative of the products from each factory.

**Abbreviations used in the report:**

- normal conditions	<b>N.C.</b>	- single fault conditions	<b>S.F.C</b>
- functional insulation	<b>OP</b>	- basic insulation	<b>BI</b>
- double insulation	<b>DI</b>	- supplementary insulation	<b>SI</b>
- between parts of opposite polarity	<b>BOP</b>	- reinforced insulation	<b>RI</b>

**Indicate used abbreviations (if any)**

<b>IEC 60950-1</b>			
Clause	Requirement + Test	Result - Remark	Verdict
<b>1</b>	<b>GENERAL</b>		<b>P</b>
<b>1.5</b>	<b>Components</b>		<b>P</b>
1.5.1	General		<b>P</b>
	Comply with IEC 60950-1 or relevant component standard	(see appended table 1.5.1)	<b>P</b>
1.5.2	Evaluation and testing of components	Components which are certified to IEC and/or national standards are used correctly within their ratings. Components not covered by IEC standards are tested under the conditions present in the equipment.	<b>P</b>
1.5.3	Thermal controls	No thermal controls.	<b>N/A</b>
1.5.4	Transformers	Transformers used are suitable for their intended application and comply with the relevant requirements of the standard and particularly Annex C.	<b>P</b>
1.5.5	Interconnecting cables	Interconnecting cable does not carry voltage higher than SELV and no higher energy level than 240VA.	<b>P</b>
1.5.6	Capacitors bridging insulation	Between lines: X1 or X2 capacitor according to IEC 60384-14 was used.  Between primary and earth: Y1 or Y2 capacitors according to IEC 60384-14 were used.  Between primary and secondary: Y1 capacitor according to IEC 60384-14 was used.  (see appended table 1.5.1)	<b>P</b>
1.5.7	Resistors bridging insulation		<b>P</b>
1.5.7.1	Resistors bridging functional, basic or supplementary insulation	Only discharge resistors bridging between L-N (functional)	<b>P</b>
1.5.7.2	Resistors bridging double or reinforced insulation between a.c. mains and other circuits		<b>N/A</b>
1.5.7.3	Resistors bridging double or reinforced insulation between a.c. mains and antenna or coaxial cable		<b>N/A</b>
1.5.8	Components in equipment for IT power systems	(see appended table 1.5.1.)	<b>P</b>

<b>IEC 60950-1</b>			
Clause	Requirement + Test	Result - Remark	Verdict
1.5.9	Surge suppressors	No surge suppressors.	<b>N/A</b>
1.5.9.1	General		<b>N/A</b>
1.5.9.2	Protection of VDRs		<b>N/A</b>
1.5.9.3	Bridging of functional insulation by a VDR		<b>N/A</b>
1.5.9.4	Bridging of basic insulation by a VDR		<b>N/A</b>
1.5.9.5	Bridging of supplementary, double or reinforced insulation by a VDR		<b>N/A</b>

<b>1.6</b>	<b>Power interface</b>		<b>P</b>
1.6.1	AC power distribution systems	Considered.	<b>P</b>
1.6.2	Input current	(see appended table 1.6.2)	<b>P</b>
1.6.3	Voltage limit of hand-held equipment	This appliance is not hand-held equipment.	<b>N/A</b>
1.6.4	Neutral conductor	The neutral conductor insulated from the body throughout the equipment as if it were a line conductor.	<b>P</b>

<b>1.7</b>	<b>Marking and instructions</b>		<b>P</b>
1.7.1	Power rating and identification markings	See below.	<b>P</b>
1.7.1.1	Power rating marking	See below.	<b>P</b>
	Multiple mains supply connections.....:		<b>N/A</b>
	Rated voltage(s) or voltage range(s) (V) .....	See copy of marking plate for details	<b>P</b>
	Symbol for nature of supply, for d.c. only .....	AC source	<b>N/A</b>
	Rated frequency or rated frequency range (Hz) .....	See copy of marking plate for details	<b>P</b>
	Rated current (mA or A) .....	See copy of marking plate for details	<b>P</b>
1.7.1.2	Identification markings	See below.	<b>P</b>
	Manufacturer's name or trade-mark or identification mark .....	See copy of marking plate for details	<b>P</b>
	Model identification or type reference .....	See copy of marking plate for details	<b>P</b>
	Symbol for Class II equipment only .....	See copy of marking plate for details	<b>P</b>
	Other markings and symbols .....	Additional symbol or marking does not give rise to misunderstanding.	<b>P</b>

<b>IEC 60950-1</b>			
Clause	Requirement + Test	Result - Remark	Verdict
1.7.1.3	Use of graphical symbols	Graphical symbols used according to IEC 60417 or ISO 3864-2 or ISO 7000.	<b>P</b>
1.7.2	Safety instructions and marking	English safety instruction provided.	<b>P</b>
1.7.2.1	General		<b>P</b>
1.7.2.2	Disconnect devices	AC inlet serves as disconnect device.	<b>P</b>
1.7.2.3	Overcurrent protective device	Not type B pluggable equipment or permanently connected equipment.	<b>N/A</b>
1.7.2.4	IT power distribution systems	For Norway compliance has to be evaluated during the national approval.	<b>N/A</b>
1.7.2.5	Operator access with a tool	No such access required.	<b>N/A</b>
1.7.2.6	Ozone	Ozone not used or generated.	<b>N/A</b>
1.7.3	Short duty cycles	Equipment is designed for continuous operation.	<b>N/A</b>
1.7.4	Supply voltage adjustment .....	Single input voltage range without adjustment.	<b>N/A</b>
	Methods and means of adjustment; reference to installation instructions .....		<b>N/A</b>
1.7.5	Power outlets on the equipment .....	No power outlets provided.	<b>N/A</b>
1.7.6	Fuse identification (marking, special fusing characteristics, cross-reference) .....	The fuse marking is marked near fuse on PCB as follow: F9901(on primary): T4AL/250Vac  CAUTION: RISK OF FIRE REPLACE ONLY WITH SAME TYPE AND RATING OF FUSE.  F9902 (on secondary for L.P.S.): T5AL/250Vac  Not located in operator access areas.	<b>P</b>
1.7.7	Wiring terminals	See below.	<b>P</b>
1.7.7.1	Protective earthing and bonding terminals .....	Appliance inlets approved according to IEC 60320-1 are used.	<b>P</b>
1.7.7.2	Terminals for a.c. mains supply conductors	The equipment is not permanently connected or provided with a non-detachable power supply cord.	<b>N/A</b>
1.7.7.3	Terminals for d.c. mains supply conductors	Not connected to d.c. mains	<b>N/A</b>

<b>IEC 60950-1</b>			
Clause	Requirement + Test	Result - Remark	Verdict
1.7.8	Controls and indicators	See below	<b>P</b>
1.7.8.1	Identification, location and marking .....	“STAND-BY” condition is indicated by the symbol according to IEC 60417-5009.	<b>P</b>
1.7.8.2	Colours .....	Colours used for LED indicate the operation status and not involved safety.	<b>N/A</b>
1.7.8.3	Symbols according to IEC 60417 .....	See 1.7.8.1	<b>P</b>
1.7.8.4	Markings using figures .....	No figures used.	<b>N/A</b>
1.7.9	Isolation of multiple power sources .....	Only one supply voltage range provided.	<b>N/A</b>
1.7.10	Thermostats and other regulating devices .....	No such components.	<b>N/A</b>
1.7.11	Durability	The label was subjected to the permanence of marking test. The label was rubbed with cloth soaked with water for 15 sec. and then again for 15 sec. with the cloth soaked with petroleum spirit.  After this test there was no damage to the label. The marking on the label did not fade. There was no curling or lifting of the label edge.	<b>P</b>
1.7.12	Removable parts	None.	<b>N/A</b>
1.7.13	Replaceable batteries .....	No replaceable batteries.	<b>N/A</b>
	Language(s) .....		□
1.7.14	Equipment for restricted access locations .....	Equipment not intended for installation in restricted access locations.	<b>N/A</b>

<b>2</b>	<b>PROTECTION FROM HAZARDS</b>		<b>P</b>
<b>2.1</b>	<b>Protection from electric shock and energy hazards</b>		<b>P</b>
2.1.1	Protection in operator access areas	Only SELV signal interface accessible by operator.	<b>P</b>
2.1.1.1	Access to energized parts	See below	<b>P</b>
	Test by inspection .....	Protection established by plastic enclosure.	<b>P</b>
	Test with test finger (Figure 2A) .....	Protection established by plastic enclosure.	<b>P</b>
	Test with test pin (Figure 2B) .....	No access to any energized parts with the removable stand detached.	<b>P</b>

<b>IEC 60950-1</b>			
Clause	Requirement + Test	Result - Remark	Verdict
	Test with test probe (Figure 2C) .....		<b>N/A</b>
2.1.1.2	Battery compartments	No battery compartment.	<b>N/A</b>
2.1.1.3	Access to ELV wiring	No ELV wiring in operator accessible area.	<b>N/A</b>
	Working voltage ( $V_{peak}$ or $V_{rms}$ ); minimum distance through insulation (mm)		—
2.1.1.4	Access to hazardous voltage circuit wiring	No hazardous voltage wiring in operator accessible area.	<b>N/A</b>
2.1.1.5	Energy hazards .....	The energy does not exceed 240VA between any two points in accessible connector of secondary circuit. (see appended table 2.1.1.5.)	<b>P</b>
2.1.1.6	Manual controls	No manual controls.	<b>N/A</b>
2.1.1.7	Discharge of capacitors in equipment	(See appended table 2.1.1.7)	<b>P</b>
	Measured voltage (V); time-constant (s) .....	(See appended table 2.1.1.7)	—
2.1.1.8	Energy hazards – d.c. mains supply	a.c. mains supply	<b>N/A</b>
	a) Capacitor connected to the d.c. mains supply ...:		<b>N/A</b>
	b) Internal battery connected to the d.c. mains supply .....		<b>N/A</b>
2.1.1.9	Audio amplifiers .....		<b>N/A</b>
2.1.2	Protection in service access areas	No service access area.	<b>N/A</b>
2.1.3	Protection in restricted access locations	Equipment not intended for installation in restricted access locations	<b>N/A</b>
<b>2.2</b>	<b>SELV circuits</b>		<b>P</b>
2.2.1	General requirements	The secondary circuits were tested as SELV. See sub-clauses 2.2.1 to 2.2.4.	<b>P</b>
2.2.2	Voltages under normal conditions (V) .....	42.4V peak or 60V d.c. are not exceeded in SELV circuit under normal operation.	<b>P</b>



IEC 60950-1			
Clause	Requirement + Test	Result - Remark	Verdict
2.2.3	Voltages under fault conditions (V) .....	Single fault did not cause excessive voltage in accessible SELV circuits. Limits of 71V peak and 120V d.c. were not exceeded within 0.2 sec. and limits 42.4V peak and 60V d.c. were not exceeded for longer than 0.2 sec., see appended tables 2.2 and 5.3.	<b>P</b>
2.2.4	Connection of SELV circuits to other circuits .....	See sub-clauses 2.2.2 and 2.2.3.  No direct connection between SELV and any primary circuits.	<b>P</b>

<b>2.3</b>	<b>TNV circuits</b>		<b>N/A</b>
2.3.1	Limits		<b>N/A</b>
	Type of TNV circuits .....		—
2.3.2	Separation from other circuits and from accessible parts		<b>N/A</b>
2.3.2.1	General requirements		<b>N/A</b>
2.3.2.2	Protection by basic insulation		<b>N/A</b>
2.3.2.3	Protection by earthing		<b>N/A</b>
2.3.2.4	Protection by other constructions .....		<b>N/A</b>
2.3.3	Separation from hazardous voltages		<b>N/A</b>
	Insulation employed .....		—
2.3.4	Connection of TNV circuits to other circuits		<b>N/A</b>
	Insulation employed .....		—
2.3.5	Test for operating voltages generated externally		<b>N/A</b>

<b>2.4</b>	<b>Limited current circuits</b>		<b>P</b>
2.4.1	General requirements	(see appended table 2.4.2)	<b>P</b>
2.4.2	Limit values	(see appended table 2.4.2)	<b>P</b>
	Frequency (Hz) .....		—
	Measured current (mA).....	(see appended table 2.4.2)	—
	Measured voltage (V) .....		—
	Measured circuit capacitance (nF or $\mu$ F) .....	(see appended table 2.4.2)	—

<b>IEC 60950-1</b>			
Clause	Requirement + Test	Result - Remark	Verdict
2.4.3	Connection of limited current circuits to other circuits	Only intended to be connected with SELV circuits.	<b>P</b>
<b>2.5</b>	<b>Limited power sources</b>		<b>P</b>
	a) Inherently limited output		<b>N/A</b>
	b) Impedance limited output		<b>N/A</b>
	c) Regulating network or IC current limiter, limits output under normal operating and single fault condition		<b>N/A</b>
	Use of integrated circuit (IC) current limiters		<b>N/A</b>
	d) Overcurrent protective device limited output	(see appended table 2.5)	<b>P</b>
	Max. output voltage (V), max. output current (A), max. apparent power (VA).....:	(see appended table 2.5)	—
	Current rating of overcurrent protective device (A) .:	(see appended table 1.5.1)	—
<b>2.6</b>	<b>Provisions for earthing and bonding</b>		<b>P</b>
2.6.1	Protective earthing	Class I appliance inlet terminal provided as protective earthing terminal, and accessible metal plate is connected to earthed metal fire enclosure. The test of 2.6.3.4 complied.	<b>P</b>
2.6.2	Functional earthing	Class I appliance inlet terminal provided as protective earthing terminal, and accessible metal plate is connected to earthed metal fire enclosure. The test of 2.6.3.4 complied.	<b>P</b>
	Use of symbol for functional earthing .....		<b>P</b>
2.6.3	Protective earthing and protective bonding conductors		<b>P</b>
2.6.3.1	General	Appliance inlet used.	<b>P</b>
2.6.3.2	Size of protective earthing conductors	Appliance inlet used.	<b>N/A</b>
	Rated current (A), cross-sectional area (mm <sup>2</sup> ), AWG .....		—
2.6.3.3	Size of protective bonding conductors	Screws fixing earthed PCB trace to metal chassis for protective bonding.	<b>P</b>
	Rated current (A), cross-sectional area (mm <sup>2</sup> ), AWG .....	Refer to appended table 2.6.3.4	—

<b>IEC 60950-1</b>			
Clause	Requirement + Test	Result - Remark	Verdict
	Protective current rating (A), cross-sectional area (mm <sup>2</sup> ), AWG .....		
2.6.3.4	Resistance of earthing conductors and their terminations; resistance ( $\Omega$ ), voltage drop (V), test current (A), duration (min) .....	(see appended table 2.6.3.4)	<b>P</b>
2.6.3.5	Colour of insulation .....		<b>N/A</b>
2.6.4	Terminals	See below	<b>P</b>
2.6.4.1	General		<b>P</b>
2.6.4.2	Protective earthing and bonding terminals	Earthing terminal in appliance inlet provided as protective earthing terminal.	<b>P</b>
	Rated current (A), type, nominal thread diameter (mm) .....	Evaluation by test.	—
2.6.4.3	Separation of the protective earthing conductor from protective bonding conductors	Separated PE and protective bonding conductor used.	<b>P</b>
2.6.5	Integrity of protective earthing	See below	<b>P</b>
2.6.5.1	Interconnection of equipment	Not depending on interconnection for protective earthing.	<b>P</b>
2.6.5.2	Components in protective earthing conductors and protective bonding conductors	No switch or overcurrent protective device in protective earthing or bonding conductor	<b>P</b>
2.6.5.3	Disconnection of protective earth	Appliance inlet used for disconnection of protective earth.	<b>P</b>
2.6.5.4	Parts that can be removed by an operator	AC inlet with PE terminal used.	<b>P</b>
2.6.5.5	Parts removed during servicing	It is not necessary to disconnect protective earth except for the removing of the earthed parts itself.	<b>P</b>
2.6.5.6	Corrosion resistance	All safety earthing connections comply with Annex J.	<b>P</b>
2.6.5.7	Screws for protective bonding	No self-tapping screws are used. For the earth connection to the metal chassis a spring washer and a screw are used	<b>N/A</b>
2.6.5.8	Reliance on telecommunication network or cable distribution system	No TNV circuit.	<b>N/A</b>
<b>2.7</b>	<b>Overcurrent and earth fault protection in primary circuits</b>		<b>P</b>

<b>IEC 60950-1</b>			
Clause	Requirement + Test	Result - Remark	Verdict
2.7.1	Basic requirements	The equipment relies on fuse or circuit breaker of the wall outlet protection of the building installation in regard to L to N short-circuits. A build-in fuse provided as overcurrent protection device (see 5.3)	<b>P</b>
	Instructions when protection relies on building installation	Pluggable equipment type A.	<b>N/A</b>
2.7.2	Faults not simulated in 5.3.7	The protection devices are well dimensioned and mounted.	<b>P</b>
2.7.3	Short-circuit backup protection	Building installation is considered as providing short-circuit backup protection.	<b>P</b>
2.7.4	Number and location of protective devices ..... :	Overcurrent protection by one built-in fuse	<b>P</b>
2.7.5	Protection by several devices	Protection by one fuse only.	<b>N/A</b>
2.7.6	Warning to service personnel ..... :	No service work necessary.	<b>N/A</b>

<b>2.8</b>	<b>Safety interlocks</b>		<b>N/A</b>
2.8.1	General principles		<b>N/A</b>
2.8.2	Protection requirements		<b>N/A</b>
2.8.3	Inadvertent reactivation		<b>N/A</b>
2.8.4	Fail-safe operation		<b>N/A</b>
	Protection against extreme hazard		<b>N/A</b>
2.8.5	Moving parts		<b>N/A</b>
2.8.6	Overriding		<b>N/A</b>
2.8.7	Switches, relays and their related circuits		<b>N/A</b>
2.8.7.1	Separation distances for contact gaps and their related circuits (mm) ..... :		<b>N/A</b>
2.8.7.2	Overload test		<b>N/A</b>
2.8.7.3	Endurance test		<b>N/A</b>
2.8.7.4	Electric strength test		<b>N/A</b>
2.8.8	Mechanical actuators		<b>N/A</b>

<b>2.9</b>	<b>Electrical insulation</b>		<b>P</b>
------------	------------------------------	--	----------

<b>IEC 60950-1</b>			
Clause	Requirement + Test	Result - Remark	Verdict
2.9.1	Properties of insulating materials	Natural rubber, asbestos or hygroscopic material not used.  After the humidity treatment of 2.9.2, the insulation is then subjected to the relevant electric strength test of 5.2.2.	<b>P</b>
2.9.2	Humidity conditioning	Performed at 40 °C, 95% R.H. for 120 h by client's request.	<b>P</b>
	Relative humidity (%), temperature (°C) .....	See above.	—
2.9.3	Grade of insulation	See above.	<b>P</b>
2.9.4	Separation from hazardous voltages	The adequate levels of safety insulation provided and maintained to comply with the requirements of this standard.	<b>P</b>
	Method(s) used .....	SELV separated from primary by reinforced or double insulation.	—

<b>2.10</b>	<b>Clearances, creepage distances and distances through insulation</b>		<b>P</b>
2.10.1	General	See sub-clauses 2.10.3, 2.10.4 and 2.10.5.	<b>P</b>
2.10.1.1	Frequency .....	Considered	<b>P</b>
2.10.1.2	Pollution degrees .....	2	<b>P</b>
2.10.1.3	Reduced values for functional insulation	Considered	<b>P</b>
2.10.1.4	Intervening unconnected conductive parts	Considered	<b>P</b>
2.10.1.5	Insulation with varying dimensions	Insulation kept homogenous.	<b>N/A</b>
2.10.1.6	Special separation requirements	Not applied.	<b>N/A</b>
2.10.1.7	Insulation in circuits generating starting pulses	No such circuits.	<b>N/A</b>
2.10.2	Determination of working voltage		<b>P</b>
2.10.2.1	General	Considered.	<b>P</b>
2.10.2.2	RMS working voltage	See table 2.10.2	<b>P</b>
2.10.2.3	Peak working voltage	See table 2.10.2	<b>P</b>
2.10.3	Clearances	See below and advantage of annex G is not considered.	<b>P</b>
2.10.3.1	General	Considered.	<b>P</b>
2.10.3.2	Mains transient voltages		<b>P</b>
	a) AC mains supply .....	240V a.c. and Overvoltage Category II	<b>P</b>

<b>IEC 60950-1</b>			
Clause	Requirement + Test	Result - Remark	Verdict
	b) Earthed d.c. mains supplies .....		<b>N/A</b>
	c) Unearthed d.c. mains supplies .....		<b>N/A</b>
	d) Battery operation .....		<b>N/A</b>
2.10.3.3	Clearances in primary circuits	(see appended table 2.10.3 and 2.10.4)	<b>P</b>
2.10.3.4	Clearances in secondary circuits	Sub-clause 5.3.4 considered.	<b>P</b>
2.10.3.5	Clearances in circuits having starting pulses		<b>N/A</b>
2.10.3.6	Transients from a.c. mains supply .....	Normal transient voltage considered (overvoltage category II for primary circuit).	<b>N/A</b>
2.10.3.7	Transients from d.c. mains supply .....		<b>N/A</b>
2.10.3.8	Transients from telecommunication networks and cable distribution systems .....		<b>N/A</b>
2.10.3.9	Measurement of transient voltage levels		<b>N/A</b>
	a) Transients from a mains supply		<b>N/A</b>
	For an a.c. mains supply .....		<b>N/A</b>
	For a d.c. mains supply .....		<b>N/A</b>
	b) Transients from a telecommunication network :		<b>N/A</b>
2.10.4	Creepage distances		<b>P</b>
2.10.4.1	General		<b>P</b>
2.10.4.2	Material group and comparative tracking index		<b>P</b>
	CTI tests .....	Material group IIIb is assumed to be used.	—
2.10.4.3	Minimum creepage distances	(see appended table 2.10.3 and 2.10.4)	<b>P</b>
2.10.5	Solid insulation		<b>P</b>
2.10.5.1	General		<b>P</b>
2.10.5.2	Distances through insulation	(see appended table 2.10.5)	<b>P</b>
2.10.5.3	Insulating compound as solid insulation	Only inside approved optocoupler.	<b>N/A</b>
2.10.5.4	Semiconductor devices	Approved optocoupler complies to IEC 60747-5-5 and having dti. 0.4mm.	<b>P</b>
2.10.5.5.	Cemented joints	Not applied.	<b>N/A</b>
2.10.5.6	Thin sheet material – General		<b>P</b>
2.10.5.7	Separable thin sheet material	Used in transformer.	<b>P</b>
	Number of layers (pcs) .....	(see appended table C.2)	—
2.10.5.8	Non-separable thin sheet material	Not applied for.	<b>N/A</b>

<b>IEC 60950-1</b>			
Clause	Requirement + Test	Result - Remark	Verdict
2.10.5.9	Thin sheet material – standard test procedure		<b>N/A</b>
	Electric strength test		—
2.10.5.10	Thin sheet material – alternative test procedure		<b>P</b>
	Electric strength test	(see appended table 5.2)	—
2.10.5.11	Insulation in wound components	See only 2.10.5.6.	<b>P</b>
2.10.5.12	Wire in wound components	T9102	<b>P</b>
	Working voltage .....	Exceeds 71 V.	<b>P</b>
	a) Basic insulation not under stress .....		<b>N/A</b>
	b) Basic, supplementary, reinforced insulation .....	Reinforced.	<b>P</b>
	c) Compliance with Annex U .....	Approved triple insulated wire used.	<b>P</b>
	Two wires in contact inside wound component; angle between 45° and 90° .....	Physical separation provided by insulation tape or tube to relieve mechanical stress at the crossover point.	<b>P</b>
2.10.5.13	Wire with solvent-based enamel in wound components	Not applied.	<b>N/A</b>
	Electric strength test		—
	Routine test		<b>N/A</b>
2.10.5.14	Additional insulation in wound components	Not applied.	<b>N/A</b>
	Working voltage .....		<b>N/A</b>
	- Basic insulation not under stress .....		<b>N/A</b>
	- Supplementary, reinforced insulation .....		<b>N/A</b>
2.10.6	Construction of printed boards		<b>P</b>
2.10.6.1	Uncoated printed boards	(see appended table 2.10.3 and 2.10.4)	<b>P</b>
2.10.6.2	Coated printed boards	Not applied.	<b>N/A</b>
2.10.6.3	Insulation between conductors on the same inner surface of a printed board	Not multi-layer printed board.	<b>N/A</b>
2.10.6.4	Insulation between conductors on different layers of a printed board	See above.	<b>N/A</b>
	Distance through insulation		<b>N/A</b>
	Number of insulation layers (pcs) .....		<b>N/A</b>
2.10.7	Component external terminations	Coatings not used over terminations to increase effective clearance and creepage distance.	<b>N/A</b>
2.10.8	Tests on coated printed boards and coated components		<b>N/A</b>
2.10.8.1	Sample preparation and preliminary inspection		<b>N/A</b>

<b>IEC 60950-1</b>			
Clause	Requirement + Test	Result - Remark	Verdict
2.10.8.2	Thermal conditioning		<b>N/A</b>
2.10.8.3	Electric strength test		<b>N/A</b>
2.10.8.4	Abrasion resistance test		<b>N/A</b>
2.10.9	Thermal cycling		<b>N/A</b>
2.10.10	Test for Pollution Degree 1 environment and insulating compound	Pollution Degree 2.	<b>N/A</b>
2.10.11	Tests for semiconductor devices and cemented joints	Photo couplers are approved components. No other components applied for.	<b>N/A</b>
2.10.12	Enclosed and sealed parts	No hermetically sealed component.	<b>N/A</b>

<b>3</b>	<b>WIRING, CONNECTIONS AND SUPPLY</b>		<b>P</b>
<b>3.1</b>	<b>General</b>		<b>P</b>
3.1.1	Current rating and overcurrent protection	The cross-sectional area and the temperature of the internal wires are adequate.	<b>P</b>
3.1.2	Protection against mechanical damage	Wires do not touch sharp edges which could damage the insulation and cause hazard.	<b>P</b>
3.1.3	Securing of internal wiring	Wires with only basic insulation are routed so that they are not close to any live bare components. Wires are secured by soldering method and additionally fixed by glue or by connectors.	<b>P</b>
3.1.4	Insulation of conductors	The insulation of the individual conductors suitable for the application and the working voltage. For the insulation material see 3.1.1.	<b>P</b>
3.1.5	Beads and ceramic insulators	Not used.	<b>N/A</b>
3.1.6	Screws for electrical contact pressure	Only metal screw is used for electrical connection between power board and metal chassis, and engages more than 2 complete threads.	<b>P</b>
3.1.7	Insulating materials in electrical connections	The integrity of protective bonding made by screw, PCB trace and spring washer.	<b>P</b>
3.1.8	Self-tapping and spaced thread screws	No self-tapping or spaced thread screws are used.	<b>N/A</b>



<b>IEC 60950-1</b>			
Clause	Requirement + Test	Result - Remark	Verdict
3.1.9	Termination of conductors	All conductors are reliably secured.	<b>P</b>
	10 N pull test		<b>P</b>
3.1.10	Sleeving on wiring		<b>N/A</b>

<b>3.2</b>	<b>Connection to a mains supply</b>		<b>P</b>
3.2.1	Means of connection	See below.	<b>P</b>
3.2.1.1	Connection to an a.c. mains supply	Appliance inlet used.	<b>P</b>
3.2.1.2	Connection to a d.c. mains supply	Only a.c. mains supply.	<b>N/A</b>
3.2.2	Multiple supply connections	Only for one mains connection.	<b>N/A</b>
3.2.3	Permanently connected equipment	Unit is not a permanently connected equipment.	<b>N/A</b>
	Number of conductors, diameter of cable and conduits (mm) .....		—
3.2.4	Appliance inlets	Approved appliance inlet used.	<b>P</b>
3.2.5	Power supply cords	See below.	<b>N/A</b>
3.2.5.1	AC power supply cords	Not provided.	<b>N/A</b>
	Type .....		—
	Rated current (A), cross-sectional area (mm <sup>2</sup> ), AWG .....		—
3.2.5.2	DC power supply cords	Not provided.	<b>N/A</b>
3.2.6	Cord anchorages and strain relief	Appliance inlet used	<b>N/A</b>
	Mass of equipment (kg), pull (N) .....		—
	Longitudinal displacement (mm) .....		—
3.2.7	Protection against mechanical damage		<b>N/A</b>
3.2.8	Cord guards	No cord guards.	<b>N/A</b>
	Diameter or minor dimension D (mm); test mass (g) .....		—
	Radius of curvature of cord (mm).....		—
3.2.9	Supply wiring space	Not permanent connection or non-detachable power cord type.	<b>N/A</b>

<b>3.3</b>	<b>Wiring terminals for connection of external conductors</b>		<b>N/A</b>
3.3.1	Wiring terminals	AC inlet used.	<b>N/A</b>
3.3.2	Connection of non-detachable power supply cords		<b>N/A</b>
3.3.3	Screw terminals		<b>N/A</b>

IEC 60950-1			
Clause	Requirement + Test	Result - Remark	Verdict
3.3.4	Conductor sizes to be connected		N/A
	Rated current (A), cord/cable type, cross-sectional area (mm <sup>2</sup> )..... :		—
3.3.5	Wiring terminal sizes		N/A
	Rated current (A), type, nominal thread diameter (mm) ..... :		—
3.3.6	Wiring terminal design		N/A
3.3.7	Grouping of wiring terminals		N/A
3.3.8	Stranded wire		N/A

<b>3.4</b>	<b>Disconnection from the mains supply</b>		<b>P</b>
3.4.1	General requirement	Disconnect device provided	<b>P</b>
3.4.2	Disconnect devices	Appliance coupler used as disconnect device.	<b>P</b>
3.4.3	Permanently connected equipment	Not permanently connected equipment	<b>N/A</b>
3.4.4	Parts which remain energized	When AC coupler is disconnected from inlet, there are no parts remaining with hazardous voltage or energy in the equipment.	<b>P</b>
3.4.5	Switches in flexible cords	No such switch in flexible cords	<b>N/A</b>
3.4.6	Number of poles - single-phase and d.c. equipment	The appliance coupler disconnects both poles simultaneously.	<b>P</b>
3.4.7	Number of poles - three-phase equipment	Single-phase equipment	<b>N/A</b>
3.4.8	Switches as disconnect devices	No such switch	<b>N/A</b>
3.4.9	Plugs as disconnect devices	Plug not used	<b>N/A</b>
3.4.10	Interconnected equipment	Only interconnected with other unit through SELV interface.	<b>P</b>
3.4.11	Multiple power sources	Single power source	<b>N/A</b>

<b>3.5</b>	<b>Interconnection of equipment</b>		<b>P</b>
3.5.1	General requirements	This power supply is not considered for connection to TNV.	<b>P</b>
3.5.2	Types of interconnection circuits ..... :	Interconnection circuits of SELV through the connector. No ELV interconnection circuits.	<b>P</b>

<b>IEC 60950-1</b>			
Clause	Requirement + Test	Result - Remark	Verdict
3.5.3	ELV circuits as interconnection circuits	No ELV interconnection	<b>N/A</b>
3.5.4	Data ports for additional equipment	All data ports are supplied by LPS.	<b>P</b>

<b>4</b>	<b>PHYSICAL REQUIREMENTS</b>		<b>P</b>
<b>4.1</b>	<b>Stability</b>		<b>P</b>
	Angle of 10°	The equipment does not overbalance when tilted to 10°	<b>P</b>
	Test force (N) .....	Equipment is not a floor standing unit.	<b>N/A</b>

<b>4.2</b>	<b>Mechanical strength</b>		<b>P</b>
4.2.1	General	See below. After tests, unit comply with 2.1.1, 2.6.1 and 2.10.	<b>P</b>
	Rack-mounted equipment.		<b>N/A</b>
4.2.2	Steady force test, 10 N	Test performed on internal components. No components located such that distances according to 2.10 can be reduced.	<b>P</b>
4.2.3	Steady force test, 30 N	Test performed on internal metal cover.	<b>P</b>
4.2.4	Steady force test, 250 N	Test performed on plastic enclosure.	<b>P</b>
4.2.5	Impact test	500g steel ball falls freely from 1.3m on top, back and bottom of plastic enclosure, no access to hazardous parts.	<b>P</b>
	Fall test		<b>P</b>
	Swing test		<b>N/A</b>
4.2.6	Drop test; height (mm) .....		<b>N/A</b>
4.2.7	Stress relief test	70°C, 7 hours, no deformation on all sources of plastic enclosure.	<b>P</b>
4.2.8	Cathode ray tubes	No CRT	<b>N/A</b>
	Picture tube separately certified .....		<b>N/A</b>
4.2.9	High pressure lamps	No high pressure lamps	<b>N/A</b>

IEC 60950-1			
Clause	Requirement + Test	Result - Remark	Verdict
4.2.10	Wall or ceiling mounted equipment; force (N) ..... :	An additional force 191.4N applied downwards through the centre of gravity of the equipment for 1 min after the removal of base (by client's request). After the test, the equipment was not damaged.	<b>P</b>

<b>4.3</b>	<b>Design and construction</b>		<b>P</b>
4.3.1	Edges and corners	Edges and corners of the enclosure are rounded.	<b>P</b>
4.3.2	Handles and manual controls; force (N) ..... :	No safety relevant handles or manual controls.	<b>N/A</b>
4.3.3	Adjustable controls	No such controls.	<b>N/A</b>
4.3.4	Securing of parts	All parts secured properly. Spring washer used for securing screws.	<b>P</b>
4.3.5	Connection by plugs and sockets		<b>N/A</b>
4.3.6	Direct plug-in equipment	Not such equipment.	<b>N/A</b>
	Torque ..... :		—
	Compliance with the relevant mains plug standard ..... :		<b>N/A</b>
4.3.7	Heating elements in earthed equipment	None.	<b>N/A</b>
4.3.8	Batteries	No batteries.	<b>N/A</b>
	- Overcharging of a rechargeable battery		<b>N/A</b>
	- Unintentional charging of a non-rechargeable battery		<b>N/A</b>
	- Reverse charging of a rechargeable battery		<b>N/A</b>
	- Excessive discharging rate for any battery		<b>N/A</b>
4.3.9	Oil and grease	None.	<b>N/A</b>
4.3.10	Dust, powders, liquids and gases	Equipment in intended use not considered to be exposed to these.	<b>N/A</b>
4.3.11	Containers for liquids or gases	None	<b>N/A</b>
4.3.12	Flammable liquids ..... :	None	<b>N/A</b>
	Quantity of liquid (l) ..... :		<b>N/A</b>
	Flash point (°C) ..... :		<b>N/A</b>
4.3.13	Radiation		<b>P</b>
4.3.13.1	General	See below	<b>P</b>
4.3.13.2	Ionizing radiation	No ionizing radiation.	<b>N/A</b>

<b>IEC 60950-1</b>			
Clause	Requirement + Test	Result - Remark	Verdict
	Measured radiation (pA/kg) .....		—
	Measured high-voltage (kV) .....		—
	Measured focus voltage (kV) .....		—
	CRT markings .....		—
4.3.13.3	Effect of ultraviolet (UV) radiation on materials	No ultraviolet radiation	<b>N/A</b>
	Part, property, retention after test, flammability classification .....		<b>N/A</b>
4.3.13.4	Human exposure to ultraviolet (UV) radiation .....	No ultraviolet radiation	<b>N/A</b>
4.3.13.5	Lasers (including laser diodes) and LEDs	See below.	<b>P</b>
4.3.13.5.1	Lasers (including laser diodes)	Not used.	<b>N/A</b>
	Laser class .....		—
4.3.13.5.2	Light emitting diodes (LEDs)	The following parts are considered complied without tests: Indicating lights. Optocouplers. For LED backlight, the luminance is far less than 10000 cd/m <sup>2</sup> . With reference to sub clause 4.1 of IEC 62471:2006 no further test is necessary.	<b>P</b>
4.3.13.6	Other types .....		<b>N/A</b>

<b>4.4</b>	<b>Protection against hazardous moving parts</b>		<b>N/A</b>
4.4.1	General		<b>N/A</b>
4.4.2	Protection in operator access areas .....		<b>N/A</b>
	Household and home/office document/media shredders		<b>N/A</b>
4.4.3	Protection in restricted access locations .....		<b>N/A</b>
4.4.4	Protection in service access areas		<b>N/A</b>
4.4.5	Protection against moving fan blades		<b>N/A</b>
4.4.5.1	General		<b>N/A</b>
	Not considered to cause pain or injury. a) .....		<b>N/A</b>
	Is considered to cause pain, not injury. b) .....		<b>N/A</b>
	Considered to cause injury. c) .....		<b>N/A</b>
4.4.5.2	Protection for users		<b>N/A</b>
	Use of symbol or warning .....		<b>N/A</b>
4.4.5.3	Protection for service persons		<b>N/A</b>

IEC 60950-1			
Clause	Requirement + Test	Result - Remark	Verdict

	Use of symbol or warning .....		N/A
--	--------------------------------	--	-----

<b>4.5</b>	<b>Thermal requirements</b>		<b>P</b>
4.5.1	General		<b>P</b>
4.5.2	Temperature tests		<b>P</b>
	Normal load condition per Annex L .....	Equipment loaded with rated output current.	—
4.5.3	Temperature limits for materials	(see appended table 4.5)	<b>P</b>
4.5.4	Touch temperature limits	(see appended table 4.5)	<b>P</b>
4.5.5	Resistance to abnormal heat .....	Bobbin materials of all transformer and all PFC chokes L9801 are phenolic that is accepted without further tests	<b>P</b>

<b>4.6</b>	<b>Openings in enclosures</b>		<b>P</b>
4.6.1	Top and side openings	See below.	<b>P</b>
	Dimensions (mm) .....	(see appended table 4.6.1 and 4.6.2)	—
4.6.2	Bottoms of fire enclosures	See below.	<b>P</b>
	Construction of the bottom, dimensions (mm) ..	(see appended table 4.6.1 and 4.6.2)	—
4.6.3	Doors or covers in fire enclosures	No doors or covers.	<b>N/A</b>
4.6.4	Openings in transportable equipment	Not transportable equipment.	<b>N/A</b>
4.6.4.1	Constructional design measures		<b>N/A</b>
	Dimensions (mm) .....		—
4.6.4.2	Evaluation measures for larger openings		<b>N/A</b>
4.6.4.3	Use of metallized parts		<b>N/A</b>
4.6.5	Adhesives for constructional purposes	No adhesives for constructional purposes.	<b>N/A</b>
	Conditioning temperature (°C), time (weeks) .....		—

<b>4.7</b>	<b>Resistance to fire</b>		<b>P</b>
4.7.1	Reducing the risk of ignition and spread of flame	No excessive temperatures. No easily burning materials employed. Fire enclosure provided. Safety relevant components used within their specified temperature limits.	<b>P</b>

<b>IEC 60950-1</b>			
Clause	Requirement + Test	Result - Remark	Verdict
	Method 1, selection and application of components wiring and materials	(see appended table 4.7)	<b>P</b>
	Method 2, application of all of simulated fault condition tests		<b>N/A</b>
4.7.2	Conditions for a fire enclosure	See below.	<b>P</b>
4.7.2.1	Parts requiring a fire enclosure	Following parts require a fire enclosure: <ul style="list-style-type: none"> <li>▪ Components in primary circuits</li> <li>▪ Components in secondary circuits not supplied by limited power source</li> <li>▪ Insulating wiring</li> </ul>	<b>P</b>
4.7.2.2	Parts not requiring a fire enclosure		<b>N/A</b>
4.7.3	Materials		<b>P</b>
4.7.3.1	General	PCB rated V-1	<b>P</b>
4.7.3.2	Materials for fire enclosures	Earthed metal enclosure is considered as fire enclosure, which complies without test.	<b>P</b>
4.7.3.3	Materials for components and other parts outside fire enclosures	HB plastic enclosure used, which is outside the fire enclosure.	<b>P</b>
4.7.3.4	Materials for components and other parts inside fire enclosures		<b>P</b>
4.7.3.5	Materials for air filter assemblies	No air filter.	<b>N/A</b>
4.7.3.6	Materials used in high-voltage components	No such high voltage components in this meaning	<b>N/A</b>

<b>5</b>	<b>ELECTRICAL REQUIREMENTS AND SIMULATED ABNORMAL CONDITIONS</b>		<b>P</b>
<b>5.1</b>	<b>Touch current and protective conductor current</b>		<b>P</b>
5.1.1	General	See sub-clauses 5.1.2 to 5.1.6.	<b>P</b>
5.1.2	Configuration of equipment under test (EUT)	See below.	<b>P</b>
5.1.2.1	Single connection to an a.c. mains supply	EUT has only one mains connection.	<b>P</b>
5.1.2.2	Redundant multiple connections to an a.c. mains supply		<b>N/A</b>
5.1.2.3	Simultaneous multiple connections to an a.c. mains supply		<b>N/A</b>
5.1.3	Test circuit	Using figure 5A.	<b>P</b>

<b>IEC 60950-1</b>			
Clause	Requirement + Test	Result - Remark	Verdict
5.1.4	Application of measuring instrument	Using measuring instrument in annex D.	<b>P</b>
5.1.5	Test procedure		<b>P</b>
5.1.6	Test measurements	(see appended table 5.1.6)	<b>P</b>
	Supply voltage (V) .....		—
	Measured touch current (mA) .....		—
	Max. allowed touch current (mA) .....		—
	Measured protective conductor current (mA) .....		—
	Max. allowed protective conductor current (mA) ...		—
5.1.7	Equipment with touch current exceeding 3,5 mA	Touch current does not exceed 3.5mA.	<b>N/A</b>
5.1.7.1	General .....		<b>N/A</b>
5.1.7.2	Simultaneous multiple connections to the supply		<b>N/A</b>
5.1.8	Touch currents to telecommunication networks and cable distribution systems and from telecommunication networks	No TNV circuits.	<b>N/A</b>
5.1.8.1	Limitation of the touch current to a telecommunication network or to a cable distribution system		<b>N/A</b>
	Supply voltage (V) .....		—
	Measured touch current (mA) .....		—
	Max. allowed touch current (mA) .....		—
5.1.8.2	Summation of touch currents from telecommunication networks		<b>N/A</b>
	a) EUT with earthed telecommunication ports .....		<b>N/A</b>
	b) EUT whose telecommunication ports have no reference to protective earth		<b>N/A</b>

<b>5.2</b>	<b>Electric strength</b>		<b>P</b>
5.2.1	General	(see appended table 5.2)	<b>P</b>
5.2.2	Test procedure	(see appended table 5.2)	<b>P</b>

<b>5.3</b>	<b>Abnormal operating and fault conditions</b>		<b>P</b>
5.3.1	Protection against overload and abnormal operation	Ventilation openings blocked, output of power supply board overloaded, no unaccepted overheating of parts (see appended table 5.3)	<b>P</b>
5.3.2	Motors	Motors not used.	<b>N/A</b>



<b>IEC 60950-1</b>			
Clause	Requirement + Test	Result - Remark	Verdict
5.3.3	Transformers	(see appended Annex C and table 5.3)	<b>P</b>
5.3.4	Functional insulation .....	By short-circuited, results see appended table 5.3.	<b>P</b>
5.3.5	Electromechanical components	No electromechanical component.	<b>N/A</b>
5.3.6	Audio amplifiers in ITE .....		<b>P</b>
5.3.7	Simulation of faults	(see appended table 5.3.)	<b>P</b>
5.3.8	Unattended equipment	No such equipment.	<b>N/A</b>
5.3.9	Compliance criteria for abnormal operating and fault conditions		<b>P</b>
5.3.9.1	During the tests	No fire or molten metal occurred and no deformation of enclosure during the tests.	<b>P</b>
5.3.9.2	After the tests	No reduction of clearance and creepage distance. Electric strength test is made on basic, supplementary and reinforced insulation after test.	<b>P</b>

<b>6</b>	<b>CONNECTION TO TELECOMMUNICATION NETWORKS</b>		<b>N/A</b>
<b>6.1</b>	<b>Protection of telecommunication network service persons, and users of other equipment connected to the network, from hazards in the equipment</b>		<b>N/A</b>
6.1.1	Protection from hazardous voltages		<b>N/A</b>
6.1.2	Separation of the telecommunication network from earth		<b>N/A</b>
6.1.2.1	Requirements		<b>N/A</b>
	Supply voltage (V) .....		—
	Current in the test circuit (mA) .....		—
6.1.2.2	Exclusions .....		<b>N/A</b>

<b>6.2</b>	<b>Protection of equipment users from overvoltages on telecommunication networks</b>		<b>N/A</b>
6.2.1	Separation requirements		<b>N/A</b>
6.2.2	Electric strength test procedure		<b>N/A</b>
6.2.2.1	Impulse test		<b>N/A</b>
6.2.2.2	Steady-state test		<b>N/A</b>
6.2.2.3	Compliance criteria		<b>N/A</b>

<b>6.3</b>	<b>Protection of the telecommunication wiring system from overheating</b>		<b>N/A</b>
------------	---	--	------------

IEC 60950-1			
Clause	Requirement + Test	Result - Remark	Verdict

	Max. output current (A) .....		—
	Current limiting method .....		—

<b>7</b>	<b>CONNECTION TO CABLE DISTRIBUTION SYSTEMS</b>		<b>N/A</b>
<b>7.1</b>	<b>General</b>		<b>N/A</b>
7.2	Protection of cable distribution system service persons, and users of other equipment connected to the system, from hazardous voltages in the equipment		<b>N/A</b>
7.3	Protection of equipment users from overvoltages on the cable distribution system		<b>N/A</b>
7.4	Insulation between primary circuits and cable distribution systems		<b>N/A</b>
7.4.1	General		<b>N/A</b>
7.4.2	Voltage surge test		<b>N/A</b>
7.4.3	Impulse test		<b>N/A</b>

<b>A</b>	<b>ANNEX A, TESTS FOR RESISTANCE TO HEAT AND FIRE</b>		<b>N/A</b>
<b>A.1</b>	<b>Flammability test for fire enclosures of movable equipment having a total mass exceeding 18 kg, and of stationary equipment (see 4.7.3.2)</b>		<b>N/A</b>
A.1.1	Samples.....		—
	Wall thickness (mm).....		—
A.1.2	Conditioning of samples; temperature (°C) .....		<b>N/A</b>
A.1.3	Mounting of samples .....		<b>N/A</b>
A.1.4	Test flame (see IEC 60695-11-3)		<b>N/A</b>
	Flame A, B, C or D .....		—
A.1.5	Test procedure		<b>N/A</b>
A.1.6	Compliance criteria		<b>N/A</b>
	Sample 1 burning time (s) .....		—
	Sample 2 burning time (s) .....		—
	Sample 3 burning time (s) .....		—
<b>A.2</b>	<b>Flammability test for fire enclosures of movable equipment having a total mass not exceeding 18 kg, and for material and components located inside fire enclosures (see 4.7.3.2 and 4.7.3.4)</b>		<b>N/A</b>
A.2.1	Samples, material.....		—
	Wall thickness (mm).....		—
A.2.2	Conditioning of samples; temperature (°C) .....		<b>N/A</b>

<b>IEC 60950-1</b>			
Clause	Requirement + Test	Result - Remark	Verdict
A.2.3	Mounting of samples .....		N/A
A.2.4	Test flame (see IEC 60695-11-4)		N/A
	Flame A, B or C .....		—
A.2.5	Test procedure		N/A
A.2.6	Compliance criteria		N/A
	Sample 1 burning time (s) .....		—
	Sample 2 burning time (s) .....		—
	Sample 3 burning time (s) .....		—
A.2.7	Alternative test acc. to IEC 60695-11-5, cl. 5 and 9		N/A
	Sample 1 burning time (s) .....		—
	Sample 2 burning time (s) .....		—
	Sample 3 burning time (s) .....		—
<b>A.3</b>	<b>Hot flaming oil test (see 4.6.2)</b>		N/A
A.3.1	Mounting of samples		N/A
A.3.2	Test procedure		N/A
A.3.3	Compliance criterion		N/A

<b>B</b>	<b>ANNEX B, MOTOR TESTS UNDER ABNORMAL CONDITIONS (see 4.7.2.2 and 5.3.2)</b>		N/A
<b>B.1</b>	<b>General requirements</b>		N/A
	Position .....		—
	Manufacturer .....		—
	Type .....		—
	Rated values .....		—
<b>B.2</b>	<b>Test conditions</b>		N/A
<b>B.3</b>	<b>Maximum temperatures</b>		N/A
<b>B.4</b>	<b>Running overload test</b>		N/A
<b>B.5</b>	<b>Locked-rotor overload test</b>		N/A
	Test duration (days) .....		—
	Electric strength test: test voltage (V) .....		—
<b>B.6</b>	<b>Running overload test for d.c. motors in secondary circuits</b>		N/A
B.6.1	General		N/A
B.6.2	Test procedure		N/A
B.6.3	Alternative test procedure		N/A
B.6.4	Electric strength test; test voltage (V) .....		N/A

<b>IEC 60950-1</b>			
Clause	Requirement + Test	Result - Remark	Verdict
<b>B.7</b>	<b>Locked-rotor overload test for d.c. motors in secondary circuits</b>		<b>N/A</b>
B.7.1	General		<b>N/A</b>
B.7.2	Test procedure		<b>N/A</b>
B.7.3	Alternative test procedure		<b>N/A</b>
B.7.4	Electric strength test; test voltage (V) .....		<b>N/A</b>
<b>B.8</b>	<b>Test for motors with capacitors</b>		<b>N/A</b>
<b>B.9</b>	<b>Test for three-phase motors</b>		<b>N/A</b>
<b>B.10</b>	<b>Test for series motors</b>		<b>N/A</b>
	Operating voltage (V) .....		—
<b>C</b>	<b>ANNEX C, TRANSFORMERS (see 1.5.4 and 5.3.3)</b>		<b>P</b>
	Position .....	See appended table 1.5.1.	—
	Manufacturer .....	See appended table 1.5.1.	—
	Type .....	See appended table 1.5.1.	—
	Rated values .....	See appended table 1.5.1.	—
	Method of protection .....	By protection circuit.	—
<b>C.1</b>	<b>Overload test</b>	(see appended table 5.3)	<b>P</b>
<b>C.2</b>	<b>Insulation</b>	(see appended table 5.2)	<b>P</b>
	Protection from displacement of windings .....	Fixed by insulation tape or bobbin.	<b>P</b>
<b>D</b>	<b>ANNEX D, MEASURING INSTRUMENTS FOR TOUCH-CURRENT TESTS (see 5.1.4)</b>		<b>P</b>
<b>D.1</b>	<b>Measuring instrument</b>		<b>P</b>
<b>D.2</b>	<b>Alternative measuring instrument</b>		<b>N/A</b>
<b>E</b>	<b>ANNEX E, TEMPERATURE RISE OF A WINDING (see 1.4.13)</b>		<b>N/A</b>
<b>F</b>	<b>ANNEX F, MEASUREMENT OF CLEARANCES AND CREEPAGE DISTANCES (see 2.10 and Annex G)</b>		<b>P</b>
<b>G</b>	<b>ANNEX G, ALTERNATIVE METHOD FOR DETERMINING MINIMUM CLEARANCES</b>		<b>N/A</b>
<b>G.1</b>	<b>Clearances</b>		<b>N/A</b>
G.1.1	General		<b>N/A</b>

<b>IEC 60950-1</b>			
Clause	Requirement + Test	Result - Remark	Verdict
G.1.2	Summary of the procedure for determining minimum clearances		N/A
<b>G.2</b>	<b>Determination of mains transient voltage (V)</b>		N/A
G.2.1	AC mains supply .....		N/A
G.2.2	Earthed d.c. mains supplies .....		N/A
G.2.3	Unearthed d.c. mains supplies .....		N/A
G.2.4	Battery operation .....		N/A
<b>G.3</b>	<b>Determination of telecommunication network transient voltage (V) .....</b>		N/A
<b>G.4</b>	<b>Determination of required withstand voltage (V)</b>		N/A
G.4.1	Mains transients and internal repetitive peaks .....		N/A
G.4.2	Transients from telecommunication networks .....		N/A
G.4.3	Combination of transients		N/A
G.4.4	Transients from cable distribution systems		N/A
<b>G.5</b>	<b>Measurement of transient voltages (V)</b>		N/A
	a) Transients from a mains supply		N/A
	For an a.c. mains supply		N/A
	For a d.c. mains supply		N/A
	b) Transients from a telecommunication network		N/A
<b>G.6</b>	<b>Determination of minimum clearances .....</b>		N/A
<b>H</b>	<b>ANNEX H, IONIZING RADIATION (see 4.3.13)</b>		N/A
<b>J</b>	<b>ANNEX J, TABLE OF ELECTROCHEMICAL POTENTIALS (see 2.6.5.6)</b>		<b>P</b>
	Metal(s) used .....	The internal metal enclosure is made of mild steel, screw spring washer are made of Ni on steel, the combined electrochemical potential is below 0.6V according to Table J.1.	—
<b>K</b>	<b>ANNEX K, THERMAL CONTROLS (see 1.5.3 and 5.3.8)</b>		N/A
K.1	Making and breaking capacity		N/A
K.2	Thermostat reliability; operating voltage (V) .....		N/A
K.3	Thermostat endurance test; operating voltage (V) .....		N/A
K.4	Temperature limiter endurance; operating voltage (V) .....		N/A

<b>IEC 60950-1</b>			
Clause	Requirement + Test	Result - Remark	Verdict
K.5	Thermal cut-out reliability		N/A
K.6	Stability of operation		N/A
<b>L</b>	<b>ANNEX L, NORMAL LOAD CONDITIONS FOR SOME TYPES OF ELECTRICAL BUSINESS EQUIPMENT (see 1.2.2.1 and 4.5.2)</b>		<b>P</b>
L.1	Typewriters		N/A
L.2	Adding machines and cash registers		N/A
L.3	Erasers		N/A
L.4	Pencil sharpeners		N/A
L.5	Duplicators and copy machines		N/A
L.6	Motor-operated files		N/A
L.7	Other business equipment	See 1.6.2.	P
<b>M</b>	<b>ANNEX M, CRITERIA FOR TELEPHONE RINGING SIGNALS (see 2.3.1)</b>		<b>N/A</b>
M.1	Introduction		N/A
M.2	Method A		N/A
M.3	Method B		N/A
M.3.1	Ringing signal		N/A
M.3.1.1	Frequency (Hz) .....		—
M.3.1.2	Voltage (V) .....		—
M.3.1.3	Cadence; time (s), voltage (V) .....		—
M.3.1.4	Single fault current (mA) .....		—
M.3.2	Tripping device and monitoring voltage .....		N/A
M.3.2.1	Conditions for use of a tripping device or a monitoring voltage		N/A
M.3.2.2	Tripping device		N/A
M.3.2.3	Monitoring voltage (V) .....		N/A
<b>N</b>	<b>ANNEX N, IMPULSE TEST GENERATORS (see 1.5.7.2, 1.5.7.3, 2.10.3.9, 6.2.2.1, 7.3.2, 7.4.3 and Clause G.5)</b>		<b>N/A</b>
N.1	ITU-T impulse test generators		N/A
N.2	IEC 60065 impulse test generator		N/A
<b>P</b>	<b>ANNEX P, NORMATIVE REFERENCES</b>		—
<b>Q</b>	<b>ANNEX Q, Voltage dependent resistors (VDRs) (see 1.5.9.1)</b>		<b>N/A</b>

<b>IEC 60950-1</b>			
Clause	Requirement + Test	Result - Remark	Verdict
	- Preferred climatic categories .....		N/A
	- Maximum continuous voltage .....		N/A
	- Combination pulse current .....		N/A
	Body of the VDR Test according to IEC60695-11-5 .....		N/A
	Body of the VDR. Flammability class of material ( min V-1) .....		N/A
<b>R</b>	<b>ANNEX R, EXAMPLES OF REQUIREMENTS FOR QUALITY CONTROL PROGRAMMES</b>		<b>N/A</b>
R.1	Minimum separation distances for unpopulated coated printed boards (see 2.10.6.2)		N/A
R.2	Reduced clearances (see 2.10.3)		N/A
<b>S</b>	<b>ANNEX S, PROCEDURE FOR IMPULSE TESTING (see 6.2.2.3)</b>		<b>N/A</b>
S.1	Test equipment		N/A
S.2	Test procedure		N/A
S.3	Examples of waveforms during impulse testing		N/A
<b>T</b>	<b>ANNEX T, GUIDANCE ON PROTECTION AGAINST INGRESS OF WATER (see 1.1.2)</b>		<b>N/A</b>
			—
<b>U</b>	<b>ANNEX U, INSULATED WINDING WIRES FOR USE WITHOUT INTERLEAVED INSULATION (see 2.10.5.4)</b>		<b>P</b>
		Approved triple insulated wire used in main transformer.	—
<b>V</b>	<b>ANNEX V, AC POWER DISTRIBUTION SYSTEMS (see 1.6.1)</b>		<b>P</b>
V.1	Introduction		P
V.2	TN power distribution systems		P
<b>W</b>	<b>ANNEX W, SUMMATION OF TOUCH CURRENTS</b>		<b>N/A</b>
W.1	Touch current from electronic circuits		N/A
W.1.1	Floating circuits		N/A
W.1.2	Earthed circuits		N/A
W.2	Interconnection of several equipments		N/A
W.2.1	Isolation		N/A

<b>IEC 60950-1</b>			
Clause	Requirement + Test	Result - Remark	Verdict
W.2.2	Common return, isolated from earth		N/A
W.2.3	Common return, connected to protective earth		N/A
<b>X</b>	<b>ANNEX X, MAXIMUM HEATING EFFECT IN TRANSFORMER TESTS (see clause C.1)</b>		<b>N/A</b>
X.1	Determination of maximum input current		N/A
X.2	Overload test procedure		N/A
<b>Y</b>	<b>ANNEX Y, ULTRAVIOLET LIGHT CONDITIONING TEST (see 4.3.13.3)</b>		<b>N/A</b>
Y.1	Test apparatus .....		N/A
Y.2	Mounting of test samples .....		N/A
Y.3	Carbon-arc light-exposure apparatus .....		N/A
Y.4	Xenon-arc light exposure apparatus .....		N/A
<b>Z</b>	<b>ANNEX Z, OVERVOLTAGE CATEGORIES (see 2.10.3.2 and Clause G.2)</b>		<b>P</b>
<b>AA</b>	<b>ANNEX AA, MANDREL TEST (see 2.10.5.8)</b>		<b>N/A</b>
<b>BB</b>	<b>ANNEX BB, CHANGES IN THE SECOND EDITION</b>		—
<b>CC</b>	<b>ANNEX CC, Evaluation of integrated circuit (IC) current limiters</b>		<b>N/A</b>
CC.1	General		N/A
CC.2	Test program 1 .....		N/A
CC.3	Test program 2 .....		N/A
CC.4	Test program 3 .....		N/A
CC.5	Compliance .....		N/A
<b>DD</b>	<b>ANNEX DD, Requirements for the mounting means of rack-mounted equipment</b>		<b>N/A</b>
DD.1	General		N/A
DD.2	Mechanical strength test, variable N.....		N/A
DD.3	Mechanical strength test, 250 N, including end stops.....		N/A
DD.4	Compliance.....		N/A
<b>EE</b>	<b>ANNEX EE, Household and home/office document/media shredders</b>		<b>N/A</b>



<b>IEC 60950-1</b>			
Clause	Requirement + Test	Result - Remark	Verdict
EE.1	General		<b>N/A</b>
EE.2	Markings and instructions		<b>N/A</b>
	Use of markings or symbols.....:		<b>N/A</b>
	Information of user instructions, maintenance and/or servicing instructions.....:		<b>N/A</b>
EE.3	Inadvertent reactivation test.....:		<b>N/A</b>
EE.4	Disconnection of power to hazardous moving parts:		<b>N/A</b>
	Use of markings or symbols.....:		<b>N/A</b>
EE.5	Protection against hazardous moving parts		<b>N/A</b>
	Test with test finger (Figure 2A) .....		<b>N/A</b>
	Test with wedge probe (Figure EE1 and EE2) .....		<b>N/A</b>

IEC 60950-1			
Clause	Requirement + Test	Result - Remark	Verdict

1.5.1	TABLE: List of critical components					P
Object/part No.	Manufacturer/ trademark	Type/model	Technical data	Standard (Edition / year)	Mark(s) of conformity <sup>1)</sup>	
LCD Panel with LED backlight	TPV	TPM340**** (*can be 0-9, A- Z or blank for marketing purpose).	34 inch TFT LCD (power consumption: 56.52W; LED array voltage: 56V)	--	Tested in equipment	
Plastic Enclosure	LOTTE ADVANCED MATERIALS CO LTD (SAMSUNG SDI)	SD-0150(+), VH-0810(+), VE-0812(+), NH-1000T(+)(&), GC- 0700(++)(RR28), GC-0700A(RR), GC- 0750(+)(RR70), GC- 1017(+)(RR30), VE-1890(+), BF-0675(+), BF-0670(+), NH-1017(p), NH-1017T, NH-1017SG(+), BF-0677(+), HS-7000(+), HG-0760(+), NE-1030(+), HR-1360(+), LX-0951(+), LX-0957(+), TH-1100(+), TN-1100(+)	HB or better, min. 1.6mm thickness	UL 94	UL (E115797)	
Alt.)	GRAND PACIFIC PETROCHEMIC AL CORP	D-150, D-1000, D-1000A	HB or better, min. 1.6mm thickness	UL 94	UL (E88637)	
Alt.)	CHI MEI CORPORATION	PA-757(+), PH-88, PA-756S	HB or better, min. 1.6mm thickness	UL 94	UL (E56070)	
Alt.)	ALBIS PLASTIC GMBH	GP-35, GP-22, 495F	HB or better, min. 1.6mm thickness	UL 94	UL (E80168)	
Alt.)	COVESTRO DEUTSCHLAN D AG [PC RESINS]	FR3000 series, FR3005 series	HB or better, min. 1.6mm thickness	UL 94	UL (E41613)	

IEC 60950-1					
Clause	Requirement + Test		Result - Remark		Verdict
Alt.)	LG CHEM LTD	HF350(#), HF380(m), HF380NS, HF380(#), HF-380(#), HF-380(m), HF-380, HF-380NS, HF380X, AF312T1, AF342T1, LUPOY GN- 5001TF(#), GN-5001RFD, LUPOY GN- 5008HF(#), LUPOY GP- 5008BF(#), SE750(#), XG568(#), XG569(#), GP-1000L, GP-1000F(#), GP-1000(m)(#), LUMILOY GP- 1000(#), SE750(#), LUPOY GN- 5001RF(T), SE885(#), HF388(#)	HB or better, min. 1.6mm thickness	UL 94	UL (E171666)
Alt.)	CHI LIN	GA-1535	HB or better, min. 1.6mm thickness	UL 94	UL (E177071)
Alt.)	PONTEX	AFE5000N, AFE5100N, 9004BK	HB or better, min. 1.6mm thickness	UL 94	UL (E205938)

IEC 60950-1					
Clause	Requirement + Test		Result - Remark		Verdict
Alt.)	KINGFA SCI & TECH CO LTD	4418, 5197, FRABS-518, HIPS-5197, HF-606, HF-626, FRABS-518, GAR-011C, JH960 6(M), FRHIPS-960, RS-900, RS-300, RS-400, GAR-011, GAR-011(L65), GAR-011(L85), GAR-011(HG6), CK-100, CK-900, CK-55111, JH960 6(M), FRHIPS-960, HIPS-4418, HIPS-3399, HIPS-CM(ee), HIPS-HG(ee), HIPS-510 (o), HIPS-550, CK-61(M) (##), RS-(hh)0, HP-126, ABS-660, ABS-122, GAR-322, GAR-332, GAR-220, H12, G360, CK-55(M) (##), CK-58(M) (##), GAR-011C, GAR-011(ww)	HB or better, min. 1.6mm thickness	UL 94	UL (E230779)
Alt.)	QINGDAO HAIER NEW MATERIAL R & D CO LTD	HRABS-RS, HRABS-HG, CR-3002	HB or better, min. 1.6mm thickness	UL 94	UL (E328304)
Alt.)	DONGGUAN HINGLONG PLASTIC TECHNOLOGY CO LTD	HL-ABS-PCR85, HL-ABS-PCR65, HL-ABS-PCR35	HB or better, min. 1.6mm thickness	UL 94	UL (E471190)

IEC 60950-1					
Clause	Requirement + Test		Result - Remark		Verdict
Alt.)	ORINKO (HEFEI) ADVANCED PLASTIC CO LTD	ABS-3070H, HIPS-2000	HB or better, min. 1.6mm thickness	UL 94	UL (E471190)
Alt.)	WISTRON ADVANCED MATERIALS (KUNSHAN) CO LTD	GA(M)(b)(c), GA35(a), NC30)	HB or better, min. 1.6mm thickness	UL 94	UL (E310240) (E359575)
Alt.)	UNIC TECHNOLOGY CORP	UR-3006+(RXX), UR-200+	HB or better, min. 1.6mm thickness	UL 94	UL (E135175)
Alt.)	GUO HENG (DONGGUAN)	YOUHO(#####)(Y)	HB or better, min. 1.6mm thickness	UL 94	UL (E471190)
Alt.)	HUIZHOU WOTE	2100	HB or better, min. 1.6mm thickness	UL 94	UL (E135175)
Alt.)	TEIJIN LIMITED RESIN AND PLASTIC	TN-7500(c), TN-7500F(#), MN-3600V(#), MN-3600H(#)	HB or better, min. 1.6mm thickness	UL 94	UL (E98529)
Alt.)	INEOS STYROLUTION GROUP GMBH	495F GR2, 495F KG2, 495F GR21, 495F KG21, PC2065	HB or better, min. 1.6mm thickness	UL 94	UL (E108538)
Alt.)	STYRON	STYRON A- TECH 1200	HB or better, min. 1.6mm thickness	UL 94	UL (E162447)
Alt.)	TOTAL PETROCHEMIC ALS SOUTH EAST ASIA PTE LTD	3441; 260-XX	HB or better, min. 1.6mm thickness	UL 94	UL (E314268)
Alt.)	DOOSAN CORPORATION ELECTRO- MATERIALS BG	DS-1107A; DS-1202G; DS-7106	HB or better, min. 1.6mm thickness	UL 94	UL (E103670)
Alt.)	SABIC JAPAN L L C	C6600(GG)(X)(V S) C6600E (VS)(X)	HB or better, min. 1.6mm thickness	UL 94	UL (E207780)
Mylar sheet around power board	SUZHOU OMA Y OPTICAL MATERIALS CO LTD	SE42B, SE42B-F	min. 0.4mm thickness, min. V- 1, 105°C	UL 94	UL
Alt.)	SICHUAN LONGHUA FILM CO LTD	PC-770F, PC-770F-A, PC-770	min. 0.4mm thickness, min. V- 1, 105°C	UL 94	UL

IEC 60950-1					
Clause	Requirement + Test		Result - Remark		Verdict
Alt.)	SICHUAN DONGFANG INSULATING MATERIAL CO LTD	DFR700, DFR700F	min. 0.4mm thickness, min. V-1, 105°C	UL 94	UL
Alt.)	CHENGDU KANGLONGXIN PLASTICS CO LTD	KLX FRPC-1860B, KLX FRPC-1870B	min. 0.4mm thickness, min. V-1, 105°C	UL 94	UL
Alt.)	CHENGDU KANGLONGXIN PLASTICS CO LTD	KLX FRPC-870B	min. 0.4mm thickness, min. V-1, 105°C	UL 94	UL
Alt.)	SICHUAN DONGFANG INSULATING MATERIAL CO LTD	DFR117ECOC, DFR117ECOB	min. 0.4mm thickness, min. V-1, 105°C	UL 94	UL
Alt.)	SICHUAN DONGFANG INSULATING MATERIAL CO LTD	DFR117ECO	min. 0.4mm thickness, min. V-1, 105°C	UL 94	UL
Alt.)	JINGMEN GORUN TECHNOLOGY CO LTD	HF70	min. 0.4mm thickness, min. V-1, 105°C	UL 94	UL
Alt.)	SICHUAN DONGFANG INSULATING MATERIAL CO LTD	DFR3A(d)	min. 0.4mm thickness, min. V-1, 105°C	UL 94	UL
Alt.)	SHENZHEN TEESUN TECHNOLOGY CO LTD	FR370, FR370F, FE383	min. 0.4mm thickness, min. V-1, 105°C	UL 94	UL
Alt.)	CHENGDU KANGLONGXIN PLASTICS CO LTD	KLX PP BK-10	min. 0.4mm thickness, min. V-1, 105°C	UL 94	UL
Alt.)	KUNSHAN DOBESTY OPTOELECTRONIC MATERIALS CO LTD	PC9842B	min. 0.4mm thickness, min. V-1, 105°C	UL 94	UL
Adhesive for mylar sheet	SYMBIO	DS50-A, DS50L	100°C, 0.05mm Thickness	UL 969	UL

<b>IEC 60950-1</b>					
Clause	Requirement + Test		Result - Remark		Verdict
Alt.)	3M	55236	100°C, 0.05mm Thickness	UL 969	UL
<b>Switching mode power supply board: 715GA649 by TPV</b>					
AC-Inlet (CN9102)	Solteam	ST-01	10A, 250Vac	IEC/ EN 60320-1 UL60320-1	VDE, UL
Alt.)	Hua Jie	SA-4S	10A, 250Vac	IEC/ EN 60320-1 UL60320-1	VDE, UL
Alt.)	Rong Feng	SS-120, SS-7B	10A, 250Vac	IEC/ EN 60320-1 UL60320-1	VDE, UL
Alt.)	DELIKANG/ Douling	CDJ-3, CDJ-3-1	10A, 250Vac	IEC/ EN 60320-1 UL60320-1	VDE, UL
Alt.)	Inalways	0707-1, 0711-2, 0714	10A, 250Vac	IEC/ EN 60320-1 UL60320-1	VDE, UL
Alt.)	TECX	TU-301-A, TU-301-AP, TU-301-S, TU-301-SP	10A, 250Vac	IEC/ EN 60320-1 UL60320-1	VDE, UL
Fuse (F9901 in primary)	Littelfuse, Inc. Wickmann	382-series, 392	T4AL, 250Vac	IEC/ EN 60127-1 IEC/ EN 60127-3 UL 248-1	VDE, UL
Alt.)	Littelfuse Phils. Inc.	TE5 400 series	T4AL, 250Vac	IEC/ EN 60127-1 IEC/ EN 60127-3 UL 248-1	VDE
Alt.)	Conquer	MET series MST series PTU	T4AL, 250Vac	IEC/ EN 60127-1 IEC/ EN 60127-3 UL 248-1	VDE, UL
Alt.)	Cooper Bussmann	SR-5, SS-5	T4AL, 250Vac	IEC/ EN 60127-1 IEC/ EN 60127-3 UL 248-1	VDE, UL
Alt.)	Ever Island Electric Co., Ltd. & Walter Electric	2000, 2010 series	T4AL, 250Vac	IEC/ EN 60127-1 IEC/ EN 60127-3 UL 248-1	VDE, UL
Alt.)	Littelfuse Phils. Inc.	877	T4AL, 250Vac	IEC/ EN 60127-1 IEC/ EN 60127-3 UL 248-1	VDE, UL
Fuse (F9902 in secondary for L.P.S.)	Littelfuse, Inc. Wickmann	382-series, 392	T5AL, 250Vac	IEC/ EN 60127-1 IEC/ EN 60127-3 UL 248-1	VDE, UL
Alt.)	Littelfuse Phils. Inc.	TE5 400 series	T5AL, 250Vac	IEC/ EN 60127-1 IEC/ EN 60127-3 UL 248-1	VDE
Alt.)	Conquer	MET series MST series PTU	T5AL, 250Vac	IEC/ EN 60127-1 IEC/ EN 60127-3 UL 248-1	VDE, UL

IEC 60950-1					
Clause	Requirement + Test		Result - Remark		Verdict
Alt.)	Cooper Bussmann	SR-5, SS-5	T5AL, 250Vac	IEC/ EN 60127-1 IEC/ EN 60127-3 UL 248-1	VDE, UL
Alt.)	Ever Island Electric Co., Ltd. & Walter Electric	2000, 2010 series	T5AL, 250Vac	IEC/ EN 60127-1 IEC/ EN 60127-3 UL 248-1	VDE, UL
Alt.)	Littelfuse Phils. Inc.	877	T5AL, 250Vac	IEC/ EN 60127-1 IEC/ EN 60127-3 UL 248-1	VDE, UL
Y- Capacitor (C9915, C9916, C9917, C9919) Y1 or Y2 type (optional)	Walsin	AC, AH	Max. 470pF, 250Vac, 85°C	IEC/EN 60384-14, UL 60384-14	VDE, UL
Alt.)	Wansheng	CT7	Max. 470pF, 250Vac, 85°C	IEC/EN 60384-14, UL 60384-14	VDE, UL
Alt.)	TDK	CS, CD	Max. 470pF, 250Vac, 85°C	IEC/EN 60384-14, UL 60384-14	VDE, UL
Alt.)	Murata	KH, KX	Max. 470pF, 250Vac, 85°C	IEC/EN 60384-14, UL 60384-14	VDE, UL
Alt.)	Matsushita	NS-A, NS-B	Max. 470pF, 250Vac, 85°C	IEC/EN 60384-14, UL 60384-14	VDE, UL
Alt.)	JYA-NAY	JY, JN	Max. 470pF, 250Vac, 85°C	IEC/EN 60384-14, UL 60384-14	VDE, UL
Alt.)	Hongming	F	Max. 470pF, 250Vac, 85°C	IEC/EN 60384-14, UL 60384-14	VDE, UL
Alt.)	Yinan Don's	CT81	Max. 470pF, 250Vac, 85°C	IEC/EN 60384-14, UL 60384-14	VDE, UL
Alt.)	SUCCESS	SB, SE	Max. 470pF, 250Vac, 85°C	IEC/EN 60384-14, UL 60384-14	VDE, UL
Y- Capacitor (C9911) Y1 type (optional)	Walsin	AH	Max. 1000pF, 250Vac, 85°C	IEC/EN 60384-14, UL 60384-14	VDE, UL
Alt.)	TDK	CD	Max. 1000pF, 250Vac, 85°C	IEC/EN 60384-14, UL 60384-14	VDE, UL
Alt.)	Murata	KX	Max. 1000pF, 250Vac, 85°C	IEC/EN 60384-14, UL 60384-14	VDE, UL
Alt.)	Kunshan Wansheng	CT7	Max. 1000pF, 250Vac, 85°C	IEC/EN 60384-14, UL 60384-14	VDE, UL
Alt.)	YINAN DON'S ELECTRONI C COMPONENT CO.,LTD	CT81	Max. 1000pF, 250Vac, 85°C	IEC/EN 60384-14, UL 60384-14	VDE, UL



IEC 60950-1					
Clause	Requirement + Test		Result - Remark		Verdict
Alt.)	SUCCESS	SE	Max. 1000pF, 250Vac, 85°C	IEC/EN 60384-14, UL 60384-14	VDE, UL
Alt.)	SUCCESS	SB	Max. 1000pF, 250Vac, 85°C	IEC/EN 60384-14, UL 60384-14	VDE, UL
X-Capacitor (X1 or X2 type) (C9918, C9920) (optional)	Ultra Tech Xiphi	HQX	Max. 0.33µF, Min. 250Vac, 85°C	IEC/EN 60384-14 UL 60384-14	VDE, UL
Alt.)	Europtronic	MPX	Max. 0.33µF, Min. 250Vac, 85°C	IEC/EN 60384-14 UL 60384-14	VDE, UL
Alt.)	Europtronic	MPX2	Max. 0.33µF, Min. 250Vac, 85°C	IEC/EN 60384-14 UL 60384-14	VDE, UL
Alt.)	Liow Gu	GS-L	Max. 0.33µF, Min. 250Vac, 85°C	IEC/EN 60384-14 UL 60384-14	VDE, UL
Alt.)	Arcotronics (KEMET)	R.46	Max. 0.33µF, Min. 250Vac, 85°C	IEC/EN 60384-14 UL 60384-14	ENEC, UL
Alt.)	EPCOS	B3292#	Max. 0.33µF, Min. 250Vac, 85°C	IEC/EN 60384-14 UL 60384-14	VDE, UL
Alt.)	Nanjing Tengen Rongguangda	MKP	Max. 0.33µF, Min. 250Vac, 85°C	IEC/EN 60384-14 UL 60384-14	VDE, UL
Discharge IC (U9104)	Leadtrend Technology Corp.	LD5760	85°C	IEC/EN 60950-1:2005+ A1	Nemko CB (Certif. No: NO77082, Date: 2013.09.10)
Photo Coupler (U9102, U9401)	Sharp	PC123	Di more than 0.4mm, int = thermal cycling test, ext. more than 8.0mm, 5000Vac, 100°C.	DIN EN 60747-5-5:2007 IEC60747-5-5:2007 IEC/EN 60950-1 UL 1577	VDE, UL, Semko, Nemko, Fimko
Alt.)	Vishay Semiconductor	TCET1103	Di more than 0.5mm, int. cr more than 6.0mm, ext. cr more than 7.7mm, 3000Vac, 100°C.	DIN EN 60747-5-5:2007 IEC60747-5-5:2007 IEC/EN 60950-1 UL 1577	VDE, UL, Semko, Fimko

IEC 60950-1					
Clause	Requirement + Test		Result - Remark		Verdict
Alt.)	Everlight Electronics Co., Ltd.	EL817, EL817M	Di more than 0.5mm, int. cr = thermal cycling test, ext. cr more than 7.7mm, 3000Vac, 100°C.	DIN EN 60747-5-5:2007 IEC60747-5-5:2007 IEC/EN 60950-1 UL 1577	VDE, UL, Semko, Nemko, Fimko
Alt.)	TOSHIBA	TLP781F , TLP781	Di more than 0.5mm, int. cr =thermal cycling test, ext. cr more than 8.0mm, 4800Vac, 100°C.	DIN EN 60747-5-5:2007 IEC60747-5-5:2007 IEC/EN 60950-1 UL 1577	VDE, UL, Semko
Alt.)	TOSHIBA	TLP421F	Di more than 0.4mm, int.cr=thermal cycling test, ext. cr more than 8.0mm, 5000Vac, 100°C.	DIN EN 60747-5-5:2007 IEC60747-5-5:2007 IEC/EN 60950-1 UL 1577	VDE, UL
Alt.)	RENESAS ELECTRONICS CORPORATION	PS2561-1, PS2561L-1, PS2561L1-1, PS2561L2-1. PS2561DL1-1	Di more than 0.4mm, int.cr=thermal cycling test, ext. cr more than 8.0mm, 5000Vac, 100°C.	DIN EN 60747-5-5:2007 IEC60747-5-5:2007 IEC/EN 60950-1 UL 1577	VDE, UL, Nemko, Fimko
Alt.)	Everlight Electronics Co., Ltd.	EL1013	Di more than 0.4mm, int.cr=thermal cycling test, ext. cr more than 8.1mm, 3000Vac, 100°C.	DIN EN 60747-5-5:2007 IEC60747-5-5:2007 IEC/EN 60950-1 UL 1577	VDE, UL, Semko, Fimko
Alt.)	Lite-On	LTV-817	Di more than 0.6mm, int.cr=thermal cycling test, ext. cr more than 8.0mm, 4800Vac, 100°C.	DIN EN 60747-5-5:2007 IEC60747-5-5:2007 IEC/EN 60950-1 UL 1577	VDE, UL, Semko, Fimko
Line Choke (L9801) (Optional)	CHANNELON	373G0174315H	105°C	--	--

IEC 60950-1					
Clause	Requirement + Test		Result - Remark		Verdict
Alt.)	ASET	373G0174315X	105°C	--	--
Alt.)	YUVA	373G0174315N	105°C	--	--
Alt.)	CHEN PING	373G0174315CP			
Line Choke (L9901, L9902) (Optional)	CHANNELON	373G0174575H	105°C	--	--
Alt.)	LIANZHEN	373G0174575Z	105°C	--	--
Transformer (T9102) (Alt.)	CHANNELON	380GL32P530H	Min. Class 130 material (B)	Applicable parts of IEC 60950-1 and according to IEC 60085	Accepted by TÜV Rheinland
- Bobbin	SUMITOMO	PM-9820	V-0, Phenolic, 150°C	UL 94	UL
- Triple insulation wire	COSMOLINK YUSHENG	TIW-M	Max.130°C	IEC/EN 60950-1, VDE0805 Teil1, UL 2353	UL, VDE
- Teflon tube	GREAT HOLDING	TFL	200°C	UL 224	UL
- Insulation tape	Jing jiang YaHua SYMBIO	CT NO.35660Y	130°C	UL 510	UL
Transformer (T9102) (Alt.)	YUVA	380GL32P530N	Min. Class 130 material (B)	Applicable parts of IEC 60950-1 and according to IEC 60085	Accepted by TÜV Rheinland
- Bobbin	SUMITOMO	PM-9820	V-0, Phenolic, 150°C	UL 94	UL
- Triple insulation wire	COSMOLINK YUSHENG	TIW-M	Max.130°C	IEC/EN 60950-1, VDE0805 Teil1, UL 2353	UL, VDE
- Teflon tube	GREAT HOLDING	TFL	200°C	UL 224	UL
- Insulation tape	Jing jiang YaHua SYMBIO	CT NO.35660Y	130°C	UL 510	UL

IEC 60950-1			
Clause	Requirement + Test	Result - Remark	Verdict

**Supplementary information:**

- <sup>1)</sup> Provided evidence ensures the agreed level of compliance. See OD-CB2039.
- 'Di' means distance through insulation, 'int.' Means internal distance of creepage and 'ext.' Means external distance of creepage.
- All sources of transformer were checked with same construction.
- Rating information of components which are not critical component:  
 Thermistor (TH9903, TH9904): Min. 2.5Ω, Min. 2A, 25°C  
 Bridging Diode (BD9901): Min. 2A, Max 800V.  
 Ripple Capacitor (C9813, C9814 and C9815): 30-68uF, min. 450 V, min .105°C  
 Transistor (Q9801, Q9101): Min. 5A, 500V min.  
 Current sensor resistor (R9111, R9808): Min. 0.15Ω, 2W

1.5.1	TABLE: Opto Electronic Devices	P
Manufacturer .....	See appended table 1.5.1 (List of critical components)	
Type .....	See appended table 1.5.1 (List of critical components)	
Separately tested .....	Tested with appliance	
Bridging insulation .....	Reinforced insulation.	
External creepage distance .....	See appended table 1.5.1 (List of critical components)	
Internal creepage distance .....	Approved source used <sup>1</sup> .	
Distance through insulation .....	See appended table 1.5.1 (List of critical components)	
Tested under the following conditions .....		
Input .....	Tested with appliance	
Output .....	Tested with appliance	
<b>Supplementary information:</b>		
1. All sources of photo coupler were in compliance with EN60747-5-5 and CTL DSH 759 decision.		

1.6.2	TABLE: Electrical data (in normal conditions)					P
U (V)	I (A)	Irated (A)	P (W)	Fuse #	Ifuse (A)	Condition/status
HDMI mode						
90/50	0.960	--	85.8	F9901	0.960	Maximum normal load
90/60	0.977	--	85.9	F9901	0.977	Maximum normal load
100/50	0.858	1.5	84.9	F9901	0.858	Maximum normal load
100/60	0.864	1.5	84.9	F9901	0.864	Maximum normal load
240/50	0.387	1.5	82.3	F9901	0.387	Maximum normal load

IEC 60950-1						
Clause	Requirement + Test				Result - Remark	Verdict
240/60	0.389	1.5	82.3	F9901	0.389	Maximum normal load
264/50	0.370	--	81.9	F9901	0.370	Maximum normal load
264/60	0.365	--	82.0	F9901	0.365	Maximum normal load
DisplayPort mode						
90/50	0.960	--	85.8	F9901	0.960	Maximum normal load
90/60	0.964	--	85.7	F9901	0.964	Maximum normal load
100/50	0.859	1.5	85.1	F9901	0.859	Maximum normal load
100/60	0.867	1.5	85.4	F9901	0.867	Maximum normal load
240/50	0.385	1.5	81.9	F9901	0.385	Maximum normal load
240/60	0.388	1.5	82.3	F9901	0.388	Maximum normal load
264/50	0.367	--	81.7	F9901	0.367	Maximum normal load
264/60	0.364	--	81.7	F9901	0.364	Maximum normal load
<b>Supplementary information:</b>						
1. Maximum normal load: maximum brightness, maximum contrast, full white screen; each USB 2.0 port in main board was maximum loaded to 5V/0.9A, each USB 3.0 port in USB board was maximum loaded to 5V/1.5A.						

2.1.1.5 c) 1)	TABLE: max. V, A, VA test				P
Voltage (rated) (V)	Current (rated) (A)	Voltage (max.) (V)	Current (max.) (A)	VA (max.) (VA)	
+19V	--	19.11	5.46	100.70	
<b>Supplementary information:</b> Test voltage is 264Vac, 60Hz.					

2.1.1.5 c) 2)	TABLE: stored energy		N/A
Capacitance C (μF)	Voltage U (V)	Energy E (J)	
--	--	--	
<b>Supplementary information:</b>			

2.2	TABLE: evaluation of voltage limiting components in SELV circuits			P
Component (measured between)	max. voltage (V) (normal operation)		Voltage Limiting Components	
	V peak	V d.c.		
T9102 Pin 6,7, 8 – 10,11,12	86.2	--		
After D9105/C9141	21.2	--	D9105/C9141	

IEC 60950-1			
Clause	Requirement + Test	Result - Remark	Verdict
	After L801 to earth	--	51.6
	Fault test performed on voltage limiting components	Voltage measured (V) in SELV circuits (V peak or V d.c.)	
	C9141 (s-c)	14.5(for +19V output)	
	D9105 (s-c)	0 (for +19V output)	
supplementary information: Input Voltage is 264Vac, 60Hz.			

2.5	TABLE: Limited power sources					P
<b>Circuit output tested: 14V outputs of power board</b>						
Note: Measured Uoc (V) with all load circuits disconnected: See below						
Components	Test condition (Single fault)	Uoc (V)	I <sub>sc</sub> (A)		VA	
			Meas.	Limit	Meas.	Limit
<b>Circuit output tested: +19V outputs of power board <sup>2)</sup></b>						
<sup>1)</sup>	Normal condition	19.1	5.46	1000/Uoc= 52.4	100.70	250
<b>Supplementary information:</b>						
1. Input Voltage is 264Vac, 60Hz.						
2. Output protected by fuses that will break the circuit within 120s with a current equal to 210%. Current limit of table 2C reduced to breaking capacity of the fuse (50A).						

2.10.2	Table: working voltage measurement			P
Location	RMS voltage (V)	Peak voltage (V)	Comments	
Input Voltage is 264Vac, 60Hz.				
T9102: Pin 1 to pin 6,7,8	200	409		
T9102: Pin 1 to pin 10,11,12	200	384		
T9102: Pin 2 to pin 6,7,8	200	388		
T9102: Pin 2 to pin 10,11,12	200	441		
T9102: Pin 3 to pin 6,7,8	315	553		
T9102: Pin 3 to pin 10,11,12	<b>330</b>	<b>575</b>	<b>Max. Vpeak and Max. Vrms</b>	
T9102: Pin 5 to pin 6,7,8	300	516		
T9102: Pin 5 to pin 10,11,12	258	422		
U9401 Pin 1-3	192	382		
U9401 Pin 1-4	192	381		
U9401 Pin 2-3	192	378		

IEC 60950-1			
Clause	Requirement + Test	Result - Remark	Verdict
U9401 Pin 2-4	192	382	
U9102 Pin 1-3	176	372	
U9102 Pin 1-4	175	366	
U9102 Pin 2-3	176	369	
U9102 Pin 2-4	175	372	
C9911 primary pin – secondary pin	197	384	
<b>Supplementary information:</b>			

2.10.3 and 2.10.4	TABLE: Clearance and creepage distance measurements						P
Clearance (cl) and creepage distance (cr) at/of/between:	U peak (V)	U r.m.s. (V)	Required cl (mm)	cl (mm)	Required cr (mm)	cr (mm)	
Functional:							
Under fuse (F901)	420	250	2.3	3.1	2.5	3.1	
Before fuse (between L-N) <sup>1.</sup>	420	250	2.3	5.6	2.5	7.4	
Basic/supplementary:							
Line-GND <sup>1.</sup>	420	250	3.0	3.0	3.0	3.7	
Neutral-GND <sup>1.</sup>	420	250	3.0	3.0	3.0	3.7	
Under C9915	420	250	3.0	7.7	3.0	7.7	
Under C9916	420	250	3.0	7.7	8.1	7.7	
Under C9917	420	250	3.0	7.7	8.1	7.7	
Under C9919	420	250	3.0	7.7	8.1	7.7	
Transformer core to metal enclosure <sup>3.</sup>	<b>575</b>	<b>330</b>	3.5	<sup>6.</sup>	3.5	<sup>6.</sup>	
Soldering side of power board to the plate of panel <sup>3.</sup>	<b>575</b>	<b>330</b>	3.5	<sup>6.</sup>	3.5	<sup>6.</sup>	
Reinforced:							
Under T9102	<b>575</b>	<b>330</b>	6.9	<sup>6.</sup>	6.9	<sup>6.</sup>	
Secondary trace to core of transformer T9102	<b>575</b>	<b>330</b>	6.9	7.0	6.9	7.0	
Secondary component (HS9105) to core of transformer T9102	<b>575</b>	<b>330</b>	6.9	14.7	6.9	14.7	
Secondary component (HS9105) to primary component (HS1)	<b>575</b>	<b>330</b>	6.9	8.8	6.9	8.8	

IEC 60950-1						
Clause	Requirement + Test			Result - Remark		Verdict
Under C9911	420	250	6.0	8.1	6.0	9.4
Under U9401	420	250	6.0	8.2	6.0	8.2
Under U9102	420	250	6.0	8.2	6.0	8.2
<b>Supplementary information:</b>						
1. There is one slot measured 1mm width.						
2. Core of main transformers T9102 and T905 consider as primary.						
3. One mylar sheet is fixed around power board to fulfil the requirement for basic. See table 5.2 for the electric strength test for mylar.						
4. Glued component: C9815, C9813 and C9814.						
5. Considered altitude correction factor 1.48 for clearances for an altitude of 5000m.						
6. For clearance and creepage that did not describe above are far larger than limit above.						

2.10.5	TABLE: Distance through insulation measurements					P
Distance through insulation (DTI) at/of:	U peak (V)	U rms (V)	Test voltage (V)	Required DTI (mm)	DTI (mm)	
Photo coupler (reinforced insulation)	420	250	3000	0.4	1.	
Mylar sheet between around power board	420	250	3000	0.4	min. 0.4	
<b>Supplementary information:</b>						
1. For approved component source see appended table 1.5.1.						

4.3.8	TABLE: Batteries								N/A
The tests of 4.3.8 are applicable only when appropriate battery data is not available									
Is it possible to install the battery in a reverse polarity position?									
	Non-rechargeable batteries			Rechargeable batteries					
	Discharging		Un-intentional charging	Charging		Discharging		Reversed charging	
	Meas. current	Manuf. Specs.		Meas. current	Manuf. Specs.	Meas. current	Manuf. Specs.	Meas. current	Manuf. Specs.
Max. current during normal condition									
Max. current during fault condition									
Test results:									Verdict



IEC 60950-1			
Clause	Requirement + Test	Result - Remark	Verdict
	- Chemical leaks		
	- Explosion of the battery		
	- Emission of flame or expulsion of molten metal		
	- Electric strength tests of equipment after completion of tests		
<b>Supplementary information:</b>			

4.3.8	TABLE: Batteries	N/A
Battery category .....: (Lithium, NiMh, NiCad, Lithium Ion ...)		
Manufacturer .....		
Type / model.....		
Voltage .....		
Capacity ..... mAh		
Tested and Certified by (incl. Ref. No.) .....		
Circuit protection diagram:		

MARKINGS AND INSTRUCTIONS (1.7.13)	
Location of replaceable battery	
Language(s) .....	
Close to the battery .....	
In the servicing instructions .....	
In the operating instructions .....	

4.5	TABLE: Thermal requirements						P
	Supply voltage (V) .....	90V/ 60Hz	264V/ 60Hz	--	--	--	—
	Ambient T <sub>min</sub> (°C) .....	See below	See below	--	--	--	—
	Ambient T <sub>max</sub> (°C) .....	See below	See below	--	--	--	—
Maximum measured temperature T of part/at.....:		T (°C)					Allowed T <sub>max</sub> (°C)
Test on HDMI mode		Horizontal		--	--	--	--
AC Inlet CN9102 (on power board)		48.6	43.2	--	--	--	56.4
C9916 body (on power board)		56.4	47.6	--	--	--	71.4
PCB near TH9903 (on power board)		72.9	53.4	--	--	--	91.4

IEC 60950-1							
Clause	Requirement + Test		Result - Remark			Verdict	
C9918 body (on power board)	66.4	52.5	--	--	--	71.4	
L9901 coil (on power board)	65.4	51.8	--	--	--	91.4	
L9902 coil (on power board)	67.1	53.0	--	--	--	91.4	
PCB near BD9901 (on power board)	70.5	54.6	--	--	--	91.4	
C9815 body (on power board)	51.3	48.8	--	--	--	86.4	
L9801 coil (on power board)	69.3	58.9	--	--	--	106.4	
L9801 core (on power board)	78.5	61.5	--	--	--	106.4	
T9102 coil (on power board)	87.2	82.0	--	--	--	96.4	
T9102 core (on power board)	83.3	78.3	--	--	--	96.4	
C9911 body (on power board)	51.1	48.0	--	--	--	71.4	
U9401 body (on power board)	60.9	59.3	--	--	--	86.4	
U9102 body (on power board)	59.3	58.7	--	--	--	86.4	
PCB near D9105 (on power board)	86.5	81.3	--	--	--	91.4	
PCB near Q9101 (on power board)	81.9	73.0	--	--	--	91.4	
L801 coil (on power board)	84.9	81.6	--	--	--	91.4	
Main IC (on main board)	59.9	60.0	--	--	--	91.4	
Plastic enclosure outside near T9101	41.2	39.6	--	--	--	81.4	
Metal enclosure	51.7	46.5	--	--	--	56.4	
Panel surface	36.5	37.0	--	--	--	81.4	
Ambient	26.4 (40)	26.4 (40)	--	--	--	--	
<b>Supplementary information:</b>							
Temperature T of winding:	t <sub>1</sub> (°C)	R <sub>1</sub> (Ω)	t <sub>2</sub> (°C)	R <sub>2</sub> (Ω)	T (°C)	Allowed T <sub>max</sub> (°C)	Insulation class
<b>Supplementary information:</b>							
<p>1. The temperatures were measured under the worst case normal mode defined in 1.2.2.1 and as described in sub-clause 1.6.2 at voltages as described above.</p> <p>2. All source of each transformer considered with maximum value recorded.</p> <p>3. With a specified ambient temperature of 40°C. Temperature limits are calculated as follows:</p> <p>Winding components providing safety isolation:</p> <ul style="list-style-type: none"> <li>- Class B → T<sub>max</sub> = 120 °C – 10 °C - 40°C + Tamb</li> </ul> <p>Components with maximum absolute temperature of others:</p> <ul style="list-style-type: none"> <li>- Tmax= Tmax of component - 40°C + Tamb</li> </ul>							

IEC 60950-1			
Clause	Requirement + Test	Result - Remark	Verdict

4.5.5	TABLE: Ball pressure test of thermoplastic parts			P
	Allowed impression diameter (mm) .....	≤ 2 mm		—
Part	Test temperature (°C)	Impression diameter (mm)		
Plastic enclosure, Kingfa: HIPS-5197, 2.5mm	90	1.59		
Plastic enclosure, Kingfa: GAR-011(L85), 2.5mm	85	1.31		
Plastic enclosure, Kingfa: GAR-011(L65), 2.5mm	85	1.29		
Plastic enclosure, Kingfa: HIPS-510(H), 2.5mm	80	1.29		
Plastic enclosure, Kingfa: FRHIPS-960, 2.5mm	85	1.88		
Plastic enclosure, Cheil: GC-0750(+), 2.5mm	80	1.61		
Plastic enclosure, Cheil: GC-0700(+), 2.5mm	80	1.94		
Plastic enclosure, Cheil: HG-0760(+), 2.5mm	85	1.73		
Plastic enclosure, Cheil: LX-0951(+), 2.5mm	85	1.83		
Plastic enclosure, Cheil: SD-0150, 2.5mm	85	1.48		
Plastic enclosure, Cheil: HR-1360, 2.5mm	85	1.71		
Plastic enclosure, Cheil: BF-0670F, 2.5mm	80	1.59		
Plastic enclosure, LG: HF380, 2.5mm	85	1.48		
Plastic enclosure, LG: SE885, 2.5mm	80	1.42		
Plastic enclosure, LG: LUPOY GP-1000(#), 2.5mm	95	1.21		
Plastic enclosure, LG: XG568, 2.5mm	80	1.81		
Plastic enclosure, LG: XG569C, 2.5mm	80	1.85		
Plastic enclosure, LG: HF388H, 2.5mm	85	1.39		
Plastic enclosure, LG: SE750, 2.5mm	80	1.5		
Plastic enclosure, Teijin: TN-7500, 2.5mm	85	1.57		
Plastic enclosure, ORINKO: HIPS-2000, 2.5mm	85	1.48		
Plastic enclosure, Kingfa: GAR-011C, 2.5mm	90	1.91		
<b>Supplementary information:</b> Above mentioned plastic enclosure material was tested by client's request.				

5.1	TABLE: touch current measurement			P
Measured between:	Measured (mA)	Limit (mA)	Comments/conditions	
L – metal enclosure	0.16	3.5	Switch “e” open	
N – metal enclosure	0.16	3.5	Switch “e” open	
L – signal connector	0.01	0.25	Switch “e” close *	

IEC 60950-1			
Clause	Requirement + Test	Result - Remark	Verdict
N – signal connector	0.01	0.25	Switch “e” close *
L – plastic enclosure	0.01	0.25	Switch “e” close
N – plastic enclosure	0.01	0.25	Switch “e” close
<b>Supplementary information:</b> Input Voltage is 264Vac, 60Hz.			

5.2	TABLE: Electric strength tests, impulse tests and voltage surge tests			P
Test voltage applied between:	Voltage shape (AC, DC, impulse, surge)	Test voltage (V)	Breakdown Yes / No	
Basic/supplementary:				
Unit primary to earthed metal part	AC	1864	No	
Reinforced:				
L/N to accessible plastic enclosure with metal foil	AC	3000	No	
Mylar sheet fixed between power board trace side and panel plate <sup>2)</sup>	AC	3000	No	
Unit primary to secondary (output)	DC	4242	No	
T9102 <sup>1)</sup> : primary to secondary	AC	3000	No	
T9102 <sup>1)</sup> : secondary to core	AC	3000	No	
T9102 <sup>1)</sup> : one layer of insulation tape	AC	3000	No	
<b>Supplementary information:</b>				
<ol style="list-style-type: none"> <li>Each source of transformer has been tested and passed;</li> <li>For all source of mylar sheet;</li> <li>The tests mentioned above were performed after humidity test.</li> </ol>				

IEC 60950-1						
Clause	Requirement + Test				Result - Remark	Verdict
5.3	TABLE: Fault condition tests					P
	Ambient temperature (°C) .....				See below	—
	Power source for EUT: Manufacturer, model/type, output rating .....				See appended table 1.5.1	—
Component No.	Fault	Supply voltage (V)	Test time	Fuse #	Fuse current (A)	Observation
Ventilation openings	blocked	264	4h	F9901	0.365	Max. measured temperature: T9102 coil = 88.3°C, T9102 core = 84.9°C, U9102 = 80.3°C, AC inlet = 49.5°C, Metal enclosure = 53.0°C, Plastic enclosure outside near T9102 = 40.5°C, Panel = 45.9°C, Button = 35.8°C, Ambient = 25.6°C Unit operated normally, no hazards, no damage.
+19V output	overload	264	4h	F9901	0.435	Max. measured temperature: T9102 coil = 93.8°C, T9102 core = 89.2°C, U9102 = 83.4°C, AC inlet = 45.6°C, Metal enclosure = 50.6°C, Plastic enclosure outside near T9102 = 35.6°C, Panel = 36.5°C, Button = 33.8°C, Ambient = 27.0 °C Before shutdown winding is loaded to additional 1.60A. No damage, no hazards.
USB 3.0 Port	overload	264	4h	F9901	0.372	Max. measured temperature: T9102 coil = 85.0 °C, T9102 core = 81.5 °C, U9102 = 76.8°C, AC inlet = 43.6 °C, Metal enclosure = 47.1 °C, Plastic enclosure outside near T9102 = 35.0 °C, Panel = 36.9 °C, Button = 33.6 °C, Ambient = 25.9 °C Before shutdown winding is loaded to additional 1.91A/7.68W. No damage, no hazards.
BD9901 Pin 1-2	s-c	264	<1 sec.	F9901	--	Fuse open instantly, no hazards.

IEC 60950-1						
Clause	Requirement + Test			Result - Remark		Verdict
C9813	s-c	264	<1 sec.	F9901	--	Fuse open instantly, no hazards.
U9801 Pin 5-6	s-c	264	1min	F9901	0.365	Unit operated normally, no damage, no hazards.
U9801 Pin 6-7	s-c	264	1min	F9901	0.365	Unit operated normally, no damage, no hazards.
U9801 Pin 5-8	s-c	264	1min	F9901	0.365	Unit operated normally, no damage, no hazards.
U9801 Pin 3-4	s-c	264	1min	F9901	0.365	Unit operated normally, no damage, no hazards.
U9104 Pin 8-1	s-c	264	1min	F9901	0.075	Unit shutdown, no damage, no hazards.
U9104 Pin 8-2	s-c	264	<1 sec.	F9901	--	Fuse open instantly, R9165 damaged, no hazards.
U9104 Pin 3-4	s-c	264	1min	F9901	0.365	Unit operated normally, no damage, no hazards.
D9101	s-c	264	1min	F9901	0.365	Unit operated normally, no damage, no hazards.
Q9101 Pin G-S	s-c	264	1min	F9901	0.075	Unit shutdown, no damage, no hazards.
Q9101 Pin G-D	s-c	264	<1 sec.	F9901	--	Fuse open instantly, R9111, R9105, U9104, D9102 damaged, no hazards.
Q9101 Pin D-S	s-c	264	1min	F9901	--	Fuse open instantly, R9111, R9105, U9104, D9102 damaged, no hazards.
Q9801 Pin G-S	s-c	264	1min	F9901	0.075	Unit shutdown, no damage, no hazards.
Q9801 Pin G-D	s-c	264	<1 sec.	F9901	--	Fuse open instantly, R9808 damaged, no hazards.
Q9801 Pin D-S	s-c	264	<1 sec.	F9901	--	Fuse open instantly, R9808 damaged, no hazards.
D9106	s-c	264	1min	F9901	0.365	Unit operated normally, no damage, no hazards.
R9145	s-c	264	1min	F9901	0.260	Unit operated normally, no damage, no hazards.
R9111	s-c	264	1min	F9901	0.229	Unit operated normally, no damage, no hazards.
T9102 Pin 1-2	s-c	264	1min	F9901	0.075	Unit shutdown, no damage, no hazards.
T9102 Pin 3-5	s-c	264	1min	F9901	0.075	Unit shutdown, no damage, no hazards.

IEC 60950-1						
Clause	Requirement + Test				Result - Remark	Verdict
T9102 Pin 6,7,8-10,11,12	s-c	264	1min	F9901	0.092	Unit shutdown, no damage, no hazards.
C9136	s-c	264	1min	F9901	0.075	Unit shutdown, no damage, no hazards.
U9102 Pin 1	o-c	264	1min	F9901	0.075	Unit shutdown, no damage, main board U701 damage, no hazards. Repeated the test with three times and same result come out. No hazards.
U9102 Pin 3	o-c	264	1min	F9901	0.075	Unit shutdown, no damage, main board U701 damage, no hazards. Repeated the test with three times and same result come out. No hazards.
U9102 Pin 1-2	s-c	264	1min	F9901	0.075	Unit shutdown, no damage, main board U701 damage, no hazards. Repeated the test with three times and same result come out. No hazards.
U9102 Pin 3-4	s-c	264	1min	F9901	0.075	Unit shutdown, no damage, main board U701 damage, no hazards. Repeated the test with three times and same result come out. No hazards.
U9102 Pin 1	o-c	264	1min	F9901	0.075	Unit shutdown, no damage, no hazards.
U9102 Pin 3	o-c	264	1min	F9901	0.075	Unit shutdown, no damage, no hazards.
U9102 Pin 1-2	s-c	264	1min	F9901	0.075	Unit shutdown, no damage, no hazards.
U9102 Pin 3-4	s-c	264	1min	F9901	0.075	Unit shutdown, no damage, no hazards.
U9401 Pin 1	o-c	264	1min	F9901	0.333	Unit operated normally, no damage, no hazards.
U9401 Pin 3	o-c	264	1min	F9901	0.333	Unit operated normally, no damage, no hazards.
U9401 Pin 1-2	s-c	264	1min	F9901	0.379	Unit operated normally, no damage, no hazards.
U9401 Pin 3-4	s-c	264	1min	F9901	0.229	Unit operated normally, no damage, no hazards.
U9103 A-K	s-c	264	1min	F9901	0.075	Unit shutdown, no damage, no hazards.
L9103	s-c	264	1min	F9901	0.075	Unit shutdown, no damage, no hazards.

IEC 60950-1						
Clause	Requirement + Test				Result - Remark	Verdict
R9129	s-c	264	1min	F9901	0.075	Unit shutdown, no damage, no hazards.
D801	s-c	264	1min	F9901	0.117	Unit shutdown, no damage, no hazards.
C9403	s-c	264	1min	F9901	0.078	Unit shutdown, no damage, no hazards.
R9351	s-c	264	1min	F9901	0.365	Unit operated normally, no damage, no hazards.
+19V/19V-Earth	s-c	264	1min	F9901	0.078	Unit shutdown, no damage, no hazards.
<b>Supplementary information:</b>						
<ol style="list-style-type: none"> <li>1. The unit passed 3000V hi-pot test between primary and accessible output connector after single fault test above.</li> <li>2. In fault column, where s-c=short-circuited, o-c=open-circuited, o-l = overload.</li> <li>3. For fuse opened conditions were tested with each source of fuse.</li> <li>4. For component damaged conditions have been repeated twice (three tests total) with same result.</li> <li>5. For heating test mentioned above was tested under HDMI mode.</li> <li>6. All source of each transformer considered with maximum value recorded.</li> <li>7. Temp. limit of transformer according to table C.1 is <math>175^{\circ}\text{C} - 10 - (40^{\circ}\text{C} - T_{amb})</math> (worst case) for Class A.</li> </ol>						



IEC 60950-1							
Clause	Requirement + Test			Result - Remark			Verdict
<b>C.2</b>	<b>TABLE: transformers</b>						<b>P</b>
Loc.	Tested insulation	Working voltage peak / V (2.10.2)	Working voltage rms / V (2.10.2)	Required electric strength (5.2)	Required clearance / mm (2.10.3)	Required creepage distance / mm (2.10.4)	Required distance thr. insul. (2.10.5)
T9102	Input terminal to output winding (RI)	<b>575</b>	<b>330</b>	AC 4000V	6.9	6.9	Min. 2 layers tape
T9102	Input terminal to output terminal (RI)	<b>575</b>	<b>330</b>	AC 4000V	6.9	6.9	Min. 2 layers tape
T9102	Input winding to output winding (RI)	<b>575</b>	<b>330</b>	AC 4000V	6.9	6.9	Min. 2 layers tape
T9102	Input winding to output terminal (RI)	<b>575</b>	<b>330</b>	AC 4000V	6.9	6.9	Min. 2 layers tape
T9102	Output winding to Core (RI)	<b>575</b>	<b>330</b>	AC 4000V	6.9	6.9	Min. 2 layers tape
T9102	Output terminal to Core (RI)	<b>575</b>	<b>330</b>	AC 4000V	6.9	6.9	Min. 2 layers tape
Loc.	Tested insulation			Test voltage/ V	Measured clearance / mm	Measured creepage dist./ mm	Measured distance thr. insul. / mm; number of layers
T9102	Input terminal to output winding (RI)			AC 4000V	Triple insulation wire used on secondary windings	Triple insulation wire used on secondary windings	--
T9102	Input terminal to output terminal (RI)			AC 4000V	54.7	54.7	--
T9102	Input winding to output winding (RI)			AC 4000V	Triple insulation wire used on secondary windings	Triple insulation wire used on secondary windings	--
T9102	Input winding to output terminal (RI)			AC 4000V	8.4	8.4	--

IEC 60950-1					
Clause	Requirement + Test	Result - Remark			Verdict
T9102	Output winding to Core (RI)	AC 4000V	Triple insulation wire used on secondary windings	Triple insulation wire used on secondary windings	--
T9102	Output terminal to Core (RI)	AC 4000V	9.3	9.3	--

**Supplementary information:** All sources of transformer were checked with same construction.

<b>C.2</b>	<b>TABLE: transformers</b>	<b>P</b>
------------	----------------------------	----------

Construction:

### 3. Mechanical Characteristics

#### 3.1 Dimensions

Core fix tape: #25\*24mmW\*2Ts MIN

Dimensions:

- A:  $40.5 \pm 2.0$ mm
- B:  $13.5 \pm 0/-1.5$ mm
- C:  $49.0 \pm 2.0$ mm
- D:  $3.5 \pm 0.3$ mm
- E1:  $5.5 \pm 0.5$ mm
- E2:  $54.7 \pm 0.5$ mm
- d:  $0.8 \times 0.8 \pm 0.1$ mm

NOTE: 1. Lead Wire Composition

- Steel 78%
- Cu 22%
- Sn 99.99% (Thickness  $6 \pm 1 \mu$ )
- Lead Free Solder
- Sn 98% Cu 2%

2. GAP COR TO TOP SIDE

3. PIN9 Cut Off, PIN4 Cut Off 1/2 after soldering

4. CORE 中柱點膠

5. 引脚挂 PIN 圈数  
配线 ALL PIN 1.0T MIN

6. Weight:  $61.5 \pm 2$ g (1PC)

EPOXY(軟膠)

## IEC 60950-1

Clause	Requirement + Test	Result - Remark	Verdict
--------	--------------------	-----------------	---------

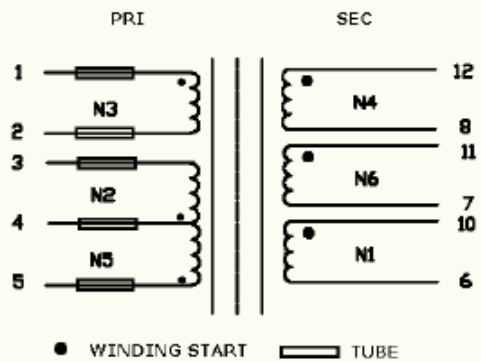

Mylar Tape

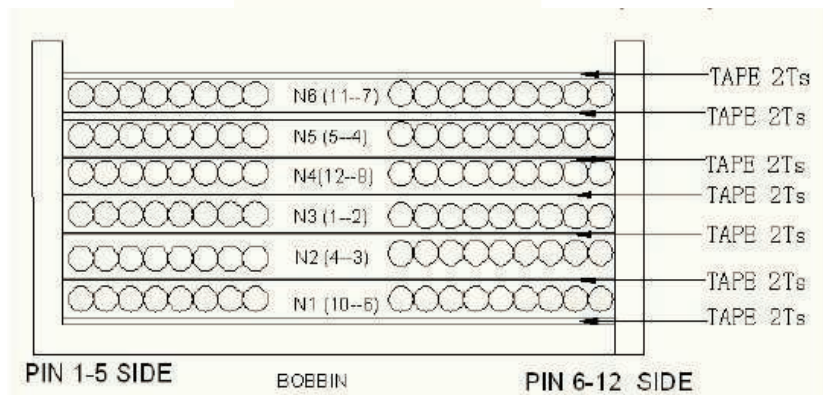

- 1.) PIN 1,2,3,4,5 ADDED TUBE,
- 2.) TUBE over winding 4.0mm min,

## 3.6 Winding mode:

NO.	Winding	Terminal	Wire	Turns	Remark	TAPE
						2Ts
1	N1	10-6	TIW-M $\phi 0.50 \times 2$	5	CLOSED	2Ts
2	N2	4-3	UEW $\phi 0.30$	13	CLOSED	2Ts
3	N3	1-2	UEW $\phi 0.20$	4	CLOSED	2Ts
4	N4	12-8	TIW-M $\phi 0.50 \times 2$	5	CLOSED	2Ts
5	N5	5-4	UEW $\phi 0.30$	13	CLOSED	2Ts
6	N6	11-7	TIW-M $\phi 0.50 \times 2$	5	CLOSED	2Ts

Concentric windings on bobbin (horizontal type core). Two layers of insulation tape around the outer winding and the outer winding is secondary. Triple insulated wire used for secondary. The core is considered as primary part.

IEC60950_1F - ATTACHMENT			
Clause	Requirement + Test	Result - Remark	Verdict

<b>ATTACHMENT TO TEST REPORT IEC 60950-1</b> <b>EUROPEAN GROUP DIFFERENCES AND NATIONAL DIFFERENCES</b> Information technology equipment – Safety – Part 1: General requirements	
<b>Differences according to</b> .....	EN 60950-1:2006/A11:2009/A1:2010/A12:2011/A2:2013
<b>Attachment Form No.</b> .....	EU_GD_IEC60950_1F
<b>Attachment Originator</b> .....	SGS Fimko Ltd
<b>Master Attachment</b> .....	Date 2014-02
<b>Copyright © 2014 IEC System for Conformity Testing and Certification of Electrical Equipment (IECEE), Geneva, Switzerland. All rights reserved.</b>	

<b>EN 60950-1:2006/A11:2009/A1:2010/A12:2011/A2:2013 – CENELEC COMMON MODIFICATIONS</b>
---

IEC 60950-1, GROUP DIFFERENCES (CENELEC common modifications EN)		
	Clauses, subclauses, notes, tables and figures which are additional to those in IEC60950-1 and it's amendmets are prefixed "Z"	P
Contents	Add the following annexes: Annex ZA (normative) Normative references to international publications with their corresponding European publications Annex ZB (normative) Special national conditions Annex ZD (informative) IEC and CENELEC code designations for flexible cords	P
(A2:2013)		
General	Delete all the "country" notes in the reference document (IEC 60950-1:2005) according to the following list: 1.4.8 Note 2      1.5.1 Note 2 & 3      1.5.7.1 Note 1.5.8 Note 2      1.5.9.4 Note      1.7.2.1 Note 4, 5 & 6 2.2.3 Note      2.2.4 Note      2.3.2 Note 2.3.2.1 Note 2      2.3.4 Note 2      2.6.3.3 Note 2 & 3 2.7.1 Note      2.10.3.2 Note 2      2.10.5.13 Note 3 3.2.1.1 Note      3.2.4 Note 3.      2.5.1 Note 2 4.3.6 Note 1 & 2      4.7 Note 4      4.7.2.2 Note 4.7.3.1 Note 2      5.1.7.1 Note 3 & 4      5.3.7 Note 1 6 Note 2 & 5      6.1.2.1 Note 2      6.1.2.2 Note 6.2.2 Note      6.2.2.1 Note 2      6.2.2.2 Note 7.1 Note 3      7.2 Note      7.3 Note 1 & 2 G.2.1 Note 2      Annex H Note 2	P
General	Delete all the "country" notes in the reference document (IEC 60950-1:2005/A1:2010) according to the following list: 1.5.7.1 Note      6.1.2.1 Note 2	P
(A1:2010)		

IEC60950_1F - ATTACHMENT			
Clause	Requirement + Test	Result - Remark	Verdict
<b>IEC 60950-1, GROUP DIFFERENCES (CENELEC common modifications EN)</b>			
	6.2.2.1 Note 2 EE.3 Note		
General (A2:2013)	Delete all the "country" notes in the reference document (IEC 60950-1:2005/A2:2013) according to the following list: 2.7.1 Note * 2.10.3.1 Note 2 6.2.2. Note * Note of secretary: Text of Common Modification remains unchanged.		P
1.1.1 (A1:2010)	<b>Replace</b> the text of NOTE 3 by the following. NOTE 3 The requirements of EN 60065 may also be used to meet safety requirements for multimedia equipment. See IEC Guide 112, Guide on the safety of multimedia equipment. For television sets EN 60065 applies.		N/A
1.3.Z1	Add the following subclause: 1.3.Z1 Exposure to excessive sound pressure The apparatus shall be so designed and constructed as to present no danger when used for its intended purpose, either in normal operating conditions or under fault conditions, particularly providing protection against exposure to excessive sound pressures from headphones or earphones. NOTE Z1 A new method of measurement is described in EN 50332-1, Sound system equipment: Headphones and earphones associated with portable audio equipment - Maximum sound pressure level measurement methodology and limit considerations - Part 1: General method for "one package equipment", and in EN 50332-2, Sound system equipment: Headphones and earphones associated with portable audio equipment - Maximum sound pressure level measurement methodology and limit considerations - Part 2: Guidelines to associate sets with headphones coming from different manufacturers.	Added.	N/A
(A12:2011)	In EN 60950-1:2006/A12:2011 Delete the addition of 1.3.Z1 / EN 60950-1:2006 Delete the definition 1.2.3.Z1 / EN 60950-1:2006 /A1:2010	Deleted.	N/A
1.5.1  (Added info*)	Add the following NOTE: NOTE Z1 The use of certain substances in electrical and electronic equipment is restricted within the EU: see Directive 2002/95/EC. New Directive 2011/65/11 *	Added.	P
1.7.2.1 (A1:2010)	In addition, for a PORTABLE SOUND SYSTEM, the instructions shall include a warning that excessive sound pressure from earphones and headphones can cause hearing loss.	Added.	N/A
1.7.2.1	In EN 60950-1:2006/A12:2011	Not portable Sound System.	N/A

IEC60950_1F - ATTACHMENT			
Clause	Requirement + Test	Result - Remark	Verdict
<b>IEC 60950-1, GROUP DIFFERENCES (CENELEC common modifications EN)</b>			
(A12.2011)	Delete NOTE Z1 and the addition for Portable Sound System. Add the following clause and annex to the existing standard and amendments.		
	<b>Zx Protection against excessive sound pressure from personal music players</b>		N/A
	<p><b>Zx.1 General</b> This sub-clause specifies requirements for protection against excessive sound pressure from personal music players that are closely coupled to the ear. It also specifies requirements for earphones and headphones intended for use with personal music players.</p> <p>A personal music player is a portable equipment□ for personal use, that:</p> <ul style="list-style-type: none"> <li>– is designed to allow the user to listen to recorded or broadcast sound or video; and</li> <li>– primarily uses headphones or earphones that can be worn in or on or around the ears; and</li> <li>– allows the user to walk around while in use.</li> </ul> <p>NOTE 1 Examples are hand-held or body-worn portable CD players, MP3 audio players, mobile phones with MP3 type features, PDA's or similar equipment.</p> <p>A personal music player and earphones or headphones intended to be used with personal music players shall comply with the requirements of this sub-clause.</p> <p>The requirements in this sub-clause are valid for music or video mode only.</p> <p>The requirements do not apply:</p> <ul style="list-style-type: none"> <li>– while the personal music player is connected to an external amplifier; or</li> <li>– while the headphones or earphones are not used.</li> </ul> <p>NOTE 2 An external amplifier is an amplifier which is not part of the personal music player or the listening device, but which is intended to play the music as a standalone music player.</p> <p>The requirements do not apply to:</p> <ul style="list-style-type: none"> <li>– hearing aid equipment and professional</li> </ul>	Not portable Sound System.	N/A

IEC60950_1F - ATTACHMENT			
Clause	Requirement + Test	Result - Remark	Verdict
<b>IEC 60950-1, GROUP DIFFERENCES (CENELEC common modifications EN)</b>			
	<p>equipment;</p> <p>NOTE 3 Professional equipment is equipment sold through special sales channels. All products sold through normal electronics stores are considered not to be professional equipment.</p>		
	<p>– analogue personal music players (personal music players without any kind of digital processing of the sound signal) that are brought to the market before the end of 2015.</p> <p>NOTE 4 This exemption has been allowed because this technology is falling out of use and it is expected that within a few years it will no longer exist. This exemption will not be extended to other technologies.</p> <p>For equipment which is clearly designed or intended for use by young children, the limits of EN 71-1 apply.</p>		N/A
	<p><b>Zx.2 Equipment requirements</b></p> <p>No safety provision is required for equipment that complies with the following:</p> <ul style="list-style-type: none"> <li>– equipment provided as a package (personal music player with its listening device), where the acoustic output <math>L_{Aeq,T}</math> is <math>\leq 85</math> dBA measured while playing the fixed “programme simulation noise” as described in EN 50332-1; and</li> <li>– a personal music player provided with an analogue electrical output socket for a listening device, where the electrical output is <math>\leq 27</math> mV measured as described in EN 50332-2, while playing the fixed “programme simulation noise” as described in EN 50332-1.</li> </ul> <p>NOTE 1 Wherever the term acoustic output is used in this clause, the 30 s A-weighted equivalent sound pressure level <math>L_{Aeq,T}</math> is meant. See also Zx.5 and Annex Zx.</p> <p>All other equipment shall:</p> <ul style="list-style-type: none"> <li>a) protect the user from unintentional acoustic outputs exceeding those mentioned above; and</li> <li>b) have a standard acoustic output level not exceeding those mentioned above, and automatically return to an output level not exceeding those mentioned above when the power is switched off; and</li> </ul>	Not portable Sound System.	N/A

IEC60950_1F - ATTACHMENT			
Clause	Requirement + Test	Result - Remark	Verdict
<b>IEC 60950-1, GROUP DIFFERENCES (CENELEC common modifications EN)</b>			
	<p>c) provide a means to actively inform the user of the increased sound pressure when the equipment is operated with an acoustic output exceeding those mentioned above. Any means used shall be acknowledged by the user before activating a mode of operation which allows for an acoustic output exceeding those mentioned above. The acknowledgement does not need to be repeated more than once every 20 h of cumulative listening time; and</p> <p>NOTE 2 Examples of means include visual or audible signals. Action from the user is always required.</p> <p>NOTE 3 The 20 h listening time is the accumulative listening time, independent how often and how long the personal music player has been switched off.</p> <p>d) have a warning as specified in Zx.3; and</p> <p>e) not exceed the following:</p> <p>1) equipment provided as a package (player with its listening device), the acoustic output shall be <math>\leq 100</math> dBA measured while playing the fixed "programme simulation noise" described in EN 50332-1; and</p> <p>2) a personal music player provided with an analogue electrical output socket for a listening device, the electrical output shall be <math>\leq 150</math> mV measured as described in EN 50332-2, while playing the fixed "programme simulation noise" described in EN 50332-1.</p> <p>For music where the average sound pressure (long term <math>L_{Aeq,T}</math>) measured over the duration of the song is lower than the average produced by the programme simulation noise, the warning does not need to be given as long as the average sound pressure of the song is below the basic limit of 85 dBA. In this case T becomes the duration of the song.</p> <p>NOTE 4 Classical music typically has an average sound pressure (long term <math>L_{Aeq,T}</math>) which is much lower than the average programme simulation noise. Therefore, if the player is capable to analyse the song and compare it with the programme simulation noise, the warning does not need to be given as long as the average sound pressure of the song is below the basic limit of 85 dBA.</p> <p>For example, if the player is set with the programme simulation noise to 85 dBA, but the average music level of the song is only 65 dBA, there is no need to give a warning or ask an acknowledgement as long as the average sound level of the song is not above the basic limit of 85 dBA.</p>		N/A



IEC60950_1F - ATTACHMENT			
Clause	Requirement + Test	Result - Remark	Verdict
<b>IEC 60950-1, GROUP DIFFERENCES (CENELEC common modifications EN)</b>			
	<p><b>Zx.3 Warning</b></p> <p>The warning shall be placed on the equipment, or on the packaging, or in the instruction manual and shall consist of the following:</p> <ul style="list-style-type: none"> <li>– the symbol of Figure 1 with a minimum height of 5 mm; and</li> <li>– the following wording, or similar:</li> </ul> <p>“To prevent possible hearing damage, do not listen at high volume levels for long periods.”</p> <div style="text-align: center;">  </div> <p><b>Figure 1 – Warning label (IEC 60417-6044)</b></p> <p>Alternatively, the entire warning may be given through the equipment display during use, when the user is asked to acknowledge activation of the higher level.</p>	Not portable Sound System.	N/A
	<b>Zx.4 Requirements for listening devices (headphones and earphones)</b>		N/A
	<p><b>Zx.4.1 Wired listening devices with analogue input</b></p> <p>With 94 dBA sound pressure output <math>L_{Aeq,T}</math>, the input voltage of the fixed “programme simulation noise” described in EN 50332-2 shall be <math>\geq 75</math> mV.</p> <p>This requirement is applicable in any mode where the headphones can operate (active or passive), including any available setting (for example built-in volume level control).</p> <p>NOTE The values of 94 dBA – 75 mV correspond with 85dBA – 27 mV and 100 dBA – 150 mV.</p>	No listening devices.	N/A
	<p><b>Zx.4.2 Wired listening devices with digital input</b></p> <p>With any playing device playing the fixed “programme simulation noise” described in EN</p>	No listening devices.	N/A

IEC60950_1F - ATTACHMENT			
Clause	Requirement + Test	Result - Remark	Verdict
<b>IEC 60950-1, GROUP DIFFERENCES (CENELEC common modifications EN)</b>			
	<p>50332-1 (and respecting the digital interface standards, where a digital interface standard exists that specifies the equivalent acoustic level), the acoustic output <math>L_{Aeq,T}</math> of the listening device shall be <math>\leq 100</math> dBA.</p> <p>This requirement is applicable in any mode where the headphones can operate, including any available setting (for example built-in volume level control, additional sound feature like equalization, etc.).</p> <p>NOTE An example of a wired listening device with digital input is a USB headphone.</p>		
	<p><b>Zx.4.3 Wireless listening devices</b></p> <p>In wireless mode:</p> <ul style="list-style-type: none"> <li>– with any playing and transmitting device playing the fixed programme simulation noise described in EN 50332-1; and</li> <li>– respecting the wireless transmission standards, where an air interface standard exists that specifies the equivalent acoustic level; and</li> <li>– with volume and sound settings in the listening device (for example built-in volume level control, additional sound feature like equalization, etc.) set to the combination of positions that maximize the measured acoustic output for the abovementioned programme simulation noise, the acoustic output <math>L_{Aeq,T}</math> of the listening device shall be <math>\leq 100</math> dBA.</li> </ul> <p>NOTE An example of a wireless listening device is a Bluetooth headphone.</p>	No listening devices.	N/A
	<p><b>Zx.5 Measurement methods</b></p> <p>Measurements shall be made in accordance with EN 50332-1 or EN 50332-2 as applicable. Unless stated otherwise, the time interval T shall be 30 s.</p> <p>NOTE Test method for wireless equipment provided without listening device should be defined.</p>	No listening devices.	N/A
2.7.1	<p>Replace the subclause as follows:</p> <p>Basic requirements</p> <p>To protect against excessive current, short-circuits and earth faults in PRIMARY CIRCUITS, protective devices shall be included either as integral parts of</p>	Replaced.	P

IEC60950_1F - ATTACHMENT									
Clause	Requirement + Test	Result - Remark	Verdict						
<b>IEC 60950-1, GROUP DIFFERENCES (CENELEC common modifications EN)</b>									
	<p>the equipment or as parts of the building installation, subject to the following, a), b) and c):</p> <p>a) except as detailed in b) and c), protective devices necessary to comply with the requirements of 5.3 shall be included as parts of the equipment;</p> <p>b) for components in series with the mains input to the equipment such as the supply cord, appliance coupler, r.f.i. filter and switch, short-circuit and earth fault protection may be provided by protective devices in the building installation;</p>								
	<p>c) it is permitted for PLUGGABLE EQUIPMENT TYPE B or PERMANENTLY CONNECTED EQUIPMENT, to rely on dedicated overcurrent and short-circuit protection in the building installation, provided that the means of protection, e.g. fuses or circuit breakers, is fully specified in the installation instructions.</p> <p>If reliance is placed on protection in the building installation, the installation instructions shall so state, except that for PLUGGABLE EQUIPMENT TYPE A the building installation shall be regarded as providing protection in accordance with the rating of the wall socket outlet.</p>	No PLUGGABLE EQUIPMENT TYPE B or PERMANENTLY CONNECTED EQUIPMENT.	N/A						
2.7.2	This subclause has been declared 'void'.	Declared.	N/A						
3.2.3	Delete the NOTE in Table 3A, and delete also in this table the conduit sizes in parentheses.	Deleted.	N/A						
3.2.5.1	<p>Replace "60245 IEC 53" by "H05 RR-F"; "60227 IEC 52" by "H03 VV-F or H03 VVH2-F"; "60227 IEC 53" by "H05 VV-F or H05 VVH2-F2".</p> <p>In Table 3B, replace the first four lines by the following:</p> <table style="margin-left: 40px;"> <tr> <td>Up to and including 6  </td> <td>0,75<sup>a)</sup>  </td> </tr> <tr> <td>Over 6 up to and including 10  </td> <td>(0,75)<sup>b)</sup> 1,0  </td> </tr> <tr> <td>Over 10 up to and including 16  </td> <td>(1,0)<sup>c)</sup> 1,5  </td> </tr> </table> <p>In the conditions applicable to Table 3B delete the words "in some countries" in condition<sup>a)</sup>.</p> <p>In NOTE 1, applicable to Table 3B, delete the second sentence.</p>	Up to and including 6	0,75 <sup>a)</sup>	Over 6 up to and including 10	(0,75) <sup>b)</sup> 1,0	Over 10 up to and including 16	(1,0) <sup>c)</sup> 1,5	No power cord provided.	N/A
Up to and including 6	0,75 <sup>a)</sup>								
Over 6 up to and including 10	(0,75) <sup>b)</sup> 1,0								
Over 10 up to and including 16	(1,0) <sup>c)</sup> 1,5								
3.2.5.1 (A2:2013)	NOTE Z1 The harmonised code designations corresponding to the IEC cord types are given in Annex ZD		N/A						
3.3.4	In Table 3D, delete the fourth line: conductor sizes for 10 to 13 A, and replace with the following:		N/A						

Disclaimer: This document is controlled and has been released electronically.  
Only the version on the IECEE Website is the current document version

IEC60950_1F - ATTACHMENT			
Clause	Requirement + Test	Result - Remark	Verdict

IEC 60950-1, GROUP DIFFERENCES (CENELEC common modifications EN)			
	Over 10 up to and including 16   1,5 to 2,5   1,5 to 4 Delete the fifth line: conductor sizes for 13 to 16 A		
4.3.13.6 (A1:2010)	Replace the existing NOTE by the following: NOTE Z1 Attention is drawn to: 1999/519/EC: Council Recommendation on the limitation of exposure of the general public to electromagnetic fields 0 Hz to 300 GHz, and 2006/25/EC: Directive on the minimum health and safety requirements regarding the exposure of workers to risks arising from physical agents (artificial optical radiation).	Replaced.	N/A
	Standards taking into account mentioned Recommendation and Directive which demonstrate compliance with the applicable EU Directive are indicated in the OJEC.	Replaced.	N/A
Annex H	Replace the last paragraph of this annex by: At any point 10 cm from the surface of the OPERATOR ACCESS AREA, the dose rate shall not exceed 1 µSv/h (0,1 mR/h) (see NOTE). Account is taken of the background level. Replace the notes as follows: NOTE These values appear in Directive 96/29/Euratom. Delete NOTE 2.	No X-ray radiation.	N/A
Bibliography	Additional EN standards.		—

<b>ZA</b>	<b>NORMATIVE REFERENCES TO INTERNATIONAL PUBLICATIONS WITH THEIR CORRESPONDING EUROPEAN PUBLICATIONS</b>	—
-----------	--	---

ZB ANNEX (normative) SPECIAL NATIONAL CONDITIONS (EN)			
1.2.4.1	In <b>Denmark</b> , certain types of Class I appliances (see 3.2.1.1) may be provided with a plug not establishing earthing conditions when inserted into Danish socket-outlets.	Equipment is for building-in and shall be evaluated in end product.	N/A
1.2.13.14 (A11:2009)	In <b>Norway</b> and <b>Sweden</b> , for requirements see 1.7.2.1 and 7.3 of this annex.	No cable distribution systems.	N/A
1.5.7.1 (A11:2009)	In <b>Finland</b> , <b>Norway</b> and <b>Sweden</b> , resistors bridging BASIC INSULATION in CLASS I PLUGGABLE EQUIPMENT TYPE A must comply with the requirements in 1.5.7.1. In addition when a single resistor is used, the resistor must withstand the	No such resistors.	N/A

Disclaimer: This document is controlled and has been released electronically.  
Only the version on the IECEE Website is the current document version

IEC60950_1F - ATTACHMENT			
Clause	Requirement + Test	Result - Remark	Verdict
	resistor test in 1.5.7.2.		
1.5.8	In <b>Norway</b> , due to the IT power system used (see annex V, Figure V.7), capacitors are required to be rated for the applicable line-to-line voltage (230 V).		P
1.5.9.4	In <b>Finland, Norway and Sweden</b> , the third dashed sentence is applicable only to equipment as defined in 6.1.2.2 of this annex.	No TNV circuits.	N/A
1.7.2.1	In <b>Finland, Norway and Sweden</b> , CLASS I PLUGGABLE EQUIPMENT TYPE A intended for connection to other equipment or a network shall, if safety relies on connection to protective earth or if surge suppressors are connected between the network terminals and accessible parts, have a marking stating that the equipment must be connected to an earthed mains socket-outlet. The marking text in the applicable countries shall be as follows: In <b>Finland</b> : "Laite on liitettävä suojakoskettimilla varustettuun pistorasiaan" In <b>Norway</b> : "Apparatet må tilkoples jordet stikkontakt" In <b>Sweden</b> : "Apparaten skall anslutas till jordat uttag"	Class II equipment.	N/A
1.7.2.1 (A11:2009)	In <b>Norway and Sweden</b> , the screen of the cable distribution system is normally not earthed at the entrance of the building and there is normally no equipotential bonding system within the building. Therefore the protective earthing of the building installation need to be isolated from the screen of a cable distribution system. It is however accepted to provide the insulation external to the equipment by an adapter or an interconnection cable with galvanic isolator, which may be provided by e.g. a retailer. The user manual shall then have the following or similar information in Norwegian and Swedish language respectively, depending on in what country the equipment is intended to be used in: "Equipment connected to the protective earthing of the building installation through the mains connection or through other equipment with a connection to protective earthing – and to a cable distribution system using coaxial cable, may in some circumstances create a fire hazard. Connection to a cable distribution system has		

IEC60950_1F - ATTACHMENT			
Clause	Requirement + Test	Result - Remark	Verdict
	therefore to be provided through a device providing electrical isolation below a certain frequency range (galvanic isolator, see EN 60728-11)."		
	<p>NOTE In Norway, due to regulation for installations of cable distribution systems, and in Sweden, a galvanic isolator shall provide electrical insulation below 5 MHz. The insulation shall withstand a dielectric strength of 1,5 kV r.m.s., 50 Hz or 60 Hz, for 1 min.</p> <p>Translation to Norwegian (the Swedish text will also be accepted in Norway): "Utstyr som er koplet til beskyttelsesjord via nettplugg og/eller via annet jordtilkoplede utstyr – og er tilkoplede et kabel-TV nett, kan forårsake brannfare. For å unngå dette skal det ved tilkopling av utstyret til kabel-TV nettet installeres en galvanisk isolator mellom utstyret og kabel-TV nettet."</p> <p>Translation to Swedish: "Utrustning som är kopplad till skyddsjord via jordat vägguttag och/eller via annan utrustning och samtidigt är kopplad till kabel-TV nät kan i vissa fall medföra risk för brand. För att undvika detta skall vid anslutning av utrustningen till kabel-TV nät galvanisk isolator finnas mellan utrustningen och kabel-TV nätet."</p>		N/A
1.7.2.1 (A2:2013)	<p>In <b>Denmark</b>, CLASS I PLUGGABLE EQUIPMENT TYPE A intended for connection to other equipment or a network shall, if safety relies on connection to protective earth or if surge suppressors are connected between the network terminals and accessible parts, have a marking stating that the equipment must be connected to an earthed mains socket-outlet.</p> <p>The marking text in <b>Denmark</b> shall be as follows: In <b>Denmark</b>: "Apparatets stikprop skal tilsluttes en stikkontakt med jord, som giver forbindelse til stikproppens jord."</p>	Class II equipment.	N/A
1.7.5	<p>In <b>Denmark</b>, socket-outlets for providing power to other equipment shall be in accordance with the Heavy Current Regulations, Section 107-2-D1, Standard Sheet DK 1-3a, DK 1-5a or DK 1-7a, when used on Class I equipment. For STATIONARY EQUIPMENT the socket-outlet shall be in accordance with Standard Sheet DK 1-1b or</p>	No socket-outlet provided.	N/A

IEC60950_1F - ATTACHMENT			
Clause	Requirement + Test	Result - Remark	Verdict
1.7.5 (A11:2009)	DK 1-5a. For <b>CLASS II EQUIPMENT</b> the socket outlet shall be in accordance with Standard Sheet DKA 1-4a.		
1.7.5 (A2:2013)	In <b>Denmark</b> , socket-outlets for providing power to other equipment shall be in accordance with the DS 60884-2-D1:2011.  For class I equipment the following Standard Sheets are applicable: DK 1-3a, DK 1-1c, DK 1-1d, DK 1-5a or DK 1-7a, with the exception for STATIONARY EQUIPMENT where the socket-outlets shall be in accordance with Standard Sheet DK 1-1b, DK 1-1c, DK 1-1d or DK 1-5a.  Socket outlets intended for providing power to Class II apparatus with a rated current of 2,5 A shall be in accordance with DS 60884-2-D1 standard sheet DKA 1-4a. Other current rating socket outlets shall be in compliance with by DS 60884-2-D1 Standard Sheet DKA 1-3a or DKA 1-3b.  Justification the Heavy Current Regulations, 6c	No socket-outlet provided.	N/A
2.2.4	In <b>Norway</b> , for requirements see 1.7.2.1, 6.1.2.1 and 6.1.2.2 of this annex.	No TNV circuits.	N/A
2.3.2	In <b>Finland, Norway and Sweden</b> there are additional requirements for the insulation. See 6.1.2.1 and 6.1.2.2 of this annex.	No TNV circuits.	N/A
2.3.4	In <b>Norway</b> , for requirements see 1.7.2.1, 6.1.2.1 and 6.1.2.2 of this annex.	No TNV circuits.	N/A
2.6.3.3	In the <b>United Kingdom</b> , the current rating of the circuit shall be taken as 13 A, not 16 A.		P
2.7.1	In the <b>United Kingdom</b> , to protect against excessive currents and short-circuits in the PRIMARY CIRCUIT of DIRECT PLUG-IN EQUIPMENT, tests according to 5.3 shall be conducted, using an external protective device rated 30 A or 32 A. If these tests fail, suitable protective devices shall be included as integral parts of the DIRECT PLUG-IN EQUIPMENT, so that the requirements of 5.3 are met.	Not direct plug-in equipment.	N/A
2.10.5.13	In <b>Finland, Norway and Sweden</b> , there are additional requirements for the insulation, see 6.1.2.1 and 6.1.2.2 of this annex.	No TNV circuits.	N/A
3.2.1.1	In <b>Switzerland</b> , supply cords of equipment having a RATED CURRENT not exceeding 10 A shall be	No power cord provided.	N/A

IEC60950_1F - ATTACHMENT			
Clause	Requirement + Test	Result - Remark	Verdict
	<p>provided with a plug complying with SEV 1011 or IEC 60884-1 and one of the following dimension sheets:</p> <p>SEV 6532-2.1991 Plug Type 15 3P+N+PE 250/400 V, 10 A</p> <p>SEV 6533-2.1991 Plug Type 11 L+N 250 V, 10 A</p> <p>SEV 6534-2.1991 Plug Type 12 L+N+PE 250 V, 10 A</p> <p>In general, EN 60309 applies for plugs for currents exceeding 10 A. However, a 16 A plug and socket-outlet system is being introduced in Switzerland, the plugs of which are according to the following dimension sheets, published in February 1998:</p> <p>SEV 5932-2.1998: Plug Type 25 , 3L+N+PE 230/400 V, 16 A</p> <p>SEV 5933-2.1998: Plug Type 21, L+N, 250 V, 16A</p> <p>SEV 5934-2.1998: Plug Type 23, L+N+PE 250 V, 16 A</p>		
3.2.1.1	<p>In <b>Denmark</b>, supply cords of single-phase equipment having a rated current not exceeding 13 A shall be provided with a plug according to the Heavy Current Regulations, Section 107-2-D1.</p> <p>CLASS I EQUIPMENT provided with socket-outlets with earth contacts or which are intended to be used in locations where protection against indirect contact is required according to the wiring rules shall be provided with a plug in accordance with standard sheet DK 2-1a or DK 2-5a.</p> <p>If poly-phase equipment and single-phase equipment having a RATED CURRENT exceeding 13 A is provided with a supply cord with a plug, this plug shall be in accordance with the Heavy Current Regulations, Section 107-2-D1 or EN 60309-2.</p>	No power cord provided.	N/A
3.2.1.1 (A2:2013)	<p>In <b>Denmark</b>, supply cords of single-phase equipment having a rated current not exceeding 13 A shall be provided with a plug according to DS 60884-2-D1.</p> <p>CLASS I EQUIPMENT provided with socket-outlets with earth contacts or which are intended to be used in locations where protection against indirect contact is required according to the wiring rules shall be provided with a plug in accordance with standard sheet DK 2-1a or DK 2-5a.</p>	No power cord provided.	N/A



IEC60950_1F - ATTACHMENT			
Clause	Requirement + Test	Result - Remark	Verdict
	<p>If a single-phase equipment having a RATED CURRENT exceeding 13 A or if a poly-phase equipment is provided with a supply cord with a plug, this plug shall be in accordance with the standard sheets DK 6-1a in DS 60884-2-D1 or EN 60309-2.</p> <p>Justification the Heavy Current Regulations, 6c</p>		
3.2.1.1	<p>In <b>Spain</b>, supply cords of single-phase equipment having a rated current not exceeding 10 A shall be provided with a plug according to UNE 20315:1994.</p> <p>Supply cords of single-phase equipment having a rated current not exceeding 2,5 A shall be provided with a plug according to UNE-EN 50075:1993.</p> <p>CLASS I EQUIPMENT provided with socket-outlets with earth contacts or which are intended to be used in locations where protection against indirect contact is required according to the wiring rules, shall be provided with a plug in accordance with standard UNE 20315:1994.</p> <p>If poly-phase equipment is provided with a supply cord with a plug, this plug shall be in accordance with UNE-EN 60309-2.</p>	No power cord provided.	N/A
3.2.1.1	<p>In the <b>United Kingdom</b>, apparatus which is fitted with a flexible cable or cord and is designed to be connected to a mains socket conforming to BS 1363 by means of that flexible cable or cord and plug, shall be fitted with a 'standard plug' in accordance with Statutory Instrument 1768:1994 - The Plugs and Sockets etc. (Safety) Regulations 1994, unless exempted by those regulations.</p> <p>NOTE 'Standard plug' is defined in SI 1768:1994 and essentially means an approved plug conforming to BS 1363 or an approved conversion plug.</p>	No power cord provided.	N/A
3.2.1.1	<p>In <b>Ireland</b>, apparatus which is fitted with a flexible cable or cord and is designed to be connected to a mains socket conforming to I.S. 411 by means of that flexible cable or cord and plug, shall be fitted with a 13 A plug in accordance with Statutory Instrument 525:1997 - National Standards Authority of Ireland (section 28) (13 A Plugs and Conversion Adaptors for Domestic Use) Regulations 1997.</p>	No power cord provided.	N/A
3.2.4	<p>In <b>Switzerland</b>, for requirements see 3.2.1.1 of this annex.</p>	No power cord provided.	N/A

IEC60950_1F - ATTACHMENT			
Clause	Requirement + Test	Result - Remark	Verdict
3.2.5.1	In the <b>United Kingdom</b> , a power supply cord with conductor of 1,25 mm <sup>2</sup> is allowed for equipment with a rated current over 10 A and up to and including 13 A.	No power cord provided.	N/A
3.3.4	In the <b>United Kingdom</b> , the range of conductor sizes of flexible cords to be accepted by terminals for equipment with a RATED CURRENT of over 10 A up to and including 13 A is: • 1,25 mm <sup>2</sup> to 1,5 mm <sup>2</sup> nominal cross-sectional area.	No power cord provided.	N/A
4.3.6	In the <b>United Kingdom</b> , the torque test is performed using a socket outlet complying with BS 1363 part 1:1995, including Amendment 1:1997 and Amendment 2:2003 and the plug part of DIRECT PLUG-IN EQUIPMENT shall be assessed to BS 1363: Part 1, 12.1, 12.2, 12.3, 12.9, 12.11, 12.12, 12.13, 12.16 and 12.17, except that the test of 12.17 is performed at not less than 125 °C. Where the metal earth pin is replaced by an Insulated Shutter Opening Device (ISOD), the requirements of clauses 22.2 and 23 also apply. <b>UK Application Note:</b> BS 1363-1:1995+A4:2012 has now superseded the previous version (incorporating Amendments 1:1997, 2:2003 and 3:2007) which has been withdrawn. Our recommendation is for users to always identify and follow the latest version of a standard to which a dated reference is made. This is also applicable in the case of BS EN 60950-1 and users would need to refer to the latest version of BS 1363-1:1995+A4:2012 when applying BS EN 60950-1.	Not direct plug-in equipment	N/A
4.3.6	In <b>Ireland</b> , DIRECT PLUG-IN EQUIPMENT is known as plug similar devices. Such devices shall comply with Statutory Instrument 526:1997 - National Standards Authority of Ireland (Section 28) (Electrical plugs, plug similar devices and sockets for domestic use) Regulations, 1997.	Not direct plug-in equipment	N/A
5.1.7.1	In <b>Finland, Norway and Sweden</b> TOUCH CURRENT measurement results exceeding 3,5 mA r.m.s. are permitted only for the following equipment: • STATIONARY PLUGGABLE EQUIPMENT TYPE A that is intended to be used in a RESTRICTED ACCESS LOCATION where equipotential bonding has been applied, for example, in a telecommunication centre; and	Measured touch current not exceeding 3,5 mA r.m.s.	N/A

IEC60950_1F - ATTACHMENT			
Clause	Requirement + Test	Result - Remark	Verdict
	<p>has provision for a permanently connected PROTECTIVE EARTHING CONDUCTOR; and is provided with instructions for the installation of that conductor by a SERVICE PERSON;</p> <ul style="list-style-type: none"> <li>• STATIONARY PLUGGABLE EQUIPMENT TYPE B;</li> <li>• STATIONARY PERMANENTLY CONNECTED EQUIPMENT.</li> </ul>		
6.1.2.1 (A1:2010)	<p>In <b>Finland, Norway and Sweden</b>, add the following text between the first and second paragraph of the compliance clause: If this insulation is solid, including insulation forming part of a component, it shall at least consist of either</p> <ul style="list-style-type: none"> <li>- two layers of thin sheet material, each of which shall pass the electric strength test below, or</li> <li>- one layer having a distance through insulation of at least 0,4 mm, which shall pass the electric strength test below.</li> </ul> <p>Alternatively for components, there is no distance through insulation requirements for the insulation consisting of an insulating compound completely filling the casing, so that CLEARANCES and CREEPAGE DISTANCES do not exist, if the component passes the electric strength test in accordance with the compliance clause below and in addition</p> <ul style="list-style-type: none"> <li>- passes the tests and inspection criteria of 2.10.11 with an electric strength test of 1,5 kV multiplied by 1,6 (the electric strength test of 2.10.10 shall be performed using 1,5 kV), and</li> <li>- is subject to ROUTINE TESTING for electric strength during manufacturing, using a test voltage of 1,5 kV.</li> </ul>	No connection to telecommunication networks.	N/A
	<p>It is permitted to bridge this insulation with an optocoupler complying with 2.10.5.4 b).</p> <p>It is permitted to bridge this insulation with a capacitor complying with EN 60384-14:2005, subclass Y2.</p> <p>A capacitor classified Y3 according to EN 60384-14:2005, may bridge this insulation under the following conditions:</p> <ul style="list-style-type: none"> <li>- the insulation requirements are satisfied by having a capacitor classified Y3 as defined by EN</li> </ul>	No TNV circuits.	N/A

IEC60950_1F - ATTACHMENT			
Clause	Requirement + Test	Result - Remark	Verdict
	60384-14, which in addition to the Y3 testing, is tested with an impulse test of 2,5 kV defined in EN 60950-1:2006, 6.2.2.1; - the additional testing shall be performed on all the test specimens as described in EN 60384-14: - the impulse test of 2,5 kV is to be performed before the endurance test in EN 60384-14, in the sequence of tests as described in EN 60384-14.		
6.1.2.2	In <b>Finland, Norway and Sweden</b> , the exclusions are applicable for PERMANENTLY CONNECTED EQUIPMENT, PLUGGABLE EQUIPMENT TYPE B and equipment intended to be used in a RESTRICTED ACCESS LOCATION where equipotential bonding has been applied, e.g. in a telecommunication centre, and which has provision for a permanently connected PROTECTIVE EARTHING CONDUCTOR and is provided with instructions for the installation of that conductor by a SERVICE PERSON.	No TNV circuits.	N/A
7.2	In <b>Finland, Norway and Sweden</b> , for requirements see 6.1.2.1 and 6.1.2.2 of this annex. The term TELECOMMUNICATION NETWORK in 6.1.2 being replaced by the term CABLE DISTRIBUTION SYSTEM.		N/A
7.3 (A11:2009)	In <b>Norway and Sweden</b> , for requirements see 1.2.13.14 and 1.7.2.1 of this annex.		N/A

Annex ZD (informative) IEC and CENELEC code designations for flexible cords		
Type of flexible cord	Code designations	
	IEC	CENELEC
<b>PVC insulated cords</b>		
Flat twin tinsel cord	60227 IEC 41	H03VH-Y
Light polyvinyl chloride sheathed flexible cord	60227 IEC 52	H03VV-F H03VVH2-F
Ordinary polyvinyl chloride sheathed flexible cord	60277 IEC 53	H05VV-F H05VVH2-F
<b>Rubber insulated cords</b>		
Braided cord	60245 IEC 51	H03RT-F



IEC60950_1F - ATTACHMENT			
Clause	Requirement + Test	Result - Remark	Verdict
	Ordinary tough rubber sheathed flexible cord	60245 IEC 53	H05RR-F
	Ordinary polychloroprene sheathed flexible cord	60245 IEC 57	H05RN-F
	Heavy polychloroprene sheathed flexible cord	60245 IEC 66	H07RN-F
<b>Cords having high flexibility</b>			
	Rubber insulated and sheathed cord	60245 IEC 86	H03RR-H
	Rubber insulated, crosslinked PVC sheathed cord	60245 IEC 87	H03RV4-H
	Crosslinked PVC insulated and sheathed cord	60245 IEC 88	H03V4V4-H



IEC60950_1F - ATTACHMENT			
Clause	Requirement + Test	Result - Remark	Verdict

<b>ATTACHMENT TO TEST REPORT IEC 60950-1</b> <b>CANADA NATIONAL DIFFERENCES</b> Information technology equipment – Safety – Part 1: General requirements	
<b>Differences according to</b> .....:	CAN/CSA-C22.2 No. 60950-1-07, Amd 1:2011, Amd 2:2014
<b>Attachment Form No.</b> .....:	CA_ND_IEC60950_1F
<b>Attachment Originator</b> .....	CSA
<b>Master Attachment</b> .....:	Date (2015-05)
<b>Copyright © 2015 IEC System for Conformity Testing and Certification of Electrical Equipment (IECEE), Geneva, Switzerland. All rights reserved.</b>	

	Special national conditions		P
1.1.1	All equipment is to be designed to allow installation in accordance with the National Electrical Code (NEC), ANSI/NFPA 70, the Canadian Electrical Code (CEC), Part I, CAN/CSA C22.1, and when applicable, the National Electrical Safety Code, IEEE C2. Also, unless marked or otherwise identified, installation is allowed per the Standard for the Protection of Electronic Computer/Data-Processing Equipment, ANSI/NFPA 75.	In accordance with the National Electrical Code (NEC) and the Canadian Electrical Code (CEC) part 1 CAN/CSA C22.1, ANSI/NFPA 70, and unless marked or otherwise identified, the Standard for Electronic Computer/Data-Processing Equipment, ANSI/NFPA 75.	P
1.1.2	Baby monitors are required to additionally comply with ASTM F2951, Consumer Safety Specification for Baby Monitors.		N/A
1.4.14	For Pluggable Equipment Type A, the protection in the installation is assumed to be 20A:	Considered.	P
1.5.5	For lengths exceeding 3.05 m, external interconnecting flexible cord and cable assemblies are required to be a suitable cable type (e.g., DP, CL2) specified in the CEC/NEC.	No external cable provided.	N/A
	For lengths 3.05 m or less, external interconnecting flexible cord and cable assemblies that are not types specified in the CEC/NEC are required to have special construction features and identification markings.		N/A
1.7.1	Equipment for use on a.c. mains supply systems with a neutral and more than one phase conductor (e.g. 120/240 V, 3-wire) require a special marking format for electrical ratings.  A voltage rating that exceeds an attachment plug	Single-phase equipment.	N/A

Disclaimer: This document is controlled and has been released electronically.  
Only the version on the IECEE Website is the current document version

IEC60950_1F - ATTACHMENT			
Clause	Requirement + Test	Result - Remark	Verdict
	cap rating is only permitted if it does not exceed the extreme operating conditions in Table 2 of CAN/CSA C22.2 No. 235, and if it is part of a range that extends into the Table 2 "Normal Operating Conditions." Likewise, a voltage rating shall not be lower than the specified "Normal Operating Conditions," unless it is part of a range that extends into the "Normal Operating Conditions."		
1.7.7	Wiring terminals intended to supply Class 2 outputs in accordance with CEC Part 1 or NEC shall be marked with the voltage rating and "Class 2" or equivalent. Marking shall be located adjacent to the terminals and shall be visible during wiring.	No wiring terminals.	N/A
2.5	Where a fuse is used to provide Class 2, Limited Power Source, or TNV current limiting, it shall not be operator-accessible unless it is not interchangeable.	Not such fuse used.	N/A
2.6	Equipment with isolated ground (earthing) receptacles are required to comply with NEC 250.146(D) and CEC 10-112 and 10-906(8).		N/A
2.7.1	Suitable NEC/CEC branch circuit protection rated at the maximum circuit rating is required for all standard supply outlets and receptacles (such as supplied in power distribution units) if the supply branch circuit protection is not suitable.	No such components provided.	N/A
	Power distribution transformers distributing power at 100 volts or more, and rated 10 kVA or more, require special transformer overcurrent protection.		N/A
3.2	Wiring methods (terminals, leads, etc.) used for the connection of the equipment to the mains shall be in accordance with the NEC/CEC.		N/A
3.2.1	Power supply cords are required to have attachment plugs rated not less than 125 percent of the rated current of the equipment.		N/A
3.2.1.2	Equipment connected to a centralized d.c. power system, and having one pole of the DC mains input terminal connected to the main protective earthing terminal in the equipment, is required to comply with special earthing, wiring, marking and installation instruction requirements.	No power supply cord provided.	N/A
3.2.3	Permanent connection of equipment to the mains supply by a power supply cord is not permitted, except for certain equipment, such as ATMs.	The equipment is not permanently connected equipment.	N/A
3.2.5	Power supply cords are required to be no longer	Pluggable equipment type A.	N/A

Disclaimer: This document is controlled and has been released electronically.  
Only the version on the IECEE Website is the current document version

IEC60950_1F - ATTACHMENT			
Clause	Requirement + Test	Result - Remark	Verdict
	than 4.5 m in length.		
	Minimum cord length is required to be 1.5 m, with certain constructions such as external power supplies allowed to consider both input and output cord lengths into the requirement.		N/A
	Flexible power supply cords are required to be compatible with Article 400 of the NEC, and Tables 11 and 12 of the CEC.		N/A
3.2.9	Permanently connected equipment is required to have a suitable wiring compartment and wire bending space.	Pluggable equipment type A.	N/A
3.3	Wiring terminals and associated spacings for field wiring connections shall comply with CSA C22.2 No. 0	No wiring terminals.	N/A
3.3.3	Wire binding screws are not permitted to attach conductors larger than 10 AWG (5.3 mm2).	No wire binding screws.	N/A
3.3.4	Terminals for permanent wiring, including protective earthing terminals, are required to be suitable for US/Canadian wire gauge sizes, rated 125 percent of the equipment rating, and be specially marked when specified (1.7.7).	Pluggable equipment type A.	N/A
3.3.5	First column of Table 3E revised to require "Smaller of the RATED CURRENT of the equipment or the PROTECTIVE CURRENT RATING of the circuit under consideration."		N/A
3.4.2	Motor control devices are required for cord-connected equipment with a motor if the equipment is rated more than 12 A, or if the motor has a nominal voltage rating greater than 120 V, or is rated more than 1/3 hp (locked rotor current over 43 A).	Equipment is not such a device.	N/A
3.4.8	Vertically-mounted disconnect switches and circuit breakers are required to have the "on" position indicated by the handle in the up position.	No such devices incorporated.	N/A
3.4.11	For computer room applications, equipment with battery systems capable of supplying 750 VA for five minutes are required to have a battery disconnect means that may be connected to the computer room remote power-off circuit.	Not such an application.	N/A
4.3.12	The maximum quantity of flammable liquid stored in equipment is required to comply with NFPA 30.	No flammable liquid.	N/A
4.3.13.5.1	Equipment with lasers is required to meet the U.S. Code of Federal Regulations 21 CFR 1040 (and	No Laser.	N/A



IEC60950_1F - ATTACHMENT			
Clause	Requirement + Test	Result - Remark	Verdict
	the Canadian Radiation Emitting Devices Act, REDR C1370).		
4.7	For computer room applications, automated information storage systems with combustible media greater than 0.76 m <sup>3</sup> (27 cu ft) are required to have a provision for connection of either automatic sprinklers or a gaseous agent extinguishing system with an extended discharge.	No such equipment.	N/A
4.7.3.1	For computer room applications, enclosures with combustible material measuring greater than 0.9 m <sup>2</sup> (10 sq ft) or a single dimension greater than 1.8 m (6 ft) are required to have a flame spread rating of 50 or less. For other applications, enclosures with the same dimensions require a flame spread rating of 200 or less.	No such equipment.	N/A
	Non-metallic enclosures of equipment for use in spaces used for environmental air (plenums) are required to comply with UL 2043.		N/A
Annex H	Equipment that produces ionizing radiation is required to comply with the U.S. Code of Federal Regulations, 21 CFR 1020 (and the Canadian Radiation Emitting Devices Act, REDR C1370).	No ionizing radiation.	N/A
OTHER DIFFERENCES			
The following key national differences are based on requirements other than national regulatory requirements.			
1.5.1	Some components and materials associated with the risk of fire, electric shock, or personal injury are required to have component or material ratings in accordance with the applicable national (Canadian and/or U.S.) component or material standard requirements. These components include: attachment plugs, battery packs (rechargeable type, used with transportable equipment), cathode ray tubes, circuit breakers, communication circuit accessories, connectors (used for current interruption of non-LPS circuits), cord sets and power supply cords, direct plug-in equipment, enclosures (outdoor), flexible cords and cables, fuses (branch circuit), fuseholders, ground-fault current interrupters, industrial control equipment, insulating tape, interconnecting cables, lampholders, limit controls, printed wiring, protectors for communications circuits, receptacles,	Complied. See table 1.5.1	P

IEC60950_1F - ATTACHMENT			
Clause	Requirement + Test	Result - Remark	Verdict
	solid state controls, supplementary protectors, switches (including interlock switches), thermal cutoffs, thermostats, (multi-layer) transformer winding wire, transient voltage surge suppressors, tubing, wire connectors, and wire and cables.		
1.6.1.2	A circuit for connection to the DC Mains Supply is classified as either a SELV Circuit, TNV-2 Circuit or Hazardous Voltage Circuit depending on the maximum operating voltage of the supply. This maximum operating voltage shall include consideration of the battery charging "float voltage" associated with the intended supply system, regardless of the marked power rating of the equipment.	No connection to the DC Mains Supply.	N/A
2.3.1	For TNV-2 and TNV-3 circuits with other than ringing signals and with voltages exceeding 42.4 V <sub>peak</sub> or 60 V <sub>d.c.</sub> , the maximum acceptable current through a 2000 ohm resistor (or greater) connected across the voltage source with other loads disconnected is 7.1 mA peak or 30 mA d.c. under normal operating conditions.	No TNV circuits.	N/A
2.3.2.1	In the event of a single fault between TNV and SELV circuits, the limits of 2.2.3 apply to SELV Circuits and accessible conductive parts.	No TNV circuits.	N/A
2.6.2	Equipment with functional earthing is required to be marked with the functional earthing symbol (IEC 60417-6092).		N/A
2.6.3.4	Protective bonding conductors of non-standard protective bonding constructions (e.g., printed circuit traces) may be subjected to the additional limited short circuit test conditions specified.		N/A
4.2.8.1	Enclosures around CRTs with a face diameter of 160 mm or more are required to reduce the risk of injury due to the implosion of the CRT.	No CRTs.	N/A
4.3.2	Equipment with handles is required to comply with special loading tests.		N/A
4.3.8	Battery packs for both portable and stationary applications are required to comply with special component requirements.		N/A
5.1.8.3	Equipment intended to receive telecommunication ringing signals is required to comply with a special touch current measurement tests.	No TNV circuits within the equipment.	N/A
5.3.7	Internal (e.g., card cage) SELV circuit connectors and printed wiring board connectors that are		P

IEC60950_1F - ATTACHMENT			
Clause	Requirement + Test	Result - Remark	Verdict
	accessible to the operator and that deliver power are to be overloaded.		
	During abnormal operating testing, if a circuit is interrupted by the opening of a component, the test shall be repeated twice (three tests total) using new components as necessary.		P
6.4	Equipment intended for connection to telecommunication network outside plant cable is required to be protected against overvoltage from power line crosses in accordance with 6.4 and Annex NAC.	No TNV circuits within the equipment.	N/A
Annex EE	UL articulated accessibility probe (Fig EE.3) required for assessing accessibility to document/media shredders instead of the Figure 2A test finger.	The equipment is not such equipment.	N/A
M.2	Continuous ringing signals up to 16 mA only are permitted if the equipment is subjected to special installation and performance restrictions.	No TNV circuits within the equipment.	N/A
Annex NAD	Equipment connected to a telecommunication and cable distribution networks and supplied with an earphone intended to be held against, or in the ear is required to comply with special acoustic pressure requirements.	No TNV circuits within the equipment.	N/A

IEC60950_1F - ATTACHMENT			
Clause	Requirement + Test	Result - Remark	Verdict

<b>ATTACHMENT TO TEST REPORT IEC 60950-1 with A1: 2009 and A2:2013 U.S.A. NATIONAL DIFFERENCES</b> Information technology equipment – Safety – Part 1: General requirements	
<b>Differences according to.....:</b>	UL 60950-1-07(Second Edition) + A1: 2011 + A2: 2014
<b>Attachment Form No. ....:</b>	US_ND_IEC60950_1F
<b>Attachment Originator.....:</b>	UL
<b>Master Attachment.....:</b>	Date 2014-07
<b>Copyright © 2014 IEC System for Conformity Testing and Certification of Electrical Equipment (IECEE), Geneva, Switzerland. All rights reserved.</b>	

	<b>Special national conditions</b>		P
1.1.1	All equipment is designed as to allow installation in accordance with the National Electrical Code (NEC), ANSI/NFPA 70, Canadian Electrical Code (CEC), Part I, CAN/CSA C22.1, and if applicable, the National Electrical Safety Code, IEEE C2	In accordance with the National Electrical Code (NEC), ANSI/NFPA 70, and unless marked or otherwise identified, the Standard for Electronic Computer/Data-Processing Equipment, ANSI/NFPA 75.	P
	Also, unless marked or otherwise identified, installation is allowed per the Standard for the Protection of Electronic Computer/Data-Processing Equipment, ANSI/NFPA 75		P
1.1.2	Baby monitors are required to additionally comply with ASTM F2951, Consumer Safety Specification for Baby Monitors.	Not such equipment.	N/A
1.4.14	For Pluggable Equipment Type A, the protection in the installation is assumed to be 20A.	Considered.	P
1.5.5	For lengths exceeding 3.05 m, external interconnecting flexible cord and cable assemblies are required to be a suitable cable type (e.g., DP, CL2) specified in the NEC. For lengths 3.05 m or less, external interconnecting flexible cord and cable assemblies that are not types specified in the NEC are required to have special construction features and identification markings.	No external cable provided.	N/A
1.7.1	Equipment for use on a.c. mains supply systems with a neutral and more than one phase conductor (e.g. 120/240 V, 3-wire) require a special marking format for electrical ratings	Single-phase equipment.	N/A
	A voltage rating that exceeds an attachment plug		N/A

IEC60950_1F - ATTACHMENT			
Clause	Requirement + Test	Result - Remark	Verdict
	cap rating is only permitted if it does not exceed the extreme operating conditions in Table 2 of CAN/CSA C22.2 No. 235, and		
	- if it is part of a range that extends into the Table 2 "Normal Operating Conditions"		N/A
	Likewise, a voltage rating is not to be lower than the specified "Normal Operating Conditions," unless it is part of a range that extends into the "Normal Operating Conditions"		N/A
1.7.7	Wiring terminals intended to supply Class 2 outputs in accordance with NEC or CEC Part 1 or NEC are marked with the voltage rating and "Class 2" or equivalent	No wiring terminals.	N/A
	- Marking is located adjacent to the terminals		N/A
	- Marking is visible during wiring		N/A
2.5	Fuse providing Class 2, Limited Power Source, or TNV current limiting is not operator-accessible unless it is not interchangeable	No such fuse.	N/A
2.6	Equipment with isolated ground (earthing) receptacles are required to comply with NEC 250.146(D) and CEC 10-112 and 10-906(8).		N/A
2.7.1	Suitable NEC/CEC branch circuit protection rated at the maximum circuit rating is provided for all standard supply outlets and receptacles (such as supplied in power distribution units) if the supply branch circuit protection is not suitable.	No such components provided.	N/A
	Power distribution transformers distributing power at 100 volts or more, and rated 10 kVA or more, provided with special transformer overcurrent protection		N/A
3.2	Wiring methods (terminals, leads, etc.) used for the connection of the equipment to the mains shall be in accordance with the NEC/CEC.		N/A
3.2.1	Power supply cords are required to have attachment plugs rated not less than 125 percent of the rated current of the equipment.		N/A
3.2.1.2	Equipment connected to a centralized d.c. power system, and having one pole of the DC mains input terminal connected to the main protective earthing terminal in the equipment comply with special earthing, wiring, marking and installation instruction requirements	No power supply cord provided.	N/A

IEC60950_1F - ATTACHMENT			
Clause	Requirement + Test	Result - Remark	Verdict
3.2.3	Permanent connection of equipment to the mains supply by a power supply cord is not permitted, except for certain equipment, such as ATMs.	The equipment is not permanently connected equipment.	N/A
3.2.5	Power supply cords are no longer than 4.5 m in length	Pluggable equipment type A.	N/A
	Minimum cord length is 1.5 m, with certain constructions such as external power supplies allowed to consider both input and output cord lengths into the requirement		N/A
	Flexible power supply cords are compatible with Article 400 of the NEC, and Tables 11 and 12 of the CEC		N/A
3.2.9	Permanently connected equipment has a suitable wiring compartment and wire bending space	Pluggable equipment type A.	N/A
3.3	Wiring terminals and associated spacings for field wiring connections shall comply with CSA C22.2 No. 0.	No wiring terminals.	N/A
3.3.3	Wire binding screws are not permitted to attach conductors larger than 10 AWG (5.3 mm <sup>2</sup> ).	No wire binding screws.	N/A
3.3.4	Terminals for permanent wiring, including protective earthing terminals, are suitable for Canadian/US wire gauge sizes, are	Pluggable equipment type A.	N/A
	- rated 125 per cent of the equipment rating, and		N/A
	- are specially marked when specified (1.7.7)		N/A
3.3.5	Revise first column of Table 3E to "Smaller of the RATED CURRENT of the equipment or the PROTECTIVE CURRENT RATING of the circuit under consideration"		N/A
3.4.2	Motor control devices are provided for cord-connected equipment with a motor if the equipment is rated more than 12 A,	Equipment is not such a device.	N/A
	- or if the motor has a nominal voltage rating greater than 120 V		N/A
	- or is rated more than 1/3 hp (locked rotor current over 43 A)		N/A
3.4.8	Vertically-mounted disconnect switches and circuit breakers are required to have the "on" position indicated by the handle in the up position.	No such devices incorporated.	N/A
3.4.11	For computer room applications, equipment with battery systems capable of supplying 750 VA for five minutes have a battery disconnect means that may be connected to the computer room remote power-	Not such an application.	N/A

IEC60950_1F - ATTACHMENT			
Clause	Requirement + Test	Result - Remark	Verdict
	off circuit		
4.3.12	The maximum quantity of flammable liquid stored in equipment is required to comply with NFPA 30.	No flammable liquid.	N/A
4.3.13.5.1	Equipment with lasers is required to meet the U.S. Code of Federal Regulations 21 CFR 1040 (and the Canadian Radiation Emitting Devices Act, REDR C1370).	No Laser.	N/A
4.7	For computer room applications, automated information storage systems with combustible media greater than 0.76 m <sup>3</sup> (27 cu ft) have a provision for connection of either automatic sprinklers or a gaseous agent extinguishing system with an extended discharge	No such equipment.	N/A
4.7.3.1	For computer room applications, enclosures with combustible material measuring greater than 0.9 m <sup>2</sup> (10 sq ft) or a single dimension greater than 1.8 m (6 ft) are required to have a flame spread rating of 50 or less.	No such equipment.	N/A
	For other applications, enclosures with the same dimensions require a flame spread rating of 200 or less.		N/A
4.7.3.1	Non-metallic enclosures of equipment for use in spaces used for environmental air (plenums) are required to comply with UL 2043.		N/A
Annex H	Equipment that produces ionizing radiation is required to comply with the U.S. Code of Federal Regulations, 21 CFR 1020 (and the Canadian Radiation Emitting Devices Act, REDR C1370).	Equipment is not such a device.	N/A
	<b>OTHER NATIONAL DIFFERENCES</b>		P
1.5.1	Some components and materials associated with the risk of fire, electric shock, or personal injury have component or material ratings in accordance with the applicable national (Canadian and/or U.S.) component or material standard requirements.  These components include: attachment plugs, battery backup systems, battery packs, cathode ray tubes, circuit breakers, communication circuit accessories, connectors (used for current interruption of non-LPS circuits), cord sets and power supply cords, direct plug-in equipment, electrochemical capacitor modules (energy storage modules with ultracapacitors), enclosures (outdoor), flexible cords and cables, fuses (branch circuit), fuseholders, ground-fault current interrupters, industrial control equipment,	Complied. See table 1.5.1.	P

Disclaimer: This document is controlled and has been released electronically.  
Only the version on the IECEE Website is the current document version

IEC60950_1F - ATTACHMENT			
Clause	Requirement + Test	Result - Remark	Verdict
	insulating tape, interconnecting cables, lampholders, limit controls, printed wiring, protectors for communications circuits, receptacles, solid state controls, supplementary protectors, switches (including interlock switches), thermal cut-offs, thermostats, (multi-layer) transformer winding wire, surge protective devices, tubing, vehicle battery adapters, wire connectors, and wire and cables		
1.6.1.2	A circuit for connection to the DC Mains Supply is classified as a SELV Circuit, TNV-2 Circuit or Hazardous Voltage Circuit depending on the maximum operating voltage of the supply	No connection to DC mains supply.	N/A
	This maximum operating voltage includes consideration of the battery charging "float voltage" associated with the intended supply system, regardless of the marked power rating of the equipment		N/A
2.3.1	For TNV-2 and TNV-3 circuits with other than ringing signals and with voltages exceeding 42.4 V <sub>peak</sub> or 60 V <sub>d.c.</sub> , the maximum acceptable current through a 2000 ohm resistor (or greater) connected across the voltage source with other loads disconnected is 7.1 mA peak or 30 mA d.c. under normal operating conditions.	No TNV circuits.	N/A
2.3.2.1	In the event of a single fault between TNV and SELV circuits, the limits of 2.2.3 apply to SELV Circuits and accessible conductive parts.	No TNV circuits.	N/A
2.6.2	Equipment with functional earthing marked with the functional earthing symbol (IEC 60417-6092)		N/A
2.6.3.4	Protective bonding conductors of non-standard protective bonding constructions (e.g., printed circuit traces) may be subjected to the additional limited short circuit test conditions specified.		N/A
4.2.8.1	Enclosures around CRTs with a face diameter of 160 mm or more are required to reduce the risk of injury due to the implosion of the CRT.	No CRTs.	N/A
4.3.2	Equipment with handles is required to comply with special loading tests.		N/A
4.3.8	Battery packs for both portable and stationary applications comply with special component requirements	No battery packs used.	N/A
5.1.8.3	Equipment intended to receive telecommunication ringing signals is required to comply with a special touch current measurement tests.	No TNV circuits within the equipment.	N/A



IEC60950_1F - ATTACHMENT			
Clause	Requirement + Test	Result - Remark	Verdict
5.3.7	Internal (e.g., card cage) SELV circuit connectors and printed wiring board connectors that are accessible to the operator and that deliver power are overloaded		P
	During abnormal operating testing, if a circuit is interrupted by the opening of a component, the test is repeated twice (three tests total) using new components as necessary		P
6.4	Equipment intended for connection to telecommunication network outside plant cable is protected against overvoltage from power line crosses in accordance with 6.4 and Annex NAC	No TNV circuits within the equipment.	N/A
Annex EE	Articulated accessibility probe (Fig EE.3) is used for assessing accessibility to document/media shredders instead of the Figure 2A test finger	The equipment is not such equipment.	N/A
Annex M.2	Continuous ringing signals up to 16 mA only are permitted if the equipment is subjected to special installation and performance restrictions.	No TNV circuits within the equipment.	N/A
Annex NAD	Equipment connected to a telecommunication and cable distribution networks and supplied with an earphone intended to be held against, or in the ear comply with special acoustic pressure requirements	No TNV circuits within the equipment.	N/A



IEC60950_1F - ATTACHMENT			
Clause	Requirement + Test	Result - Remark	Verdict

<b>ATTACHMENT TO TEST REPORT IEC 60950-1 (AUSTRALIA/NEW ZEALAND) NATIONAL DIFFERENCES</b> (Information technology equipment-safety)	
Differences according to.....:	AS/NZS 60950.1:2015
Attachment Form No.....:	AU_NZ_ND_IEC60950_1F
Attachment Originator .....	JAS-ANZ
Master Attachment .....	2017-06
<b>Copyright © 2017 IEC System for Conformity Testing and Certification of Electrical Equipment (IECEE), Geneva, Switzerland. All rights reserved.</b>	

	<b>National Differences</b>		P
<b>Appendix ZZ</b>	Variations to IEC 60950-1, Ed 2.2 (2013) for Australia and New Zealand		P
<b>1.2</b>	<b>DEFINITIONS</b>		P
	After definition 'PERSON, SERVICE', insert the following new definition: POTENTIAL IGNITION SOURCE.....1.2.12.201	Inserted.	N/A
<b>1.5</b>	<b>COMPONENTS</b>		P
1.5.1	1..... First paragraph, insert the following text after the words 'IEC component standard: or the relevant Australian/New Zealand Standard  2..... In the Note, insert the following text after the word standard: or the relevant Australian/New Zealand Standard  3..... Second paragraph, delete the words 'without further evaluation'	Inserted.	P
1.5.2	1..... First paragraph, insert the following text after the word 'standard' or an Australian/New Zealand Standard  2..... First paragraph, second dash item, second line, insert the following text after the word 'standard' or an Australian/New Zealand Standard	Inserted.	P

IEC60950_1F - ATTACHMENT															
Clause	Requirement + Test	Result - Remark	Verdict												
	3 ..... First paragraph, second dash item, last line, insert the following text after the word 'standard': or an Australian/New Zealand Standard														
<b>1.7</b>	<b>MARKINGS AND INSTRUCTIONS</b>		P												
1.7.1.3	<i>Delete</i> existing text and <i>replace</i> with the following: Graphical symbols placed on the equipment as a requirement of this standard, shall be in accordance with IEC 60417 or ISO 3864-2 or ISO 7000, if available. In the absence of suitable symbols, the manufacturer may design specific graphical symbols. Symbols as required by this standard placed on the equipment shall be explained in the user manual	Deleted and replaced.	P												
<b>2.9</b>	<b>ELECTRICAL INSULATION</b>		P												
2.9.2	Variation Second paragraph, <i>delete</i> the word 'designated'		P												
<b>3.2.5</b>	<b>POWER SUPPLY CORDS</b>		N/A												
Table 3B	Variation 1. .... <i>Delete</i> the first four rows and replace with the following: <table border="1" data-bbox="391 1328 1002 1641"> <tbody> <tr> <td>Over 0.2 up to and including 3</td> <td>0.5<sup>a</sup></td> <td>18 [0.8]</td> </tr> <tr> <td>Over 3 up to and including 7.5</td> <td>0.75</td> <td>16 [1.3]</td> </tr> <tr> <td>Over 7.5 up to including 10</td> <td>(0.75)<sup>b</sup> 1.00</td> <td>16 [1.3]</td> </tr> <tr> <td>Over 10 up to including 16</td> <td>(1.0)<sup>c</sup> 1.5</td> <td>14 [2]</td> </tr> </tbody> </table>	Over 0.2 up to and including 3	0.5 <sup>a</sup>	18 [0.8]	Over 3 up to and including 7.5	0.75	16 [1.3]	Over 7.5 up to including 10	(0.75) <sup>b</sup> 1.00	16 [1.3]	Over 10 up to including 16	(1.0) <sup>c</sup> 1.5	14 [2]	Deleted.	N/A
Over 0.2 up to and including 3	0.5 <sup>a</sup>	18 [0.8]													
Over 3 up to and including 7.5	0.75	16 [1.3]													
Over 7.5 up to including 10	(0.75) <sup>b</sup> 1.00	16 [1.3]													
Over 10 up to including 16	(1.0) <sup>c</sup> 1.5	14 [2]													
	2. .... <i>Delete</i> NOTE 1 and renumber existing NOTE 2 as 'NOTE'	Deleted.	N/A												
	3. .... <i>Delete</i> Footnote <sup>a</sup> and replace with the following: <sup>a</sup> This nominal cross-sectional area is only allowed for Class II appliances if the length of the power supply cord, measured between the point where the cord, or cord guard, enters the appliance, and the to the plug does not exceed 2 m (0,5 mm <sup>2</sup> three-core supply flexible	Deleted.	N/A												

IEC60950_1F - ATTACHMENT			
Clause	Requirement + Test	Result - Remark	Verdict
	cords are not permitted; see AS/NZS 3191)		
<b>4.3</b>	<b>DESIGN AND CONSTRUCTION</b>		P
4.3.6	Variation <i>Delete</i> the third paragraph and <i>replace</i> with the following:	Deleted	N/A
	<i>Equipment with a plug portion, suitable for insertion into a 10 A 3-pin flat-pin socket-outlet complying with AS/NZS 3112 shall comply with the requirements in AS/NZS 3112 for equipment with integral pins for insertion into socket-outlets</i>	Not direct plug-in type.	N/A
4.3.8	Addition Eighth paragraph, <i>insert</i> the following new note after the first dash item:	Added. No batteries.	N/A
	NOTE 6.201 In cases where the voltage source is provided by power from an unassociated power source, consideration should be given to the effects of possible single fault conditions in the unassociated equipment. If the power source is unknown then it should be assumed that the maximum limit of SELV may be applied to the source input under assumed single fault conditions in the source when assessing the charging circuit in the equipment under test.		N/A
4.3.13.5.1	Variation <i>Delete</i> the first paragraph and <i>replace</i> with the following: Except as permitted below, equipment shall be classified and labelled according to IEC 60825-1 or AS/NZS 60825.1, IEC 60825-2 or AS/NZS 60825.2 and IEC 60825-12, as applicable	Deleted.	N/A
	Third paragraph, first sentence, after 'IEC 60825-1', <i>insert</i> the following text: or AS/NZS 60825.1	Inserted.	N/A
	Fourth paragraph, after 'IEC 60825-1', <i>insert</i> the following text: or AS/NZS 60825.1	Inserted.	N/A
<b>4.7</b>	<b>RESISTANCE TO FIRE</b>		P
4.7	Addition At the end of Clause 4.7, <i>insert</i> the following text: For alternate tests refer to Clause 4.7.201	Added. The alternative method is not considered.	N/A
<b>6</b>	<b>CONNECTION TO TELECOMMUNICATIONS NETWORKS</b>		N/A
6.2.2	Variation For Australia only, <i>delete</i> the first paragraph and	Deleted.	N/A

IEC60950_1F - ATTACHMENT			
Clause	Requirement + Test	Result - Remark	Verdict
	Note, and <i>replace</i> with the following: In Australia only, compliance with 6.2.2 shall be checked by the tests of both 6.2.2.1 and 6.2.2.2		
6.2.2.1	Variation For Australia only, <i>delete</i> the first paragraph including the Notes, and <i>replace</i> with the following: In Australia only, the electrical separation is subjected to 10 impulses of alternating polarity, using the impulse test generator Reference 1 of Table N.1. The interval between successive impulses is 60 s and the initial voltage, $U_c$ , is: (i) ..... for 6.2.1 a): 7.0 kV for hand-held telephones and for headsets and 2.5 kV for other equipment; and (ii) ..... For 6.2.1 b) and 6.2.1 c): 1.5kV	Deleted.	N/A
	NOTE 201 The 7 kV impulse simulates lightning surges on typical rural and semi-rural network lines		N/A
	NOTE 202 The value of 2.5 kV for 6.2.1 a) was chosen to ensure the adequacy of the insulation concerned and does not necessarily simulate likely overvoltages		N/A
6.2.2.2	Variation For Australia only, delete the second paragraph including the Note, and replace with the following: In Australia only, the a.c. test voltage is (i) ..... for 6.2.1 a): 3kV; and (ii) ..... for 6.2.1b) and 6.2.1c): 1.5kV	Deleted.	N/A
	NOTE 201 Where there are capacitors across the insulation under test, it is recommended that d.c. test voltages are used.		N/A
	NOTE 202 The 3 kV and 1.5 kV values have been determined considering the low frequency induced voltages from the power supply distribution system.		N/A
<b>7</b>	<b>CONNECTION TO CABLE DISTRIBUTION NETWORK</b>		N/A
7.3	Addition <i>Add</i> the following before the first paragraph: Equipment providing functions that fall only within the scope of AS/NZS 60065 and that incorporate a PSTN interface, are not required to comply with this Clause where the only ports provided on the equipment, in addition to a coaxial cable connection and a PSTN interface, are audio or video ports and	Added.	N/A

IEC60950_1F - ATTACHMENT			
Clause	Requirement + Test	Result - Remark	Verdict
	analogue or data ports not intended to be used for telecommunications purposes		
Annex P	Addition <i>Add</i> the following Normative References: AS/NZS 3191, Electric flexible cords AS/NZS 3112, Approval and test specification— Plugs and socket-outlets	Added.	N/A
	<b>Special national conditions (if any)</b>		P
<b>1.2.12</b>	<b>FLAMMABILITY</b>		N/A
1.2.12.15	Addition After Clause 1.2.12.15, <i>insert</i> the following new clause:	Added.	N/A
<b>1.2.12.201</b>	<b>POTENTIAL IGNITION SOURCE</b> Possible fault which can start a fire if the open-circuit voltage measured across an interruption or faulty contact exceeds a value of 50 V (peak) a.c. or d.c. and the product of the peak value of this voltage and the measured r.m.s. current under normal operating conditions exceeds 15 VA		N/A
	Such a faulty contact or interruption in an electrical connection includes those which may occur in CONDUCTIVE PATTERNS on PRINTED BOARDS		N/A
	NOTE 1 An electronic protection circuit may be used to prevent such a fault from becoming a POTENTIAL IGNITION SOURCE		N/A
	NOTE 2 This definition is from AS/NZS 60065:2012, Clause 2.8.11.		N/A
<b>4</b>	<b>PHYSICAL REQUIREMENTS</b>		P
4.1	Addition After Clause 4.1, <i>insert</i> new Clause 4.1.201 as follows:	Added.	N/A
<b>4.1.201</b>	<b>Display devices used for television purposes</b> Display devices which may be used for television purposes, with a mass of 7 kg or more, shall comply with the requirements for stability and mechanical hazards, including the additional stability requirements for television receivers, specified in AS/NZS 60065		N/A
<b>4.3</b>	<b>DESIGN AND CONSTRUCTION</b>		N/A

IEC60950_1F - ATTACHMENT			
Clause	Requirement + Test	Result - Remark	Verdict
4.3.8	Addition After Clause 4.3.8, <i>add</i> the following new clause as follows	Added. No batteries.	N/A
<b>4.3.8.201</b>	<b>Products containing coin/button cell batteries and batteries designated R1</b> The requirements of AS/NZS 60065:2012 Amendment 1:2015, Clause 14.10.201 apply for this Clause.		N/A
<b>4.7</b>	<b>RESISTANCE TO FIRE</b>		P
4.7.3.6	Addition After Clause 4.7.3.6, <i>add</i> new clauses as follows:	Added.	N/A
<b>4.7.201</b>	<b>Resistance to fire—Alternative tests</b>	Added. The alternative method is not considered.	N/A
<b>4.7.201.1</b>	<b>General</b> Parts of non-metallic material shall be resistant to ignition and spread of fire. This requirement does not apply to decorative trims, knobs and other parts unlikely to be ignited or to propagate flames from inside the apparatus, or the following: a) Components that are contained in an enclosure having a flammability category of V-0 according to AS/NZS 60695.11.10 and having openings only for the connecting wires filling the openings completely, and for ventilation not exceeding 1 mm in width regardless of length.		N/A
	b) The following parts which would contribute negligible fuel to a fire: – small mechanical parts, the mass of which does not exceed 4 g, such as mounting parts, gears, cams, belts and bearings; – small electrical components, such as capacitors with a volume not exceeding 1,750 mm <sup>3</sup> , integrated circuits, transistors and optocoupler packages, if these components are mounted on material of flammability category V-1, or better, according to AS/NZS 60695.11.10		N/A
	NOTE In considering how to minimize propagation of fire and what 'small parts' are, account should be taken of the cumulative effect of small parts adjacent to each other for the possible effect of propagating the fire from one part to another		N/A
	<i>Compliance shall be checked by the tests of 4.7.201.2, 4.7.201.3, 4.7.201.4 and 4.7.201.5</i>		N/A
	<i>For the base material of printed boards, compliance shall be checked by the test of 4.7.201.5</i>		N/A

IEC60950_1F - ATTACHMENT									
Clause	Requirement + Test	Result - Remark	Verdict						
	The tests shall be carried out on parts of non-metallic material which have been removed from the apparatus. When the glow-wire test is carried out, the parts shall be placed in the same orientation as they would be in normal use. These tests are not carried out on internal wiring		N/A						
4.7.201.2	<p><b>Testing of non-metallic materials</b></p> <p>Parts of non-metallic material shall be subject to the glow-wire test of AS/NZS 60695.2.11 which shall be carried out at 550°C</p> <p>Parts for which the glow-wire test cannot be carried out, such as those made of soft or foamy material, shall meet the requirements specified in ISO 9772 for category FH-3 material. The glow-wire test shall be not carried out on parts of material classified at least FH-3 according to ISO 9772 provided that the sample tested was not thicker than the relevant part.</p>		N/A						
4.7.201.3	<p><b>Testing of insulating materials</b></p> <p>Parts of insulating material supporting POTENTIAL IGNITION SOURCES shall be subject to the glow-wire test of AS/NZS 60695.2.11 which shall be carried out at 750°C.</p> <p>The test shall be also carried out on other parts of insulating material which are within a distance of 3 mm of the connection.</p> <p>NOTE Contacts in components such as switch contacts are considered to be connections.</p> <p>For parts which withstand the glow-wire test but produce a flame, other parts above the connection within the envelope of a vertical cylinder having a diameter of 20 mm and a height of 50 mm shall be subjected to the needle-flame test. However, parts shielded by a barrier which meets the needle-flame test shall not be tested.</p> <p>The needle-flame test shall be made in accordance with AS/NZS 60695.11.5 with the following modifications:</p>		N/A						
	<table border="1"> <tr> <td><b>Clause of AS/NZS 60695.11.5</b></td> <td><b>Change</b></td> </tr> <tr> <td><b>9 Test procedure</b></td> <td></td> </tr> <tr> <td><b>9.2 Application of Needle-flame</b></td> <td><i>Delete</i> the first and second paragraphs and <i>replace</i> with the</td> </tr> </table>	<b>Clause of AS/NZS 60695.11.5</b>	<b>Change</b>	<b>9 Test procedure</b>		<b>9.2 Application of Needle-flame</b>	<i>Delete</i> the first and second paragraphs and <i>replace</i> with the		N/A
<b>Clause of AS/NZS 60695.11.5</b>	<b>Change</b>								
<b>9 Test procedure</b>									
<b>9.2 Application of Needle-flame</b>	<i>Delete</i> the first and second paragraphs and <i>replace</i> with the								



IEC60950_1F - ATTACHMENT			
Clause	Requirement + Test	Result - Remark	Verdict
	<p>following: The specimen shall be arranged so that the flame can be applied to a vertical or horizontal edge as shown in the examples of Figure 1. If possible the flame shall be applied at least 10 mm from a corner. The duration of application of the test flame shall be 30 s ± 1 s</p>		
	<p><b>9.3 Number of test specimens</b></p>	<p><i>Delete</i> existing text and <i>replace</i> with the following: The test shall be made on one specimen. If the specimen does not withstand the test, the test may be repeated on two further specimens, both of which shall withstand the test.</p>	
	<p><b>11 Evaluation of test results</b></p>	<p><i>Delete</i> existing text and <i>replace</i> with the following: The duration of burning (tb) shall not exceed 30 s. However, for printed circuit boards, it shall not exceed 15s</p>	
	<p>The needle-flame test shall not be carried out on parts of material classified as V-0 or V-1 according to AS/NZS 60695.11.10, provided that the sample tested was not thicker than the relevant part</p>		N/A
<b>4.7.201.4</b>	<p><b>Testing in the event of non-extinguishing material</b> If parts, other than enclosures, do not withstand the glow wire tests of 4.7.201.3 by failure to extinguish within 30 s after the removal of the glow-wire tip, the needle-flame test detailed in 4.7.201.3 shall be made on all parts of non-metallic material which are within a distance of 50 mm or</p>		N/A

IEC60950_1F - ATTACHMENT			
Clause	Requirement + Test	Result - Remark	Verdict
	which are likely to be impinged upon by flame during the tests of 4.7.201.3. Parts shielded by a separate barrier which meets the needle-flame test need not be tested.		
	NOTE 1 If the enclosure does not withstand the glow-wire test the equipment is considered to have failed to meet the requirements of Clause 4.7.201 without the need for consequential testing.		N/A
	NOTE 2 If other parts do not withstand the glow-wire test due to ignition of the tissue paper and if this indicates that burning or glowing particles can fall onto an external surface underneath the equipment, the equipment is considered to have failed to meet the requirements of Clause 4.7.201 without the need for consequential testing		N/A
	NOTE 3 Parts likely to be impinged upon by the flame are considered to be those within the envelope of a vertical cylinder having a radius of 10 mm and a height equal to the height of the flame, positioned above the point of the material supporting, in contact with, or in close proximity to, connections.		N/A
<b>4.7.201.5</b>	<b>Testing of printed boards</b> The base material of printed boards shall be subjected to the needle-flame test of Clause 4.7.201.3. The flame shall be applied to the edge of the board where the heat sink effect is lowest when the board is positioned as in normal use. The flame shall not be applied to an edge, consisting of broken perforations, unless the edge is less than 3 mm from a POTENTIAL IGNITION SOURCE.		N/A
	The test is not carried out if the – Printed board does not carry any POTENTIAL IGNITION SOURCE;  – Base material of printed boards, on which the available apparent power at a connection exceeds 15 VA operating at a voltage exceeding 50 V and equal or less than 400 V (peak) a.c. or d.c. under normal operating conditions, is of flammability category V-1 or better according to AS/NZS 60695.11.10, or the printed boards are protected by an enclosure meeting the flammability category V-0 according to AS/NZS 60695.11.10, or made of metal, having openings only for connecting wires which fill the openings completely; or  – Base material of printed boards, on which the available apparatus power at a connection exceeds 15 VA operating at a voltage exceeding 400 V (peak) a.c. or d.c. under normal operating conditions, and base material of printed boards supporting spark gaps which provides protection		N/A



IEC60950_1F - ATTACHMENT			
Clause	Requirement + Test	Result - Remark	Verdict
	against overvoltages, is of flammability category V-0 according to AS/NZS 60695.11.10 or the printed boards are contained in a metal enclosure, having openings only for connecting wires which fill the openings completely . <i>Compliance shall be determined using the smallest thickness of the material.</i>		
	NOTE Available apparent power is the maximum apparent power which can be drawn from the supplying circuit through a resistive load whose value is chosen to maximise the apparent power for more than 2 m when the circuit supplied is disconnected.		N/A

IEC60950_1F - ATTACHMENT			
Clause	Requirement + Test	Result - Remark	Verdict
<b>ATTACHMENT TO TEST REPORT</b> <b>IEC 60950-1 with A1: 2009 and A2:2013</b> <b>JAPAN NATIONAL DIFFERENCES</b> <b>Information technology equipment – Safety – Part 1: General requirements</b>			
<b>Differences according to.....</b> : J60950-1 (H29) <b>Attachment Form No.....</b> : JP_ND_IEC60950_1F <b>Attachment Originator .....</b> : JQA <b>Master Attachment.....</b> : 2017-11			
<b>Copyright © 2017 IEC System for Conformity Testing and Certification of Electrical Equipment (IECEE), Geneva, Switzerland. All rights reserved.</b>			
1.2.4.1	Add the following new notes. Note: Even if the equipment is designed as Class I, the equipment is regarded as CLASS 0I EQUIPMENT (see 1.2.4.3A) when 2-pin adaptor with earthing lead wire or cord set having 2-pin plug with earthing lead wire is provided or recommended.	Added. Class II equipment.	N/A
1.2.4.3A	Add the following new clause. 1.2.4.3A CLASS 0I EQUIPMENT Equipment having attachment plug without earthing blade, where protection against electric shock is achieved by: <ul style="list-style-type: none"> <li>- using BASIC INSULATION, and</li> <li>- providing either of the following a) or b) in order to connect those conductive parts that might assume a HAZARDOUS VOLTAGES in the event of BASIC INSULATION fault to the PROTECTIVE EARTHING CONDUCTOR in the building wiring.</li> </ul> a) Provision of 2-pin plug with earthing lead including the condition of that 2-pin adaptor with earthing lead wire is provided or recommended. b) Provision of an independent earthing terminal, when 2-core mains cord (without earthing conductor) is used. Note – CLASS 0I EQUIPMENT may have a part constructed with Double Insulation or Reinforced Insulation.	Added. Class II equipment.	N/A
1.3.2	Add the following notes after the first paragraph: Note 1 Transportable or similar equipment that are relocated frequently for intended usage should not	Added.	N/A

IEC60950_1F - ATTACHMENT			
Clause	Requirement + Test	Result - Remark	Verdict
	<p>be designed as Class I or CLASS 0I EQUIPMENT unless it is intended to be installed by service personnel.</p> <p>Note 2 Considering wiring circumstance in Japan, equipment intended to be installed where the provision for earthing connection is unlikely should not be designed as Class I or CLASS 0I EQUIPMENT unless it is intended to be installed by service personnel.</p>		
1.5.1	<p>Replace the first paragraph with the follows: Where safety is involved, components shall comply either with the requirements of this standard, with the safety aspects of the relevant JIS component standard, or IEC component standards, or components shall have equivalent to or better properties than these.</p> <p>Replace Note 1 with the following: Note 1 Components complying with the interpretation of Ministerial Ordinance on stipulating technical requirements for the Electrical Appliance is regarded to have equivalent to or better performance.</p> <p>Note 2 JIS or an IEC component standard is considered relevant only if the component in question clearly falls within its scope.</p> <p>Add the following after the last paragraph: For an appliance connector that is able to fit with appliance inlet compatible with the standard sheet of IEC 60320-1 or JIS C 8283-1, the size of the connector shall comply with relevant standard sheet of IEC 60320-1 or JIS C 8283-1. A power supply cord set complying with JIS C 8286 is regarded to comply with this requirement.</p> <p>Note 3 A power supply cord set provided with appliance connector that is able to fit with appliance inlet compatible with the standard sheet of IEC 60320-1 or JIS C 8283-1 should comply with JIS C 8286.</p>	Replaced.	P
1.5.2	<p>Add the following Note 2 after the 4th dashed paragraph: Note 2 See 1.7.5A when Type C.14 appliance coupler rated 10 A per JIS C 8283-1 is used with an equipment rated not more than 125 V and rated more than 10 A.</p>	Replaced.	P
1.5.5	<p>Add the following Note after the last paragraph:</p>	Added.	P

IEC60950_1F - ATTACHMENT			
Clause	Requirement + Test	Result - Remark	Verdict
	NOTE An interconnection cord sets provided with interconnecting coupler for mains supply complying with JIS C 8283-2-2 should comply with JIS C 8286.		
1.5.9.1	Add the following in the last of NOTE 1. Gas discharge tube connected in series with VDR may be used.	Added. No gas discharge tube.	N/A
1.7	Replace EE.2 and EE.4 with the following: JA.1 Shredder warning JA.3 Shredder power disconnection	Replaced.	P
1.7.1.2	Replace first and second dashed paragraphs with the followings: - manufacturer's or responsible company's name or trade-mark or identification mark; - manufacturer's or responsible company's model identification or type reference;	Replaced.	P
1.7.2.1	Add the following after the second paragraph. Instruction or equipment marking regarding safety shall be written in Japanese unless otherwise permitted in this standard.	Added.	P
1.7.2.5	Replace the last sentence with the following: An acceptable marking for an electric shock hazard is  (6.2.4 of JIS S 0101).	Replaced. No operator access area with a tool.	N/A
1.7.5	Replace the second paragraph with the following. Socket-outlets conforming to JISC8282-1 are examples of standard power supply outlets.	Replaced.	N/A
1.7.5A	Add the following new clause after 1.7.5. 1.7.5A Power supply cord set If appliance coupler according to IEC60320-1, C.14(rated current: 10A) is used in equipment whose rated voltage is less than 125V and rated current is over 10A, the following instruction or equivalent shall be described in the operating instruction. " Use only designated cord set attached in this equipment" <i>Example in Japanese:</i> "この機器に同こん(梱)した指定の電源コードセットだけを使用して下さい。" If appliance coupler is used for connection to the	Added. The rated current of appliance coupler is less than 10A.	N/A

IEC60950_1F - ATTACHMENT			
Clause	Requirement + Test	Result - Remark	Verdict
	<p>mains and if the cord set is not provided within the package for the equipment, suitable information regarding to the cord set shall be described in the operating instruction</p> <p>Note Since the combination of appliance inlet with earthing pin and two-core cord set (without earthing conductor) is special, the cord set should be attached in the equipment and the operating <i>instruction should provide the information that the cord set is exclusively used with the equipment and not allowed to use with other equipment.</i></p>		
1.7.14A	<p>Add the following new clause after 1.7.14.</p> <p>1.7.14A Marking for CLASS 0I EQUIPMENT For CLASS 0I EQUIPMENT, the following or equivalent instructions shall be marked.</p> <p>- the following instruction shall be marked on the mains plug or on the visible place of the main body “Provide an earthing connection”</p> <p><i>Example in Japanese:</i> “必ず接地接続を行ってください。”</p> <p>- the following instruction shall be marked on the visible place of the main body or written in the operating instructions: “Provide an earthing connection before the mains plug is connected to the mains. And, when disconnecting the earthing connection, be sure to disconnect after pulling out the mains plug from the mains.”</p> <p><i>Example in Japanese:</i> 接地接続は必ず、電源プラグを電源につなぐ前に行ってください。 また、接地接続を外す場合は、必ず電源プラグを電源から切り離してから行ってください。</p>	Added. Class II equipment.	N/A
1.7.14B	<p>Add the following new clause after 1.7.14A</p> <p>1.7.14B Protective earthing conductor used for CLASS 0I EQUIPMENT For CLASS 0I EQUIPMENT provided with independent main protective earthing terminal, where the cord for the protective earthing connection is not provided within the package for the equipment, the suitable information for the protective earthing connection shall be provided in the operating instruction. (See 2.6.3.2)</p>	Added. Class II equipment.	N/A

IEC60950_1F - ATTACHMENT			
Clause	Requirement + Test	Result - Remark	Verdict
2.1.1.1	<p>Replace item b) of 2.1.1.1 with the following.</p> <p>b) A test with the test finger, Figure 2A, which shall not contact parts described above when applied to openings in the ENCLOSURES after removal of parts that can be detached by an OPERATOR, including fuseholders, and with OPERATOR access doors and covers open. It is permitted to leave lamps in place for this test. Connectors that can be separated by an OPERATOR, other than those complying with JIS C 8303 or JIS C 8285 or IEC 60309 series or JIS C 8283 series or IEC 60320 series, shall also be tested during disconnection. But even if the connector does not comply with these standards, the one having equivalent to or better performance need not be tested during disconnection.</p> <p>Note 4 Connectors complying with Appendix 4 of the interpretation of Ministerial Ordinance on stipulating technical requirements for the Electrical Appliance is regarded to have equivalent to or better performance.</p>	Replaced.	P
2.5	Replace "IEC 60730-1" with "JIS C 9730-1" (in item b)).	Replaced.	P
2.6.2	<p>Delete the following line.</p> <p>• the symbol , IEC 60417-5018 (2011-07);</p>	Deleted.	N/A
2.6.3.2	<p>Add the following after the first paragraph.</p> <p>However where the single core conductor is used for protective earthing lead or earthing cord for CLASS 01 EQUIPMENT, either of the following condition shall be met.</p> <ul style="list-style-type: none"> <li>- Use of annealed copper wire with 1.6 mm diameter or corrosion-inhibiting metal wire having equivalent to or more strength and thickness.</li> <li>- Single core cord or single core cable with 1.25 mm<sup>2</sup> or more cross-sectional area</li> </ul>	Added. Class II equipment.	N/A
2.6.3.5	<p>Add the following after the first paragraph.</p> <p>However this requirement does not apply to internal conductor of the cord set that is covered by the sheath of mains cord and is formed together with mains plug and appliance connector.</p>	Added.	N/A
2.6.4.2	<p>Replace the first paragraph with the following.</p> <p>Equipment required to have protective earthing</p>	Added.	N/A



IEC60950_1F - ATTACHMENT			
Clause	Requirement + Test	Result - Remark	Verdict
	shall have a main protective earthing terminal. For equipment with a DETACHABLE POWER SUPPLY CORD, the earthing terminal in the appliance inlet is regarded as the main protective earthing terminal. However, for CLASS 0I EQUIPMENT provided with the separate main protective earthing terminal other than appliance inlet, the separate main protective earthing terminal may be treated as mains protective earthing terminal.		
2.6.5.4	Replace the first sentence with the following. Protective earthing connections of CLASS I EQUIPMENT shall make earlier and break later than the supply connections in each of the following: Add the following after last paragraph: Note For CLASS 0I EQUIPMENT, 1.7.14A is applied instead of this requirement.	Replaced.	N/A
2.6.5.8A	Add the following new clause after 2.6.5.8 2.6.5.8A Earthing of CLASS 0I EQUIPMENT Plugs with a lead wire for earthing shall not be used for equipment having a rated voltage exceeding 150V. For plugs with a lead wire for earthing, the lead wire shall not be earthed by a clip. CLASS 0I EQUIPMENT shall be provided with an earthing terminal or lead wire for earthing in the external location where easily visible.	Added.	N/A
2.7.6	Replace "ISO 3864, No. 5036" with "6.2.4 of JIS S 0101".	Replaced. No service work considered.	N/A
2.10.3.1	Replace the 8th paragraph with the following The above minimum CLEARANCE for connectors do not apply to connectors that comply with JIS C 8285, IEC60309 series of standards, JIS C 8283 series of standards, IEC60320 series of standards, JIS C 8303, or even if it does not comply with the above standards but the one having equivalent to or better performance and dimension which comply with JIS C 8283 series of standards, JIS C 8303 or IEC 60309-2. Note Connectors complying with Appendix 4 of the interpretation of Ministerial Ordinance on stipulating technical requirements for the Electrical Appliance is regarded to have equivalent to or	Replaced.	P

IEC60950_1F - ATTACHMENT			
Clause	Requirement + Test	Result - Remark	Verdict
	better performance.		
2.10.3.2 Table 2J	In Japan, the value of the main power supply transient voltage for the nominal ac main power supply voltage of 100 V is determined by applying the row of AC main power supply voltage 150 V.	Added.	P
2.10.4.3	Replace the 6th paragraph with the following The above minimum CREEPAGE DISTANCE for connectors do not apply to connectors that comply with JIS C 8285, IEC60309 series of standards, JIS C 8283 series of standards, IEC60320 series of standards, JIS C 8303, or even if it does not comply with the above standards but the one having equivalent to or better performance and dimension which comply with JIS C 8283 series of standards, JIS C 8303 or IEC 60309-2. Note Connectors complying with Appendix 4 of the interpretation of Ministerial Ordinance on stipulating technical requirements for the Electrical Appliance is regarded to have equivalent to or better performance.	Replaced.	P
2.10.9	Replace "1.4.5" in the third paragraph with "1.4.12".	Replaced.	N/A
3.2.3	Add the following after the third paragraph. Table 3A applies when cables complying JIS C 3662 series of standards or JIS C 3663 series of standards are used. In case of other cables, cable entries shall be so designed that the cable could be fitted in a conduit.	Added. Not permanently connected equipment.	N/A
3.2.4	Add the following as 4th dashed paragraph. - be so constructed that mechanical stress shall not transmit to the soldering part of inlet terminal during insertion or removal of the connector except that the body of the inlet is secured and is secured not only soldering.	Inlet is fixed by adequate mechanical construction, not rely on soldering only.	P
3.2.5.1	Add the following after Note 3: Note 4 In Japan, mains cords having equivalent to or better electro-mechanical and fire safety performance as above and complying with Appendix 1 of the interpretation of Ministerial Ordinance on stipulating technical requirements for the Electrical Appliance can be used. Replace the paragraph after Note 3 with the following. For equipment required to have protective	Added. Approved power supply cord provided.	P

IEC60950_1F - ATTACHMENT			
Clause	Requirement + Test	Result - Remark	Verdict
	<p>earthing, a PROTECTIVE EARTHING CONDUCTOR shall be included in the MAINS SUPPLY cord except for CLASS 0I EQUIPMENT having separate protective earthing conductor from mains cord.</p> <p>Add the following after the second paragraph after Note 3:</p> <p>Note 5 For the cross-sectional area of mains cord described in Note 4, relevant Japanese wiring regulation can be applied.</p>		
3.2.5A	<p>Add the following new clause after 3.2.5</p> <p>3.2.5A AC mains plug Mains plug for PLUGGABLE EQUIPMENT TYPE A shall comply with JIS C 8282-1 or equivalent to or better performance. Power supply cord set complying with JIS C 8286 is regarded to meet the requirements. Mains plug with fuse link for PLUGGABLE EQUIPMENT TYPE A shall comply with JIS C 8282-2-1 or equivalent to or better performance.</p> <p>Note Mains plug complying with Appendix 4 of the interpretation of Ministerial Ordinance on stipulating technical requirements for the Electrical Appliance is regarded to have equivalent to or better performance.</p>	<p>Added. Approved power supply cord provided.</p>	P
3.3.4 Table 3D	<p>Add the following note to Table 3D:</p> <p>Note For cables other than those complying with JIS C 3662 series of standards or JIS C 3663 series of standards, the terminals shall be suitable for the size of the intended cables.</p>	<p>Added. AC inlet used. No such wiring terminal on EUT.</p>	N/A
3.3.7	<p>Add the following after the first sentence:</p> <p>This requirement is not applicable to the external earthing terminal of CLASS 0I EQUIPMENT.</p>	<p>Added. AC inlet used. No such wiring terminal on EUT.</p>	N/A
4.2.8	<p>Add the following after the first paragraph:</p> <p>Note Intrinsically protected picture tube is required to comply with JIS C 6965 in clause 18 of JIS C 6065. No intrinsically protected picture tube which is out of scope of JIS C 6965 is required to test according to sub-clause 18.2 of JIS C 6065.</p>	<p>Added. No CRT.</p>	N/A
4.3.4	<p>Add the following after the first sentence:</p> <p>This requirement also applies to those connections in CLASS 0I EQUIPMENT, where CLEARANCE or CREEPAGE DISTANCES over BASIC INSULATION would be reduced to less than the</p>	<p>Added.</p>	N/A

IEC60950_1F - ATTACHMENT											
Clause	Requirement + Test	Result - Remark	Verdict								
	values specified in 2.10.										
4.3.5	<p>Replace the first dashed paragraph with the following.</p> <p>Within a manufacturer's unit or system, plugs and sockets likely to be used by the OPERATOR or by a SERVICE PERSON shall not be employed in a manner likely to create a hazard due to misconnection. In particular, connectors complying with IEC 60320/JIS C 8283 series of standards or JIS C 8303 or JIS C 8358 shall not be used for SELV CIRCUITS or TNV CIRCUITS. Keying, location or, in the case of connectors accessible only to a SERVICE PERSON, clear markings are permitted to meet the requirement.</p>	Replaced. AC inlet used.	N/A								
4.3.6	<p>Replace the 1st paragraph with the following:</p> <p>DIRECT PLUG-IN EQUIPMENT shall not impose undue stress on the socket-outlet. The mains plug part shall comply with the standard for the relevant mains plug. (see 3.2.5A)</p>	Replaced. No direct plug-in equipment.	N/A								
4.4.2	<p>Replace the paragraph with the following:</p> <p>HOUSEHOLD AND HOME/OFFICE DOCUMENT/MEDIA SHREDDERS shall also comply with Annex JA.</p>	Replaced. No such equipment.	N/A								
4.5.3	<p>Add the following note to footnote b) of Table 4B:</p> <p>NOTE In case no data for the material is available, Appendix 4, 1. (1). b. 3 of the Interpretation on the Ministerial Ordinance stipulating Technical Specifications for Electrical Appliances is regarded as maximum temperature limit of the material.</p>	Replaced.	P								
5.1.3	<p>Add a note after the first paragraph as follows:</p> <p>Note – Attention should be drawn to that majority of three-phase power system in Japan is of delta connection, and therefore, in that case, test is conducted using the test circuit from IEC 60990, figure 13.</p>	Added.	P								
5.1.6	<p>Replace Table 5A. as follows</p> <table border="1" data-bbox="391 1720 1002 1989"> <thead> <tr> <th>Type of equipment</th> <th>Terminal A of measuring instrument connected to:</th> <th>Maximum TOUCH CURRENT mA r.m.s. <sup>a</sup></th> <th>Maximum PROTECTIVE CONDUCTOR CURRENT</th> </tr> </thead> <tbody> <tr> <td>ALL equipment</td> <td>Accessible parts and circuits not connected to protective earth</td> <td>0,25</td> <td>-</td> </tr> </tbody> </table>	Type of equipment	Terminal A of measuring instrument connected to:	Maximum TOUCH CURRENT mA r.m.s. <sup>a</sup>	Maximum PROTECTIVE CONDUCTOR CURRENT	ALL equipment	Accessible parts and circuits not connected to protective earth	0,25	-	Replaced.	P
Type of equipment	Terminal A of measuring instrument connected to:	Maximum TOUCH CURRENT mA r.m.s. <sup>a</sup>	Maximum PROTECTIVE CONDUCTOR CURRENT								
ALL equipment	Accessible parts and circuits not connected to protective earth	0,25	-								

IEC60950_1F - ATTACHMENT						
Clause	Requirement + Test			Result - Remark	Verdict	
	HAND-HELD	<sup>b</sup> Main protective earthing terminal of CLASS I EQUIPMENT	0,75	-		
		Main protective earthing terminal of CLASS 0 I EQUIPMENT	0,5	-		
	MOVABLE (other than HAND_HELD, but including TRANSPORTABLE EQUIPMENT)	Main protective earthing terminal of CLASS I EQUIPMENT	3,5	-		
		Main protective earthing terminal of CLASS 0 I EQUIPMENT	1.0	-		
	STATIONARY, PLUGGABLE TYPE A	Main protective earthing terminal of CLASS I EQUIPMENT	3,5	-		
		Main protective earthing terminal of CLASS 0 I EQUIPMENT	1,0	-		
	ALL other STATIONARY EQUIPMENT - not subject to the conditions of 5.1.7 - subject to the conditions of 5.1.7	Main protective earthing terminal of CLASS I EQUIPMENT	3.5 -	- 5 % of input current		
		Main protective earthing terminal of CLASS 0 I EQUIPMENT	1.0 -	- -		
	a If peak values of TOUCH CURRENT are measured, the maximum values are obtained by multiplying the r.m.s.values in the table by 1,414. b Some unearthed accessible parts are covered in 1.5.6 and 1.5.7 and the requirements of 2.4 apply. These may be different from those in 5.1.6.					
	Annex G	Replace the paragraph before Table G.2 with the following The above minimum CLEARANCE for connectors do not apply to connectors that comply with JIS C 8285, IEC60309 series of standards, JIS C 8283 series of standards, IEC60320 series of standards, JIS C 8303, and 1.5.1 of this standard in which dimension is comply with JIS C 8283 series, JIS C 8303 or IEC 60309-2.				Replaced.
Annex V V.1	Replace "3.1.2" in the first line of V.1 with "312" in the first line.			Replaced.	P	
Annex W W.1	Replace the third sentence in the first paragraph with the following: Floating circuits can exist in CLASS I EQUIPMENT, CLASS 0I EQUIPMENT and earthed circuits can exist in CLASS II EQUIPMENT.			Replaced.	N/A	

IEC60950_1F - ATTACHMENT			
Clause	Requirement + Test	Result - Remark	Verdict
Annex BB	This annex is not applicable.		—
Annex CC CC.2	Replace the third dashed paragraph with the following: <i>- 10 000 cycles of turning enable on and off with the input connected to a capacitor rated 425 uF ± 10 uF and shorting the output;</i>	Replaced.	N/A
CC.3	Add note at end of CC.3: Note: The fast blow fuse should be the one complying with JIS C 6575-2.	Added.	N/A
CC.4	Replace the 2nd dashed paragraph with the following: - 10 000 cycles of turning enable on and off with a 100 Ω ± 5 Ω resistor and a 425 uF ± 10 uF capacitor in parallel with the output; Replace the 4th dashed paragraph with the following: - 10 000 cycles of turning enable on and off with the input connected to a capacitor rated 425 uF ± 10 uF and shorting the output; Replace the 5th dashed paragraph with the following: -10 000 cycles of turning the input pin on and off with a capacitor rated 425 uF ± 10 uF connected to the input supply while keeping enable active and shorting the output; Replace the 6th dashed paragraph with the following: -10 000 cycles of turning the input pin on and off with an ferrite-core inductor having 350 mH ± 10 mH inductance at 1 kHz and less than 1 Ω d.c. resistance connected to the input supply and return while keeping enable active and shorting the output; Replace the 10th dashed paragraph with the following: -3 cycles of exposing the device (not energized) to 70 °C ± 2 °C for 24 h; followed by at least 1 h at room ambient; followed by at least 3 h at -30 °C ± 2 °C; followed by 3 h at room ambient; Replace the 11th dashed paragraph with the following:	Replaced.	N/A

IEC60950_1F - ATTACHMENT			
Clause	Requirement + Test	Result - Remark	Verdict
	-10 cycles of exposing the device (while energized) to 50 °C ± 2 °C for 10 min; followed by 10 min at 0 °C ± 2 °C with a 5 min period of transition from one state to the other;		
Annex EE	<p>Replace Annex EE with the following Annex JA.</p> <p style="text-align: center;">Annex JA (normative) Document shredding machines</p> <p>HOUSEHOLD AND HOME/OFFICE DOCUMENT/MEDIA SHREDDERS shall additionally comply with the requirements of this annex.</p> <p><b>JA.1 Markings and instructions</b></p> <p>The symbol  (JIS S 0101:2000, 6.2.1) and the following precautions for use shall be marked on readily visible part adjacent to document feed opening. The marking shall be clearly legible, permanent, and easily discernible;</p> <p>子供が使用することによって、傷害などの危害が発生するおそれがある。 (that use by infants/children may cause a hazard of injury etc.)</p> <p>文書投入口に手を触れることによって、細断機構に引き込まれるおそれがある。 (that a hand can be drawn into the mechanical section for shredding when touching the document-slot)</p> <p>文書投入口に衣類が触れることによって、細断機構に引き込まれるおそれがある。 (that clothing can be drawn into the mechanical section for shredding when touching the document-slot)</p> <p>文書投入口に髪の毛が触れることによって、細断機構に引き込まれるおそれがある。 (that hairs can be drawn into the mechanical section for shredding when touching the document-slot)</p> <p>- in case of equipment incorporating a commutator motor, 可燃性ガスを噴射することによって引火又は爆発するおそれがある。 (that equipment may catch fire or explode by spraying of flammable gas.)</p>	Replaced.	N/A

IEC60950_1F - ATTACHMENT			
Clause	Requirement + Test	Result - Remark	Verdict
	<p><b>JA.2 Inadvertent reactivation</b> Any safety interlock that can be operated by means of the test finger, Figure JA.1, is considered to be likely to cause inadvertent reactivation of the hazard. Compliance is checked by inspection and, where necessary, by a test with the test finger, Figure JA.1.</p> <p><b>JA.3 Disconnection from the mains supply</b> Document shredding machines shall incorporate an isolating switch complying with sub-clause 3.4.2 as the device disconnecting the power of hazardous moving parts. For this switch, two-position (single-use) switch or multi-position (multifunction) switch (e.g., slide switch) may be used. If two-position switch, the positions for "ON" and "OFF" shall be indicated in accordance with sub-clause 1.7.8. If multi-position switch, the position for "OFF" shall be indicated in accordance with sub-clause 1.7.8 and other positions shall be indicated with proper terms or symbols. Compliance is checked by inspection.</p>		
	<p><b>JA.4 Protection against hazardous moving parts</b> Any warning shall not be used instead of the structure for preventing access to hazardous moving parts. Document shredding machines shall comply with the following requirements. Insert the test finger, Figure JA.1, into all openings in MECHANICAL ENCLOSURES without applying appreciable force. It shall not be possible to touch hazardous moving parts with the test finger. This consideration applies to all sides of MECHANICAL ENCLOSURES when the equipment is mounted as intended. Before testing with the test finger, remove the parts detachable without a tool. Insert the wedge-probe, Figure JA.2, into the document-slot. And, against all directions of openings, if straight-cutting type, a force of 45 N shall apply to the probe, and 90 N if cross-cutting type. In this case, the weight of the probe is to be factored into the overall applied force. Before testing with the wedge-probe, remove the parts detachable without a tool. It shall not be possible to touch any hazardous moving parts, including the</p>		N/A



IEC60950\_1F - ATTACHMENT

Clause	Requirement + Test	Result - Remark	Verdict
--------	--------------------	-----------------	---------

	shredding roller or the mechanical section for shredding, with the probe.		
--	---	--	--

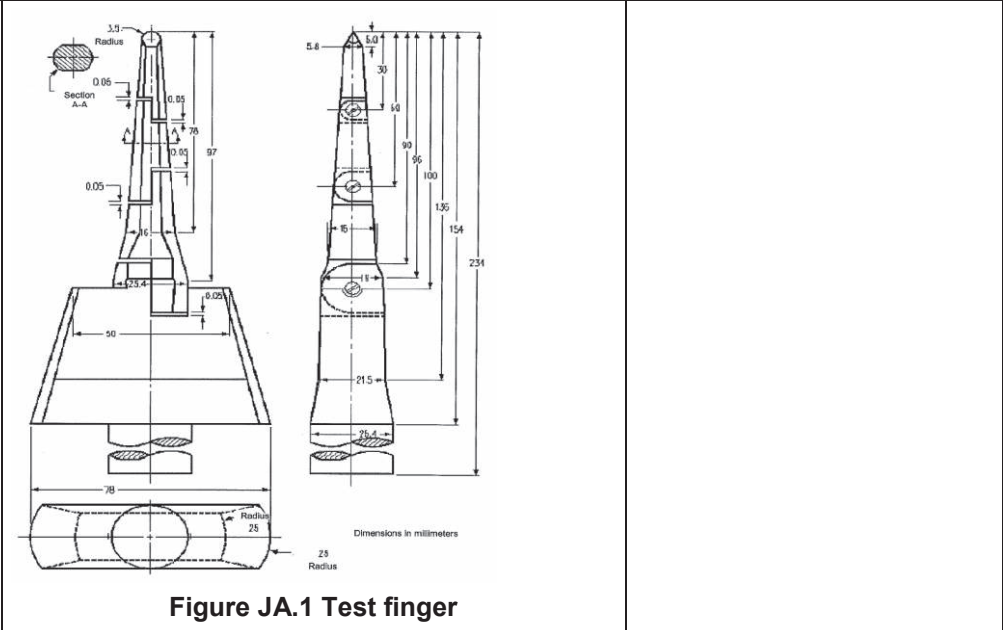

N/A

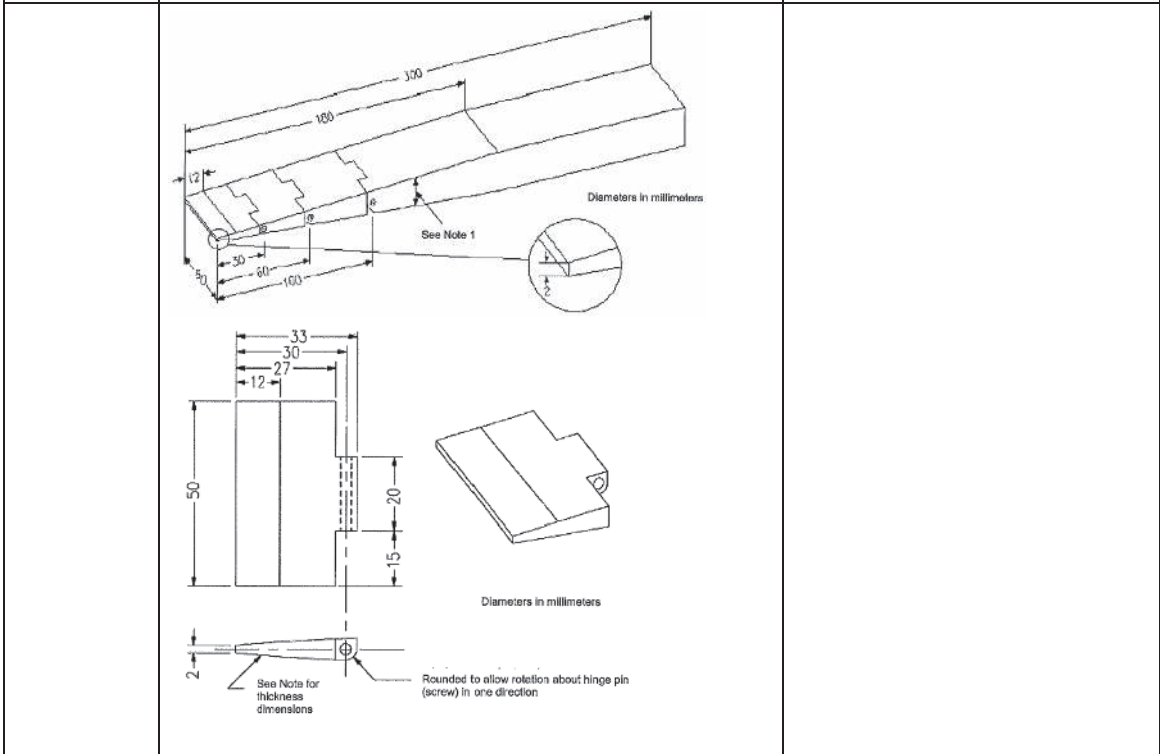

N/A

Distance from the tip (mm)	Thickness of probe (mm)
----------------------------	-------------------------

IEC60950_1F - ATTACHMENT									
Clause	Requirement + Test	Result - Remark	Verdict						
	<table border="1"> <tr> <td>0</td> <td>2</td> </tr> <tr> <td>12</td> <td>4</td> </tr> <tr> <td>180</td> <td>24</td> </tr> </table> <p>Note 1 - The thickness of the probe varies linearly, with slope changes at the respective points shown in the table.</p> <p>Note 2 –The allowable dimensional tolerance of the probe is;</p> <p style="padding-left: 40px;">for <math>\leq 25</math> mm: +/- 0.13 mm</p> <p style="padding-left: 40px;">for <math>&gt; 25</math> mm: +/- 0.3 mm.</p> <p style="text-align: center;"><b>Figure JA.2 Wedge-probe</b></p>	0	2	12	4	180	24		
0	2								
12	4								
180	24								

National Differences to IEC 60950-1:2005 + A1:2009			
Clause	Requirement + Test	Result - Remark	Verdict

**ATTACHMENT TO TEST REPORT IEC 60950-1  
GERMANY NATIONAL DIFFERENCES**  
Information technology equipment – Safety –  
Part 1: General requirements

**Differences according to**.....: VDE 0805-1:2011-01: EK1-557-13 (2013-07)

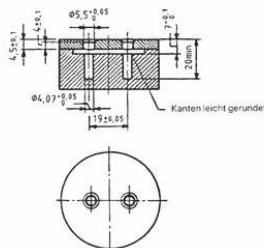
1.5	<p>Bei Steckernetzteilen wird der angeformte Stecker als Komponente betrachtet und in Deutschland generell nach DIN VDE 0620-1:2010 bzw. DIN VDE 0620-1:2013 und DIN VDE 0620-2-1:2013 beurteilt.</p> <p>Nach der Prüfung gemäß DIN VDE 0620-2-1:2013, Abschnitt 24.2 muss der Stecker noch die Prüfung entsprechend DIN VDE 0620-101:1992 Abschnitt 7 Bild 2 „Lehre für die Auswechselbarkeit“ bestehen.</p> <p>Es muss möglich sein, die Stecker in die Lehre ohne übermäßige Kraft so einzuführen, dass ihre Stirnfläche die Oberfläche der Lehre berührt.</p> <p>The moulded plug of plug-in power supplies will be considered as component and will be generally evaluated in Germany according to DIN VDE 0620-1:2010 respectively DIN VDE 0620-1:2013 and DIN VDE 0620-2-1:2013</p> <p>After the test according to DIN VDE 0620-2-1:2013, sub-clause 24.2, the plug be shall still pass the test according to DIN VDE 0620-101:1992 clause 7, figure 2 “Gauge for interchangeability”</p> <p>It should be possible to insert the plug without applying an excessive force such that the end surface touches the surface of the gauge</p> 	Not direct plug-in equipment.	N/A
Annex ZC, 1.7.2.1	<p>According to GPSG, section 2, clause 4: If certain rules on the use, supplementation or maintenance of an item of technical work equipment or ready-to-use commodity must be observed in order to guarantee safety and health, instructions for use in German must be supplied when it is brought into circulation.</p>	The requirements have to be checked during the national approval.	N/A

National Differences to IEC 60950-1:2005 + A1:2009			
Clause	Requirement + Test	Result - Remark	Verdict

<p><b>ATTACHMENT TO TEST REPORT IEC 60950-1</b>  <b>ISRAEL NATIONAL DIFFERENCES</b>          Information technology equipment – Safety –          Part 1: General requirements</p> <p><b>Differences according to.....: SI 60950 Part 1</b></p>
---

1.1.1	Replace the the text of Note 3 as follows: The requirements of Israel Standard SI 60065 may also be used to meet safety requirements for multimedia equipment. See IEC Guide 112, Guide on the safety of multimedia equipment.	Replaced.	N/A
1.6	The clause is applicable with the following addition:		N/A
1.6.1	Add following note: In Israel, this clause is applicable subject to the Electricity Law, 1954, its regulations and revisions.	Added.	N/A
1.7	The clause is applicable with the following additions: Subclause 1.7.201 shall be added at the beginning of the clause as follows:	Added.	N/A
1.7.201	Marking in the Hebrew language The marking in the Hebrew language shall be in accordance with the Consumer Protection Order (Marking of goods), 1983. In addition to the marking required by clause 1.7.1, the following details shall be marked in the Hebrew language. The details shall be marked on the apparatus or on its package, or on a label properly attached to the apparatus or on the package, by bonding or sewing, in a manner that the label cannot be easily removed. 1. Name of the apparatus and it commercial designation; 2. Manufacturer's name and address. If the apparatus is imported, the importer's name and address; 3. Manufacturer's registered trademark, if any; 4. Name of the model and serial number, if any; 5. Country of manufacture.		N/A
1.7.2.1	The following shall be added to the clause: All the instructions and warnings related to safety shall also be written in the Hebrew language.	Added.	N/A

Disclaimer: This document is controlled and has been released electronically.  
Only the version on the IECEE Website is the current document version

National Differences to IEC 60950-1:2005 + A1:2009			
Clause	Requirement + Test	Result - Remark	Verdict
2	The clause is applicable with the following additions:	Added.	P
2.9.4	The following shall be added at the beginning of the clause: In Israel, according to the Electricity Law, 1954, and the Electricity Regulations (Earthing and means of protection against electricity of voltages up to 1,000V) 1991, seven means of protection against electrocution are permitted, as follows: 1) TN-S - Network system earthing; TN-C-S - Network system earthing; 2) TT - Network system earthing; 3) IT - Network Insulation Terre; 4) Isolated transformer; 5) Safety extra low voltage (SELV or ELV); 6) Residual current circuit breaker (30 mA = I $\Delta$ ); 7) Reinforced insulation; Double insulation (class II)	Added.	P
2.201	Prevention of electromagnetic interference - Prior to carrying out the tests in accordance with the clauses of this Standard, the compliance of the apparatus with the relevant requirements specified in the appropriate part of the Standard series, SI 961, shall be checked. <u>The apparatus shall meet the requirements in the appropriate part of the Standard series, SI 961.</u> - If there are components in the apparatus for the prevention of electromagnetic interference, these components shall not reduce the safety level of the apparatus as required by this Standard.	Added.	N/A
3	The clause is applicable with the following additions:	Added.	N/A
3.2.1.1	Connection to an a.c. mains supply After the note, the following note shall be added: Note: In Israel, the feed plug shall comply with the requirements of Israel Standard SI 32 Part 1.1.	Added.	N/A
3.2.1.2	Connection to a d.c. mains supply At the end of the first paragraph, the following note shall be added: Note: At the time of issue of this Standard, there is no	Added.	N/A



National Differences to IEC 60950-1:2005 + A1:2009			
Clause	Requirement + Test	Result - Remark	Verdict
	Israel Standard for connection accessories to d.c.		
Annex P	Normative references (List of relevant Israel Standards that have been inserted in place of some of the International Standards)	Added.	N/A



National Differences to IEC 60950-1:2005 + A1:2009			
Clause	Requirement + Test	Result - Remark	Verdict

<p><b>ATTACHMENT TO TEST REPORT IEC 60950-1</b>  <b>KOREA NATIONAL DIFFERENCES</b>                  Information technology equipment – Safety –                  Part 1: General requirements</p>
<p><b>Differences according to.....: K 60950-1</b></p>



1.5.101	Plugs for the connection of the apparatus to the supply mains shall comply with the Korean requirement (KSC 8305)	No plug provided.	N/A
8	EMC The apparatus shall comply with the relevant CISPR standards.	The requirements have to be checked during the national approval.	N/A

National Differences to IEC 60950-1:2005			
Clause	Requirement + Test	Result - Remark	Verdict
<b>ATTACHMENT TO TEST REPORT IEC 60950-1</b> <b>CHINA NATIONAL DIFFERENCES</b> Information technology equipment – Safety – Part 1: General requirements			
Differences according to.....: GB4943.1-2011			
1.5. 2	Add a note behind the first dashed paragraph. Note: A component used shall comply with related requirements corresponding altitude of 5000m.	Added.	P
1.7	Add a paragraph before the last paragraph: The required marking and instruction should be given in normative Chinese unless otherwise specified.	The marking text and instruction must be provided when marketed in China.	N/A
1.7.1	Amend dashed paragraph at the fifth paragraph : The RATED VOLTAGE should be 220V (single phase) or 380V (three-phases) for single rated voltage, for RATED VOLTAGE RANGE, it should cover 220V or 380V (three-phases), for multiple RATED VOLTAGES, one of them should be 220V or 380V (three-phases) and set on 220V or 380V (three-phases) when manufactured. And the RATED FREQUENCY or RATED FREQUENCY RANGE should be 50Hz or include 50Hz.		P
1.7.2.1	Add requirements of warning for equipment intended to be used at altitude not exceeding 2000m or at non-tropical climate regions: For equipment intended to be used at altitude not exceeding 2000m, a warning label containing the following or a similar appropriate wording, or a symbol as in annex DD shall fixed to the equipment at readily visible place. "Only used at altitude not exceeding 2000m."  For equipment intended to be used in not-tropical climate regions, a warning label containing the following or a similar appropriate wording, or a symbol as in annex DD shall fixed to the equipment at readily visible place. "Only used in not-tropical climate regions."	Added. The requirements of warning must be checked when marketed in China.	N/A



National Differences to IEC 60950-1:2005			
Clause	Requirement + Test	Result - Remark	Verdict
	 <p>If only the symbol used, the explanation of the symbol shall be contained in the instruction manual. The above statements shall be given in a language acceptable to the regions where the apparatus is intended to be used.</p>		
2.7.1	<p>Amended the first paragraph as: Protection in PRIMARY CIRCUITS against overcurrent short-circuits and earth faults shall be provided as an integral part of the equipment except special provisions. And the protective device shall meet the requirement of Clause 5.3. Delete note of Clause 2.7.1.</p>		P
2.9	<p>Humidity conditioning This section applies for equipment to be operated at tropical climatic conditions, humidity conditioning dealt with tropical climatic conditions. For equipment not to be operated at tropical climatic conditions, its humidity conditioning complies with rules of CTL 624/07.</p>	Considered.	P
2.9.2	<p>First section of Clause 2.9.2 amended as two sections: Where required by 2.9.1, 2.10.8.3, 2.10.10 or 2.10.11, humidity conditioning is conducted for 120 h in a cabinet or room containing air with ambient temperature <math>40\pm 2^{\circ}\text{C}</math> and a relative humidity of <math>(93\pm 3)\%</math>. During this conditioning the component or subassembly is not energized. For equipment not to be operated at tropical climatic conditions, Where required by 2.9.1, 2.10.8.3, 2.10.10 or 2.10.11, humidity conditioning is conducted for 48 h in a cabinet or room containing air with a relative humidity of <math>(93\pm 3)\%</math>. The temperature of the air, at all places where samples can be located, is maintained within <math>2^{\circ}\text{C}</math> of any convenient value between <math>20^{\circ}\text{C}</math> and <math>30^{\circ}\text{C}</math> such that condensation does not occur. Due to pretreatment of equipment operated at high altitude area is humidity conditioning withstand hot shock, specific requirements are to be considered.</p>	Amended. Shall be evaluated during the national approval.	N/A
	<p>Add note: For equipment to be operated at 2000 m - 5000m above sea level, assessment and</p>	Added.	N/A

National Differences to IEC 60950-1:2005			
Clause	Requirement + Test	Result - Remark	Verdict
	requirement of humidity conditioning for Insulation material properties are considered.		
2.10.3.1	Amend the third paragraph of Clause 2.10.3.1 to be: These requirements apply for equipment to be operated up to 2000 m above sea level. For equipment to be operated at more than 2000 m above sea level and up to 5000m above sea level, the minimum CLEARANCE shall be multiplied by the factor 1.48 corresponding altitude of 5000m given in Table A.2 of IEC 60664-1. For equipment to be operated at more than 5000 m above sea level, the minimum CLEARANCE shall be multiplied by the factor given in Table A.2 of IEC 60664-1. Linear interpolation is permitted between the nearest two points in Table A.2. The calculated minimum CLEARANCE using this multiplication factor shall be rounded up to the next higher 0,1 mm increment.	Changed. Shall be evaluated during the national approval.	N/A
2.10.3.3& 2.10.3.4	Add "(applicable for altitude up to 2000m)" in header of Table 2K , 2L and 2M.	Added	N/A
2.10.3.4	Add a new section above Table 2K and in Clause 2.10.3.4: Minimum CLEARANCES determined by above rules apply for equipment to be operated up to 2000m above sea level. For equipment operated at 2000 m - 5000m above sea level, the minimum CLEARANCE shall be multiplied by the factor 1.48 corresponding altitude of 5000m given in Table A.2 of GB/T16935.1 ( IEC 60664-1) . For equipment to be operated at more than 5000 m above sea level, the minimum CLEARANCE shall be multiplied by the factor given in Table A.2 of GB/T16935.1.	Added. Shall be evaluated during the national approval.	N/A
3.2.1.1	Add a paragraph before the last paragraph: Plugs connected to AC mains supply shall comply with GB 1002 or GB 1003 or GB/T 11918 as applicable.		N/A
4.2.8	Clause 4.2.8 cathode ray tubes quoted Clause 18 of GB8898-2011. Delete note of Clause 4.2.8.	Deleted. No cathode ray tubes provided.	N/A
Annex E	Amend last section: For comparison of winding temperatures determined by the resistance method of this annex	Amended.	N/A

National Differences to IEC 60950-1:2005			
Clause	Requirement + Test	Result - Remark	Verdict
	with the temperature limits of Table 4B, 35 °C shall be added to the calculated temperature rise. Add note: for equipment not to be operated at tropical climatic conditions, 25 °C shall be added to the calculated temperature rise to compare with the temperature of Table 4B.	Added.	
Annex G.6	Change the second section of Clause G.6 to be: For equipment to be operated at 2000 m - 5000m above sea level, the minimum CLEARANCE shall be multiplied by the factor 1.48 corresponding altitude of 5000m given in Table A.2 of GB/T16935.1. For equipment to be operated at more than 5000 m above sea level, the minimum CLEARANCE shall be multiplied by the factor given in Table A.2 of IEC 60664-1. Linear interpolation is permitted between the nearest two points in Table A.2. The calculated minimum CLEARANCE using this multiplication factor shall be rounded up to the next higher 0,1 mm increment.	Changed. Shall be evaluated during the national approval.	N/A
Annex BB	Amended as : The differences between Chinese national standards GB 4943.1-2011 and GB 4943-2001.	Amended.	P
Annex DD (normative)	Added annex DD: Instructions for the new safety warning labels.  DD.1 Altitude warning label Meaning of the label: Evaluation for apparatus only based on altitude not exceeding 2000m, therefore it's the only operating condition applied for the equipment. There may be some potential safety hazard if the equipment is used at altitude above 2000m.  DD.2 Climate warning label Meaning of the label: Evaluation for apparatus only based on temperate climate condition, therefore it's the only operating condition applied for the equipment. There may be some potential safety hazard if the equipment is used in tropical climate region.	Added. The requirements of warning must be checked when marketed in China.	N/A
Annex EE (informative)	Added annex EE: Illustration relative to safety explanation in normative Chinese, Tibetan, Mongolian, Zhuang		N/A

National Differences to IEC 60950-1:2005			
Clause	Requirement + Test	Result - Remark	Verdict
	Language and Uighur.		
Other amend-ments	In accordance with the relevant CTL decisions and the amendments of IEC 60950-1, the specific requirements or mistakes in IEC standard are corrected or editorially modified in this part, Including clause 1.7, 2.1.1.7, 2.9.2, Table 2H, Figure 2H, F.8, F.9, M.3 and Annex U.	Amended.	P
Quoting standards and reference documents	<p>The principles of quoting and referring to other standards in Annex P and reference documents of IEC 60950-1 are as follows:</p> <p>If the date of the reference document is given, only that edition applies, excluding any subsequent corrigenda and amendments. However, parties to agreements based on this part are encouraged to investigate the possibility of applying the most recent editions of the reference documents. For undated references, the latest edition of the referenced document applies, including any corrigenda and amendments.</p> <p>For the usage of international standards in Chinese national standards and industry standards is various, in the aim of achieving easy operation and based on the requirements of GB/T 1.1 and GB/T 20000.2, when quoting an entire international standard in the normative quoting files and reference documents of Annex P of this part, the principles of quotation are as follows:</p> <ul style="list-style-type: none"> <li>- If there is no national standard or industry standard corresponding to the international standard, then the international standard is quoted;</li> <li>- If there is national standard or industry standard corresponding to the international standard, then either the national or industry standard is quoted;</li> <li>- If the date of the national standard or industry standard is not given, the latest edition of the standard applies;</li> <li>- The national standard or industry standard number, corresponding international standard number and the consistency level code should be identified in parentheses behind the listed national standard or industry standard.</li> </ul> <p>When quoting several chapters or clauses of the international standard, the principles of quotation are as follows:</p> <ul style="list-style-type: none"> <li>- If there is no national standard or industry standard corresponding to the international</li> </ul>	Considered.	P

National Differences to IEC 60950-1:2005			
Clause	Requirement + Test	Result - Remark	Verdict
	<p>standard, then the international standard is quoted; - If there is national standard or industry standard corresponding to the international standard, then either the national or industry standard is quoted. Meanwhile, in order to retain the relevant information on international standards, informative annex CC is increased, which gives the table about the comparison of the normative quoting files and reference documents in IEC 60950-1: 2005.</p>		
	<b>Special national conditions</b>		
1.1.2	<p>GB4943.1-2011 applies to equipment used at altitudes not exceeding 5000m above sea level, primarily in regions with moderate or tropical climates. Revise the third dashed paragraph of 1.1.2 as: —equipment intended to be used in vehicles, on board ships or aircraft, at altitudes greater than 5000m;</p>	Revised. Shall be evaluated during the national approval.	N/A
1.4.5	<p>Amend the second paragraph by the following: If the equipment is intended for direct connection to an AC mains supply, the tolerances on RATED VOLTAGE shall be taken as +10% and -10%.</p>		N/A
1.4.12.1	<p>T<sub>ma</sub>: The maximum ambient temperature permitted by the manufacturer's specification, or 35 °C, whichever is greater.</p>	Amended. Shall be evaluated during the national approval.	N/A
	<p>Add note 1: For equipment not to be operated at tropical climatic conditions, T<sub>ma</sub> is the maximum ambient temperature permitted by the manufacturer's specification, or 25 °C, whichever is greater.</p>	Added.	N/A
	<p>Add note 2: For equipment to be operated at 2000m-5000m above sea level, its temperature test conditions and temperature limits are under consideration.</p>	Added.	N/A

National Differences to IEC 60950-1:2005			
Clause	Requirement + Test	Result - Remark	Verdict
Appendix	Appendix 12, J3000(H25) Special National conditions, National deviation and other information according to MITI Ordinance No. 85.		—
1	General requirement When equipment provides with appliance inlet complying with JIS C 8283-1(2008), soldered parts of appliance inlet is not applied by force during insert or removal of connector. This is not applied when inlet body is fixed itself and not fixed by solder.	Inlet is fixed by adequate mechanical construction, not rely on soldering.	P
2	Requirement for equipment		—
2.1	Heater Appliances When diode is used in parallel for adjustment of power, the equipment shall remain safe for operation under open condition of one diode.	Not electric stove.	N/A
	The current rating of one diode shall be more than main current. The diodes connected in parallel are same type.		N/A
	The heating test specified by clause 11 of JIS C 9335-2-30(2006) under open condition of one diode shall comply with the requirements.		N/A
2.2	Electric heater with glowing heating elements	Not electric stove.	N/A
	Surface treatment by paint or adhesive on protective frame or protective mesh shall not be used.		N/A
	Caution marking like below shall be on - easily visible place of the equipment or - Instruction manual 「注意 当該機器から、使用初期段階で揮発性有機化合物及びカルボニル化合物が最も放散するおそれがあるため、その際には十分換気を行うこと。」		N/A
3	Components used in equipment	No such equipment /components.	N/A

National Differences to IEC 60950-1:2005			
Clause	Requirement + Test	Result - Remark	Verdict
3.1	Motor capacitors used in ventilating fan, electric fan, air conditioner, electric washing machine, refrigerator or electric freezer shall be comply with <ul style="list-style-type: none"> <li>- capacitors with protective elements or protective mechanism complying with JIS C 4908(2007)</li> <li>- P2 capacitor complying with IEC 60252-1(2001)</li> </ul> Capacitor complying with below is acceptable		N/A
	Enclosed by metal or ceramic		N/A
	No non-metallic materials within 50 mm from capacitor surface		N/A
	Non-metallic material within 50 mm from capacitor surface comply with needle frame test of JIS C 9335-1(2003), Annex E		N/A
	Non-metallic material within 50 mm from capacitor surface comply with V-1 test of JIS C 60965-11-10(2006).		N/A
3.2	Plug directly inserted to outlet used refrigerator or electric freezer. Shall comply with <ul style="list-style-type: none"> <li>- Face contact with outlet shall have CTI with more than 400 according to JIS C 2134(2007) or</li> <li>- Supporting material of blades shall comply with glow wire test by temperature of 750°C according to JIS C 60695-2-11(2004) or JIS C 60695-2-12(2004).</li> </ul> Materials having glow wire frame temperature of 775 °C are acceptable.		N/A

IEC 60950-1			
Clause	Requirement + Test	Result - Remark	Verdict

2.1.1.7	TABLE: discharge test			P
Condition	$\tau$ calculated (s)	$\tau$ measured (s)	t u→ 0V (s)	Comments
System on (with fuse in, L-N)	--	0.20	--	Vo=375Vpk, 37% of Vo=138V. Input voltage: 264V/60Hz.
<b>Supplementary information:</b> Overall capacity: C9901=0.47 $\mu$ F; Discharge resistor: R9165=1k $\Omega$ , Approved discharge IC U9104				

2.4.2	TABLE: limited current circuit measurement					P
Location	Voltage (V)	Current (mA)	Freq. (kHz)	Limit (mA)	Comments	
C913, C9818	--	0.315	--	--	--	
<b>Supplementary information:</b> See table 1.5.1 for capacity. Input Voltage is 264Vac, 60Hz. Test with figure D.1.						

2.6.3.4	TABLE: ground continue test		P
Location	Resistance measured (m $\Omega$ )	Comments	
PE terminal of AC inlet to internal metal enclosure	6	Test with 32A, 2 minutes	
PE terminal of AC inlet to internal metal enclosure	6	Test with 40A, 2 minutes	
PE terminal of AC inlet to C9915/ C9916 trace	8	Test with 32A, 2 minutes	
PE terminal of AC inlet to C9915/ C9916 trace	8	Test with 40A, 2 minutes	
PE terminal of AC inlet to C9917/ C9919 trace	8	Test with 32A, 2 minutes	
PE terminal of AC inlet to C9917/ C9919 trace	8	Test with 40A, 2 minutes	
<b>Supplementary information:</b>			

4.6.1 and 4.6.2	Table: enclosure openings		P
Location	Size (mm)	Comments	
<b>External plastic enclosure</b>			
Top	Numerous rectangle openings: Max. 15.5mm x 1.8mm	Openings are covered by internal metal enclosure.	
Rear	No opening.	--	



IEC 60950-1			
Clause	Requirement + Test	Result - Remark	Verdict
Left	No opening.	--	
Right	No opening.	--	
Bottom	--	--	
<b>Internal metal enclosure</b>			
Top	1. Numerous circle openings: $\varnothing$ 4.7mm; 2. One rectangle openings above power board: Max.55.0mm x 0.8mm	1. Openings do not exceed 5mm in any dimension. No hazards. 2. Width of opening do not exceed 1.0mm. No hazards.	
Rear	--	V-0 Mylar sheet was used for fire barrier around power board. All openings are covered by Mylar sheet inside.	
Left	Numerous rectangle openings above power board: Max.54.0mm x 23.4mm	The opening is covered by V-1 Mylar sheet. No hazards.	
Right	1. One rectangle openings above power board: Max.61.0mm x 18.8mm; 2. Numerous circle openings: $\varnothing$ 4.7mm	Main board is supplied by L.P.S. No hazards.	
Bottom	1. Numerous $\varnothing$ 1.7mm holes; spacing of holes (centre to centre): 6.0 mm; thickness of metal: min.0.81mm 2. Numerous rectangle openings above power board: Max.46.0mm x 4.0mm	1. Metal enclosure is considered to satisfy the requirement of fire enclosure opening. No hazards. 2. V-0 Mylar sheet was used for fire barrier around power board. All openings are covered by Mylar sheet mentioned above.	
Note(s):			

Type Designation: 34G2, 34G2X, \*\*34G2\*\*\*\*\* (\* can be 0-9, A-Z, a-z, -, \, /, + or blank, represent different enclosure colour for marketing purpose)

Report Number: 50298194 001



Figure 1. Front view



Figure 2. Rear view

Type Designation: 34G2, 34G2X, \*\*34G2\*\*\*\*\* (\* can be 0-9, A-Z, a-z, -, \, /, + or blank, represent different enclosure colour for marketing purpose)

Report Number: 50298194 001

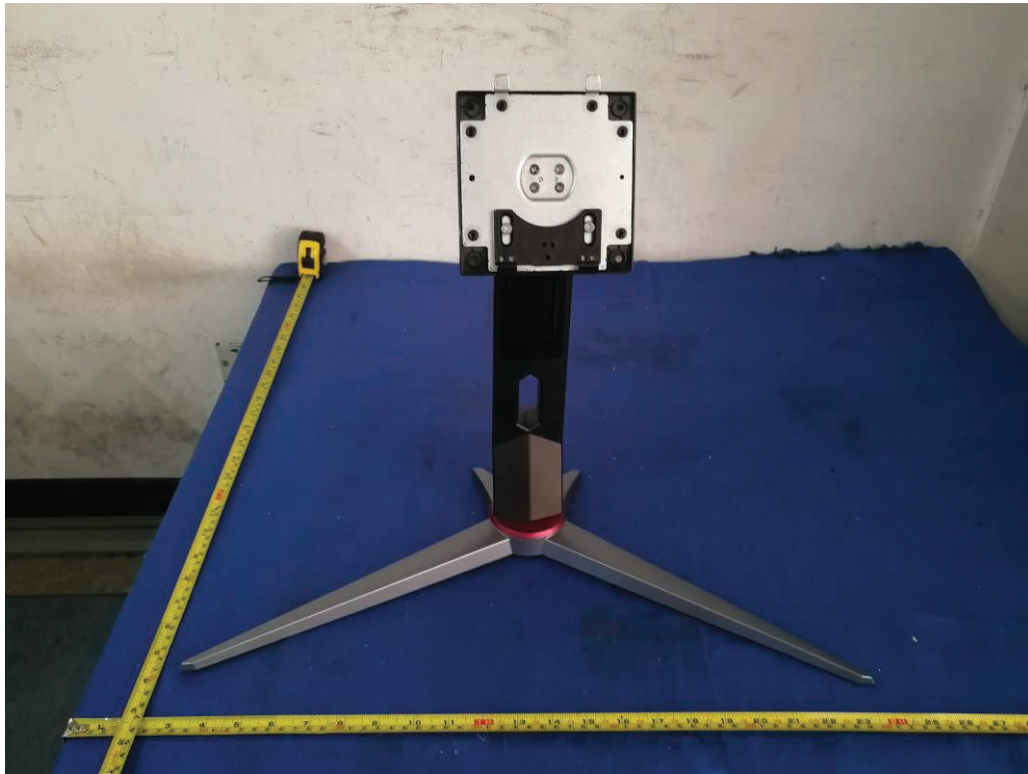

Figure 3. Base stand

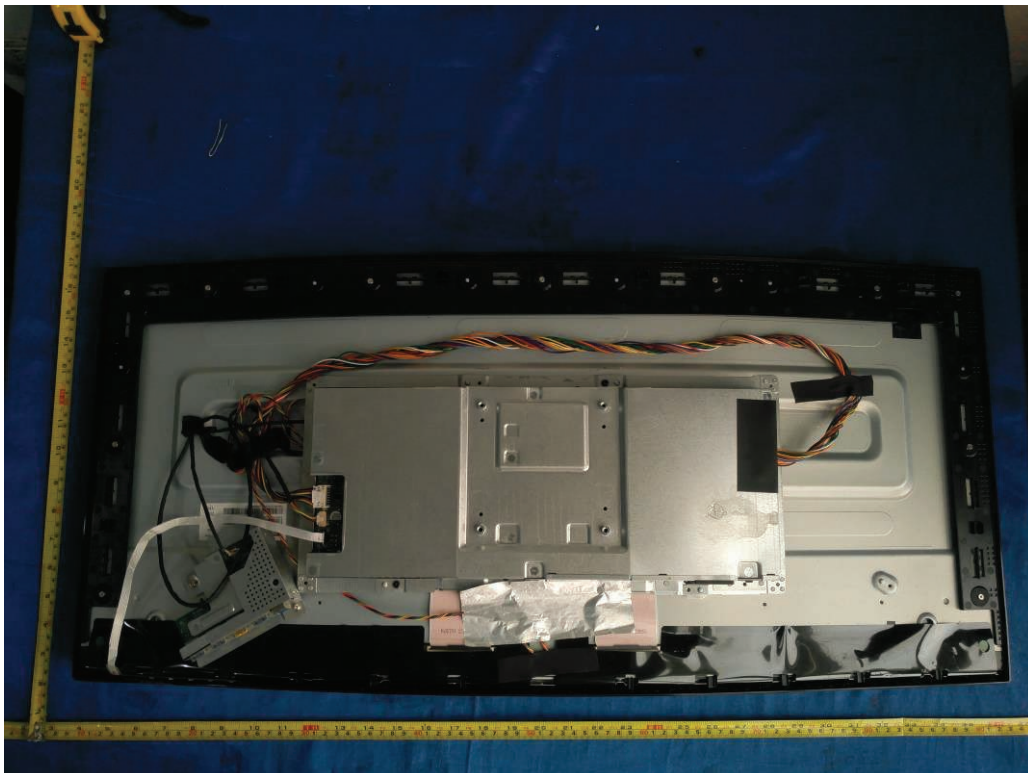

Figure 4. Metal enclosure

Type Designation: 34G2, 34G2X, \*\*34G2\*\*\*\*\* (\* can be 0-9, A-Z, a-z, -, \, /, + or blank, represent different enclosure colour for marketing purpose)

Report Number: 50298194 001

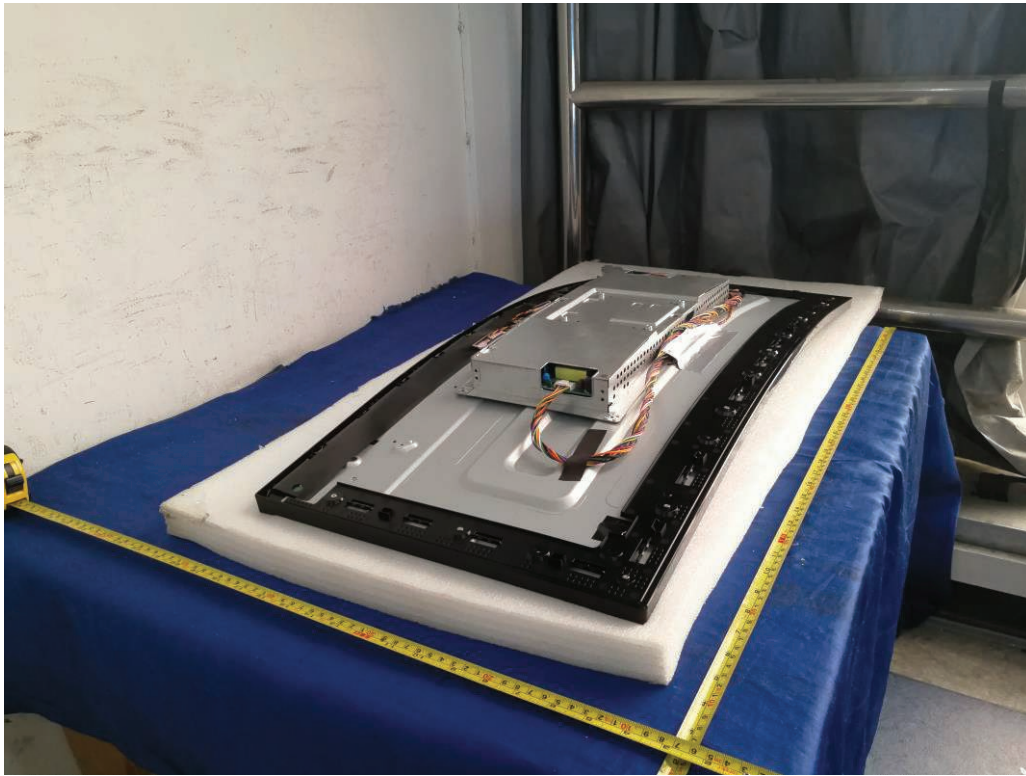

Figure 5. Metal enclosure

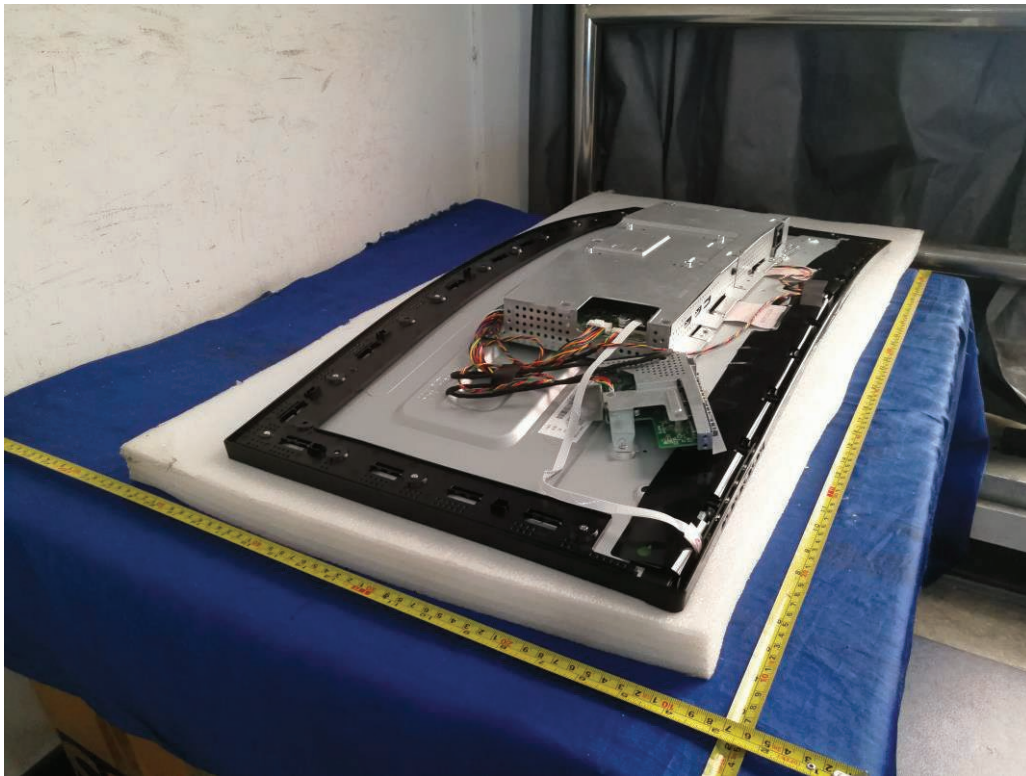

Figure 6. Metal enclosure

Type Designation: 34G2, 34G2X, \*\*34G2\*\*\*\*\* (\* can be 0-9, A-Z, a-z, -, \, /, + or blank, represent different enclosure colour for marketing purpose)

Report Number: 50298194 001

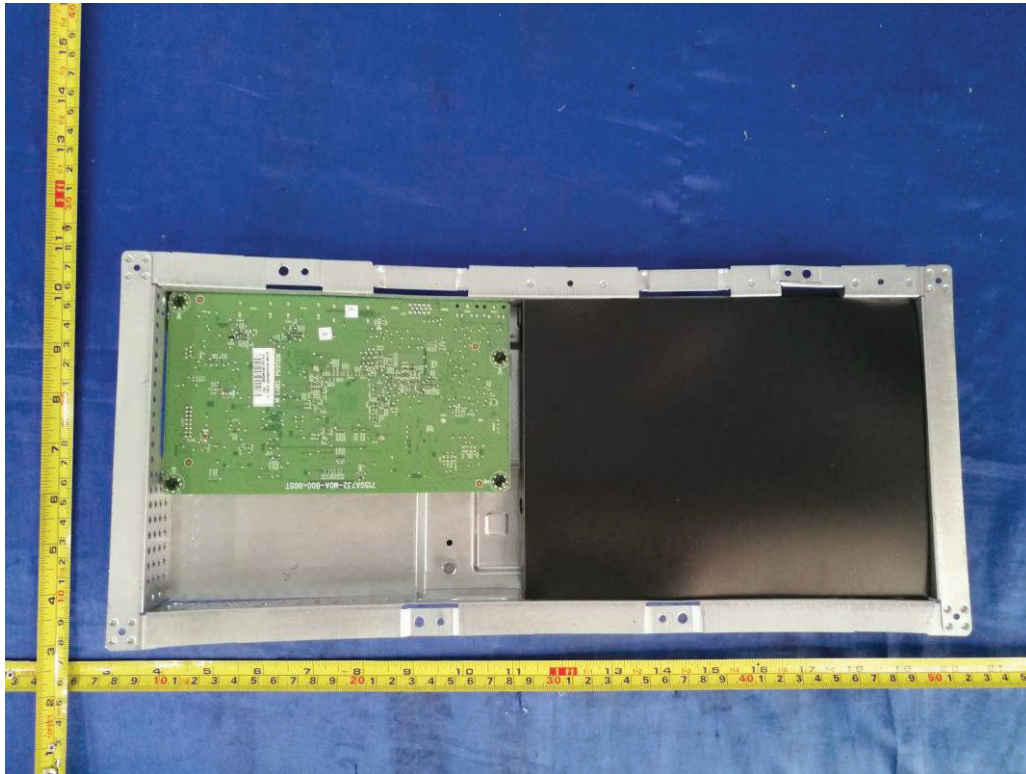

Figure 7. Internal view

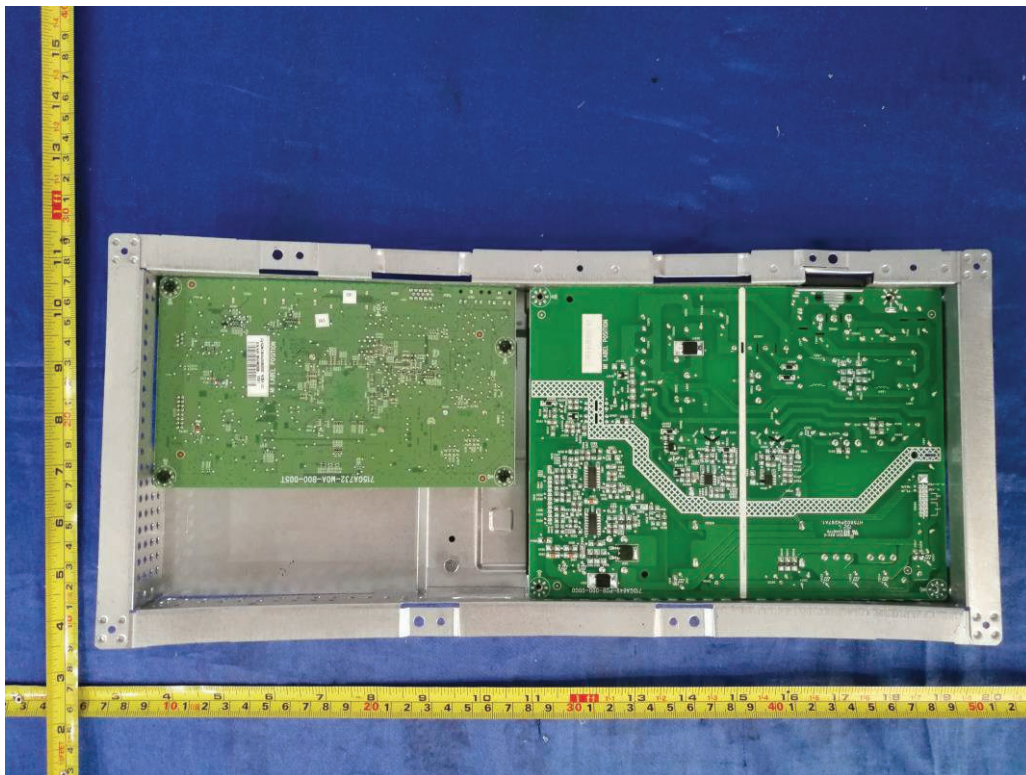

Figure 8. Internal view

Type Designation: 34G2, 34G2X, \*\*34G2\*\*\*\*\* (\* can be 0-9, A-Z, a-z, -, \, /, + or blank, represent different enclosure colour for marketing purpose)

Report Number: 50298194 001

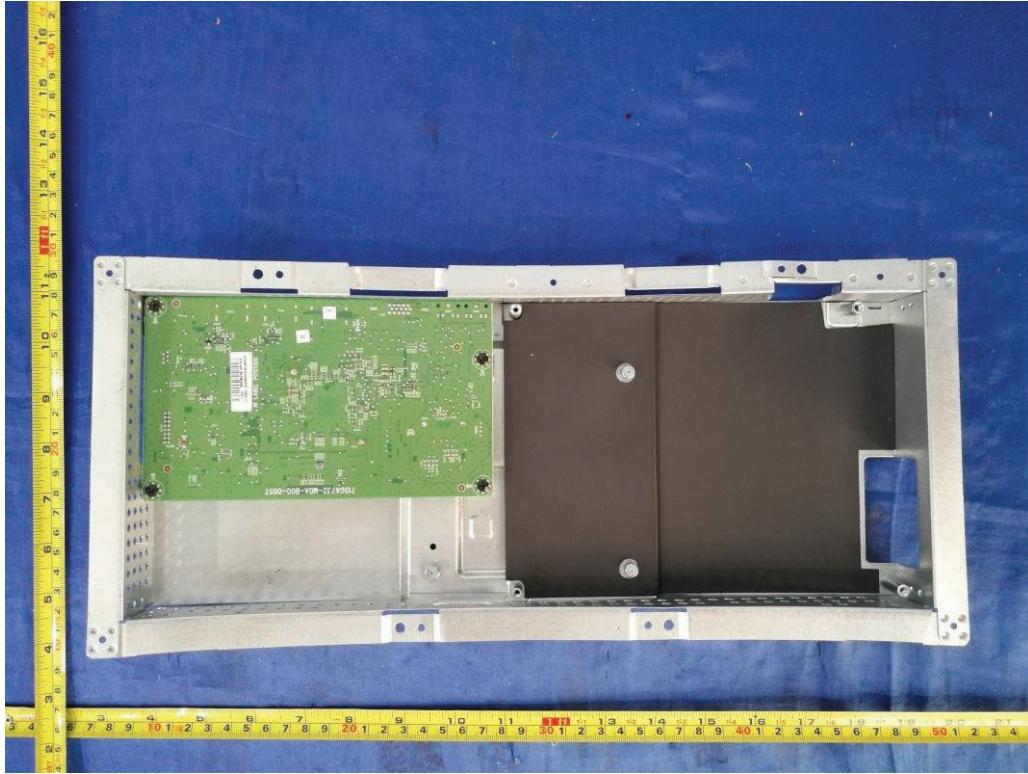

Figure 9. Internal view after remove power board

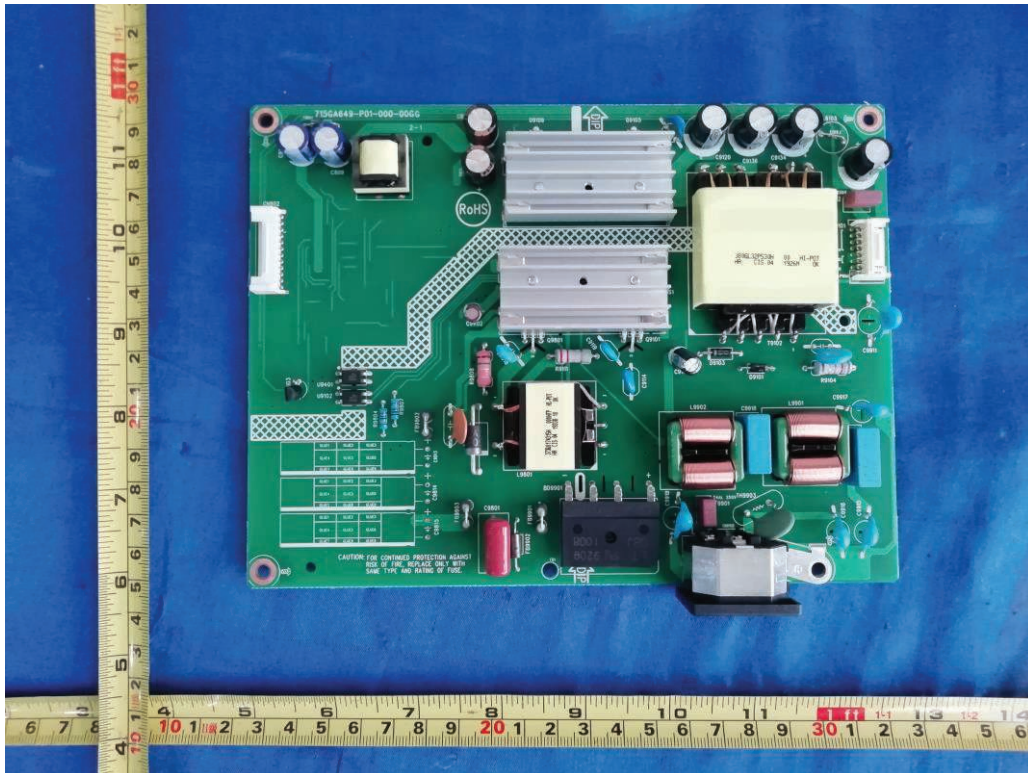

Figure 10. Power board 715GA649

Type Designation: 34G2, 34G2X, \*\*34G2\*\*\*\*\* (\* can be 0-9, A-Z, a-z, -, \, /, + or blank, represent different enclosure colour for marketing purpose)

Report Number: 50298194 001

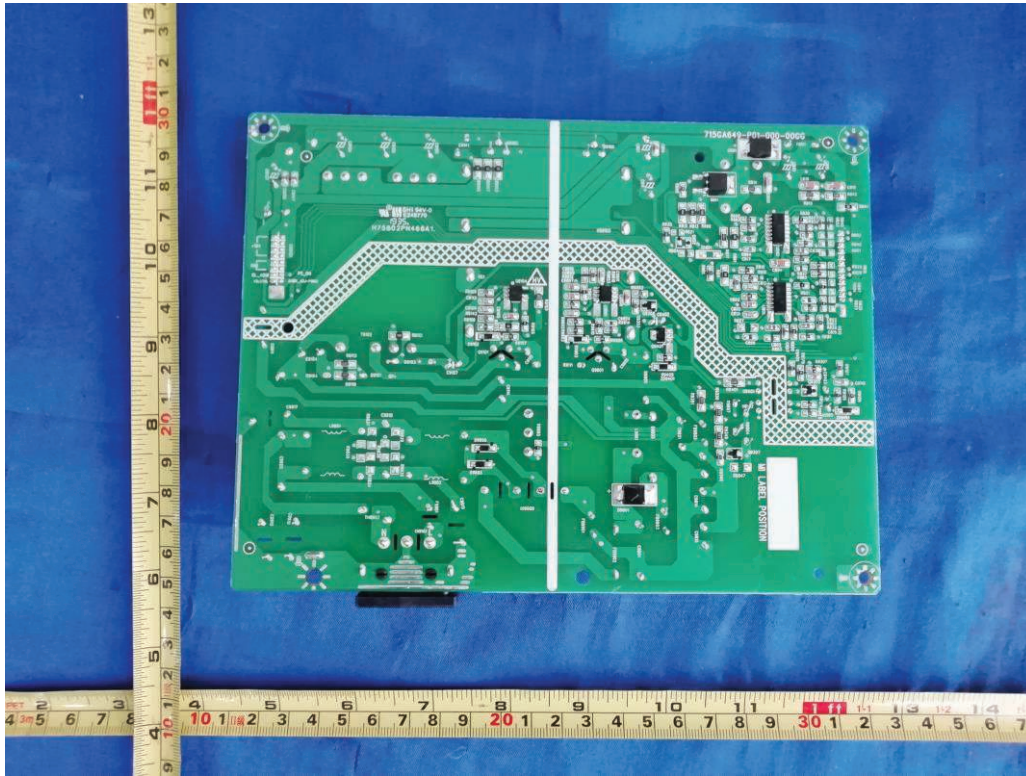

Figure 11. Power board 715GA649

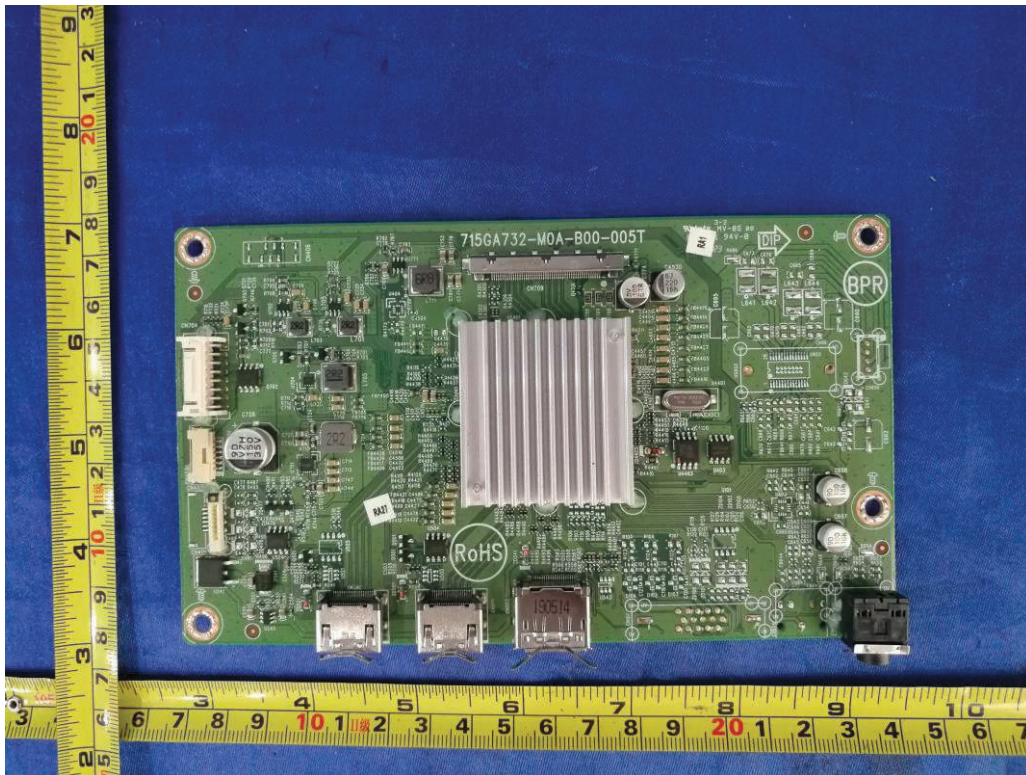

Figure 12. Main board 715GA732

Type Designation: 34G2, 34G2X, \*\*34G2\*\*\*\*\* (\* can be 0-9, A-Z, a-z, -, /, + or blank, represent different enclosure colour for marketing purpose)

Report Number: 50298194 001

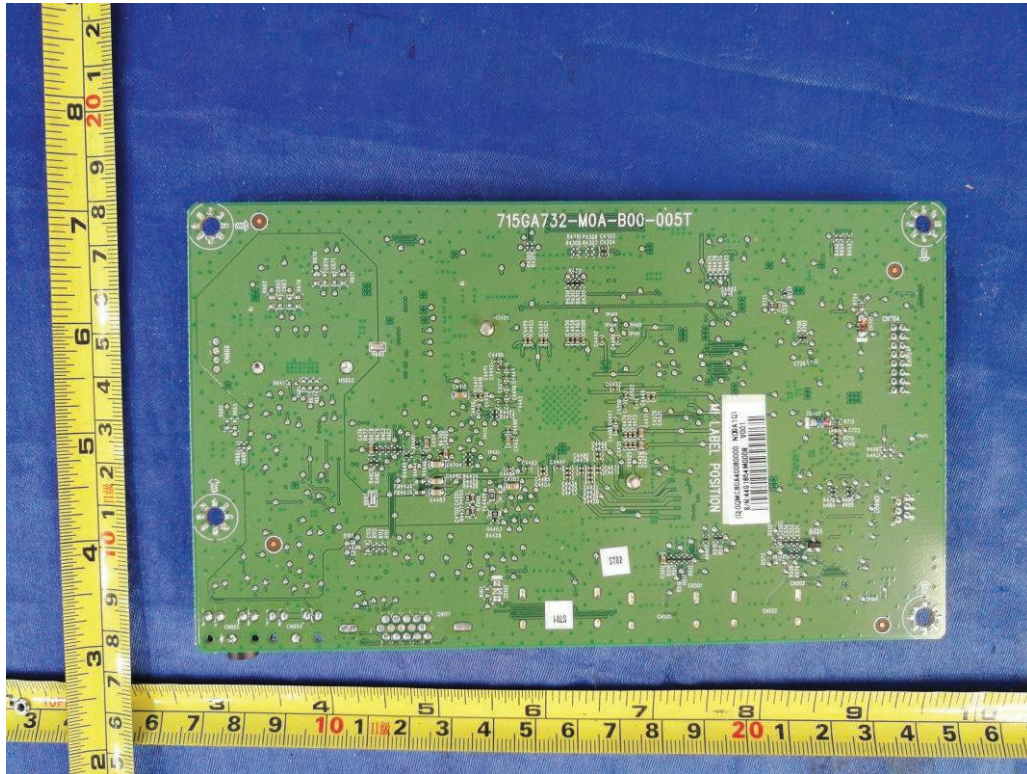

Figure 13. Main board 715GA732

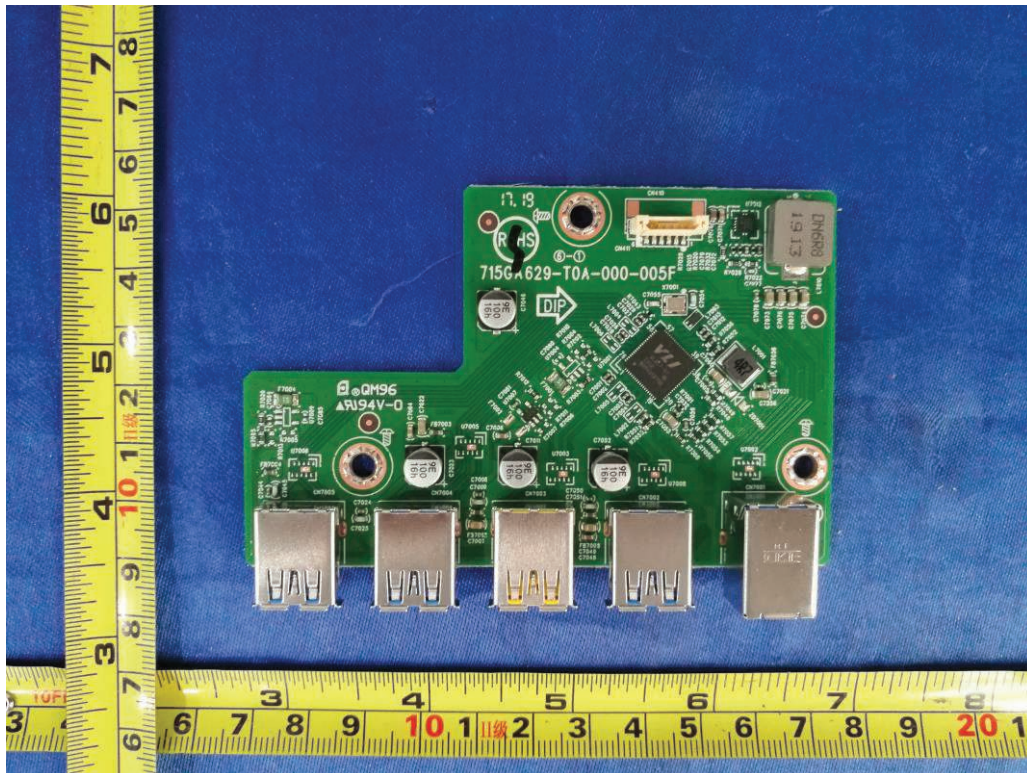

Figure 14. Extend USB board 715GA629



Type Designation: 34G2, 34G2X, \*\*34G2\*\*\*\*\* (\* can be 0-9, A-Z, a-z, -, \, /, + or blank, represent different enclosure colour for marketing purpose)

Report Number: 50298194 001

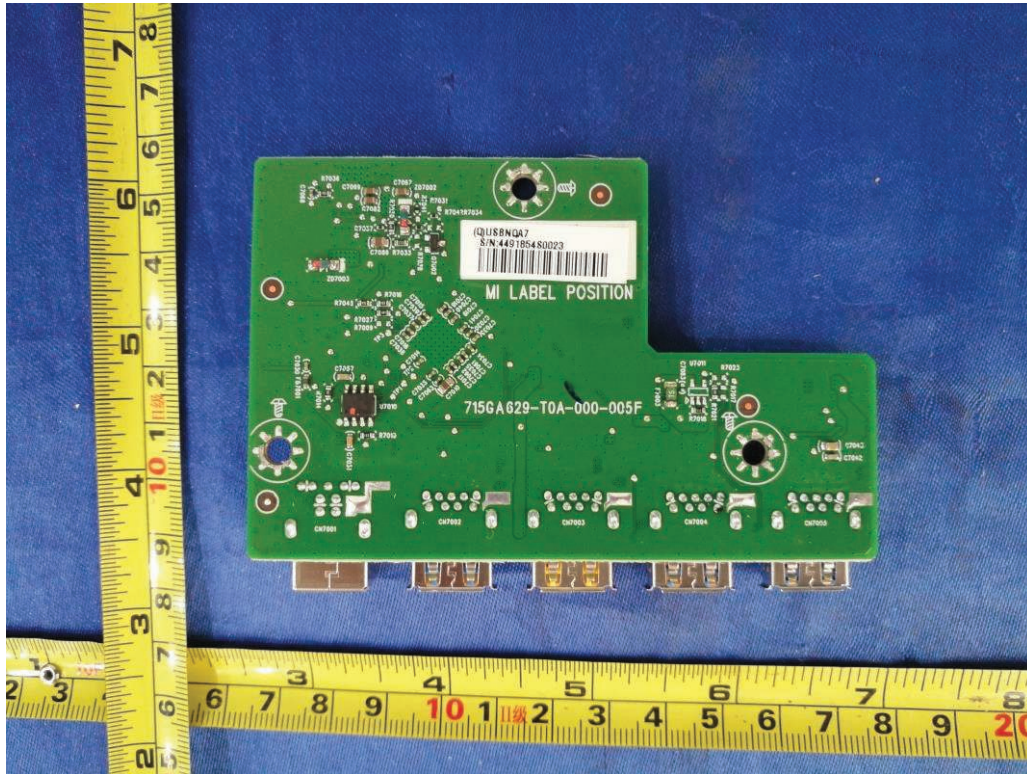

Figure 15. Extend USB board 715GA629