

FCC& ISED EMC Test Report

Project No. : 1801C226
Equipment : LCD Monitor
Model Name : (1)24E1Q, (2)24E1, (3)**24*****(*=A-Z,a-z,0-9,/,,or blank)
Applicant : TPV Electronics (Fujian) Co., Ltd.
Address : Rongqiao Economic and Technological Development Zone, Fuqing City, Fujian Province, P.R. China

Date of Receipt : Jan. 30, 2018
Date of Test : Jan. 30, 2018 ~ Feb. 12, 2018
Issued Date : Apr. 23, 2018
Tested by : BTL Inc.

Testing Engineer : Kang Zhang
(Kang Zhang)
Technical Manager : Bill Zhang
(Bill Zhang)
Authorized Signatory : Kevin Li
(Kevin Li)

B T L I N C .

No.3, Jinshagang 1st Road, Shixia, Dalang Town, Dongguan, Guangdong, China.

TEL: +86-769-8318-3000 FAX: +86-769-8319-6000



Declaration

BTL represents to the client that testing is done in accordance with standard procedures as applicable and that test instruments used has been calibrated with standards traceable to international standard(s) and/or national standard(s).

BTL's reports apply only to the specific samples tested under conditions. It is manufacture's responsibility to ensure that additional production units of this model are manufactured with the identical electrical and mechanical components. **BTL** shall have no liability for any declarations, inferences or generalizations drawn by the client or others from **BTL** issued reports.

BTL's report must not be used by the client to claim product certification, approval, or endorsement by NVLAP, NIST, or any agency of the Federal Government.

This report is the confidential property of the client. As a mutual protection to the clients, the public and **BTL-self**, extracts from the test report shall not be reproduced except in full with **BTL's** authorized written approval.

BTL's laboratory quality assurance procedures are in compliance with the **ISO Guide 17025** requirements, and accredited by the conformity assessment authorities listed in this test report.

Limitation

For the use of the authority's logo is limited unless the Test Standard(s)/Scope(s)/Item(s) mentioned in this test report is (are) included in the conformity assessment authorities acceptance respective.

Table of Contents	Page
REPORT ISSUED HISTORY	4
1 . CERIFICATION	5
2 . SUMMARY OF TEST RESULTS	6
2.1 TEST FACILITY	7
2.2 MEASUREMENT UNCERTAINTY	7
3 . GENERAL INFORMATION	8
3.1 GENERAL DESCRIPTION OF EUT	8
3.2 DESCRIPTION OF TEST MODES	9
3.3 EUT OPERATING CONDITIONS	10
3.4 BLOCK DIAGRAM SHOWING THE CONFIGURATION OF SYSTEM TESTED	10
3.5 DESCRIPTION OF SUPPORT UNITS	11
4 . EMC EMISSION TEST	12
4.1 CONDUCTED EMISSION MEASUREMENT	12
4.1.1 POWER LINE CONDUCTED EMISSION	12
4.1.2 MEASUREMENT INSTRUMENTS LIST	12
4.1.3 TEST PROCEDURE	13
4.1.4 DEVIATION FROM TEST STANDARD	13
4.1.5 TEST SETUP	13
4.1.6 TEST RESULTS	13
4.2 RADIATED EMISSION MEASUREMENT	24
4.2.1 LIMITS OF RADIATED EMISSION MEASUREMENT	24
4.2.2 MEASUREMENT INSTRUMENTS LIST	25
4.2.3 TEST PROCEDURE	26
4.2.4 DEVIATION FROM TEST STANDARD	26
4.2.5 TEST SETUP	27
4.2.6 TEST RESULTS-BELOW 1GHZ	27
4.2.7 TEST RESULTS-ABOVE 1GHZ	38
5 . EUT TEST PHOTO	49

REPORT ISSUED HISTORY

Issued No.	Description	Issued Date
BTL-FICE-1-1801C226	Original report.	Feb. 26, 2018
MDG1804011	Added model name 24E1.	Apr. 23, 2018

1. CERIFICATION

Equipment : LCD Monitor
Brand Name : N/A
Model Name : (1)24E1Q, (2)24E1, (3)**24*****(*=A-Z,a-z,0-9,/.,or blank)
Applicant : TPV Electronics (Fujian) Co., Ltd.
Date of Test : Jan. 30, 2018 ~ Feb. 12, 2018
Test Sample : Engineering Sample
Standard(s) : FCC Part 15, Subpart B
ICES-003 Issue 6: 2016
ANSI C63.4-2014

The above equipment has been tested and found compliance with the requirement of the relative standards by BTL Inc.

The test data, data evaluation, and equipment configuration contained in our test report (Ref No. BTL-FICE-1-1801C226) were obtained utilizing the test procedures, test instruments, test sites that has been accredited by the Authority of NVLAP according to the ISO-17025 quality assessment standard and technical standard(s).

2. SUMMARY OF TEST RESULTS

Test procedures according to the technical standard(s):

EMC Emission				
Standard(s)	Test Item	Limit	Judgment	Remark
FCC Part15, Subpart B ICES-003 Issue 6: 2016 ANSI C63.4-2014	Conducted Emission	Class B	PASS	
	Radiated emission Below 1 GHz	Class B	PASS	
	Radiated emission Above 1 GHz	Class B	PASS	NOTE(2)

NOTE:

- (1) " N/A" denotes test is not applicable to this device.
- (2) The EUT's max operating frequency is 148.5MHz which does exceed 108 MHz, so the test will be performed.

2.1 TEST FACILITY

The test facilities used to collect the test data in this report at the location of No.3, Jinshagang 1st Road, Shixia, Dalang Town, Dongguan, Guangdong, China.

BTL's test firm number for FCC: 854385

BTL's test firm number for IC: 4428B-3

BTL's test designation number for FCC: CN5020

2.2 MEASUREMENT UNCERTAINTY

Where relevant, the following measurement uncertainty levels have been estimated for tests performed on the EUT as specified in CISPR 16-4-2. The BTL measurement uncertainty is less than the CISPR 16-4-2 U_{cispr} requirement.

The reported uncertainty of measurement $y \pm U$, where expanded uncertainty U is based on a standard uncertainty multiplied by a coverage factor of $k=2$, providing a level of confidence of approximately **95%**.

A. Conducted Measurement :

Test Site	Method	Measurement Frequency Range	U, (dB)
DG-C01	CISPR	150 kHz ~ 30MHz	3.16

B. Radiated Measurement :

Test Site	Method	Measurement Frequency Range	Ant. H / V	U, (dB)
DG-CB08 (3m)	CISPR	30MHz ~ 200MHz	V	4.68
		30MHz ~ 200MHz	H	4.68
		200MHz ~ 1,000MHz	V	4.90
		200MHz ~ 1,000MHz	H	4.90

Test Site	Method	Measurement Frequency Range	U, (dB)
DG-CB08 (3m)	CISPR	1 ~ 6 GHz	4.26
		6 ~18 GHz	5.30

Note: Unless specifically mentioned, the uncertainty of measurement has not been taken into account to declare the compliance or non-compliance to the specification.

3. GENERAL INFORMATION

3.1 GENERAL DESCRIPTION OF EUT

Equipment	LCD Monitor
Brand Name	N/A
Model Name	(1)24E1Q, (2)24E1, (3)**24*****(*=A-Z,a-z,0-9,/ ,or blank)
Model Difference	The market distribution is different only.
Power Source	AC Mains
Power Rating	100-240V~ 50-60Hz 1.5A
Connecting I/O ports	1* HDMI port 1* D-SUB port 1* Display port 1* Earphone port 1* Audio port 1* AC port

Cable Type	Shielded Type	Ferrite Core	Length(m)	Note
D-SUB	Shielded	YES	1.2/1.5/1.8	Bonded two Ferrite Cores
Display	Shielded	NO	1.2/1.5/1.8	
HDMI	Shielded	NO	1.2/1.5/1.8	
Audio	Shielded	NO	1.2/1.5/1.8	
AC Power Cord	Non-shielded	NO	1.2/1.5/1.8	1.8m is worst case Detachable (3 Pin)

Note:

1. For a more detailed features description, please refer to the manufacturer's specifications or the user's manual.
2. Power cable 1.8m, 1.5m and 1.2m length, worst case is Power cable 1.8m with D-SUB+HDMI + Display+Audio 1.8m and 1.5m length testing and recording in test report.

3.2 DESCRIPTION OF TEST MODES

To investigate the maximum EMI emission characteristics generated from EUT, the test system was pre-scanning tested base on the consideration of following EUT operation mode or test configuration mode which possible have effect on EMI emission level. Each of these EUT operation mode(s) or test configuration mode(s) mentioned above was evaluated respectively.

Pretest Mode	Description
Mode 1	D-SUB 1920*1080/60Hz
Mode 2	D-SUB 1280*1024/75Hz
Mode 3	D-SUB 640*480/60Hz
Mode 4	HDMI 1920*1080/60Hz
Mode 5	HDMI 1280*1024/75Hz
Mode 6	HDMI 640*480/60Hz
Mode 7	HDMI 1080P
Mode 8	HDMI 576P
Mode 9	HDMI 480I
Mode 10	Display 1920*1080/60Hz
Mode 11	Display 1280*1024/75Hz
Mode 12	Display 640*480/60Hz

For Conducted Test	
Final Test Mode	Description
Mode 1	D-SUB 1920*1080/60Hz
Mode 4	HDMI 1920*1080/60Hz
Mode 7	HDMI 1080P

For Radiated Test	
Final Test Mode	Description
Mode 1	D-SUB 1920*1080/60Hz
Mode 4	HDMI 1920*1080/60Hz
Mode 7	HDMI 1080P

3.3 EUT OPERATING CONDITIONS

The EUT exercise program used during radiated and/or conducted emission measurement was designed to exercise the various system components in a manner similar to a typical use. The standard test signals and output signal as following:

1. Send "H" pattern to serial port device (Modem).
2. Read (write) from (to) mass storage device.
3. EUT Connected to Earphone via Earphone cable.
4. EUT Connected to PC via D-SUB & HDMI & Display & Audio cable.

As the keyboard and mouse are strictly input devices, no data is transmitted to (from) them during test. They are, however, continuously scanned for data input activity.

3.4 BLOCK DIAGRAM SHOWING THE CONFIGURATION OF SYSTEM TESTED

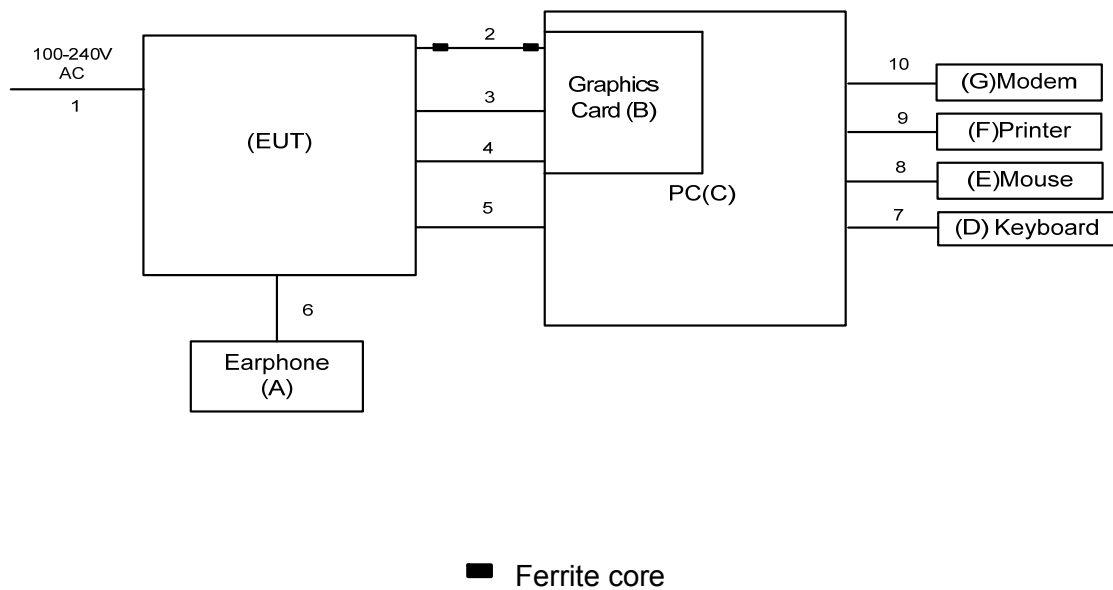

3.5 DESCRIPTION OF SUPPORT UNITS

The EUT has been tested as an independent unit together with other necessary accessories or support units. The following support units or accessories were used to form a representative test configuration during the tests.

Item	Equipment	Mfr/Brand	Model/Type No.	FCC ID	Series No.
A	Earphone	Apple	N/A	VER	N/A
B	Graphics Card	DELL	ATI 3650	DOC	2.60832E+11
C	PC	DELL	Vostro 470	DOC	28747261333
D	USB Keyboard	DELL	KB212-B	DOC	CN0HTXH97158125004DXA01
E	USB Mouse	DELL	MS111-P	DOC	CN011D3V71581279OLOT
F	Printer	SII	DPU-414	DOC	3018507 B
G	Modem	ACEEX	DM-1414V	IFAXDM1414	0603002131

Item	Shielded Type	Ferrite Core	Length	Note
1	NO	NO	1.8m/1.5m/1.2m	AC Cable
2	YES	YES	1.8m/1.5m/1.2m	D-SUB Cable
3	YES	NO	1.8m/1.5m/1.2m	HDMI Cable
4	YES	NO	1.8m/1.5m/1.2m	Display Cable
5	YES	NO	1.8m/1.5m/1.2m	Audio Cable
6	NO	NO	1.2m	Earphone Cable
7	YES	NO	1.8m	USB Cable
8	YES	NO	1.8m	USB Cable
9	YES	NO	1.8m	Parallel Cable
10	YES	NO	1.8m	RS232 Cable

4. EMC EMISSION TEST

4.1 CONDUCTED EMISSION MEASUREMENT

4.1.1 POWER LINE CONDUCTED EMISSION (FREQUENCY RANGE 150KHZ-30MHZ)

FREQUENCY (MHz)	Class A (dBuV)		Class B (dBuV)	
	Quasi-peak	Average	Quasi-peak	Average
0.15 -0.5	79.00	66.00	66 - 56 *	56 - 46 *
0.50 -5.0	73.00	60.00	56.00	46.00
5.0 -30.0	73.00	60.00	60.00	50.00

Note:

- (1) The tighter limit applies at the band edges.
- (2) The limit of " * " marked band means the limitation decreases linearly with the logarithm of the frequency in the range.
- (3) The test result calculated as following:
 Measurement Value = Reading Level + Correct Factor
 Correct Factor = Insertion Loss + Cable Loss + Attenuator Factor(if use)
 Margin Level = Measurement Value - Limit Value

4.1.2 MEASUREMENT INSTRUMENTS LIST

Item	Kind of Equipment	Manufacturer	Type No.	Serial No.	Calibrated until
1	Measurement Software	Farad	EZ-EMC Ver.NB-03A 1-01	N/A	N/A
2	50Ω Terminator	SHX	TF2-3G-A	08122901	Mar. 26, 2018
3	TWO-LINE V-NETWORK	R&S	ENV216	100526	Mar. 26, 2018
4	EMI Test Receiver	R&S	ESR3	101862	Aug. 15, 2018
5	Artificial-Mains Network	SCHWARZBECK	NSLK 8127	8127685	Aug. 20, 2018
6	Cable	N/A	RG400 12m	N/A	Mar. 07, 2018

Remark: "N/A" denotes no model name, serial no. or calibration specified.
 All calibration period of equipment list is one year.

4.1.3 TEST PROCEDURE

- a. The EUT was placed 0.8 meters from the horizontal ground plane with EUT being connected to the power mains through a line impedance stabilization network (LISN). All other support equipments powered from additional LISN(s). The LISN provide 50 Ohm/ 50uH of coupling impedance for the measuring instrument.
- b. Interconnecting cables that hang closer than 40 cm to the ground plane shall be folded back and forth in the center forming a bundle 30 to 40 cm long.
- c. I/O cables that are not connected to a peripheral shall be bundled in the center. The end of the cable may be terminated, if required, using the correct terminating impedance. The overall length shall not exceed 1 m.
- d. LISN at least 80 cm from nearest part of EUT chassis.
- e. For the actual test configuration, please refer to the related Item –EUT Test Photos.
- f. First the whole spectrum of emission caused by equipment under test(EUT) is recorded with Detector set to peak. Peak value recorded in table if the margin from QP Limit is larger than 2dB, otherwise, QP value is recorded, Measuring frequency range from 150KHz to 30MHz.

4.1.4 DEVIATION FROM TEST STANDARD

No deviation

4.1.5 TEST SETUP

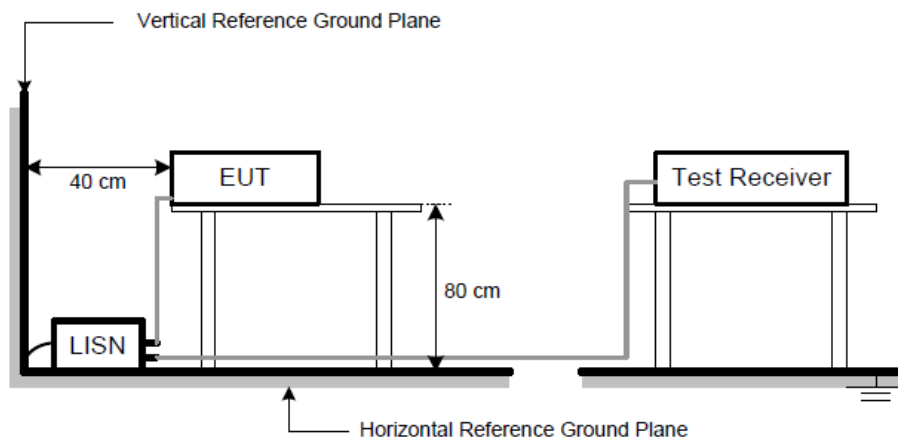

4.1.6 TEST RESULTS

Remark

- (1) Reading in which marked as QP means measurements by using are Quasi-Peak Mode with Detector BW=9KHz; SPA setting in RBW=10KHz, VBW =10KHz, Swp. Time = 0.3 sec./MHz. Reading in which marked as AV means measurements by using are Average Mode with instrument setting in RBW=10KHz, VBW=10KHz, Swp. Time =0.3 sec./MHz.
- (2) All readings are QP Mode value unless otherwise stated AVG in column of 『Note』. If the QP Mode Measured value compliance with the QP Limits and lower than AVG Limits, the EUT shall be deemed to meet both QP & AVG Limits and then only QP Mode was measured, but AVG Mode didn't perform. In this case, a “*” marked in AVG Mode column of Interference Voltage Measured.

EUT	LCD Monitor	Model Name	24E1Q
Temperature	25°C	Relative Humidity	53%
Test Voltage	AC 120V/60Hz	Phase	Line
Test Mode	D-SUB 1920*1080/60Hz		
Note	1.8m		
Test Engineer	Kang Zhang		

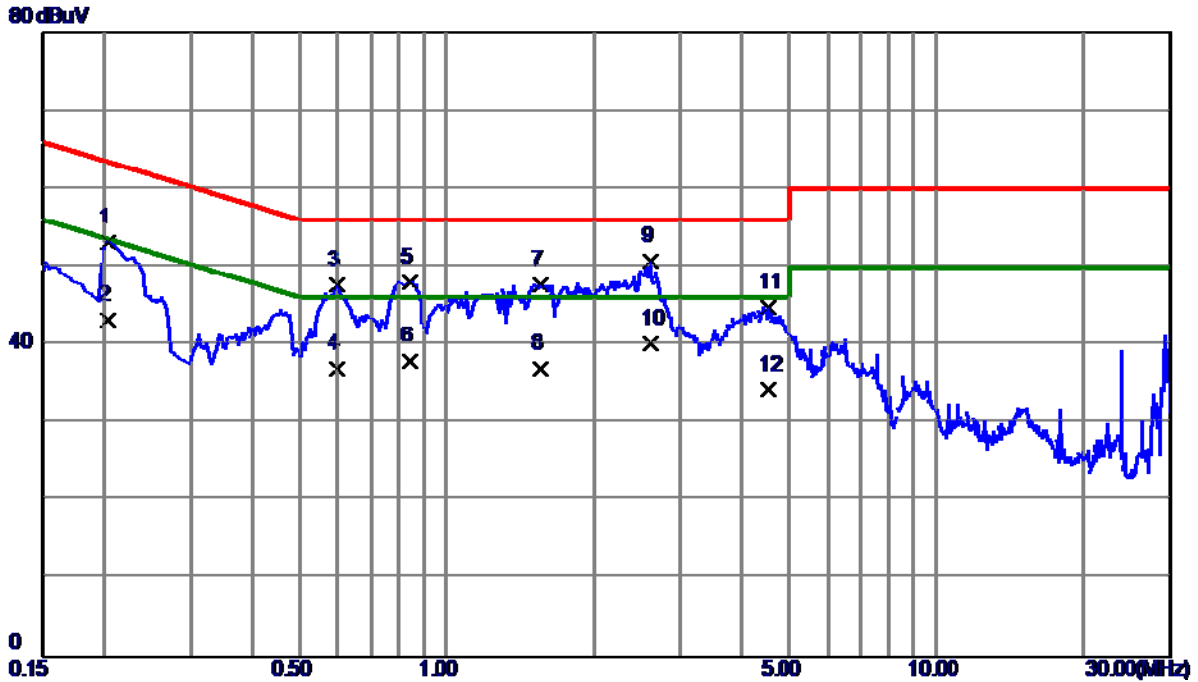

No.	Freq. MHz	Reading Level dBuV	Correct Factor dB	Measure ment dBuV	Limit dBuV	Margin dB	Detector
1	0.2040	43.48	9.69	53.17	63.45	-10.28	QP
2	0.2040	33.56	9.69	43.25	53.45	-10.20	AVG
3	0.5977	37.87	9.74	47.61	56.00	-8.39	QP
4	0.5977	27.15	9.74	36.89	46.00	-9.11	AVG
5	0.8407	38.31	9.75	48.06	56.00	-7.94	QP
6	0.8407	28.15	9.75	37.90	46.00	-8.10	AVG
7	1.5517	37.86	9.81	47.67	56.00	-8.33	QP
8	1.5517	27.17	9.81	36.98	46.00	-9.02	AVG
9 *	2.6070	40.83	9.88	50.71	56.00	-5.29	QP
10	2.6070	30.25	9.88	40.13	46.00	-5.87	AVG
11	4.5240	34.76	10.00	44.76	56.00	-11.24	QP
12	4.5240	24.17	10.00	34.17	46.00	-11.83	AVG

EUT	LCD Monitor	Model Name	24E1Q
Temperature	25°C	Relative Humidity	53%
Test Voltage	AC 120V/60Hz	Phase	Neutral
Test Mode	D-SUB 1920*1080/60Hz		
Note	1.8m		
Test Engineer	Kang Zhang		

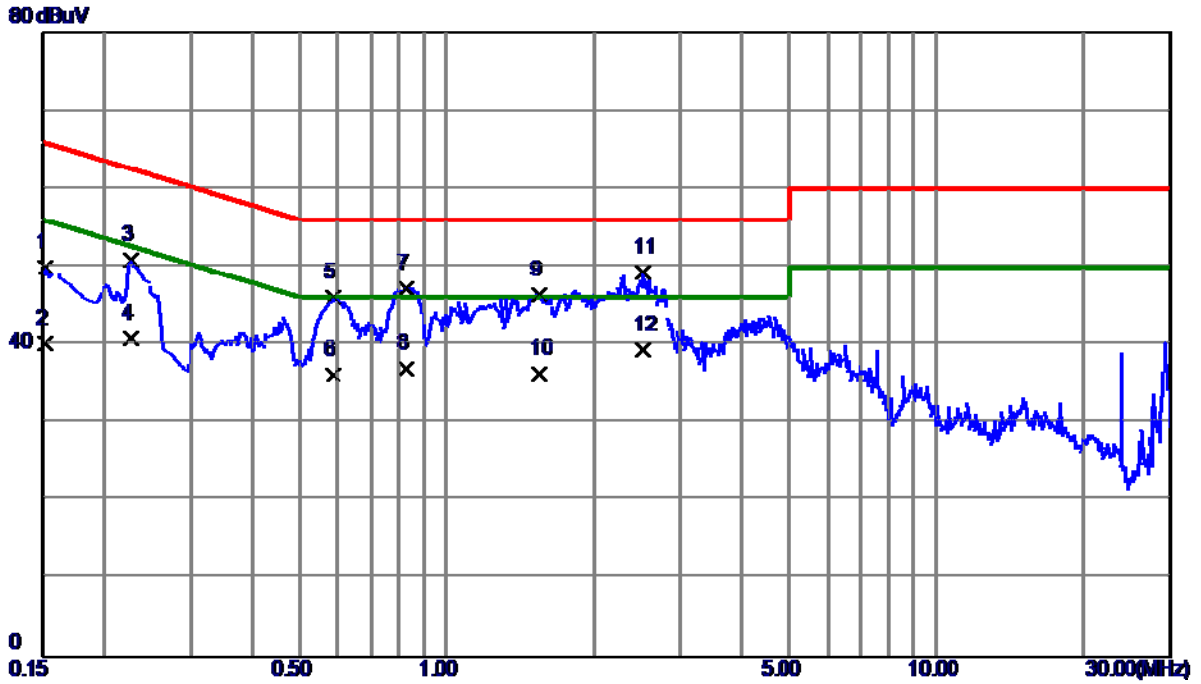

No.	Freq. MHz	Reading Level dBuV	Correct Factor dB	Measure ment dBuV	Limit dBuV	Margin dB	Detector
1	0.1522	40.18	9.66	49.84	65.88	-16.04	QP
2	0.1522	30.56	9.66	40.22	55.88	-15.66	AVG
3	0.2265	41.22	9.68	50.90	62.58	-11.68	QP
4	0.2265	31.05	9.68	40.73	52.58	-11.85	AVG
5	0.5887	36.32	9.73	46.05	56.00	-9.95	QP
6	0.5887	26.45	9.73	36.18	46.00	-9.82	AVG
7	0.8294	37.48	9.74	47.22	56.00	-8.78	QP
8	0.8294	27.15	9.74	36.89	46.00	-9.11	AVG
9	1.5427	36.62	9.81	46.43	56.00	-9.57	QP
10	1.5427	26.48	9.81	36.29	46.00	-9.71	AVG
11	2.5215	39.39	9.87	49.26	56.00	-6.74	QP
12 *	2.5215	29.45	9.87	39.32	46.00	-6.68	AVG

EUT	LCD Monitor	Model Name	24E1Q
Temperature	25°C	Relative Humidity	53%
Test Voltage	AC 120V/60Hz	Phase	Line
Test Mode	D-SUB 1920*1080/60Hz		
Note	1.5m		
Test Engineer	Kang Zhang		

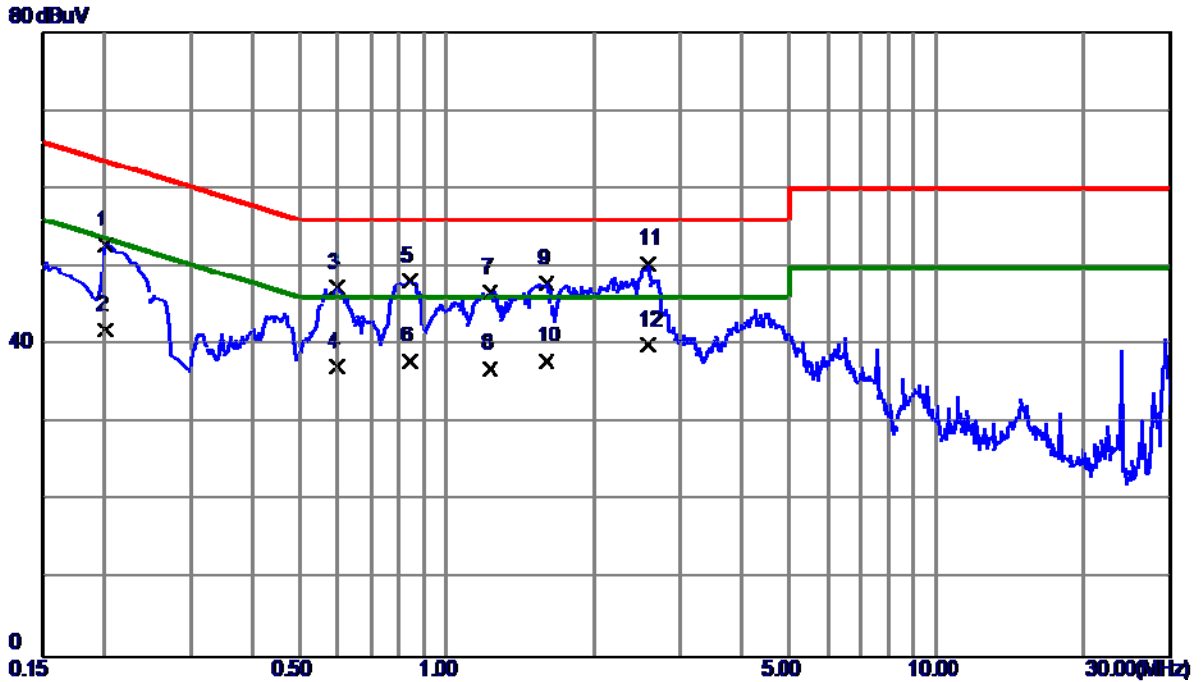

No.	Freq. MHz	Reading Level dBuV	Correct Factor dB	Measure ment dBuV	Limit dBuV	Margin dB	Detector
1	0.2017	43.08	9.69	52.77	63.54	-10.77	QP
2	0.2017	32.17	9.69	41.86	53.54	-11.68	AVG
3	0.5977	37.61	9.74	47.35	56.00	-8.65	QP
4	0.5977	27.46	9.74	37.20	46.00	-8.80	AVG
5	0.8407	38.39	9.75	48.14	56.00	-7.86	QP
6	0.8407	28.15	9.75	37.90	46.00	-8.10	AVG
7	1.2276	36.90	9.80	46.70	56.00	-9.30	QP
8	1.2276	27.16	9.80	36.96	46.00	-9.04	AVG
9	1.5967	38.08	9.82	47.90	56.00	-8.10	QP
10	1.5967	28.14	9.82	37.96	46.00	-8.04	AVG
11 *	2.5800	40.45	9.88	50.33	56.00	-5.67	QP
12	2.5800	30.12	9.88	40.00	46.00	-6.00	AVG

EUT	LCD Monitor	Model Name	24E1Q
Temperature	25°C	Relative Humidity	53%
Test Voltage	AC 120V/60Hz	Phase	Neutral
Test Mode	D-SUB 1920*1080/60Hz		
Note	1.5m		
Test Engineer	Kang Zhang		

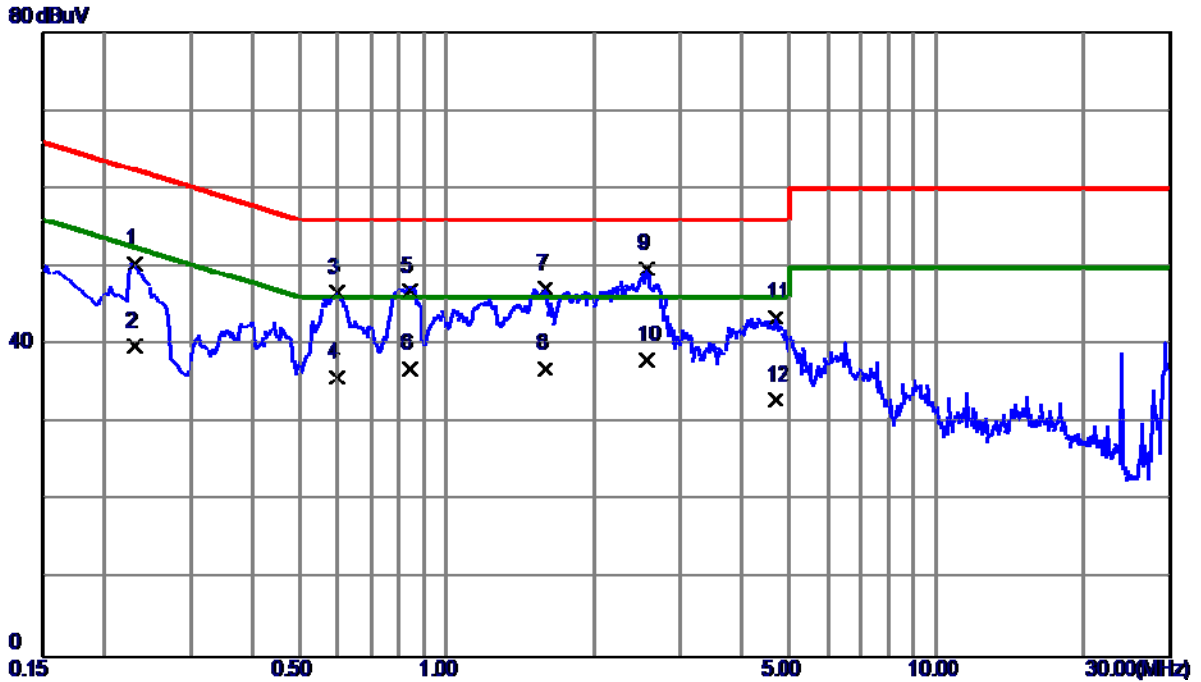

No.	Freq. MHz	Reading Level dBuV	Correct Factor dB	Measure ment dBuV	Limit dBuV	Margin dB	Detector
1	0.2310	40.77	9.68	50.45	62.41	-11.96	QP
2	0.2310	30.15	9.68	39.83	52.41	-12.58	AVG
3	0.6000	36.96	9.73	46.69	56.00	-9.31	QP
4	0.6000	26.15	9.73	35.88	46.00	-10.12	AVG
5	0.8407	37.15	9.74	46.89	56.00	-9.11	QP
6	0.8407	27.15	9.74	36.89	46.00	-9.11	AVG
7	1.5877	37.44	9.81	47.25	56.00	-8.75	QP
8	1.5877	27.15	9.81	36.96	46.00	-9.04	AVG
9 *	2.5641	39.83	9.88	49.71	56.00	-6.29	QP
10	2.5641	28.15	9.88	38.03	46.00	-7.97	AVG
11	4.6994	33.49	10.01	43.50	56.00	-12.50	QP
12	4.6994	23.02	10.01	33.03	46.00	-12.97	AVG

EUT	LCD Monitor	Model Name	24E1Q
Temperature	25°C	Relative Humidity	53%
Test Voltage	AC 120V/60Hz	Phase	Line
Test Mode	D-SUB 1920*1080/60Hz		
Note	1.2m		
Test Engineer	Kang Zhang		

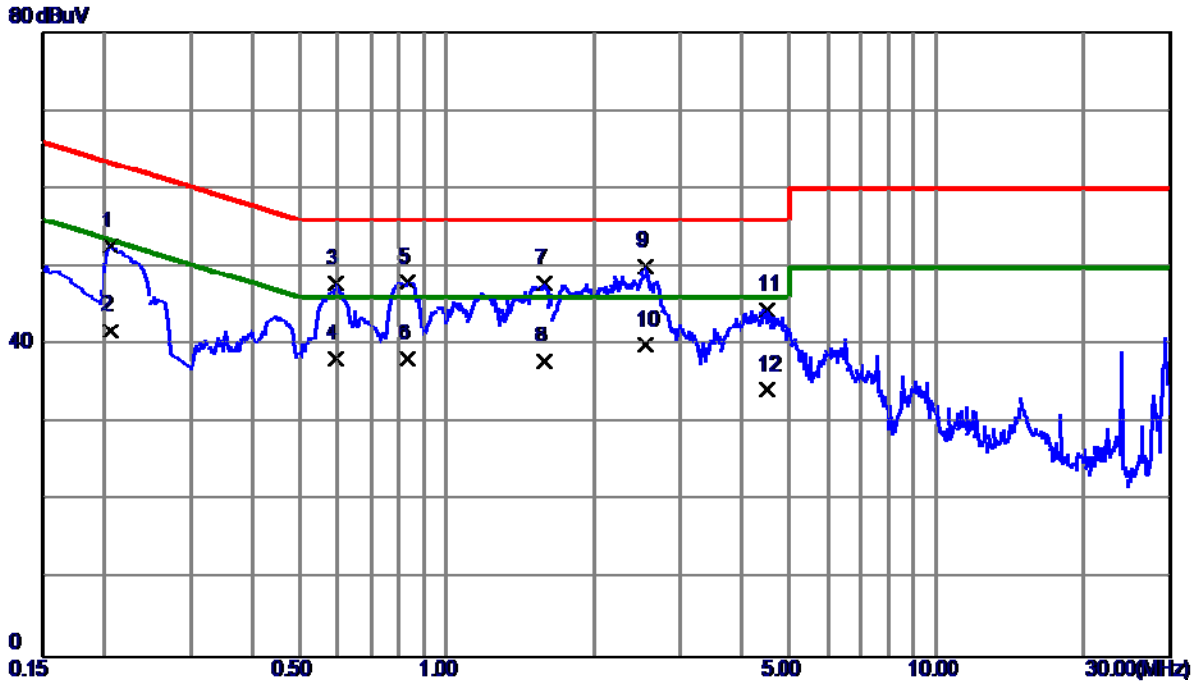

No.	Freq. MHz	Reading Level dBuV	Correct Factor dB	Measure ment dBuV	Limit dBuV	Margin dB	Detector
1	0.2062	42.89	9.69	52.58	63.36	-10.78	QP
2	0.2062	32.15	9.69	41.84	53.36	-11.52	AVG
3	0.5954	38.04	9.74	47.78	56.00	-8.22	QP
4	0.5954	28.46	9.74	38.20	46.00	-7.80	AVG
5	0.8340	38.21	9.75	47.96	56.00	-8.04	QP
6	0.8340	28.45	9.75	38.20	46.00	-7.80	AVG
7	1.5809	38.01	9.81	47.82	56.00	-8.18	QP
8	1.5809	28.15	9.81	37.96	46.00	-8.04	AVG
9 *	2.5530	40.15	9.88	50.03	56.00	-5.97	QP
10	2.5530	30.15	9.88	40.03	46.00	-5.97	AVG
11	4.5127	34.49	10.00	44.49	56.00	-11.51	QP
12	4.5127	24.19	10.00	34.19	46.00	-11.81	AVG

EUT	LCD Monitor	Model Name	24E1Q
Temperature	25°C	Relative Humidity	53%
Test Voltage	AC 120V/60Hz	Phase	Neutral
Test Mode	D-SUB 1920*1080/60Hz		
Note	1.2m		
Test Engineer	Kang Zhang		

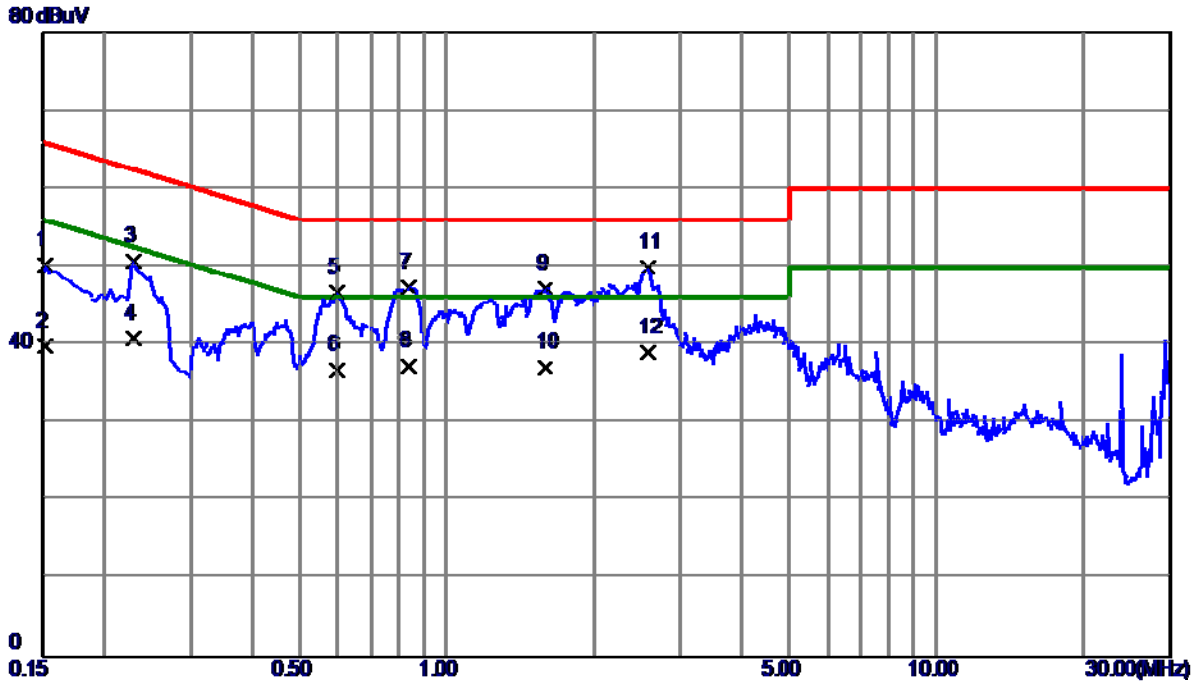

No.	Freq. MHz	Reading Level dBuV	Correct Factor dB	Measurement dBuV	Limit dBuV	Margin dB	Detector
1	0.1522	40.55	9.66	50.21	65.88	-15.67	QP
2	0.1522	30.12	9.66	39.78	55.88	-16.10	AVG
3	0.2287	41.03	9.68	50.71	62.50	-11.79	QP
4	0.2287	31.05	9.68	40.73	52.50	-11.77	AVG
5	0.5977	37.02	9.73	46.75	56.00	-9.25	QP
6	0.5977	27.06	9.73	36.79	46.00	-9.21	AVG
7	0.8362	37.64	9.74	47.38	56.00	-8.62	QP
8	0.8362	27.61	9.74	37.35	46.00	-8.65	AVG
9	1.5900	37.42	9.81	47.23	56.00	-8.77	QP
10	1.5900	27.36	9.81	37.17	46.00	-8.83	AVG
11 *	2.5687	39.96	9.88	49.84	56.00	-6.16	QP
12	2.5687	29.15	9.88	39.03	46.00	-6.97	AVG

EUT	LCD Monitor	Model Name	24E1Q
Temperature	25°C	Relative Humidity	53%
Test Voltage	AC 120V/60Hz	Phase	Line
Test Mode	HDMI 1920*1080/60Hz		
Note	1.8m		
Test Engineer	Kang Zhang		

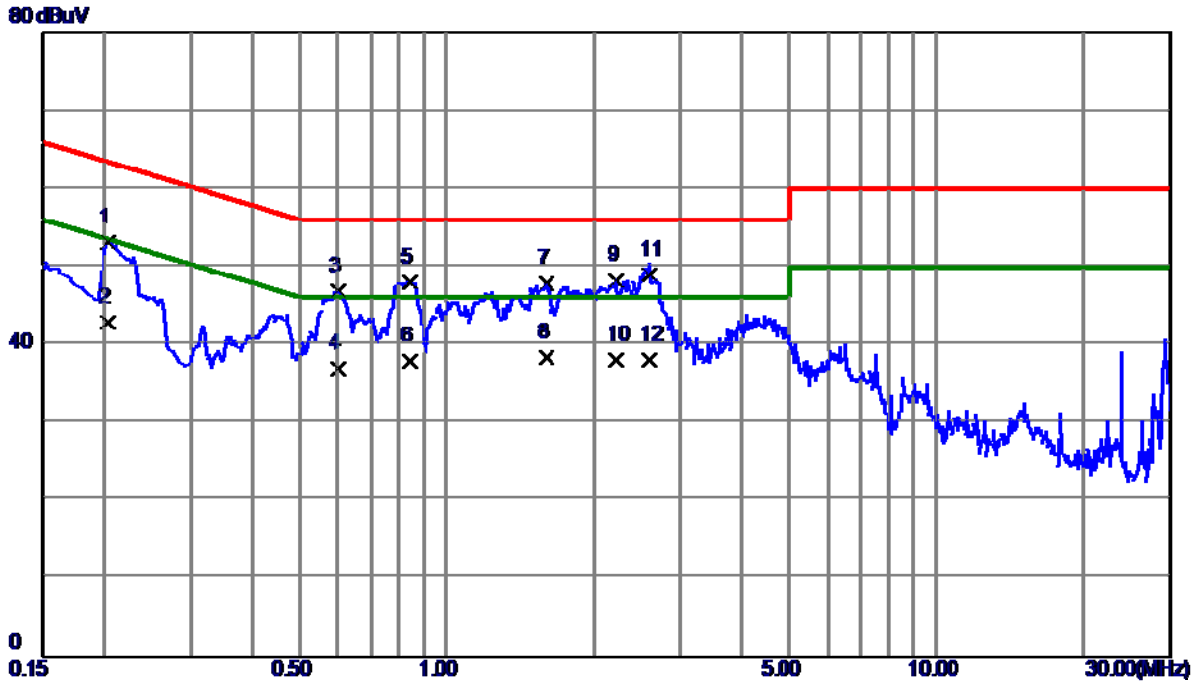

No.	Freq. MHz	Reading Level dBuV	Correct Factor dB	Measure ment dBuV	Limit dBuV	Margin dB	Detector
1	0.2040	43.36	9.69	53.05	63.45	-10.40	QP
2	0.2040	33.14	9.69	42.83	53.45	-10.62	AVG
3	0.6022	37.09	9.74	46.83	56.00	-9.17	QP
4	0.6022	27.15	9.74	36.89	46.00	-9.11	AVG
5	0.8407	38.21	9.75	47.96	56.00	-8.04	QP
6	0.8407	28.15	9.75	37.90	46.00	-8.10	AVG
7	1.6035	38.05	9.82	47.87	56.00	-8.13	QP
8	1.6035	28.51	9.82	38.33	46.00	-7.67	AVG
9	2.2222	38.37	9.87	48.24	56.00	-7.76	QP
10	2.2222	28.15	9.87	38.02	46.00	-7.98	AVG
11 *	2.5912	39.15	9.88	49.03	56.00	-6.97	QP
12	2.5912	28.15	9.88	38.03	46.00	-7.97	AVG

EUT	LCD Monitor	Model Name	24E1Q
Temperature	25°C	Relative Humidity	53%
Test Voltage	AC 120V/60Hz	Phase	Neutral
Test Mode	HDMI 1920*1080/60Hz		
Note	1.8m		
Test Engineer	Kang Zhang		

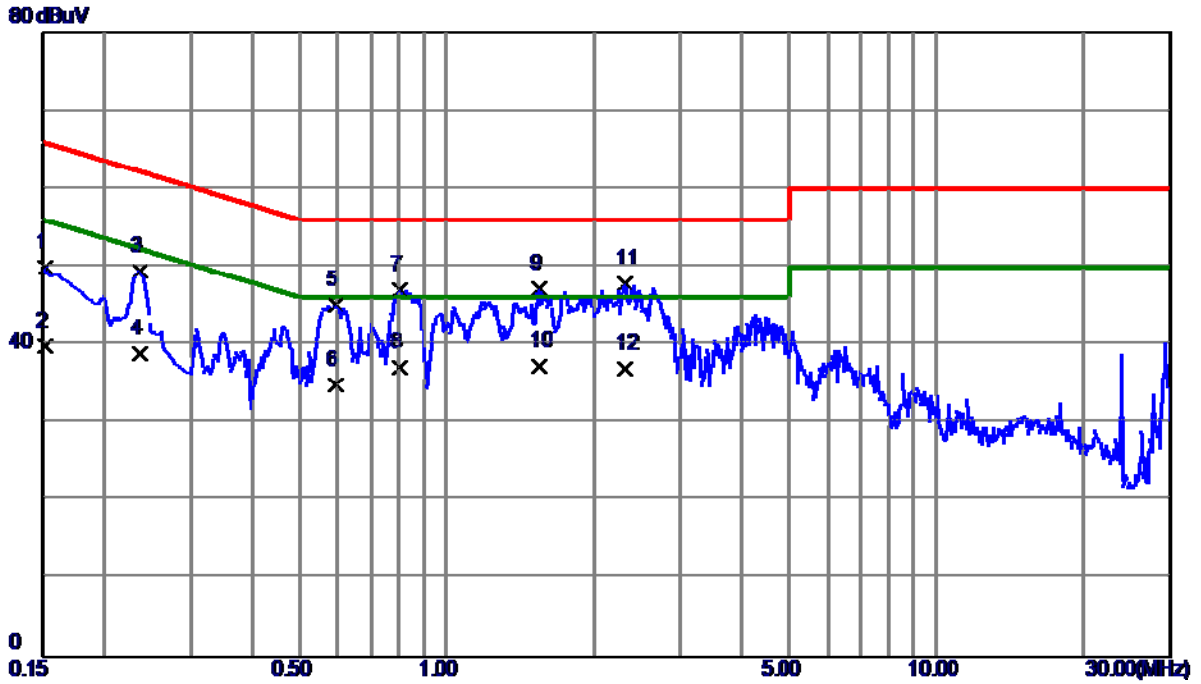

No.	Freq. MHz	Reading Level dBuV	Correct Factor dB	Measure ment dBuV	Limit dBuV	Margin dB	Detector
1	0.1522	40.31	9.66	49.97	65.88	-15.91	QP
2	0.1522	30.12	9.66	39.78	55.88	-16.10	AVG
3	0.2355	39.72	9.68	49.40	62.25	-12.85	QP
4	0.2355	29.15	9.68	38.83	52.25	-13.42	AVG
5	0.5954	35.44	9.73	45.17	56.00	-10.83	QP
6	0.5954	25.15	9.73	34.88	46.00	-11.12	AVG
7	0.8024	37.23	9.74	46.97	56.00	-9.03	QP
8	0.8024	27.31	9.74	37.05	46.00	-8.95	AVG
9	1.5472	37.33	9.81	47.14	56.00	-8.86	QP
10	1.5472	27.52	9.81	37.33	46.00	-8.67	AVG
11 *	2.3145	37.92	9.86	47.78	56.00	-8.22	QP
12	2.3145	27.15	9.86	37.01	46.00	-8.99	AVG

EUT	LCD Monitor	Model Name	24E1Q
Temperature	25°C	Relative Humidity	53%
Test Voltage	AC 120V/60Hz	Phase	Line
Test Mode	HDMI 1080P		
Note	1.8m		
Test Engineer	Kang Zhang		

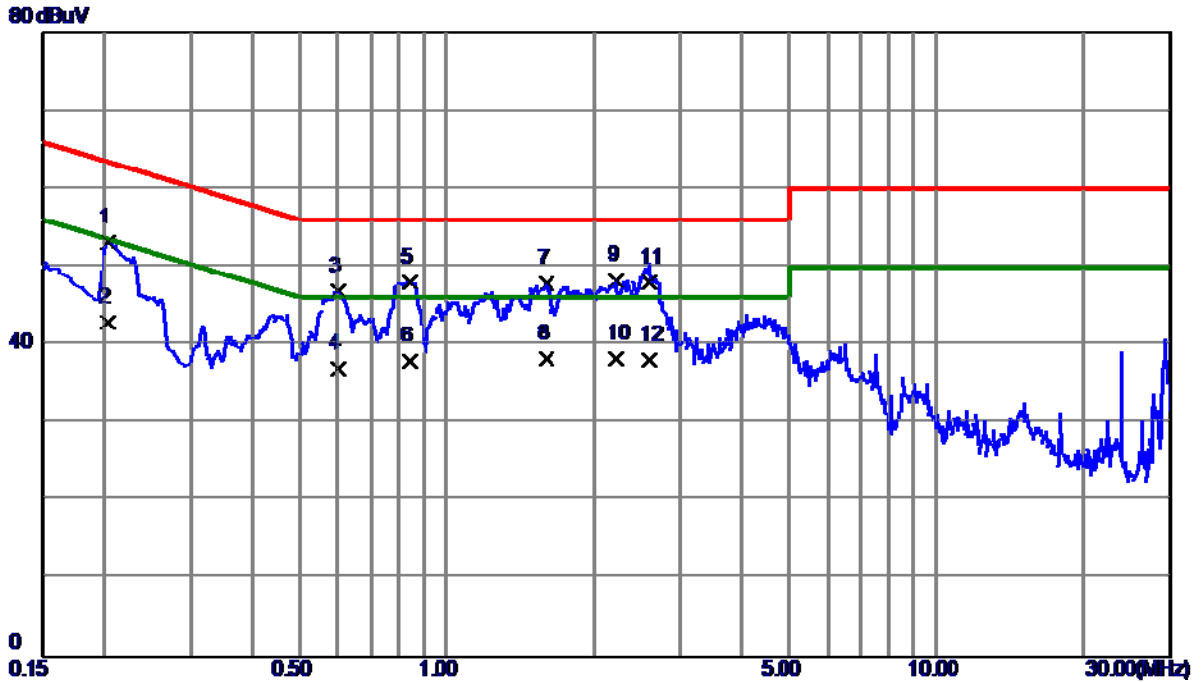

No.	Freq. MHz	Reading Level dBuV	Correct Factor dB	Measure ment dBuV	Limit dBuV	Margin dB	Detector
1	0.2040	43.36	9.69	53.05	63.45	-10.40	QP
2	0.2040	33.15	9.69	42.84	53.45	-10.61	AVG
3	0.6022	37.09	9.74	46.83	56.00	-9.17	QP
4	0.6022	27.15	9.74	36.89	46.00	-9.11	AVG
5	0.8407	38.21	9.75	47.96	56.00	-8.04	QP
6	0.8407	28.15	9.75	37.90	46.00	-8.10	AVG
7	1.6035	38.05	9.82	47.87	56.00	-8.13	QP
8 *	1.6035	28.49	9.82	38.31	46.00	-7.69	AVG
9	2.2222	38.37	9.87	48.24	56.00	-7.76	QP
10	2.2222	28.35	9.87	38.22	46.00	-7.78	AVG
11	2.5912	38.15	9.88	48.03	56.00	-7.97	QP
12	2.5912	28.15	9.88	38.03	46.00	-7.97	AVG

EUT	LCD Monitor	Model Name	24E1Q
Temperature	25°C	Relative Humidity	53%
Test Voltage	AC 120V/60Hz	Phase	Neutral
Test Mode	HDMI 1080P		
Note	1.8m		
Test Engineer	Kang Zhang		

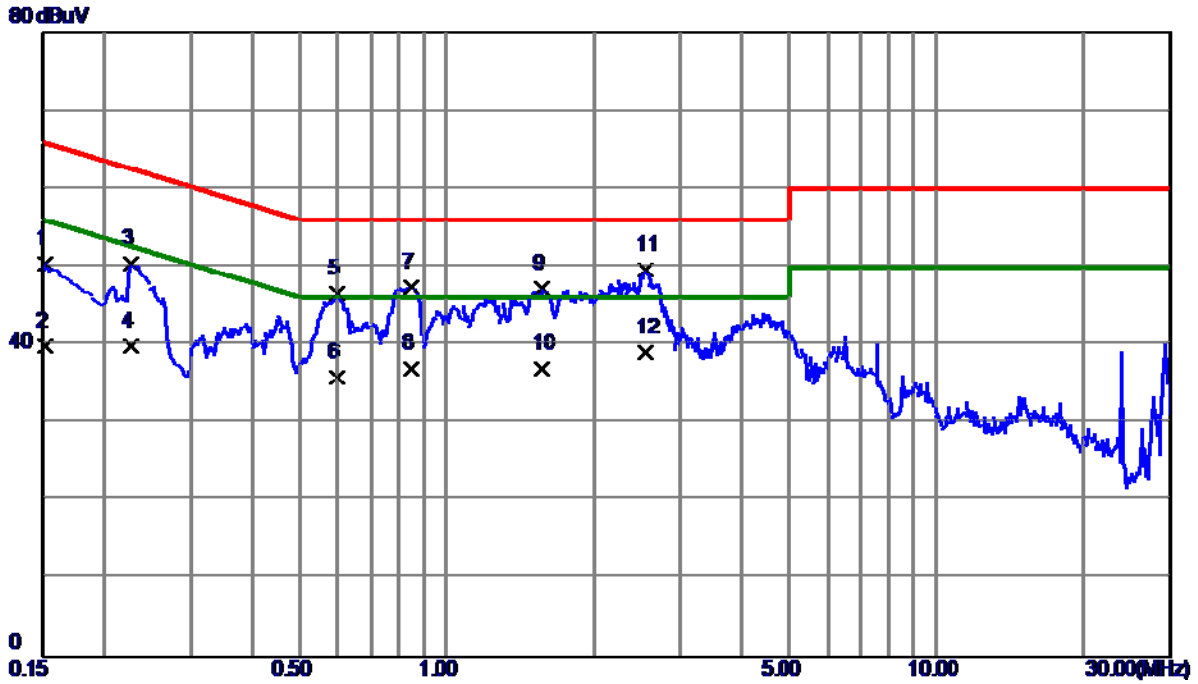

No.	Freq. MHz	Reading Level dBuV	Correct Factor dB	Measure ment dBuV	Limit dBuV	Margin dB	Detector
1	0.1522	40.77	9.66	50.43	65.88	-15.45	QP
2	0.1522	30.15	9.66	39.81	55.88	-16.07	AVG
3	0.2265	40.69	9.68	50.37	62.58	-12.21	QP
4	0.2265	30.15	9.68	39.83	52.58	-12.75	AVG
5	0.6000	36.87	9.73	46.60	56.00	-9.40	QP
6	0.6000	26.15	9.73	35.88	46.00	-10.12	AVG
7	0.8474	37.58	9.74	47.32	56.00	-8.68	QP
8	0.8474	27.15	9.74	36.89	46.00	-9.11	AVG
9	1.5607	37.37	9.81	47.18	56.00	-8.82	QP
10	1.5607	27.14	9.81	36.95	46.00	-9.05	AVG
11 *	2.5395	39.76	9.88	49.64	56.00	-6.36	QP
12	2.5395	29.15	9.88	39.03	46.00	-6.97	AVG

4.2 RADIATED EMISSION MEASUREMENT

4.2.1 LIMITS OF RADIATED EMISSION MEASUREMENT

Below 1 GHz

Measurement Method and Applied Limits:

ANSI C63.4:

Frequency (MHz)	Class A (at 10m)		Class B (at 3m)	
	(uV/m) Field strength	(dBuV/m) Field strength	(uV/m) Field strength	(dBuV/m) Field strength
30 - 88	90	39	100	40
88 - 216	150	43.5	150	43.5
216 - 960	210	46.4	200	46
Above 960	300	49.5	500	54

Above 1 GHz

Measurement Method and Applied Limits:

ANSI C63.4:

Frequency (MHz)	Class A				Class B	
	(dBuV/m) (at 3m)		(dBuV/m) (at 10m)		(dBuV/m) (at 3m)	
	Peak	Average	Peak	Average	Peak	Average
Above 1000	80	60	69.5	49.5	74	54

FREQUENCY RANGE OF RADIATED MEASUREMENT (FOR UNINTENTIONAL RADIATORS)

Highest frequency generated or Upper frequency of measurement used in the device or on which the device operates or tunes (MHz)	Range (MHz)
Below 1.705	30
1.705 - 108	1000
108 - 500	2000
500 - 1000	5000
Above 1000	5 th harmonic of the highest frequency or 40 GHz, whichever is lower

NOTE:

- (1) The limit for radiated test was performed according to as following:
FCC Part 15, Subpart B; ICES-003 Issue 6: 2016.
- (2) The tighter limit applies at the band edges.
- (3) Emission level (dBuV/m) = 20log Emission level (uV/m).
3m Emission level = 10m Emission level + 20log(10m/3m).
- (4) The test result calculated as following:
Measurement Value = Reading Level + Correct Factor
Correct Factor = Antenna Factor + Cable Loss - Amplifier Gain(if use)
Margin Level = Measurement Value - Limit Value

4.2.2 MEASUREMENT INSTRUMENTS LIST

Below 1GHz:

Item	Kind of Equipment	Manufacturer	Type No.	Serial No.	Calibrated until
1	Pre-Amplifier	Mini-Circuits	EMC 9135	980284	Mar. 26, 2018
2	Pre-Amplifier	Mini-Circuits	EMC 9135	980283	Mar. 26, 2018
3	Trilog-Broadband Antenna	Schwarzbeck	VULB9168	586	Mar. 26, 2018
4	Trilog-Broadband Antenna	Schwarzbeck	VULB9168	587	Mar. 26, 2018
5	Cable	emci	LMR-400(5m+11m+15m)	N/A	Nov. 03, 2018
6	Cable	emci	LMR-400(5m+8m+15m)	N/A	Nov. 03, 2018
7	Measurement Software	Farad	EZ-EMC Ver.BTL-2AN T-1	N/A	N/A
8	Multi-Device Controller	ETS-Lindgren	2090	N/A	N/A
9	Attenuator	N/A	SA18N-06	6dB	Apr. 14, 2018
10	Attenuator	N/A	SA18N-06	6dB	Apr. 14, 2018
11	Receiver	Keysight	N9038A	MY54450004	Aug. 15, 2018
12	MXE EMI Receiver	Agilent	N9038A	MY53220133	Jun. 20, 2018

Remark: "N/A" denotes no model name, no serial no. or no calibration specified.
All calibration period of equipment list is one year.

Above 1GHz:

Item	Kind of Equipment	Manufacturer	Type No.	Serial No.	Calibrated until
1	Measurement Software	Farad	EZ-EMC Ver.BTL-2A NT-1	N/A	N/A
2	Cable	emci	SUCOFLE X_15m_5m (0.01GHz–26.5GHz)	N/A	Nov. 03, 2018
3	Multi-Device Controller	ETS-Lindgren	2090	N/A	N/A
4	Controller	MF	MF-7802	MF780208159	N/A
5	Horn Antenna	EMCO	3115	9605-4803	Mar. 26, 2018
6	Amplifier	Agilent	8449B	3008A02584	Aug. 20, 2018
7	MXE EMI Receiver	Agilent	N9038A	MY53220133	Jun. 20, 2018

Remark: "N/A" denotes no model name, no serial no. or no calibration specified.
All calibration period of equipment list is one year.

4.2.3 TEST PROCEDURE

- a. The measuring distance of 3 m shall be used for measurements. The EUT was placed on the top of a rotating table 0.8 meter above the ground at a 10 meter semi-anechoic chamber. The table was rotated 360 degrees to determine the position of the highest radiation.(below 1GHz)
- b. The measuring distance of 3 m shall be used for measurements. The EUT was placed on the top of a rotating table 0.8 meter above the ground at a 10 meter semi-anechoic chamber. The table was rotated 360 degrees to determine the position of the highest radiation.(above 1GHz)
- c. The height of the equipment or of the substitution antenna shall be 0.8 m, the height of the test antenna shall vary between 1 m to 4 m. Both horizontal and vertical polarizations of the antenna are set to make the measurement.
- d. For each suspected emission, the EUT was arranged to its worst case and then the antenna was tuned to heights find the maximum reading (used Bore sight function).
- e. The receiver system was set to peak and average detect function and specified bandwidth with maximum hold mode when the test frequency is above 1GHz.
- f. The initial step in collecting radiated emission data is a receiver peak detector mode pre-scanning the measurement frequency range. Significant peaks are then marked and then Quasi Peak detector mode re-measured.
- g. All readings are Peak unless otherwise stated QP in column of Note. Peak denotes that the Peak reading compliance with the QP Limits and then QP Mode measurement didn't perform. (below 1GHz)
- h. All readings are Peak Mode value unless otherwise stated AVG in column of Note. If the Peak Mode Measured value compliance with the Peak Limits and lower than AVG Limits, the EUT shall be deemed to meet both Peak & AVG Limits and then only Peak Mode was measured, but AVG Mode didn't perform. (above 1GHz)
- i. For the actual test configuration, please refer to the related Item - Block Diagram of system tested (please refer to 3.3).

4.2.4 DEVIATION FROM TEST STANDARD

No deviation

4.2.5 TEST SETUP

(A) Radiated Emission Test Set-Up Frequency Below 1 GHz

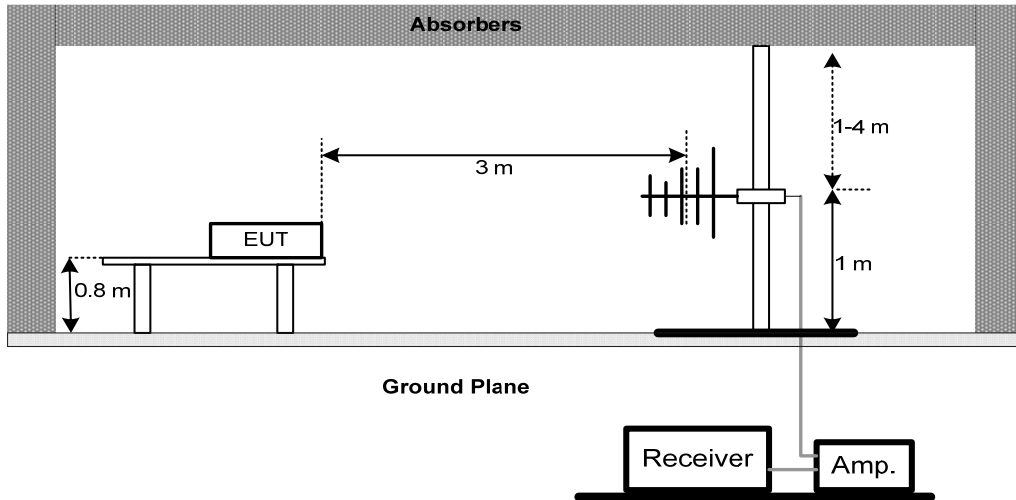

(B) Radiated Emission Test Set-Up Frequency Above 1 GHz

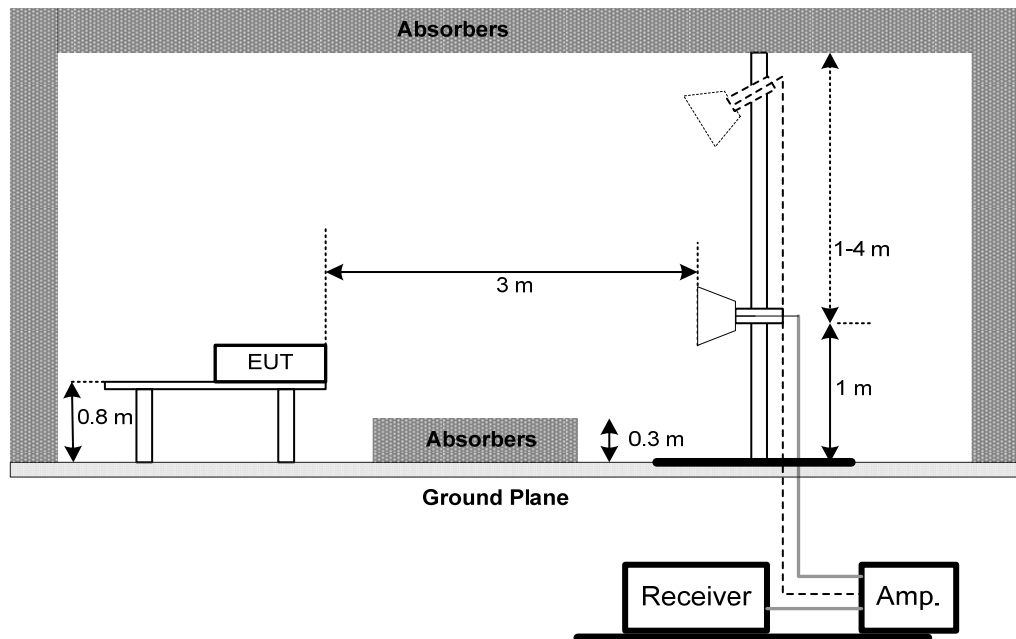

4.2.6 TEST RESULTS-BELOW 1GHZ

Remark :

- (1) All readings are Peak unless otherwise stated QP in column of 『Note』 . Peak denotes that the Peak reading compliance with the QP Limits and then QP Mode measurement didn't perform ◦
- (2) Measuring frequency range from 30MHz to 1000MHz ◦
- (3) If the peak scan value lower limit more than 20dB, then this signal data does not show in table ◦

EUT	LCD Monitor	Model Name	24E1Q
Temperature	25°C	Relative Humidity	60%
Test Voltage	AC 120V/60Hz	Polarization	Vertical
Test Mode	D-SUB 1920*1080/60Hz		
Note	1.8m		
Test Engineer	Kang Zhang		

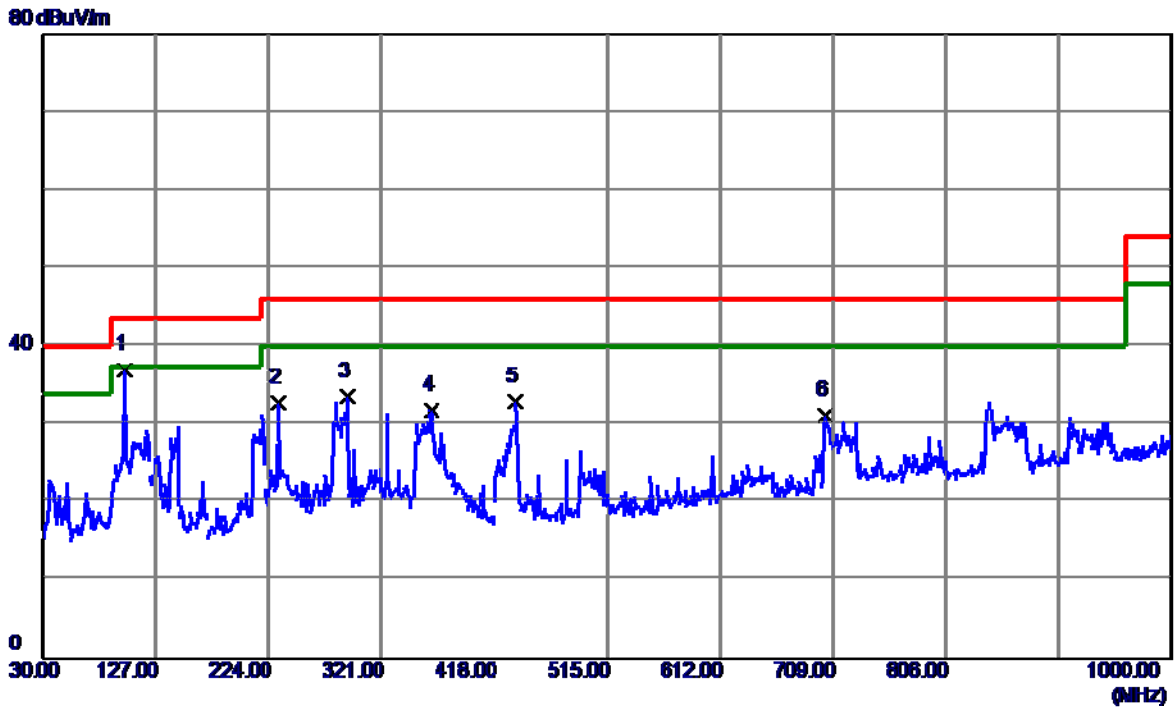

No.	Freq. MHz	Reading Level dBuV/m	Correct Factor dB	Measure ment dBuV/m	Limit dBuV/m	Margin dB	Detector
1 *	99.8399	63.96	-26.92	37.04	43.50	-6.46	QP
2	232.7300	57.12	-24.29	32.83	46.00	-13.17	QP
3	291.4150	54.97	-21.42	33.55	46.00	-12.45	QP
4	363.6800	51.75	-19.84	31.91	46.00	-14.09	QP
5	436.4300	50.87	-17.89	32.98	46.00	-13.02	QP
6	702.6950	44.93	-13.75	31.18	46.00	-14.82	QP

EUT	LCD Monitor	Model Name	24E1Q
Temperature	25°C	Relative Humidity	60%
Test Voltage	AC 120V/60Hz	Polarization	Horizontal
Test Mode	D-SUB 1920*1080/60Hz		
Note	1.8m		
Test Engineer	Kang Zhang		

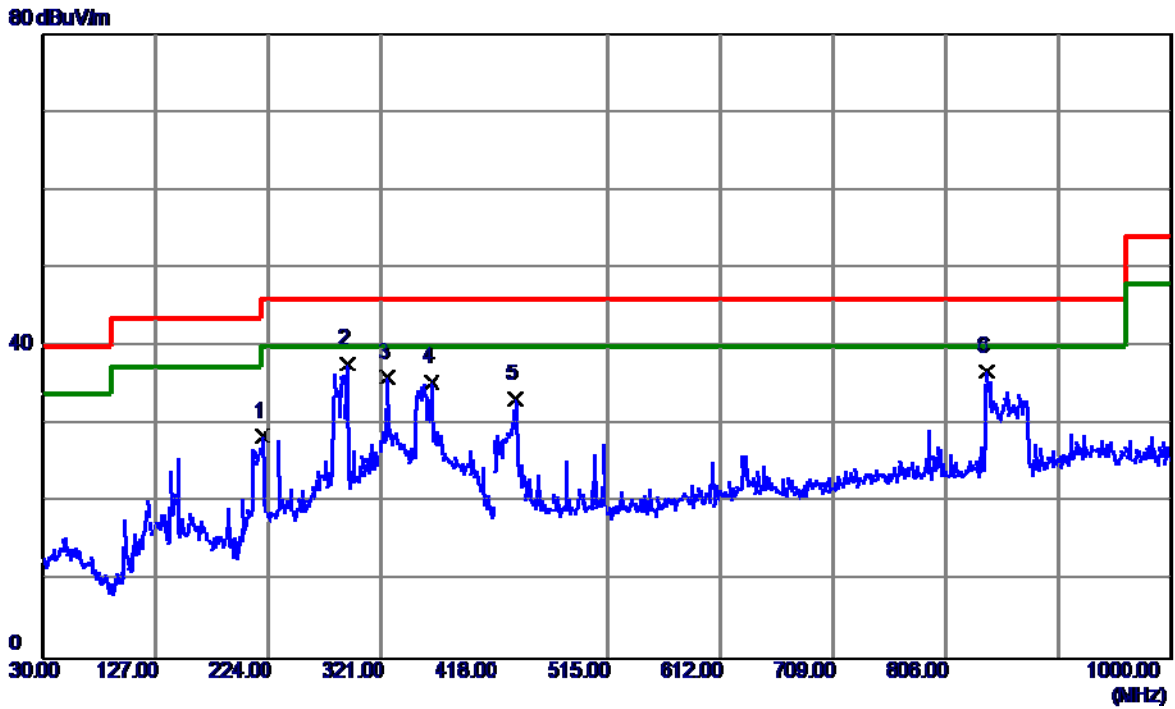

No.	Freq. MHz	Reading Level dBuV/m	Correct Factor dB	Measure ment dBuV/m	Limit dBuV/m	Margin dB	Detector
1	218.1800	53.58	-25.07	28.51	46.00	-17.49	QP
2 *	291.4150	59.24	-21.42	37.82	46.00	-8.18	QP
3	325.8500	56.67	-20.69	35.98	46.00	-10.02	QP
4	363.6800	55.28	-19.84	35.44	46.00	-10.56	QP
5	435.9450	51.17	-17.90	33.27	46.00	-12.73	QP
6	841.8900	48.48	-11.65	36.83	46.00	-9.17	QP

EUT	LCD Monitor	Model Name	24E1Q
Temperature	25°C	Relative Humidity	60%
Test Voltage	AC 120V/60Hz	Polarization	Vertical
Test Mode	D-SUB 1920*1080/60Hz		
Note	1.5m		
Test Engineer	Kang Zhang		

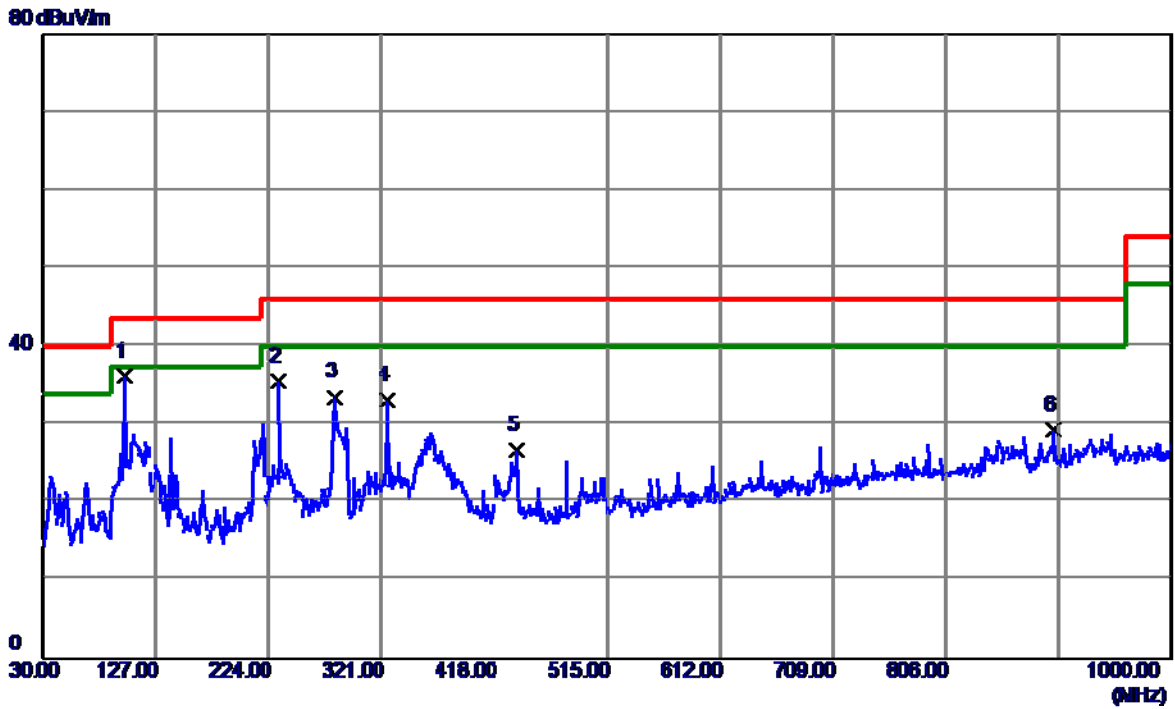

No.	Freq. MHz	Reading Level dBuV/m	Correct Factor dB	Measure ment dBuV/m	Limit dBuV/m	Margin dB	Detector
1 *	99.8399	63.08	-26.92	36.16	43.50	-7.34	QP
2	232.7300	59.74	-24.29	35.45	46.00	-10.55	QP
3	280.7450	55.18	-21.66	33.52	46.00	-12.48	QP
4	325.8500	53.87	-20.69	33.18	46.00	-12.82	QP
5	437.4000	44.56	-17.86	26.70	46.00	-19.30	QP
6	899.1200	39.96	-10.70	29.26	46.00	-16.74	QP

EUT	LCD Monitor	Model Name	24E1Q
Temperature	25°C	Relative Humidity	60%
Test Voltage	AC 120V/60Hz	Polarization	Horizontal
Test Mode	D-SUB 1920*1080/60Hz		
Note	1.5m		
Test Engineer	Kang Zhang		

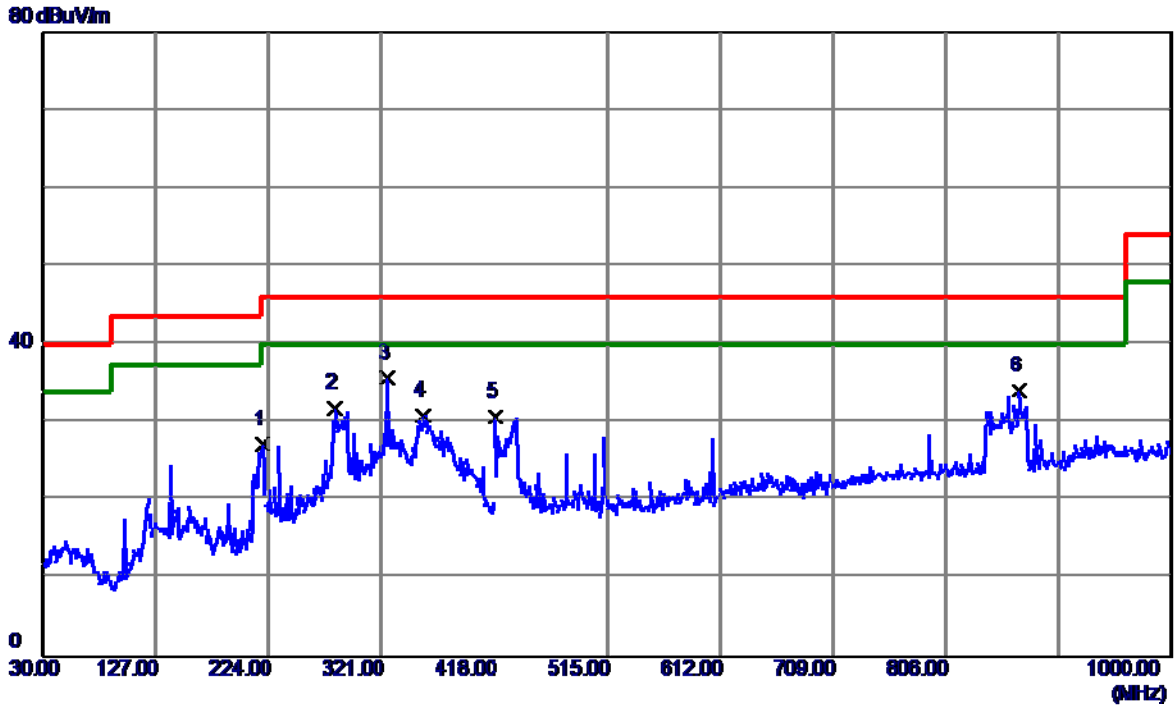

No.	Freq. MHz	Reading Level dBuV/m	Correct Factor dB	Measure ment dBuV/m	Limit dBuV/m	Margin dB	Detector
1	218.1800	52.20	-25.07	27.13	46.00	-18.87	QP
2	280.7450	53.46	-21.66	31.80	46.00	-14.20	QP
3 *	325.8500	56.39	-20.69	35.70	46.00	-10.30	QP
4	356.4050	50.92	-20.02	30.90	46.00	-15.10	QP
5	418.9700	49.13	-18.39	30.74	46.00	-15.26	QP
6	870.0200	45.31	-11.21	34.10	46.00	-11.90	QP

EUT	LCD Monitor	Model Name	24E1Q
Temperature	25°C	Relative Humidity	60%
Test Voltage	AC 120V/60Hz	Polarization	Vertical
Test Mode	D-SUB 1920*1080/60Hz		
Note	1.2m		
Test Engineer	Kang Zhang		

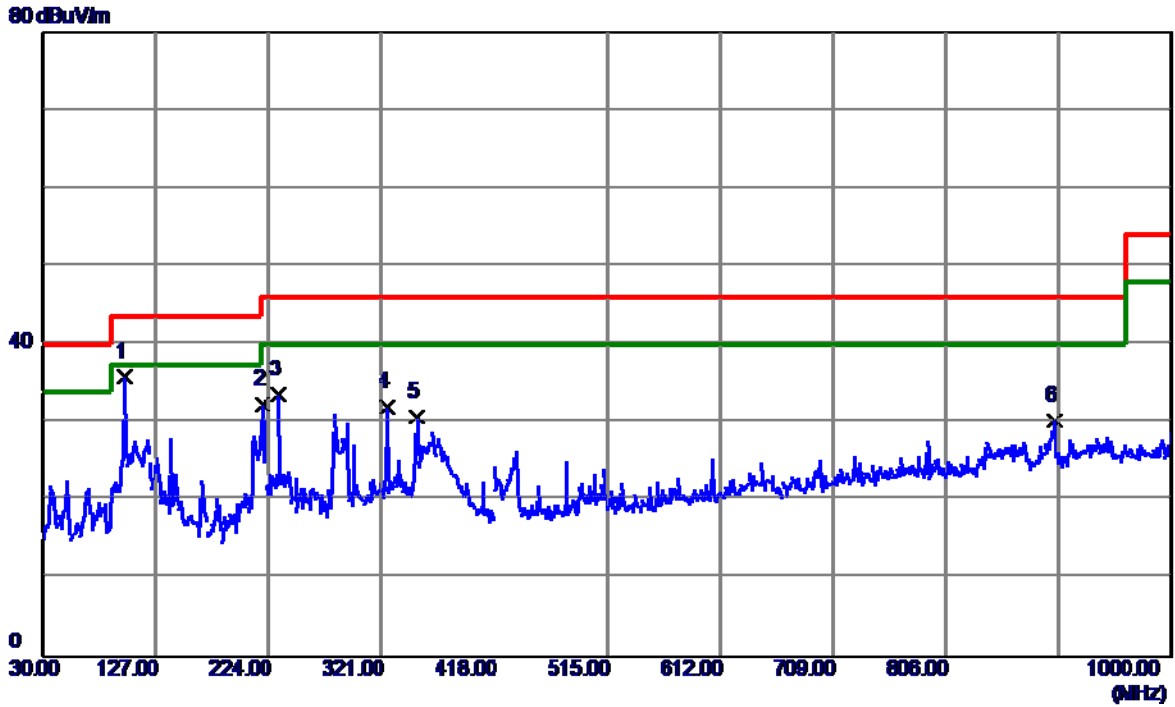

No.	Freq. MHz	Reading Level dBuV/m	Correct Factor dB	Measure ment dBuV/m	Limit dBuV/m	Margin dB	Detector
1 *	99.8399	62.75	-26.92	35.83	43.50	-7.67	QP
2	218.1800	57.33	-25.07	32.26	46.00	-13.74	QP
3	232.7300	57.96	-24.29	33.67	46.00	-12.33	QP
4	325.8500	52.73	-20.69	32.04	46.00	-13.96	QP
5	351.5550	50.85	-20.14	30.71	46.00	-15.29	QP
6	899.6050	40.98	-10.69	30.29	46.00	-15.71	QP

EUT	LCD Monitor	Model Name	24E1Q
Temperature	25°C	Relative Humidity	60%
Test Voltage	AC 120V/60Hz	Polarization	Horizontal
Test Mode	D-SUB 1920*1080/60Hz		
Note	1.2m		
Test Engineer	Kang Zhang		

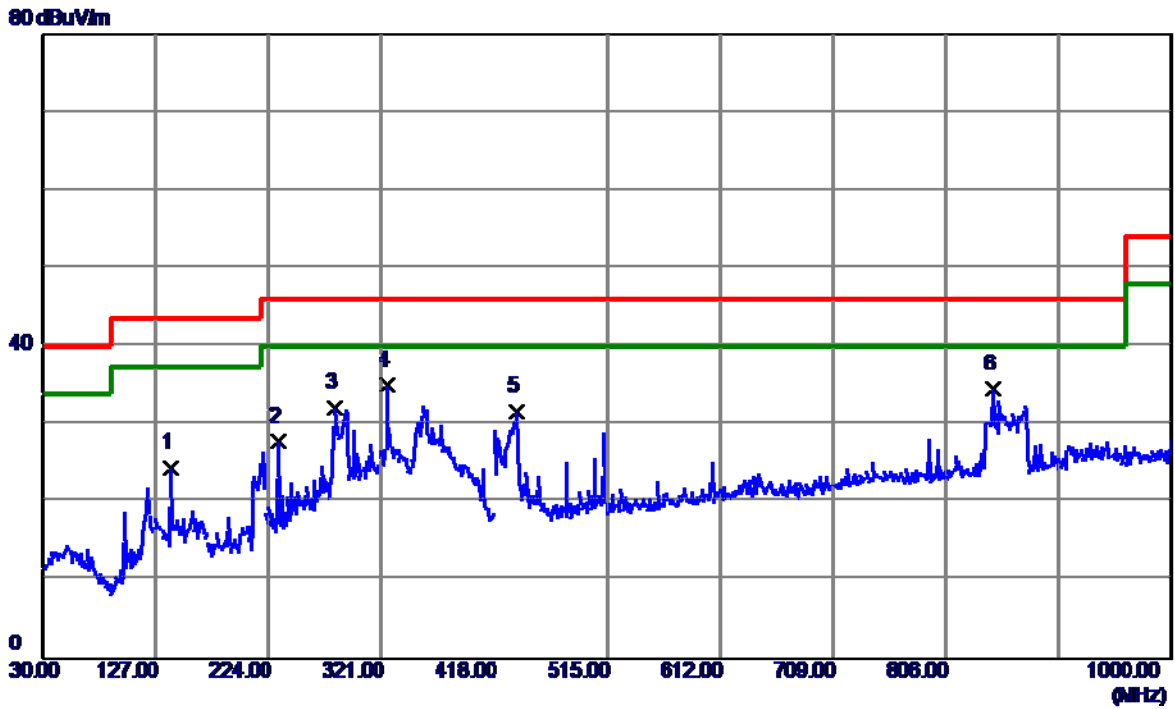

No.	Freq. MHz	Reading Level dBuV/m	Correct Factor dB	Measure ment dBuV/m	Limit dBuV/m	Margin dB	Detector
1	139.6100	46.94	-22.52	24.42	43.50	-19.08	QP
2	232.7300	52.07	-24.29	27.78	46.00	-18.22	QP
3	281.2300	53.87	-21.65	32.22	46.00	-13.78	QP
4 *	325.8500	55.70	-20.69	35.01	46.00	-10.99	QP
5	437.4000	49.54	-17.86	31.68	46.00	-14.32	QP
6	847.2250	46.20	-11.60	34.60	46.00	-11.40	QP

EUT	LCD Monitor	Model Name	24E1Q
Temperature	25°C	Relative Humidity	60%
Test Voltage	AC 120V/60Hz	Polarization	Vertical
Test Mode	HDMI 1920*1080/60Hz		
Note	1.8m		
Test Engineer	Kang Zhang		

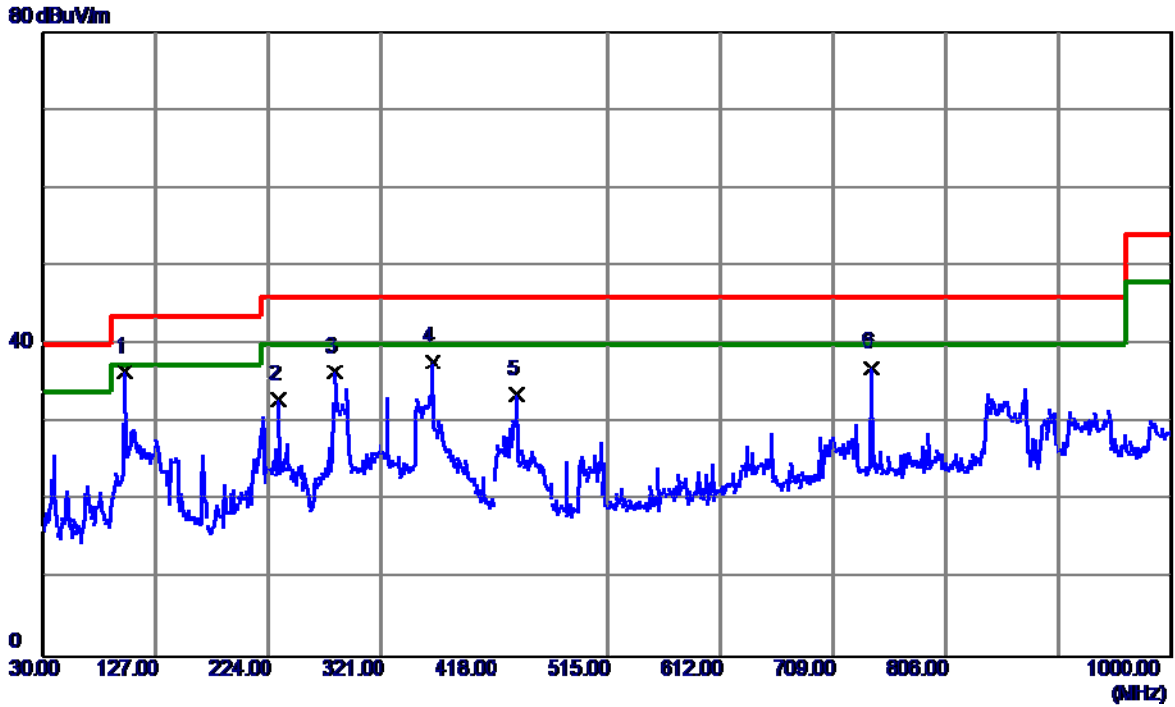

No.	Freq. MHz	Reading Level dBuV/m	Correct Factor dB	Measure ment dBuV/m	Limit dBuV/m	Margin dB	Detector
1 *	99.8399	63.34	-26.92	36.42	43.50	-7.08	QP
2	232.7300	57.18	-24.29	32.89	46.00	-13.11	QP
3	281.2300	58.13	-21.65	36.48	46.00	-9.52	QP
4	364.6500	57.63	-19.82	37.81	46.00	-8.19	QP
5	437.4000	51.41	-17.86	33.55	46.00	-12.45	QP
6	742.4650	49.50	-12.46	37.04	46.00	-8.96	QP

EUT	LCD Monitor	Model Name	24E1Q
Temperature	25°C	Relative Humidity	60%
Test Voltage	AC 120V/60Hz	Polarization	Horizontal
Test Mode	HDMI 1920*1080/60Hz		
Note	1.8m		
Test Engineer	Kang Zhang		

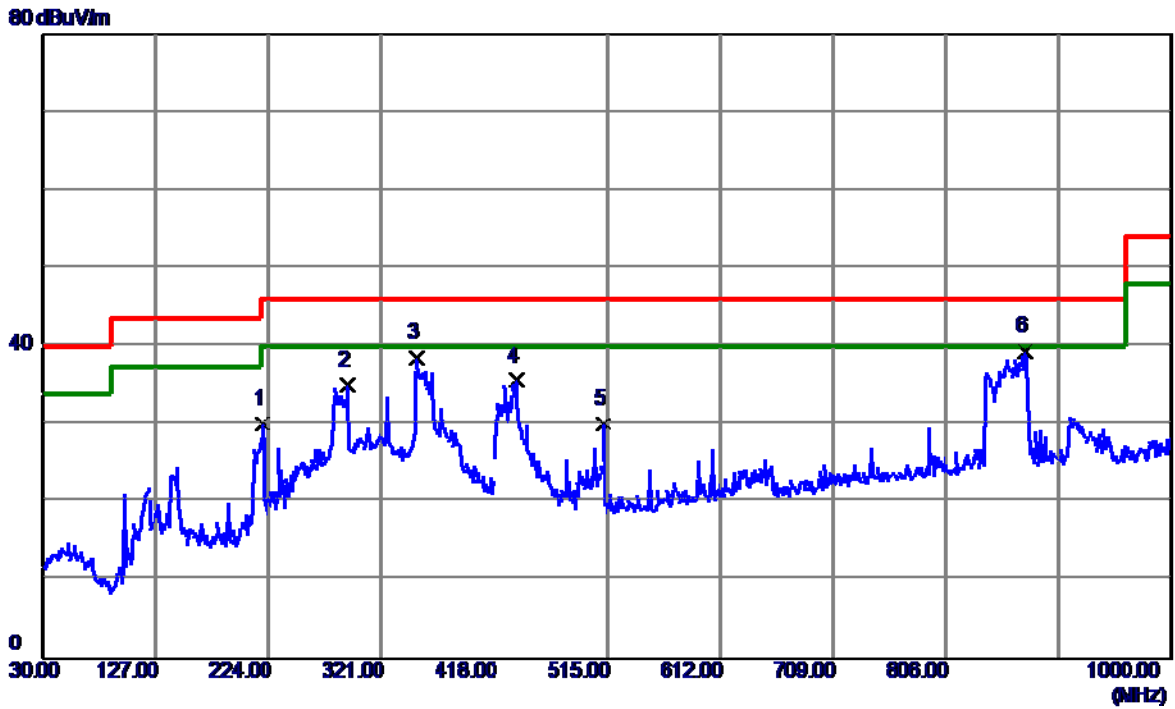

No.	Freq. MHz	Reading Level dBuV/m	Correct Factor dB	Measure ment dBuV/m	Limit dBuV/m	Margin dB	Detector
1	218.6650	55.21	-25.06	30.15	46.00	-15.85	QP
2	291.4150	56.43	-21.42	35.01	46.00	-10.99	QP
3	351.0700	58.73	-20.15	38.58	46.00	-7.42	QP
4	436.9150	53.48	-17.88	35.60	46.00	-10.40	QP
5	512.0900	46.89	-16.80	30.09	46.00	-15.91	QP
6 *	875.3550	50.46	-11.12	39.34	46.00	-6.66	QP

EUT	LCD Monitor	Model Name	24E1Q
Temperature	25°C	Relative Humidity	60%
Test Voltage	AC 120V/60Hz	Polarization	Vertical
Test Mode	HDMI 1080P		
Note	1.8m		
Test Engineer	Kang Zhang		

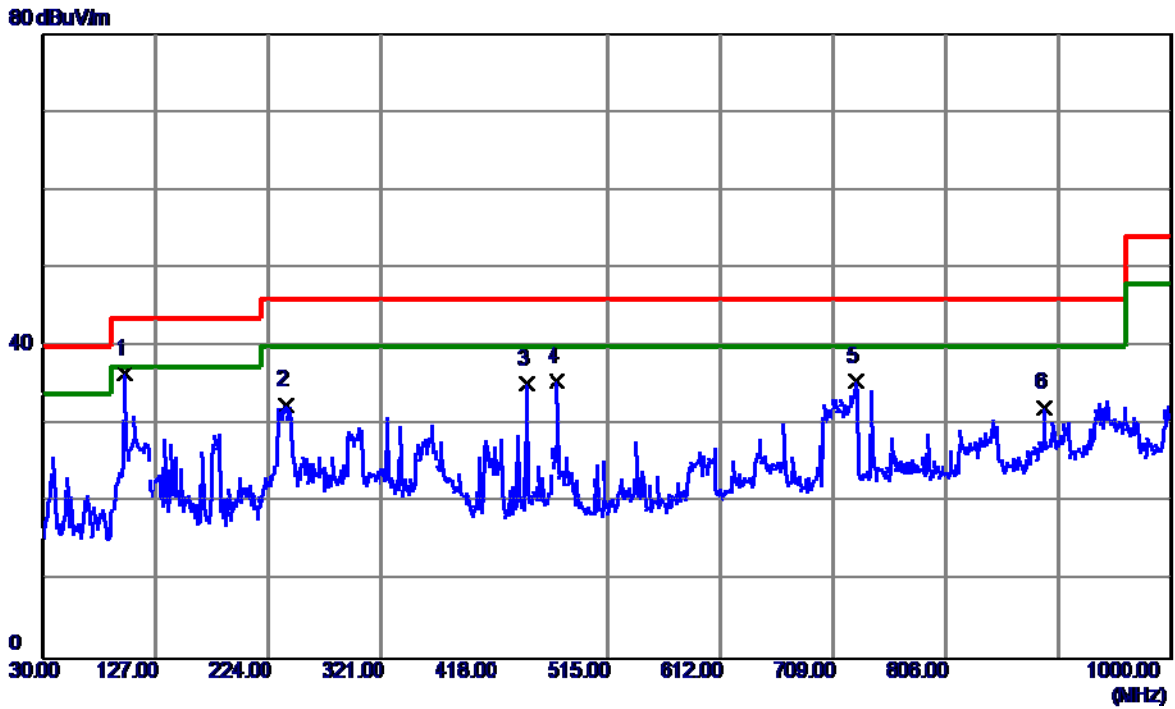

No.	Freq. MHz	Reading Level dBuV/m	Correct Factor dB	Measure ment dBuV/m	Limit dBuV/m	Margin dB	Detector
1 *	99.8399	63.47	-26.92	36.55	43.50	-6.95	QP
2	239.0350	56.00	-23.52	32.48	46.00	-13.52	QP
3	445.6450	52.90	-17.63	35.27	46.00	-10.73	QP
4	472.3200	52.80	-17.27	35.53	46.00	-10.47	QP
5	729.8550	48.45	-12.87	35.58	46.00	-10.42	QP
6	890.8750	42.99	-10.84	32.15	46.00	-13.85	QP

EUT	LCD Monitor	Model Name	24E1Q
Temperature	25°C	Relative Humidity	60%
Test Voltage	AC 120V/60Hz	Polarization	Horizontal
Test Mode	HDMI 1080P		
Note	1.8m		
Test Engineer	Kang Zhang		

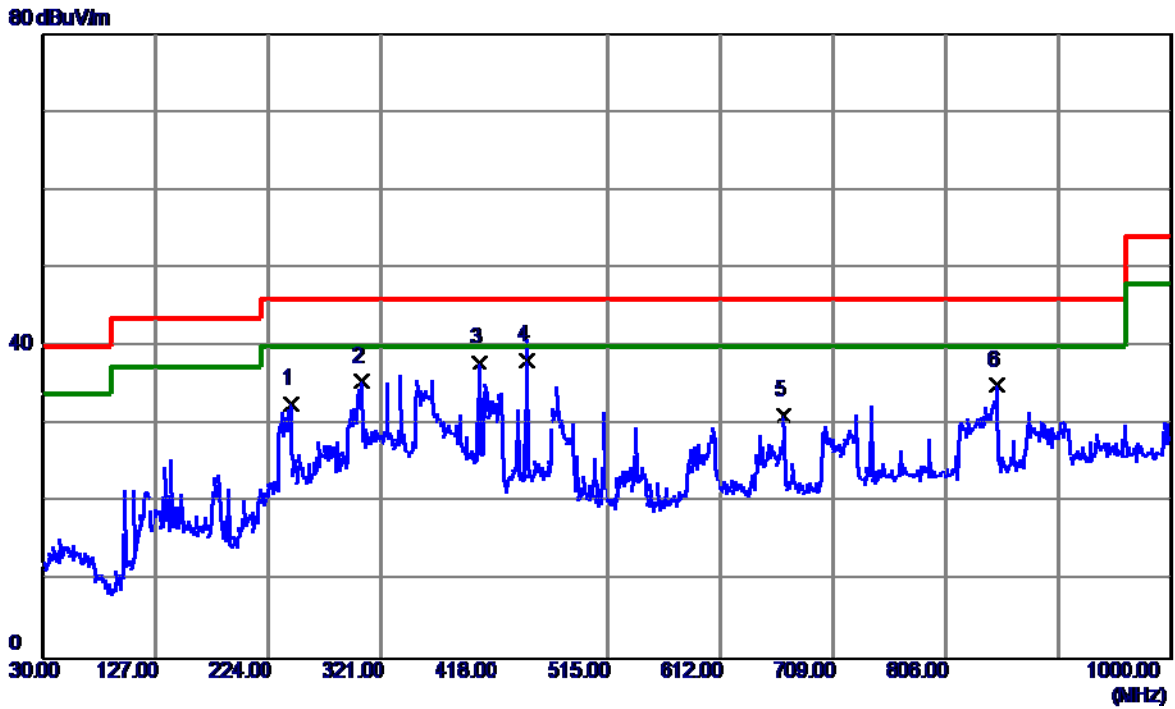

No.	Freq. MHz	Reading Level dBuV/m	Correct Factor dB	Measure ment dBuV/m	Limit dBuV/m	Margin dB	Detector
1	242.9150	55.93	-23.27	32.66	46.00	-13.34	QP
2	303.5400	56.63	-21.16	35.47	46.00	-10.53	QP
3	404.9050	56.72	-18.80	37.92	46.00	-8.08	QP
4 *	445.6450	55.91	-17.63	38.28	46.00	-7.72	QP
5	667.2900	45.18	-14.05	31.13	46.00	-14.87	QP
6	850.1350	46.67	-11.57	35.10	46.00	-10.90	QP

4.2.7 TEST RESULTS-ABOVE 1GHZ

Remark :

- (1) All readings are Peak unless otherwise stated QP in column of『 Note 』. Peak denotes that the Peak reading compliance with the QP Limits and then QP Mode measurement didn't perform.
- (2) Radiated emissions measured in frequency range above 1000MHz were made with an instrument using Peak detector mode and AV detector mode of the emission.
- (3) Data of measurement within this frequency range shown “ * ” in the table above means the reading of emissions are attenuated more than 20dB below the permissible limits or the field strength is too small to be measured.
- (4) A preamp and high pass filter were used for this test in order to provide sufficient measurement sensitivity.

EUT	LCD Monitor	Model Name	24E1Q
Temperature	25°C	Relative Humidity	60%
Test Voltage	AC 120V/60Hz	Polarization	Vertical
Test Mode	D-SUB 1920*1080/60Hz		
Note	1.8m		
Test Engineer	Kang Zhang		

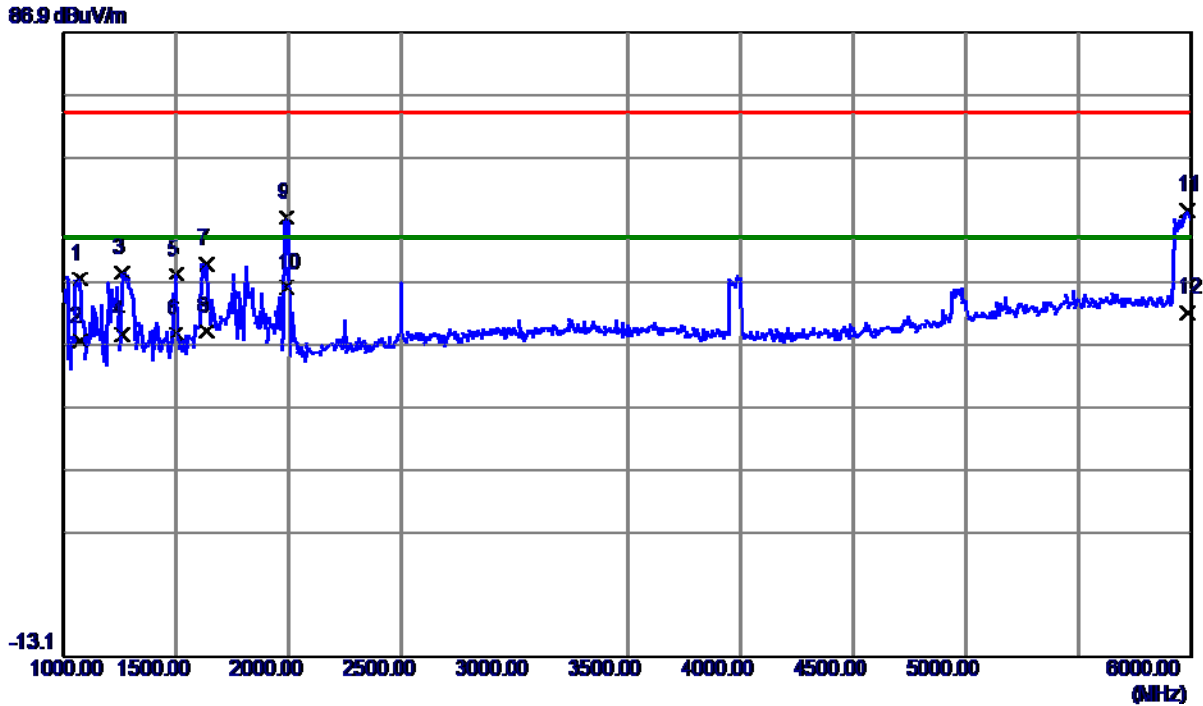

No.	Freq. MHz	Reading Level dBuV/m	Correct Factor dB	Measure ment dBuV/m	Limit dBuV/m	Margin dB	Detector
1	1070.0000	52.42	-4.97	47.45	74.00	-26.55	Peak
2	1070.0000	42.55	-4.97	37.58	54.00	-16.42	AVG
3	1262.5000	52.45	-3.92	48.53	74.00	-25.47	Peak
4	1262.5000	42.37	-3.92	38.45	54.00	-15.55	AVG
5	1497.5000	50.83	-2.63	48.20	74.00	-25.80	Peak
6	1497.5000	41.25	-2.63	38.62	54.00	-15.38	AVG
7	1632.5000	52.28	-2.34	49.94	74.00	-24.06	Peak
8	1632.5000	41.49	-2.34	39.15	54.00	-14.85	AVG
9	1990.0000	58.84	-1.59	57.25	74.00	-16.75	Peak
10 *	1990.0000	47.77	-1.59	46.18	54.00	-7.82	AVG
11	5985.0000	44.67	13.75	58.42	74.00	-15.58	Peak
12	5985.0000	28.43	13.75	42.18	54.00	-11.82	AVG

EUT	LCD Monitor	Model Name	24E1Q
Temperature	25°C	Relative Humidity	60%
Test Voltage	AC 120V/60Hz	Polarization	Horizontal
Test Mode	D-SUB 1920*1080/60Hz		
Note	1.8m		
Test Engineer	Kang Zhang		

86.9 dBuV/m

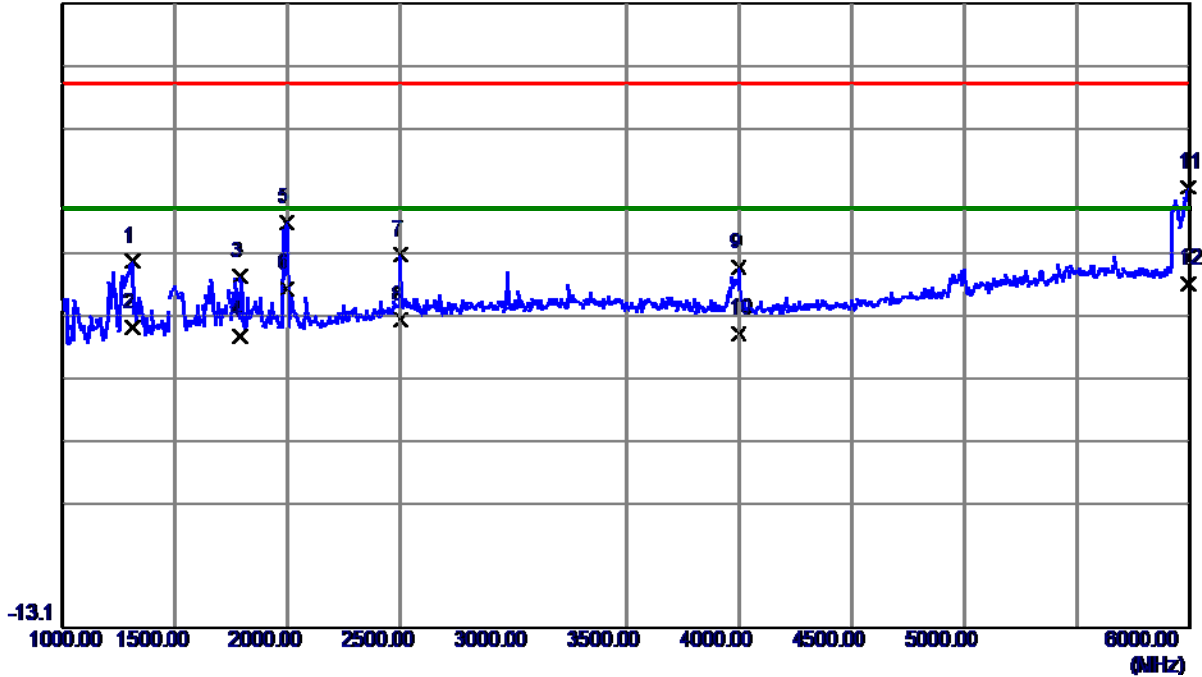

No.	Freq. MHz	Reading Level dBuV/m	Correct Factor dB	Measure ment dBuV/m	Limit dBuV/m	Margin dB	Detector
1	1312.5000	49.31	-3.64	45.67	74.00	-28.33	Peak
2	1312.5000	38.81	-3.64	35.17	54.00	-18.83	AVG
3	1790.0000	45.36	-2.01	43.35	74.00	-30.65	Peak
4	1790.0000	35.70	-2.01	33.69	54.00	-20.31	AVG
5	1992.5000	53.58	-1.59	51.99	74.00	-22.01	Peak
6	1992.5000	42.84	-1.59	41.25	54.00	-12.75	AVG
7	2500.0000	44.77	1.95	46.72	74.00	-27.28	Peak
8	2500.0000	34.33	1.95	36.28	54.00	-17.72	AVG
9	3997.5000	38.53	6.13	44.66	74.00	-29.34	Peak
10	3997.5000	28.04	6.13	34.17	54.00	-19.83	AVG
11	5995.0000	43.71	13.75	57.46	74.00	-16.54	Peak
12 *	5995.0000	28.40	13.75	42.15	54.00	-11.85	AVG

EUT	LCD Monitor	Model Name	24E1Q
Temperature	25°C	Relative Humidity	60%
Test Voltage	AC 120V/60Hz	Polarization	Vertical
Test Mode	D-SUB 1920*1080/60Hz		
Note	1.5m		
Test Engineer	Kang Zhang		

86.9 dBuV/m

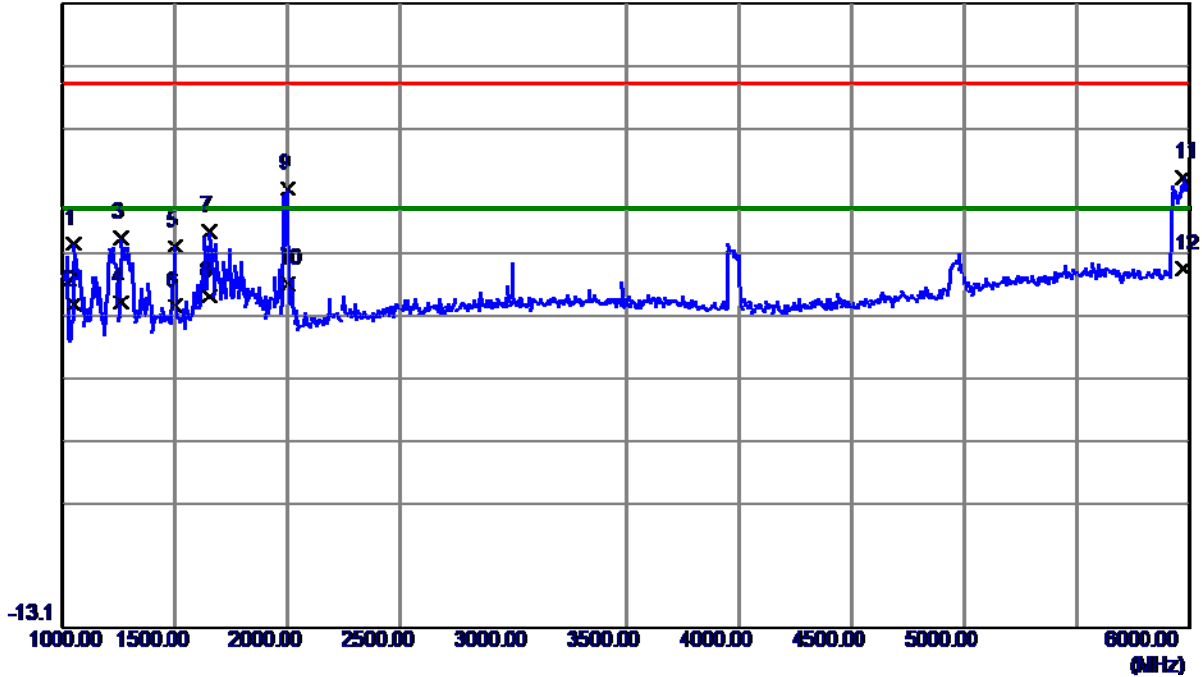

No.	Freq. MHz	Reading Level dBuV/m	Correct Factor dB	Measure ment dBuV/m	Limit dBuV/m	Margin dB	Detector
1	1052.5000	53.55	-5.06	48.49	74.00	-25.51	Peak
2	1052.5000	43.68	-5.06	38.62	54.00	-15.38	AVG
3	1262.5000	53.47	-3.92	49.55	74.00	-24.45	Peak
4	1262.5000	43.07	-3.92	39.15	54.00	-14.85	AVG
5	1500.0000	50.77	-2.62	48.15	74.00	-25.85	Peak
6	1500.0000	41.09	-2.62	38.47	54.00	-15.53	AVG
7	1650.0000	52.88	-2.31	50.57	74.00	-23.43	Peak
8	1650.0000	42.46	-2.31	40.15	54.00	-13.85	AVG
9	2000.0000	58.91	-1.57	57.34	74.00	-16.66	Peak
10	2000.0000	43.72	-1.57	42.15	54.00	-11.85	AVG
11	5975.0000	45.36	13.75	59.11	74.00	-14.89	Peak
12 *	5975.0000	30.82	13.75	44.57	54.00	-9.43	AVG

EUT	LCD Monitor	Model Name	24E1Q
Temperature	25°C	Relative Humidity	60%
Test Voltage	AC 120V/60Hz	Polarization	Horizontal
Test Mode	D-SUB 1920*1080/60Hz		
Note	1.5m		
Test Engineer	Kang Zhang		

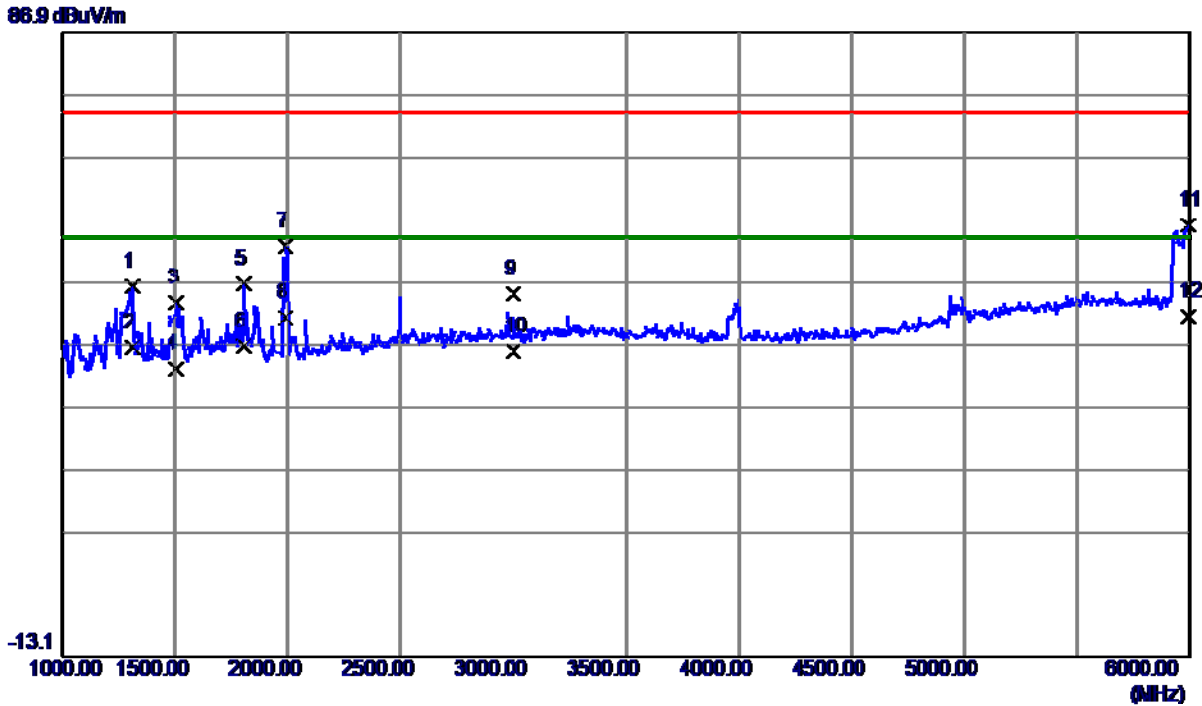

No.	Freq. MHz	Reading Level dBuV/m	Correct Factor dB	Measure ment dBuV/m	Limit dBuV/m	Margin dB	Detector
1	1310.0000	50.05	-3.66	46.39	74.00	-27.61	Peak
2	1310.0000	40.24	-3.66	36.58	54.00	-17.42	AVG
3	1505.0000	46.37	-2.61	43.76	74.00	-30.24	Peak
4	1505.0000	35.76	-2.61	33.15	54.00	-20.85	AVG
5	1805.0000	48.73	-1.98	46.75	74.00	-27.25	Peak
6	1805.0000	38.62	-1.98	36.64	54.00	-17.36	AVG
7	1990.0000	54.22	-1.59	52.63	74.00	-21.37	Peak
8	1990.0000	42.86	-1.59	41.27	54.00	-12.73	AVG
9	2997.5000	40.81	4.36	45.17	74.00	-28.83	Peak
10	2997.5000	31.61	4.36	35.97	54.00	-18.03	AVG
11	5995.0000	42.39	13.75	56.14	74.00	-17.86	Peak
12 *	5995.0000	27.72	13.75	41.47	54.00	-12.53	AVG

EUT	LCD Monitor	Model Name	24E1Q
Temperature	25°C	Relative Humidity	60%
Test Voltage	AC 120V/60Hz	Polarization	Vertical
Test Mode	D-SUB 1920*1080/60Hz		
Note	1.2m		
Test Engineer	Kang Zhang		

86.9 dBuV/m

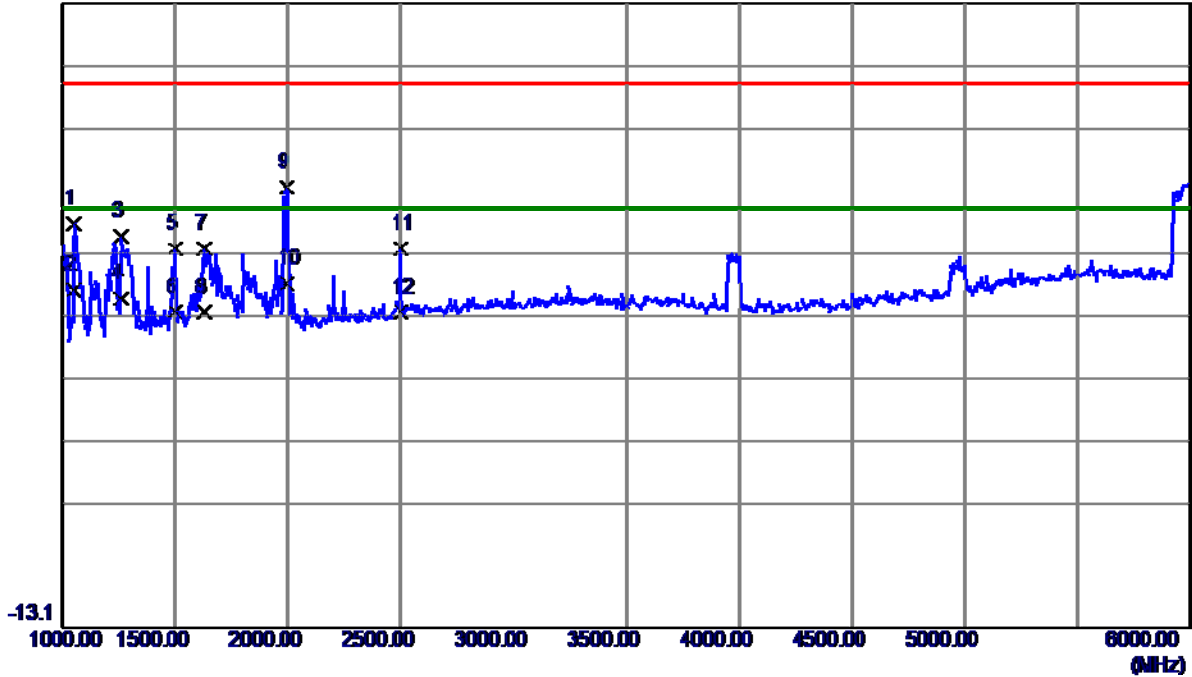

No.	Freq. MHz	Reading Level dBuV/m	Correct Factor dB	Measure ment dBuV/m	Limit dBuV/m	Margin dB	Detector
1	1052.5000	56.79	-5.06	51.73	74.00	-22.27	Peak
2	1052.5000	46.08	-5.06	41.02	54.00	-12.98	AVG
3	1262.5000	53.55	-3.92	49.63	74.00	-24.37	Peak
4	1262.5000	43.59	-3.92	39.67	54.00	-14.33	AVG
5	1500.0000	50.40	-2.62	47.78	74.00	-26.22	Peak
6	1500.0000	40.20	-2.62	37.58	54.00	-16.42	AVG
7	1630.0000	50.12	-2.35	47.77	74.00	-26.23	Peak
8	1630.0000	39.79	-2.35	37.44	54.00	-16.56	AVG
9	1995.0000	59.10	-1.58	57.52	74.00	-16.48	Peak
10 *	1995.0000	43.73	-1.58	42.15	54.00	-11.85	AVG
11	2497.5000	45.71	1.94	47.65	74.00	-26.35	Peak
12	2497.5000	35.48	1.94	37.42	54.00	-16.58	AVG

EUT	LCD Monitor	Model Name	24E1Q
Temperature	25°C	Relative Humidity	60%
Test Voltage	AC 120V/60Hz	Polarization	Horizontal
Test Mode	D-SUB 1920*1080/60Hz		
Note	1.2m		
Test Engineer	Kang Zhang		

86.9 dBuV/m

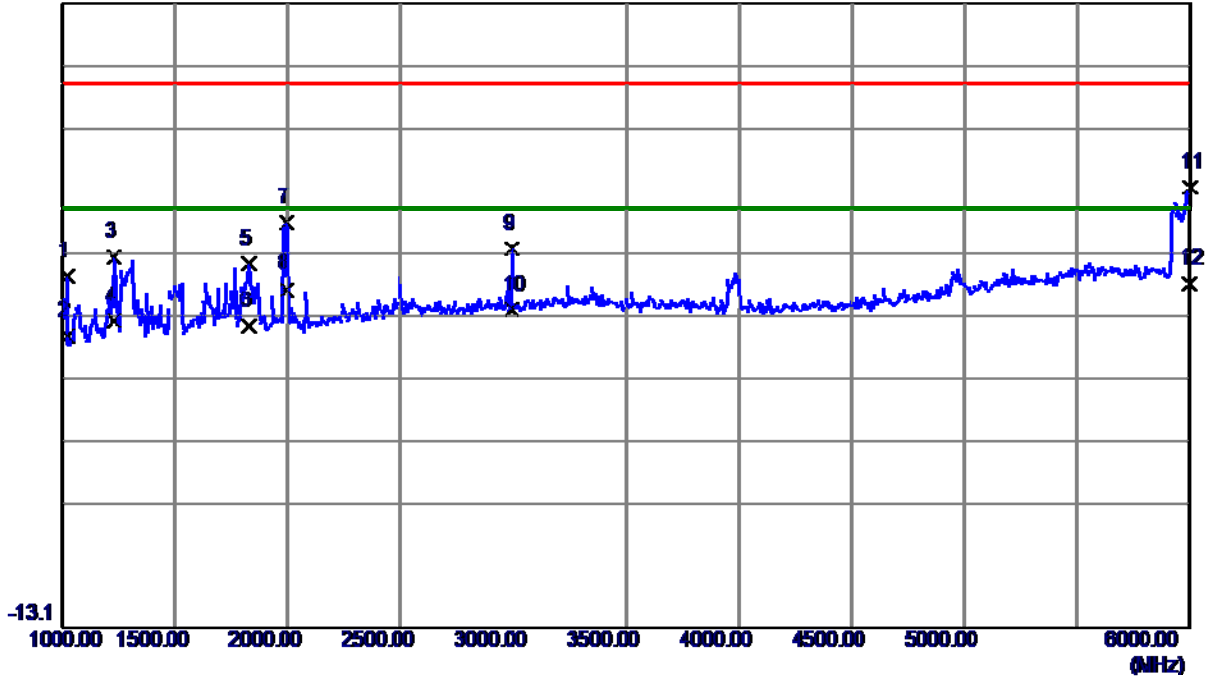

No.	Freq. MHz	Reading Level dBuV/m	Correct Factor dB	Measure ment dBuV/m	Limit dBuV/m	Margin dB	Detector
1	1020.0000	48.52	-5.24	43.28	74.00	-30.72	Peak
2	1020.0000	38.91	-5.24	33.67	54.00	-20.33	AVG
3	1230.0000	50.49	-4.09	46.40	74.00	-27.60	Peak
4	1230.0000	40.27	-4.09	36.18	54.00	-17.82	AVG
5	1830.0000	47.27	-1.93	45.34	74.00	-28.66	Peak
6	1830.0000	37.17	-1.93	35.24	54.00	-18.76	AVG
7	1992.5000	53.47	-1.59	51.88	74.00	-22.12	Peak
8	1992.5000	42.79	-1.59	41.20	54.00	-12.80	AVG
9	2992.5000	43.47	4.33	47.80	74.00	-26.20	Peak
10	2992.5000	33.65	4.33	37.98	54.00	-16.02	AVG
11	6000.0000	43.69	13.75	57.44	74.00	-16.56	Peak
12 *	6000.0000	28.40	13.75	42.15	54.00	-11.85	AVG

EUT	LCD Monitor	Model Name	24E1Q
Temperature	25°C	Relative Humidity	60%
Test Voltage	AC 120V/60Hz	Polarization	Vertical
Test Mode	HDMI 1920*1080/60Hz		
Note	1.8m		
Test Engineer	Kang Zhang		

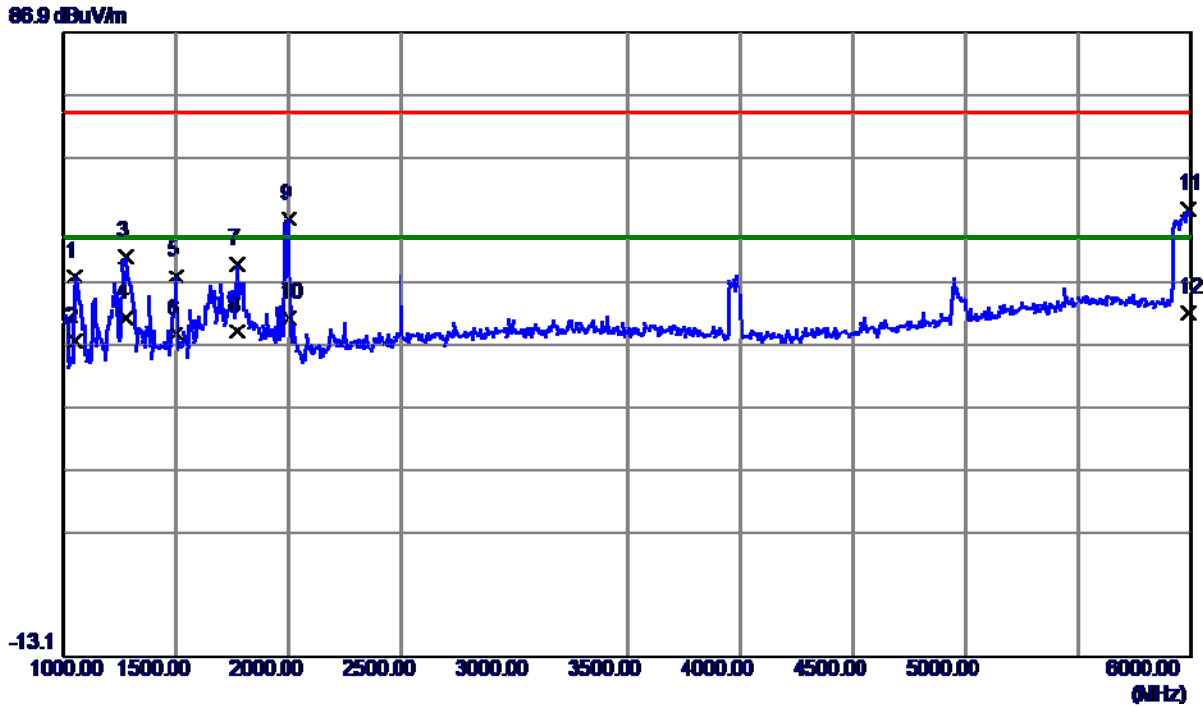

No.	Freq. MHz	Reading Level dBuV/m	Correct Factor dB	Measure ment dBuV/m	Limit dBuV/m	Margin dB	Detector
1	1052.5000	52.94	-5.06	47.88	74.00	-26.12	Peak
2	1052.5000	42.54	-5.06	37.48	54.00	-16.52	AVG
3	1277.5000	54.84	-3.83	51.01	74.00	-22.99	Peak
4	1277.5000	45.08	-3.83	41.25	54.00	-12.75	AVG
5	1500.0000	50.62	-2.62	48.00	74.00	-26.00	Peak
6	1500.0000	41.26	-2.62	38.64	54.00	-15.36	AVG
7	1770.0000	51.87	-2.05	49.82	74.00	-24.18	Peak
8	1770.0000	41.20	-2.05	39.15	54.00	-14.85	AVG
9	2000.0000	58.59	-1.57	57.02	74.00	-16.98	Peak
10	2000.0000	42.84	-1.57	41.27	54.00	-12.73	AVG
11	5987.5000	44.96	13.75	58.71	74.00	-15.29	Peak
12 *	5987.5000	28.40	13.75	42.15	54.00	-11.85	AVG

EUT	LCD Monitor	Model Name	24E1Q
Temperature	25°C	Relative Humidity	60%
Test Voltage	AC 120V/60Hz	Polarization	Horizontal
Test Mode	HDMI 1920*1080/60Hz		
Note	1.8m		
Test Engineer	Kang Zhang		

86.9 dBuV/m

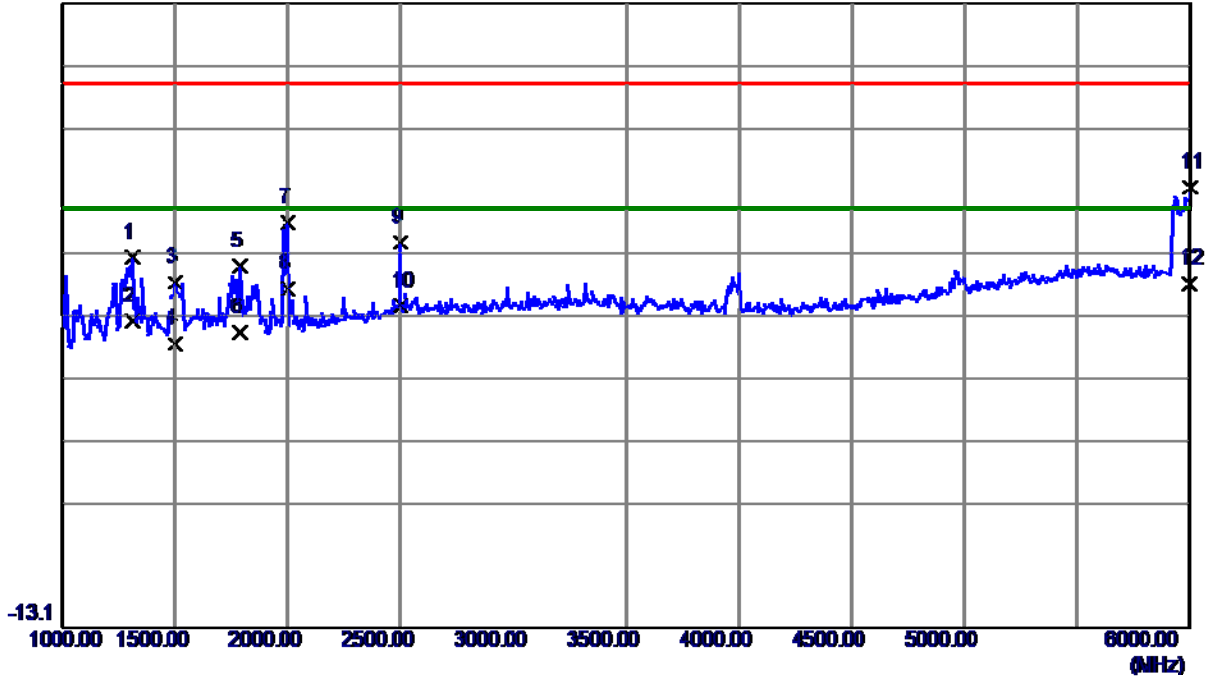

No.	Freq. MHz	Reading Level dBuV/m	Correct Factor dB	Measure ment dBuV/m	Limit dBuV/m	Margin dB	Detector
1	1310.0000	50.03	-3.66	46.37	74.00	-27.63	Peak
2	1310.0000	39.84	-3.66	36.18	54.00	-17.82	AVG
3	1500.0000	44.88	-2.62	42.26	74.00	-31.74	Peak
4	1500.0000	35.09	-2.62	32.47	54.00	-21.53	AVG
5	1787.5000	46.97	-2.02	44.95	74.00	-29.05	Peak
6	1787.5000	36.27	-2.02	34.25	54.00	-19.75	AVG
7	2000.0000	53.54	-1.57	51.97	74.00	-22.03	Peak
8	2000.0000	42.82	-1.57	41.25	54.00	-12.75	AVG
9	2497.5000	46.76	1.94	48.70	74.00	-25.30	Peak
10	2497.5000	36.54	1.94	38.48	54.00	-15.52	AVG
11	5997.5000	43.75	13.75	57.50	74.00	-16.50	Peak
12 *	5997.5000	28.40	13.75	42.15	54.00	-11.85	AVG

EUT	LCD Monitor	Model Name	24E1Q
Temperature	25°C	Relative Humidity	60%
Test Voltage	AC 120V/60Hz	Polarization	Vertical
Test Mode	HDMI 1080P		
Note	1.8m		
Test Engineer	Kang Zhang		

86.9 dBuV/m

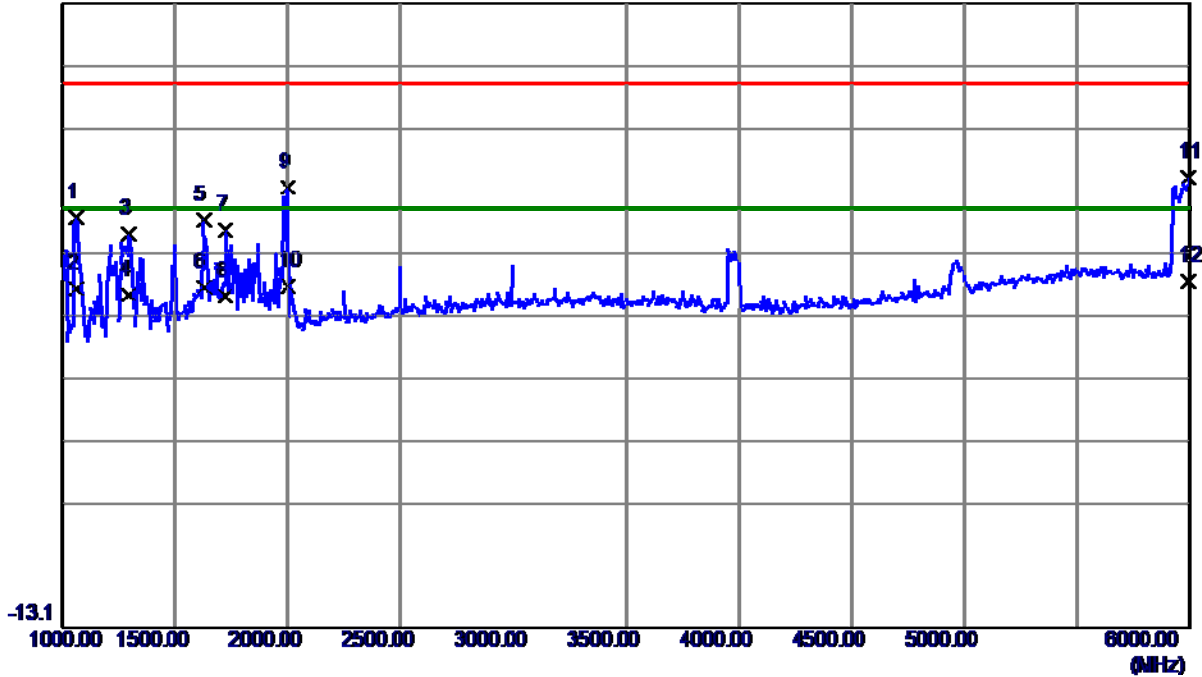

No.	Freq. MHz	Reading Level dBuV/m	Correct Factor dB	Measure ment dBuV/m	Limit dBuV/m	Margin dB	Detector
1	1060.0000	57.68	-5.02	52.66	74.00	-21.34	Peak
2	1060.0000	46.30	-5.02	41.28	54.00	-12.72	AVG
3	1292.5000	53.77	-3.75	50.02	74.00	-23.98	Peak
4	1292.5000	44.14	-3.75	40.39	54.00	-13.61	AVG
5	1625.0000	54.64	-2.36	52.28	74.00	-21.72	Peak
6	1625.0000	43.91	-2.36	41.55	54.00	-12.45	AVG
7	1720.0000	52.81	-2.16	50.65	74.00	-23.35	Peak
8	1720.0000	42.33	-2.16	40.17	54.00	-13.83	AVG
9	2000.0000	59.13	-1.57	57.56	74.00	-16.44	Peak
10	2000.0000	43.19	-1.57	41.62	54.00	-12.38	AVG
11	5995.0000	45.34	13.75	59.09	74.00	-14.91	Peak
12 *	5995.0000	28.83	13.75	42.58	54.00	-11.42	AVG

EUT	LCD Monitor	Model Name	24E1Q
Temperature	25°C	Relative Humidity	60%
Test Voltage	AC 120V/60Hz	Polarization	Horizontal
Test Mode	HDMI 1080P		
Note	1.8m		
Test Engineer	Kang Zhang		

86.9 dBuV/m

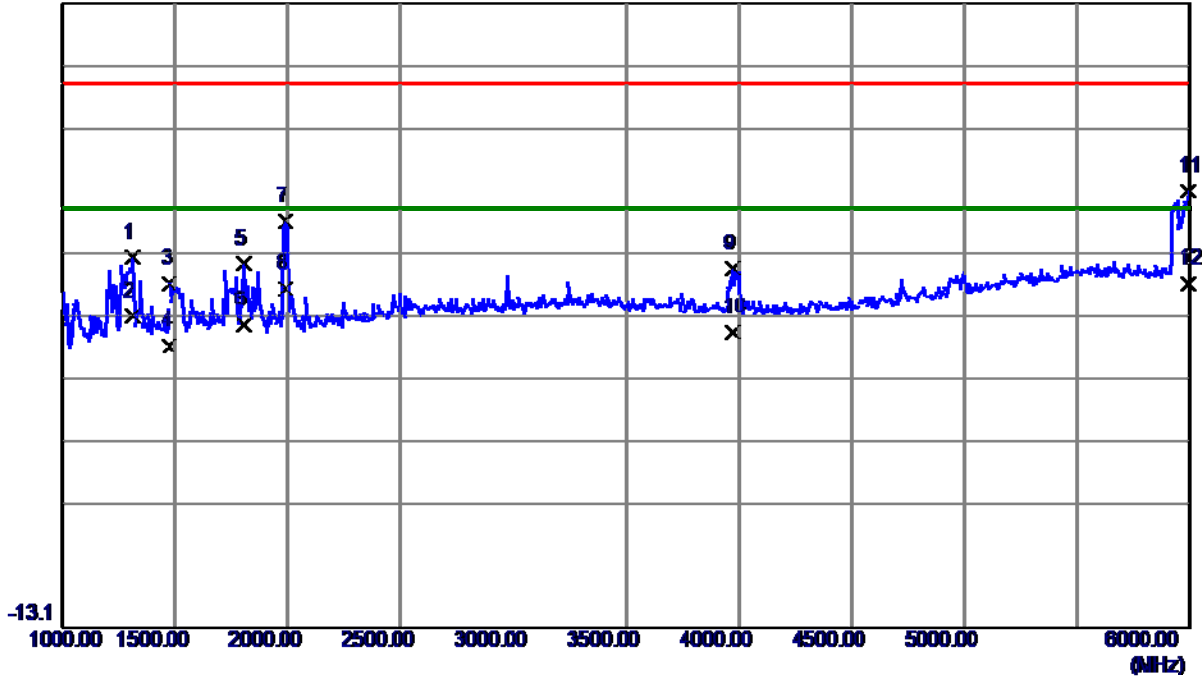

No.	Freq. MHz	Reading Level dBuV/m	Correct Factor dB	Measure ment dBuV/m	Limit dBuV/m	Margin dB	Detector
1	1312.5000	50.03	-3.64	46.39	74.00	-27.61	Peak
2	1312.5000	40.59	-3.64	36.95	54.00	-17.05	AVG
3	1475.0000	44.83	-2.76	42.07	74.00	-31.93	Peak
4	1475.0000	34.93	-2.76	32.17	54.00	-21.83	AVG
5	1805.0000	47.29	-1.98	45.31	74.00	-28.69	Peak
6	1805.0000	37.43	-1.98	35.45	54.00	-18.55	AVG
7	1987.5000	53.69	-1.60	52.09	74.00	-21.91	Peak
8	1987.5000	42.88	-1.60	41.28	54.00	-12.72	AVG
9	3972.5000	38.35	6.10	44.45	74.00	-29.55	Peak
10	3972.5000	28.19	6.10	34.29	54.00	-19.71	AVG
11	5992.5000	43.07	13.75	56.82	74.00	-17.18	Peak
12 *	5992.5000	28.36	13.75	42.11	54.00	-11.89	AVG

5. EUT TEST PHOTO

Conducted Emission



Radiated emission below 1 GHz

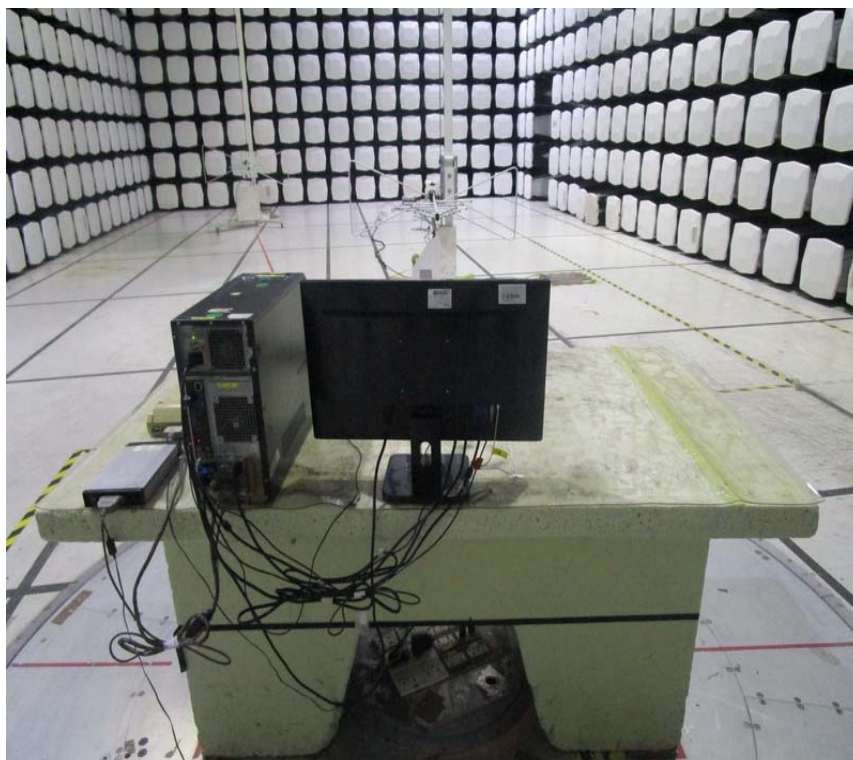

Radiated emission above 1 GHz

