

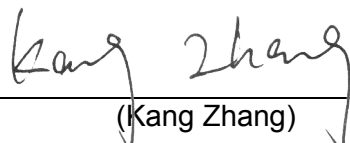

CE EMC Test Report

Project No. : 1905C011
Equipment : LCD Monitor
Test Model : 22B2
Series Model : **22B2***** (*=0-9, A-Z, a-z, +, -, /, \ or blank)
Applicant : TPV Electronics (Fujian) Co., Ltd.
Address : Rongqiao Economic and Technological Development
Zone, Fuqing City, Fujian Province, P.R. China

Date of Receipt : May 07, 2019
Date of Test : May 10, 2019 ~ May 30, 2019
Issued Date : Jun. 12, 2019
Tested by : BTL Inc.

Testing Engineer : 
(Kang Zhang)
Technical Manager : 
(Bill Zhang)
Authorized Signatory : 
(Kevin Li)

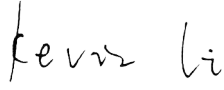
B T L I N C .

No.3, Jinshagang 1st Road, Shixia, Dalang Town, Dongguan,
Guangdong, China.

TEL: +86-769-8318-3000 FAX: +86-769-8319-6000



Certificate #5123.02

Declaration

BTL represents to the client that testing is done in accordance with standard procedures as applicable and that test instruments used has been calibrated with standards traceable to international standard(s) and/or national standard(s).

BTL's reports apply only to the specific samples tested under conditions. It is manufacture's responsibility to ensure that additional production units of this model are manufactured with the identical electrical and mechanical components. **BTL** shall have no liability for any declarations, inferences or generalizations drawn by the client or others from **BTL** issued reports.

The report must not be used by the client to claim product certification, approval, or endorsement by NVLAP, NIST, A2LA, or any agency of the U.S. Government.

This report is the confidential property of the client. As a mutual protection to the clients, the public and ourselves, the test report shall not be reproduced, except in full, without our written approval.

BTL's laboratory quality assurance procedures are in compliance with the **ISO/IEC 17025** requirements, and accredited by the conformity assessment authorities listed in this test report.

BTL is not responsible for the sampling stage, so the results only apply to the sample as received.

The information, data and test plan are provided by manufacturer which may affect the validity of results, so it is manufacturer's responsibility to ensure that the apparatus meets the essential requirements of applied standards and in all the possible configurations as representative of its intended use.

Limitation

For the use of the authority's logo is limited unless the Test Standard(s)/Scope(s)/Item(s) mentioned in this test report is (are) included in the conformity assessment authorities acceptance respective.

Please note that the measurement uncertainty is provided for informational purpose only and are not use in determining the Pass/Fail results.

Table of Contents**Page**

REPORT ISSUED HISTORY	6
1 . GENERAL SUMMARY	7
2 . SUMMARY OF TEST RESULTS	8
2.1 TEST FACILITY	10
2.2 MEASUREMENT UNCERTAINTY	10
3 . GENERAL INFORMATION	12
3.1 GENERAL DESCRIPTION OF EUT	12
3.2 DESCRIPTION OF TEST MODES	13
3.3 EUT OPERATING CONDITIONS	14
3.4 BLOCK DIAGRAM SHOWING THE CONFIGURATION OF SYSTEM TESTED	14
3.5 DESCRIPTION OF SUPPORT UNITS	15
4 . EMC EMISSION TEST- EN55032:2012+AC:2013 & 2015	16
4.1 RADIATED EMISSION	16
4.1.1 LIMITS	16
4.1.2 MEASUREMENT INSTRUMENTS LIST	17
4.1.3 TEST PROCEDURE	18
4.1.4 DEVIATION FROM TEST STANDARD	19
4.1.5 TEST SETUP	19
4.1.6 MEASUREMENT DISTANCE	20
4.1.7 TEST RESULTS (UP TO 1 GHZ)	21
4.1.8 TEST RESULTS (ABOVE TO 1 GHZ)	29
4.2 CONDUCTED EMISSION MEASUREMENT AT AC MAINS POWER PORTS	37
4.2.1 LIMITS	37
4.2.2 MEASUREMENT INSTRUMENTS LIST	37
4.2.3 TEST PROCEDURE	38
4.2.4 DEVIATION FROM TEST STANDARD	38
4.2.5 TEST SETUP	38
4.2.6 TEST RESULTS	39
5 . EMC EMISSION TEST- EN 55032:2015+AC:2016	47
5.1 RADIATED EMISSION	47
5.1.1 LIMITS	47
5.1.2 MEASUREMENT INSTRUMENTS LIST	49
5.1.3 TEST PROCEDURE	50
5.1.4 DEVIATION FROM TEST STANDARD	51
5.1.5 TEST SETUP	51
5.1.6 MEASUREMENT DISTANCE	52

Table of Contents	Page
5.1.7 TEST RESULTS (UP TO 1 GHZ)	53
5.1.8 TEST RESULTS (ABOVE 1 GHZ)	55
5.2 CONDUCTED EMISSION MEASUREMENT AT AC MAINS POWER PORTS	57
5.2.1 LIMITS	57
5.2.2 MEASUREMENT INSTRUMENTS LIST	57
5.2.3 TEST PROCEDURE	58
5.2.4 DEVIATION FROM TEST STANDARD	58
5.2.5 TEST SETUP	58
5.2.6 TEST RESULTS	59
6 . HARMONIC AND FLICKER TEST	61
6.1 HARMONIC CURRENT EMISSIONS	61
6.1.1 LIMITS	61
6.1.2 MEASUREMENT INSTRUMENTS LIST	61
6.1.3 TEST PROCEDURE	62
6.1.4 DEVIATION FROM TEST STANDARD	62
6.1.5 TEST SETUP	62
6.1.6 TEST RESULTS	63
6.2 VOLTAGE CHANGES, VOLTAGE FLUCTUATIONS AND FLICKER TEST	66
6.2.1 LIMITS	66
6.2.2 MEASUREMENT INSTRUMENTS LIST	66
6.2.3 TEST PROCEDURE	66
6.2.4 DEVIATION FROM TEST STANDARD	66
6.2.5 TEST SETUP	67
6.2.6 TEST RESULTS	68
7 . EMC IMMUNITY TEST	69
7.1 STANDARD COMPLIANCE/SEVERITY LEVEL/CRITERIA	69
7.2 GENERAL PERFORMANCE CRITERIA	71
7.3 ELECTROSTATIC DISCHARGE IMMUNITY TEST (ESD)	72
7.3.1 TEST SPECIFICATION	72
7.3.2 MEASUREMENT INSTRUMENTS	72
7.3.3 TEST PROCEDURE	72
7.3.4 DEVIATION FROM TEST STANDARD	73
7.3.5 TEST SETUP	73
7.3.6 TEST RESULTS	74
7.4 RADIATED, RADIO-FREQUENCY, ELECTROMAGNETIC FIELD IMMUNITY TEST (RS)	77
7.4.1 TEST SPECIFICATION	77
7.4.2 MEASUREMENT INSTRUMENTS	77
7.4.3 TEST PROCEDURE	77
7.4.4 DEVIATION FROM TEST STANDARD	77

Table of Contents	Page
7.4.5 TEST SETUP	78
7.4.6 TEST RESULTS	79
7.5 ELECTRICAL FAST TRANSIENT/BURST IMMUNITY TEST (EFT/BURST)	80
7.5.1 TEST SPECIFICATION	80
7.5.2 MEASUREMENT INSTRUMENTS	80
7.5.3 TEST PROCEDURE	80
7.5.4 DEVIATION FROM TEST STANDARD	80
7.5.5 TEST SETUP	81
7.5.6 TEST RESULTS	82
7.6 SURGE IMMUNITY TEST	83
7.6.1 TEST SPECIFICATION	83
7.6.2 MEASUREMENT INSTRUMENTS	83
7.6.3 TEST PROCEDURE	83
7.6.4 DEVIATION FROM TEST STANDARD	84
7.6.5 TEST SETUP	84
7.6.6 TEST RESULTS	85
7.7 IMMUNITY TO CONDUCTED DISTURBANCES, INDUCED BY	
RADIO-FREQUENCY FIELDS TEST (CS)	86
7.7.1 TEST SPECIFICATION	86
7.7.2 MEASUREMENT INSTRUMENTS	86
7.7.3 TEST PROCEDURE	86
7.7.4 DEVIATION FROM TEST STANDARD	86
7.7.5 TEST SETUP	87
7.7.6 TEST RESULTS	88
7.8 POWER FREQUENCY MAGNETIC FIELD IMMUNITY TEST (PFMF)	89
7.8.1 TEST SPECIFICATION	89
7.8.2 MEASUREMENT INSTRUMENTS	89
7.8.3 TEST PROCEDURE	89
7.8.4 DEVIATION FROM TEST STANDARD	89
7.8.5 TEST SETUP	90
7.8.6 TEST RESULTS	91
7.9 VOLTAGE DIPS, SHORT INTERRUPTIONS AND VOLTAGE VARIATIONS	
IMMUNITY TEST	92
7.9.1 TEST SPECIFICATION	92
7.9.2 MEASUREMENT INSTRUMENTS	92
7.9.3 TEST PROCEDURE	92
7.9.4 DEVIATION FROM TEST STANDARD	92
7.9.5 TEST SETUP	93
7.9.6 TEST RESULTS	94
8 . EUT TEST PHOTO	95

REPORT ISSUED HISTORY

Report Version	Description	Issued Date
R00	Original Issue.	Jun. 12, 2019

1. GENERAL SUMMARY

Equipment : LCD Monitor
Brand Name : N/A
Test Model : 22B2
Series Model : **22B2***** (*=0-9, A-Z, a-z, +, -, /, \ or blank)
Applicant : TPV Electronics (Fujian) Co., Ltd.
Date of Test : May 10, 2019 ~ May 30, 2019
Test Sample : Engineering Sample No.: DG19050736
Standard(s) : EN 55032:2012+AC:2013 Class B
EN 55032:2015 Class B
EN 55032:2015+AC:2016 Class B
IEC 61000-3-2:2014 / EN 61000-3-2:2014 Class D
IEC 61000-3-3:2013 / EN 61000-3-3:2013
EN 55024:2010
EN 55024:2010+A1:2015
IEC 61000-4-2:2008 / EN 61000-4-2:2009
IEC 61000-4-3:2006+A1:2007+A2:2010 /
EN 61000-4-3:2006+A1:2008+A2:2010
IEC 61000-4-4:2004 / EN 61000-4-4:2004
IEC 61000-4-5:2005 / EN 61000-4-5:2006
IEC 61000-4-6:2008 / EN 61000-4-6:2009
IEC 61000-4-8:2009 / EN 61000-4-8:2010
IEC 61000-4-11:2004 / EN 61000-4-11:2004
AS/NZS CISPR 32:2015 / CISPR 32:2015+C1:2016
AS/NZS CISPR 32:2013 / CISPR 32:2012

The above equipment has been tested and found compliance with the requirement of the relative standards by BTL Inc.

The test data, data evaluation, and equipment configuration contained in our test report (Ref No. BTL-EMC-1-1905C011) were obtained utilizing the test procedures, test instruments, test sites that has been accredited by the Authority of A2LA according to the ISO/IEC 17025 quality assessment standard and technical standard(s).

2. SUMMARY OF TEST RESULTS

Test procedures according to the technical standards:

Emission					
Standard(s)	Test Item	Limit	Judgment	Remark	
EN 55032: 2012+AC:2013 EN 55032:2015 EN 55032:2015+AC:2016 AS/NZS CISPR 32:2015 AS/NZS CISPR 32:2013	Radiated emissions up to 1 GHz	Class B	PASS		
	Radiated emissions above 1 GHz	Class B	PASS	NOTE (2)	
	Radiated emissions from FM receivers	-----	N/A	NOTE (1) NOTE (6)	
	Conducted emissions AC mains power port	Class B	PASS	NOTE (7)	
	Asymmetric mode conducted emissions	AAN	-----	N/A	NOTE (1) NOTE (8)
		Current Probe	-----	N/A	
		CVP	-----	N/A	
Conducted differential voltage emissions	-----	N/A	NOTE (1) NOTE (9)		

Standard	Test Item	Limit	Judgment	Remark
EN 61000-3-2:2014	Harmonic current emissions	Class D	PASS	NOTE (3)
EN 61000-3-3:2013	Voltage changes, voltage fluctuations and flicker	-----	PASS	

Immunity EN 55024: 2010/ EN 55024: 2010+A1:2015				
Section(s)	Test Item	Performance Criterion	Judgment	Remark
EN 61000-4-2:2009	Electrostatic discharge immunity	B	PASS	
EN 61000-4-3: 2006+A1:2008+A2:2010	Radiated, radio-frequency, electromagnetic field immunity	A	PASS	
EN 61000-4-4:2004	Electrical fast transient/burst immunity	B	PASS	
EN 61000-4-5:2006	Surge immunity	B/C	PASS	NOTE (4)
EN 61000-4-6: 2009	Immunity to conducted disturbances, induced by radio-frequency fields	A	PASS	
EN 61000-4-8:2010	Power frequency magnetic field immunity	A	PASS	
EN 61000-4-11:2004	Voltage dips, short interruptions and voltage variations immunity	B / C / C	PASS	NOTE (5)

NOTE:

- (1) "N/A" denotes test is not applicable to this device.
- (2) The EUT's max operating frequency is 148.5 MHz which does exceed 108 MHz, so the test will be performed.
- (3) If the power consumption is less than 75W, there is no limit applied.
- (4) Performance Criterion C for signal ports and telecommunication ports.
Performance Criterion B for input d.c. power port and a.c. power ports.
- (5) Voltage Dips: >95% reduction – Performance Criterion B
Voltage Dips: 30% reduction – Performance Criterion C
Voltage Interruptions: >95% reduction – Performance Criterion C
- (6) If the EUT has FM function the test will be performed.
- (7) If the EUT has AC power mains port the test will be performed.
- (8)

Cable Type	Number of pairs	Measurement type	Procedures
Balanced Unscreened	1 (2 wire) ;2 (4 wire); 3 (6 wire) ;4 (8 wire)	Voltage	AAN
Balanced Unscreened	See a)	Voltage and Current	CP+CVP
Screened or Coaxial	n/a	Voltage	AAN
Screened or Coaxial	n/a	Voltage or Current	CP or CVP
Unbalanced cables	n/a	Voltage and Current	CP+CVP

Ports connected to cables with more than 4 balanced pairs or where the port is unable to function correctly when connected through an AAN.

- (9) If the EUT has tuner port the test will be performed.

2.1 TEST FACILITY

The test facilities used to collect the test data in this report is at the location of No.3, Jinshagang 1st Road, Shixia, Dalang Town, Dongguan, Guangdong, China.

2.2 MEASUREMENT UNCERTAINTY

Where relevant, the following measurement uncertainty levels have been estimated for tests performed on the EUT as specified in CISPR 16-4-2, The BTL measurement uncertainty is less than the CISPR 16-4-2 U_{cispr} requirement.

The reported uncertainty of measurement $y \pm U$, where expanded uncertainty U is based on a standard uncertainty multiplied by a coverage factor of $k=2$, providing a level of confidence of approximately **95%**.

A. Radiated emissions up to 1 GHz measurement:

Test Site	Method	Measurement Frequency Range	Ant. H / V	U, (dB)
DG-CB08 (10m)	CISPR	30MHz ~ 200MHz	V	4.54
		30MHz ~ 200MHz	H	3.98
		200MHz ~ 1,000MHz	V	3.98
		200MHz ~ 1,000MHz	H	3.76

B. Radiated emissions above 1 GHz measurement:

Test Site	Method	Measurement Frequency Range	U, (dB)
DG-CB08 (3m)	CISPR	1 ~ 6 GHz	4.02
		6 ~18 GHz	5.10

C. Conducted emissions AC mains power port measurement:

Test Site	Method	Measurement Frequency Range	U, (dB)
DG-C01	CISPR	150 kHz ~ 30MHz	3.16

D. Harmonic current emissions / Voltage changes, voltage fluctuations and flicker measurement:

Test Site	Method	Measurement Frequency Range	U, (dB)
DG-C01	EN 61000-3-2	Voltage	0.774
	EN 61000-3-3	Current	0.782

E. Immunity Measurement:

Test Site	Method	Measurement Frequency Range	U, (dB)
DG-SR02	EN 61000-4-2	Rise time t_r	14.60 %
		Peak current I_p	1.72 %
		Current at 30 ns	2.0 %
		Current at 60 ns	1.84 %
DG-CB05	EN 61000-4-3	80 MHz~1 GHz	2.175 dB
		Electrical measurements	2.267 dB
		Measuring the demodulation on analogue wired network lines	2.267 dB
		Audio breakthrough measurement, test set-up for RS 2G/3G	2.349 dB
		Audio breakthrough measurement, test set-up for RS 4G	2.413 dB
DG-SR05	EN 61000-4-4	Voltage rise time (t_r)	10.40 %
		Voltage peak value(V_P)	8.20 %
		Voltage pulse width(t_w)	6.0 %
DG-SR05	EN 61000-4-5	Voltage front time (T_{fv})	5.80 %
		Voltage peak value(V_P)	3.90 %
		Voltage duration(t_d)	0.60 %
DG-CB06	EN 61000-4-6	CDN	3.25 dB
		EM clamp	4.410 dB
		Electrical measurements	3.258 dB
		measuring the demodulation on analogue wired network lines	3.258 dB
DG-SR05	EN 61000-4-8	Magnetic Field Level	3.787 %
DG-SR05	EN 61000-4-11	voltage fall time (T_f)	2.0 %

Note: Unless specifically mentioned, the uncertainty of measurement has not been taken into account to declare the compliance or non-compliance to the specification.

3. GENERAL INFORMATION

3.1 GENERAL DESCRIPTION OF EUT

Equipment	LCD Monitor
Brand Name	N/A
Test Model	22B2
Series Model	**22B2***** (*=0-9, A-Z, a-z, +, -, /, \ or blank)
Model Difference	Only differ in model name due to marketing purpose.
Power Source	DC voltage supplied from AC/DC adapter. Model: ADPC1925EX
Power Rating	I/P: 100-240V~ 1.3A 50/60Hz O/P: 19V=1.31A
Connecting I/O Port	1* DC port 1* D-SUB port 2* HDMI port 1* Earphone port

Cable Type	Shielded Type	Ferrite Core	Length(m)	Note
D-SUB	Shielded	YES	1.8/1.5/1.2	Bonded two Ferrite Cores
HDMI	Shielded	NO	1.8/1.5/1.2	
AC Power Cord	Non-shielded	NO	1.8/1.5/1.2	

Note:

1. For a more detailed features description, please refer to the manufacturer's specifications or the user's manual.
2. Power cable 1.8m, 1.5m, 1.2m length, worst case is Power cable 1.8m with D-SUB+HDMI 1.8m length testing and recording in test report.

3.2 DESCRIPTION OF TEST MODES

To investigate the maximum EMI emission characteristics generates from EUT, the test system was pre-scanning tested base on the consideration of following EUT operation mode or test configuration mode which possible have effect on EMI emission level. Each of these EUT operation mode(s) or test configuration mode(s) mentioned above was evaluated respectively.

Pretest Mode	Description
Mode 1	D-SUB 1920*1080/60Hz
Mode 2	HDMI 1920*1080/60Hz
Mode 3	HDMI 1080P
Mode 4	HDMI 1280*1024/75Hz
Mode 5	HDMI 640*480/60Hz

For Radiated Test	
Final Test Mode	Description
Mode 1	D-SUB 1920*1080/60Hz
Mode 2	HDMI 1920*1080/60Hz
Mode 3	HDMI 1080P

For Conducted Test	
Final Test Mode	Description
Mode 1	D-SUB 1920*1080/60Hz
Mode 2	HDMI 1920*1080/60Hz
Mode 3	HDMI 1080P

For Harmonics / Flickers Test	
Final Test Mode	Description
Mode 2	HDMI 1920*1080/60Hz

For EMS Test	
Final Test Mode	Description
Mode 2	HDMI 1920*1080/60Hz

Evaluation description:

1. The maximum resolution is evaluated Mode 1-3. The worst case is Mode 2 and evaluated the middle and low resolution Mode 4 and mode 5.
2. According to the client's requirement, choose Mode 1, Mode 2, Mode 3 and recorded in test report.

3.3 EUT OPERATING CONDITIONS

The EUT exercise program used during radiated and/or conducted emission measurement was designed to exercise the various system components in a manner similar to a typical use. The standard test signals and output signal as following:

1. EUT connected to Earphone via Earphone cable.
2. EUT connected to PC via D-SUB & HDMI cable.
3. EUT connected to adapter via DC cable.
4. PC connected to Mouse and Keyboard via USB cable.

3.4 BLOCK DIAGRAM SHOWING THE CONFIGURATION OF SYSTEM TESTED

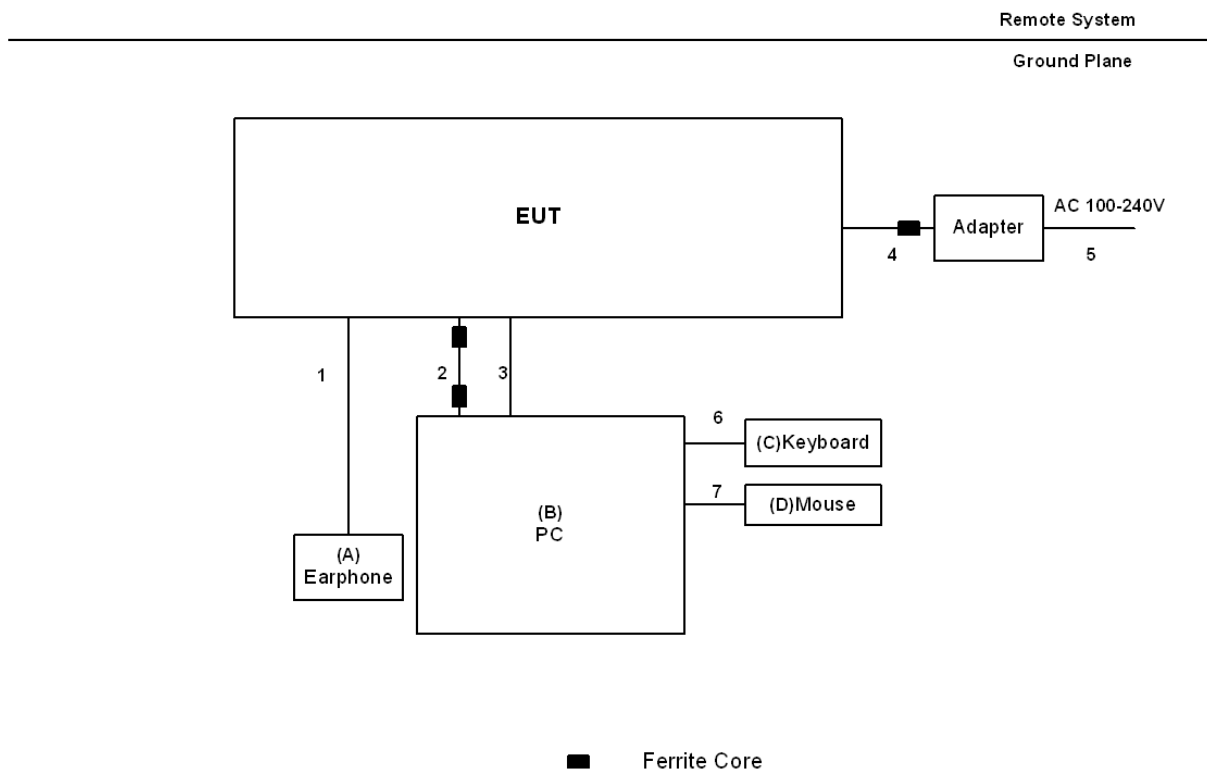

3.5 DESCRIPTION OF SUPPORT UNITS

The EUT has been tested as an independent unit together with other necessary accessories or support units. The following support units or accessories were used to form a representative test configuration during the tests.

Item	Equipment	Mfr/Brand	Model/Type No.	Series No.
A	Earphone	Apple	N/A	N/A
B	PC	DELL	ATI 3650	260832000932
C	Keyboard	DELL	Vostro 470	28747261333
D	Mouse	DELL	KB212-B	CN0HTXH97158125004DXA01

Item	Cable Type	Shielded Type	Ferrite Core	Length
1	Earphone	NO	NO	1.2m
2	D-SUB Cable	YES	YES	1.8/1.5/1.2m
3	HDMI Cable	YES	NO	1.8/1.5/1.2m
4	DC Cable	NO	YES	1.0m
5	AC Cable	NO	NO	1.8/1.5/1.2m
6	USB Cable	YES	NO	1.8m
7	USB Cable	YES	NO	1.8m

4. EMC EMISSION TEST- EN55032:2012+AC:2013 & 2015

4.1 RADIATED EMISSION

4.1.1 LIMITS

Class A equipment up to 1000MHz

Table clause	Frequency MHz	Measurement		Class A limit dB(uV/m)
		Distance m	Detector type/bandwidth	OATS/SAC
A2.1	30-230	10	Quasi peak / 120 kHz	40
	230-1000			47
A2.2	30-230	3		50
	230-1000			57

Class A equipment above 1000MHz

Table clause	Frequency MHz	Measurement		Class A limit dB(uV/m)
		Distance m	Detector type/bandwidth	FSOATS
A3.1	1000-3000	3	Average / 1 MHz	56
	3000-6000			60
A3.2	1000-3000		Peak / 1 MHz	76
	3000-6000			80

Class B equipment up to 1000MHz

Table clause	Frequency MHz	Measurement		Class B limit dB(uV/m)
		Distance m	Detector type/bandwidth	OATS/SAC
A4.1	30-230	10	Quasi peak / 120 kHz	30
	230-1000			37
A4.2	30-230	3		40
	230-1000			47

Class B equipment above 1000MHz

Table clause	Frequency MHz	Measurement		Class B limit dB(uV/m)
		Distance m	Detector type/bandwidth	FSOATS
A5.1	1000-3000	3	Average / 1 MHz	50
	3000-6000			54
A5.2	1000-3000		Peak / 1 MHz	70
	3000-6000			74

Notes:

- (1) The limit for radiated test was performed according to as following: EN 55032
- (2) The tighter limit applies at the band edges.
- (3) Emission level (dBuV/m)=20log Emission level (uV/m).
- (4) The test result calculated as following:
 Measurement Value = Reading Level + Correct Factor
 Correct Factor = Antenna Factor + Cable Loss - Amplifier Gain(if use)
 Margin Level = Measurement Value - Limit Value

Required highest frequency for radiated measurement

Highest internal frequency (F _x) MHz	Highest measured frequency MHz
F _x ≤ 108	1000
108 < F _x ≤ 500	2000
500 < F _x ≤ 1000	5000
F _x > 1000	5 th up to a maximum 6 GHz,

Note for FM and TV broadcast receiver, F_x is determined from the highest frequency generated or used excluding the local oscillator and tuned frequencies.

4.1.2 MEASUREMENT INSTRUMENTS LIST

Up to 1GHz:

Item	Kind of Equipment	Manufacturer	Type No.	Serial No.	Calibrated until
1	Receiver	Keysight	N9038A	MY54450004	Aug. 11, 2019
2	MXE EMI Receiver	Agilent	N9038A	MY53220133	Mar. 10, 2020
3	Pre-Amplifier	EMC INSTRUMENT	EMC 9135	980284	Mar. 10, 2020
4	Pre-Amplifier	EMC INSTRUMENT	EMC 9135	980283	Mar. 10, 2020
5	Trilog-Broadband Antenna	Schwarzbeck	VULB9168	946	Nov. 24, 2019
6	Trilog-Broadband Antenna	Schwarzbeck	VULB9168	947	Nov. 24, 2019
7	Cable	emci	LMR-400(5m+11m+15m)	N/A	Aug. 07, 2019
8	Cable	emci	LMR-400(5m+8m+8m)	N/A	Aug. 07, 2019
9	Measurement Software	Farad	EZ-EMC Ver.BTL-2ANT-1	N/A	N/A
10	Multi-Device Controller	ETS-Lindgren	2090	N/A	N/A
11	Attenuator	EMCI	EMCI-N-6-06	N0670	Nov. 24, 2019
12	Attenuator	EMCI	EMCI-N-6-06	N0671	Nov. 24, 2019

Remark: "N/A" denotes no model no., no serial no. or no calibration specified.
 All calibration period of equipment list is one year.

Above 1GHz:

Item	Kind of Equipment	Manufacturer	Type No.	Serial No.	Calibrated until
1	Horn Antenna	EMCO	3115	9605-4803	Mar. 23, 2020
2	Amplifier	Agilent	8449B	3008A02584	Aug. 11, 2019
3	MXE EMI Receiver	Agilent	N9038A	MY53220133	Mar. 10, 2020
4	Measurement Software	Farad	EZ-EMC Ver.BTL-2AN T-1	N/A	N/A
5	Multi-Device Controller	ETS-Lindgren	2090	N/A	N/A
6	Controller	MF	MF-7802	MF780208159	N/A
7	Cable	Mlcable Inc.	B10-01-01-5 M	18047123	Mar. 01, 2020
8	Cable	Mlcable Inc.	B10-01-01-10 M	18072746	Mar. 01, 2020
9	Cable	N/A	A50-3.5M3.5 M-1.5M-AT	18041824	Mar. 01, 2020

Remark: "N/A" denotes no model no., no serial no. or no calibration specified.

All calibration period of equipment list is one year.

4.1.3 TEST PROCEDURE

- a. The measuring distance of 10 m shall be used for measurements. The EUT was placed on the top of a rotating table 0.8 meter above the ground at a 10 meter semi-anechoic chamber. The table was rotated 360 degrees to determine the position of the highest radiation.(below 1GHz).
- b. The measuring distance of 3 m shall be used for measurements. The EUT was placed on the top of a rotating table 0.8 meter above the ground at a 10 meter semi-anechoic chamber. The table was rotated 360 degrees to determine the position of the highest radiation.(above 1GHz)
- c. The height of the equipment or of the substitution antenna shall be 0.8 m, the height of the test antenna shall vary between 1 m to 4 m. Both horizontal and vertical polarizations of the antenna are set to make the measurement.
- d. The initial step in collecting radiated emission data is a receiver peak detector mode pre-scanning the measurement frequency range. Significant peaks are then marked and then Quasi Peak detector mode re-measured.
- e. All readings are Peak unless otherwise stated QP in column of Note. Peak denotes that the Peak reading compliance with the QP Limits and then QP Mode measurement didn't perform. (below 1GHz)
- f. All readings are Peak Mode value unless otherwise stated AVG in column of Note. If the Peak Mode Measured value compliance with the Peak Limits and lower than AVG Limits, the EUT shall be deemed to meet both Peak & AVG Limits and then only Peak Mode was measured, but AVG Mode didn't perform. (above 1GHz)
- g. For the actual test configuration, please refer to the related Item - Block Diagram of system tested (please refer to 3.4).

4.1.4 DEVIATION FROM TEST STANDARD

No deviation

4.1.5 TEST SETUP

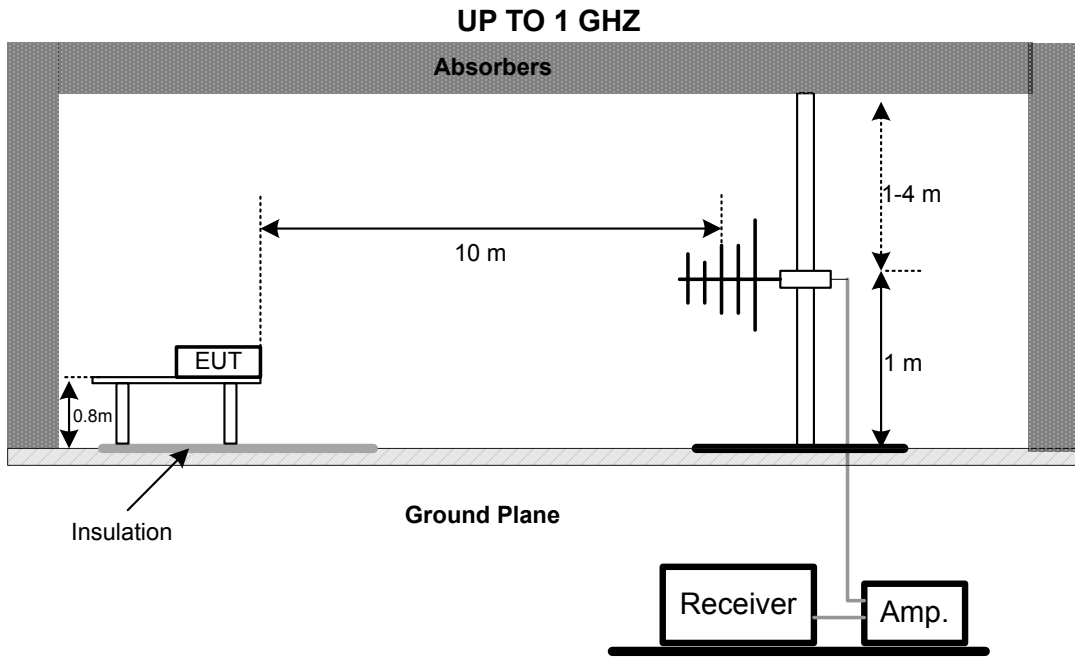

Note: The antenna can be moved between 1 to 4 meters above the ground.

ABOVE 1 GHZ

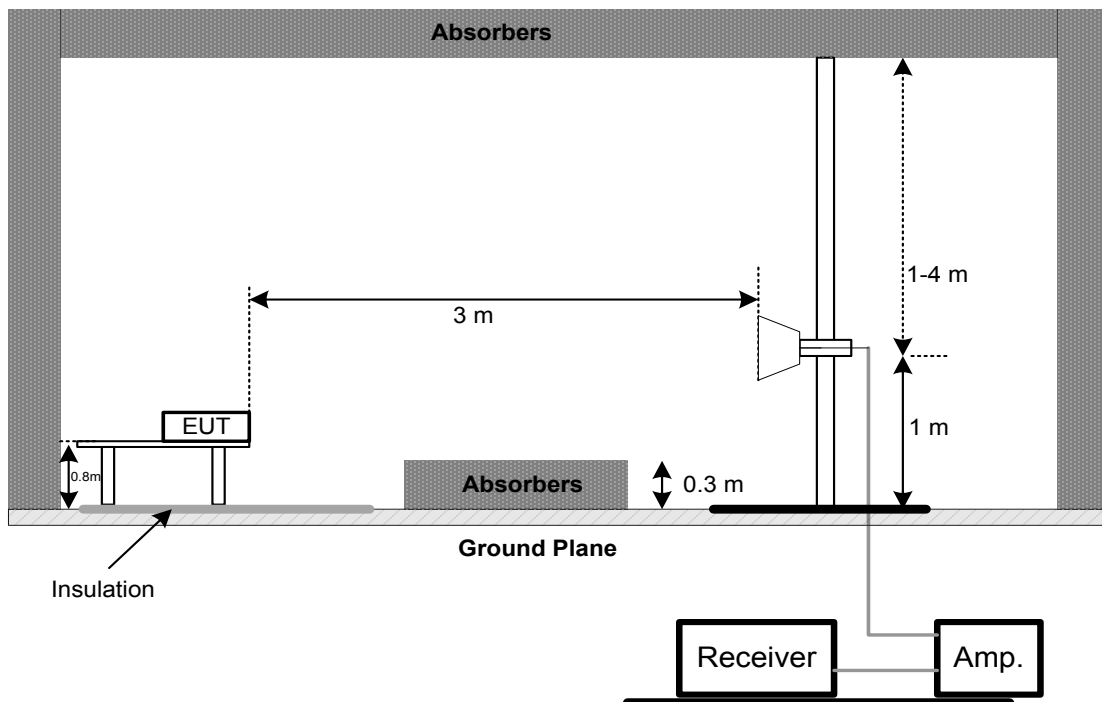

4.1.6 MEASUREMENT DISTANCE

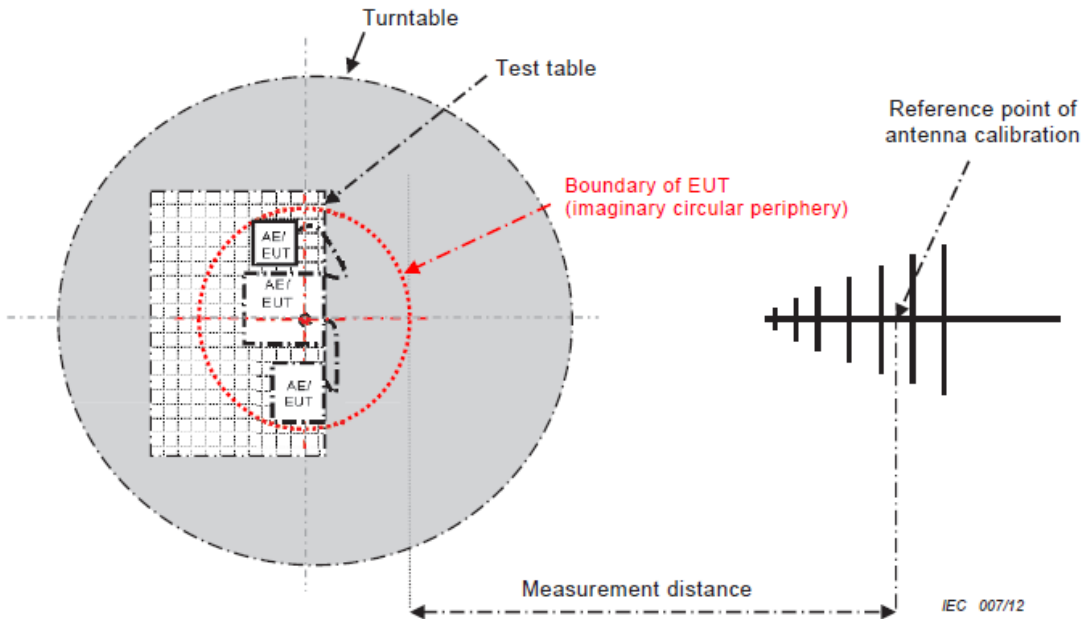

- 34 -

CISPR 32 © IEC:2012

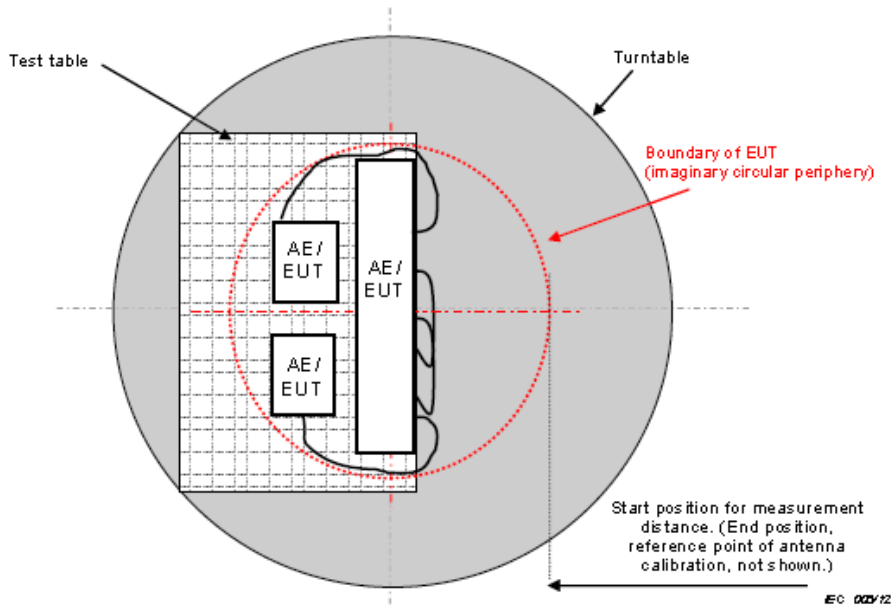
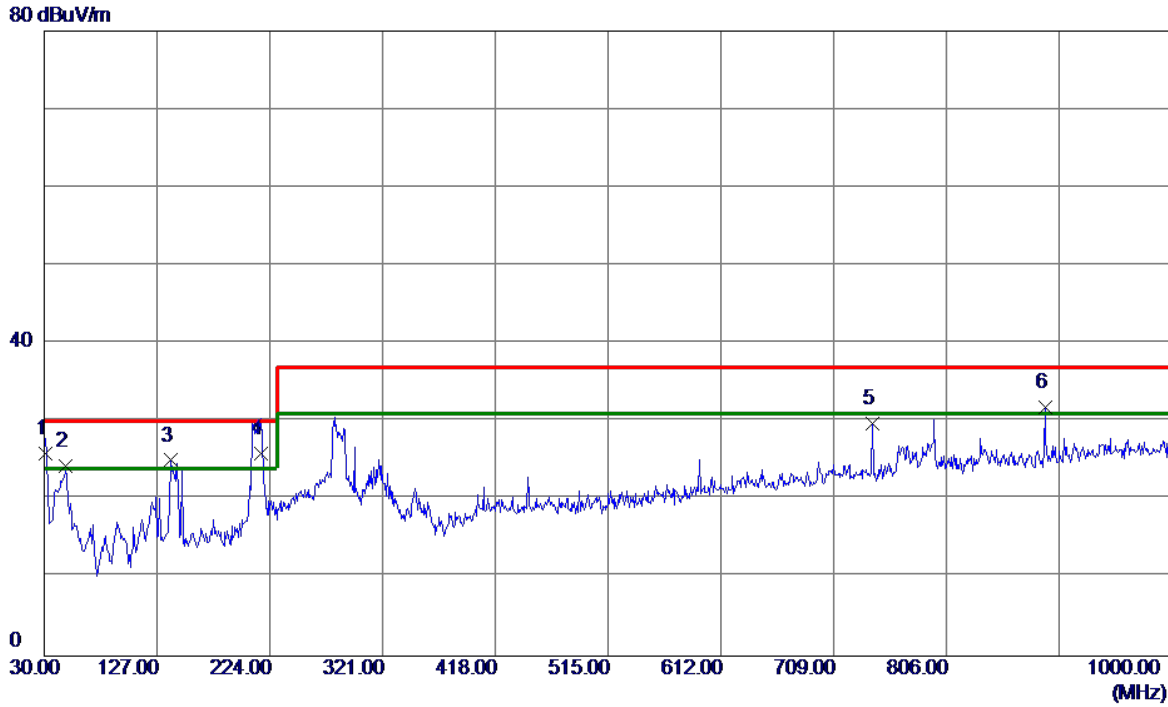

Figure C.2 – Boundary of EUT, Local AE and associated cabling

4.1.7 TEST RESULTS (UP TO 1 GHZ)

EUT	LCD Monitor	Test Model	22B2
Temperature	25°C	Relative Humidity	60%
Test Voltage	AC 230V/50Hz	Polarization	Vertical
Test Mode	D-SUB 1920*1080/60Hz		
Test Engineer	Kang		



No.	Freq. MHz	Reading Level dBuV/m	Correct Factor dB	Measure ment dBuV/m	Limit dBuV/m	Margin dB	Detector
1 *	30.9700	44.38	-18.46	25.92	30.00	-4.08	QP
2	48.4300	40.91	-16.62	24.29	30.00	-5.71	QP
3	139.1250	41.67	-16.63	25.04	30.00	-4.96	QP
4	216.2400	44.99	-19.09	25.90	30.00	-4.10	QP
5	742.4650	36.15	-6.35	29.80	37.00	-7.20	QP
6	890.8750	36.39	-4.59	31.80	37.00	-5.20	QP

EUT	LCD Monitor	Test Model	22B2
Temperature	25°C	Relative Humidity	60%
Test Voltage	AC 230V/50Hz	Polarization	Horizontal
Test Mode	D-SUB 1920*1080/60Hz		
Test Engineer	Kang		

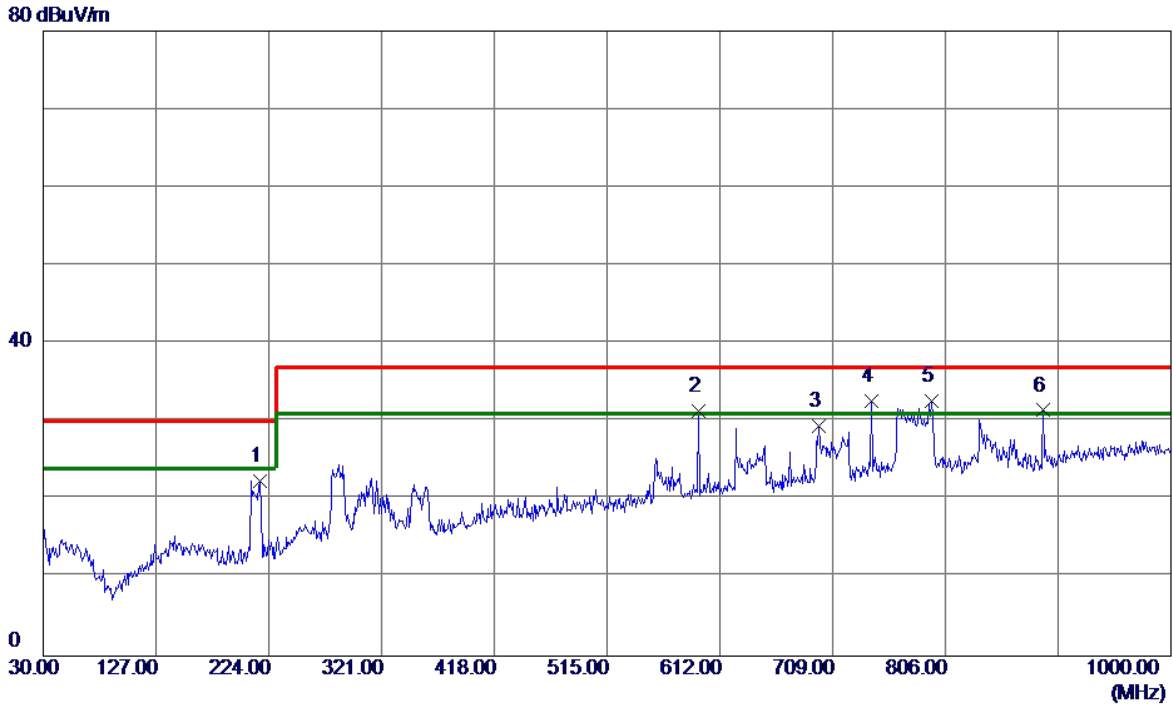

No.	Freq. MHz	Reading Level dBuV/m	Correct Factor dB	Measure ment dBuV/m	Limit dBuV/m	Margin dB	Detector
1	216.2400	41.78	-19.32	22.46	30.00	-7.54	QP
2	593.5700	40.06	-8.73	31.33	37.00	-5.67	QP
3	697.3600	36.64	-7.21	29.43	37.00	-7.57	QP
4 *	741.9800	39.16	-6.46	32.70	37.00	-4.30	QP
5	794.3600	38.61	-5.99	32.62	37.00	-4.38	QP
6	890.3900	36.44	-5.00	31.44	37.00	-5.56	QP

EUT	LCD Monitor	Test Model	22B2
Temperature	25°C	Relative Humidity	60%
Test Voltage	AC 230V/50Hz	Polarization	Vertical
Test Mode	HDMI 1920*1080/60Hz		
Test Engineer	Kang		

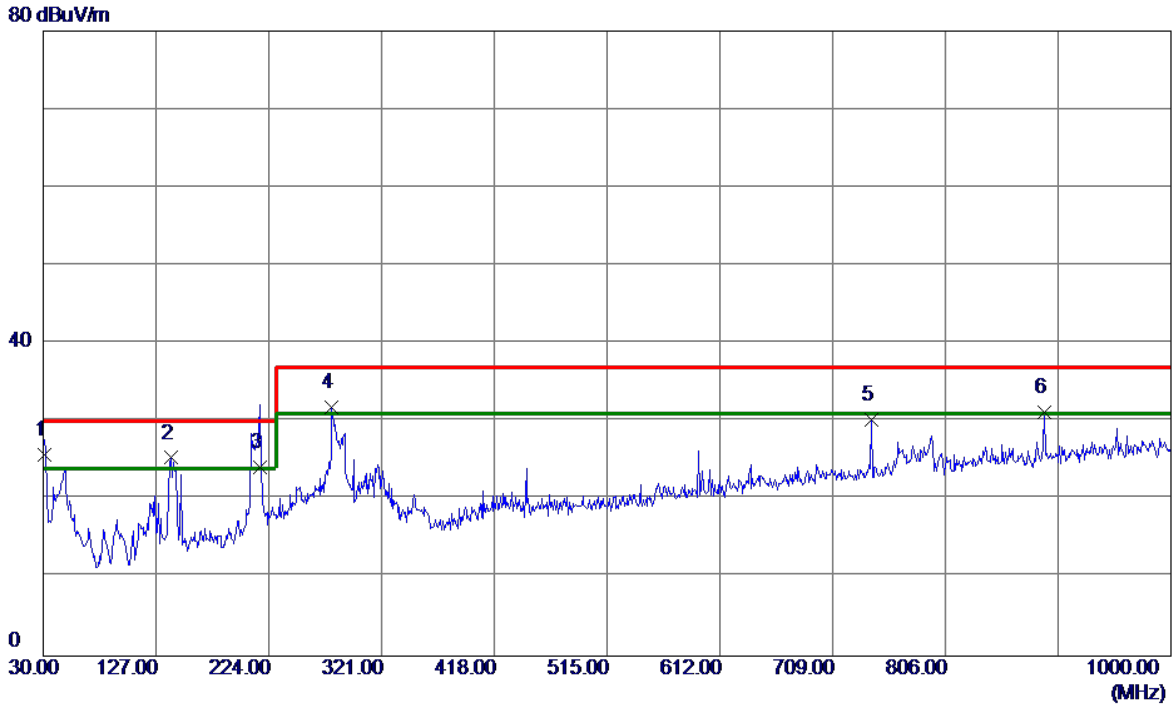

No.	Freq. MHz	Reading Level dBuV/m	Correct Factor dB	Measure ment dBuV/m	Limit dBuV/m	Margin dB	Detector
1 *	30.9700	44.16	-18.46	25.70	30.00	-4.30	QP
2	139.6100	41.93	-16.57	25.36	30.00	-4.64	QP
3	216.7250	43.20	-19.09	24.11	30.00	-5.89	QP
4	278.3200	47.63	-15.77	31.86	37.00	-5.14	QP
5	742.4650	36.65	-6.35	30.30	37.00	-6.70	QP
6	890.8750	35.82	-4.59	31.23	37.00	-5.77	QP

EUT	LCD Monitor	Test Model	22B2
Temperature	25°C	Relative Humidity	60%
Test Voltage	AC 230V/50Hz	Polarization	Horizontal
Test Mode	HDMI 1920*1080/60Hz		
Test Engineer	Kang		

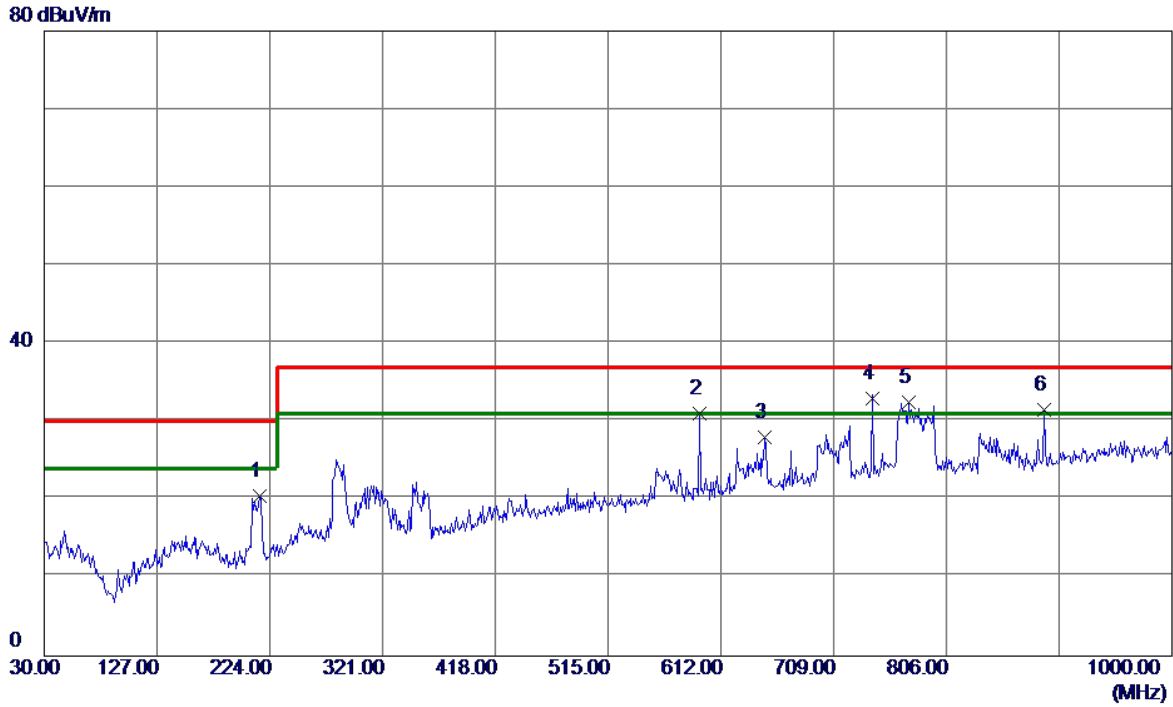

No.	Freq. MHz	Reading Level dBuV/m	Correct Factor dB	Measure ment dBuV/m	Limit dBuV/m	Margin dB	Detector
1	215.2700	39.75	-19.31	20.44	30.00	-9.56	QP
2	593.5700	39.75	-8.73	31.02	37.00	-5.98	QP
3	649.8300	35.91	-7.96	27.95	37.00	-9.05	QP
4 *	741.9800	39.40	-6.46	32.94	37.00	-4.06	QP
5	773.9900	38.69	-6.15	32.54	37.00	-4.46	QP
6	890.3900	36.56	-5.00	31.56	37.00	-5.44	QP

EUT	LCD Monitor	Test Model	22B2
Temperature	25°C	Relative Humidity	60%
Test Voltage	AC 230V/50Hz	Polarization	Vertical
Test Mode	HDMI 1080P		
Test Engineer	Kang		

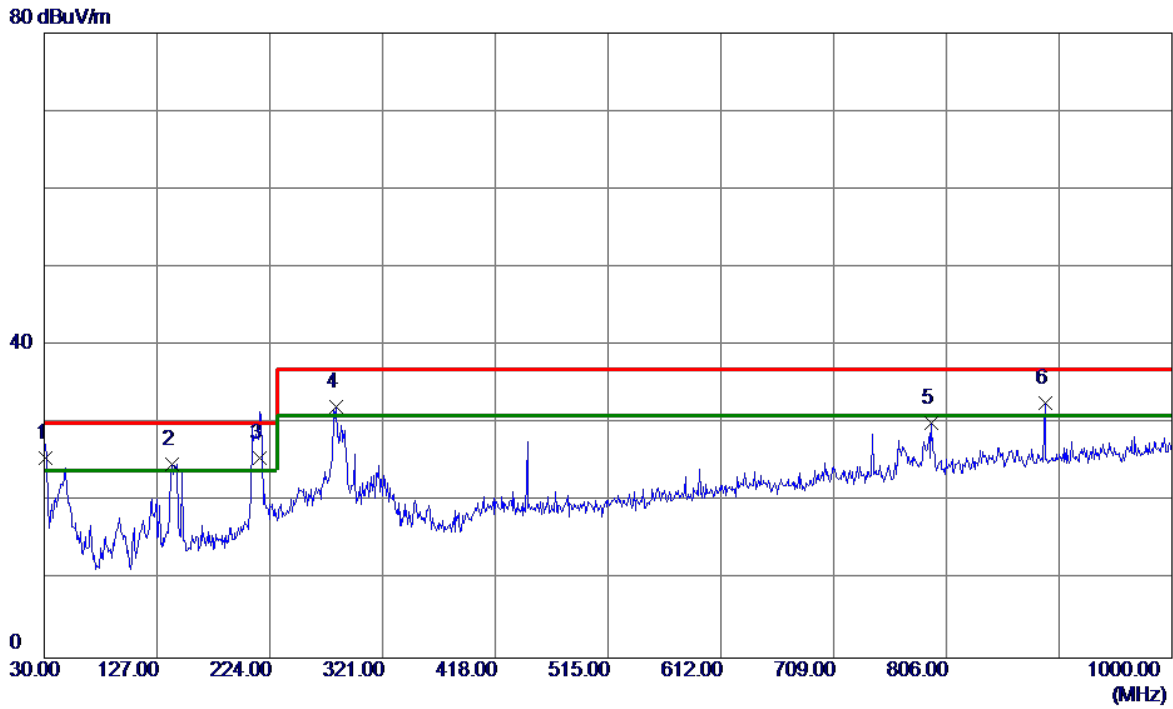

No.	Freq. MHz	Reading Level dBuV/m	Correct Factor dB	Measure ment dBuV/m	Limit dBuV/m	Margin dB	Detector
1	30.9700	44.09	-18.46	25.63	30.00	-4.37	QP
2	139.6100	41.38	-16.57	24.81	30.00	-5.19	QP
3	215.7550	44.62	-19.09	25.53	30.00	-4.47	QP
4	280.7450	47.80	-15.67	32.13	37.00	-4.87	QP
5	793.3900	35.80	-5.78	30.02	37.00	-6.98	QP
6 *	890.8750	37.27	-4.59	32.68	37.00	-4.32	QP

EUT	LCD Monitor	Test Model	22B2
Temperature	25°C	Relative Humidity	60%
Test Voltage	AC 230V/50Hz	Polarization	Horizontal
Test Mode	HDMI 1080P		
Test Engineer	Kang		

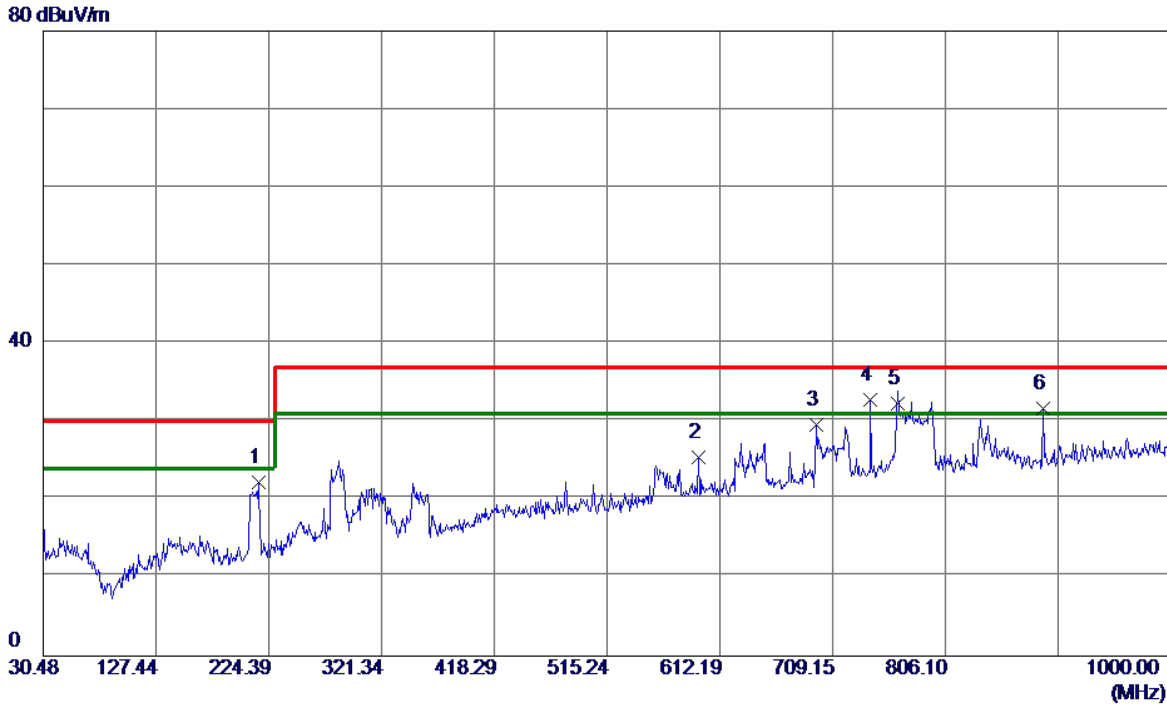

No.	Freq. MHz	Reading Level dBuV/m	Correct Factor dB	Measure ment dBuV/m	Limit dBuV/m	Margin dB	Detector
1	215.2700	41.62	-19.31	22.31	30.00	-7.69	QP
2	593.5700	34.19	-8.73	25.46	37.00	-11.54	QP
3	695.4200	36.77	-7.24	29.53	37.00	-7.47	QP
4 *	741.9800	39.24	-6.46	32.78	37.00	-4.22	QP
5	765.2600	38.60	-6.21	32.39	37.00	-4.61	QP
6	890.3900	36.69	-5.00	31.69	37.00	-5.31	QP

EUT	LCD Monitor	Test Model	22B2
Temperature	25°C	Relative Humidity	60%
Test Voltage	AC 110V/60Hz	Polarization	Vertical
Test Mode	HDMI 1920*1080/60Hz		
Test Engineer	Kang		

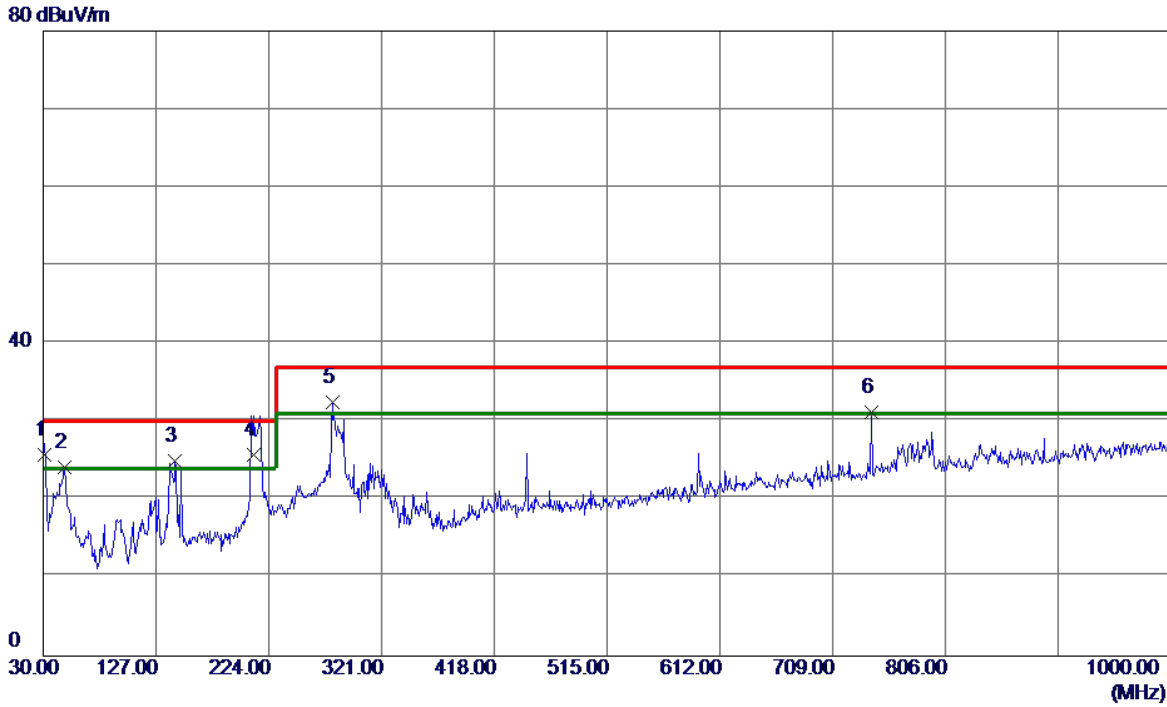

No.	Freq. MHz	Reading Level dBuV/m	Correct Factor dB	Measure ment dBuV/m	Limit dBuV/m	Margin dB	Detector
1 *	30.9700	44.29	-18.46	25.83	30.00	-4.17	QP
2	48.4300	40.72	-16.62	24.10	30.00	-5.90	QP
3	143.4900	41.22	-16.33	24.89	30.00	-5.11	QP
4	211.3900	44.90	-19.10	25.80	30.00	-4.20	QP
5	278.8050	48.21	-15.75	32.46	37.00	-4.54	QP
6	742.4650	37.59	-6.35	31.24	37.00	-5.76	QP

EUT	LCD Monitor	Test Model	22B2
Temperature	25°C	Relative Humidity	60%
Test Voltage	AC 110V/60Hz	Polarization	Horizontal
Test Mode	HDMI 1920*1080/60Hz		
Test Engineer	Kang		

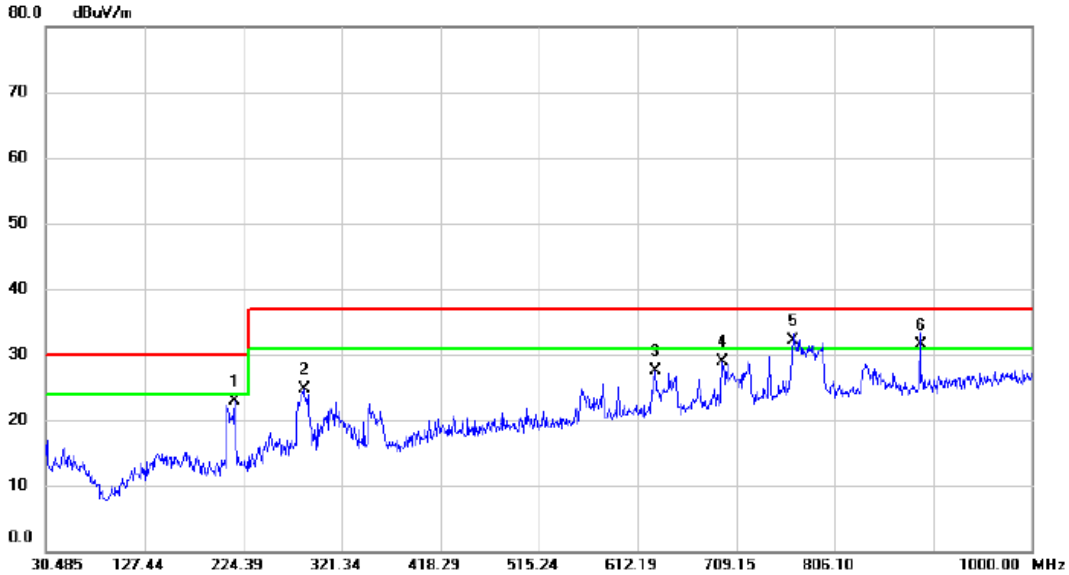

No.	Mk.	Freq. MHz	Reading Level dBuV	Correct Factor dB	Measure- ment dBuV/m	Limit dBuV/m	Margin dB	Detector	Comment
1		216.2400	42.26	-19.33	22.93	30.00	-7.07	QP	
2		284.1400	40.40	-15.66	24.74	37.00	-12.26	QP	
3		629.4600	35.70	-8.20	27.50	37.00	-9.50	QP	
4		695.4200	36.19	-7.24	28.95	37.00	-8.05	QP	
5	*	765.2600	38.32	-6.21	32.11	37.00	-4.89	QP	
6	!	890.3900	36.60	-5.00	31.60	37.00	-5.40	QP	

4.1.8 TEST RESULTS (ABOVE TO 1 GHZ)

EUT	LCD Monitor	Test Model	22B2
Temperature	25°C	Relative Humidity	60%
Test Voltage	AC 230V/50Hz	Polarization	Vertical
Test Mode	D-SUB 1920*1080/60Hz		
Test Engineer	Kang		

86.9 dBuV/m

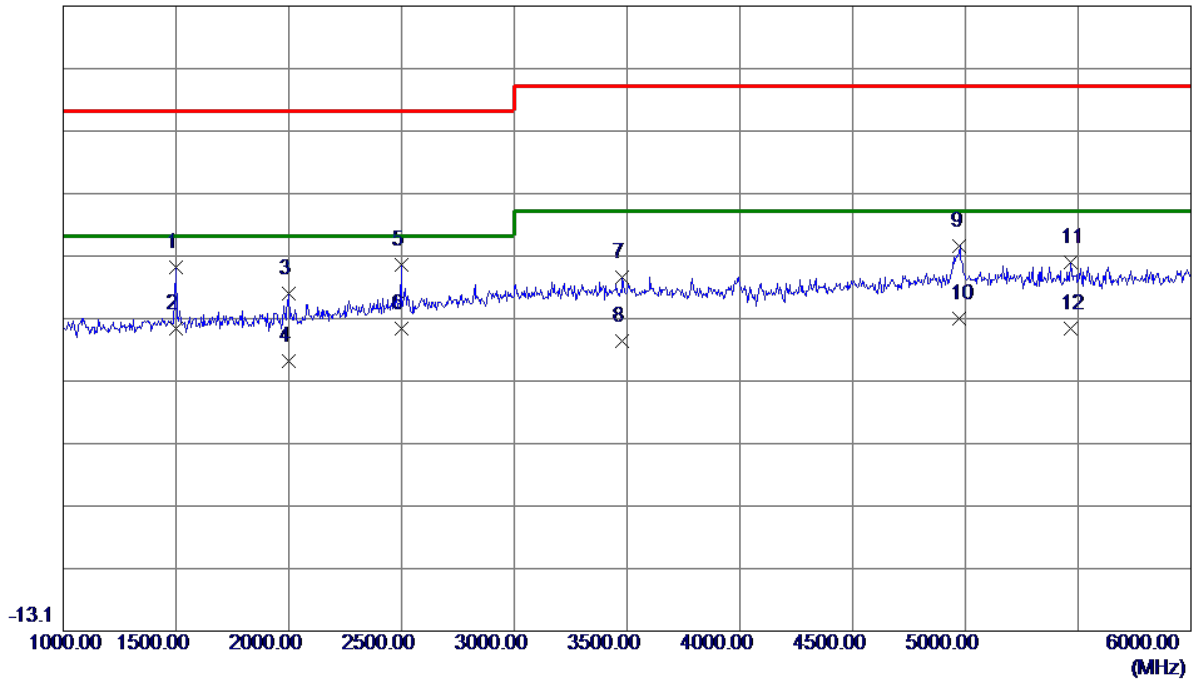

No.	Freq. MHz	Reading Level dBuV/m	Correct Factor dB	Measure ment dBuV/m	Limit dBuV/m	Margin dB	Detector
1	1500.0000	48.65	-3.48	45.17	70.00	-24.83	Peak
2	1500.0000	38.71	-3.48	35.23	50.00	-14.77	AVG
3	2000.0000	42.72	-1.75	40.97	70.00	-29.03	Peak
4	2000.0000	31.89	-1.75	30.14	50.00	-19.86	AVG
5	2497.5000	44.97	0.51	45.48	70.00	-24.52	Peak
6 *	2497.5000	34.75	0.51	35.26	50.00	-14.74	AVG
7	3480.0000	39.46	4.07	43.53	74.00	-30.47	Peak
8	3480.0000	29.19	4.07	33.26	54.00	-20.74	AVG
9	4975.0000	40.56	7.88	48.44	74.00	-25.56	Peak
10	4975.0000	29.07	7.88	36.95	54.00	-17.05	AVG
11	5465.0000	37.53	8.42	45.95	74.00	-28.05	Peak
12	5465.0000	26.86	8.42	35.28	54.00	-18.72	AVG

EUT	LCD Monitor	Test Model	22B2
Temperature	25°C	Relative Humidity	60%
Test Voltage	AC 230V/50Hz	Polarization	Horizontal
Test Mode	D-SUB 1920*1080/60Hz		
Test Engineer	Kang		

86.9 dBuV/m

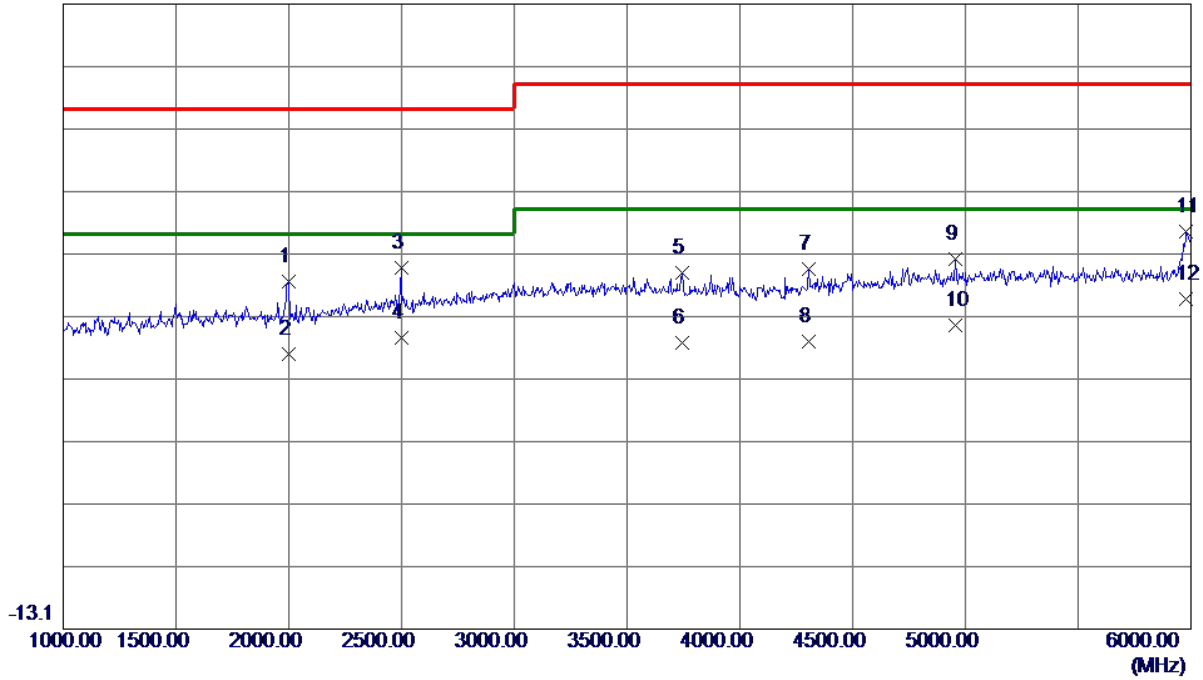

No.	Freq. MHz	Reading Level dBuV/m	Correct Factor dB	Measure ment dBuV/m	Limit dBuV/m	Margin dB	Detector
1	2000.0000	44.34	-1.75	42.59	70.00	-27.41	Peak
2	2000.0000	32.61	-1.75	30.86	50.00	-19.14	AVG
3	2497.5000	44.21	0.51	44.72	70.00	-25.28	Peak
4	2497.5000	33.02	0.51	33.53	50.00	-16.47	AVG
5	3742.5000	39.44	4.52	43.96	74.00	-30.04	Peak
6	3742.5000	28.18	4.52	32.70	54.00	-21.30	AVG
7	4305.0000	38.68	5.74	44.42	74.00	-29.58	Peak
8	4305.0000	27.17	5.74	32.91	54.00	-21.09	AVG
9	4955.0000	38.32	7.81	46.13	74.00	-27.87	Peak
10	4955.0000	27.62	7.81	35.43	54.00	-18.57	AVG
11	5980.0000	41.68	8.86	50.54	74.00	-23.46	Peak
12 *	5980.0000	30.79	8.86	39.65	54.00	-14.35	AVG

EUT	LCD Monitor	Test Model	22B2
Temperature	25°C	Relative Humidity	60%
Test Voltage	AC 230V/50Hz	Polarization	Vertical
Test Mode	HDMI 1920*1080/60Hz		
Test Engineer	Kang		

86.9 dBuV/m

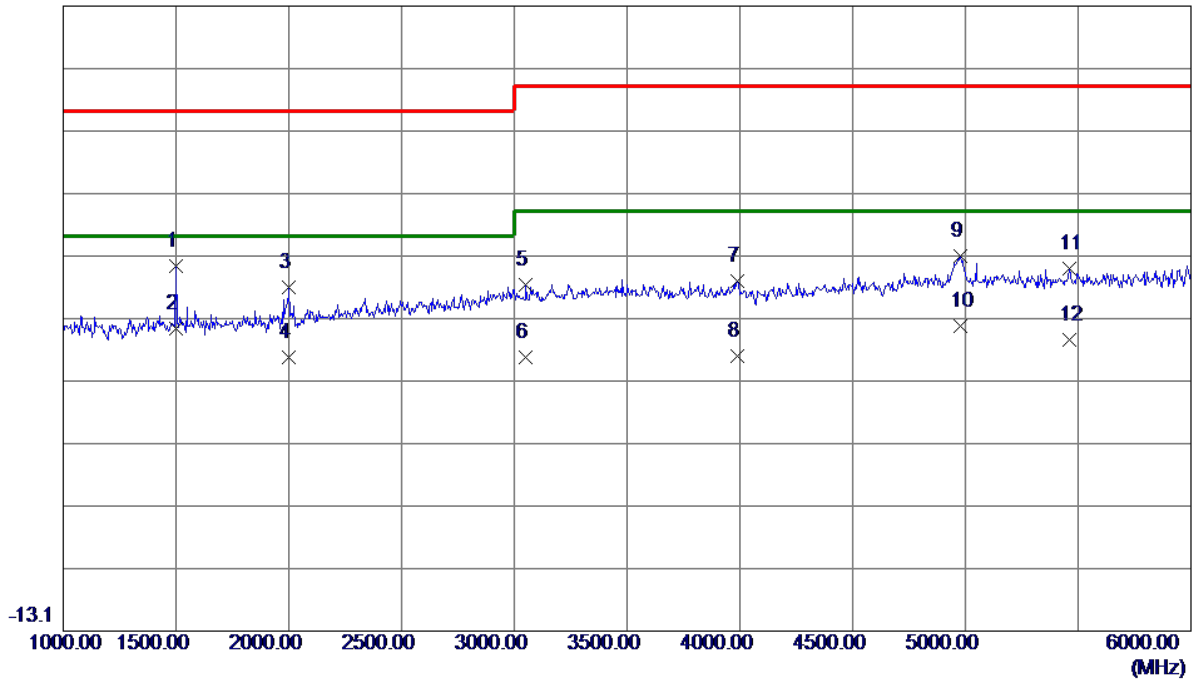

No.	Freq. MHz	Reading Level dBuV/m	Correct Factor dB	Measure ment dBuV/m	Limit dBuV/m	Margin dB	Detector
1	1500.0000	48.74	-3.48	45.26	70.00	-24.74	Peak
2 *	1500.0000	38.81	-3.48	35.33	50.00	-14.67	AVG
3	2000.0000	43.69	-1.75	41.94	70.00	-28.06	Peak
4	2000.0000	32.37	-1.75	30.62	50.00	-19.38	AVG
5	3050.0000	39.06	3.16	42.22	74.00	-31.78	Peak
6	3050.0000	27.63	3.16	30.79	54.00	-23.21	AVG
7	3987.5000	37.93	4.94	42.87	74.00	-31.13	Peak
8	3987.5000	25.90	4.94	30.84	54.00	-23.16	AVG
9	4977.5000	38.92	7.89	46.81	74.00	-27.19	Peak
10	4977.5000	27.76	7.89	35.65	54.00	-18.35	AVG
11	5462.5000	36.41	8.41	44.82	74.00	-29.18	Peak
12	5462.5000	25.10	8.41	33.51	54.00	-20.49	AVG

EUT	LCD Monitor	Test Model	22B2
Temperature	25°C	Relative Humidity	60%
Test Voltage	AC 230V/50Hz	Polarization	Horizontal
Test Mode	HDMI 1920*1080/60Hz		
Test Engineer	Kang		

86.9 dBuV/m

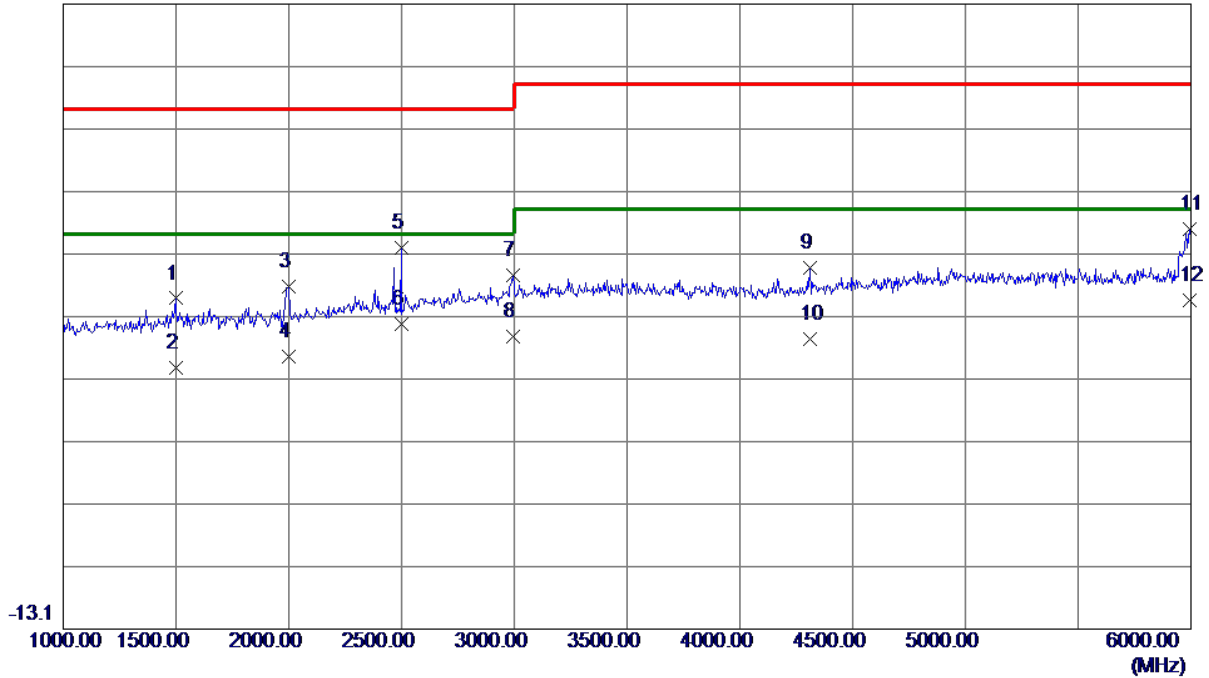

No.	Freq. MHz	Reading Level dBuV/m	Correct Factor dB	Measure ment dBuV/m	Limit dBuV/m	Margin dB	Detector
1	1497.5000	43.29	-3.49	39.80	70.00	-30.20	Peak
2	1497.5000	32.18	-3.49	28.69	50.00	-21.31	AVG
3	1997.5000	43.51	-1.76	41.75	70.00	-28.25	Peak
4	1997.5000	32.30	-1.76	30.54	50.00	-19.46	AVG
5	2497.5000	47.47	0.51	47.98	70.00	-22.02	Peak
6 *	2497.5000	35.22	0.51	35.73	50.00	-14.27	AVG
7	2992.5000	40.44	3.02	43.46	70.00	-26.54	Peak
8	2992.5000	30.59	3.02	33.61	50.00	-16.39	AVG
9	4310.0000	38.99	5.75	44.74	74.00	-29.26	Peak
10	4310.0000	27.53	5.75	33.28	54.00	-20.72	AVG
11	5992.5000	42.00	8.87	50.87	74.00	-23.13	Peak
12	5992.5000	30.63	8.87	39.50	54.00	-14.50	AVG

EUT	LCD Monitor	Test Model	22B2
Temperature	25°C	Relative Humidity	60%
Test Voltage	AC 230V/50Hz	Polarization	Vertical
Test Mode	HDMI1 1080P		
Test Engineer	Kang		

86.9 dBuV/m

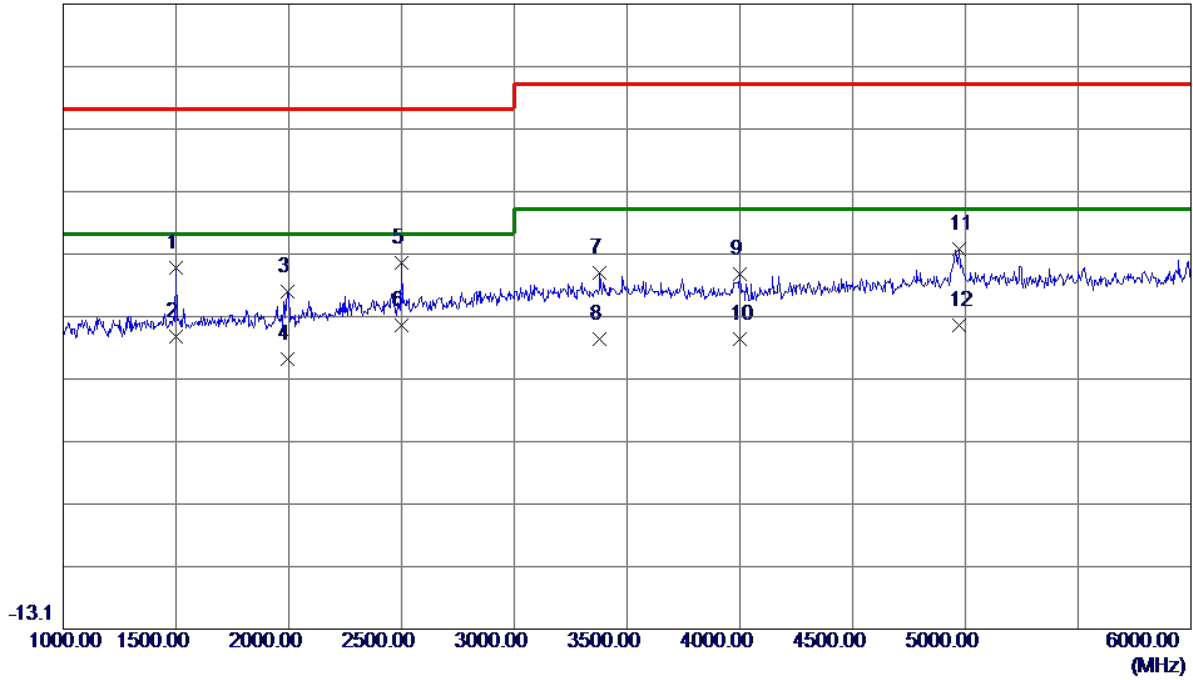

No.	Freq. MHz	Reading Level dBuV/m	Correct Factor dB	Measure ment dBuV/m	Limit dBuV/m	Margin dB	Detector
1	1500.0000	48.11	-3.48	44.63	70.00	-25.37	Peak
2	1500.0000	37.17	-3.48	33.69	50.00	-16.31	AVG
3	1992.5000	42.69	-1.78	40.91	70.00	-29.09	Peak
4	1992.5000	31.90	-1.78	30.12	50.00	-19.88	AVG
5	2500.0000	45.01	0.52	45.53	70.00	-24.47	Peak
6 *	2500.0000	34.90	0.52	35.42	50.00	-14.58	AVG
7	3380.0000	40.08	3.86	43.94	74.00	-30.06	Peak
8	3380.0000	29.41	3.86	33.27	54.00	-20.73	AVG
9	4000.0000	38.79	4.96	43.75	74.00	-30.25	Peak
10	4000.0000	28.43	4.96	33.39	54.00	-20.61	AVG
11	4970.0000	39.84	7.87	47.71	74.00	-26.29	Peak
12	4970.0000	27.69	7.87	35.56	54.00	-18.44	AVG

EUT	LCD Monitor	Test Model	22B2
Temperature	25°C	Relative Humidity	60%
Test Voltage	AC 230V/50Hz	Polarization	Horizontal
Test Mode	HDMI1 1080P		
Test Engineer	Kang		

86.9 dBuV/m

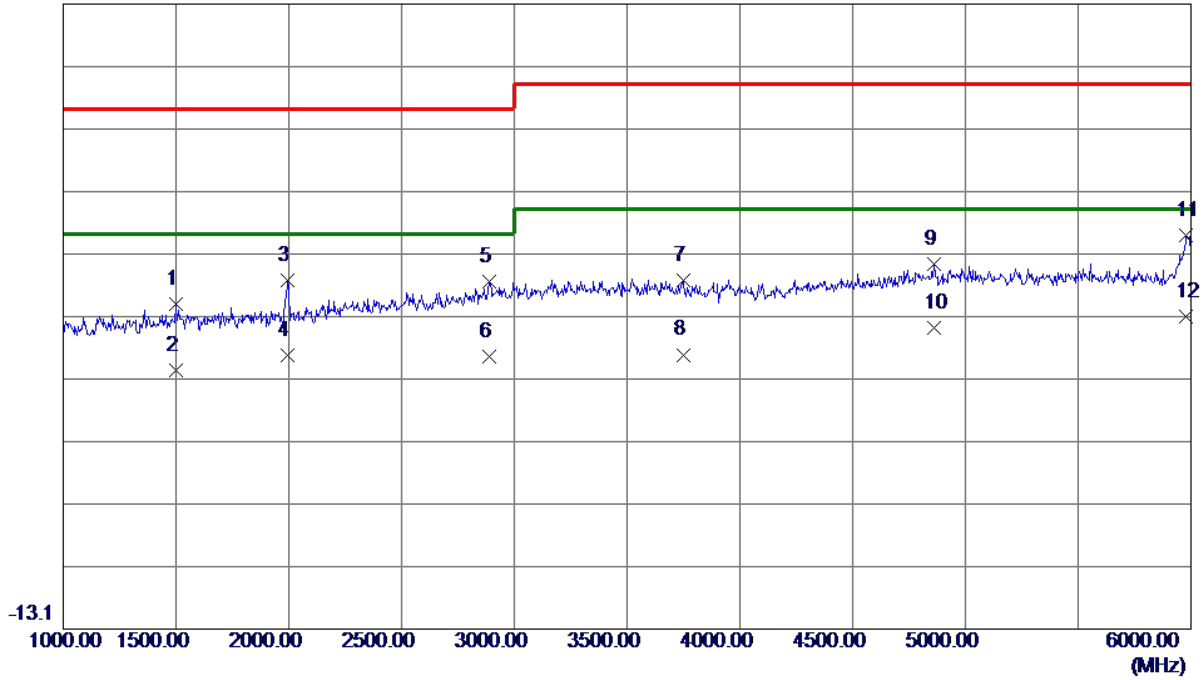

No.	Freq. MHz	Reading Level dBuV/m	Correct Factor dB	Measure ment dBuV/m	Limit dBuV/m	Margin dB	Detector
1	1497.5000	42.43	-3.49	38.94	70.00	-31.06	Peak
2	1497.5000	31.74	-3.49	28.25	50.00	-21.75	AVG
3	1992.5000	44.43	-1.78	42.65	70.00	-27.35	Peak
4	1992.5000	32.45	-1.78	30.67	50.00	-19.33	AVG
5	2890.0000	39.99	2.50	42.49	70.00	-27.51	Peak
6	2890.0000	27.99	2.50	30.49	50.00	-19.51	AVG
7	3747.5000	38.23	4.53	42.76	74.00	-31.24	Peak
8	3747.5000	26.27	4.53	30.80	54.00	-23.20	AVG
9	4860.0000	37.74	7.49	45.23	74.00	-28.77	Peak
10	4860.0000	27.63	7.49	35.12	54.00	-18.88	AVG
11	5980.0000	41.06	8.86	49.92	74.00	-24.08	Peak
12 *	5980.0000	28.06	8.86	36.92	54.00	-17.08	AVG

EUT	LCD Monitor	Test Model	22B2
Temperature	25°C	Relative Humidity	60%
Test Voltage	AC 110V/60Hz	Polarization	Vertical
Test Mode	HDMI 1920*1080/60Hz		
Test Engineer	Kang		

86.9 dBuV/m

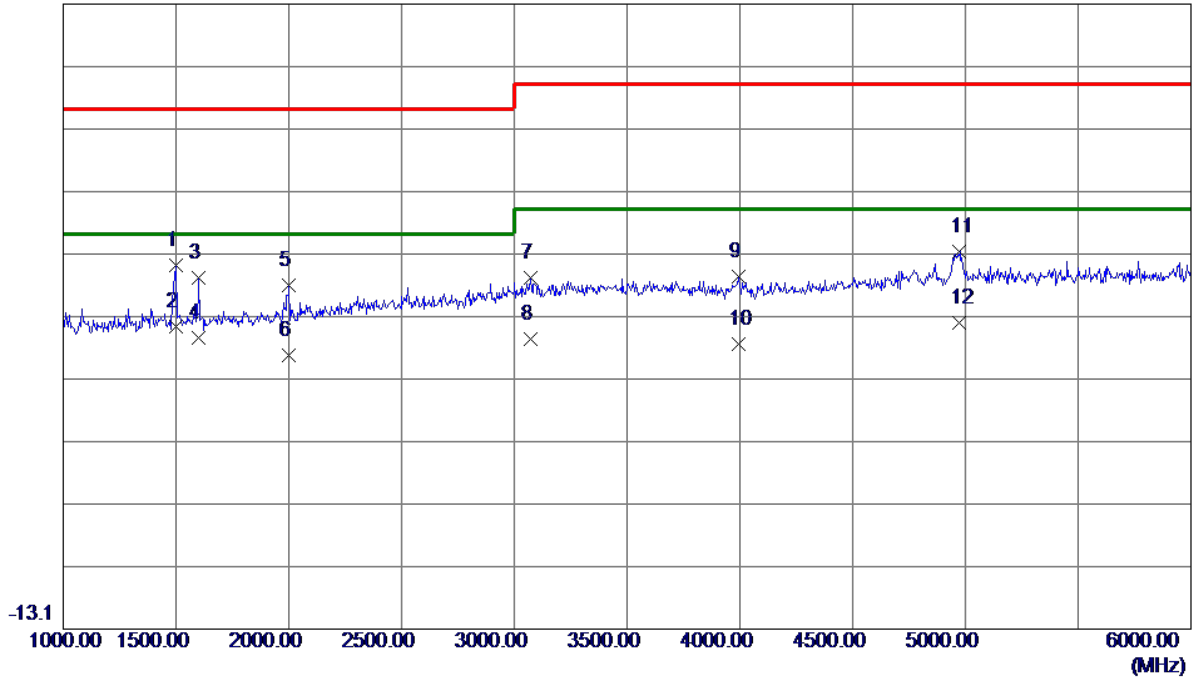

No.	Freq. MHz	Reading Level dBuV/m	Correct Factor dB	Measure ment dBuV/m	Limit dBuV/m	Margin dB	Detector
1	1500.0000	48.52	-3.48	45.04	70.00	-24.96	Peak
2 *	1500.0000	38.76	-3.48	35.28	50.00	-14.72	AVG
3	1600.0000	46.32	-3.13	43.19	70.00	-26.81	Peak
4	1600.0000	36.54	-3.13	33.41	50.00	-16.59	AVG
5	2000.0000	43.60	-1.75	41.85	70.00	-28.15	Peak
6	2000.0000	32.42	-1.75	30.67	50.00	-19.33	AVG
7	3072.5000	39.89	3.21	43.10	74.00	-30.90	Peak
8	3072.5000	30.08	3.21	33.29	54.00	-20.71	AVG
9	3992.5000	38.37	4.95	43.32	74.00	-30.68	Peak
10	3992.5000	27.61	4.95	32.56	54.00	-21.44	AVG
11	4975.0000	39.50	7.88	47.38	74.00	-26.62	Peak
12	4975.0000	28.02	7.88	35.90	54.00	-18.10	AVG

EUT	LCD Monitor	Test Model	22B2
Temperature	25°C	Relative Humidity	60%
Test Voltage	AC 110V/60Hz	Polarization	Horizontal
Test Mode	HDMI 1920*1080/60Hz		
Test Engineer	Kang		

86.9 dBuV/m

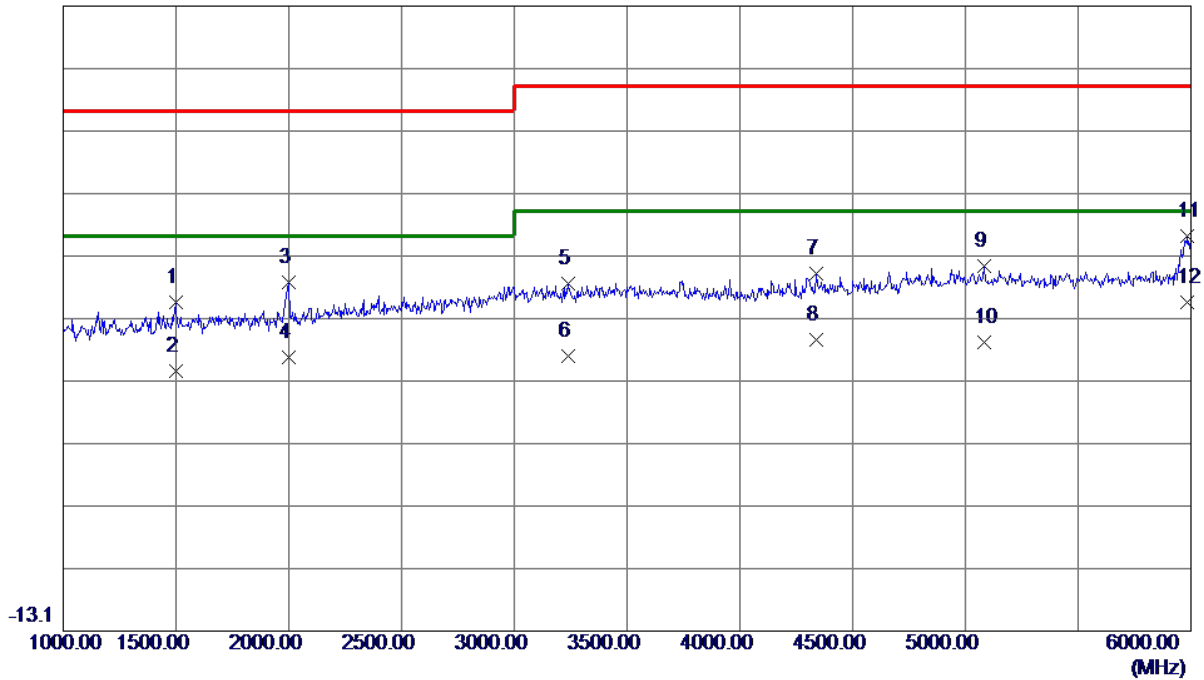

No.	Freq. MHz	Reading Level dBuV/m	Correct Factor dB	Measure ment dBuV/m	Limit dBuV/m	Margin dB	Detector
1	1497.5000	43.05	-3.49	39.56	70.00	-30.44	Peak
2	1497.5000	32.00	-3.49	28.51	50.00	-21.49	AVG
3	2000.0000	44.52	-1.75	42.77	70.00	-27.23	Peak
4	2000.0000	32.42	-1.75	30.67	50.00	-19.33	AVG
5	3240.0000	39.02	3.56	42.58	74.00	-31.42	Peak
6	3240.0000	27.34	3.56	30.90	54.00	-23.10	AVG
7	4340.0000	38.28	5.83	44.11	74.00	-29.89	Peak
8	4340.0000	27.63	5.83	33.46	54.00	-20.54	AVG
9	5082.5000	37.18	8.05	45.23	74.00	-28.77	Peak
10	5082.5000	25.07	8.05	33.12	54.00	-20.88	AVG
11	5985.0000	41.30	8.87	50.17	74.00	-23.83	Peak
12 *	5985.0000	30.67	8.87	39.54	54.00	-14.46	AVG

4.2 CONDUCTED EMISSION MEASUREMENT AT AC MAINS POWER PORTS

4.2.1 LIMITS

Requirements for conducted emissions from AC mains power ports of Class A equipment

Table clause	Frequency Range MHz	Coupling Device	Detector Type / bandwidth	Class A Limits (dB(μV))
A8.1	0.15 - 0.5	AMN	Quasi Peak / 9 kHz	79
	0.5 - 30			73
A8.2	0.15 - 0.5	AMN	Average / 9 kHz	66
	0.5 - 30			60

Requirements for conducted emissions from AC mains power ports of Class B equipment

Table clause	Frequency Range MHz	Coupling Device	Detector Type / bandwidth	Class B Limits (dB(μV))
A9.1	0.15 - 0.5	AMN	Quasi Peak / 9 kHz	66-56
	0.5 - 5			56
	5 - 30			60
A9.2	0.15 - 0.5	AMN	Average / 9 kHz	56-46
	0.5 - 5			46
	5 - 30			50

NOTE:

- (1) The test result calculated as following:
 Measurement Value = Reading Level + Correct Factor
 Correct Factor = Insertion Loss + Cable Loss + Attenuator Factor(if use)
 Margin Level = Measurement Value – Limit Value

4.2.2 MEASUREMENT INSTRUMENTS LIST

Item	Kind of Equipment	Manufacturer	Type No.	Serial No.	Calibrated until
1*	LISN	EMCO	3816/2SH	52766	Mar. 10, 2022
2	50Ω Terminator	SHX	TF2-3G-A	8122901	Mar. 10, 2020
3	TWO-LINE V-NETWORK	R&S	ENV216	100526	Mar. 10, 2020
4	EMI Test Receiver	R&S	ESR3	101862	Aug. 11, 2019
5	Cable	N/A	N/A(6m)	N/A	Mar. 12, 2020
6	Measurement Software	Farad	EZ-EMC Ver.NB-03A 1-01	N/A	N/A

Remark: "N/A" denotes no model no., no serial no. or no calibration specified.

"**" calibration period of equipment list is three year.

Except * item, all calibration period of equipment list is one year.

4.2.3 TEST PROCEDURE

- a. The EUT was placed 0.8 meters from the horizontal ground plane with EUT being connected to the power mains through a line impedance stabilization network (LISN). All other support equipments powered from additional LISN(s). The LISN provide 50 Ohm/ 50uH of coupling impedance for the measuring instrument.
- b. Interconnecting cables that hang closer than 40 cm to the ground plane shall be folded back and forth in the center forming a bundle 30 to 40 cm long.
- c. I/O cables that are not connected to a peripheral shall be bundled in the center. The end of the cable may be terminated, if required, using the correct terminating impedance. The overall length shall not exceed 1 m.
- d. LISN at least 80 cm from nearest part of EUT chassis.
- e. For the actual test configuration, please refer to the related Item –EUT Test Photos.

4.2.4 DEVIATION FROM TEST STANDARD

No deviation

4.2.5 TEST SETUP

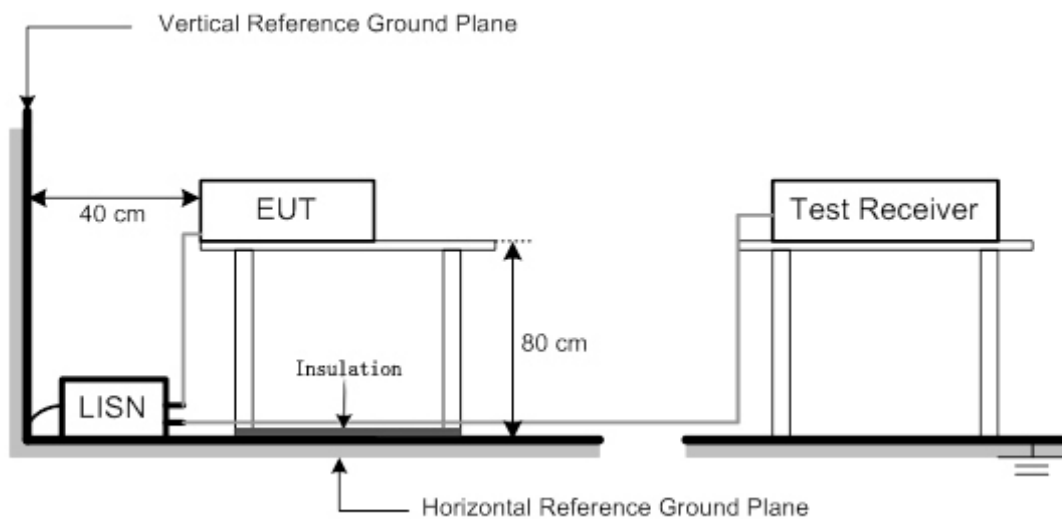

4.2.6 TEST RESULTS

EUT	LCD Monitor	Test Model	22B2
Temperature	25°C	Relative Humidity	53%
Test Voltage	AC 230V/50Hz	Phase	Line
Test Mode	D-SUB 1920*1080/60Hz		
Test Engineer	Kang		

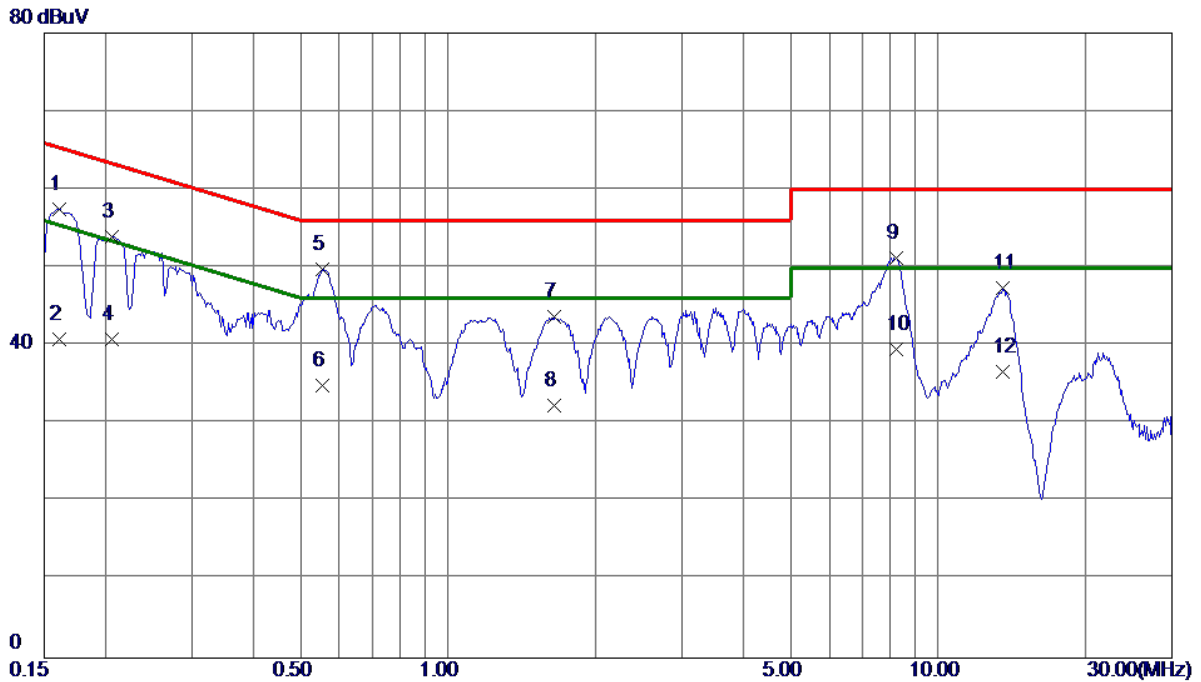

No.	Freq. MHz	Reading Level dBuV	Correct Factor dB	Measure ment dBuV	Limit dBuV	Margin dB	Detector
1	0.1613	47.88	9.57	57.45	65.40	-7.95	QP
2	0.1613	31.20	9.57	40.77	55.40	-14.63	AVG
3	0.2063	44.33	9.56	53.89	63.35	-9.46	QP
4	0.2063	31.20	9.56	40.76	53.35	-12.59	AVG
5 *	0.5550	40.16	9.58	49.74	56.00	-6.26	QP
6	0.5550	25.30	9.58	34.88	46.00	-11.12	AVG
7	1.6508	34.07	9.68	43.75	56.00	-12.25	QP
8	1.6508	22.70	9.68	32.38	46.00	-13.62	AVG
9	8.2319	41.21	10.06	51.27	60.00	-8.73	QP
10	8.2319	29.48	10.06	39.54	50.00	-10.46	AVG
11	13.5420	37.10	10.32	47.42	60.00	-12.58	QP
12	13.5420	26.34	10.32	36.66	50.00	-13.34	AVG

EUT	LCD Monitor	Test Model	22B2
Temperature	25°C	Relative Humidity	53%
Test Voltage	AC 230V/50Hz	Phase	Neutral
Test Mode	D-SUB 1920*1080/60Hz		
Test Engineer	Kang		

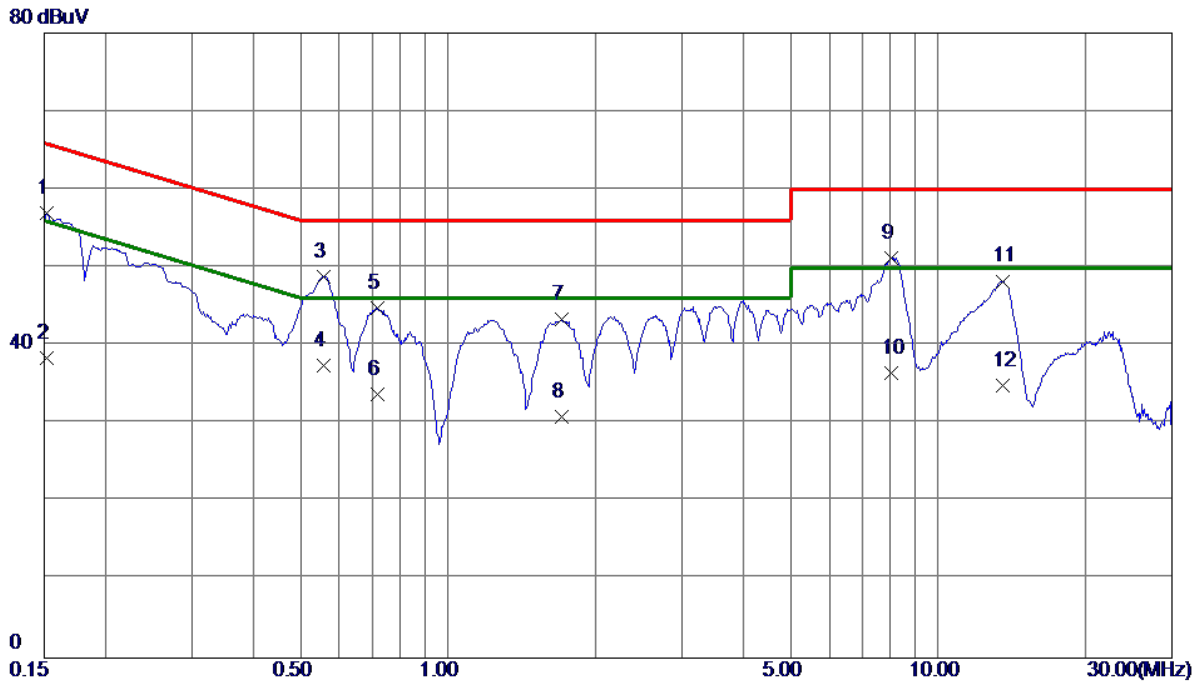

No.	Freq. MHz	Reading Level dBuV	Correct Factor dB	Measure ment dBuV	Limit dBuV	Margin dB	Detector
1	0.1522	47.35	9.55	56.90	65.88	-8.98	QP
2	0.1522	28.78	9.55	38.33	55.88	-17.55	AVG
3 *	0.5571	39.21	9.57	48.78	56.00	-7.22	QP
4	0.5571	27.89	9.57	37.46	46.00	-8.54	AVG
5	0.7170	35.24	9.58	44.82	56.00	-11.18	QP
6	0.7170	24.15	9.58	33.73	46.00	-12.27	AVG
7	1.7048	33.63	9.66	43.29	56.00	-12.71	QP
8	1.7048	21.16	9.66	30.82	46.00	-15.18	AVG
9	8.0115	41.19	10.05	51.24	60.00	-8.76	QP
10	8.0115	26.39	10.05	36.44	50.00	-13.56	AVG
11	13.5443	37.89	10.35	48.24	60.00	-11.76	QP
12	13.5443	24.56	10.35	34.91	50.00	-15.09	AVG

EUT	LCD Monitor	Test Model	22B2
Temperature	25°C	Relative Humidity	53%
Test Voltage	AC 230V/50Hz	Phase	Line
Test Mode	HDMI 1920*1080/60Hz		
Test Engineer	Kang		

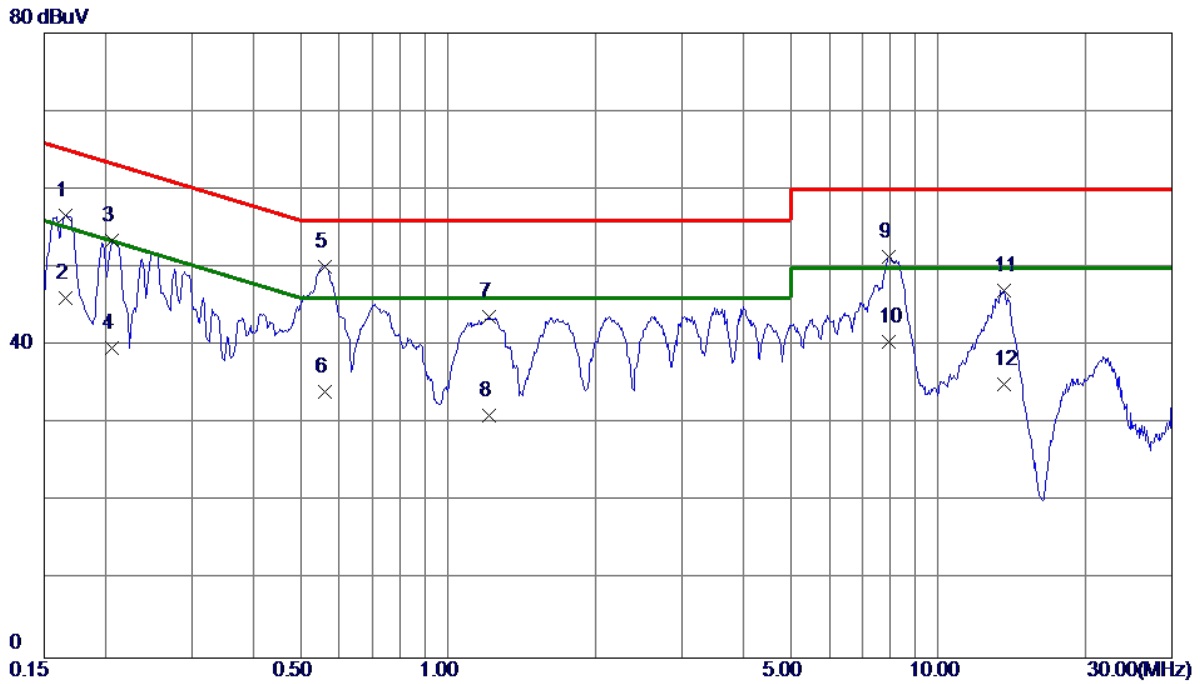

No.	Freq. MHz	Reading Level dBuV	Correct Factor dB	Measure ment dBuV	Limit dBuV	Margin dB	Detector
1	0.1658	47.07	9.56	56.63	65.17	-8.54	QP
2	0.1658	36.45	9.56	46.01	55.17	-9.16	AVG
3	0.2063	43.85	9.56	53.41	63.35	-9.94	QP
4	0.2063	30.18	9.56	39.74	53.35	-13.61	AVG
5 *	0.5595	40.50	9.58	50.08	56.00	-5.92	QP
6	0.5595	24.50	9.58	34.08	46.00	-11.92	AVG
7	1.2142	33.98	9.64	43.62	56.00	-12.38	QP
8	1.2142	21.44	9.64	31.08	46.00	-14.92	AVG
9	7.9305	41.28	10.04	51.32	60.00	-8.68	QP
10	7.9305	30.46	10.04	40.50	50.00	-9.50	AVG
11	13.6095	36.78	10.32	47.10	60.00	-12.90	QP
12	13.6095	24.79	10.32	35.11	50.00	-14.89	AVG

EUT	LCD Monitor	Test Model	22B2
Temperature	25°C	Relative Humidity	53%
Test Voltage	AC 230V/50Hz	Phase	Neutral
Test Mode	HDMI 1920*1080/60Hz		
Test Engineer	Kang		

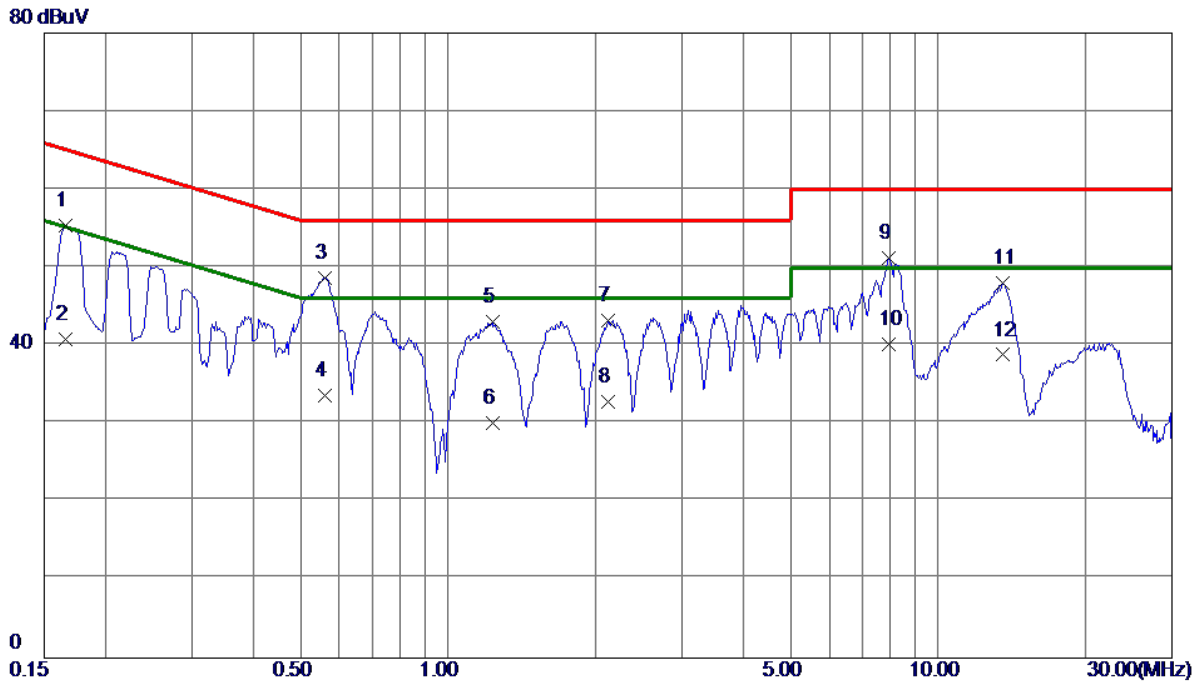

No.	Freq. MHz	Reading Level dBuV	Correct Factor dB	Measure ment dBuV	Limit dBuV	Margin dB	Detector
1	0.1658	45.76	9.54	55.30	65.17	-9.87	QP
2	0.1658	31.20	9.54	40.74	55.17	-14.43	AVG
3 *	0.5595	39.06	9.57	48.63	56.00	-7.37	QP
4	0.5595	24.10	9.57	33.67	46.00	-12.33	AVG
5	1.2323	33.37	9.63	43.00	56.00	-13.00	QP
6	1.2323	20.50	9.63	30.13	46.00	-15.87	AVG
7	2.1255	33.53	9.70	43.23	56.00	-12.77	QP
8	2.1255	23.10	9.70	32.80	46.00	-13.20	AVG
9	7.9260	41.16	10.05	51.21	60.00	-8.79	QP
10	7.9260	30.15	10.05	40.20	50.00	-9.80	AVG
11	13.5285	37.69	10.35	48.04	60.00	-11.96	QP
12	13.5285	28.45	10.35	38.80	50.00	-11.20	AVG

EUT	LCD Monitor	Test Model	22B2
Temperature	25°C	Relative Humidity	53%
Test Voltage	AC 230V/50Hz	Phase	Line
Test Mode	HDMI1 1080P		
Test Engineer	Kang		

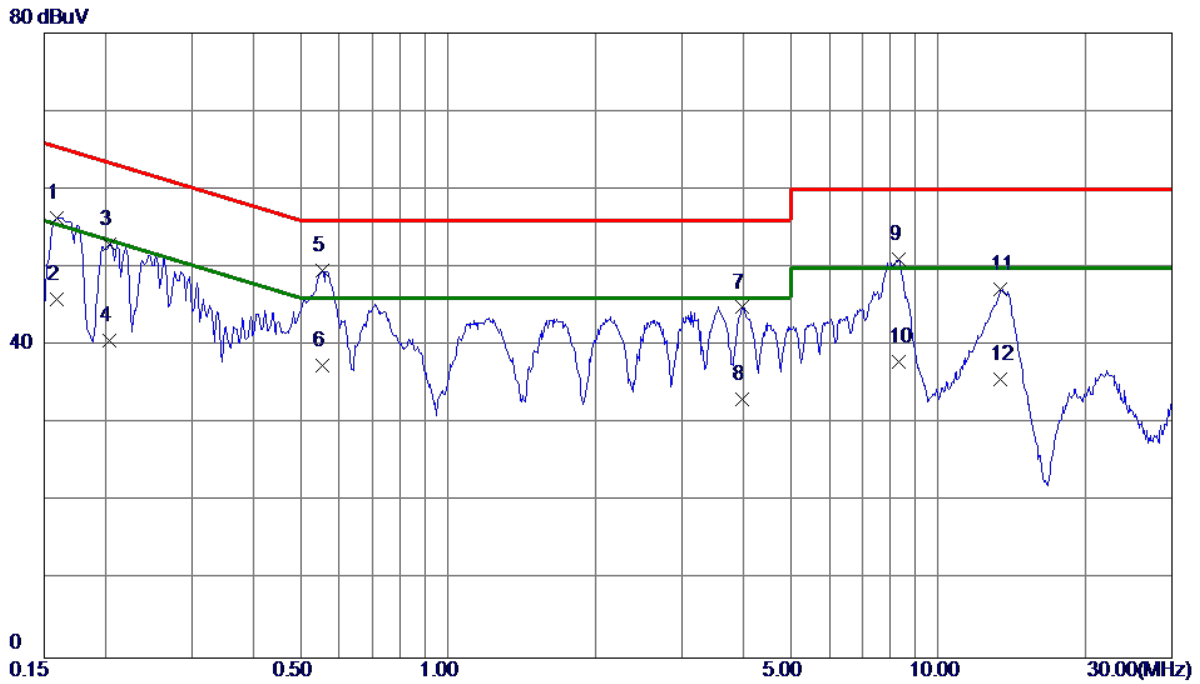

No.	Freq. MHz	Reading Level dBuV	Correct Factor dB	Measure ment dBuV	Limit dBuV	Margin dB	Detector
1	0.1590	46.79	9.57	56.36	65.52	-9.16	QP
2	0.1590	36.40	9.57	45.97	55.52	-9.55	AVG
3	0.2040	43.47	9.56	53.03	63.45	-10.42	QP
4	0.2040	31.15	9.56	40.71	53.45	-12.74	AVG
5 *	0.5550	39.94	9.58	49.52	56.00	-6.48	QP
6	0.5550	27.90	9.58	37.48	46.00	-8.52	AVG
7	3.9840	35.06	9.82	44.88	56.00	-11.12	QP
8	3.9840	23.30	9.82	33.12	46.00	-12.88	AVG
9	8.3265	41.04	10.06	51.10	60.00	-8.90	QP
10	8.3265	27.89	10.06	37.95	50.00	-12.05	AVG
11	13.4160	36.89	10.31	47.20	60.00	-12.80	QP
12	13.4160	25.40	10.31	35.71	50.00	-14.29	AVG

EUT	LCD Monitor	Test Model	22B2
Temperature	25°C	Relative Humidity	53%
Test Voltage	AC 230V/50Hz	Phase	Neutral
Test Mode	HDMI1 1080P		
Test Engineer	Kang		

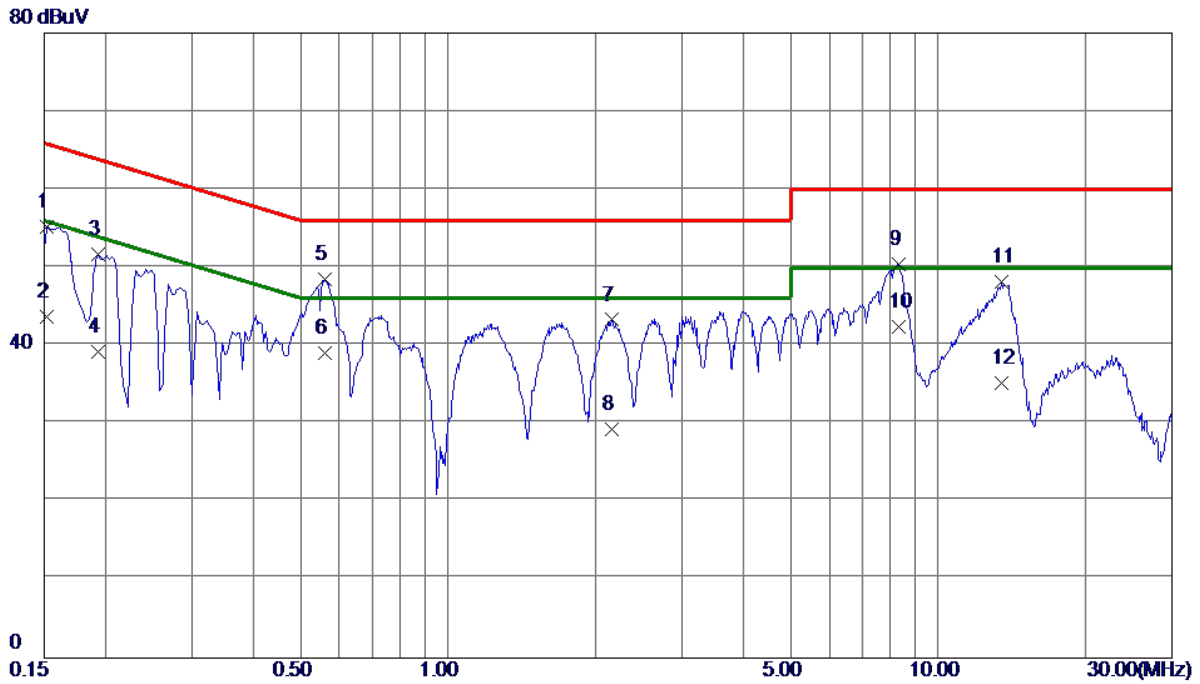

No.	Freq. MHz	Reading Level dBuV	Correct Factor dB	Measurement dBuV	Limit dBuV	Margin dB	Detector
1	0.1522	45.67	9.55	55.22	65.88	-10.66	QP
2	0.1522	34.12	9.55	43.67	55.88	-12.21	AVG
3	0.1928	42.09	9.54	51.63	63.92	-12.29	QP
4	0.1928	29.60	9.54	39.14	53.92	-14.78	AVG
5	0.5595	38.86	9.57	48.43	56.00	-7.57	QP
6 *	0.5595	29.40	9.57	38.97	46.00	-7.03	AVG
7	2.1570	33.58	9.70	43.28	56.00	-12.72	QP
8	2.1570	19.60	9.70	29.30	46.00	-16.70	AVG
9	8.3040	40.38	10.07	50.45	60.00	-9.55	QP
10	8.3040	32.30	10.07	42.37	50.00	-7.63	AVG
11	13.5105	37.81	10.35	48.16	60.00	-11.84	QP
12	13.5105	24.80	10.35	35.15	50.00	-14.85	AVG

EUT	LCD Monitor	Test Model	22B2
Temperature	25°C	Relative Humidity	53%
Test Voltage	AC 110V/60Hz	Phase	Line
Test Mode	HDMI 1920*1080/60Hz		
Test Engineer	Kang		

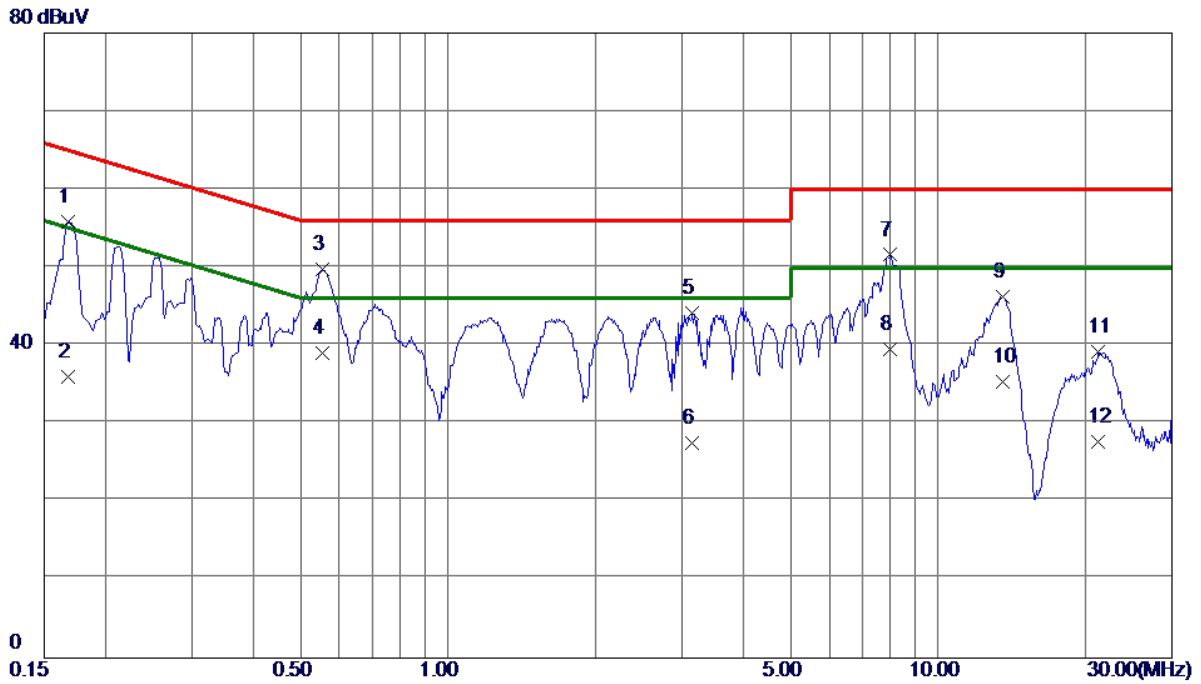

No.	Freq. MHz	Reading Level dBuV	Correct Factor dB	Measure ment dBuV	Limit dBuV	Margin dB	Detector
1	0.1680	46.25	9.56	55.81	65.06	-9.25	QP
2	0.1680	26.40	9.56	35.96	55.06	-19.10	AVG
3 *	0.5550	40.12	9.58	49.70	56.00	-6.30	QP
4	0.5550	29.40	9.58	38.98	46.00	-7.02	AVG
5	3.1403	34.43	9.77	44.20	56.00	-11.80	QP
6	3.1403	17.80	9.77	27.57	46.00	-18.43	AVG
7	7.9800	41.55	10.05	51.60	60.00	-8.40	QP
8	7.9800	29.48	10.05	39.53	50.00	-10.47	AVG
9	13.5488	35.99	10.32	46.31	60.00	-13.69	QP
10	13.5488	25.10	10.32	35.42	50.00	-14.58	AVG
11	21.1808	28.47	10.79	39.26	60.00	-20.74	QP
12	21.1808	16.90	10.79	27.69	50.00	-22.31	AVG

EUT	LCD Monitor	Test Model	22B2
Temperature	25°C	Relative Humidity	53%
Test Voltage	AC 110V/60Hz	Phase	Neutral
Test Mode	HDMI 1920*1080/60Hz		
Test Engineer	Kang		

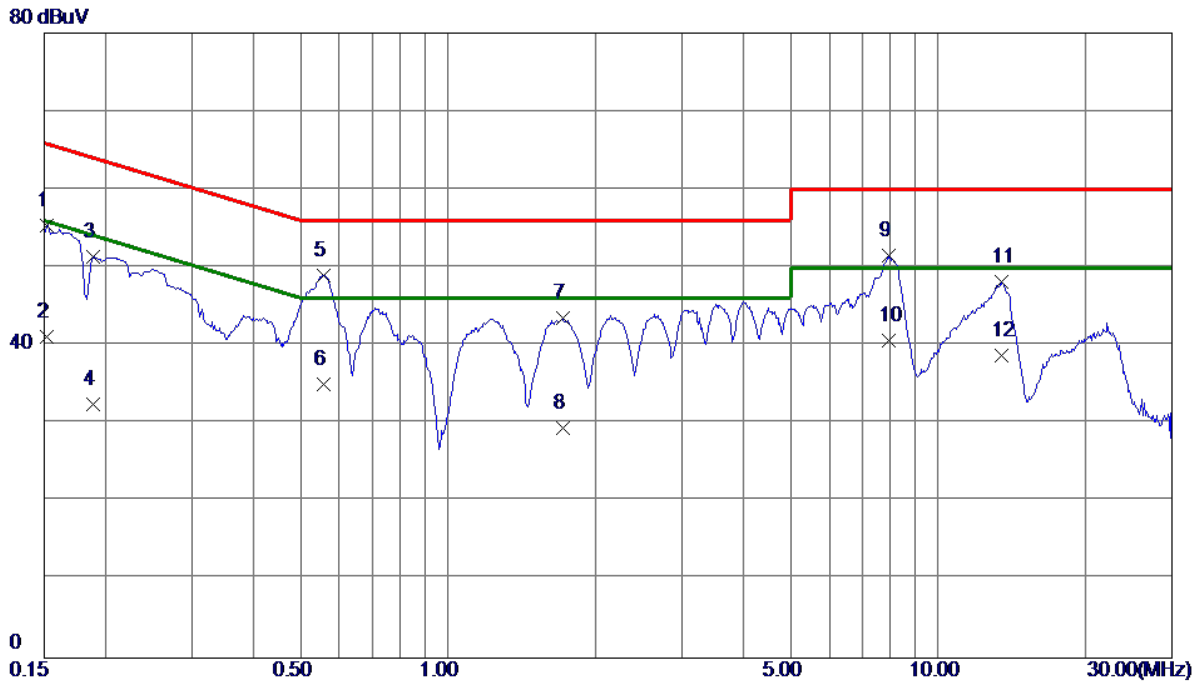

No.	Freq. MHz	Reading Level dBuV	Correct Factor dB	Measurement dBuV	Limit dBuV	Margin dB	Detector
1	0.1522	45.81	9.55	55.36	65.88	-10.52	QP
2	0.1522	31.60	9.55	41.15	55.88	-14.73	AVG
3	0.1883	41.89	9.54	51.43	64.11	-12.68	QP
4	0.1883	22.90	9.54	32.44	54.11	-21.67	AVG
5 *	0.5571	39.38	9.57	48.95	56.00	-7.05	QP
6	0.5571	25.45	9.57	35.02	46.00	-10.98	AVG
7	1.7138	33.86	9.66	43.52	56.00	-12.48	QP
8	1.7138	19.80	9.66	29.46	46.00	-16.54	AVG
9	7.9283	41.45	10.05	51.50	60.00	-8.50	QP
10	7.9283	30.60	10.05	40.65	50.00	-9.35	AVG
11	13.5038	37.87	10.35	48.22	60.00	-11.78	QP
12	13.5038	28.40	10.35	38.75	50.00	-11.25	AVG

5. EMC EMISSION TEST- EN 55032:2015+AC:2016

5.1 RADIATED EMISSION

5.1.1 LIMITS

Class A equipment up to 1000MHz

Table clause	Frequency range MHz	Measurement			Class A limits dB(μ V/m)
		Facility (see Table A.1)	Distance m	Detector type/ bandwidth	
A2.1	30-230	OATS/SAC	10	Quasi peak / 120 kHz	40
	230-1000				47
A2.2	30-230	OATS/SAC	3		50
	230-1000				57
A2.3	30-230	FAR	10	Quasi peak / 120 kHz	42 to 35
	230-1000				42
A2.4	30-230	FAR	3		52 to 45
	230-1000				52

Apply only A2.1 or A2.2 or A2.3 or A2.4 across the entire frequency range.

Class A equipment above 1000MHz

Table clause	Frequency range MHz	Measurement			Class A limits dB(μ V/m)
		Facility (see Table A.1)	Distance m	Detector type/ bandwidth	
A3.1	1000-3000	FSOATS	3	Average / 1 MHz	56
	3000-6000				60
A3.2	1000-3000			Peak / 1 MHz	76
	3000-6000				80

Apply A3.1 and A3.2 across the frequency range from 1000 MHz to the highest required frequency of measurement derived from Table 1.

Class B equipment up to 1000MHz

Table clause	Frequency range MHz	Measurement			Class B limits dB(μV/m)
		Facility (see Table A.1)	Distance m	Detector type/ bandwidth	
A4.1	30-230	OATS/SAC	10	Quasi peak / 120 kHz	30
	230-1000				37
A4.2	30-230	OATS/SAC	3		40
	230-1000				47
A4.3	30-230	FAR	10	32 to 25	
	230-1000			32	
A4.4	30-230	FAR	3	42 to 35	
	230-1000			42	

Apply only table clause A4.1 or A4.2 or A4.3 or A4.4 across the entire frequency range. These requirements are not applicable to the local oscillator and harmonics frequencies of equipment covered by Table A.6.

Class B equipment above 1000MHz

Table clause	Frequency range MHz	Measurement			Class B limits dB(μV/m)
		Facility (see Table A.1)	Distance m	Detector type/bandwidth	
A5.1	1000-3000	FSOATS	3	Average / 1 MHz	50
	3000-6000				54
A5.2	1000-3000			Peak / 1 MHz	70
	3000-6000				74

Apply A5.1 and A5.2 across the frequency range from 1000 MHz to the highest required frequency of measurement derived from Table 1.

Notes:

- (1) The limit for radiated test was performed according to as following: EN 55032
- (2) The tighter limit applies at the band edges.
- (3) Emission level (dBuV/m)=20log Emission level (uV/m).
- (4) The test result calculated as following:
 Measurement Value = Reading Level + Correct Factor
 Correct Factor = Antenna Factor + Cable Loss - Amplifier Gain(if use)
 Margin Level = Measurement Value - Limit Value

Required highest frequency for radiated measurement

Highest internal frequency (F_x) MHz	Highest measured frequency MHz
$F_x \leq 108$	1000
$108 < F_x \leq 500$	2000
$500 < F_x \leq 1000$	5000
$F_x > 1000$	5 th up to a maximum 6 GHz,

Note for FM and TV broadcast receiver, F_x is determined from the highest frequency generated or used excluding the local oscillator and tuned frequencies.

5.1.2 MEASUREMENT INSTRUMENTS LIST

Up to 1GHz:

Item	Kind of Equipment	Manufacturer	Type No.	Serial No.	Calibrated until
1	Receiver	Keysight	N9038A	MY54450004	Aug. 11, 2019
2	MXE EMI Receiver	Agilent	N9038A	MY53220133	Mar. 10, 2020
3	Pre-Amplifier	EMC INSTRUMENT	EMC 9135	980284	Mar. 10, 2020
4	Pre-Amplifier	EMC INSTRUMENT	EMC 9135	980283	Mar. 10, 2020
5	Trilog-Broadband Antenna	Schwarzbeck	VULB9168	946	Nov. 24, 2019
6	Trilog-Broadband Antenna	Schwarzbeck	VULB9168	947	Nov. 24, 2019
7	Cable	emci	LMR-400(5m+11m+15m)	N/A	Aug. 07, 2019
8	Cable	emci	LMR-400(5m+8m+8m)	N/A	Aug. 07, 2019
9	Measurement Software	Farad	EZ-EMC Ver.BTL-2ANT-1	N/A	N/A
10	Multi-Device Controller	ETS-Lindgren	2090	N/A	N/A
11	Attenuator	EMCI	EMCI-N-6-06	N0670	Nov. 24, 2019
12	Attenuator	EMCI	EMCI-N-6-06	N0671	Nov. 24, 2019

Remark: "N/A" denotes no model no., no serial no. or no calibration specified.
All calibration period of equipment list is one year.

Above 1GHz:

Item	Kind of Equipment	Manufacturer	Type No.	Serial No.	Calibrated until
1	Horn Antenna	EMCO	3115	9605-4803	Mar. 23, 2020
2	Amplifier	Agilent	8449B	3008A02584	Aug. 11, 2019
3	MXE EMI Receiver	Agilent	N9038A	MY53220133	Mar. 10, 2020
4	Measurement Software	Farad	EZ-EMC Ver.BTL-2AN T-1	N/A	N/A
5	Multi-Device Controller	ETS-Lindgren	2090	N/A	N/A
6	Controller	MF	MF-7802	MF780208159	N/A
7	Cable	Mlcable Inc.	B10-01-01-5 M	18047123	Mar. 01, 2020
8	Cable	Mlcable Inc.	B10-01-01-10 M	18072746	Mar. 01, 2020
9	Cable	N/A	A50-3.5M3.5 M-1.5M-AT	18041824	Mar. 01, 2020

Remark: "N/A" denotes no model no., no serial no. or no calibration specified.
 All calibration period of equipment list is one year.

5.1.3 TEST PROCEDURE

- a. The measuring distance of 10 m shall be used for measurements. The EUT was placed on the top of a rotating table 0.8 meter above the ground at a 10 meter semi-anechoic chamber. The table was rotated 360 degrees to determine the position of the highest radiation.(below 1GHz).
- b. The measuring distance of 3 m shall be used for measurements. The EUT was placed on the top of a rotating table 0.8 meter above the ground at a 10 meter semi-anechoic chamber. The table was rotated 360 degrees to determine the position of the highest radiation.(above 1GHz)
- c. The height of the equipment or of the substitution antenna shall be 0.8 m, the height of the test antenna shall vary between 1 m to 4 m. Both horizontal and vertical polarizations of the antenna are set to make the measurement.
- d. The initial step in collecting radiated emission data is a receiver peak detector mode pre-scanning the measurement frequency range. Significant peaks are then marked and then Quasi Peak detector mode re-measured.
- e. All readings are Peak unless otherwise stated QP in column of Note. Peak denotes that the Peak reading compliance with the QP Limits and then QP Mode measurement didn't perform. (below 1GHz)
- f. All readings are Peak Mode value unless otherwise stated AVG in column of Note. If the Peak Mode Measured value compliance with the Peak Limits and lower than AVG Limits, the EUT shall be deemed to meet both Peak & AVG Limits and then only Peak Mode was measured, but AVG Mode didn't perform. (above 1GHz)
- g. For the actual test configuration, please refer to the related Item - Block Diagram of system tested (please refer to 3.4).

5.1.4 DEVIATION FROM TEST STANDARD

No deviation

5.1.5 TEST SETUP

UP TO 1 GHZ

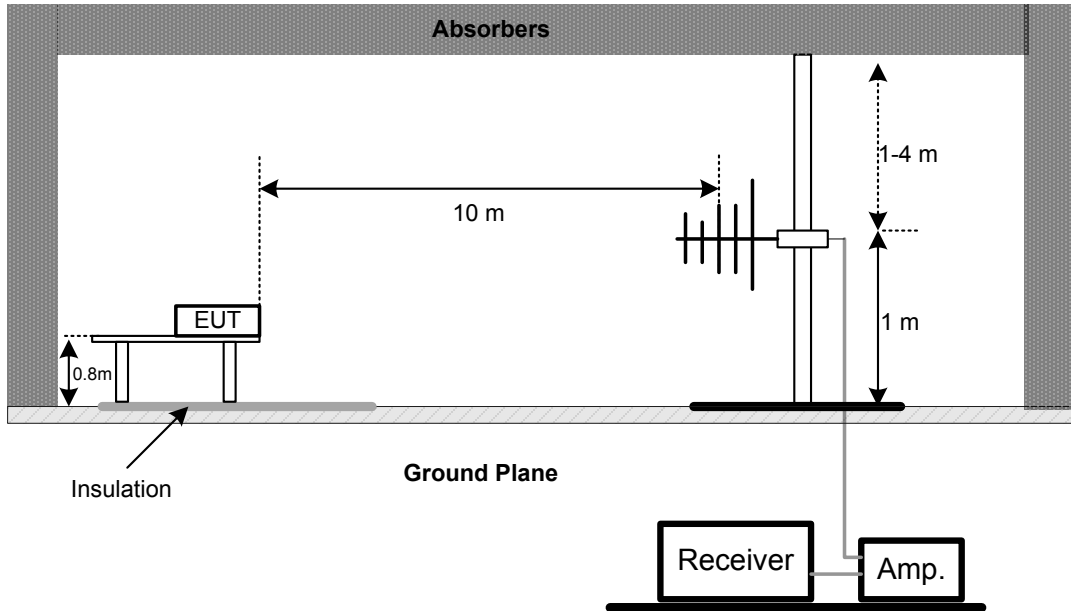

Note: The antenna can be moved between 1 to 4 meters above the ground.

ABOVE 1 GHZ

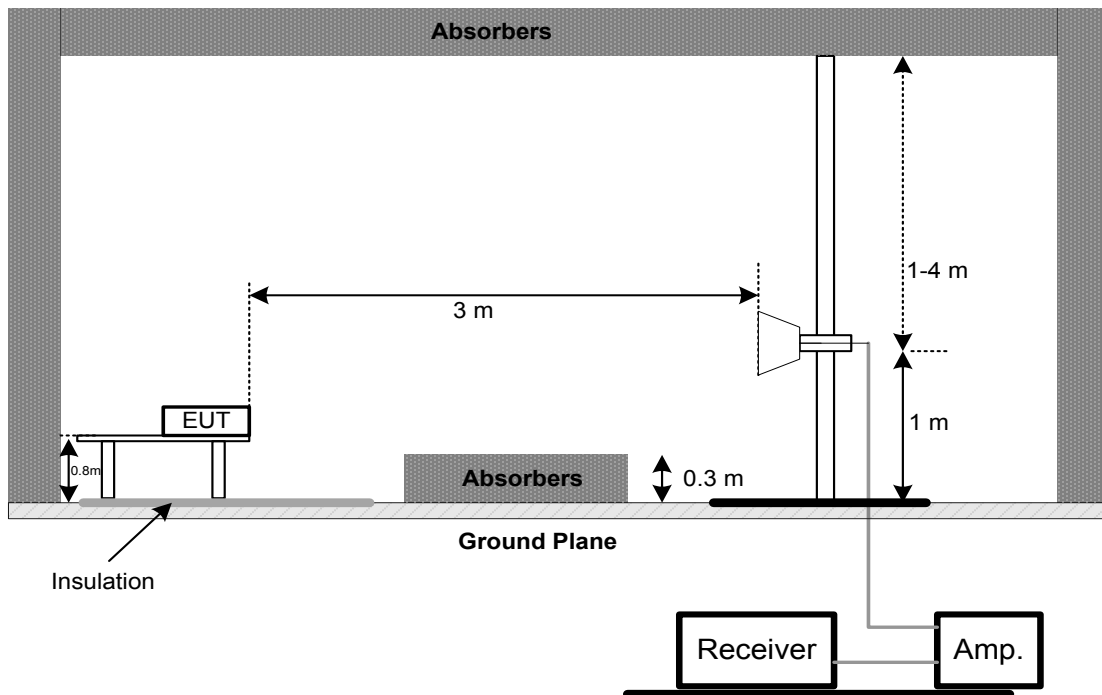

5.1.6 MEASUREMENT DISTANCE

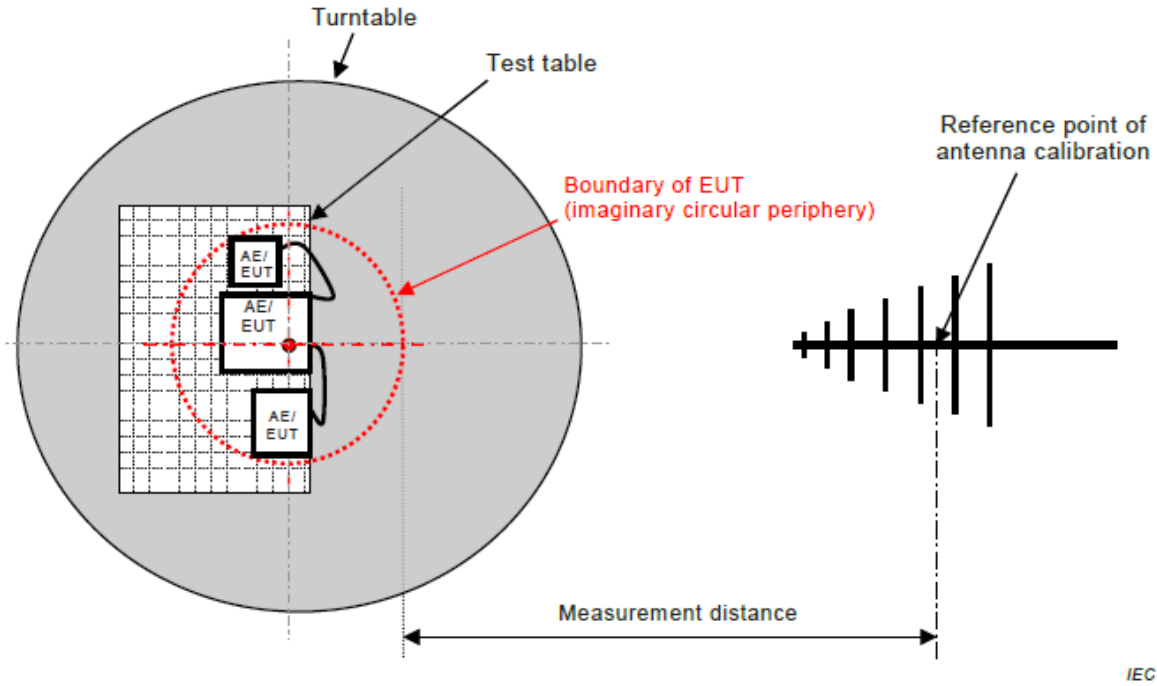

Figure C.1 – Measurement distance

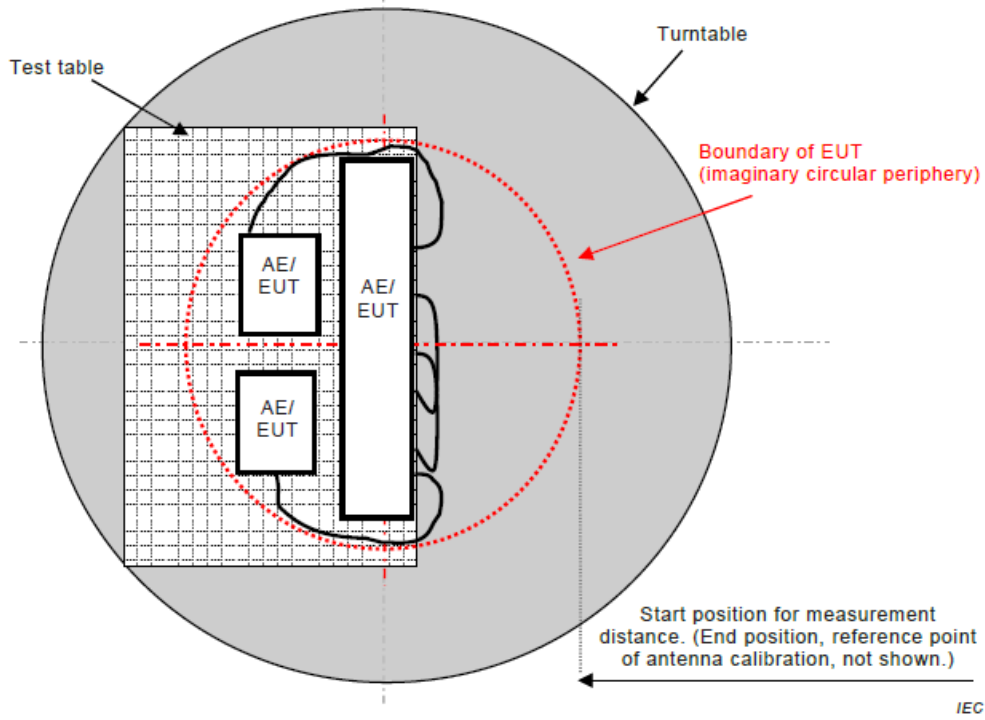
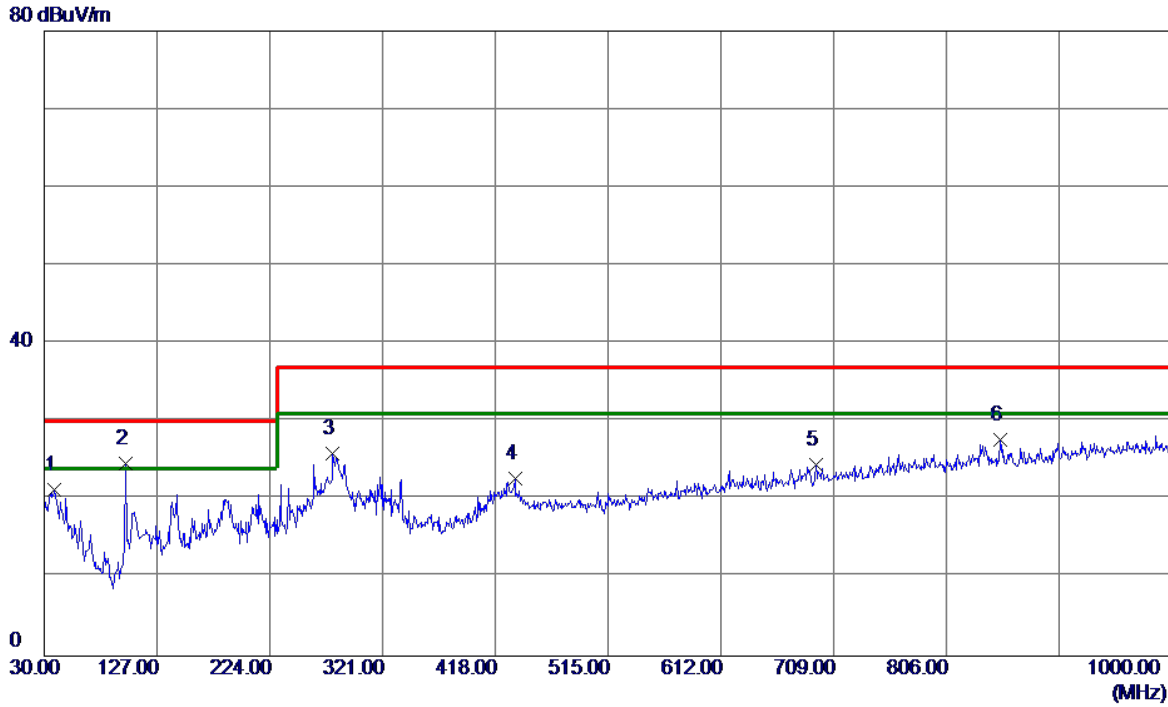

Figure C.2 – Boundary of EUT, Local AE and associated cabling

5.1.7 TEST RESULTS (UP TO 1 GHZ)

EUT	LCD Monitor	Test Model	22B2
Temperature	25°C	Relative Humidity	60%
Test Voltage	AC 230V/50Hz	Polarization	Vertical
Test Mode	HDMI 1920*1080/60Hz		
Test Engineer	Kang		



No.	Freq. MHz	Reading Level dBuV/m	Correct Factor dB	Measure ment dBuV/m	Limit dBuV/m	Margin dB	Detector
1	38.7300	38.90	-17.55	21.35	30.00	-8.65	QP
2 *	99.8399	45.68	-20.98	24.70	30.00	-5.30	QP
3	278.3200	41.64	-15.77	25.87	37.00	-11.13	QP
4	434.9750	34.54	-11.82	22.72	37.00	-14.28	QP
5	693.9650	31.72	-7.20	24.52	37.00	-12.48	QP
6	852.5600	32.92	-5.19	27.73	37.00	-9.27	QP

EUT	LCD Monitor	Test Model	22B2
Temperature	25°C	Relative Humidity	60%
Test Voltage	AC 230V/50Hz	Polarization	Horizontal
Test Mode	HDMI 1920*1080/60Hz		
Test Engineer	Kang		

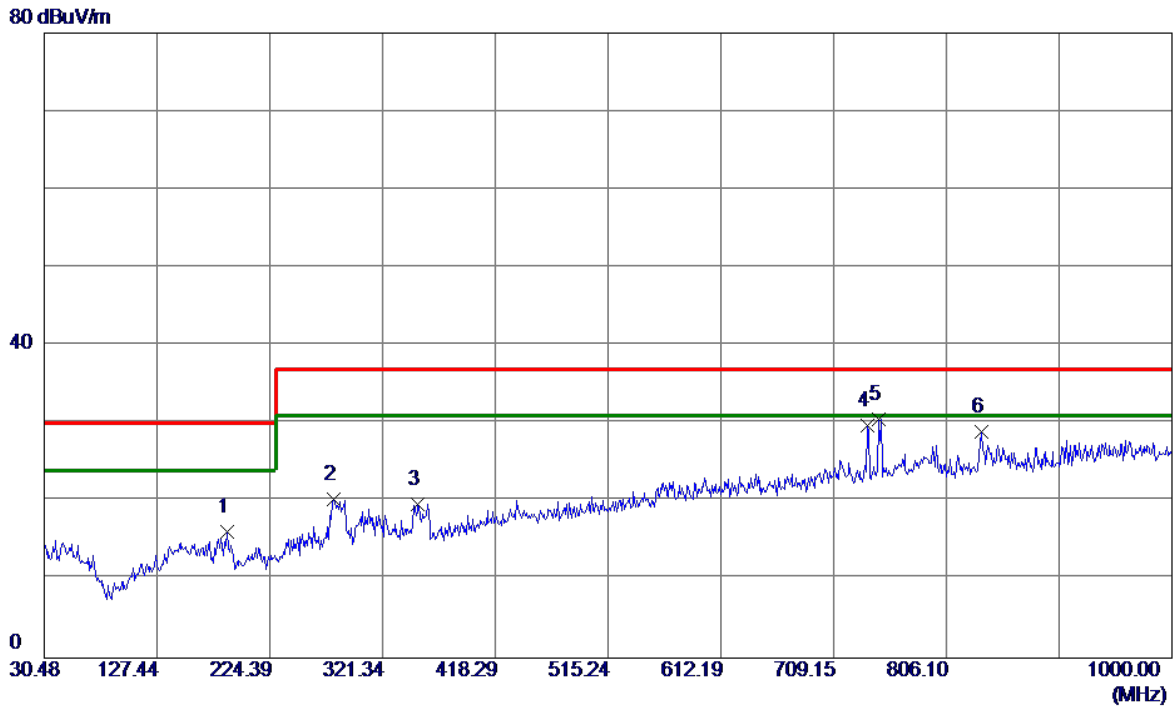

No.	Freq. MHz	Reading Level dBuV/m	Correct Factor dB	Measure ment dBuV/m	Limit dBuV/m	Margin dB	Detector
1	188.1100	34.48	-18.31	16.17	30.00	-13.83	QP
2	279.2900	36.09	-15.79	20.30	37.00	-16.70	QP
3	352.0400	33.65	-14.03	19.62	37.00	-17.38	QP
4	738.1000	36.28	-6.53	29.75	37.00	-7.25	QP
5 *	747.8000	36.93	-6.37	30.56	37.00	-6.44	QP
6	836.0700	34.49	-5.57	28.92	37.00	-8.08	QP

5.1.8 TEST RESULTS (ABOVE 1 GHZ)

EUT	LCD Monitor	Test Model	22B2
Temperature	25°C	Relative Humidity	60%
Test Voltage	AC 230V/50Hz	Polarization	Vertical
Test Mode	HDMI 1920*1080/60Hz		
Test Engineer	Kang		

86.9 dBuV/m

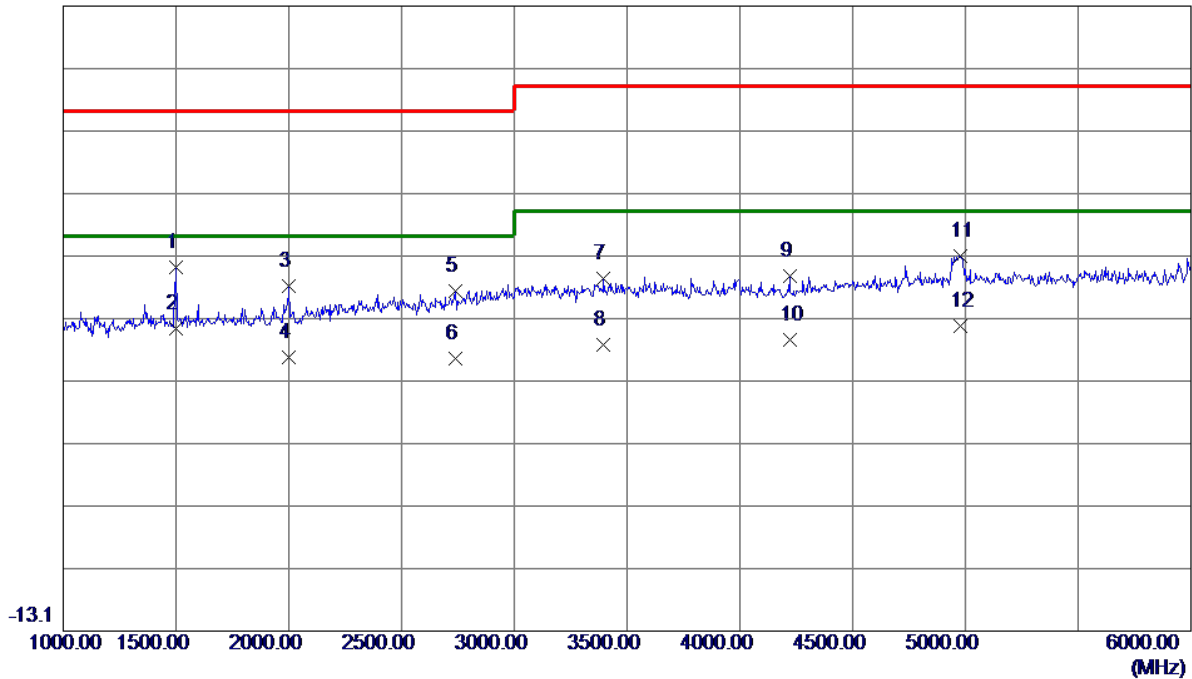

No.	Freq. MHz	Reading Level dBuV/m	Correct Factor dB	Measure ment dBuV/m	Limit dBuV/m	Margin dB	Detector
1	1500.0000	48.50	-3.48	45.02	70.00	-24.98	Peak
2 *	1500.0000	38.76	-3.48	35.28	50.00	-14.72	AVG
3	2000.0000	43.94	-1.75	42.19	70.00	-27.81	Peak
4	2000.0000	32.54	-1.75	30.79	50.00	-19.21	AVG
5	2737.5000	39.60	1.73	41.33	70.00	-28.67	Peak
6	2737.5000	28.78	1.73	30.51	50.00	-19.49	AVG
7	3395.0000	39.47	3.89	43.36	74.00	-30.64	Peak
8	3395.0000	28.79	3.89	32.68	54.00	-21.32	AVG
9	4220.0000	38.14	5.52	43.66	74.00	-30.34	Peak
10	4220.0000	27.91	5.52	33.43	54.00	-20.57	AVG
11	4977.5000	39.01	7.89	46.90	74.00	-27.10	Peak
12	4977.5000	27.73	7.89	35.62	54.00	-18.38	AVG

EUT	LCD Monitor	Test Model	22B2
Temperature	25°C	Relative Humidity	60%
Test Voltage	AC 230V/50Hz	Polarization	Horizontal
Test Mode	HDMI 1920*1080/60Hz		
Test Engineer	Kang		

86.9 dBuV/m

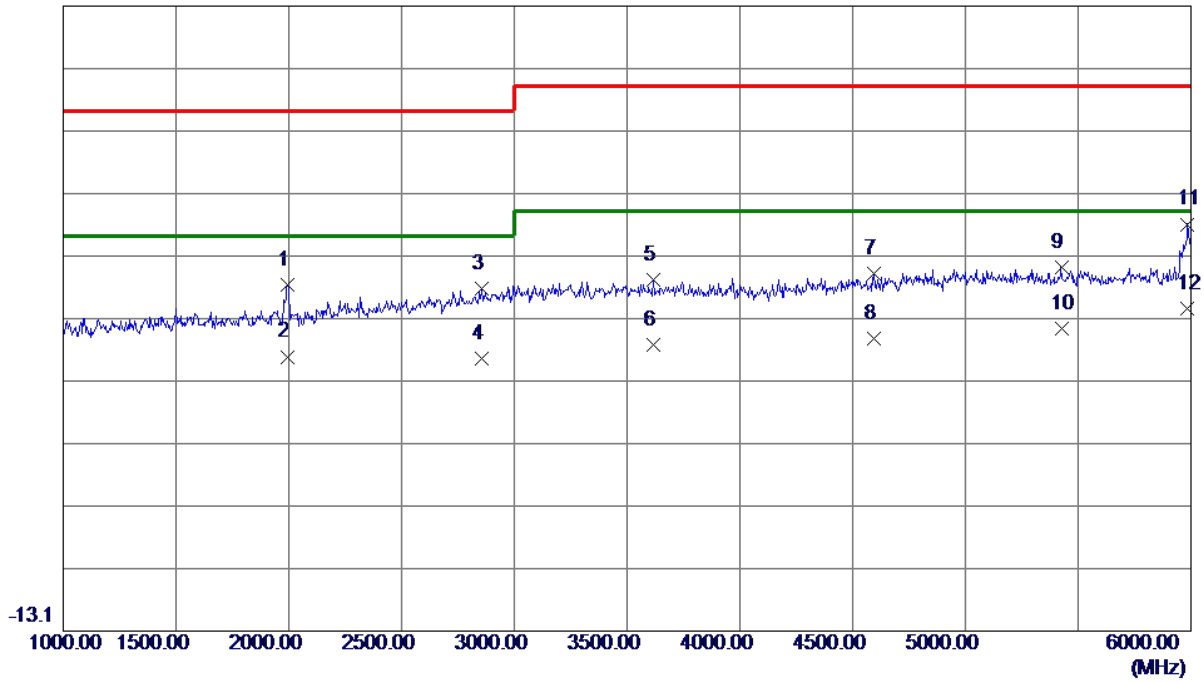

No.	Freq. MHz	Reading Level dBuV/m	Correct Factor dB	Measure ment dBuV/m	Limit dBuV/m	Margin dB	Detector
1	1995.0000	44.11	-1.77	42.34	70.00	-27.66	Peak
2	1995.0000	32.57	-1.77	30.80	50.00	-19.20	AVG
3	2857.5000	39.40	2.34	41.74	70.00	-28.26	Peak
4	2857.5000	28.25	2.34	30.59	50.00	-19.41	AVG
5	3617.5000	38.87	4.31	43.18	74.00	-30.82	Peak
6	3617.5000	28.41	4.31	32.72	54.00	-21.28	AVG
7	4595.0000	37.54	6.57	44.11	74.00	-29.89	Peak
8	4595.0000	27.07	6.57	33.64	54.00	-20.36	AVG
9	5425.0000	36.64	8.38	45.02	74.00	-28.98	Peak
10	5425.0000	26.85	8.38	35.23	54.00	-18.77	AVG
11	5985.0000	43.13	8.87	52.00	74.00	-22.00	Peak
12 *	5985.0000	29.60	8.87	38.47	54.00	-15.53	AVG

5.2 CONDUCTED EMISSION MEASUREMENT AT AC MAINS POWER PORTS

5.2.1 LIMITS

Requirements for conducted emissions from AC mains power ports of Class A equipment

Table clause	Frequency Range MHz	Coupling Device	Detector Type / bandwidth	Class A Limits (dB(μV))
A9.1	0.15 - 0.5	AMN	Quasi Peak / 9 kHz	79
	0.5 - 30			73
A9.2	0.15 - 0.5	AMN	Average / 9 kHz	66
	0.5 - 30			60

Apply A9.1 and A9.2 across the entire frequency range.

Requirements for conducted emissions from AC mains power ports of Class B equipment

Table clause	Frequency Range MHz	Coupling Device	Detector Type / bandwidth	Class B Limits (dB(μV))
A10.1	0.15 - 0.5	AMN	Quasi Peak / 9 kHz	66-56
	0.5 - 5			56
	5 - 30			60
A10.2	0.15 - 0.5	AMN	Average / 9 kHz	56-46
	0.5 - 5			46
	5 - 30			50

Apply A10.1 and A10.2 across the entire frequency range.

NOTE:

(1) The test result calculated as following:

Measurement Value = Reading Level + Correct Factor

Correct Factor = Insertion Loss + Cable Loss + Attenuator Factor(if use)

Margin Level = Measurement Value – Limit Value

5.2.2 MEASUREMENT INSTRUMENTS LIST

Item	Kind of Equipment	Manufacturer	Type No.	Serial No.	Calibrated until
1*	LISN	EMCO	3816/2SH	52766	Mar. 10, 2022
2	50Ω Terminator	SHX	TF2-3G-A	8122901	Mar. 10, 2020
3	TWO-LINE V-NETWORK	R&S	ENV216	100526	Mar. 10, 2020
4	EMI Test Receiver	R&S	ESR3	101862	Aug. 11, 2019
5	Cable	N/A	N/A(6m)	N/A	Mar. 12, 2020
6	Measurement Software	Farad	EZ-EMC Ver.NB-03A 1-01	N/A	N/A

Remark: "N/A" denotes no model no., no serial no. or no calibration specified.

"*" calibration period of equipment list is three year.

Except * item, all calibration period of equipment list is one year.

5.2.3 TEST PROCEDURE

- a. The EUT was placed 0.8 meters from the horizontal ground plane with EUT being connected to the power mains through a line impedance stabilization network (LISN). All other support equipments powered from additional LISN(s). The LISN provide 50 Ohm/ 50uH of coupling impedance for the measuring instrument.
- b. Interconnecting cables that hang closer than 40 cm to the ground plane shall be folded back and forth in the center forming a bundle 30 to 40 cm long.
- c. I/O cables that are not connected to a peripheral shall be bundled in the center. The end of the cable may be terminated, if required, using the correct terminating impedance. The overall length shall not exceed 1 m.
- d. LISN at least 80 cm from nearest part of EUT chassis.
- e. For the actual test configuration, please refer to the related Item –EUT Test Photos.

5.2.4 DEVIATION FROM TEST STANDARD

No deviation

5.2.5 TEST SETUP

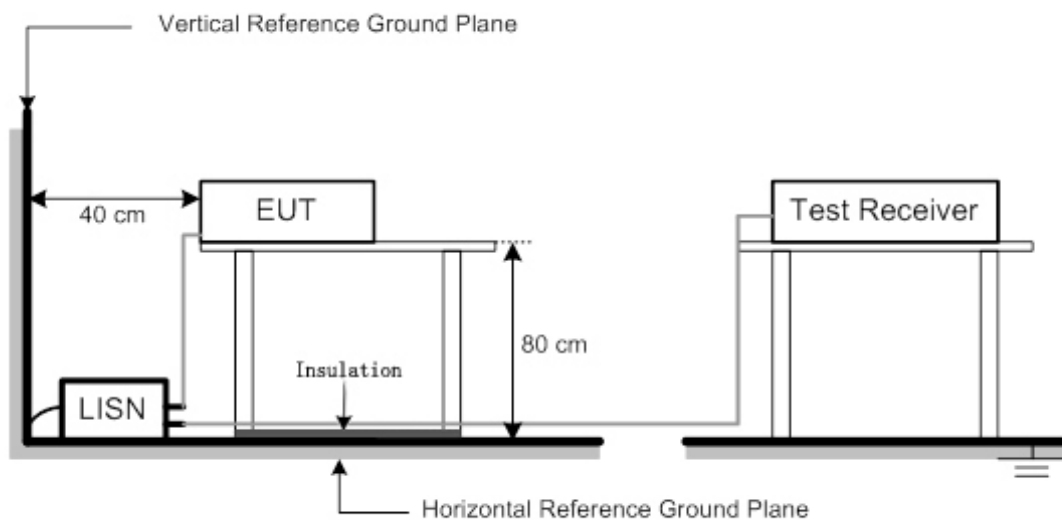

5.2.6 TEST RESULTS

EUT	LCD Monitor	Test Model	22B2
Temperature	25°C	Relative Humidity	53%
Test Voltage	AC 230V/50Hz	Phase	Line
Test Mode	HDMI 1920*1080/60Hz		
Test Engineer	Kang		

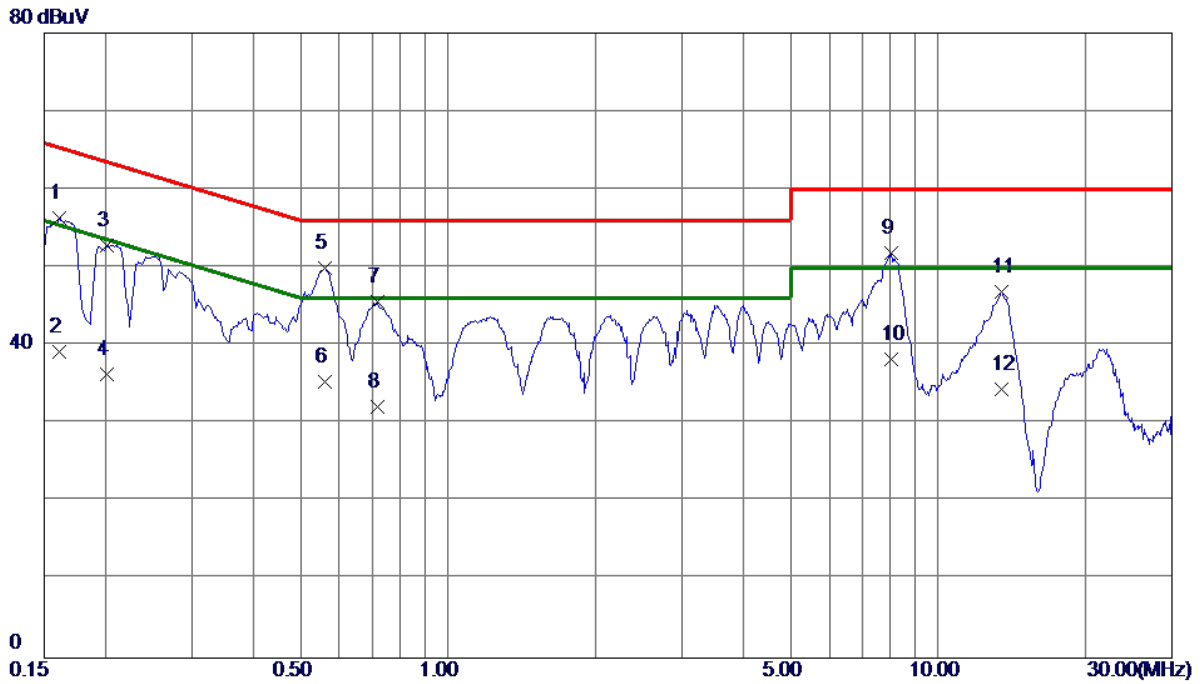

No.	Freq. MHz	Reading Level dBuV	Correct Factor dB	Measure ment dBuV	Limit dBuV	Margin dB	Detector
1	0.1613	46.74	9.57	56.31	65.40	-9.09	QP
2	0.1613	29.70	9.57	39.27	55.40	-16.13	AVG
3	0.2017	43.25	9.56	52.81	63.54	-10.73	QP
4	0.2017	26.80	9.56	36.36	53.54	-17.18	AVG
5 *	0.5595	40.31	9.58	49.89	56.00	-6.11	QP
6	0.5595	25.80	9.58	35.38	46.00	-10.62	AVG
7	0.7170	35.95	9.59	45.54	56.00	-10.46	QP
8	0.7170	22.50	9.59	32.09	46.00	-13.91	AVG
9	8.0318	41.73	10.05	51.78	60.00	-8.22	QP
10	8.0318	28.20	10.05	38.25	50.00	-11.75	AVG
11	13.4408	36.55	10.31	46.86	60.00	-13.14	QP
12	13.4408	24.15	10.31	34.46	50.00	-15.54	AVG

EUT	LCD Monitor	Test Model	22B2
Temperature	25°C	Relative Humidity	53%
Test Voltage	AC 230V/50Hz	Phase	Neutral
Test Mode	HDMI 1920*1080/60Hz		
Test Engineer	Kang		

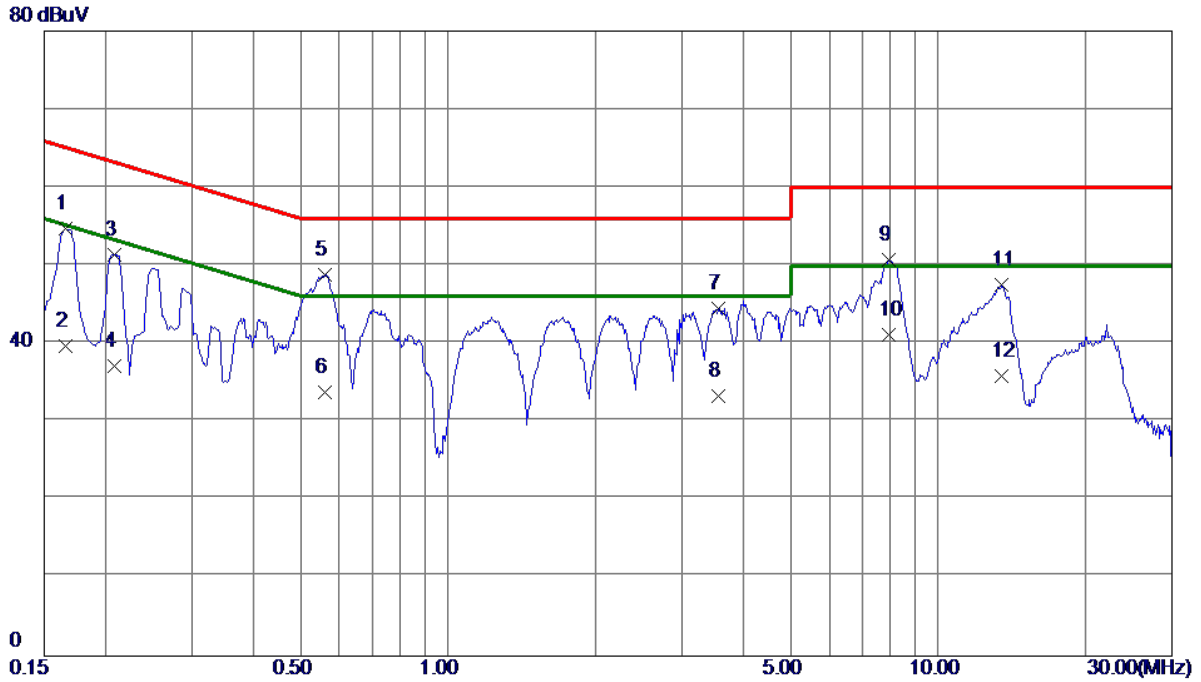

No.	Freq. MHz	Reading Level dBuV	Correct Factor dB	Measure ment dBuV	Limit dBuV	Margin dB	Detector
1	0.1658	45.12	9.54	54.66	65.17	-10.51	QP
2	0.1658	30.10	9.54	39.64	55.17	-15.53	AVG
3	0.2085	41.84	9.54	51.38	63.26	-11.88	QP
4	0.2085	27.60	9.54	37.14	53.26	-16.12	AVG
5 *	0.5617	39.25	9.57	48.82	56.00	-7.18	QP
6	0.5617	24.20	9.57	33.77	46.00	-12.23	AVG
7	3.5520	34.76	9.78	44.54	56.00	-11.46	QP
8	3.5520	23.50	9.78	33.28	46.00	-12.72	AVG
9	7.9238	40.64	10.05	50.69	60.00	-9.31	QP
10	7.9238	31.10	10.05	41.15	50.00	-8.85	AVG
11	13.4813	37.14	10.34	47.48	60.00	-12.52	QP
12	13.4813	25.49	10.34	35.83	50.00	-14.17	AVG

6. HARMONIC AND FLICKER TEST

6.1 HARMONIC CURRENT EMISSIONS

6.1.1 LIMITS

EN 61000-3-2						
Equipment Category	Harmonic Order	Max. Permissible Harmonic Current	Equipment Category	Harmonic Order	Max. Permissible Harmonic Current	
	n	A		n	A	mA/w
Class A	Odd Harmonics		Class D	Odd Harmonics only		
	3	2.30		3	2.30	3.4
	5	1.14		5	1.14	1.9
	7	0.77		7	0.77	1.0
	9	0.40		9	0.40	0.5
	11	0.33		11	0.33	0.35
	13	0.21		13	0.21	0.30
	15≤n≤39	0.15 x 15/n		15≤n≤39	0.15 x 15/n	3.85/n
	Even Harmonics					
	2	1.08				
	4	0.43				
	6	0.30				
	8≤n≤40	0.23 x 8/n				

6.1.2 MEASUREMENT INSTRUMENTS LIST

Item	Kind of Equipment	Manufacturer	Type No.	Serial No.	Calibrated until
1	Harmonics and Flicker Analyzer	California Instruments	PACS-1	72344	Aug. 13, 2019
2	3KVA AC Power source	California Instruments	3001ix	56309	Aug. 11, 2019
3	Measurement Software	California	CTS4.0 Version 4.21	N/A	N/A

Remark: "N/A" denotes no model no., no serial No. or no calibration specified.

All calibration period of equipment list is one year.

6.1.3 TEST PROCEDURE

- a. The EUT was placed on the top of a wooden table 0.8 meters above the ground and operated to produce the maximum harmonic components under normal operating conditions.
- b. The classification of EUT is according to of EN 61000-3-2. The EUT is classified as follows:
 - Class A: Balanced three-phase equipment, Household appliances excluding equipment as Class D, Tools excluding portable tools, Dimmers for incandescent lamps, audio equipment, equipment not specified in one of the three other classes.
 - Class B: Portable tools; Arc welding equipment which is not professional equipment.
 - Class C: Lighting equipment.
 - Class D: Equipment having a specified power less than or equal to 600 W of the following types: Personal computers and personal computer monitors and television receivers.
- c. The correspondent test program of test instrument to measure the current harmonics emanated from EUT is chosen. The measure time shall be not less than the time necessary for the EUT to be exercised.

6.1.4 DEVIATION FROM TEST STANDARD

No deviation

6.1.5 TEST SETUP

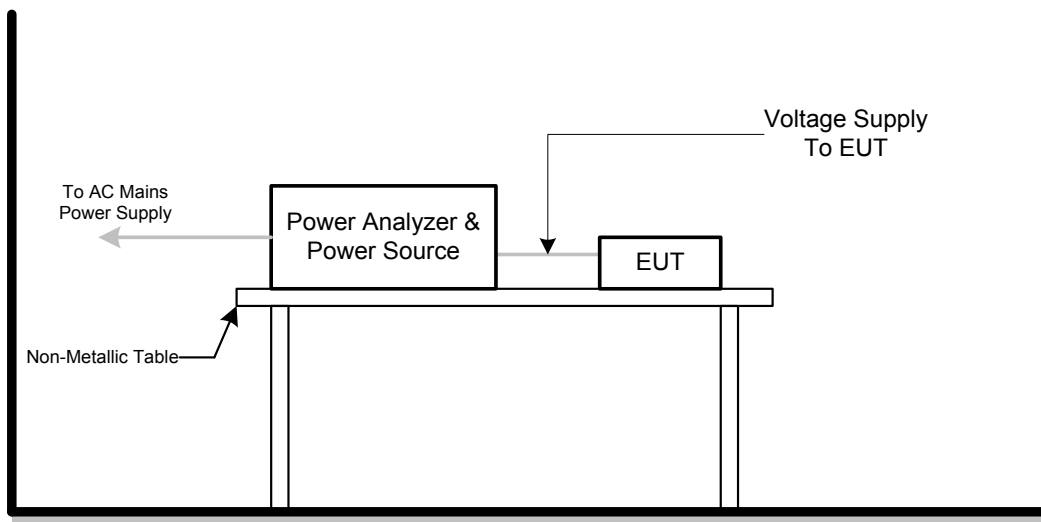

6.1.6 TEST RESULTS

Harmonic - Class D			
EUT	LCD Monitor	Test Model	22B2
Temperature	25°C	Relative Humidity	55%
Test Voltage	AC 230V/50Hz		
Test Mode	HDMI 1920*1080/60Hz		

Current & voltage waveforms



Harmonics and Class D limit line European Limits

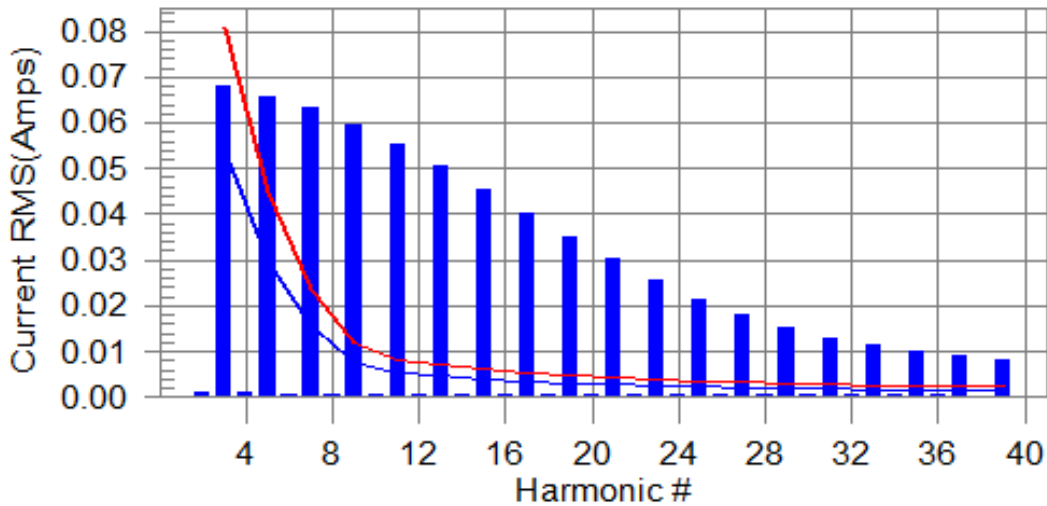

Test result: N/L Worst harmonics H0-0.0% of 150% limit, H0-0% of 100% limit

Current Test Result Summary (Run time)			
EUT	LCD Monitor	Test Model	22B2
Temperature	25°C	Relative Humidity	55%
Test Voltage	AC 230V/50Hz		
Test Mode	HDMI 1920*1080/60Hz		

Highest parameter values during test:

V _{RMS} (Volts): 230.25	Frequency(Hz): 50.00
I _{Peak} (Amps): 1.020	I _{RMS} (Amps): 0.192
Γ _{Fund} (Amps): 0.080	Crest Factor: 5.355
P _{Power} (Watts): 15.8	Power Factor: 0.361

Harm#	Harms(avg)	100%Limit	%of Limit	Harms(max)	150%Limit	%of Limit	Status
2	0.001	0.000	N/A	0.002	0.000	N/A	N/L
3	0.068	0.054	N/A	0.069	0.081	N/A	N/L
4	0.001	0.000	N/A	0.001	0.000	N/A	N/L
5	0.066	0.030	N/A	0.066	0.045	N/A	N/L
6	0.001	0.000	N/A	0.001	0.000	N/A	N/L
7	0.063	0.016	N/A	0.063	0.024	N/A	N/L
8	0.001	0.000	N/A	0.001	0.000	N/A	N/L
9	0.059	0.008	N/A	0.060	0.012	N/A	N/L
10	0.001	0.000	N/A	0.001	0.000	N/A	N/L
11	0.055	0.006	N/A	0.055	0.008	N/A	N/L
12	0.001	0.000	N/A	0.001	0.000	N/A	N/L
13	0.051	0.005	N/A	0.051	0.007	N/A	N/L
14	0.001	0.000	N/A	0.001	0.000	N/A	N/L
15	0.046	0.004	N/A	0.046	0.006	N/A	N/L
16	0.001	0.000	N/A	0.001	0.000	N/A	N/L
17	0.040	0.004	N/A	0.040	0.005	N/A	N/L
18	0.001	0.000	N/A	0.001	0.000	N/A	N/L
19	0.035	0.003	N/A	0.035	0.005	N/A	N/L
20	0.001	0.000	N/A	0.001	0.000	N/A	N/L
21	0.030	0.003	N/A	0.030	0.004	N/A	N/L
22	0.001	0.000	N/A	0.001	0.000	N/A	N/L
23	0.026	0.003	N/A	0.026	0.004	N/A	N/L
24	0.001	0.000	N/A	0.001	0.000	N/A	N/L
25	0.022	0.002	N/A	0.022	0.004	N/A	N/L
26	0.001	0.000	N/A	0.001	0.000	N/A	N/L
27	0.018	0.002	N/A	0.018	0.003	N/A	N/L
28	0.001	0.000	N/A	0.001	0.000	N/A	N/L
29	0.015	0.002	N/A	0.015	0.003	N/A	N/L
30	0.001	0.000	N/A	0.001	0.000	N/A	N/L
31	0.013	0.002	N/A	0.013	0.003	N/A	N/L
32	0.001	0.000	N/A	0.001	0.000	N/A	N/L
33	0.011	0.002	N/A	0.011	0.003	N/A	N/L
34	0.001	0.000	N/A	0.001	0.000	N/A	N/L
35	0.010	0.002	N/A	0.010	0.003	N/A	N/L
36	0.000	0.000	N/A	0.001	0.000	N/A	N/L
37	0.009	0.002	N/A	0.009	0.002	N/A	N/L
38	0.000	0.000	N/A	0.001	0.000	N/A	N/L
39	0.008	0.002	N/A	0.008	0.002	N/A	N/L
40	0.000	0.000	N/A	0.000	0.000	N/A	N/L

Note: The EUT power level is below 75.0 Watts and therefore has no defined limits

Voltage Source Verification Data (Run time)			
EUT	LCD Monitor	Test Model	22B2
Temperature	25°C	Relative Humidity	55%
Test Voltage	AC 230V/50Hz		
Test Mode	HDMI 1920*1080/60Hz		

Highest parameter values during test:

Voltage (Vrms): 230.25	Frequency(Hz): 50.00
I Peak (Amps): 1.020	I RMS (Amps): 0.192
ΓFund (Amps): 0.080	Crest Factor: 5.355
Power (Watts): 15.8	Power Factor: 0.361

Harm#	Harmonics V-rms	Limit V-rms	% of Limit	Status
2	0.118	0.460	25.65	OK
3	0.459	2.072	22.14	OK
4	0.059	0.460	12.74	OK
5	0.045	0.921	4.88	OK
6	0.028	0.460	5.98	OK
7	0.052	0.691	7.57	OK
8	0.020	0.460	4.39	OK
9	0.032	0.460	6.99	OK
10	0.026	0.460	5.58	OK
11	0.046	0.230	19.85	OK
12	0.014	0.230	6.19	OK
13	0.023	0.230	10.15	OK
14	0.013	0.230	5.74	OK
15	0.041	0.230	17.93	OK
16	0.020	0.230	8.63	OK
17	0.031	0.230	13.36	OK
18	0.015	0.230	6.58	OK
19	0.036	0.230	15.47	OK
20	0.018	0.230	7.70	OK
21	0.027	0.230	11.77	OK
22	0.013	0.230	5.75	OK
23	0.029	0.230	12.48	OK
24	0.005	0.230	2.32	OK
25	0.025	0.230	10.76	OK
26	0.007	0.230	3.15	OK
27	0.022	0.230	9.38	OK
28	0.007	0.230	3.20	OK
29	0.024	0.230	10.48	OK
30	0.005	0.230	2.09	OK
31	0.017	0.230	7.46	OK
32	0.005	0.230	2.09	OK
33	0.022	0.230	9.50	OK
34	0.004	0.230	1.63	OK
35	0.015	0.230	6.36	OK
36	0.003	0.230	1.37	OK
37	0.016	0.230	7.07	OK
38	0.003	0.230	1.44	OK
39	0.013	0.230	5.86	OK
40	0.006	0.230	2.42	OK

6.2 VOLTAGE CHANGES, VOLTAGE FLUCTUATIONS AND FLICKER TEST

6.2.1 LIMITS

Tests	Limits	Descriptions
	EN 61000-3-3	
Pst	≤ 1.0 , $T_p= 10$ min.	Short Term Flicker Indicator
Plt	≤ 0.65 , $T_p=2$ hr.	Long Term Flicker Indicator
dc	$\leq 3.3\%$	Relative Steady-State V-Chang
dmax	$\leq 4\%$	Maximum Relative V-change
d (t)	≤ 500 ms	Relative V-change characteristic

6.2.2 MEASUREMENT INSTRUMENTS LIST

Item	Kind of Equipment	Manufacturer	Type No.	Serial No.	Calibrated until
1	Harmonics and Flicker Analyzer	California Instruments	PACS-1	72344	Aug. 13, 2019
2	3KVA AC Power source	California Instruments	3001ix	56309	Aug. 11, 2019
3	Measurement Software	California	CTS4.0 Version 4.21	N/A	N/A

Remark: "N/A" denotes no model no., no serial No. or no calibration specified.
All calibration period of equipment list is one year.

6.2.3 TEST PROCEDURE

- a. Tests was performed according to the Test Conditions/Assessment of Voltage Fluctuations specified in EN 61000-3-3 depend on which standard adopted for compliance measurement.
- b. All types of harmonic current and/or voltage fluctuation in this report are assessed by direct measurement using flicker-meter.

6.2.4 DEVIATION FROM TEST STANDARD

No deviation

6.2.5 TEST SETUP

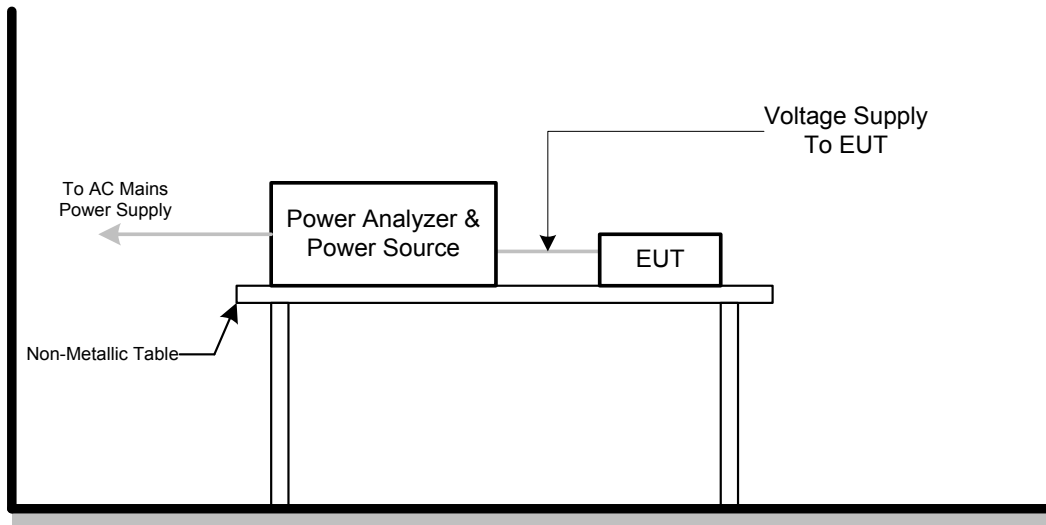

6.2.6 TEST RESULTS

EUT	LCD Monitor	Test Model	22B2
Temperature	25°C	Relative Humidity	55%
Test Voltage	AC 230V/50Hz		
Test Mode	HDMI 1920*1080/60Hz		

Psti and limit line

European Limits

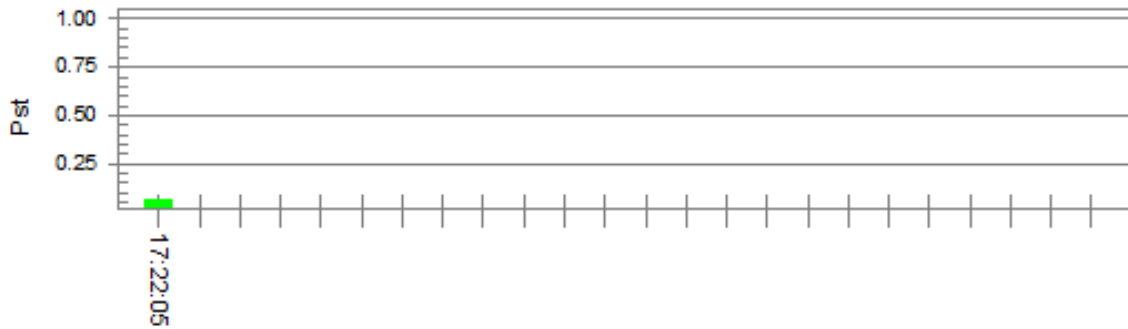

Plt and limit line



Parameter values recorded during the test:

Vrms at the end of test (Volt):	230.23		
T-max (mS):	0	Test limit (mS):	500.0 Pass
Highest dc (%):	0.00	Test limit (%):	3.30 Pass
Highest dmax (%):	0.00	Test limit (%):	4.00 Pass
Highest Pst (10 min. period):	0.064	Test limit:	1.000 Pass
Highest Plt (2 hr. period):	0.028	Test limit:	0.650 Pass

7. EMC IMMUNITY TEST

7.1 STANDARD COMPLIANCE/SEVERITY LEVEL/CRITERIA

Tests Standard No.	Test Specification Level / Test Mode	Test Ports	Criteria
Electrostatic discharge EN 61000-4-2 (ESD)	±8 kV air discharge ±4 kV contact discharge (Direct Mode)	Enclosure	B
	±4kV HCP discharge ±4kV VCP discharge (Indirect Mode)	Enclosure	B
Radiated, radio-frequency, electromagnetic field immunity EN 61000-4-3 (RS)	80 MHz to 1000 MHz 3V/m(unmodulated, r.m.s), 1 kHz, 80%, AM modulated	Enclosure	A
Electrical fast transient/burst immunity EN 61000-4-4 (EFT/Burst)	±0.5kV(peak) 5/50ns Tr/Th 5kHz Repetition Frequency (100kHz Repetition Frequency for xDSL equipment)	Signal ports and telecommunication ports (Only applicable to cable length>3 m)	B
	±0.5kV(peak) 5/50ns Tr/Th 5kHz Repetition Frequency	DC Power Ports	B
	±1 kV(peak) 5/50ns Tr/Th 5kHz Repetition Frequency	AC Power Ports	B
Surge immunity EN 61000-4-5 (Surges)	±1 kV(peak) 10/700 Tr/Th μs(NOTE) (without primary protection)	Signal ports and telecommunication ports (applicable only to ports connect directly to outdoor cables)	C
	±4 kV(peak) 10/700 Tr/Th μs(NOTE) (with primary protectors fitted)		C
	±0.5 kV(peak) 1.2/50(8/20) Tr/Th μs	DC Power Ports (applicable only to ports connect directly to outdoor cables)	B
	±1 kV(peak) 1.2/50(8/20) Tr/Th μs (line to line)	AC Power Ports	B
	±2 kV(peak) 1.2/50(8/20) Tr/Th μs (line to earth or ground)		B

Immunity to conducted disturbances, induced by radio-frequency fields EN 61000-4-6 (Injected Current)	0.15 MHz to 80 MHz 3V(unmodulated, r.m.s), 1kHz 80%, AM 150Ω source impedance	Signal ports and telecommunication ports (Only applicable to cable length>3 m)	A
	0.15 MHz to 80 MHz 3V(unmodulated, r.m.s), 1kHz 80%, AM 150Ω source impedance	DC Power Ports	A
	0.15 MHz to 80 MHz 3V(unmodulated, r.m.s), 1kHz 80%, AM 150Ω source impedance	AC Power Ports	A
Power frequency magnetic field immunity EN 61000-4-8 (PFMF)	50 Hz or 60Hz, 1A/m(r.m.s)	Enclosure	A
Voltage dips, short interruptions and voltage variations immunity EN 61000-4-11 (Voltage Interruption/Dips)	Voltage reduction > 95% 0.5 period Voltage reduction 30% 25 periods Voltage reduction > 95% 250 periods	AC Power Ports	B C C

Note.

Where the coupling network for the 10/700 μs waveform affects the functioning of high speed data ports, the test shall be carried out using a 1,2/50 (8/20) μs waveform and appropriate coupling network.

7.2 GENERAL PERFORMANCE CRITERIA

According to **EN55024** standard, the general performance criteria as following:

<p>Criterion A</p>	<p>The equipment shall continue to operate as intended without operator intervention. No degradation of performance or loss of function is allowed below a performance level specified by the manufacturer when the equipment is used as intended. The performance level may be replaced by a permissible loss of performance.</p> <p>If the minimum performance level or the permissible performance loss is not specified by the manufacturer, then either of these may be derived from the product description and documentation, and by what the user product description and documentation, and by what the user may reasonably expect from the equipment if used as intended.</p>
<p>Criterion B</p>	<p>After the test, the equipment shall continue to operate as intended without operator intervention. No degradation of performance or loss of function is allowed, after the application of the phenomenon below a performance level specified by the manufacturer, when the equipment is used as intended. The performance level may be replaced by a permissible loss of performance.</p> <p>During the test, degradation of performance is allowed. However, no change of operating state if stored data allowed to persist after the test. If the minimum performance level (or the permissible performance loss) is not specified by the manufacturer, then either of these may be derived from the product description and documentation, and by what the user may reasonably expect from the equipment if used as intended.</p>
<p>Criterion C</p>	<p>Loss of function is allowed, provided the function is self-recoverable, or can be restored by the operation of the controls by the user in accordance with the manufacturer's instructions.</p> <p>Functions, and/or information stored in non-volatile memory, or protected by a battery backup, shall not be lost.</p>

7.3 ELECTROSTATIC DISCHARGE IMMUNITY TEST (ESD)

7.3.1 TEST SPECIFICATION

Basic Standard	EN 61000-4-2
Discharge Impedance	330 ohm / 150 pF
Required Performance	B
Discharge Voltage	Air Discharge: ± 2 kV, ± 4 kV, ± 8 kV (Direct) Contact Discharge: ± 2 kV, ± 4 kV (Direct/Indirect)
Polarity	Positive & Negative
Number of Discharge	Air Discharge: min. 20 times at each test point Contact Discharge: min. 200 times in total
Discharge Mode	Single Discharge
Discharge Period	1 second minimum

7.3.2 MEASUREMENT INSTRUMENTS

Item	Kind of Equipment	Manufacturer	Type No.	Serial No.	Calibrated until
1	ESD Generator	TESEQ AG	NSG 437	450	Sep. 28, 2019

Remark: "N/A" denotes no model no., no serial No. or no calibration specified.
All calibration period of equipment list is one year.

7.3.3 TEST PROCEDURE

The test generator necessary to perform direct and indirect application of discharges to the EUT in the following manner:

- a. Contact discharge was applied to conductive surfaces (Direct) and coupling planes (Indirect) of the EUT.

During the test, it was performed with single discharges. For the single discharge time between successive single discharges was at least 1 second. The EUT shall be exposed to at least 200 discharges, 100 each at negative and positive polarity, at a minimum of four test points. One of the test points shall be subjected to at least 50 indirect discharges to the center of the front edge of the horizontal coupling plane. The remaining three test points shall each receive at least 50 direct contact discharges.

If no direct contact test points are available, then at least 200 indirect discharges shall be applied in the indirect mode. Test shall be performed at a maximum repetition rate of one discharge per second.

Vertical Coupling Plane (VCP):

The coupling plane, of dimensions 0.5m x 0.5m, is placed parallel to, and positioned at a distance 0.1m from, the EUT, with the Discharge Electrode touching the coupling plane.

The four faces of the EUT will be performed with electrostatic discharge.

Horizontal Coupling Plane (HCP):

The coupling plane is placed under to the EUT. The generator shall be positioned vertically at a distance of 0.1m from the EUT, with the Discharge Electrode touching the coupling plane.

The four faces of the EUT will be performed with electrostatic discharge.

- b. Air discharges at insulation surfaces of the EUT.

It was at least ten single discharges with positive and negative at the same selected point.

7.3.4 DEVIATION FROM TEST STANDARD

No deviation

7.3.5 TEST SETUP

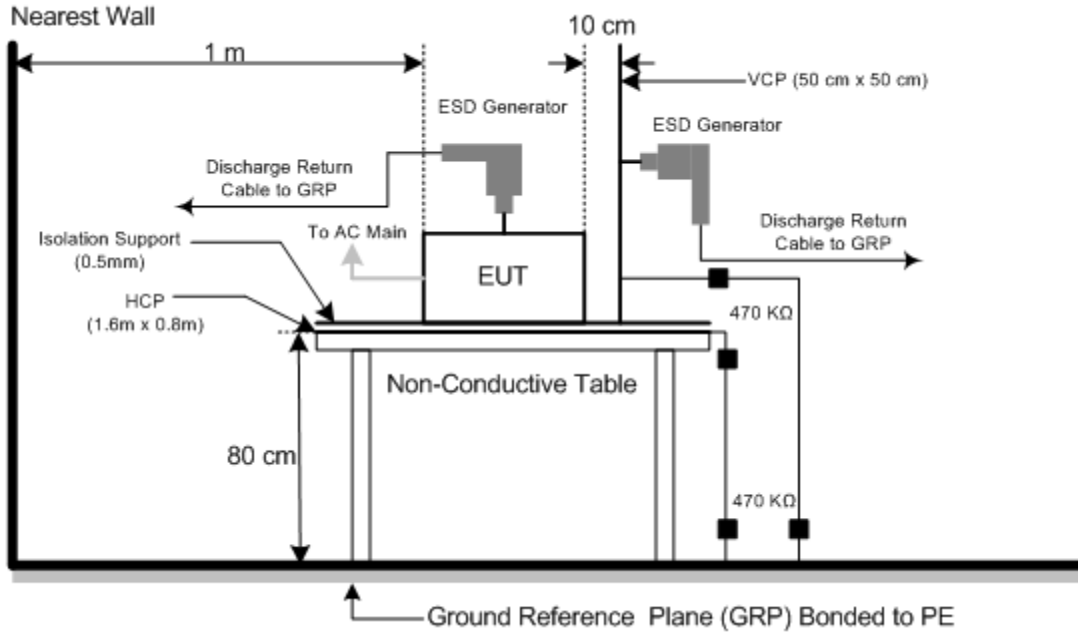

Note:

TABLE-TOP EQUIPMENT

The configuration consisted of a wooden table 0.8 meters high standing on the Ground Reference Plane. The GRP consisted of a sheet of aluminum at least 0.25mm thick, and 2.5 meters square connected to the protective grounding system. A Horizontal Coupling Plane (1.6m x 0.8m) was placed on the table and attached to the GRP by means of a cable with 940k total impedance. The equipment under test was installed in a representative system as described in EN 61000-4-2, and its cables were placed on the HCP and isolated by an insulating support of 0.5mm thickness. A distance of 1-meter minimum was provided between the EUT and the walls of the laboratory and any other metallic structure.

FLOOR-STANDING EQUIPMENT

The equipment under test was installed in a representative system as described in EN 61000-4-2, and its cables were isolated from the Ground Reference Plane by an insulating support of 0.1-meter thickness. The GRP consisted of a sheet of aluminum that is at least 0.25mm thick, and 2.5meters square connected to the protective grounding system and extended at least 0.5 meters from the EUT on all sides.

7.3.6 TEST RESULTS

EUT	LCD Monitor	Test Model	22B2
Temperature	25°C	Relative Humidity	47%
Test Voltage	AC 230V/50Hz	Pressure	1010hPa
Test Mode	HDMI 1920*1080/60Hz		

Mode	Air Discharge								Contact Discharge					
	2kV		4kV		8kV		- kV		2kV		4kV		- kV	
Location	P	N	P	N	P	N	P	N	P	N	P	N	P	N
1	A	A	A	A	B	B	-	-	A	A	A	A	-	-
2	A	A	A	A	A	A	-	-	-	-	-	-	-	-
3	A	A	A	A	A	A	-	-	-	-	-	-	-	-
4	A	A	A	A	A	A	-	-	-	-	-	-	-	-
5	A	A	A	A	A	A	-	-	-	-	-	-	-	-
Criteria	B						-		B					
Result	B						-		A					
Judgment	PASS						-		PASS					

Mode	HCP Contact Discharge						VCP Contact Discharge							
	2kV		4kV		- kV		2kV		4kV		- kV			
Location	P	N	P	N	P	N	P	N	P	N	P	N		
1	A	A	A	A	-	-	A	A	A	A	-	-		
2	A	A	A	A	-	-	A	A	A	A	-	-		
3	A	A	A	A	-	-	A	A	A	A	-	-		
4	A	A	A	A	-	-	A	A	A	A	-	-		
Criteria	B						-		B					
Result	A						-		A					
Judgment	PASS						-		PASS					

Note:

- 1) P/N denotes the Positive/Negative polarity of the output voltage.
- 2) Test condition:
 - Direct/Indirect(HCP/VCP) discharges: Minimum 50 times (Positive/Negative) at eachpoint.
 - Air discharges: Minimum 20 times (Positive/Negative) at each point.
- 3) Test location(s) in which discharge (Air and contact discharge) to be applied illustrated by photos shown in next page(s)
- 4) The Indirect (HCP/VCP) discharges description of test point as following:
 - 1.left side; 2.right side; 3.front side; 4.rear side.
- 5) N/A - denotes test is not applicable in this test report
- 6) Criterion A: No observation of any performance degradation.
- 7) Criterion B: Some degradation of performance is observed but the equipment continues to operate as intended.
- 8) Criterion C: Loss of functionality, but self-recoverable by user, without loss of information or settings.

PHOTO(S) SHOWN THE LOCATION(S) OF ESD EVALUATED

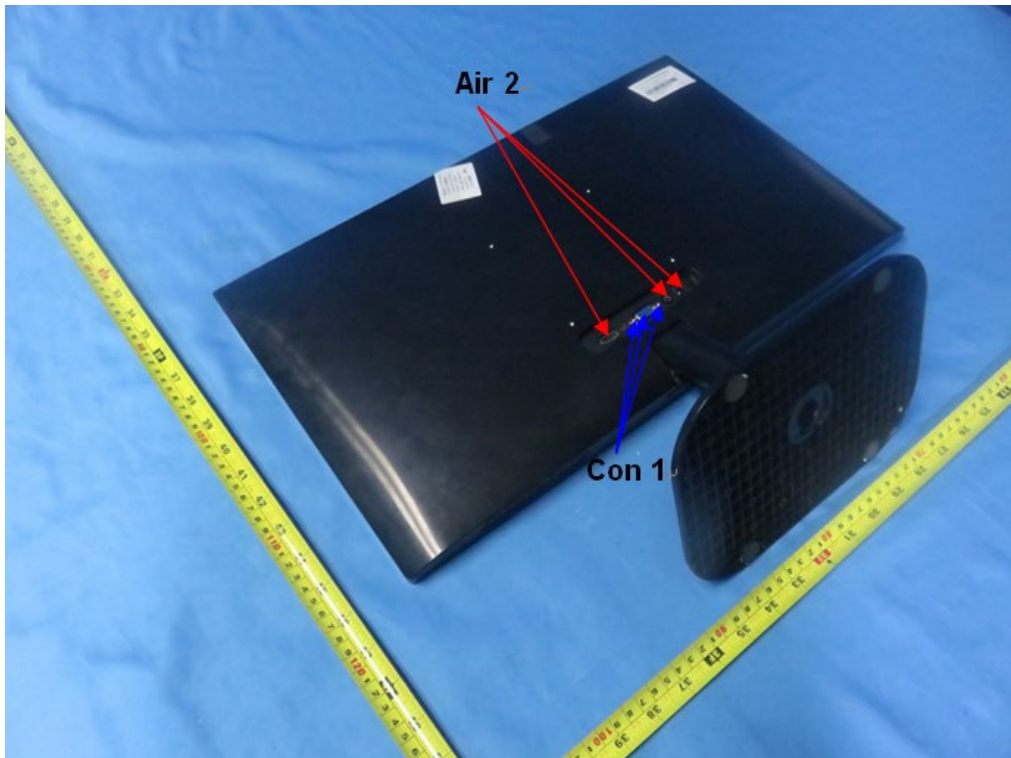
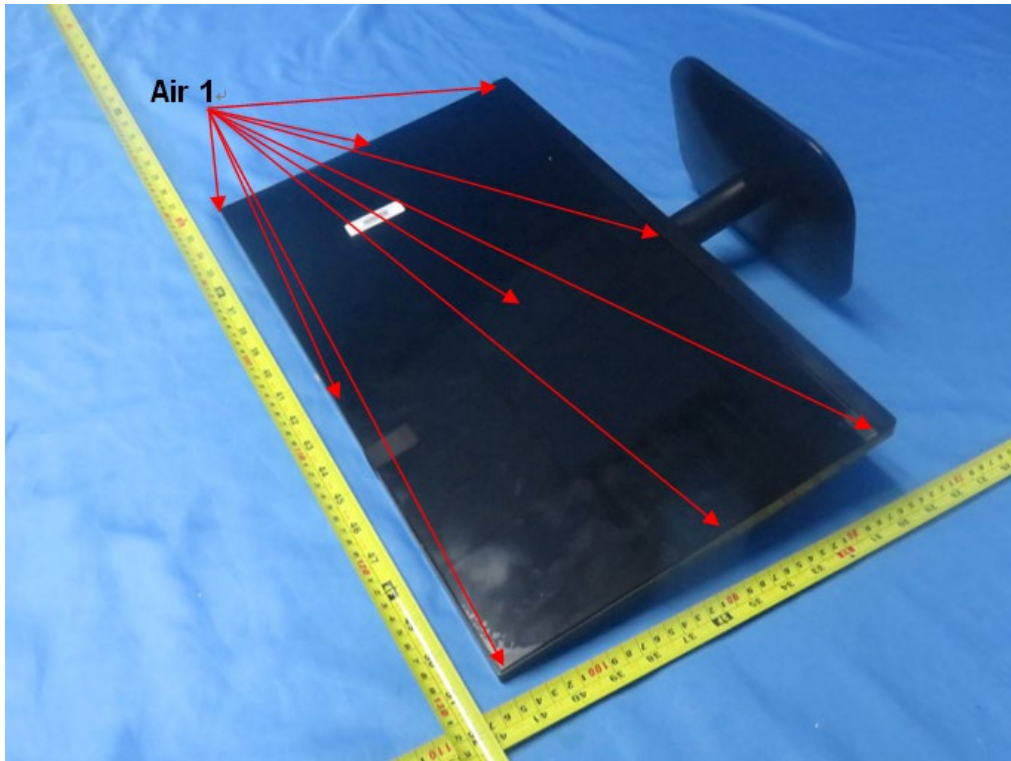

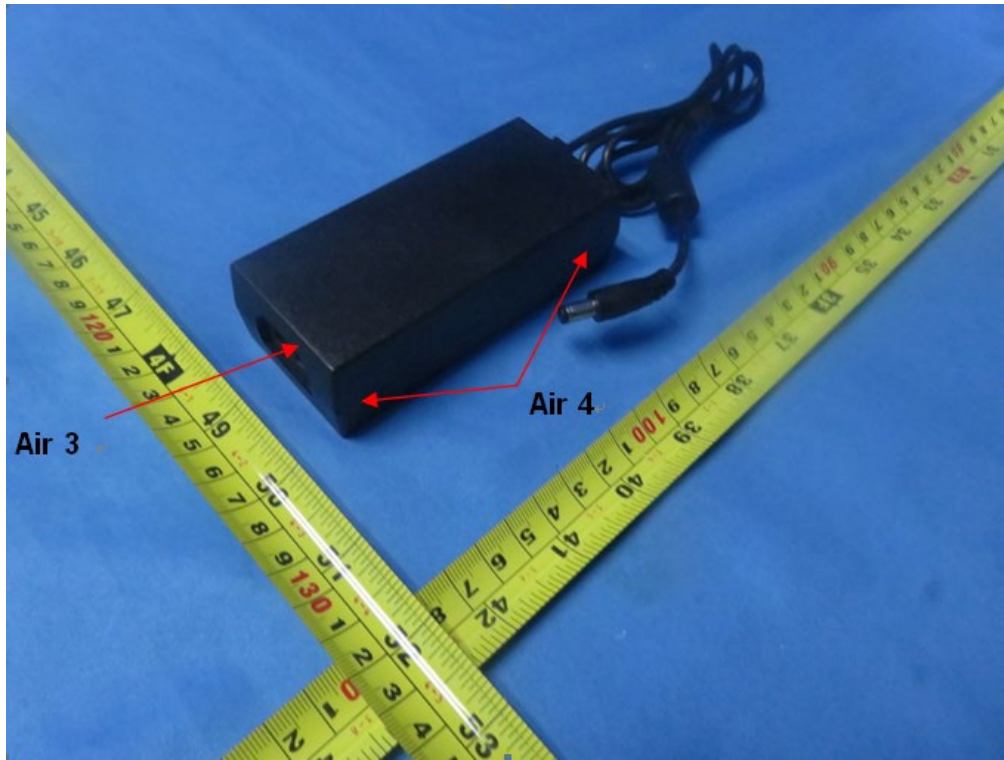

7.4 RADIATED, RADIO-FREQUENCY, ELECTROMAGNETIC FIELD IMMUNITY TEST (RS)

7.4.1 TEST SPECIFICATION

Basic Standard	EN 61000-4-3
Required Performance	A
Frequency Range	80 MHz - 1000 MHz
Field Strength	3 V/m(unmodulated, r.m.s)
Modulation	1 kHz Sine Wave, 80%, AM Modulation
Frequency Step	1% of fundamental
Polarity of Antenna	Horizontal and Vertical
Test Distance	3 m
Antenna Height	1.55 m
Dwell Time	at least 3 seconds

7.4.2 MEASUREMENT INSTRUMENTS

Item	Kind of Equipment	Manufacturer	Type No.	Serial No.	Calibrated until
1	MXG Analog Signal Generator	Agilent	N5181A	MY49060710	Aug. 11, 2019
2	Power amplifier	MILMEGA	80RF1000-250	1064833	Aug. 20, 2020
3	Antenna	ETS	3142C	47662	Mar. 23, 2020
4	Measurement Software	TOYO	IM5/RS Ver 3.8.050	N/A	N/A

Remark: "N/A" denotes no model no., no serial No. or no calibration specified.
All calibration period of equipment list is one year.

7.4.3 TEST PROCEDURE

The EUT and support equipment, which are placed on a table that is 0.8 meter above ground and the testing was performed in a fully-anechoic chamber.

The testing distance from antenna to the EUT was 3 meters.

The other condition as following manner:

- a. The field strength level was 3 V/m(unmodulated, r.m.s).
- b. The frequency range is swept from 80 MHz to 1000 MHz, with the signal 80%amplitude modulated with a 1 kHz sine wave. The rate of sweep did not exceed 1.5×10^{-3} decade/s. Where the frequency range is swept incrementally, the step size was 1% of fundamental.
- c. The dwell time at each frequency shall be not less than the time necessary for the EUT to be able to respond.
- d. The test was performed with the EUT exposed to both vertically and horizontally polarized fields on each of the four sides.

7.4.4 DEVIATION FROM TEST STANDARD

No deviation

7.4.5 TEST SETUP

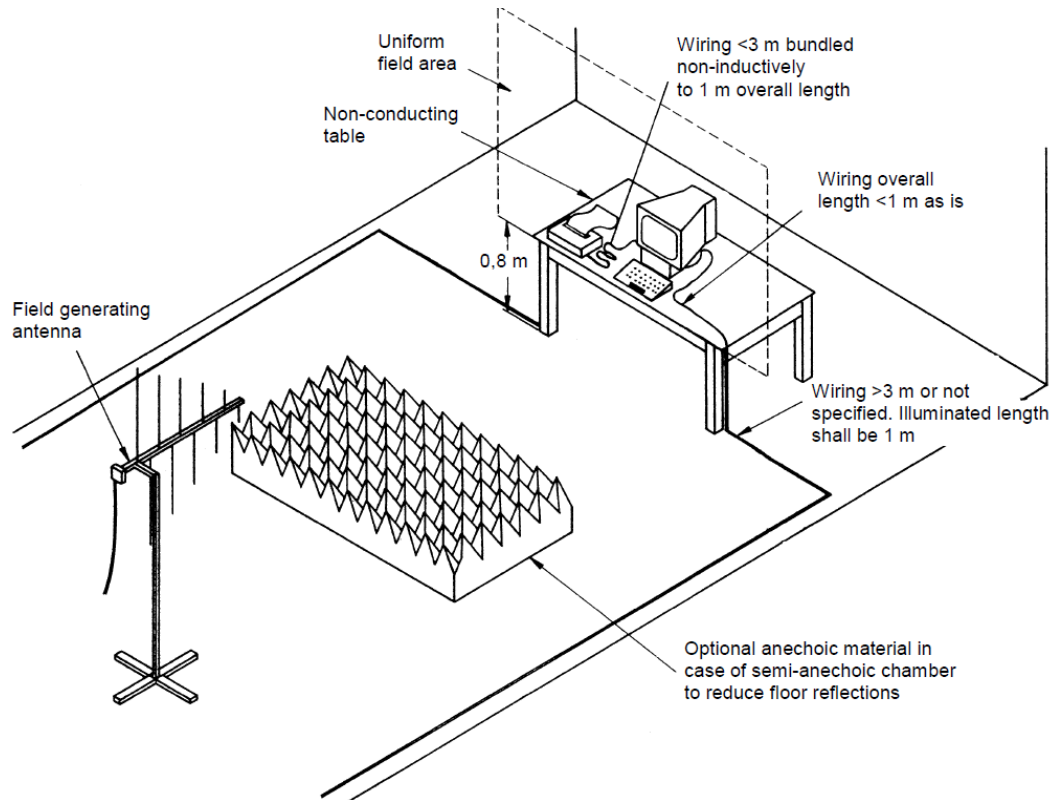

Note:

TABLE-TOP EQUIPMENT

The EUT installed in a representative system as described in EN 61000-4-3 was placed on a non-conductive table 0.8 meters in height. The system under test was connected to the power and signal wire according to relevant installation instructions.

FLOOR-STANDING EQUIPMENT

The EUT installed in a representative system as described in EN 61000-4-3 was placed on a non-conductive wood support 0.1 meters in height. The system under test was connected to the power and signal wire according to relevant installation instructions.

7.4.6 TEST RESULTS

EUT	LCD Monitor	Test Model	22B2
Temperature	25°C	Relative Humidity	50%
Test Voltage	AC 230V/50Hz		
Test Mode	HDMI 1920*1080/60Hz		

Frequency Range (MHz)	RF Field Position	R.F. Field Strength	Azimuth	Criterion	Result	Judgment
80 - 1000	H / V	3V/m (unmodulated, r.m.s) AM Modulated 1000Hz, 80%	0	A	A	PASS
			90			
			180			
			270			

Note:

- 1) P/N denotes the Positive/Negative polarity of the output voltage.
- 2) N/A - denotes test is not applicable in this test report.
- 3) Criterion A: No observation of any performance degradation.
- 4) Criterion B: Some degradation of performance is observed but the equipment continues to operate as intended.
- 5) Criterion C: Loss of functionality, but self-recoverable by user, without loss of information or settings.

7.5 ELECTRICAL FAST TRANSIENT/BURST IMMUNITY TEST (EFT/BURST)

7.5.1 TEST SPECIFICATION

Basic Standard	EN 61000-4-4
Required Performance	B
Test Voltage	Power Line: ± 1 kV
Polarity	Positive & Negative
Impulse Frequency	5 kHz: except for xDSL port 100 kHz: only for single lines of xDSL port.
Impulse Wave shape	5/50 ns
Burst Duration	15 ms
Burst Period	300 ms
Test Duration	Not less than 1 min.

7.5.2 MEASUREMENT INSTRUMENTS

Item	Kind of Equipment	Manufacturer	Type No.	Serial No.	Calibrated until
1	THE MODULAR SOLUTION FOR 6 KV APPLICATIONS	Teseq	NSG 3060	1423	Aug. 11, 2019

Remark: "N/A" denotes no model no., no serial No. or no calibration specified.

All calibration period of equipment list is one year.

7.5.3 TEST PROCEDURE

The EUT and support equipment, are placed on a table that is 0.8 meter above a metal ground plane measured 1m*1m min. and 0.65mm thick min.

The other condition as following manner:

- a. Both positive and negative polarity discharges were applied.
- b. The duration time of each test sequential was 1 minute

7.5.4 DEVIATION FROM TEST STANDARD

No deviation

7.5.5 TEST SETUP

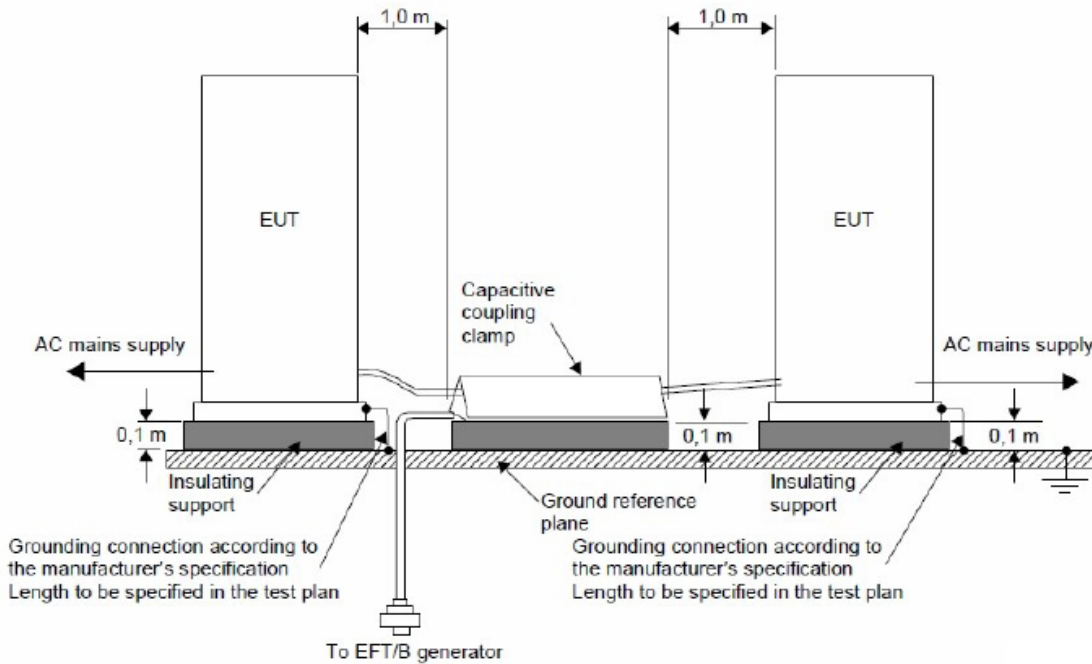
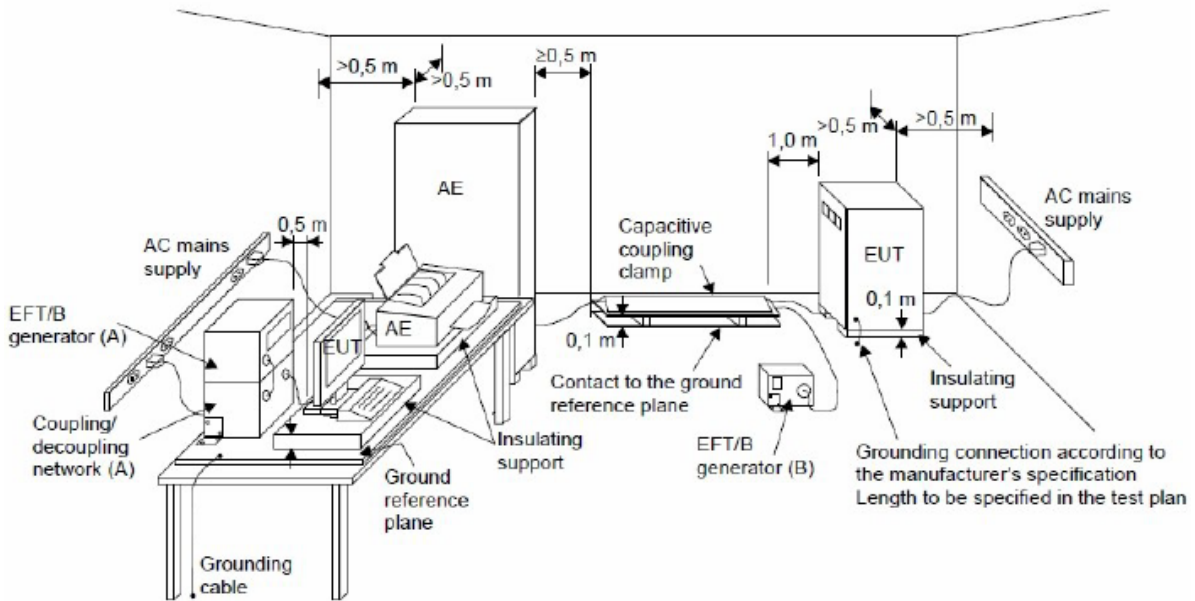

Note:

TABLE-TOP EQUIPMENT

The configuration consisted of a wooden table (0.8m high) standing on the Ground Reference Plane and should be located 0.1 m+/- 0.01m above the Ground Reference Plane. The GRP consisted of a sheet of aluminum (at least 0.25mm thick and 2.5m square) connected to the protective grounding system. A minimum distance of 0.5m was provided between the EUT and the walls of the laboratory or any other metallic structure.

FLOOR-STANDING EQUIPMENT

The EUT installed in a representative system as described in EN 61000-4-4 and its cables were isolated from the Ground Reference Plane by an insulating support that is 0.1-meter thick. The GRP consisted of a sheet of aluminum (at least 0.25mm thick and 2.5m square) connected to the protective grounding system.

7.5.6 TEST RESULTS

EUT	LCD Monitor	Test Model	22B2
Temperature	25°C	Relative Humidity	50%
Test Voltage	AC 230V/50Hz		
Test Mode	HDMI 1920*1080/60Hz		

EUT Ports Tested		Polarity	Repetition Frequency	Test Level	Criterion	Result	Judgment
				1kV			
AC Power Port	Line (L)	+	5 kHz	A	B	A	PASS
		-	5 kHz	A			
	Neutral (N)	+	5 kHz	A	B	A	PASS
		-	5 kHz	A			
	L+N	+	5 kHz	A	B	A	PASS
		-	5 kHz	A			

Note:

- 1) P/N denotes the Positive/Negative polarity of the output voltage.
- 2) N/A - denotes test is not applicable in this test report
- 3) Criterion A: No observation of any performance degradation.
- 4) Criterion B: Some degradation of performance is observed but the equipment continues to operate as intended.
- 5) Criterion C: Loss of functionality, but self-recoverable by user, without loss of information or settings.

7.6 SURGE IMMUNITY TEST

7.6.1 TEST SPECIFICATION

Basic Standard	EN 61000-4-5
Required Performance	B
Wave-Shape	Combination Wave for power lines 1.2/50 us Open Circuit Voltage 8 /20 us Short Circuit Current
Test Voltage	Power Line: ± 0.5 kV, ± 1 kV
Surge Input/Output	L-N
Generator Source Impedance	2 Ω of the low-voltage power supply network.
Polarity	Positive/Negative
Phase Angle:	AC Port: 0°/90°/180°/270°
Pulse Repetition Rate	1 time / min. (maximum)
Number of Tests	5 positive and 5 negative at selected points

7.6.2 MEASUREMENT INSTRUMENTS

Item	Kind of Equipment	Manufacturer	Type No.	Serial No.	Calibrated until
1	THE MODULAR SOLUTION FOR 6 KV APPLICATIONS	Teseq	NSG 3060	1423	Aug. 11, 2019

Remark: "N/A" denotes no model no., no serial No. or no calibration specified.
All calibration period of equipment list is one year.

7.6.3 TEST PROCEDURE

a. For EUT power supply:

The surge is to be applied to the EUT power supply terminals via the capacitive coupling network. Decoupling networks are required in order to avoid possible adverse effects on equipment not under test that may be powered by the same lines, and to provide sufficient decoupling impedance to the surge wave. The power cord between the EUT and the coupling/decoupling networks shall be 2meters in length (or shorter).

b. For test applied to unshielded unsymmetrically operated interconnection lines of EUT :

The surge is applied to the lines via the capacitive coupling. The coupling /decoupling networks shall not influence the specified functional conditions of the EUT. The interconnection line between the EUT and the coupling/decoupling networks shall be 2 meters in length (or shorter).

c. For test applied to unshielded symmetrically operated interconnection /telecommunication lines of EUT :

The surge is applied to the lines via gas arrestors coupling. Test levels below the ignition point of the coupling arrestor cannot be specified. The interconnection line between the EUT and the coupling/decoupling networks shall be 2 meters in length (or shorter).

7.6.4 DEVIATION FROM TEST STANDARD

No deviation

7.6.5 TEST SETUP

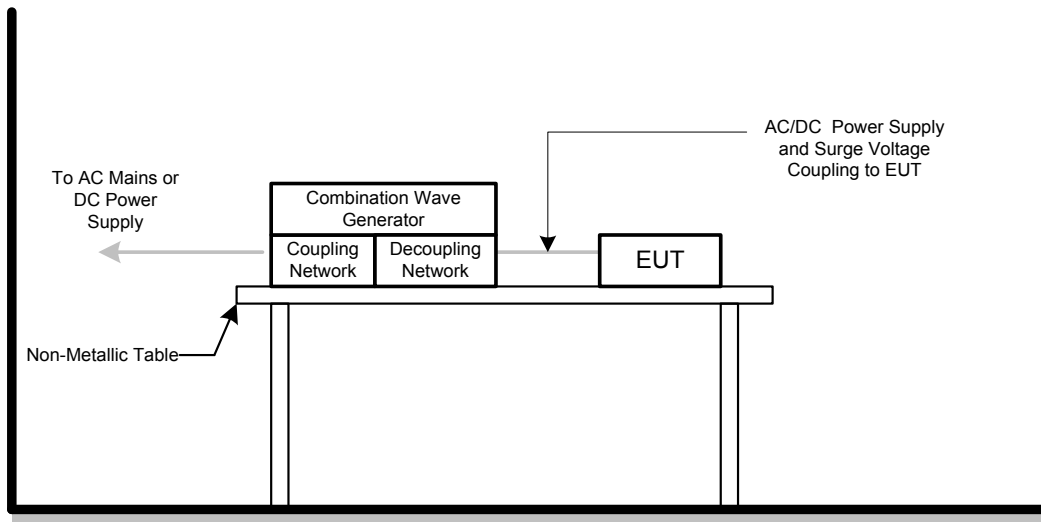

7.6.6 TEST RESULTS

EUT	LCD Monitor	Test Model	22B2
Temperature	25°C	Relative Humidity	50%
Test Voltage	AC 230V/50Hz		
Test Mode	HDMI 1920*1080/60Hz		

Wave Form	EUT Ports Tested	1.2/50(8/20)Tr/Th μ s						Criterion	Result	Judgment
		Polarity	Phase	Voltage						
				0.5kV	1kV	-- kV	-- kV			
AC	L – N	+/-	0°	A	A	-	-	B	A	PASS
		+/-	90°	A	A	-	-			
		+/-	180°	A	A	-	-			
		+/-	270°	A	A	-	-			

Note:

- 1) Polarity and Numbers of Impulses: 5 Pst / Ngst at each tested mode
- 2) N/A - denotes test is not applicable in this Test Report
- 3) Criterion A: No observation of any performance degradation.
- 4) Criterion B: Some degradation of performance is observed but the equipment continues to operate as intended.
- 5) Criterion C: Loss of functionality, but self-recoverable by user, without loss of information or settings.

7.7 IMMUNITY TO CONDUCTED DISTURBANCES, INDUCED BY RADIO-FREQUENCY FIELDS TEST (CS)

7.7.1 TEST SPECIFICATION

Basic Standard	EN 61000-4-6
Required Performance	A
Frequency Range	0.15 MHz - 80 MHz
Field Strength	3 V (unmodulated, r.m.s.)
Modulation	1 kHz Sine Wave, 80%, AM Modulation
Frequency Step	1% of fundamental
Dwell Time	at least 3 seconds

7.7.2 MEASUREMENT INSTRUMENTS

Item	Kind of Equipment	Manufacturer	Type No.	Serial No.	Calibrated until
1	Power CDN	FCC	FCC-801-M 2/M3-16A	100270	Mar. 10, 2020
2	TEST SYSTEM FOR CONDUCTED AND RADIATED IMMUNITY	TESEQ	NSG 4070B	37513	Aug. 11, 2019
3	Measurement Software	Farad	EZ-CS(V2. 0.1.2)	N/A	N/A

Remark: "N/A" denotes no model no., no serial No. or no calibration specified.
All calibration period of equipment list is one year.

7.7.3 TEST PROCEDURE

The EUT and support equipment, are placed on a table that is 0.8 meter above a metal ground plane measured 1m*1m min. and 0.65mm thick min.

The other condition as following manner:

- a. The field strength level was 3 V (unmodulated, r.m.s.)
- b. The frequency range is swept from 150 kHz to 80 MHz, with the signal 80%amplitude modulated with a 1 kHz sine wave. The rate of sweep did not exceed 1.5×10^{-3} decade/s. Where the frequency range is swept incrementally, the step size was 1% of fundamental.
- c. The dwell time at each frequency shall be not less than the time necessary for the EUT to be able to respond.

7.7.4 DEVIATION FROM TEST STANDARD

No deviation

7.7.5 TEST SETUP

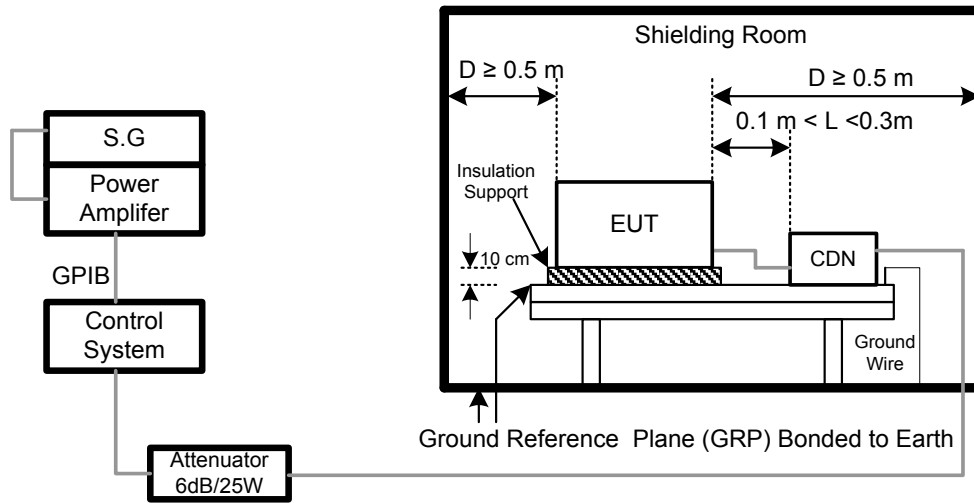

NOTE:

FLOOR-STANDING EQUIPMENT

The equipment to be tested is placed on an insulating support of 0.1 meters height above a ground reference plane. All relevant cables shall be provided with the appropriate coupling and decoupling devices at a distance between 0.1 meters and 0.3 meters from the projected geometry of the EUT on the ground reference plane.

7.7.6 TEST RESULTS

EUT	LCD Monitor	Test Model	22B2
Temperature	25°C	Relative Humidity	49%
Test Voltage	AC 230V/50Hz		
Test Mode	HDMI 1920*1080/60Hz		

Test Ports (Mode)	Freq.Range (MHz)	Field Strength	Criteria	Results	Judgment
Input/ Output AC.PowerPort	0.15 ---80	3V(unmodulated, r.m.s) AM Modulated 1000Hz, 80%	A	A	PASS

Note:

- 1). N/A - denotes test is not applicable in this test report.
- 2) Criterion A: No observation of any performance degradation.
- 3) Criterion B: Some degradation of performance is observed but the equipment continues to operate as intended.
- 4) Criterion C: Loss of functionality, but self-recoverable by user, without loss of information or settings.

7.8 POWER FREQUENCY MAGNETIC FIELD IMMUNITY TEST (PFMF)

7.8.1 TEST SPECIFICATION

Basic Standard	EN 61000-4-8
Required Performance	A
Frequency Range	50/60 Hz
Field Strength	1 A/m
Observation Time	1 minute
Inductance Coil	Rectangular type, 1mx1m

7.8.2 MEASUREMENT INSTRUMENTS

Item	Kind of Equipment	Manufacturer	Type No.	Serial No.	Calibrated until
1	Magnetic Field test Generator	FCC	F-1000-4-8-G-125A	04032	Mar. 10, 2020
2	Magnetic Field immunity loop	Thermo KeyTek	F-1000-4-8/9/10-L-1M	04024	Mar. 10, 2020

Remark: "N/A" denotes no model no., no serial No. or no calibration specified.
All calibration period of equipment list is one year.

7.8.3 TEST PROCEDURE

The EUT and support equipment, are placed on a table that is 0.8 meter above a metal ground plane measured 1m*1m min. and 0.65mm thick min.

The other condition as following manner:

- a. The equipment cabinets shall be connected to the safety earth directly on the GRP via the earth terminal of the EUT.
- b. The cables supplied or recommended by the equipment manufacturer shall be used. 1 meter of all cables used shall be exposed to the magnetic field.

7.8.4 DEVIATION FROM TEST STANDARD

No deviation

7.8.5 TEST SETUP

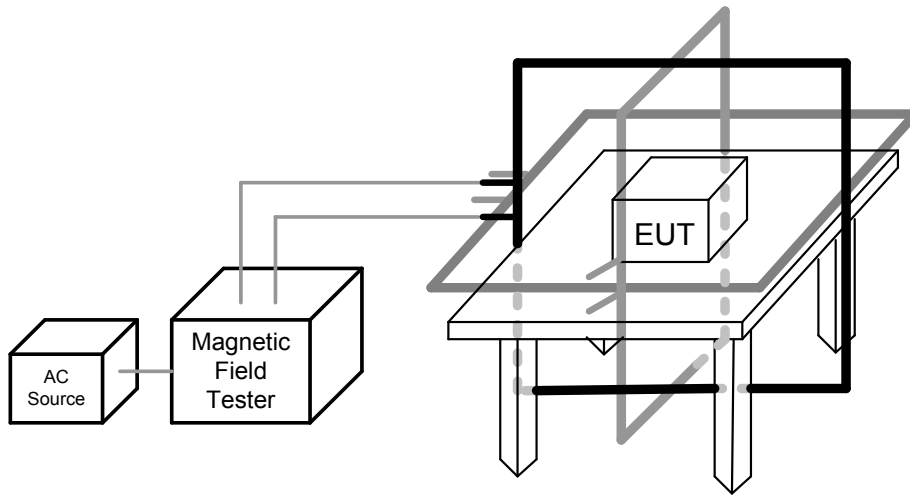

Note:

TABLE-TOP EQUIPMENT

The equipment shall be subjected to the test magnetic field by using the induction coil of standard dimension (1 m x 1 m). The induction coil shall then be rotated by 90 degrees in order to expose the EUT to the test field with different orientations.

FLOOR-STANDING EQUIPMENT

The equipment shall be subjected to the test magnetic field by using induction coils of suitable dimensions. The test shall be repeated by moving and shifting the induction coils, in order to test the whole volume of the EUT for each orthogonal direction. The test shall be repeated with the coil shifted to different positions along the side of the EUT, in steps corresponding to 50 percent of the shortest side of the coil. The induction coil shall then be rotated by 90 degrees in order to expose the EUT to the test field with different orientations.

7.8.6 TEST RESULTS

EUT	LCD Monitor	Test Model	22B2
Temperature	25°C	Relative Humidity	50%
Test Voltage	AC 230V/50Hz		
Test Mode	HDMI 1920*1080/60Hz		

50Hz

Test Mode	Test Level	Antenna aspect	Duration (s)	Criteria	Results	Judgment
Enclosure	1 A/m	X	60	A	A	PASS
Enclosure	1 A/m	Y	60	A	A	PASS
Enclosure	1 A/m	Z	60	A	A	PASS

60Hz

Test Mode	Test Level	Antenna aspect	Duration (s)	Criteria	Results	Judgment
Enclosure	1 A/m	X	60	A	A	PASS
Enclosure	1 A/m	Y	60	A	A	PASS
Enclosure	1 A/m	Z	60	A	A	PASS

Note:

- 1). N/A - denotes test is not applicable in this test report.
- 2) Criterion A: No observation of any performance degradation.
- 3) Criterion B: Some degradation of performance is observed but the equipment continues to operate as intended.
- 4) Criterion C: Loss of functionality, but self-recoverable by user, without loss of information or settings.

7.9 VOLTAGE DIPS, SHORT INTERRUPTIONS AND VOLTAGE VARIATIONS IMMUNITY TEST

7.9.1 TEST SPECIFICATION

Basic Standard	EN 61000-4-11
Required Performance	B (For >95% Voltage Dips) C (For 30% Voltage Dips) C (For >95% Voltage Interruptions)
Test Duration Time	Minimum three test events in sequence
Interval between Event	Minimum ten seconds
Phase Angle	0°/180°
Test Cycle	3 times

7.9.2 MEASUREMENT INSTRUMENTS

Item	Kind of Equipment	Manufacturer	Type No.	Serial No.	Calibrated until
1	THE MODULAR SOLUTION FOR 6 KV APPLICATIONS	Teseq	NSG 3060	1423	Aug. 11, 2019

Remark: "N/A" denotes no model no., no serial No. or no calibration specified.
All calibration period of equipment list is one year.

7.9.3 TEST PROCEDURE

The EUT shall be tested for each selected combination of test levels and duration with a sequence of three dips/interruptions with intervals of 10 s minimum (between each test event). Each representative mode of operation shall be tested. Abrupt changes in supply voltage shall occur at zero crossings of the voltage waveform.

7.9.4 DEVIATION FROM TEST STANDARD

No deviation

7.9.5 TEST SETUP

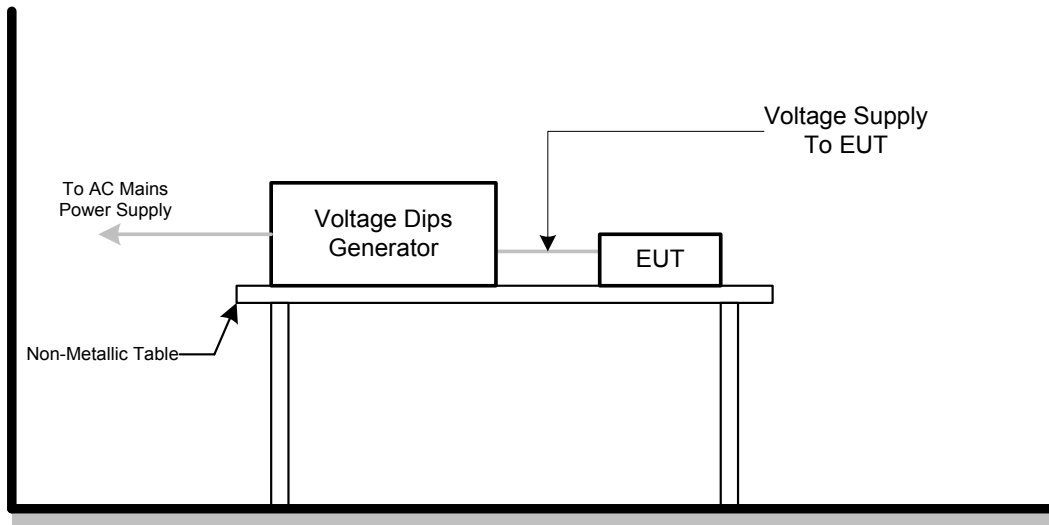

7.9.6 TEST RESULTS

EUT	LCD Monitor	Test Model	22B2
Temperature	25°C	Relative Humidity	50%
Test Voltage	AC 100V/50Hz, AC 230V/50Hz, AC 240V/50Hz		
Test Mode	HDMI 1920*1080/60Hz		

AC 100V/50Hz				
Voltage Reduction	Periods	Criteria	Results	Judgment
Voltage dip >95%	0.5	B	A	PASS
Voltage dip 30%	25	C	A	PASS
Interruption >95%	250	C	C	PASS

AC 230V/50Hz				
Voltage Reduction	Periods	Criteria	Results	Judgment
Voltage dip >95%	0.5	B	A	PASS
Voltage dip 30%	25	C	A	PASS
Interruption >95%	250	C	C	PASS

AC 240V/50Hz				
Voltage Reduction	Periods	Criteria	Results	Judgment
Voltage dip >95%	0.5	B	A	PASS
Voltage dip 30%	25	C	A	PASS
Interruption >95%	250	C	C	PASS

Note:

- 1). N/A - denotes test is not applicable in this test report.
- 2) Criterion A: No observation of any performance degradation.
- 3) Criterion B: Some degradation of performance is observed but the equipment continues to operate as intended.
- 4) Criterion C: Loss of functionality, but self-recoverable by user, without loss of information or settings.

8. EUT TEST PHOTO

EN 55032:2012+AC:2013 &2015

Radiated emissions up to 1 GHz

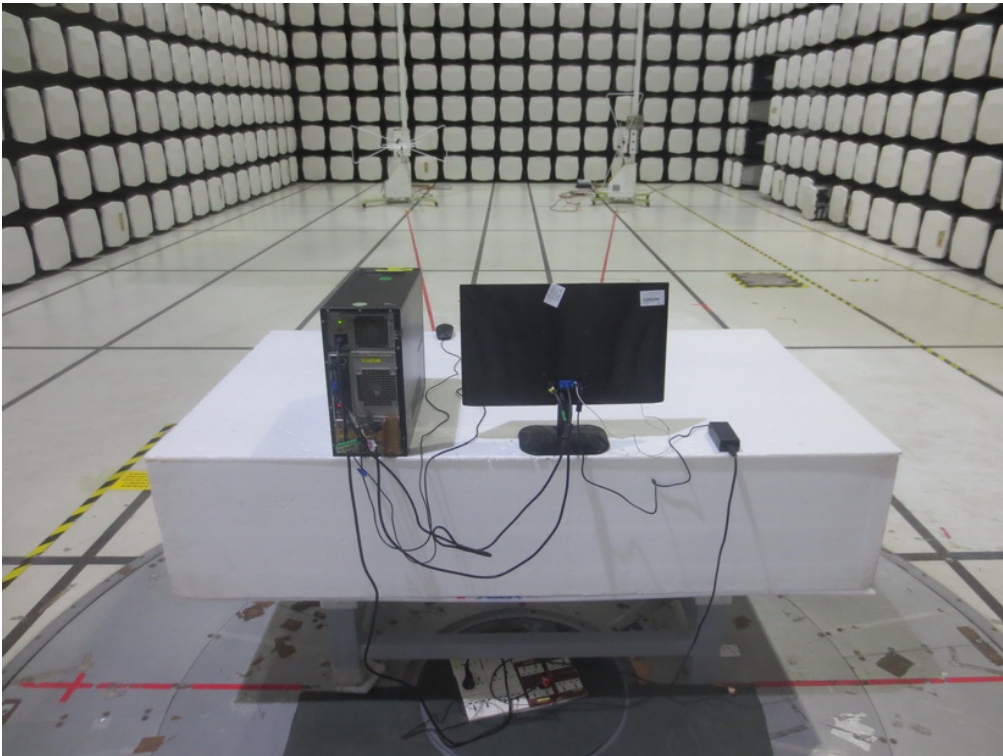
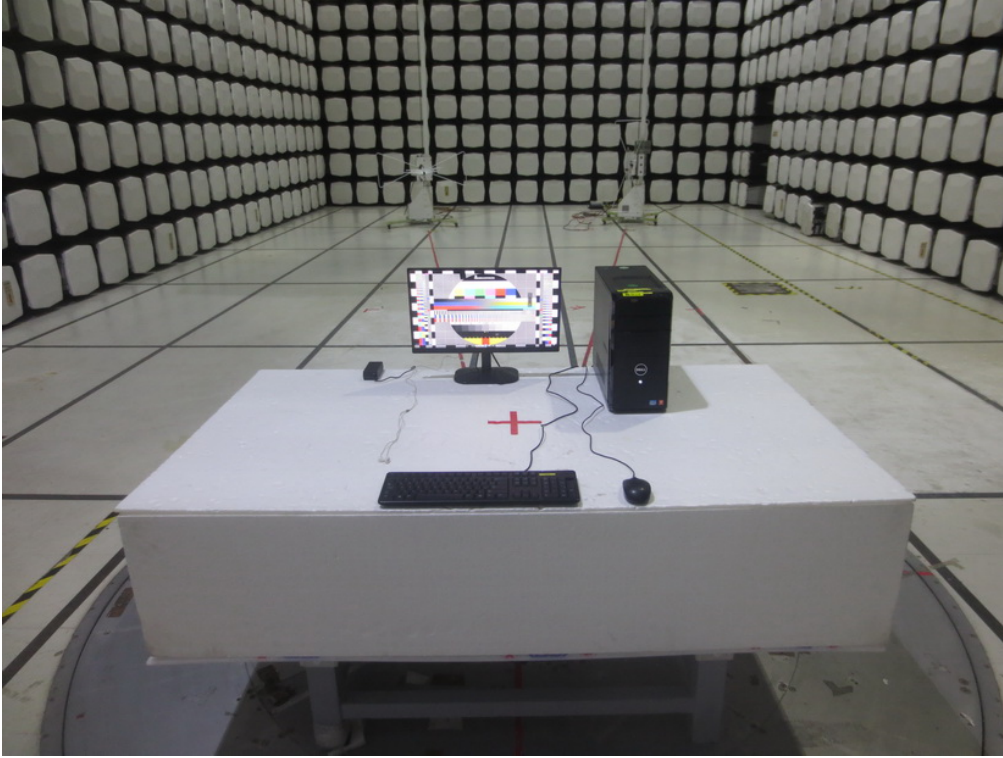

Radiated emissions above 1 GHz

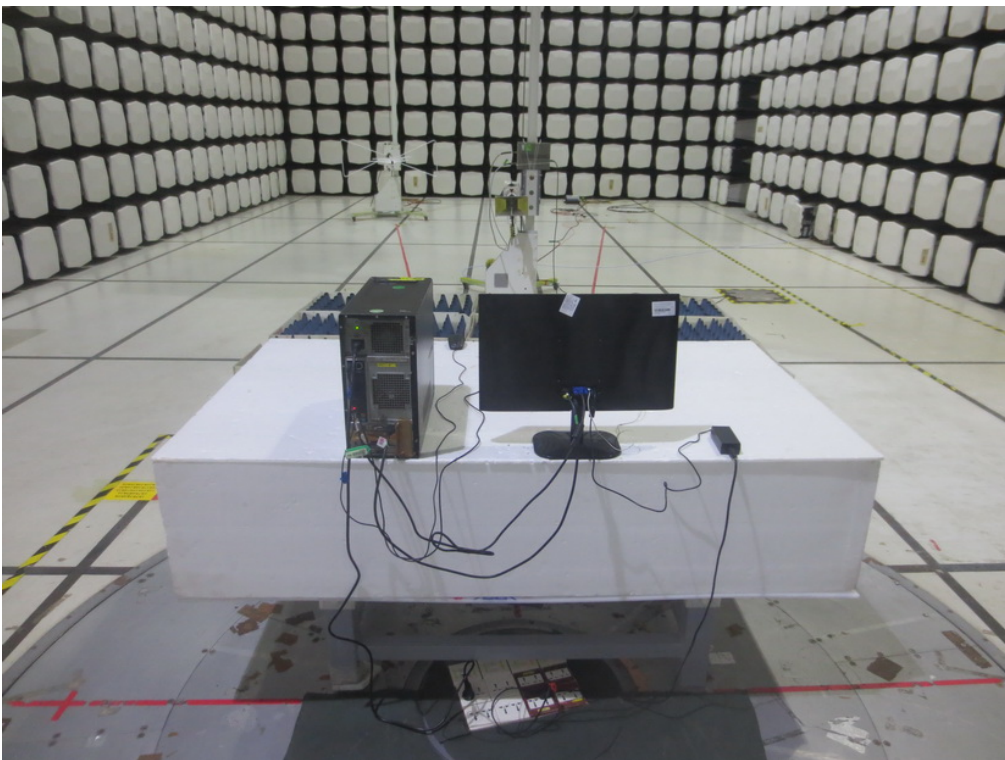

Conducted emissions AC mains power port

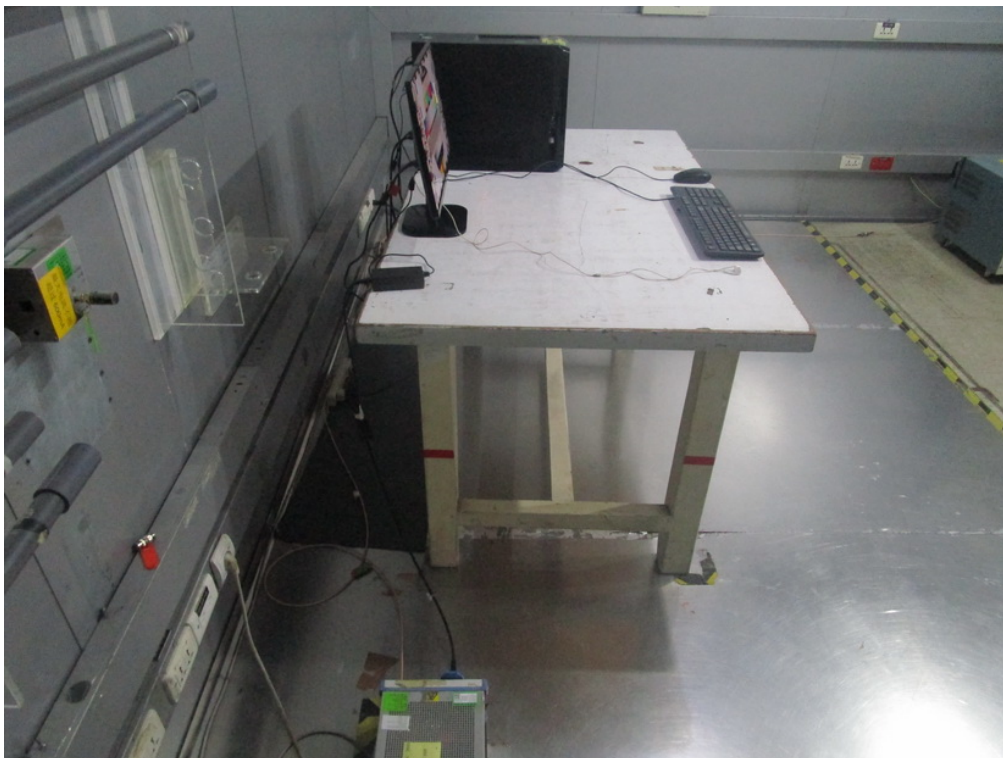

EN 55032:2015+AC:2016
Radiated emissions up to 1 GHz

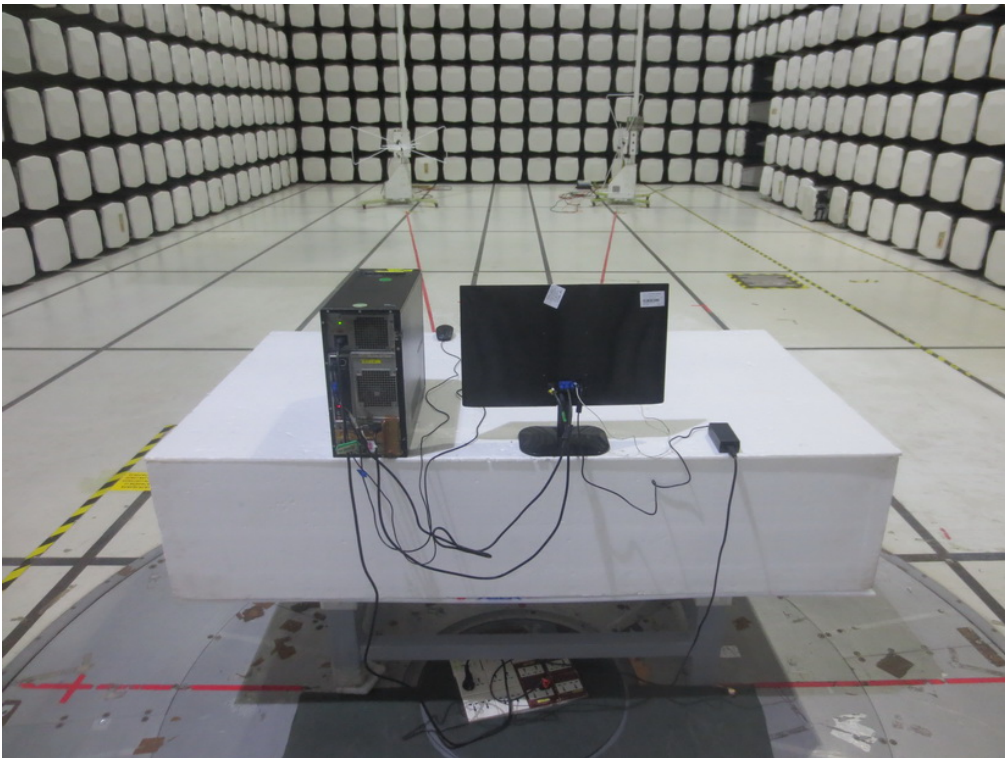
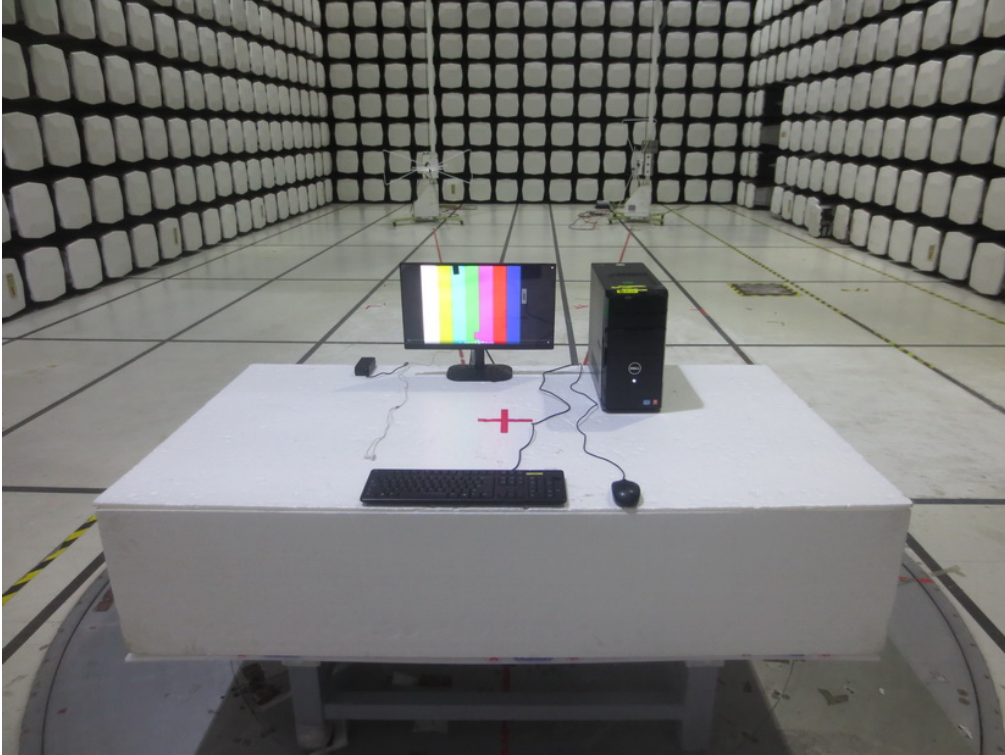

Radiated emissions above 1 GHz

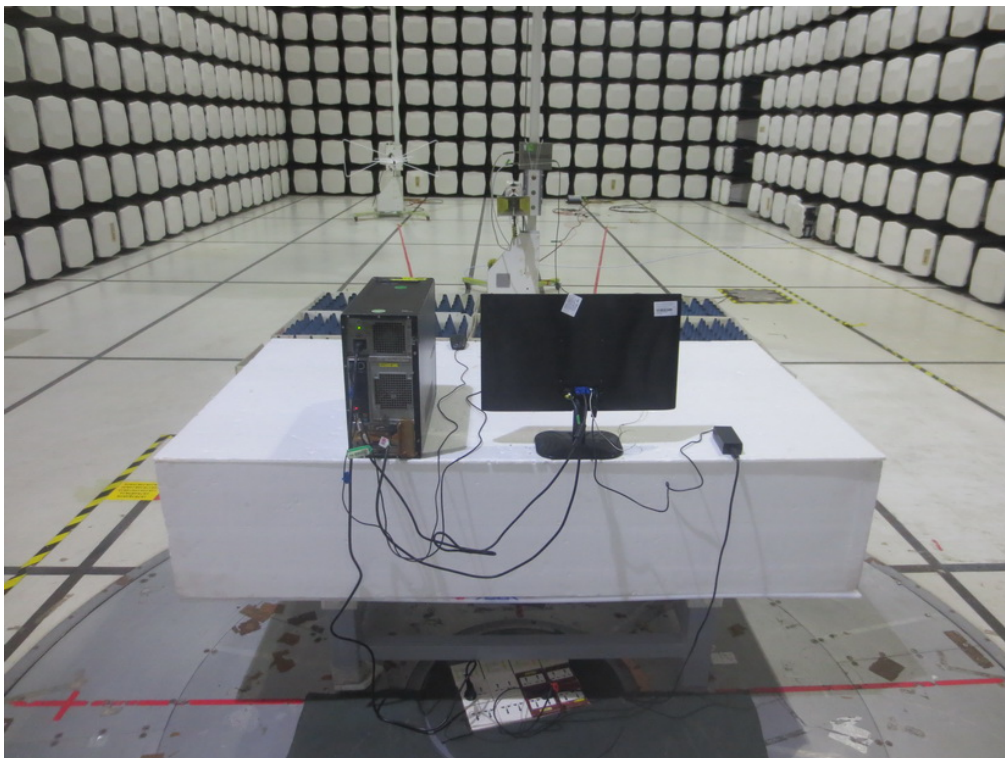
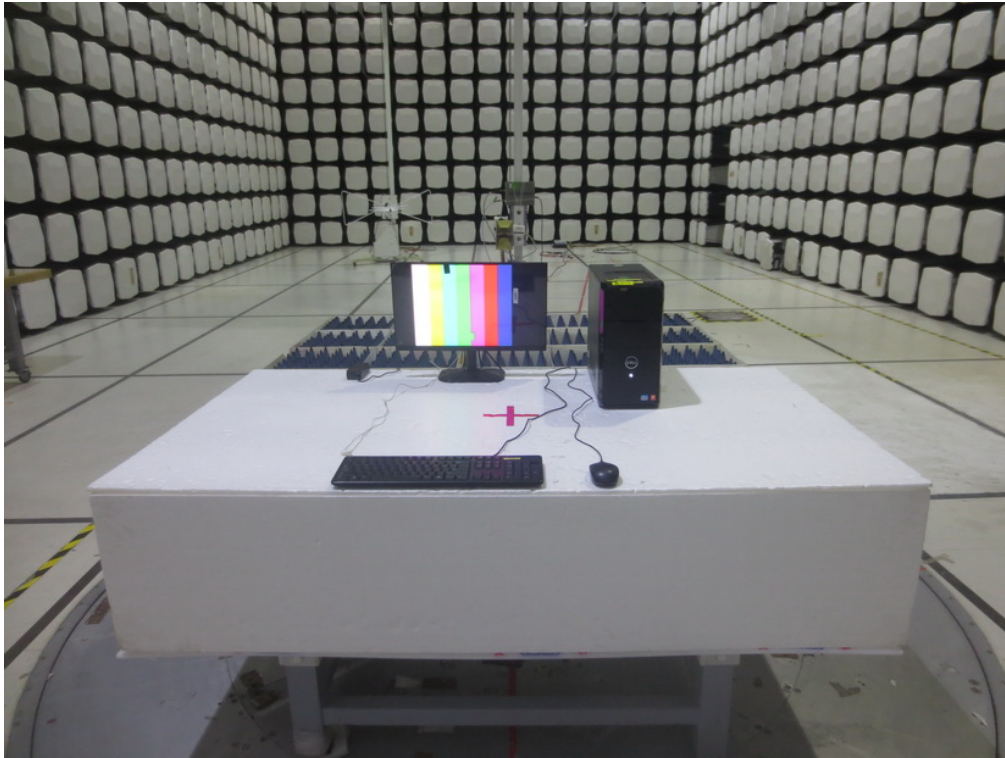

Conducted emissions AC mains power port

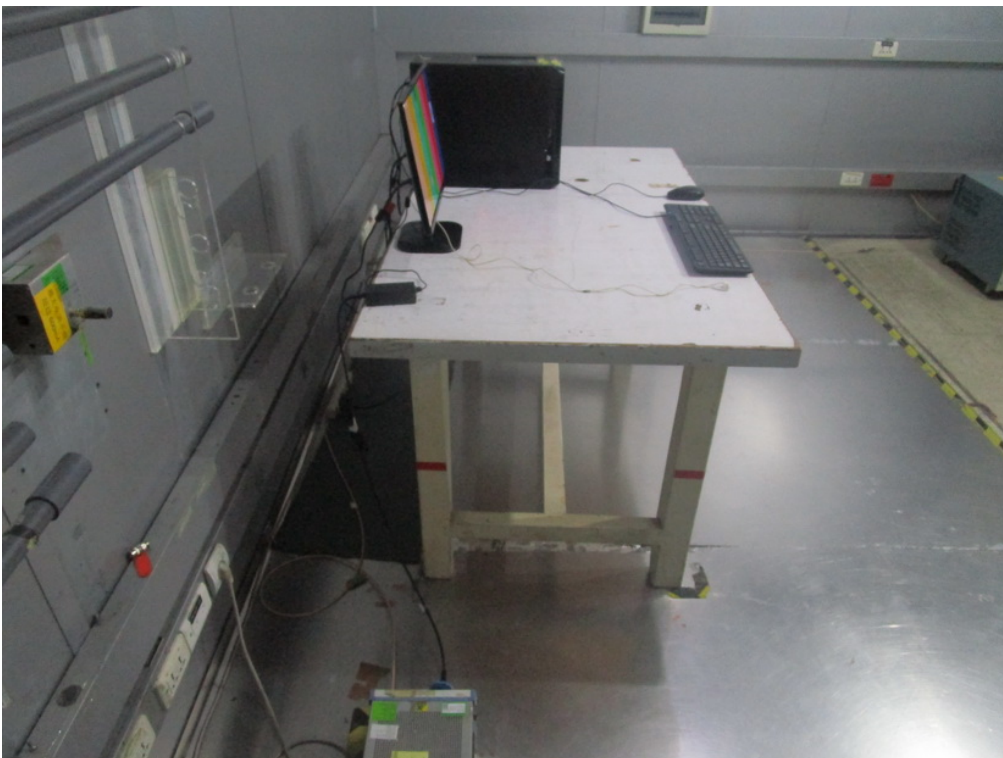

Harmonic current emissions



Voltage changes, voltage fluctuations and flicker

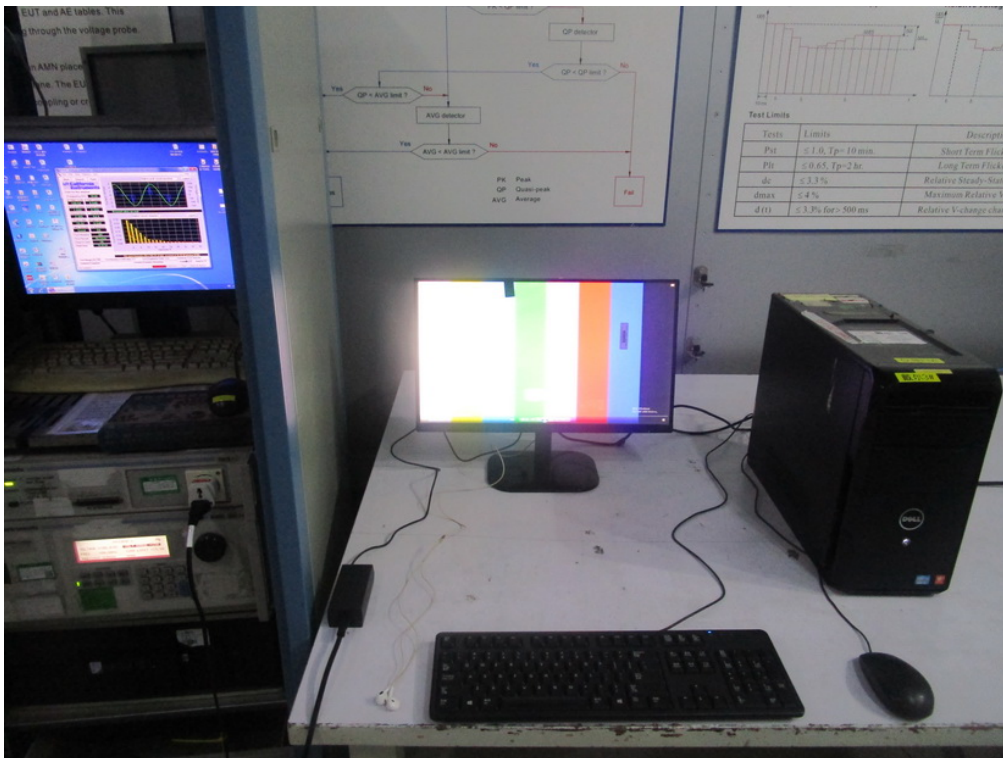

Electrostatic discharge immunity

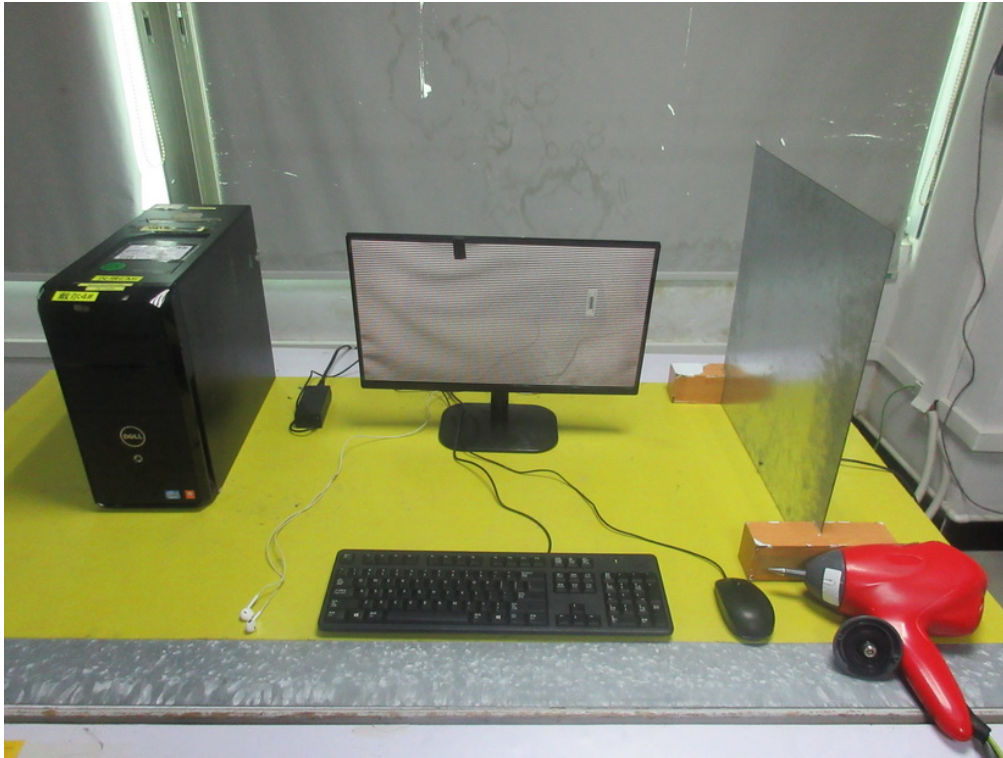

Radiated, radio-frequency, electromagnetic field immunity

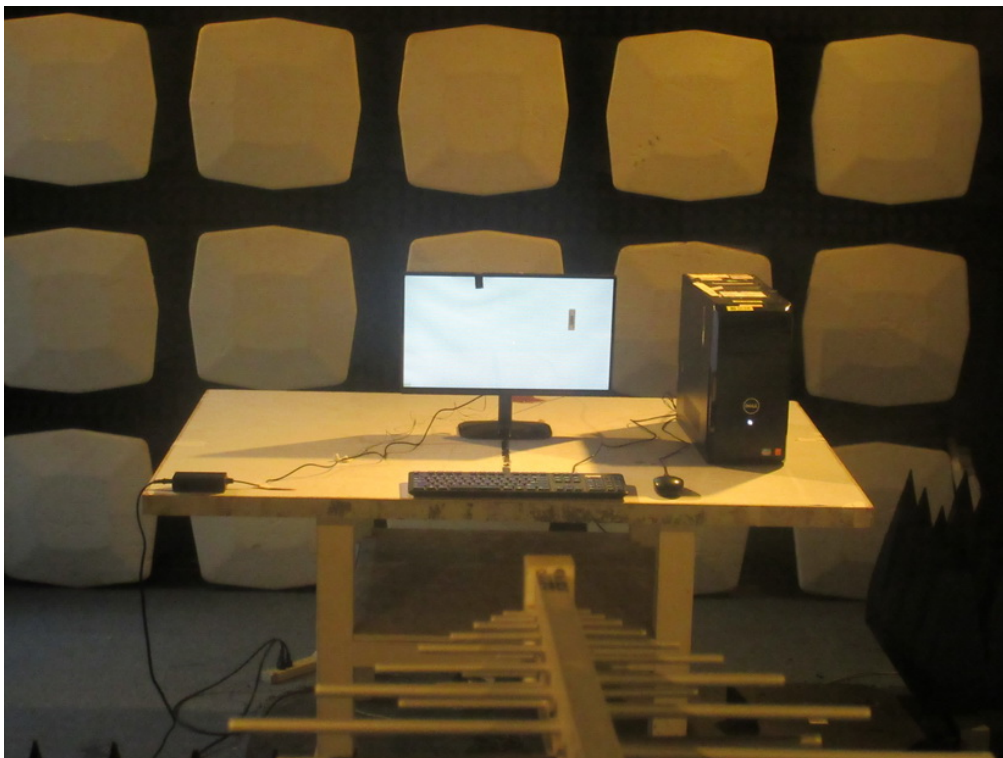

Electrical fast transient/burst immunity



Surge immunity



Immunity to conducted disturbances, induced by radio-frequency fields



Power frequency magnetic field immunity



Voltage dips, short interruptions and voltage variations immunity



End of Test Report