

CE EMC Test Report

Project No. : 2006C201
Equipment : LCD Monitor
Brand Name : N/A
Test Model : **2490***** (*=0-9,A-Z,a-z,+,-,/,\ or blank)
Series Model : N/A
Applicant : TPV Electronics (Fujian) Co., Ltd.
Address : Rongqiao Economic and Technological Development Zone, Fuqing City,
Fujian Province, P.R. China
Date of Receipt : Jun. 29, 2020
Date of Test : Jul. 01, 2020 ~ Jul. 22, 2020
Issued Date : Aug. 13, 2020
Report Version : R00
Test Sample : Engineering Sample No.: DG2020063045
Standard(s) : EN 55032:2012+AC:2013
EN 55032:2015
EN 55032:2015+AC:2016
EN 55035:2017
IEC 61000-3-2:2014 / EN 61000-3-2:2014
IEC 61000-3-3:2013+A1:2017 / EN 61000-3-3:2013+A1:2019

The above equipment has been tested and found compliance with the requirement of the relative standards by BTL Inc.

Derek Tong

Prepared by : Derek Tong

Kevin Li

Approved by : Kevin Li



Certificate #5123.02

Add: No.3, Jinshagang 1st Road, Shixia, Dalang Town, Dongguan, Guangdong, China.

Tel: +86-769-8318-3000

Web: www.newbtl.com

Declaration

BTL represents to the client that testing is done in accordance with standard procedures as applicable and that test instruments used has been calibrated with standards traceable to international standard(s) and/or national standard(s).

BTL's reports apply only to the specific samples tested under conditions. It is manufacture's responsibility to ensure that additional production units of this model are manufactured with the identical electrical and mechanical components. **BTL** shall have no liability for any declarations, inferences or generalizations drawn by the client or others from **BTL** issued reports.

The report must not be used by the client to claim product certification, approval, or endorsement by NVLAP, NIST, A2LA, or any agency of the U.S. Government.

This report is the confidential property of the client. As a mutual protection to the clients, the public and ourselves, the test report shall not be reproduced, except in full, without our written approval.

BTL's laboratory quality assurance procedures are in compliance with the **ISO/IEC 17025** requirements, and accredited by the conformity assessment authorities listed in this test report.

BTL is not responsible for the sampling stage, so the results only apply to the sample as received.

The information, data and test plan are provided by manufacturer which may affect the validity of results, so it is manufacturer's responsibility to ensure that the apparatus meets the essential requirements of applied standards and in all the possible configurations as representative of its intended use.

Limitation

For the use of the authority's logo is limited unless the Test Standard(s)/Scope(s)/Item(s) mentioned in this test report is (are) included in the conformity assessment authorities acceptance respective.

Please note that the measurement uncertainty is provided for informational purpose only and are not use in determining the Pass/Fail results.

Table of Contents	Page
REPORT ISSUED HISTORY	7
1 . SUMMARY OF TEST RESULTS	8
1.1 TEST FACILITY	9
1.2 MEASUREMENT UNCERTAINTY	9
1.3 TEST ENVIRONMENT CONDITIONS	11
2 . GENERAL INFORMATION	12
2.1 GENERAL DESCRIPTION OF EUT	12
2.2 DESCRIPTION OF TEST MODES	13
2.3 EUT OPERATING CONDITIONS	15
2.4 BLOCK DIAGRAM SHOWING THE CONFIGURATION OF SYSTEM TESTED	15
2.5 DESCRIPTION OF SUPPORT UNITS	15
3 . EMC EMISSION TEST- EN55032:2012+AC:2013&2015	16
3.1 RADIATED EMISSION UP TO 1 GHZ	16
3.1.1 LIMITS	16
3.1.2 MEASUREMENT INSTRUMENTS LIST	16
3.1.3 TEST PROCEDURE	17
3.1.4 DEVIATION FROM TEST STANDARD	17
3.1.5 TEST SETUP	17
3.1.6 MEASUREMENT DISTANCE	18
3.1.7 TEST RESULTS (UP TO 1 GHZ)	19
3.2 RADIATED EMISSION ABOVE 1 GHZ	27
3.2.1 LIMITS	27
3.2.2 MEASUREMENT INSTRUMENTS LIST	27
3.2.3 TEST PROCEDURE	28
3.2.4 DEVIATION FROM TEST STANDARD	28
3.2.5 TEST SETUP	28
3.2.6 MEASUREMENT DISTANCE	29
3.2.7 TEST RESULTS (ABOVE 1 GHZ)	30
3.3 CONDUCTED EMISSION MEASUREMENT AT AC MAINS POWER PORTS	38
3.3.1 LIMITS	38
3.3.2 MEASUREMENT INSTRUMENTS LIST	38
3.3.3 TEST PROCEDURE	38
3.3.4 DEVIATION FROM TEST STANDARD	39
3.3.5 TEST SETUP	39
3.3.6 TEST RESULTS	40
4 . EMC EMISSION TEST- EN 55032:2015+AC:2016	48

Table of Contents	Page
4.1 RADIATED EMISSIONS UP TO 1 GHZ	48
4.1.1 LIMITS	48
4.1.2 MEASUREMENT INSTRUMENTS LIST	48
4.1.3 TEST PROCEDURE	49
4.1.4 DEVIATION FROM TEST STANDARD	49
4.1.5 TEST SETUP	49
4.1.6 MEASUREMENT DISTANCE	50
4.1.7 TEST RESULTS (UP TO 1 GHZ)	51
4.2 RADIATED EMISSIONS ABOVE 1 GHZ	53
4.2.1 LIMITS	53
4.2.2 TEST PROCEDURE	54
4.2.3 DEVIATION FROM TEST STANDARD	54
4.2.4 TEST SETUP	55
4.2.5 MEASUREMENT DISTANCE	56
4.2.6 TEST RESULTS (ABOVE 1 GHZ)	57
4.3 CONDUCTED EMISSION MEASUREMENT AT AC MAINS POWER PORTS	59
4.3.1 LIMITS	59
4.3.2 MEASUREMENT INSTRUMENTS LIST	59
4.3.3 TEST PROCEDURE	59
4.3.4 DEVIATION FROM TEST STANDARD	60
4.3.5 TEST SETUP	60
4.3.6 TEST RESULTS	61
5 . HARMONIC AND FLICKER TEST	63
5.1 HARMONIC CURRENT EMISSIONS	63
5.1.1 LIMITS	63
5.1.2 MEASUREMENT INSTRUMENTS LIST	63
5.1.3 TEST PROCEDURE	63
5.1.4 DEVIATION FROM TEST STANDARD	63
5.1.5 TEST SETUP	63
5.1.6 TEST RESULTS	64
5.2 VOLTAGE CHANGES, VOLTAGE FLUCTUATIONS AND FLICKER TEST	67
5.2.1 LIMITS	67
5.2.2 MEASUREMENT INSTRUMENTS LIST	67
5.2.3 TEST PROCEDURE	67
5.2.4 DEVIATION FROM TEST STANDARD	67
5.2.5 TEST SETUP	68
5.2.6 TEST RESULTS	69
6 . EMC IMMUNITY TEST	70
6.1 STANDARD COMPLIANCE/SEVERITY LEVEL/CRITERIA	70
6.2 GENERAL PERFORMANCE CRITERIA	73

Table of Contents	Page
6.3 ANNEX D (NORMATIVE) - DISPLAY AND DISPLAY OUTPUT FUNCTION	74
6.3.1 PERFORMANCE CRITERIA	74
6.4 ANNEX G (NORMATIVE) - AUDIO OUTPUT FUNCTION	75
6.4.1 PERFORMANCE CRITERIA	75
6.5 ELECTROSTATIC DISCHARGE IMMUNITY TEST (ESD)	76
6.5.1 TEST SPECIFICATION	76
6.5.2 MEASUREMENT INSTRUMENTS	76
6.5.3 TEST PROCEDURE	76
6.5.4 DEVIATION FROM TEST STANDARD	77
6.5.5 TEST SETUP	77
6.5.6 TEST RESULTS	78
6.6 RADIATED, RADIO-FREQUENCY, ELECTROMAGNETIC FIELD IMMUNITY TEST (RS)	82
6.6.1 TEST SPECIFICATION	82
6.6.2 MEASUREMENT INSTRUMENTS	82
6.6.3 TEST PROCEDURE	82
6.6.4 DEVIATION FROM TEST STANDARD	83
6.6.5 TEST SETUP	83
6.6.6 TEST RESULTS	85
6.7 ELECTRICAL FAST TRANSIENT/BURST IMMUNITY TEST (EFT/BURST)	90
6.7.1 TEST SPECIFICATION	90
6.7.2 MEASUREMENT INSTRUMENTS	90
6.7.3 TEST PROCEDURE	90
6.7.4 DEVIATION FROM TEST STANDARD	90
6.7.5 TEST SETUP	91
6.7.6 TEST RESULTS	92
6.8 SURGE IMMUNITY TEST	93
6.8.1 TEST SPECIFICATION	93
6.8.2 MEASUREMENT INSTRUMENTS	93
6.8.3 TEST PROCEDURE	93
6.8.4 DEVIATION FROM TEST STANDARD	94
6.8.5 TEST SETUP	94
6.8.6 TEST RESULTS	95
6.9 IMMUNITY TO CONDUCTED DISTURBANCES, INDUCED BY RADIO-FREQUENCY FIELDS TEST (CS)	96
6.9.1 TEST SPECIFICATION	96
6.9.2 MEASUREMENT INSTRUMENTS	96
6.9.3 TEST PROCEDURE	96
6.9.4 DEVIATION FROM TEST STANDARD	97
6.9.5 TEST SETUP	97
6.9.6 TEST RESULTS	99
6.10 POWER FREQUENCY MAGNETIC FIELD IMMUNITY TEST (PFMF)	102

Table of Contents	Page
6.10.1 TEST SPECIFICATION	102
6.10.2 MEASUREMENT INSTRUMENTS	102
6.10.3 TEST PROCEDURE	102
6.10.4 DEVIATION FROM TEST STANDARD	102
6.10.5 TEST SETUP	103
6.10.6 TEST RESULTS	104
6.11 VOLTAGE DIPS, SHORT INTERRUPTIONS AND VOLTAGE VARIATIONS IMMUNITY	
TEST (DIPS)	105
6.11.1 TEST SPECIFICATION	105
6.11.2 MEASUREMENT INSTRUMENTS	105
6.11.3 TEST PROCEDURE	105
6.11.4 DEVIATION FROM TEST STANDARD	105
6.11.5 TEST SETUP	105
6.11.6 TEST RESULTS	106
7 . EUT TEST PHOTO	107

REPORT ISSUED HISTORY

Report Version	Description	Issued Date
R00	Original Issue.	Aug. 13, 2020

1. SUMMARY OF TEST RESULTS

Test procedures according to the technical standards:

Emission			
Standard(s)	Test Item		Result
EN 55032:2012+AC:2013 EN 55032:2015 EN 55032:2015+AC:2016	Radiated emissions up to 1 GHz		PASS
	Radiated emissions above 1 GHz		PASS
	Radiated emissions from FM receivers		N/A
	Conducted emissions AC mains power port		PASS
	Asymmetric mode conducted emissions	AAN	N/A
		Current Probe	N/A
		CP+CVP	N/A
Conducted differential voltage emissions		N/A	

Standard(s)	Test Item	Result
IEC 61000-3-2:2014 EN 61000-3-2:2014	Harmonic current	PASS
IEC 61000-3-3:2013+A1:2017 EN 61000-3-3:2013+A1:2019	Voltage fluctuations (Flicker)	PASS

Immunity			
Standard(s)	Ref Standard(s)	Test Item	Result
EN 55035:2017	IEC 61000-4-2:2008 / EN 61000-4-2:2009	ESD	PASS
	IEC 61000-4-3:2006+A1:2007+A2:2010 / EN 61000-4-3:2006+A1:2008+A2:2010	RS	PASS
	IEC 61000-4-4:2012 / EN 61000-4-4:2012	EFT	PASS
	IEC 61000-4-5:2014+A1:2017 / EN 61000-4-5:2014+A1:2017	Surge	PASS
	IEC 61000-4-6:2013 / EN 61000-4-6:2014+AC:2015	CS	PASS
	IEC 61000-4-8:2009 / EN 61000-4-8:2010	PFMF	PASS
	IEC 61000-4-11:2004+A1:2017 / EN 61000-4-11:2004+A1:2017	Dips	PASS
	4.2.7	Broadband impulse noise disturbances, repet itive	N/A
	4.2.7	Broadband impulse noise disturbances, isolat ed	N/A

NOTE:

- (1) "N/A" denotes test is not applicable to this device.

1.1 TEST FACILITY

The test facilities used to collect the test data in this report is at the location of No.3, Jinshagang 1st Road, Shixia, Dalang Town, Dongguan, Guangdong, China.

1.2 MEASUREMENT UNCERTAINTY

Where relevant, the following measurement uncertainty levels have been estimated for tests performed on the EUT as specified in CISPR 16-4-2, The BTL measurement uncertainty is less than the CISPR 16-4-2 U_{cispr} requirement.

The reported uncertainty of measurement $y \pm U$, where expanded uncertainty U is based on a standard uncertainty multiplied by a coverage factor of $k=2$, providing a level of confidence of approximately **95%**.

A. Radiated emissions up to 1 GHz measurement:

Test Site	Method	Measurement Frequency Range	Ant. H / V	U,(dB)
DG-CB08 (10m)	CISPR	30MHz ~ 200MHz	V	4.44
		30MHz ~ 200MHz	H	3.44
		200MHz ~ 1,000MHz	V	4.28
		200MHz ~ 1,000MHz	H	3.52

B. Radiated emissions above 1 GHz measurement:

Test Site	Method	Measurement Frequency Range	U,(dB)
DG-CB08 (3m)	CISPR	1GHz ~ 6GHz	4.36

C. Conducted emissions AC mains power port measurement:

Test Site	Method	Measurement Frequency Range	U,(dB)
DG-C01	CISPR	150kHz ~ 30MHz	2.90

D. Harmonic/ Flicker Measurement:

Test Site	Method	Item	U (%)
DG-C01	EN 61000-3-2	Current	0.593
	EN 61000-3-3	Voltage	0.595

E. Immunity Measurement:

Test Site	Method	Item	U
DG-SR02	IEC 61000-4-2	Rise time t_r	6.80%
		Peak current I_p	6.30%
		Current at 30 ns	6.50%
		Current at 60 ns	6.90%
DG-CB05	IEC 61000-4-3 (80MHz~6GHz)	Electromagnetic field immunity test	2.38dB
		On-ear acoustic & Acoustic measurements on loudspeakers	2.40dB
		Electrical measurements	2.40dB
DG-SR05	IEC 61000-4-4	Peak voltage (V_P)	3.7%
		Rise time (t_r)	4.4%
		Pulse width(t_w)	4.1%
		Pulse Freq.(kHz)	0.8%
		Burst Duration(ms)	1.4%
		Burst Period(ms)	1.4%
DG-SR05	IEC 61000-4-5	Open-Circuit Output Voltage (1.2/50us)	3.8%
		Open circuit front time (1.2/50us)	6.3%
		Open circuit time of half value (1.2/50us)	4.6%
DG-CB06	IEC 61000-4-6 (150kHz-80MHz)	CDN	1.32dB
		EM clamp	3.16dB
		On-ear acoustic & Acoustic measurements on loudspeakers	1.36dB
		Electrical measurements	1.34dB
DG-SR05	IEC 61000-4-8	Magnetic Field Level	2.38%
DG-SR05	IEC 61000-4-11	DIP Amplitude	0.5%
		DIP Time Event	3%

Note: Unless specifically mentioned, the uncertainty of measurement has not been taken into account to declare the compliance or non-compliance to the specification.

1.3 TEST ENVIRONMENT CONDITIONS

Test Item	Temperature	Humidity	Tested By
Radiated emissions up to 1 GHz	25°C	60%	Albe Zhou
Radiated emissions above 1 GHz	25°C	60%	Albe Zhou
Conducted emissions AC mains power port	25°C	53%	Bang Liang
Harmonic current	25°C	55%	Bang Liang
Voltage fluctuations (Flicker)	25°C	55%	Bang Liang

Test Item	Temperature	Humidity	Pressure	Tested By
ESD	25°C	45%	1011hPa	Rich Ye
RS	24°C	48%	/	Hunter Xu
EFT	25°C	44%	/	Celina Lai
Surge	25°C	44%	/	Celina Lai
CS	25°C	42%	/	Jason Liang
PFMF	25°C	44%	/	Celina Lai
Dips	25°C	44%	/	Celina Lai

2. GENERAL INFORMATION

2.1 GENERAL DESCRIPTION OF EUT

Equipment	LCD Monitor
Brand Name	N/A
Test Model	**2490***** (*=0-9,A-Z,a-z,+,-,/, \ or blank)
Series Model	N/A
Model Difference(s)	Only differ in model name due to marketing purpose.
Power Source	AC Mains.
Power Rating	100-240V ~ 50-60Hz 1.3A
Connecting I/O Port(s)	1* AC port 1* HDMI port 1* Earphone port 1* DP port
Classification Of EUT	Class B
Highest Internal Frequency(Fx)	148.5MHz

Cable Type	Shielded Type	Ferrite Core	Length(m)	Note
AC Power Cord	Non-shielded	NO	1.8/1.5/1.2	1.8m is worst case Detachable
DP	Shielded	NO	1.8/1.5/1.2	-
HDMI	Shielded	NO	1.8/1.5/1.2	-

Note:

- For a more detailed features description, please refer to the manufacturer's specifications or the user's manual.
- Power cable 1.8m, 1.5m, 1.2m length, worst case is Power cable 1.8m with DP+HDMI length testing and recording in test report.

2.2 DESCRIPTION OF TEST MODES

To investigate the maximum EMI emission characteristics generated from EUT, the test system was pre-scanning tested based on the consideration of following EUT operation mode or test configuration mode which possibly have effect on EMI emission level. Each of these EUT operation mode(s) or test configuration mode(s) mentioned above was evaluated respectively.

Pretest Mode	Description
Mode 1	HDMI 1920*1080/60Hz 1.8m
Mode 2	DP 1920*1080/144Hz 1.8m
Mode 3	HDMI 1080P 1.8m
Mode 4	HDMI 1280*720/60Hz 1.8m
Mode 5	HDMI 640*480/60Hz 1.8m
Mode 6	HDMI 1920*1080/60Hz 1.5m
Mode 7	HDMI 1920*1080/60Hz 1.2m

Radiated emissions up to 1 GHz test	
Final Test Mode	Description
Mode 1	HDMI 1920*1080/60Hz 1.8m
Mode 2	DP 1920*1080/144Hz 1.8m
Mode 3	HDMI 1080P 1.8m

Radiated emissions Above 1 GHz test	
Final Test Mode	Description
Mode 1	HDMI 1920*1080/60Hz 1.8m
Mode 2	DP 1920*1080/144Hz 1.8m
Mode 3	HDMI 1080P 1.8m

Conducted emissions AC mains power port test	
Final Test Mode	Description
Mode 1	HDMI 1920*1080/60Hz 1.8m
Mode 2	DP 1920*1080/144Hz 1.8m
Mode 3	HDMI 1080P 1.8m

Harmonic current & Voltage fluctuations (Flicker) Test	
Final Test Mode	Description
Mode 1	HDMI 1920*1080/60Hz 1.8m

Immunity Test	
Final Test Mode	Description
Mode 1	HDMI 1920*1080/60Hz 1.8m
Mode 2	DP 1920*1080/144Hz 1.8m
Mode 3	HDMI 1080P 1.8m
Mode 6	HDMI 1920*1080/60Hz 1.5m
Mode 7	HDMI 1920*1080/60Hz 1.2m

Evaluation description:

1. The maximum resolution is evaluated Mode 1-3. The worst case is Mode 1 and evaluated the middle and low resolution Mode 4 and Mode 5.
2. According to the client's requirement, choose Mode 1, Mode 2, Mode 3 and recorded in test report.
3. RS Acoudtic: The Front, Rear, Left and Right were evaluated. The worst placement direction of Auido is Front ,the worst placement direction of Speaker is Rear and recorded in this report

2.3 EUT OPERATING CONDITIONS

The EUT exercise program used during radiated and/or conducted emission measurement was designed to exercise the various system components in a manner similar to a typical use. The standard test signals and output signal as following:

1. EUT connected to PC via DP&HDMI cable.
2. EUT connected to Earphone via earphone cable.
3. Mouse and Keyboard connected to PC via USB cable.

2.4 BLOCK DIAGRAM SHOWING THE CONFIGURATION OF SYSTEM TESTED

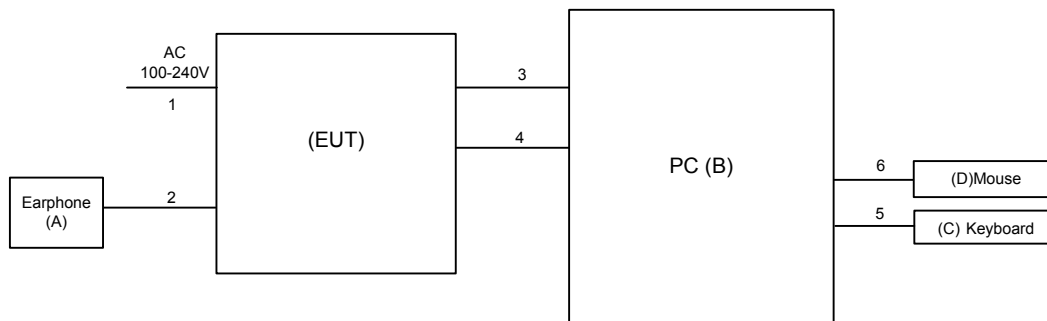

2.5 DESCRIPTION OF SUPPORT UNITS

The EUT has been tested as an independent unit together with other necessary accessories or support units. The following support units or accessories were used to form a representative test configuration during the tests.

Item	Equipment	Mfr/Brand	Model/Type No.	Series No.
A	Earphone	APPLE	N/A	N/A
B	PC	DELL	Vostro 470	24454162837
C	Keyboard	DELL	KB212-B	CN0HTXH97158125004DXA01
D	Mouse	DELL	MS111-P	CN011D3V71581279OLOT

Item	Cable Type	Shielded Type	Ferrite Core	Length
1	AC Cable	NO	NO	1.8/1.5/1.2m
2	Earphone Cable	NO	NO	1.2m
3	DP Cable	YES	NO	1.8/1.5/1.2m
4	HDMI Cable	YES	NO	1.8/1.5/1.2m
5	USB Cable	YES	NO	1.8m
6	USB Cable	YES	NO	1.8m

3. EMC EMISSION TEST- EN55032:2012+AC:2013&2015

3.1 RADIATED EMISSION UP TO 1 GHZ

3.1.1 LIMITS

Class B equipment up to 1000MHz

Frequency MHz	Measurement		Class B limit dB(uV/m)
	Distance m	Detector type/bandwidth	SAC
30-230	10	Quasi peak / 120 kHz	30
230-1000			37

Notes:

- (1) The limit for radiated test was performed according to as following: EN 55032
- (2) The tighter limit applies at the band edges.
- (3) Emission level (dBuV/m)=20log Emission level (uV/m).
- (4) The test result calculated as following:
 Measurement Value = Reading Level + Correct Factor
 Correct Factor = Antenna Factor + Cable Loss - Amplifier Gain(if use)
 Margin Level = Measurement Value - Limit Value

3.1.2 MEASUREMENT INSTRUMENTS LIST

Up to 1GHz:

Item	Kind of Equipment	Manufacturer	Type No.	Series Model	Calibrated until
1	Receiver	Keysight	N9038A	MY54450004	Aug. 03, 2020
2	MXE EMI Receiver	Agilent	N9038A	MY53220133	Feb. 28, 2021
3	Pre-Amplifier	EMC INSTRUMENT	EMC 9135	980284	Mar. 01, 2021
4	Pre-Amplifier	EMC INSTRUMENT	EMC 9135	980283	Mar. 01, 2021
5	Trilog-Broadband Antenna	Schwarzbeck	VULB9168	946	Oct. 26, 2020
6	Trilog-Broadband Antenna	Schwarzbeck	VULB9168	947	Dec. 02, 2020
7	Cable	emci	LMR-400(5m+1 1m+15m)	N/A	Nov. 22, 2020
8	Cable	emci	LMR-400(5m+8 m+8m)	N/A	Nov. 22, 2020
9	Measurement Software	Farad	EZ-EMC Ver.BTL-2ANT-1	N/A	N/A
10	Multi-Device Controller	ETS-Lindgren	2090	N/A	N/A
11	Attenuator	EMCI	EMCI-N-6-06	N0670	Dec. 02, 2020
12	Attenuator	EMCI	EMCI-N-6-06	N0671	Oct. 26, 2020

Remark: "N/A" denotes no model no., no serial no. or no calibration specified.

All calibration period of equipment list is one year.

3.1.3 TEST PROCEDURE

- a. The measuring distance of 10 m shall be used for measurements. The EUT was placed on the top of a rotating table 0.8 meter above the ground at a 10 meter semi-anechoic chamber. The table was rotated 360 degrees to determine the position of the highest radiation.(below 1GHz).
- c. The height of the equipment or of the substitution antenna shall be 0.8 m, the height of the test antenna shall vary between 1 m to 4 m. Both horizontal and vertical polarizations of the antenna are set to make the measurement.
- d. The initial step in collecting radiated emission data is a receiver peak detector mode pre-scanning the measurement frequency range. Significant peaks are then marked and then Quasi Peak detector mode re-measured.
- e. All readings are Peak unless otherwise stated QP in column of Note. Peak denotes that the Peak reading compliance with the QP Limits and then QP Mode measurement didn't perform.
(below 1GHz)
- g. For the actual test configuration, please refer to the related Item - Block Diagram of system tested.

3.1.4 DEVIATION FROM TEST STANDARD

No deviation

3.1.5 TEST SETUP

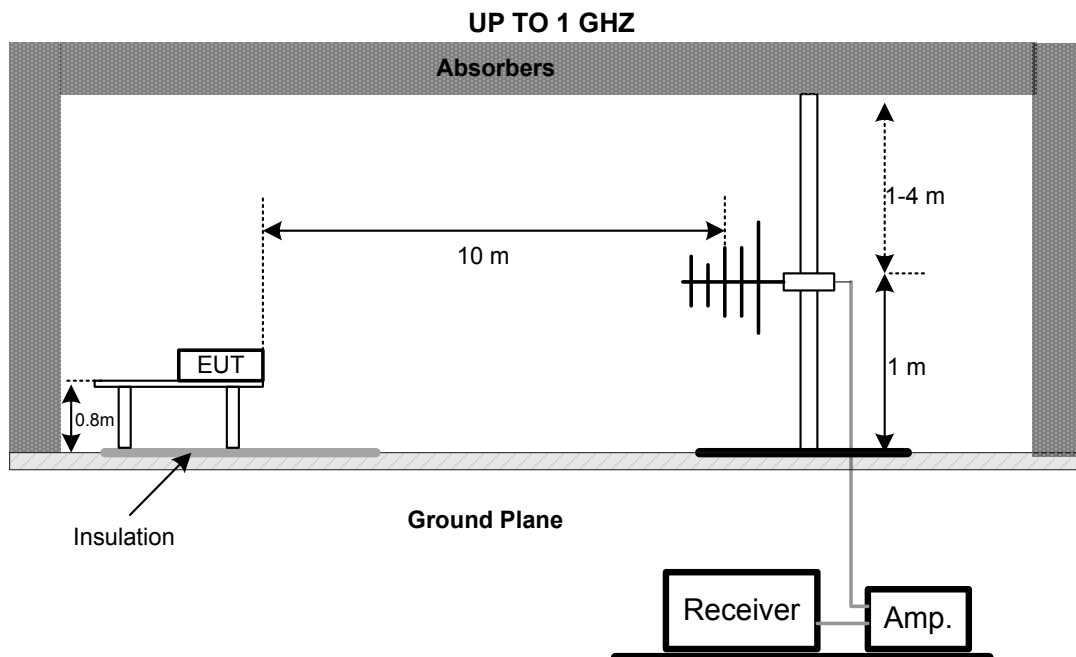

Note: The antenna can be moved between 1 to 4 meters above the ground.

3.1.6 MEASUREMENT DISTANCE

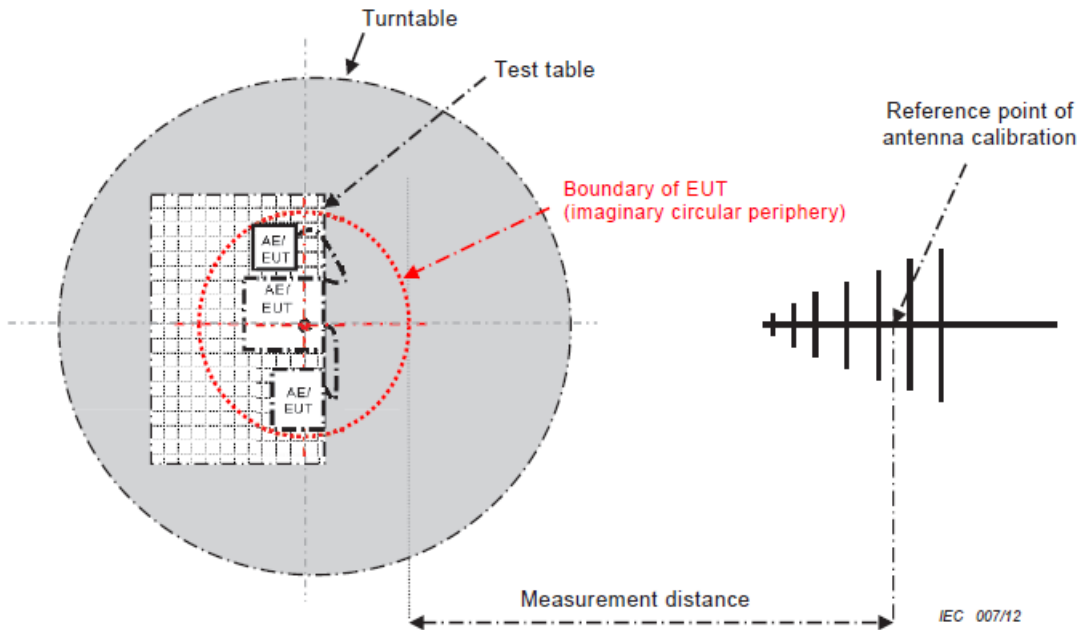

- 34 -

CISPR 32 © IEC:2012

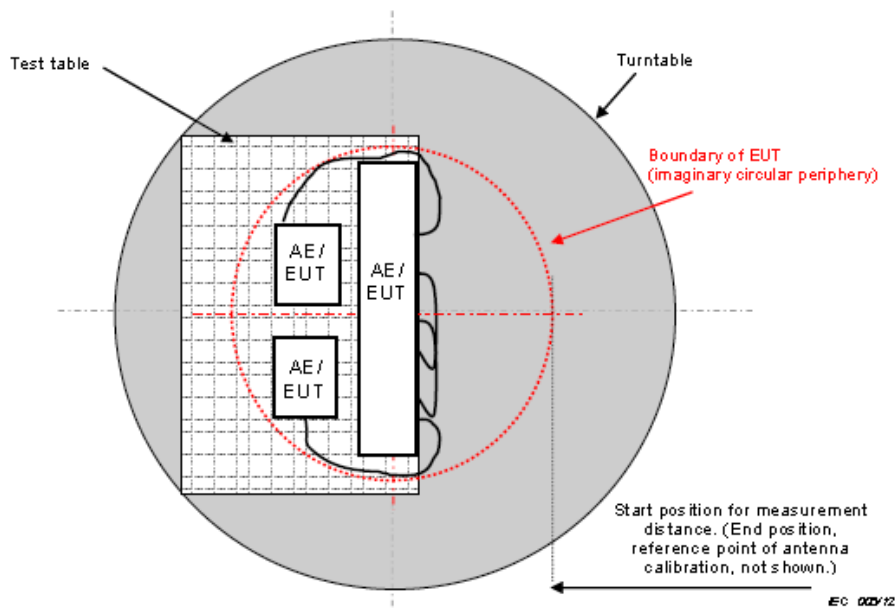
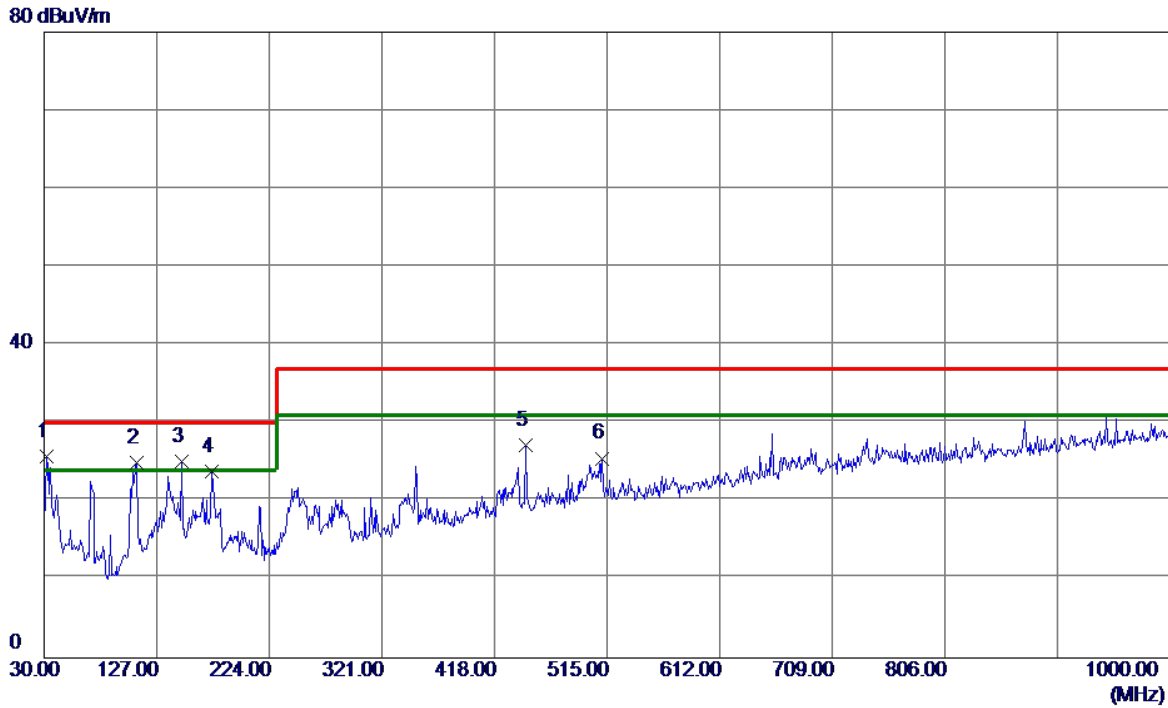

Figure C.2 – Boundary of EUT, Local AE and associated cabling

3.1.7 TEST RESULTS (UP TO 1 GHZ)

Test Voltage	AC 230V/50Hz	Polarization	Vertical
Test Mode	HDMI 1920*1080/60Hz 1.8m		



No.	Freq. MHz	Reading Level dBuV/m	Correct Factor dB	Measure ment dBuV/m	Limit dBuV/m	Margin dB	Detector
1 *	31.9400	44.65	-18.83	25.82	30.00	-4.18	QP
2	109.5400	44.62	-19.62	25.00	30.00	-5.00	QP
3	148.3400	41.11	-15.96	25.15	30.00	-4.85	QP
4	174.5300	40.27	-16.50	23.77	30.00	-6.23	QP
5	445.1600	37.87	-10.70	27.17	37.00	-9.83	QP
6	511.1200	35.00	-9.48	25.52	37.00	-11.48	QP

Test Voltage	AC 230V/50Hz	Polarization	Horizontal
Test Mode	HDMI 1920*1080/60Hz 1.8m		

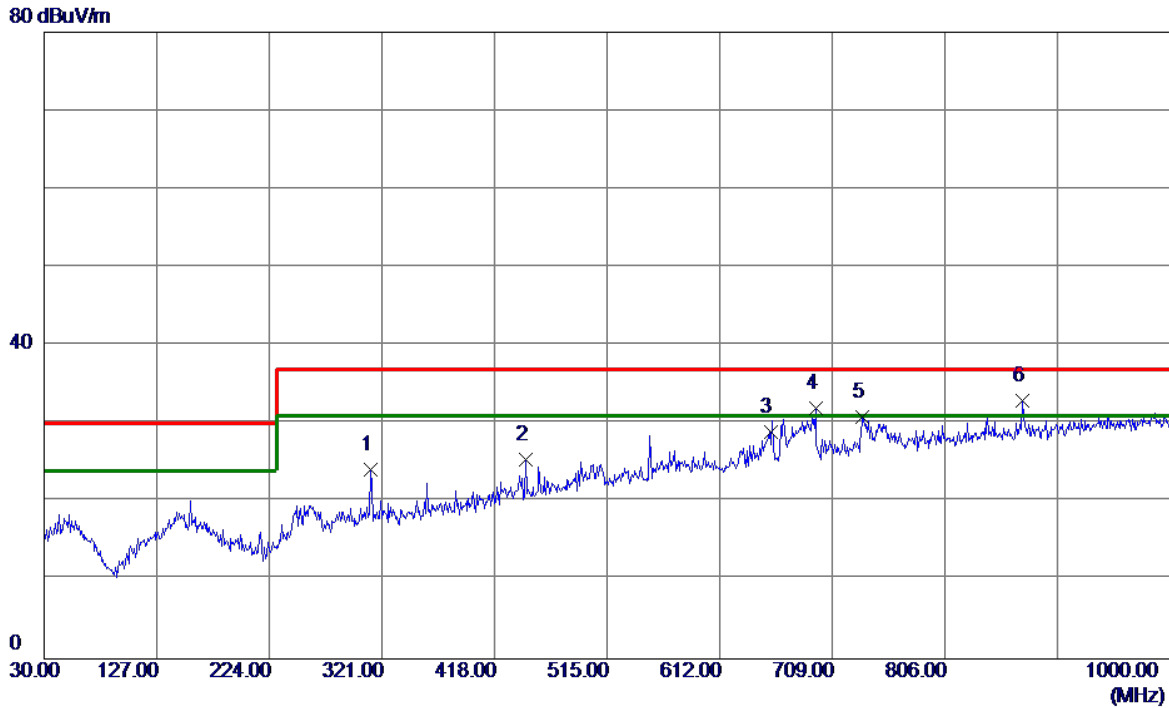

No.	Freq. MHz	Reading Level dBuV/m	Correct Factor dB	Measure ment dBuV/m	Limit dBuV/m	Margin dB	Detector
1	311.3000	38.10	-13.94	24.16	37.00	-12.84	QP
2	445.1600	36.01	-10.55	25.46	37.00	-11.54	QP
3	655.6500	35.40	-6.44	28.96	37.00	-8.04	QP
4	694.4500	37.75	-5.72	32.03	37.00	-4.97	QP
5	735.1900	35.78	-4.97	30.81	37.00	-6.19	QP
6 *	872.9300	36.31	-3.37	32.94	37.00	-4.06	QP

Test Voltage	AC 230V/50Hz	Polarization	Vertical
Test Mode	DP 1920*1080/144Hz 1.8m		

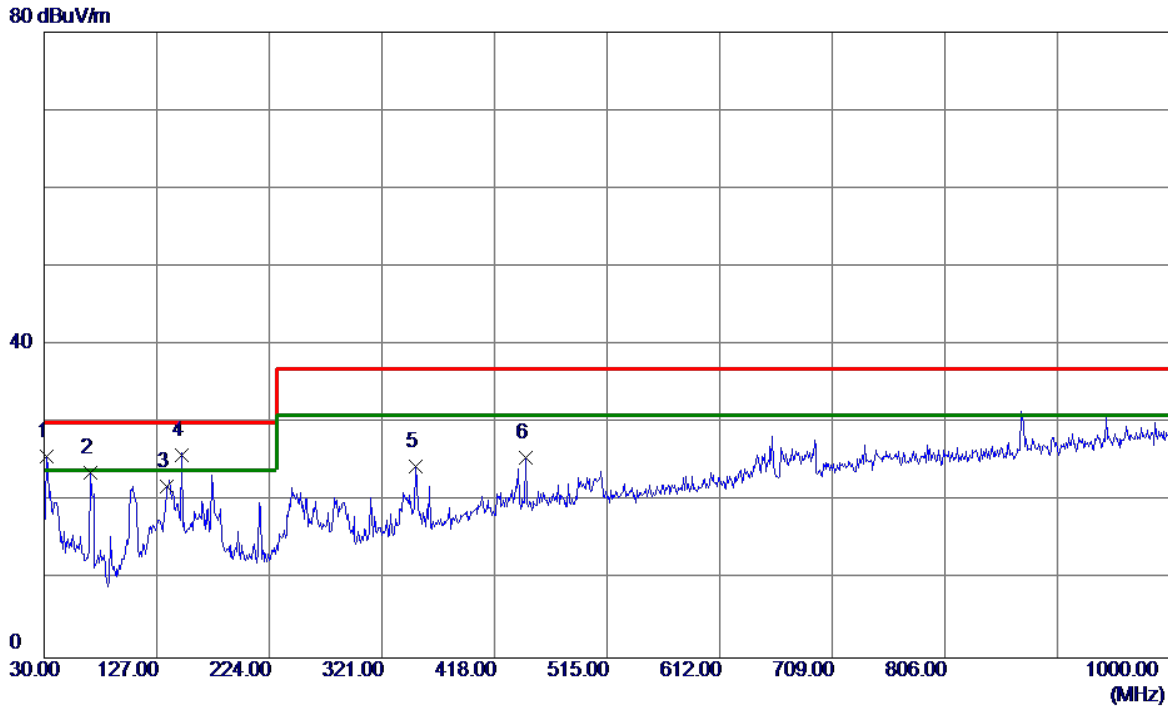

No.	Freq. MHz	Reading Level dBuV/m	Correct Factor dB	Measure ment dBuV/m	Limit dBuV/m	Margin dB	Detector
1	31.9400	44.66	-18.83	25.83	30.00	-4.17	QP
2	69.7699	42.30	-18.66	23.64	30.00	-6.36	QP
3	135.7300	38.95	-16.97	21.98	30.00	-8.02	QP
4 *	148.3400	41.85	-15.96	25.89	30.00	-4.11	QP
5	350.1000	37.69	-13.28	24.41	37.00	-12.59	QP
6	445.1600	36.36	-10.70	25.66	37.00	-11.34	QP

Test Voltage	AC 230V/50Hz	Polarization	Horizontal
Test Mode	DP 1920*1080/144Hz 1.8m		

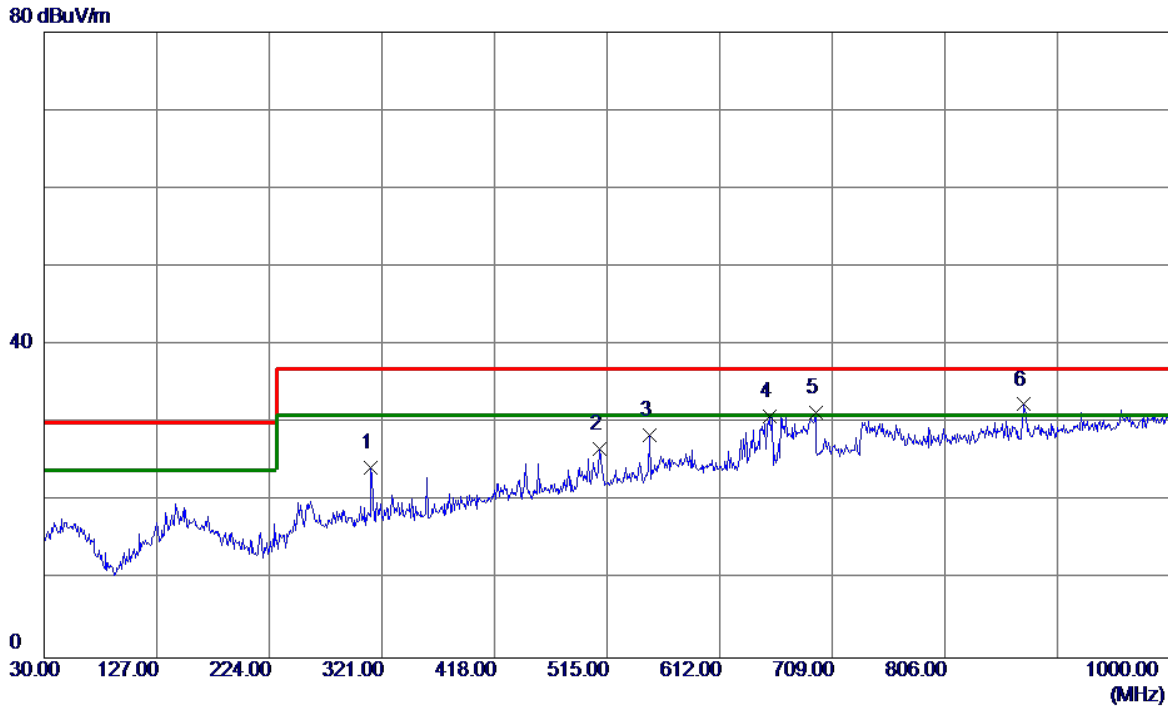

No.	Freq. MHz	Reading Level dBuV/m	Correct Factor dB	Measure ment dBuV/m	Limit dBuV/m	Margin dB	Detector
1	311.3000	38.19	-13.94	24.25	37.00	-12.75	QP
2	508.2100	36.11	-9.35	26.76	37.00	-10.24	QP
3	551.8600	36.97	-8.51	28.46	37.00	-8.54	QP
4	654.6800	37.31	-6.45	30.86	37.00	-6.14	QP
5	694.4500	37.07	-5.72	31.35	37.00	-5.65	QP
6 *	873.9000	35.76	-3.36	32.40	37.00	-4.60	QP

Test Voltage	AC 230V/50Hz	Polarization	Vertical
Test Mode	HDMI 1080P 1.8m		

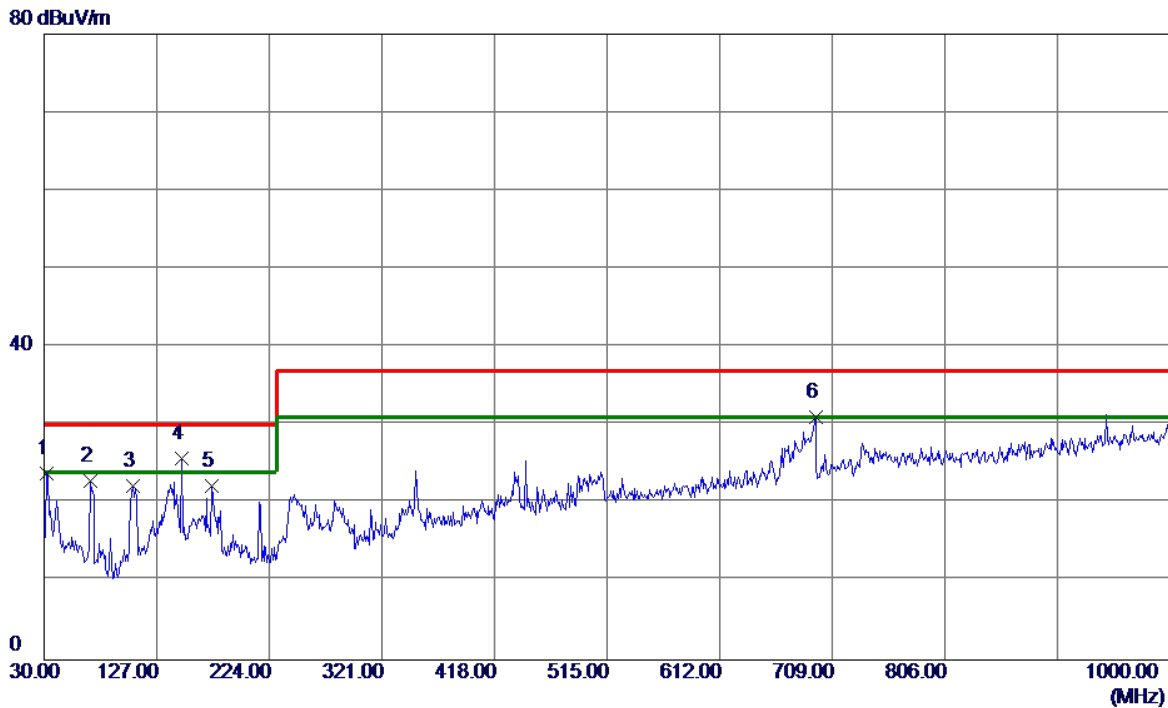

No.	Freq. MHz	Reading Level dBuV/m	Correct Factor dB	Measure ment dBuV/m	Limit dBuV/m	Margin dB	Detector
1	31.9400	42.61	-18.83	23.78	30.00	-6.22	QP
2	69.7699	41.54	-18.66	22.88	30.00	-7.12	QP
3	106.6300	42.16	-19.97	22.19	30.00	-7.81	QP
4 *	148.3400	41.66	-15.96	25.70	30.00	-4.30	QP
5	174.5300	38.77	-16.50	22.27	30.00	-7.73	QP
6	694.4500	37.25	-6.15	31.10	37.00	-5.90	QP

Test Voltage	AC 230V/50Hz	Polarization	Horizontal
Test Mode	HDMI 1080P 1.8m		

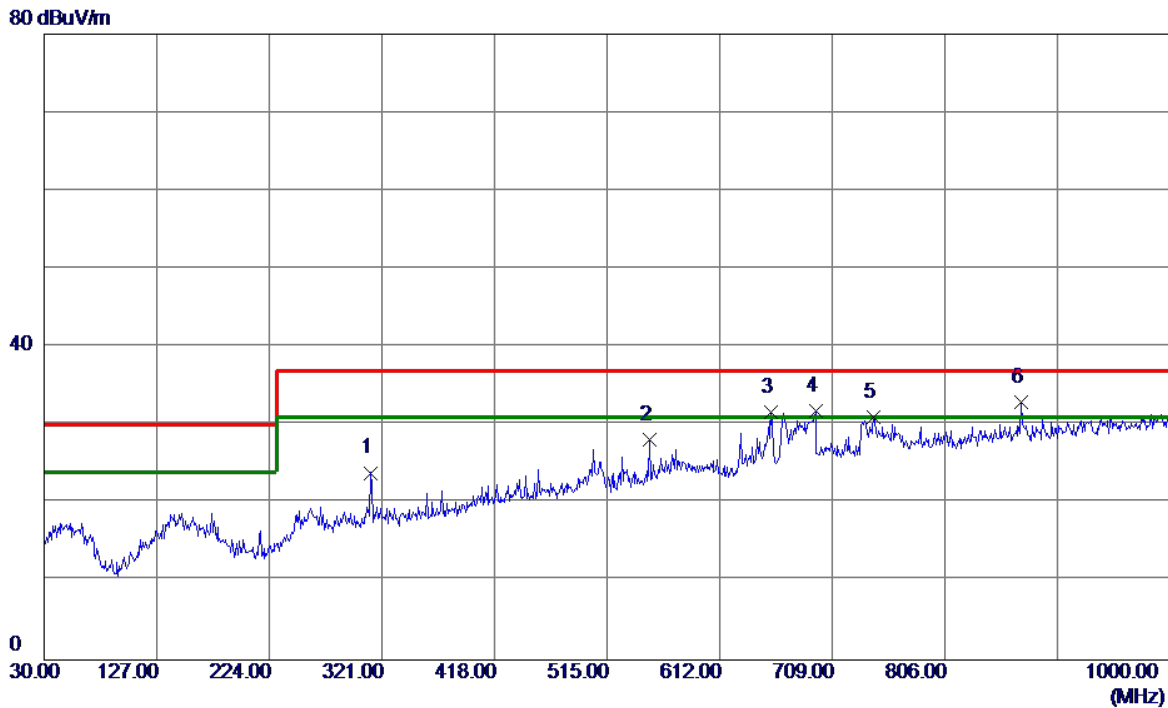

No.	Freq. MHz	Reading Level dBuV/m	Correct Factor dB	Measure ment dBuV/m	Limit dBuV/m	Margin dB	Detector
1	311.3000	37.86	-13.94	23.92	37.00	-13.08	QP
2	551.8600	36.64	-8.51	28.13	37.00	-8.87	QP
3	656.6200	38.12	-6.42	31.70	37.00	-5.30	QP
4	694.4500	37.53	-5.72	31.81	37.00	-5.19	QP
5	744.8900	35.76	-4.79	30.97	37.00	-6.03	QP
6 *	871.9600	36.31	-3.38	32.93	37.00	-4.07	QP

Test Voltage	AC 110V/60Hz	Polarization	Vertical
Test Mode	HDMI 1920*1080/60Hz 1.8m		

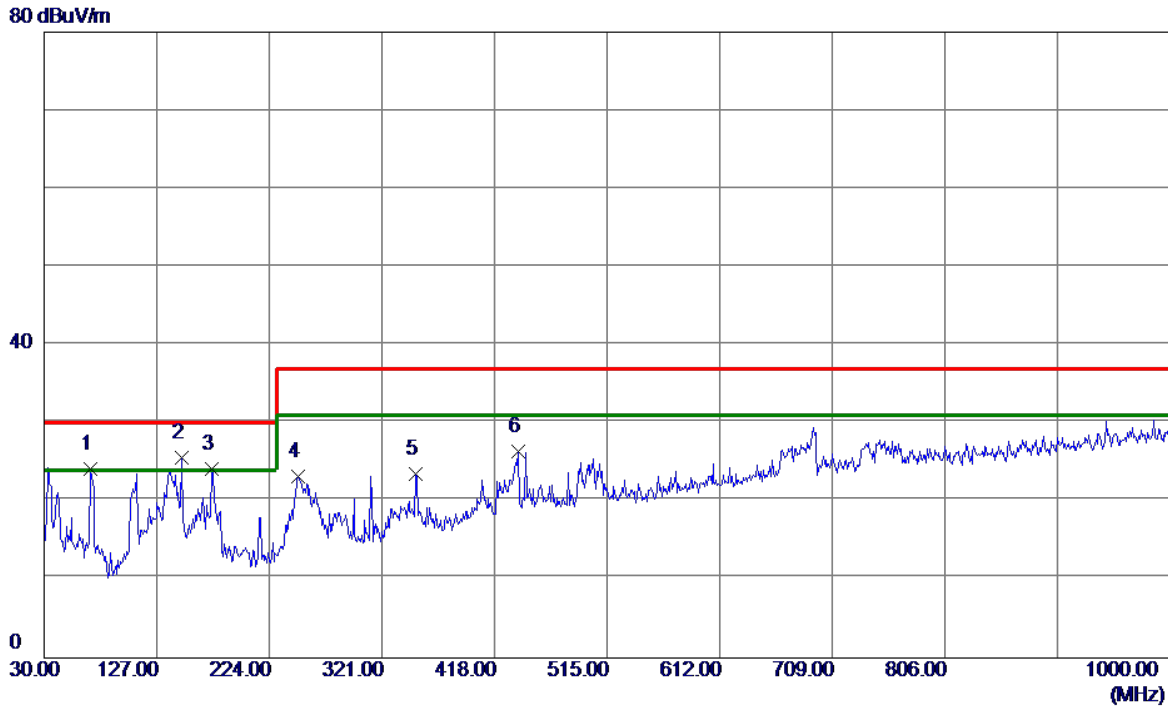

No.	Freq. MHz	Reading Level dBuV/m	Correct Factor dB	Measure ment dBuV/m	Limit dBuV/m	Margin dB	Detector
1	69.7699	42.77	-18.66	24.11	30.00	-5.89	QP
2 *	148.3400	41.57	-15.96	25.61	30.00	-4.39	QP
3	174.5300	40.63	-16.50	24.13	30.00	-5.87	QP
4	249.2200	39.54	-16.40	23.14	37.00	-13.86	QP
5	350.1000	36.81	-13.28	23.53	37.00	-13.47	QP
6	438.3700	37.38	-10.92	26.46	37.00	-10.54	QP

Test Voltage	AC 110V/60Hz	Polarization	Horizontal
Test Mode	HDMI 1920*1080/60Hz 1.8m		

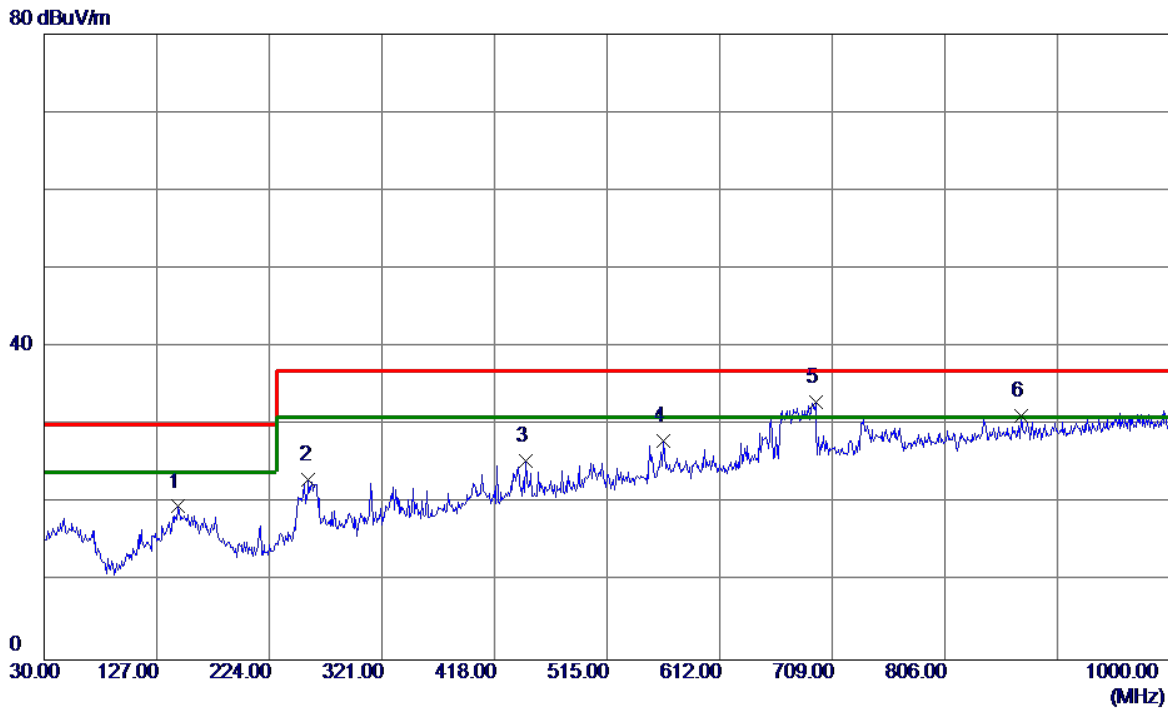

No.	Freq. MHz	Reading Level dBuV/m	Correct Factor dB	Measure ment dBuV/m	Limit dBuV/m	Margin dB	Detector
1	145.4299	35.36	-15.76	19.60	30.00	-10.40	QP
2	257.9500	39.20	-16.12	23.08	37.00	-13.92	QP
3	445.1600	35.92	-10.55	25.37	37.00	-11.63	QP
4	563.5000	36.17	-8.21	27.96	37.00	-9.04	QP
5 *	694.4500	38.67	-5.72	32.95	37.00	-4.05	QP
6	871.9600	34.65	-3.38	31.27	37.00	-5.73	QP

3.2 RADIATED EMISSION ABOVE 1 GHZ

3.2.1 LIMITS

Class B equipment above 1000MHz

Frequency MHz	Measurement		Class B limit dB(uV/m)
	Distance m	Detector type/bandwidth	FSOATS
1000-3000	3	Average / 1 MHz	50
3000-6000			54
1000-3000		Peak / 1 MHz	70
3000-6000			74

Notes:

- (1) The limit for radiated test was performed according to as following: EN 55032
- (2) The tighter limit applies at the band edges.
- (3) Emission level (dBuV/m)=20log Emission level (uV/m).
- (4) The test result calculated as following:
 Measurement Value = Reading Level + Correct Factor
 Correct Factor = Antenna Factor + Cable Loss - Amplifier Gain(if use)
 Margin Level = Measurement Value - Limit Value

Required highest frequency for radiated measurement

Highest internal frequency (F_x) MHz	Highest measured frequency MHz
$F_x \leq 108$	1000
$108 < F_x \leq 500$	2000
$500 < F_x \leq 1000$	5000
$F_x > 1000$	5 th up to a maximum 6 GHz,

Note for FM and TV broadcast receiver, F_x is determined from the highest frequency generated or used excluding the local oscillator and tuned frequencies.

3.2.2 MEASUREMENT INSTRUMENTS LIST

Above 1GHz:

Item	Kind of Equipment	Manufacturer	Type No.	Series Model	Calibrated until
1	Horn Antenna	EMCO	3115	9605-4803	May 12, 2021
2	Amplifier	Agilent	8449B	3008A02333	Mar. 01, 2021
3	MXE EMI Receiver	Agilent	N9038A	MY53220133	Feb. 28, 2021
4	Measurement Software	Farad	EZ-EMC Ver.BTL-2ANT-1	N/A	N/A
5	Multi-Device Controller	ETS-Lindgren	2090	N/A	N/A
6	Controller	MF	MF-7802	MF780208159	N/A
7	Cable	Micable Inc.	B10-01-01-5M	18047123	Feb. 28, 2021
8	Cable	Micable Inc.	B10-01-01-12M	18072743	Feb. 28, 2021
9	Cable	RegalWay	RWLPS50-7.9A- SMSM-1M	20200102 001	Feb. 28, 2021

Remark: "N/A" denotes no model no., no serial no. or no calibration specified.

All calibration period of equipment list is one year.

3.2.3 TEST PROCEDURE

- a. The measuring distance of 3 m shall be used for measurements. The EUT was placed on the top of a rotating table 0.8 meter above the ground at a 10 meter semi-anechoic chamber. The table was rotated 360 degrees to determine the position of the highest radiation.(above 1GHz)
- b. The height of the equipment or of the substitution antenna shall be 0.8 m, the height of the test antenna shall vary between 1 m to 4 m. Both horizontal and vertical polarizations of the antenna are set to make the measurement.
- c. The initial step in collecting radiated emission data is a receiver peak detector mode pre-scanning the measurement frequency range. Significant peaks are then marked and then Quasi Peak detector mode re-measured.
- d. All readings are Peak Mode value unless otherwise stated AVG in column of Note. If the Peak Mode Measured value compliance with the Peak Limits and lower than AVG Limits, the EUT shall be deemed to meet both Peak & AVG Limits and then only Peak Mode was measured, but AVG Mode didn't perform. (above 1GHz)
- f. For the actual test configuration, please refer to the related Item - Block Diagram of system tested.

3.2.4 DEVIATION FROM TEST STANDARD

No deviation

3.2.5 TEST SETUP

ABOVE 1 GHZ

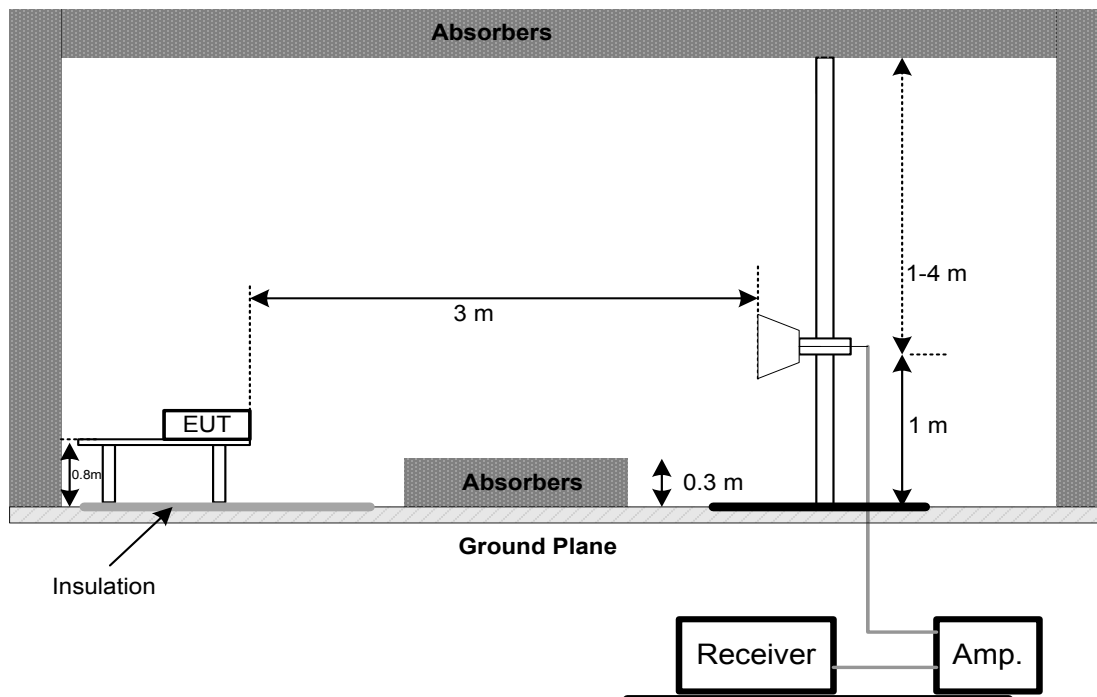

3.2.6 MEASUREMENT DISTANCE

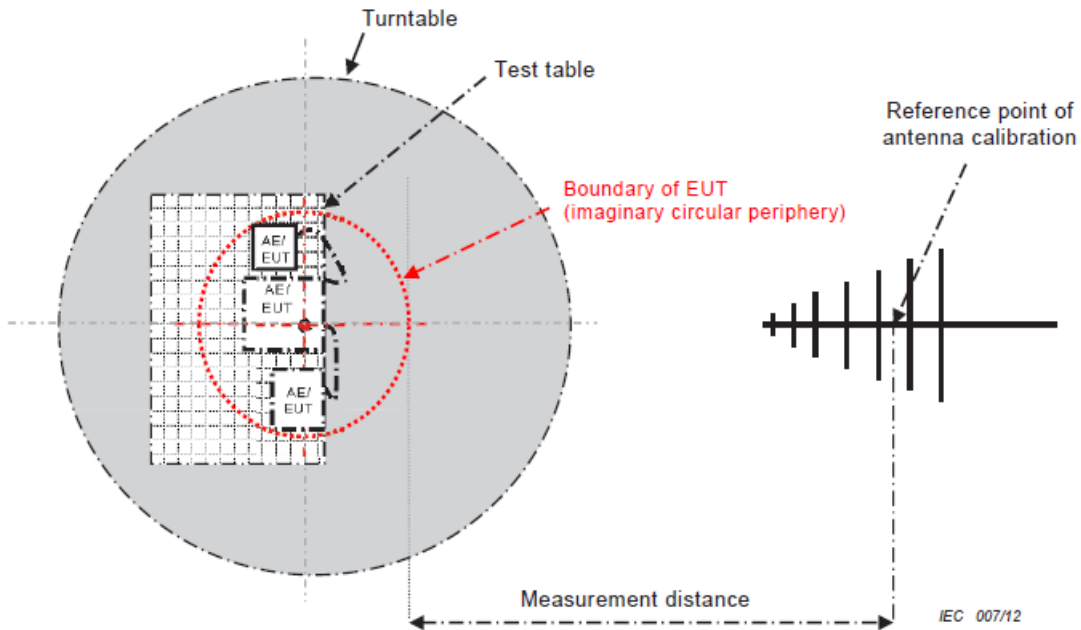

- 34 -

CISPR 32 © IEC:2012

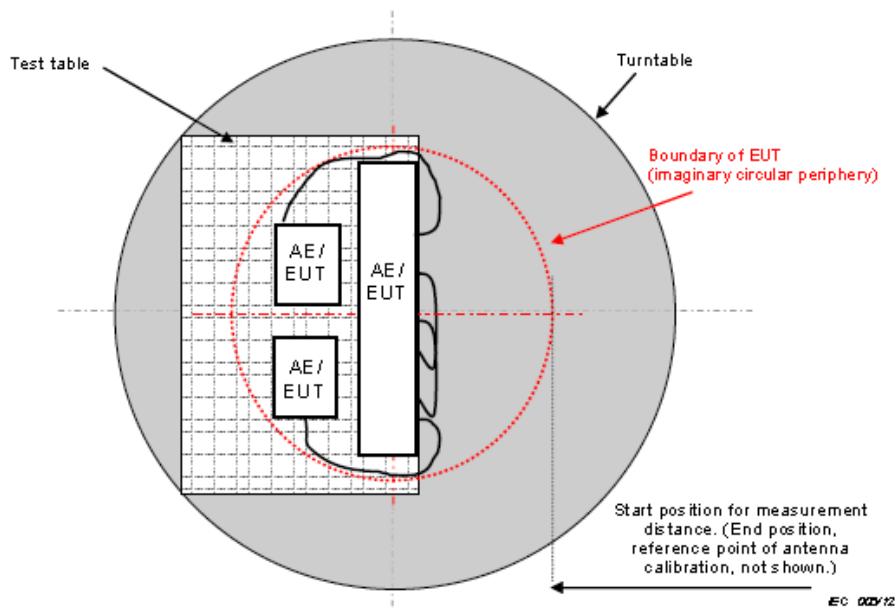
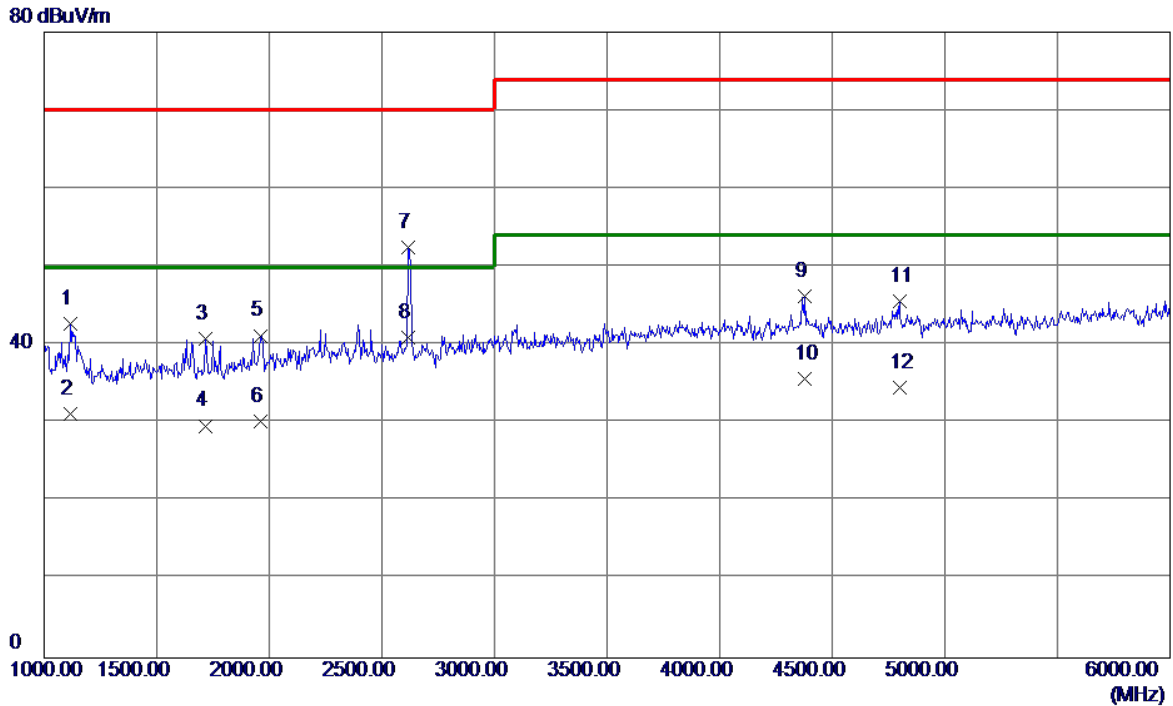

Figure C.2 – Boundary of EUT, Local AE and associated cabling

3.2.7 TEST RESULTS (ABOVE 1 GHZ)

Test Voltage	AC 230V/50Hz	Polarization	Vertical
Test Mode	HDMI 1920*1080/60Hz 1.8m		



No.	Freq. MHz	Reading Level dBuV/m	Correct Factor dB	Measure ment dBuV/m	Limit dBuV/m	Margin dB	Detector
1	1117.5000	47.30	-4.63	42.67	70.00	-27.33	Peak
2	1117.5000	35.88	-4.63	31.25	50.00	-18.75	AVG
3	1715.0000	42.46	-1.61	40.85	70.00	-29.15	Peak
4	1715.0000	31.29	-1.61	29.68	50.00	-20.32	AVG
5	1962.5000	41.21	-0.01	41.20	70.00	-28.80	Peak
6	1962.5000	30.25	-0.01	30.24	50.00	-19.76	AVG
7	2617.5000	49.93	2.57	52.50	70.00	-17.50	Peak
8 *	2617.5000	38.45	2.57	41.02	50.00	-8.98	AVG
9	4380.0000	37.38	8.90	46.28	74.00	-27.72	Peak
10	4380.0000	26.74	8.90	35.64	54.00	-18.36	AVG
11	4797.5000	35.85	9.74	45.59	74.00	-28.41	Peak
12	4797.5000	24.84	9.74	34.58	54.00	-19.42	AVG

Test Voltage	AC 230V/50Hz	Polarization	Horizontal
Test Mode	HDMI 1920*1080/60Hz 1.8m		

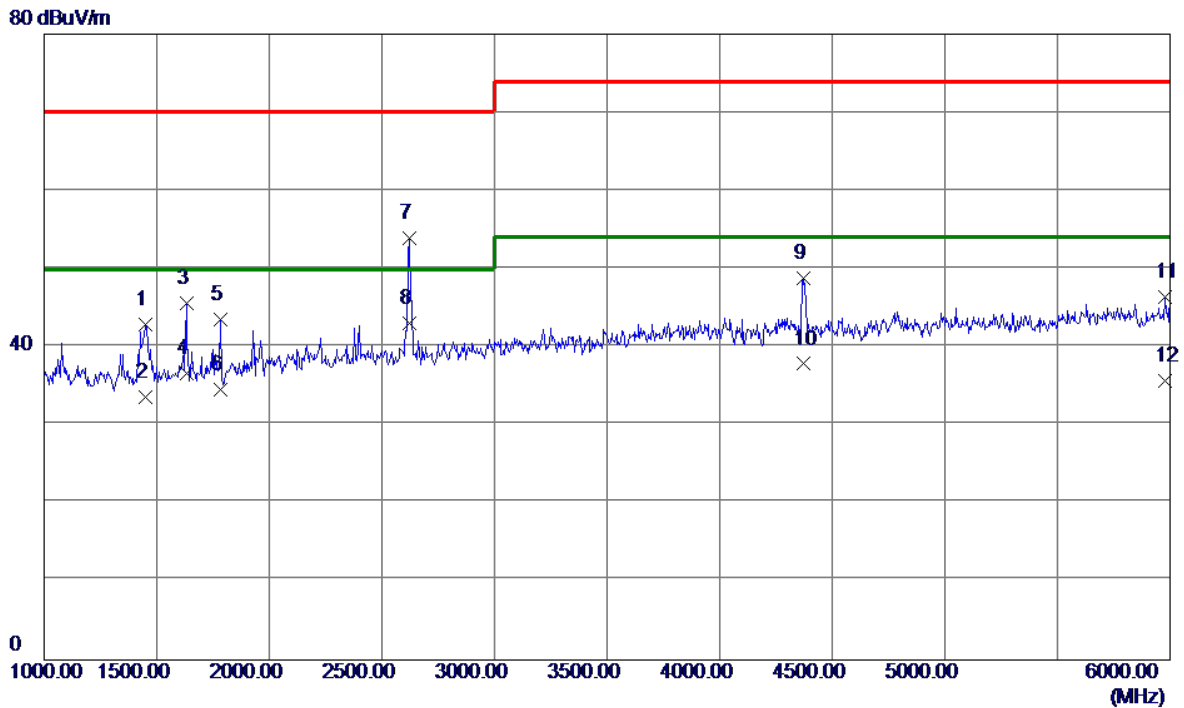

No.	Freq. MHz	Reading Level dBuV/m	Correct Factor dB	Measure ment dBuV/m	Limit dBuV/m	Margin dB	Detector
1	1450.0000	46.05	-3.21	42.84	70.00	-27.16	Peak
2	1450.0000	36.82	-3.21	33.61	50.00	-16.39	AVG
3	1632.5000	47.66	-2.14	45.52	70.00	-24.48	Peak
4	1632.5000	38.73	-2.14	36.59	50.00	-13.41	AVG
5	1782.5000	44.72	-1.17	43.55	70.00	-26.45	Peak
6	1782.5000	35.68	-1.17	34.51	50.00	-15.49	AVG
7	2622.5000	51.31	2.60	53.91	70.00	-16.09	Peak
8 *	2622.5000	40.38	2.60	42.98	50.00	-7.02	AVG
9	4372.5000	39.88	8.89	48.77	74.00	-25.23	Peak
10	4372.5000	28.95	8.89	37.84	54.00	-16.16	AVG
11	5977.5000	33.28	13.08	46.36	74.00	-27.64	Peak
12	5977.5000	22.54	13.08	35.62	54.00	-18.38	AVG

Test Voltage	AC 230V/50Hz	Polarization	Vertical
Test Mode	DP 1920*1080/144Hz 1.8m		

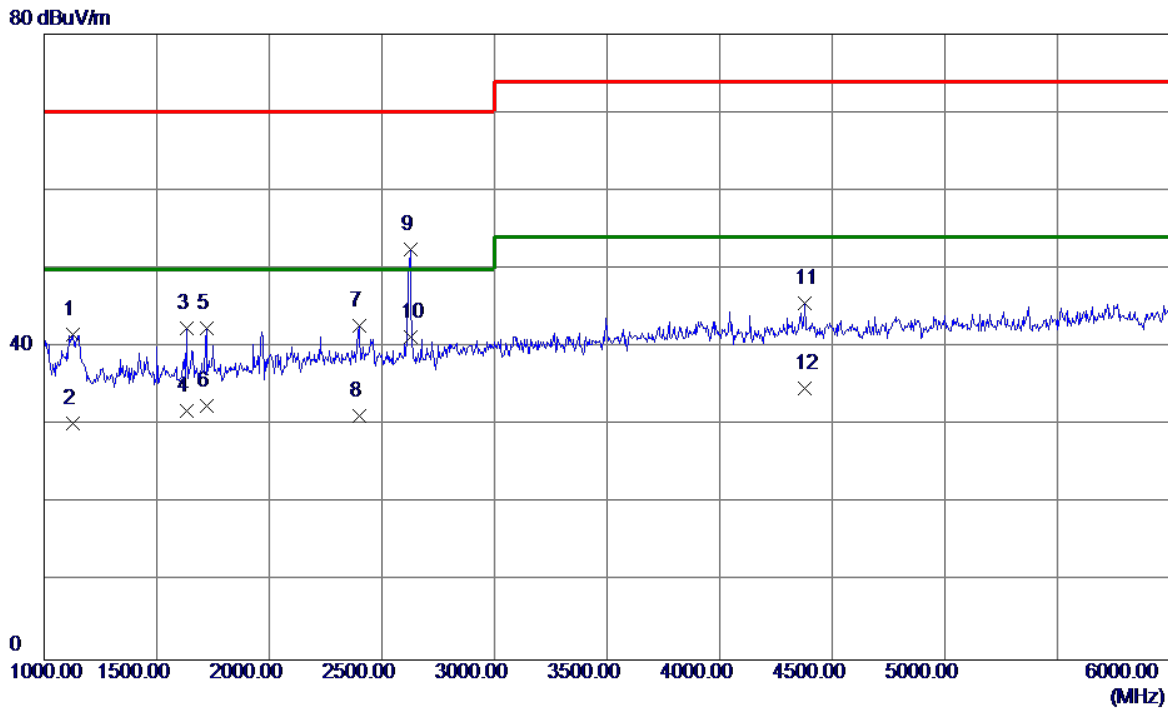

No.	Freq. MHz	Reading Level dBuV/m	Correct Factor dB	Measure ment dBuV/m	Limit dBuV/m	Margin dB	Detector
1	1127.5000	46.18	-4.59	41.59	70.00	-28.41	Peak
2	1127.5000	34.81	-4.59	30.22	50.00	-19.78	AVG
3	1632.5000	44.61	-2.14	42.47	70.00	-27.53	Peak
4	1632.5000	34.00	-2.14	31.86	50.00	-18.14	AVG
5	1722.5000	44.02	-1.56	42.46	70.00	-27.54	Peak
6	1722.5000	34.10	-1.56	32.54	50.00	-17.46	AVG
7	2397.5000	41.07	1.65	42.72	70.00	-27.28	Peak
8	2397.5000	29.60	1.65	31.25	50.00	-18.75	AVG
9	2627.5000	49.80	2.62	52.42	70.00	-17.58	Peak
10 *	2627.5000	38.63	2.62	41.25	50.00	-8.75	AVG
11	4380.0000	36.72	8.90	45.62	74.00	-28.38	Peak
12	4380.0000	25.88	8.90	34.78	54.00	-19.22	AVG

Test Voltage	AC 230V/50Hz	Polarization	Horizontal
Test Mode	DP 1920*1080/144Hz 1.8m		

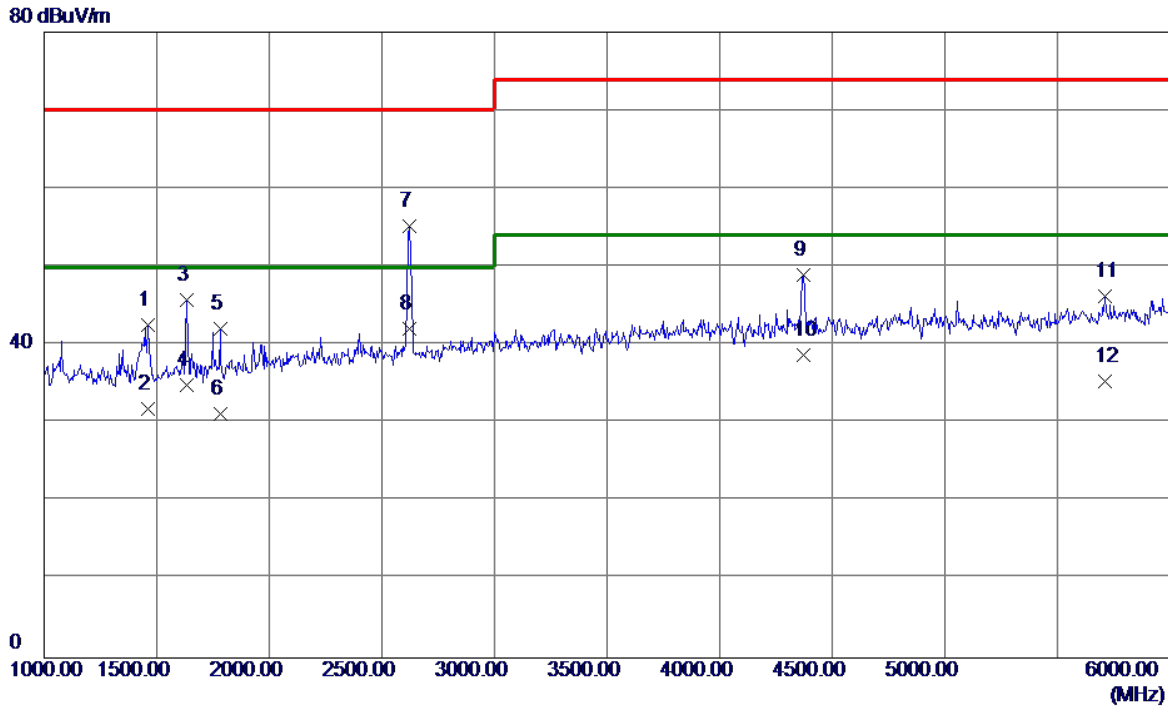

No.	Freq. MHz	Reading Level dBuV/m	Correct Factor dB	Measure ment dBuV/m	Limit dBuV/m	Margin dB	Detector
1	1462.5000	45.75	-3.15	42.60	70.00	-27.40	Peak
2	1462.5000	35.01	-3.15	31.86	50.00	-18.14	AVG
3	1632.5000	47.85	-2.14	45.71	70.00	-24.29	Peak
4	1632.5000	37.08	-2.14	34.94	50.00	-15.06	AVG
5	1782.5000	43.24	-1.17	42.07	70.00	-27.93	Peak
6	1782.5000	32.43	-1.17	31.26	50.00	-18.74	AVG
7	2620.0000	52.65	2.58	55.23	70.00	-14.77	Peak
8 *	2620.0000	39.53	2.58	42.11	50.00	-7.89	AVG
9	4370.0000	40.12	8.88	49.00	74.00	-25.00	Peak
10	4370.0000	29.88	8.88	38.76	54.00	-15.24	AVG
11	5710.0000	34.06	12.16	46.22	74.00	-27.78	Peak
12	5710.0000	23.26	12.16	35.42	54.00	-18.58	AVG

Test Voltage	AC 230V/50Hz	Polarization	Vertical
Test Mode	HDMI1 1080P 1.8m		

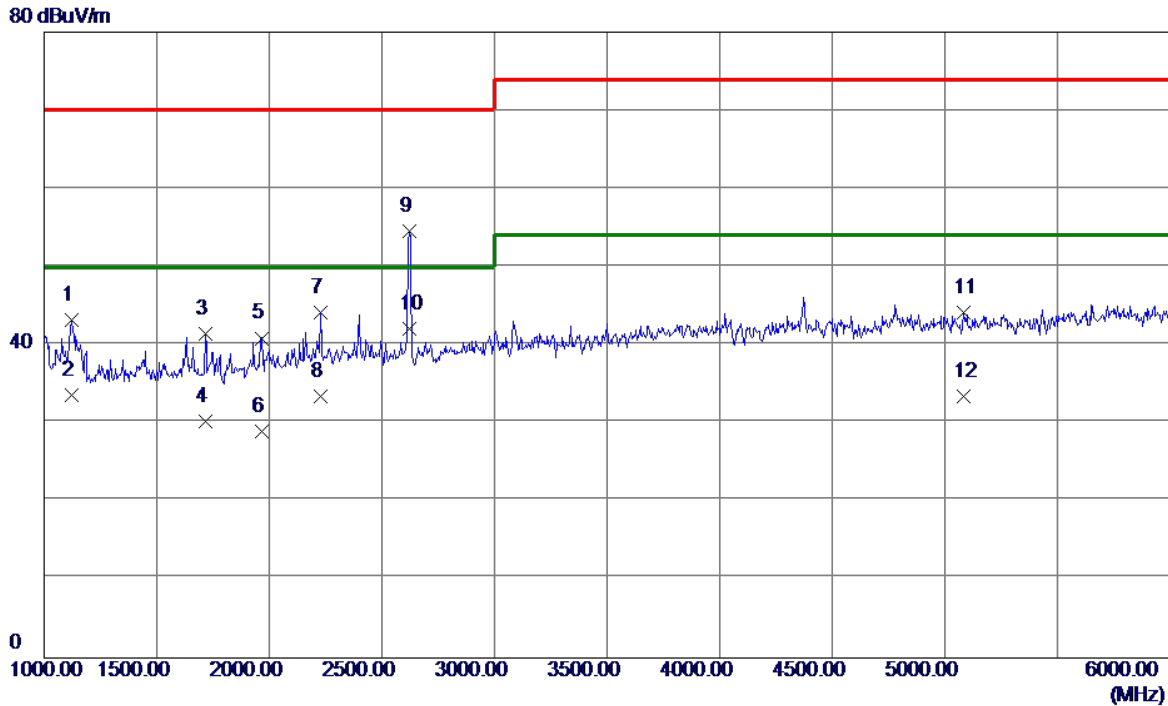

No.	Freq. MHz	Reading Level dBuV/m	Correct Factor dB	Measure ment dBuV/m	Limit dBuV/m	Margin dB	Detector
1	1122.5000	47.88	-4.61	43.27	70.00	-26.73	Peak
2	1122.5000	38.23	-4.61	33.62	50.00	-16.38	AVG
3	1715.0000	43.09	-1.61	41.48	70.00	-28.52	Peak
4	1715.0000	31.82	-1.61	30.21	50.00	-19.79	AVG
5	1967.5000	40.86	0.02	40.88	70.00	-29.12	Peak
6	1967.5000	28.96	0.02	28.98	50.00	-21.02	AVG
7	2227.5000	43.05	1.04	44.09	70.00	-25.91	Peak
8	2227.5000	32.43	1.04	33.47	50.00	-16.53	AVG
9	2620.0000	51.96	2.58	54.54	70.00	-15.46	Peak
10 *	2620.0000	39.55	2.58	42.13	50.00	-7.87	AVG
11	5082.5000	33.74	10.38	44.12	74.00	-29.88	Peak
12	5082.5000	23.13	10.38	33.51	54.00	-20.49	AVG

Test Voltage	AC 230V/50Hz	Polarization	Horizontal
Test Mode	HDMI1 1080P 1.8m		

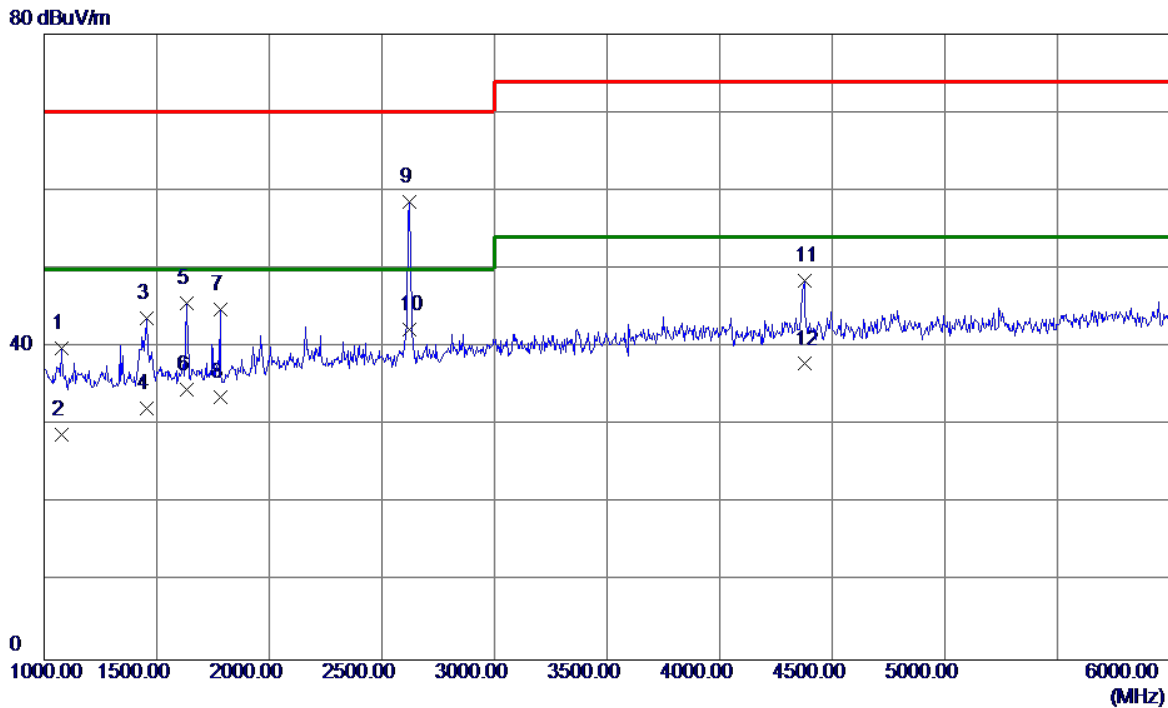

No.	Freq. MHz	Reading Level dBuV/m	Correct Factor dB	Measure ment dBuV/m	Limit dBuV/m	Margin dB	Detector
1	1077.5000	44.71	-4.81	39.90	70.00	-30.10	Peak
2	1077.5000	33.57	-4.81	28.76	50.00	-21.24	AVG
3	1457.5000	46.91	-3.17	43.74	70.00	-26.26	Peak
4	1457.5000	35.29	-3.17	32.12	50.00	-17.88	AVG
5	1632.5000	47.76	-2.14	45.62	70.00	-24.38	Peak
6	1632.5000	36.65	-2.14	34.51	50.00	-15.49	AVG
7	1782.5000	46.02	-1.17	44.85	70.00	-25.15	Peak
8	1782.5000	34.79	-1.17	33.62	50.00	-16.38	AVG
9	2620.0000	56.01	2.58	58.59	70.00	-11.41	Peak
10 *	2620.0000	39.73	2.58	42.31	50.00	-7.69	AVG
11	4377.5000	39.58	8.89	48.47	74.00	-25.53	Peak
12	4377.5000	28.95	8.89	37.84	54.00	-16.16	AVG

Test Voltage	AC 110V/60Hz	Polarization	Vertical
Test Mode	HDMI 1920*1080/60Hz 1.8m		

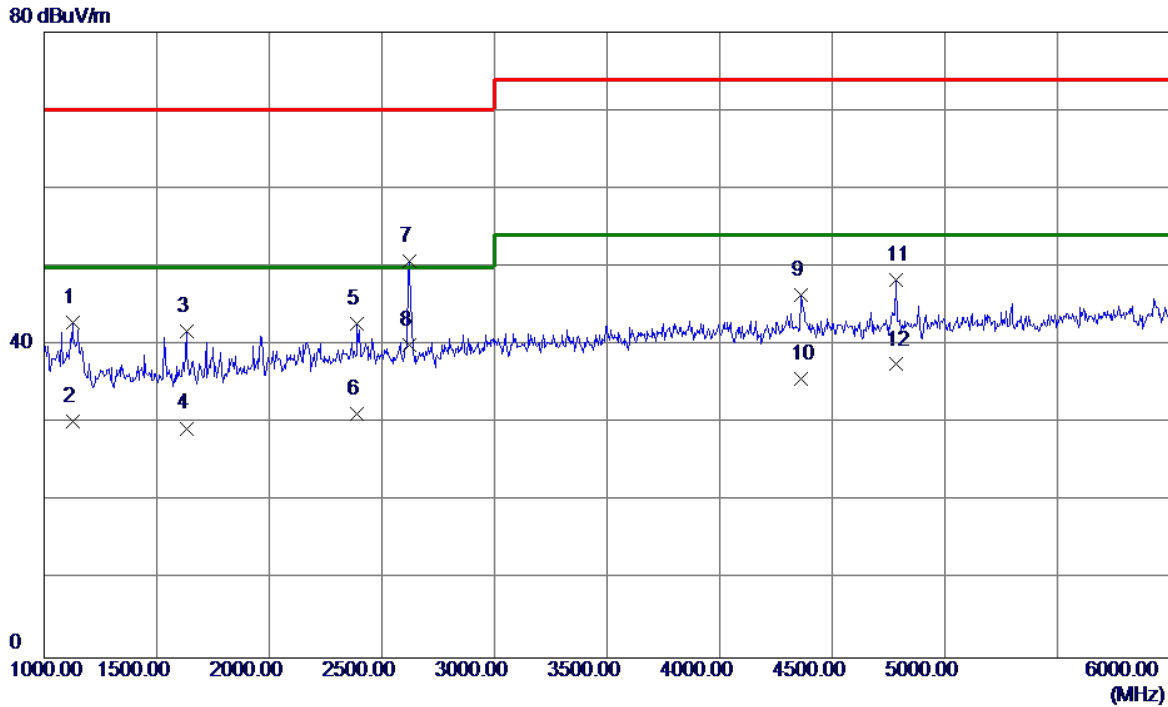

No.	Freq. MHz	Reading Level dBuV/m	Correct Factor dB	Measure ment dBuV/m	Limit dBuV/m	Margin dB	Detector
1	1127.5000	47.42	-4.59	42.83	70.00	-27.17	Peak
2	1127.5000	34.85	-4.59	30.26	50.00	-19.74	AVG
3	1632.5000	43.97	-2.14	41.83	70.00	-28.17	Peak
4	1632.5000	31.50	-2.14	29.36	50.00	-20.64	AVG
5	2390.0000	41.08	1.63	42.71	70.00	-27.29	Peak
6	2390.0000	29.61	1.63	31.24	50.00	-18.76	AVG
7	2620.0000	48.10	2.58	50.68	70.00	-19.32	Peak
8 *	2620.0000	37.43	2.58	40.01	50.00	-9.99	AVG
9	4362.5000	37.47	8.87	46.34	74.00	-27.66	Peak
10	4362.5000	26.74	8.87	35.61	54.00	-18.39	AVG
11	4785.0000	38.61	9.71	48.32	74.00	-25.68	Peak
12	4785.0000	27.81	9.71	37.52	54.00	-16.48	AVG

Test Voltage	AC 110V/60Hz	Polarization	Horizontal
Test Mode	HDMI 1920*1080/60Hz 1.8m		

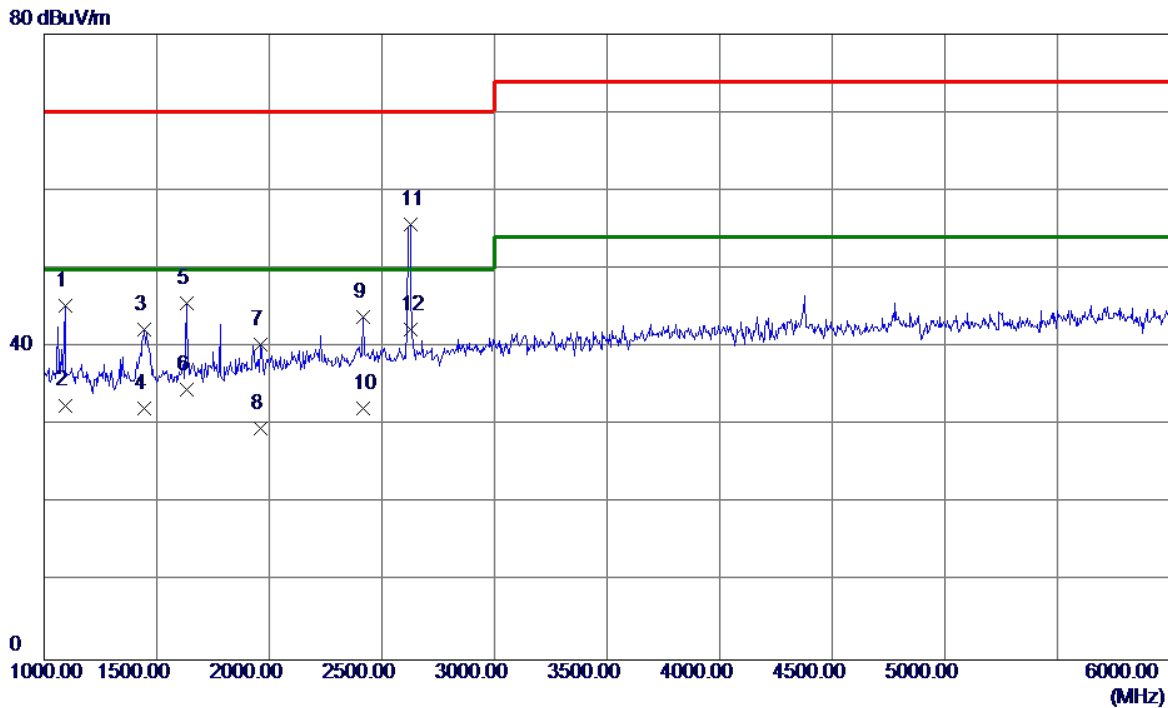

No.	Freq. MHz	Reading Level dBuV/m	Correct Factor dB	Measure ment dBuV/m	Limit dBuV/m	Margin dB	Detector
1	1092.5000	49.98	-4.74	45.24	70.00	-24.76	Peak
2	1092.5000	37.30	-4.74	32.56	50.00	-17.44	AVG
3	1445.0000	45.44	-3.23	42.21	70.00	-27.79	Peak
4	1445.0000	35.35	-3.23	32.12	50.00	-17.88	AVG
5	1632.5000	47.68	-2.14	45.54	70.00	-24.46	Peak
6	1632.5000	36.73	-2.14	34.59	50.00	-15.41	AVG
7	1962.5000	40.35	-0.01	40.34	70.00	-29.66	Peak
8	1962.5000	29.64	-0.01	29.63	50.00	-20.37	AVG
9	2415.0000	42.12	1.72	43.84	70.00	-26.16	Peak
10	2415.0000	30.50	1.72	32.22	50.00	-17.78	AVG
11	2627.5000	53.03	2.62	55.65	70.00	-14.35	Peak
12 *	2627.5000	39.69	2.62	42.31	50.00	-7.69	AVG

3.3 CONDUCTED EMISSION MEASUREMENT AT AC MAINS POWER PORTS

3.3.1 LIMITS

Requirements for conducted emissions from AC mains power ports of Class B equipment

Frequency Range MHz	Coupling Device	Detector Type / bandwidth	Class B Limits (dB(μV))
0.15 - 0.5	AMN	Quasi Peak / 9 kHz	66-56
0.5 - 5			56
5 - 30			60
0.15 - 0.5	AMN	Average / 9 kHz	56-46
0.5 - 5			46
5 - 30			50

NOTE:

(1) The test result calculated as following:

Measurement Value = Reading Level + Correct Factor

Correct Factor = Insertion Loss + Cable Loss + Attenuator Factor(if use)

Margin Level = Measurement Value – Limit Value

3.3.2 MEASUREMENT INSTRUMENTS LIST

Item	Kind of Equipment	Manufacturer	Type No.	Series Model	Calibrated until
1	50Ω Terminator	SHX	TF2-3G-A	8122901	Feb. 28, 2021
2	TWO-LINE V-NETWORK	R&S	ENV216	100526	Mar. 01, 2021
3	EMI Test Receiver	R&S	ESR3	101862	Aug. 03, 2020
4	Artificial-Mains Network	SCHWARZBECK	NSLK 8127	8127685	Mar. 01, 2021
5	TRANSIENT LIMITER	EM	EM-7600	772	Mar. 01, 2021
6	Cable	N/A	RG400	N/A(12m)	Mar. 10, 2021
7	Measurement Software	Farad	EZ-EMC Ver.NB-03A1-01	N/A	N/A

Remark: "N/A" denotes no model name, serial no. or calibration specified.

All calibration period of equipment list is one year.

3.3.3 TEST PROCEDURE

- a. The EUT was placed 0.8 meters from the horizontal ground plane with EUT being connected to the power mains through a line impedance stabilization network (LISN). All other support equipments powered from additional LISN(s). The LISN provide 50 Ohm/ 50uH of coupling impedance for the measuring instrument.
- b. Interconnecting cables that hang closer than 40 cm to the ground plane shall be folded back and forth in the center forming a bundle 30 to 40 cm long.
- c. I/O cables that are not connected to a peripheral shall be bundled in the center. The end of the cable may be terminated, if required, using the correct terminating impedance. The overall length shall not exceed 1 m.
- d. LISN at least 80 cm from nearest part of EUT chassis.
- e. For the actual test configuration, please refer to the related Item –EUT Test Photos.

3.3.4 DEVIATION FROM TEST STANDARD

No deviation

3.3.5 TEST SETUP

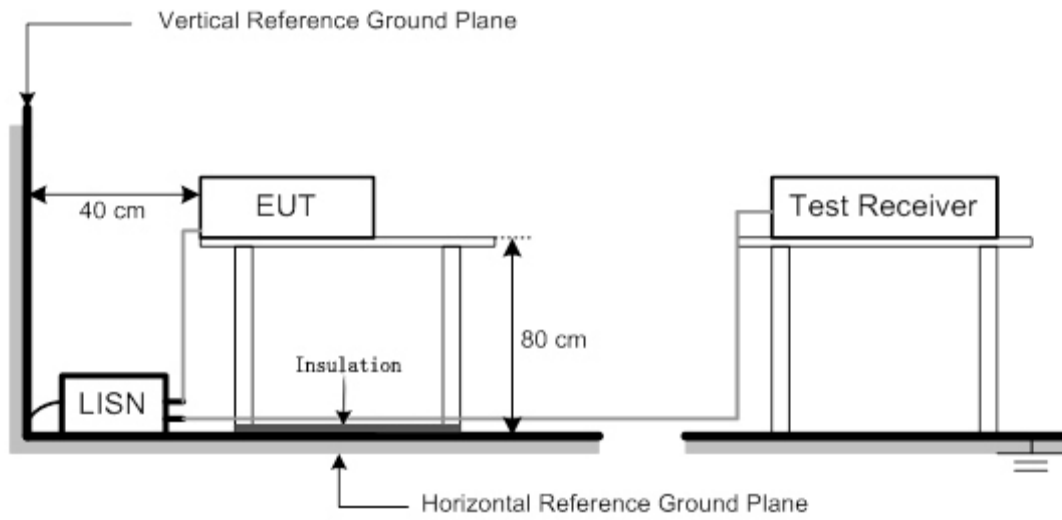

3.3.6 TEST RESULTS

Test Voltage	AC 230V/50Hz	Phase	Line
Test Mode	HDMI 1920*1080/60Hz 1.8m		

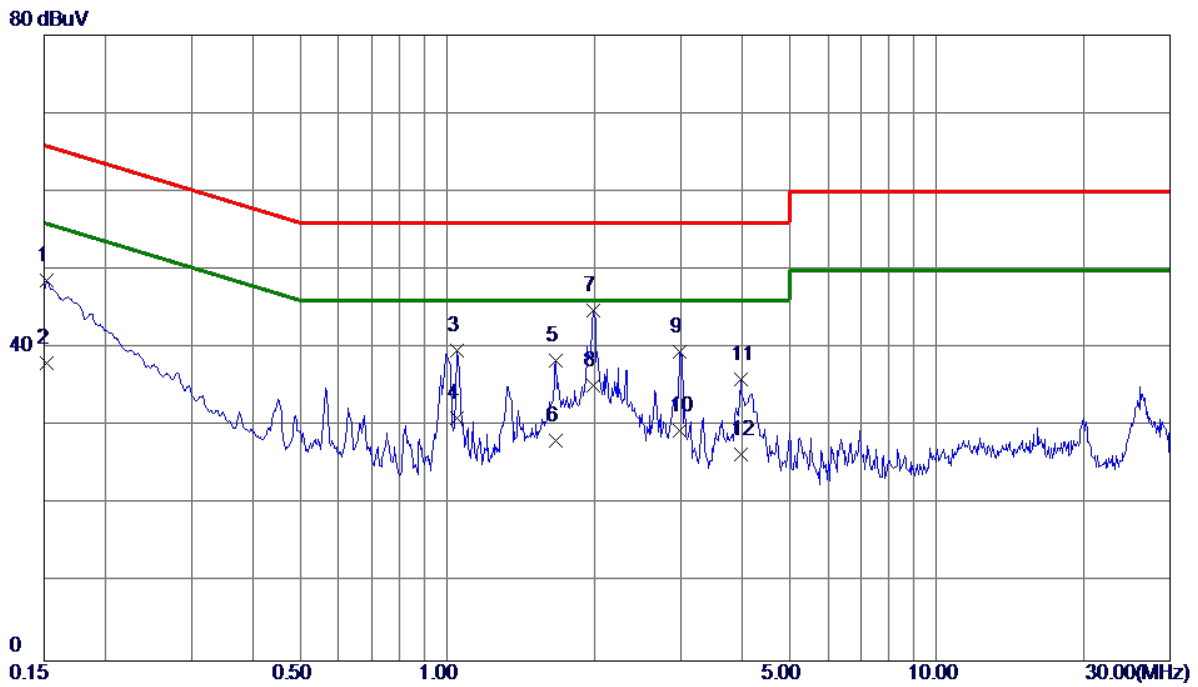

No.	Freq. MHz	Reading Level dBuV	Correct Factor dB	Measure ment dBuV	Limit dBuV	Margin dB	Detector
1	0.1522	39.01	9.59	48.60	65.88	-17.28	QP
2	0.1522	28.51	9.59	38.10	55.88	-17.78	AVG
3	1.0477	30.06	9.67	39.73	56.00	-16.27	QP
4	1.0477	21.30	9.67	30.97	46.00	-15.03	AVG
5	1.6642	28.62	9.73	38.35	56.00	-17.65	QP
6	1.6642	18.50	9.73	28.23	46.00	-17.77	AVG
7	1.9882	35.02	9.75	44.77	56.00	-11.23	QP
8 *	1.9882	25.50	9.75	35.25	46.00	-10.75	AVG
9	2.9827	29.64	9.83	39.47	56.00	-16.53	QP
10	2.9827	19.60	9.83	29.43	46.00	-16.57	AVG
11	3.9772	26.03	9.90	35.93	56.00	-20.07	QP
12	3.9772	16.50	9.90	26.40	46.00	-19.60	AVG

Test Voltage	AC 230V/50Hz	Phase	Neutral
Test Mode	HDMI 1920*1080/60Hz 1.8m		

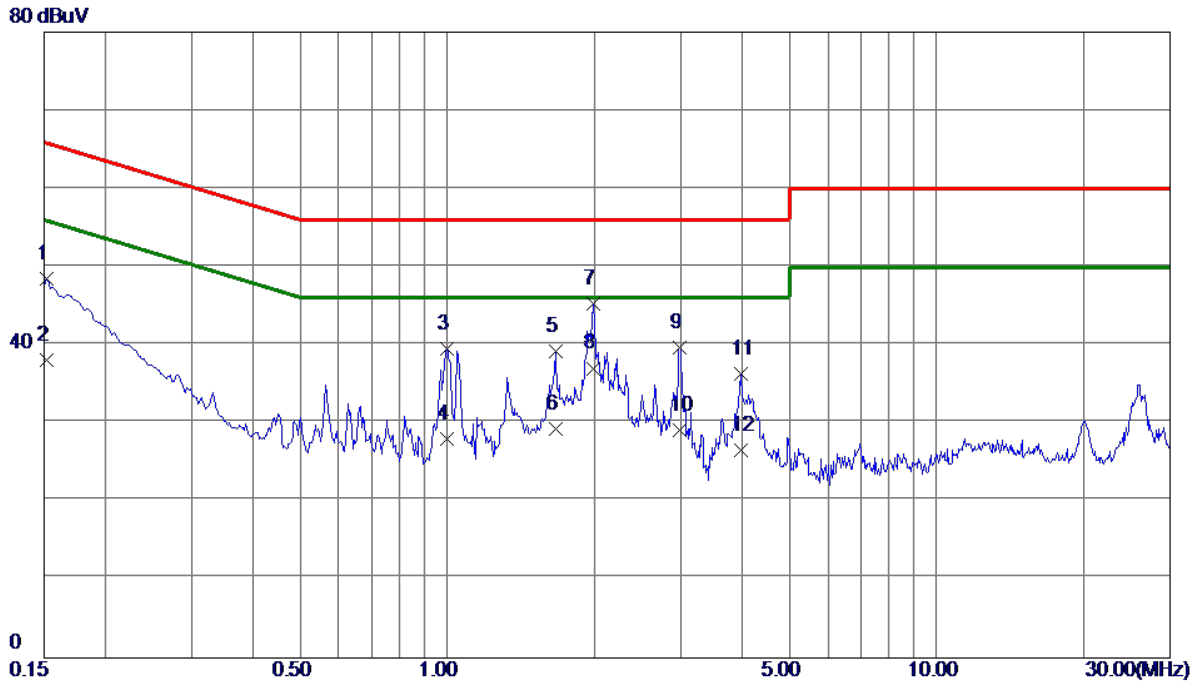

No.	Freq. MHz	Reading Level dBuV	Correct Factor dB	Measure ment dBuV	Limit dBuV	Margin dB	Detector
1	0.1522	38.89	9.56	48.45	65.88	-17.43	QP
2	0.1522	28.51	9.56	38.07	55.88	-17.81	AVG
3	0.9982	29.89	9.66	39.55	56.00	-16.45	QP
4	0.9982	18.40	9.66	28.06	46.00	-17.94	AVG
5	1.6620	29.51	9.71	39.22	56.00	-16.78	QP
6	1.6620	19.50	9.71	29.21	46.00	-16.79	AVG
7	1.9860	35.53	9.74	45.27	56.00	-10.73	QP
8 *	1.9860	27.30	9.74	37.04	46.00	-8.96	AVG
9	2.9895	29.81	9.82	39.63	56.00	-16.37	QP
10	2.9895	19.30	9.82	29.12	46.00	-16.88	AVG
11	3.9863	26.40	9.89	36.29	56.00	-19.71	QP
12	3.9863	16.60	9.89	26.49	46.00	-19.51	AVG

Test Voltage	AC 230V/50Hz	Phase	Line
Test Mode	DP 1920*1080/144Hz 1.8m		

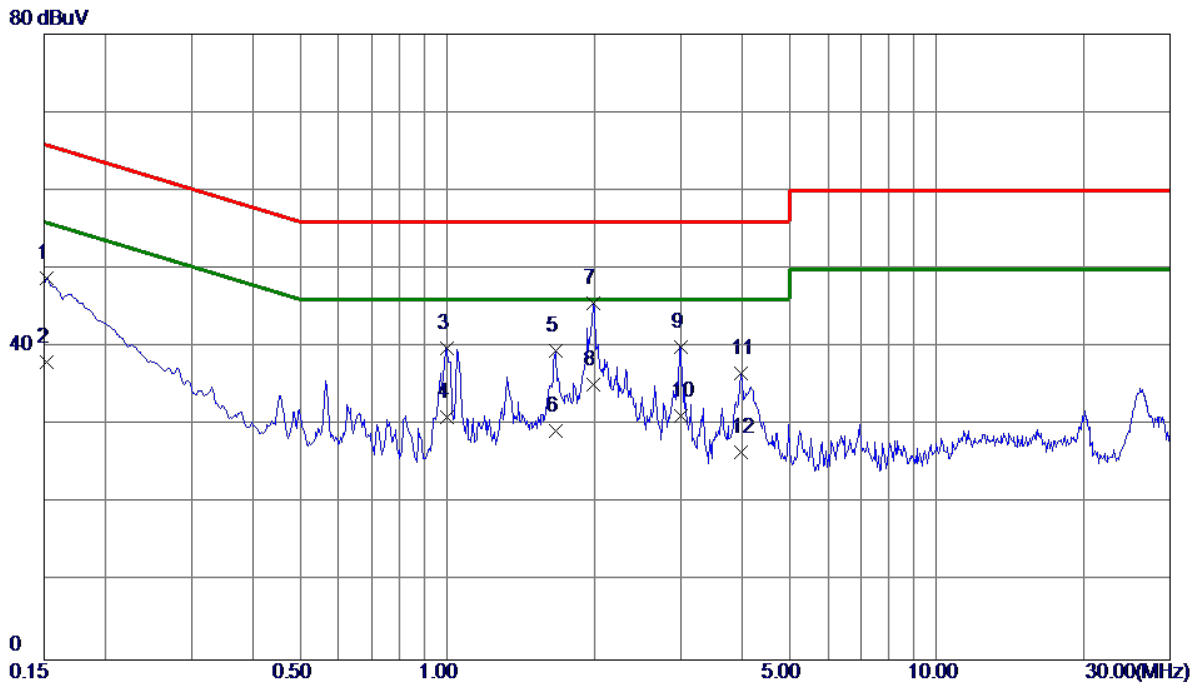

No.	Freq. MHz	Reading Level dBuV	Correct Factor dB	Measure ment dBuV	Limit dBuV	Margin dB	Detector
1	0.1522	39.28	9.59	48.87	65.88	-17.01	QP
2	0.1522	28.51	9.59	38.10	55.88	-17.78	AVG
3	0.9982	30.20	9.67	39.87	56.00	-16.13	QP
4	0.9982	21.40	9.67	31.07	46.00	-14.93	AVG
5	1.6620	29.80	9.73	39.53	56.00	-16.47	QP
6	1.6620	19.60	9.73	29.33	46.00	-16.67	AVG
7 *	1.9928	35.87	9.75	45.62	56.00	-10.38	QP
8	1.9928	25.50	9.75	35.25	46.00	-10.75	AVG
9	3.0053	30.20	9.83	40.03	56.00	-15.97	QP
10	3.0053	21.40	9.83	31.23	46.00	-14.77	AVG
11	3.9863	26.74	9.90	36.64	56.00	-19.36	QP
12	3.9863	16.60	9.90	26.50	46.00	-19.50	AVG

Test Voltage	AC 230V/50Hz	Phase	Neutral
Test Mode	DP 1920*1080/144Hz 1.8m		

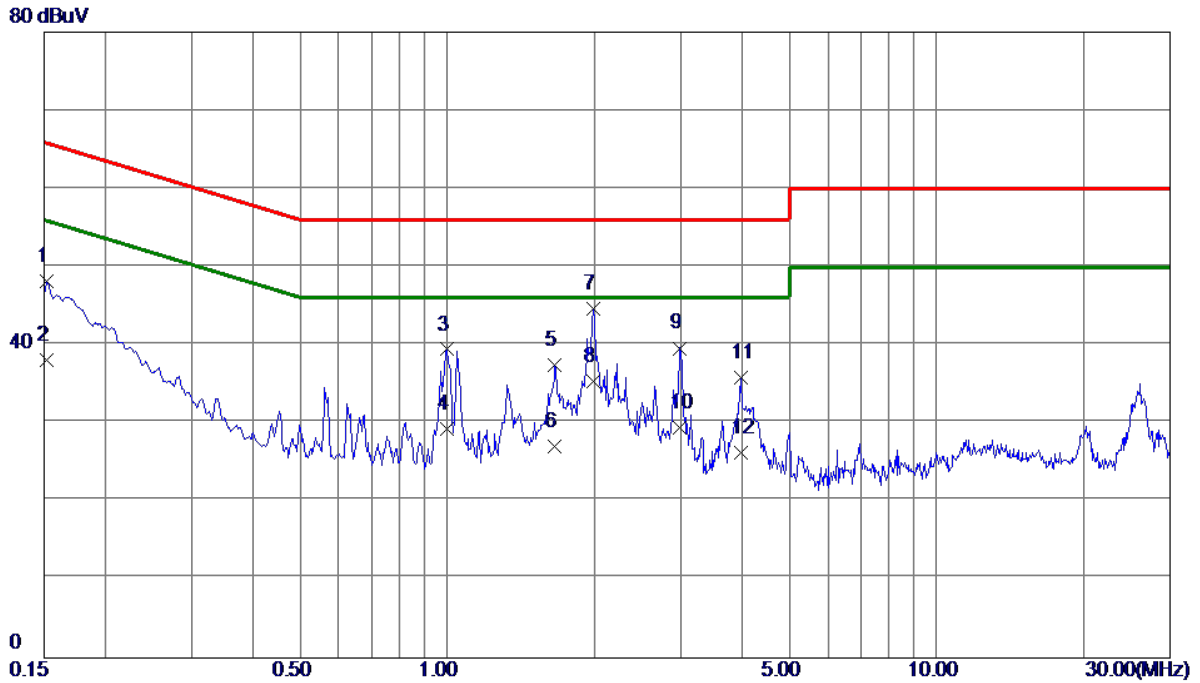

No.	Freq. MHz	Reading Level dBuV	Correct Factor dB	Measurement dBuV	Limit dBuV	Margin dB	Detector
1	0.1522	38.54	9.56	48.10	65.88	-17.78	QP
2	0.1522	28.51	9.56	38.07	55.88	-17.81	AVG
3	0.9982	29.78	9.66	39.44	56.00	-16.56	QP
4	0.9982	19.60	9.66	29.26	46.00	-16.74	AVG
5	1.6575	27.74	9.71	37.45	56.00	-18.55	QP
6	1.6575	17.40	9.71	27.11	46.00	-18.89	AVG
7	1.9883	34.92	9.74	44.66	56.00	-11.34	QP
8 *	1.9883	25.60	9.74	35.34	46.00	-10.66	AVG
9	2.9895	29.78	9.82	39.60	56.00	-16.40	QP
10	2.9895	19.60	9.82	29.42	46.00	-16.58	AVG
11	3.9930	26.02	9.89	35.91	56.00	-20.09	QP
12	3.9930	16.30	9.89	26.19	46.00	-19.81	AVG

Test Voltage	AC 230V/50Hz	Phase	Line
Test Mode	HDMI1 1080P 1.8m		

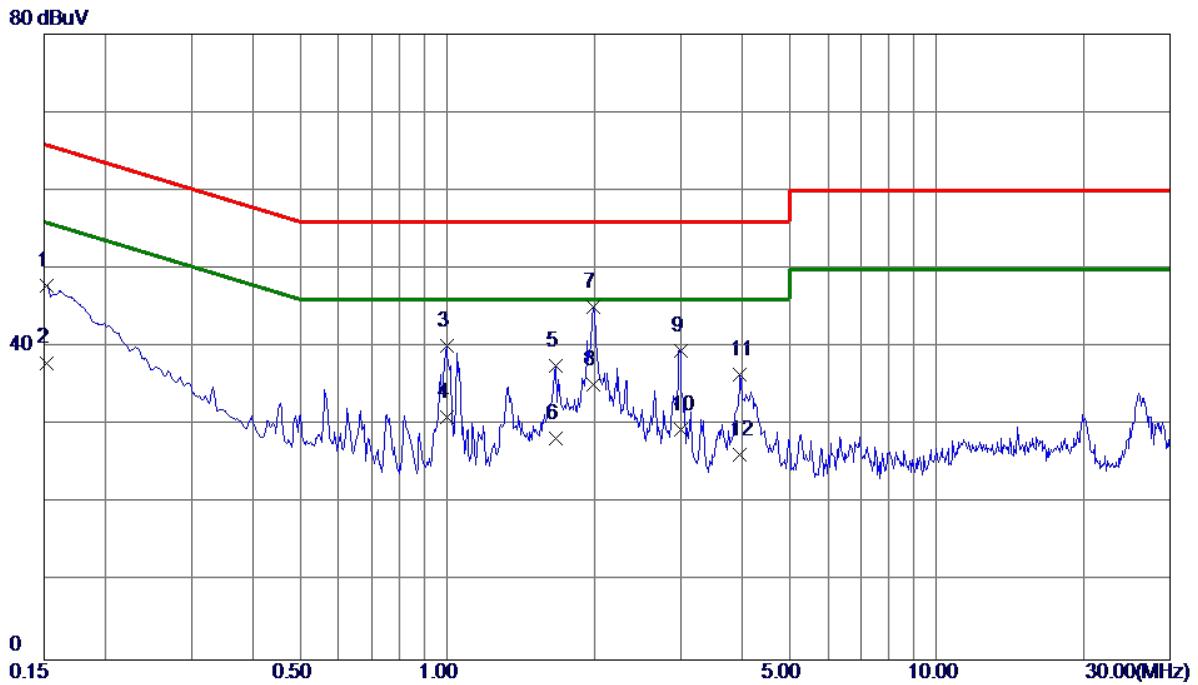

No.	Freq. MHz	Reading Level dBuV	Correct Factor dB	Measure ment dBuV	Limit dBuV	Margin dB	Detector
1	0.1522	38.27	9.59	47.86	65.88	-18.02	QP
2	0.1522	28.41	9.59	38.00	55.88	-17.88	AVG
3	0.9982	30.55	9.67	40.22	56.00	-15.78	QP
4	0.9982	21.40	9.67	31.07	46.00	-14.93	AVG
5	1.6643	27.90	9.73	37.63	56.00	-18.37	QP
6	1.6643	18.60	9.73	28.33	46.00	-17.67	AVG
7	1.9860	35.36	9.75	45.11	56.00	-10.89	QP
8 *	1.9860	25.50	9.75	35.25	46.00	-10.75	AVG
9	3.0008	29.71	9.83	39.54	56.00	-16.46	QP
10	3.0008	19.60	9.83	29.43	46.00	-16.57	AVG
11	3.9705	26.60	9.90	36.50	56.00	-19.50	QP
12	3.9705	16.30	9.90	26.20	46.00	-19.80	AVG

Test Voltage	AC 230V/50Hz	Phase	Neutral
Test Mode	HDMI1 1080P 1.8m		

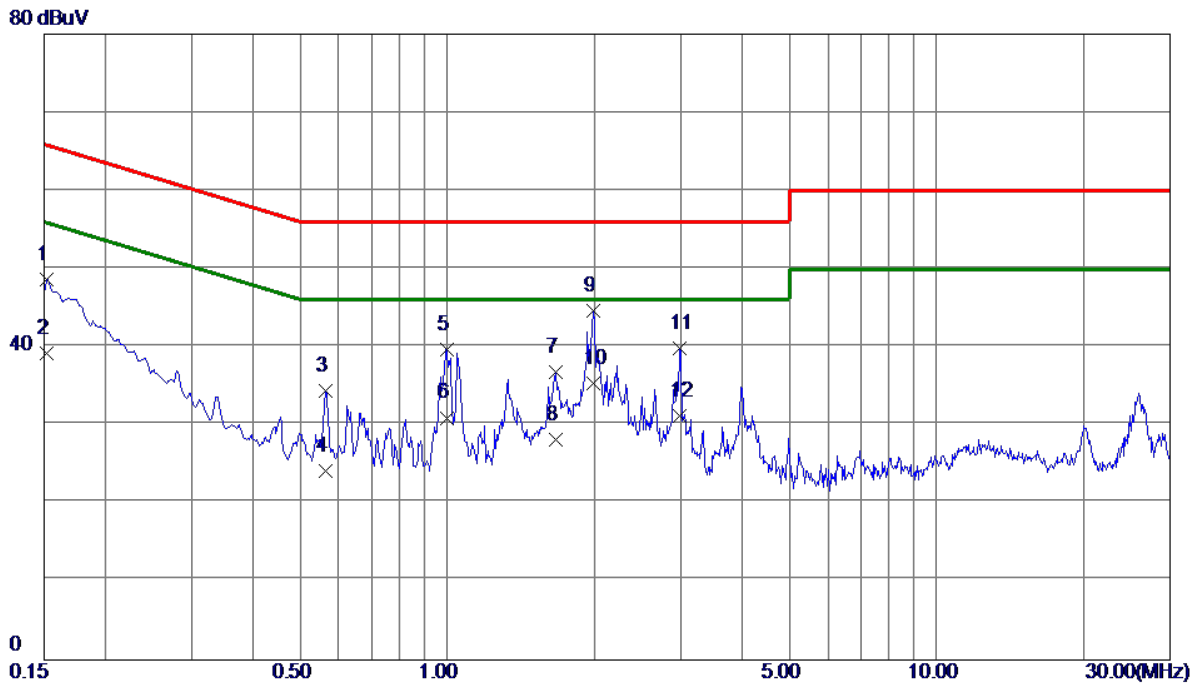

No.	Freq. MHz	Reading Level dBuV	Correct Factor dB	Measure ment dBuV	Limit dBuV	Margin dB	Detector
1	0.1522	39.09	9.56	48.65	65.88	-17.23	QP
2	0.1522	29.61	9.56	39.17	55.88	-16.71	AVG
3	0.5639	24.82	9.61	34.43	56.00	-21.57	QP
4	0.5639	14.60	9.61	24.21	46.00	-21.79	AVG
5	0.9982	30.10	9.66	39.76	56.00	-16.24	QP
6	0.9982	21.30	9.66	30.96	46.00	-15.04	AVG
7	1.6643	27.08	9.71	36.79	56.00	-19.21	QP
8	1.6643	18.50	9.71	28.21	46.00	-17.79	AVG
9	1.9928	34.92	9.74	44.66	56.00	-11.34	QP
10 *	1.9928	25.60	9.74	35.34	46.00	-10.66	AVG
11	2.9828	30.02	9.82	39.84	56.00	-16.16	QP
12	2.9828	21.40	9.82	31.22	46.00	-14.78	AVG

Test Voltage	AC 110V/60Hz	Phase	Line
Test Mode	HDMI 1920*1080/60Hz 1.8m		

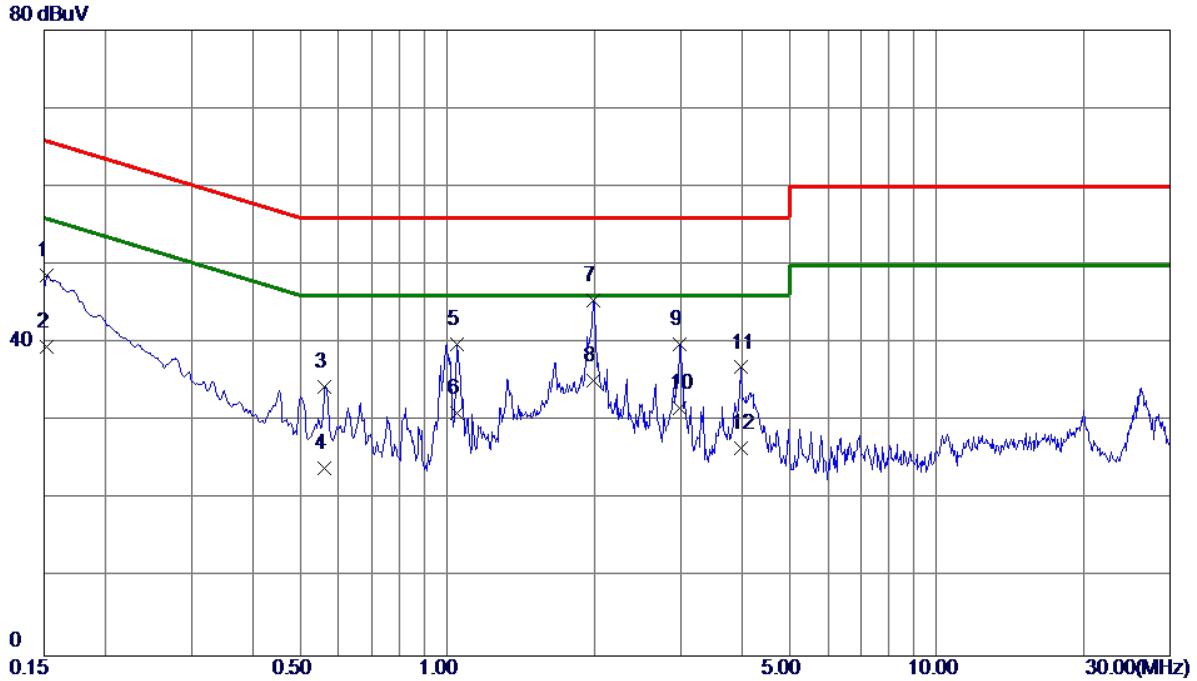

No.	Freq. MHz	Reading Level dBuV	Correct Factor dB	Measure ment dBuV	Limit dBuV	Margin dB	Detector
1	0.1522	39.10	9.59	48.69	65.88	-17.19	QP
2	0.1522	29.91	9.59	39.50	55.88	-16.38	AVG
3	0.5617	24.71	9.62	34.33	56.00	-21.67	QP
4	0.5617	14.40	9.62	24.02	46.00	-21.98	AVG
5	1.0477	30.20	9.67	39.87	56.00	-16.13	QP
6	1.0477	21.30	9.67	30.97	46.00	-15.03	AVG
7 *	1.9860	35.64	9.75	45.39	56.00	-10.61	QP
8	1.9860	25.50	9.75	35.25	46.00	-10.75	AVG
9	2.9828	30.06	9.83	39.89	56.00	-16.11	QP
10	2.9828	21.80	9.83	31.63	46.00	-14.37	AVG
11	3.9885	26.98	9.90	36.88	56.00	-19.12	QP
12	3.9885	16.60	9.90	26.50	46.00	-19.50	AVG

Test Voltage	AC 110V/60Hz	Phase	Neutral
Test Mode	HDMI 1920*1080/60Hz 1.8m		

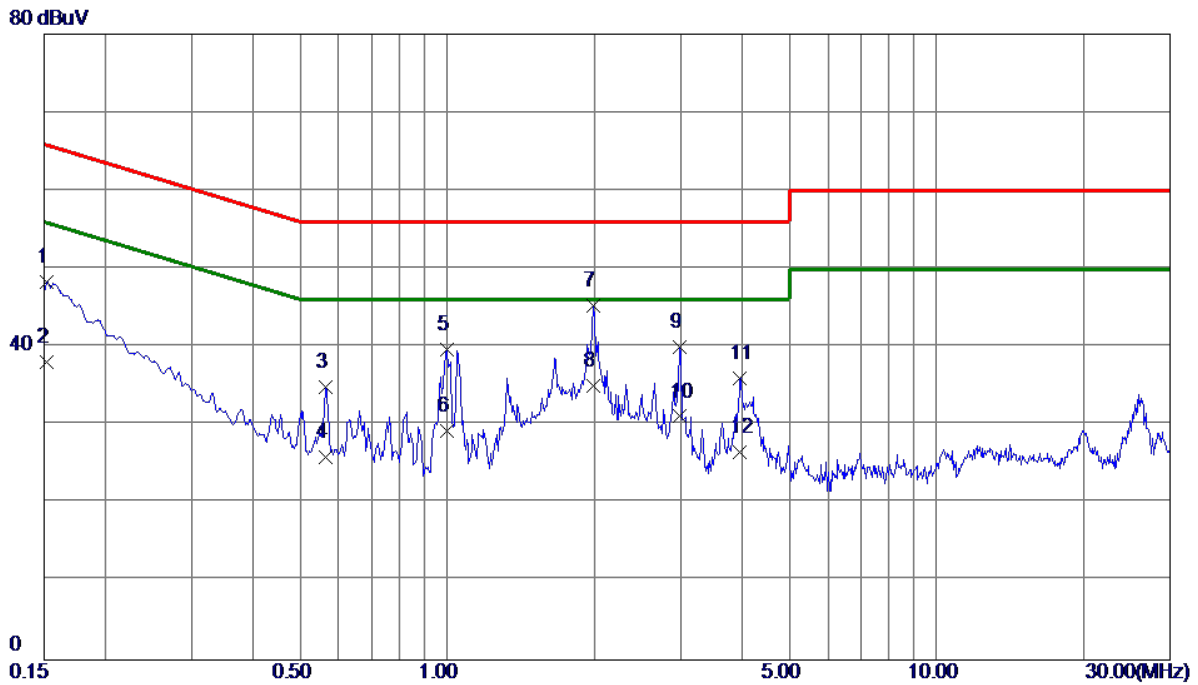

No.	Freq. MHz	Reading Level dBuV	Correct Factor dB	Measure ment dBuV	Limit dBuV	Margin dB	Detector
1	0.1522	38.82	9.56	48.38	65.88	-17.50	QP
2	0.1522	28.51	9.56	38.07	55.88	-17.81	AVG
3	0.5639	25.33	9.61	34.94	56.00	-21.06	QP
4	0.5639	16.30	9.61	25.91	46.00	-20.09	AVG
5	0.9982	29.97	9.66	39.63	56.00	-16.37	QP
6	0.9982	19.60	9.66	29.26	46.00	-16.74	AVG
7 *	1.9883	35.59	9.74	45.33	56.00	-10.67	QP
8	1.9883	25.30	9.74	35.04	46.00	-10.96	AVG
9	2.9760	30.12	9.82	39.94	56.00	-16.06	QP
10	2.9760	21.30	9.82	31.12	46.00	-14.88	AVG
11	3.9683	26.15	9.89	36.04	56.00	-19.96	QP
12	3.9683	16.60	9.89	26.49	46.00	-19.51	AVG

4. EMC EMISSION TEST- EN 55032:2015+AC:2016

4.1 RADIATED EMISSIONS UP TO 1 GHZ

4.1.1 LIMITS

Class B equipment up to 1000MHz

Frequency Range MHz	Measurement			Class B limits dB(μV/m)
	Facility	Distance m	Detector type/ bandwidth	
30 - 230	SAC	10	Quasi peak / 120 kHz	30
230 - 1000				37

Notes:

- (1) The limit for radiated test was performed according to as following: EN 55032
- (2) The tighter limit applies at the band edges.
- (3) Emission level (dBuV/m)=20log Emission level (uV/m).
- (4) The test result calculated as following:
 Measurement Value = Reading Level + Correct Factor
 Correct Factor = Antenna Factor + Cable Loss - Amplifier Gain(if use)
 Margin Level = Measurement Value - Limit Value

4.1.2 MEASUREMENT INSTRUMENTS LIST

Up to 1GHz:

Item	Kind of Equipment	Manufacturer	Type No.	Series Model	Calibrated until
1	Receiver	Keysight	N9038A	MY54450004	Aug. 03, 2020
2	MXE EMI Receiver	Agilent	N9038A	MY53220133	Feb. 28, 2021
3	Pre-Amplifier	EMC INSTRUMENT	EMC 9135	980284	Mar. 01, 2021
4	Pre-Amplifier	EMC INSTRUMENT	EMC 9135	980283	Mar. 01, 2021
5	Trilog-Broadband Antenna	Schwarzbeck	VULB9168	946	Oct. 26, 2020
6	Trilog-Broadband Antenna	Schwarzbeck	VULB9168	947	Dec. 02, 2020
7	Cable	emci	LMR-400(5m+11 m+15m)	N/A	Nov. 22, 2020
8	Cable	emci	LMR-400(5m+8m +8m)	N/A	Nov. 22, 2020
9	Measurement Software	Farad	EZ-EMC Ver.BTL-2ANT-1	N/A	N/A
10	Multi-Device Controller	ETS-Lindgren	2090	N/A	N/A
11	Attenuator	EMCI	EMCI-N-6-06	N0670	Dec. 02, 2020
12	Attenuator	EMCI	EMCI-N-6-06	N0671	Oct. 26, 2020

Remark: "N/A" denotes no model no., no serial no. or no calibration specified.

All calibration period of equipment list is one year.

4.1.3 TEST PROCEDURE

- The measuring distance of 10 m shall be used for measurements. The EUT was placed on the top of a rotating table 0.8 meter above the ground at a 10 meter semi-anechoic chamber. The table was rotated 360 degrees to determine the position of the highest radiation.(below 1GHz).
- The height of the equipment or of the substitution antenna shall be 0.8 m, the height of the test antenna shall vary between 1 m to 4 m. Both horizontal and vertical polarizations of the antenna are set to make the measurement.
- The initial step in collecting radiated emission data is a receiver peak detector mode pre-scanning the measurement frequency range. Significant peaks are then marked and then Quasi Peak detector mode re-measured.
- All readings are Peak unless otherwise stated QP in column of Note. Peak denotes that the Peak reading compliance with the QP Limits and then QP Mode measurement didn't perform.
(below 1GHz)
- For the actual test configuration, please refer to the related Item - Block Diagram of system tested.

4.1.4 DEVIATION FROM TEST STANDARD

No deviation

4.1.5 TEST SETUP

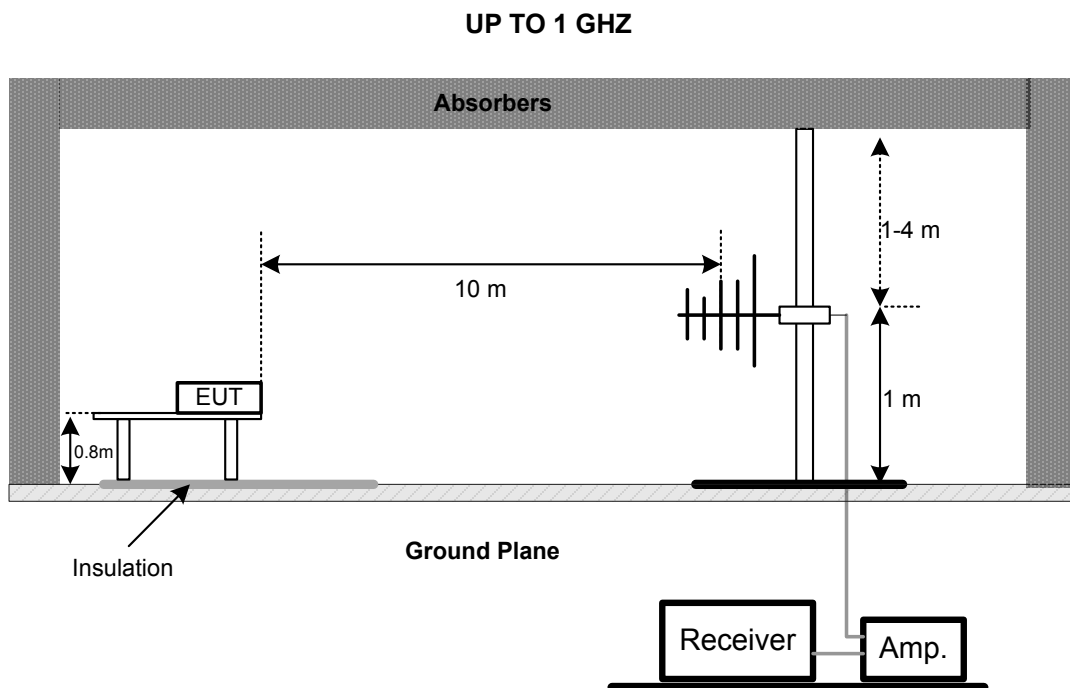

Note: The antenna can be moved between 1 to 4 meters above the ground.

4.1.6 MEASUREMENT DISTANCE

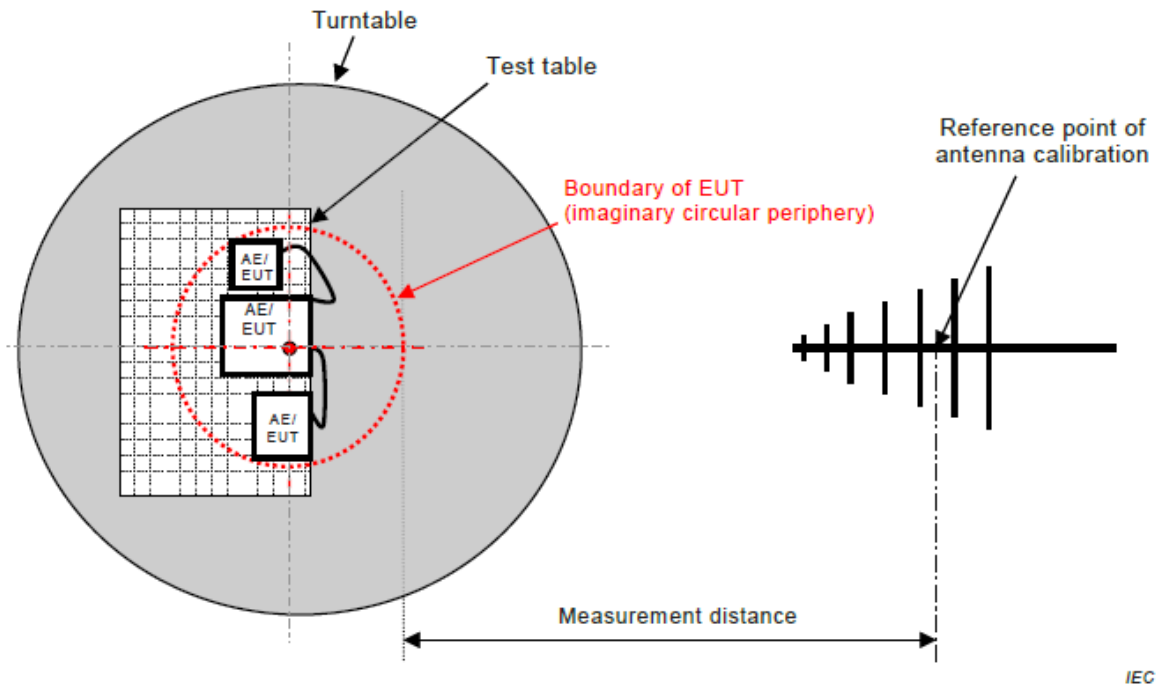

Figure C.1 – Measurement distance

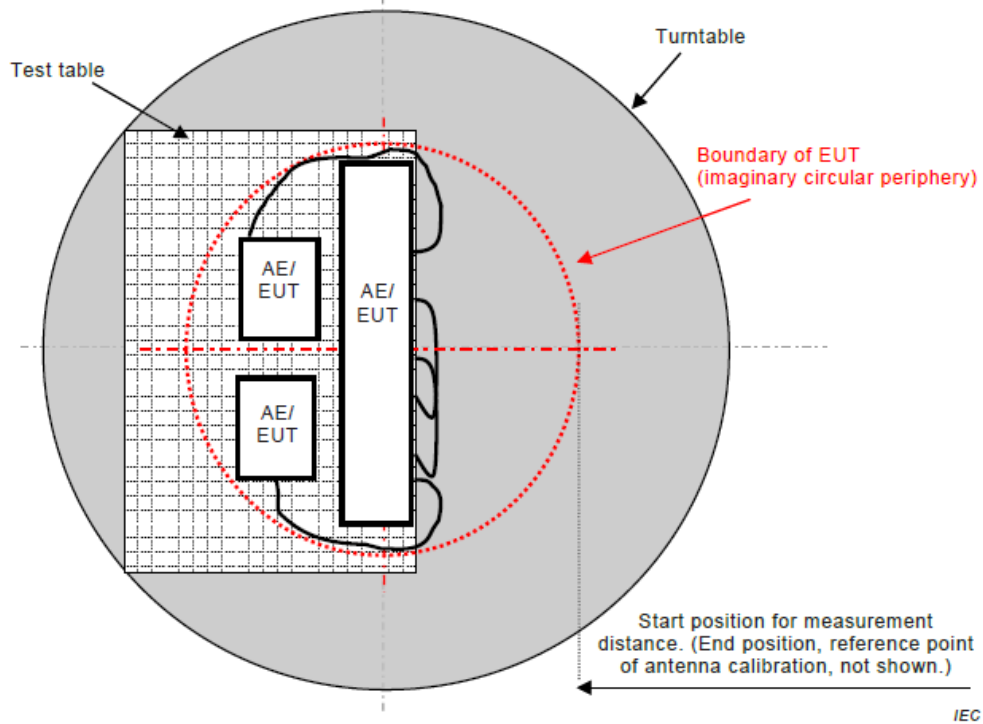
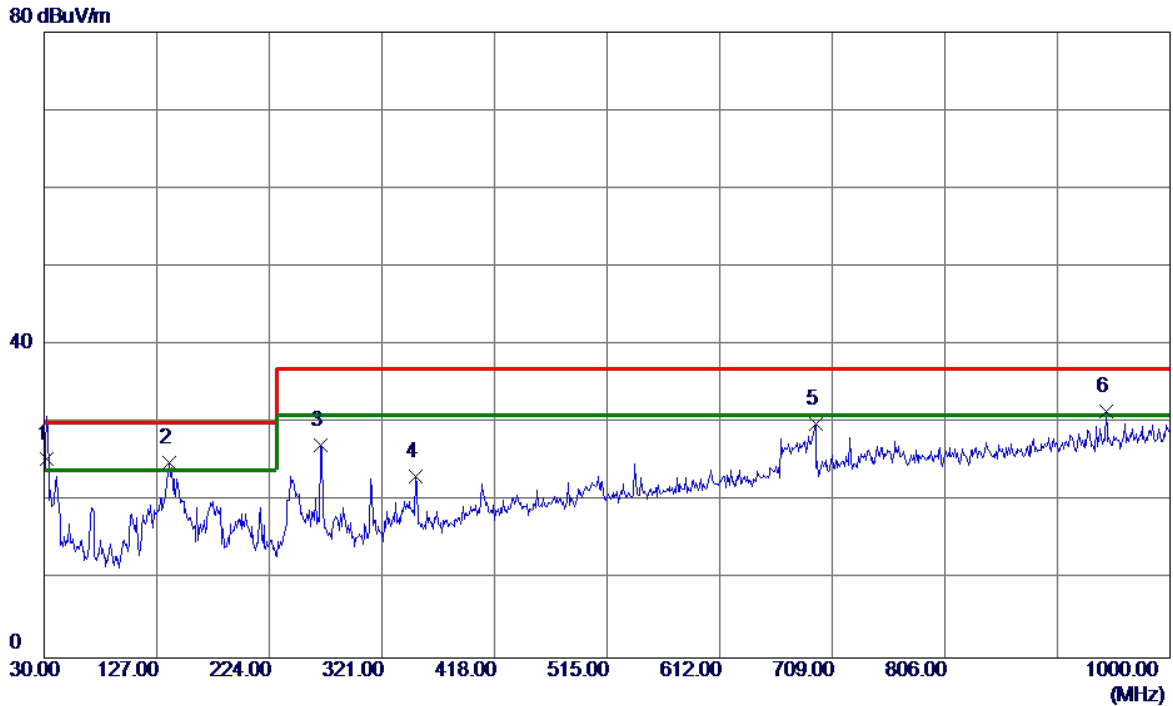

Figure C.2 – Boundary of EUT, Local AE and associated cabling

4.1.7 TEST RESULTS (UP TO 1 GHZ)

Test Voltage	AC 230V/50Hz	Polarization	Vertical
Test Mode	HDMI 1920*1080/60Hz 1.8m		



No.	Freq. MHz	Reading Level dBuV/m	Correct Factor dB	Measure ment dBuV/m	Limit dBuV/m	Margin dB	Detector
1 *	31.9400	44.25	-18.83	25.42	30.00	-4.58	QP
2	137.6700	41.69	-16.78	24.91	30.00	-5.09	QP
3	268.6200	42.90	-15.68	27.22	37.00	-9.78	QP
4	350.1000	36.49	-13.28	23.21	37.00	-13.79	QP
5	694.4500	36.03	-6.15	29.88	37.00	-7.12	QP
6	944.7100	33.94	-2.46	31.48	37.00	-5.52	QP

Test Voltage	AC 230V/50Hz	Polarization	Horizontal
Test Mode	HDMI 1920*1080/60Hz 1.8m		

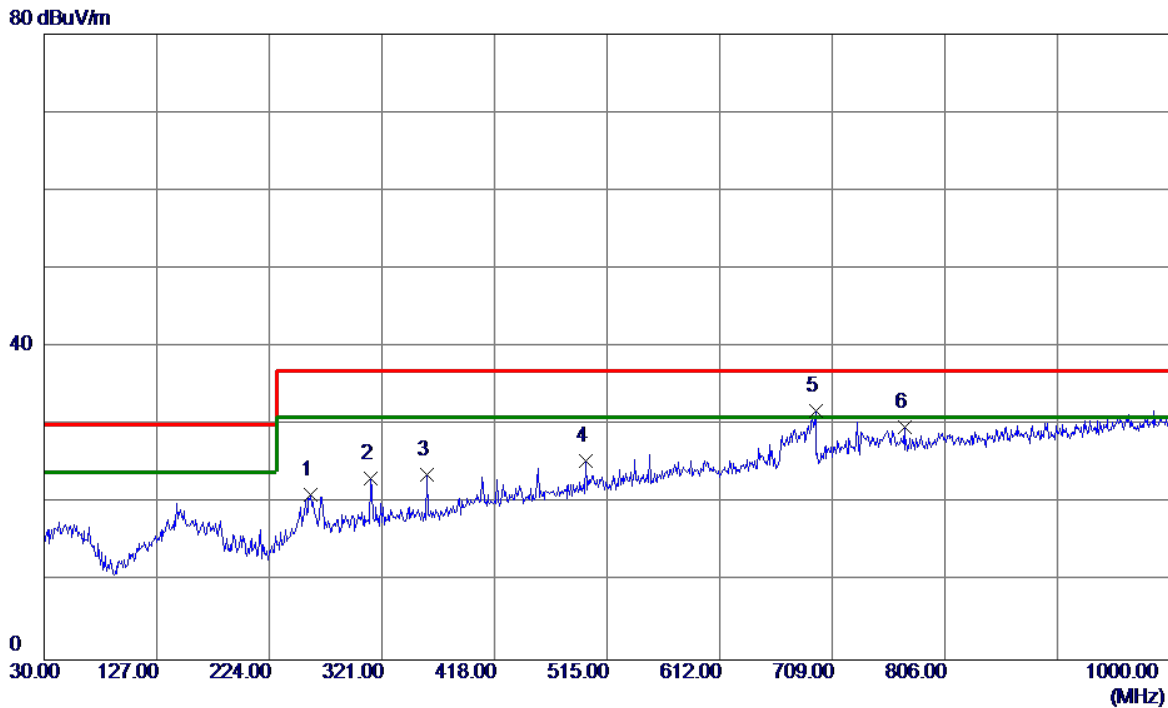

No.	Freq. MHz	Reading Level dBuV/m	Correct Factor dB	Measure ment dBuV/m	Limit dBuV/m	Margin dB	Detector
1	259.8900	37.14	-16.05	21.09	37.00	-15.91	QP
2	311.3000	37.13	-13.94	23.19	37.00	-13.81	QP
3	359.8000	36.50	-12.86	23.64	37.00	-13.36	QP
4	496.5700	35.01	-9.57	25.44	37.00	-11.56	QP
5 *	694.4500	37.53	-5.72	31.81	37.00	-5.19	QP
6	771.0800	34.29	-4.49	29.80	37.00	-7.20	QP

4.2 RADIATED EMISSIONS ABOVE 1 GHZ

4.2.1 LIMITS

Class B equipment above 1000MHz

Frequency Range MHz	Measurement			Class B limits dB(μ V/m)
	Facility	Distance m	Detector type/bandwidth	
1000 - 3000	FSOATS	3	Average / 1 MHz	50
3000 - 6000				54
1000 - 3000			Peak / 1 MHz	70
3000 - 6000				74

Notes:

- (1) The limit for radiated test was performed according to as following: EN 55032
- (2) The tighter limit applies at the band edges.
- (3) Emission level (dBuV/m)=20log Emission level (uV/m).
- (4) The test result calculated as following:
 Measurement Value = Reading Level + Correct Factor
 Correct Factor = Antenna Factor + Cable Loss - Amplifier Gain(if use)
 Margin Level = Measurement Value - Limit Value

Required highest frequency for radiated measurement

Highest internal frequency (F_x) MHz	Highest measured frequency MHz
$F_x \leq 108$	1000
$108 < F_x \leq 500$	2000
$500 < F_x \leq 1000$	5000
$F_x > 1000$	5 th up to a maximum 6 GHz,

Note for FM and TV broadcast receiver, F_x is determined from the highest frequency generated or used excluding the local oscillator and tuned frequencies.

Above 1GHz:

Item	Kind of Equipment	Manufacturer	Type No.	Series Model	Calibrated until
1	Horn Antenna	EMCO	3115	9605-4803	May 12, 2021
2	Amplifier	Agilent	8449B	3008A02333	Mar. 01, 2021
3	MXE EMI Receiver	Agilent	N9038A	MY53220133	Feb. 28, 2021
4	Measurement Software	Farad	EZ-EMC Ver.BTL-2ANT-1	N/A	N/A
5	Multi-Device Controller	ETS-Lindgren	2090	N/A	N/A
6	Controller	MF	MF-7802	MF780208159	N/A
7	Cable	Mlcable Inc.	B10-01-01-5M	18047123	Feb. 28, 2021
8	Cable	Mlcable Inc.	B10-01-01-12 M	18072743	Feb. 28, 2021
9	Cable	RegalWay	RWLPS50-7.9 A-SMSM-1M	20200102 001	Feb. 28, 2021

Remark: "N/A" denotes no model no., no serial no. or no calibration specified.

All calibration period of equipment list is one year.

4.2.2 TEST PROCEDURE

- a. The measuring distance of 3 m shall be used for measurements. The EUT was placed on the top of a rotating table 0.8 meter above the ground at a 10 meter semi-anechoic chamber. The table was rotated 360 degrees to determine the position of the highest radiation.
- b. The height of the equipment or of the substitution antenna shall be 0.8 m, the height of the test antenna shall vary between 1 m to 4 m. Both horizontal and vertical polarizations of the antenna are set to make the measurement.
- c. The initial step in collecting radiated emission data is a receiver peak detector mode pre-scanning the measurement frequency range. Significant peaks are then marked and then Quasi Peak detector mode re-measured.
- d. All readings are Peak Mode value unless otherwise stated AVG in column of Note. If the Peak Mode Measured value compliance with the Peak Limits and lower than AVG Limits, the EUT shall be deemed to meet both Peak & AVG Limits and then only Peak Mode was measured, but AVG Mode didn't perform. (above 1GHz)
- e. For the actual test configuration, please refer to the related Item - Block Diagram of system tested.

4.2.3 DEVIATION FROM TEST STANDARD

No deviation

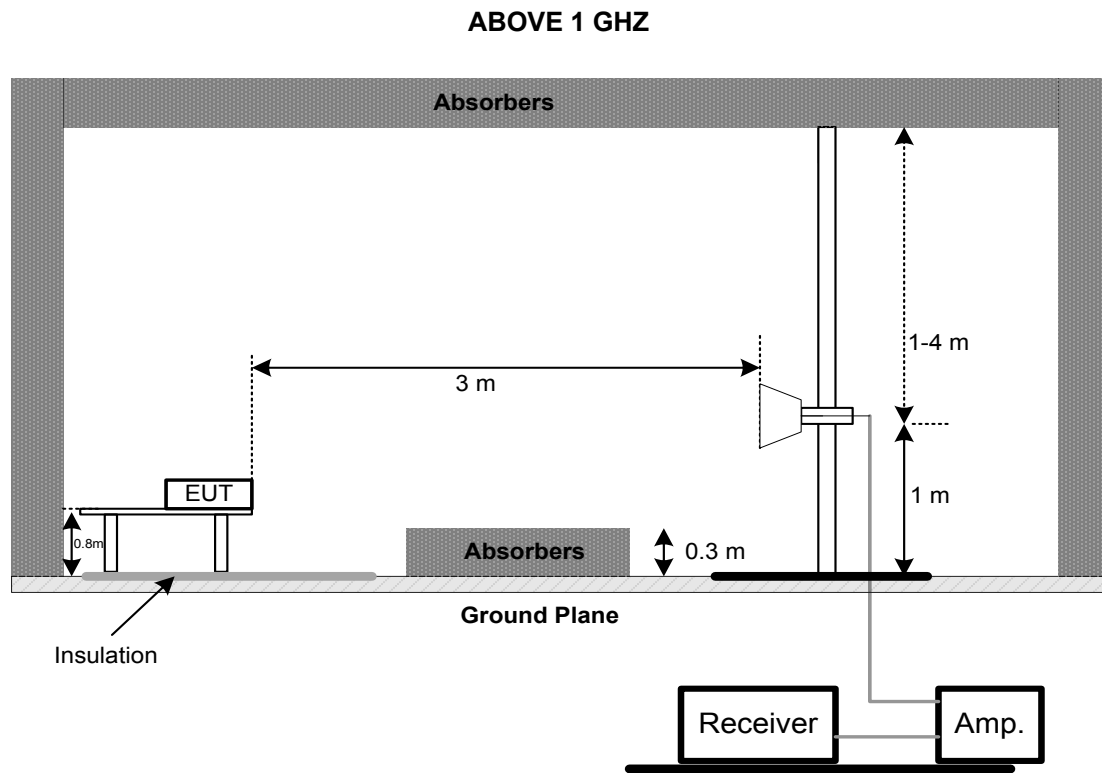
4.2.4 TEST SETUP

4.2.5 MEASUREMENT DISTANCE

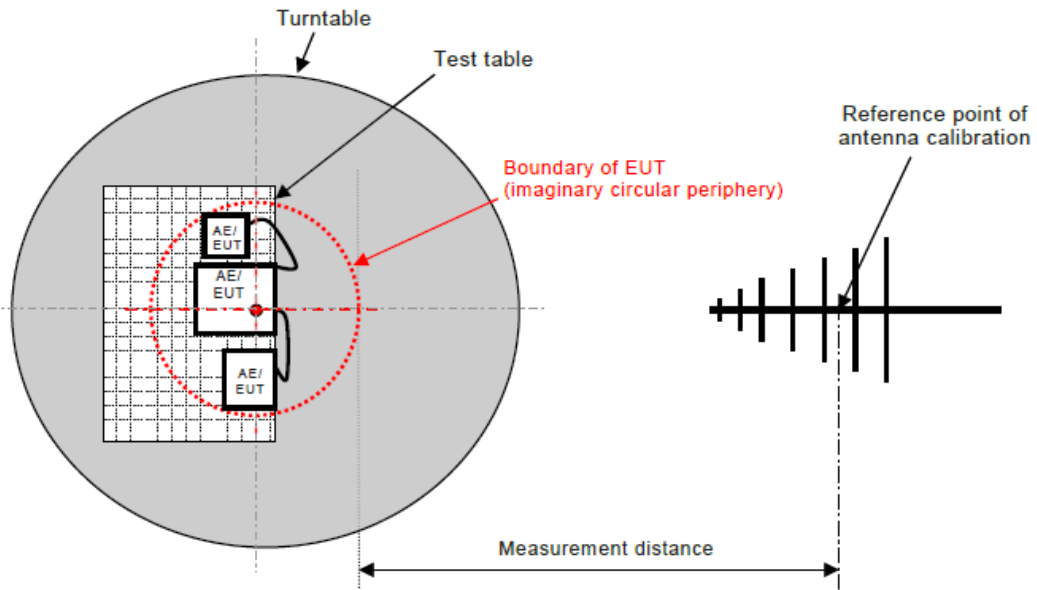

Figure C.1 – Measurement distance

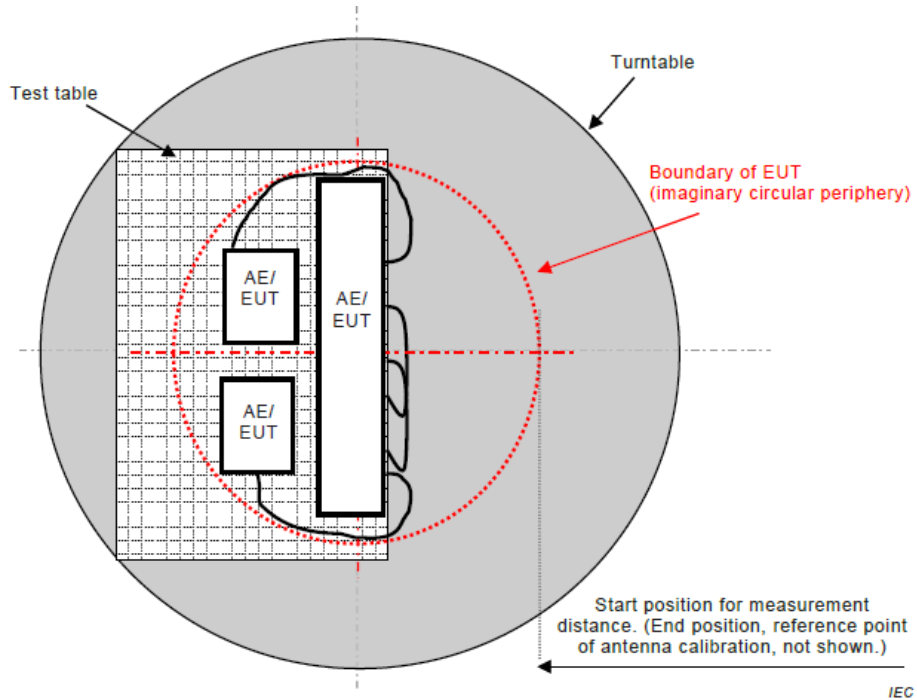
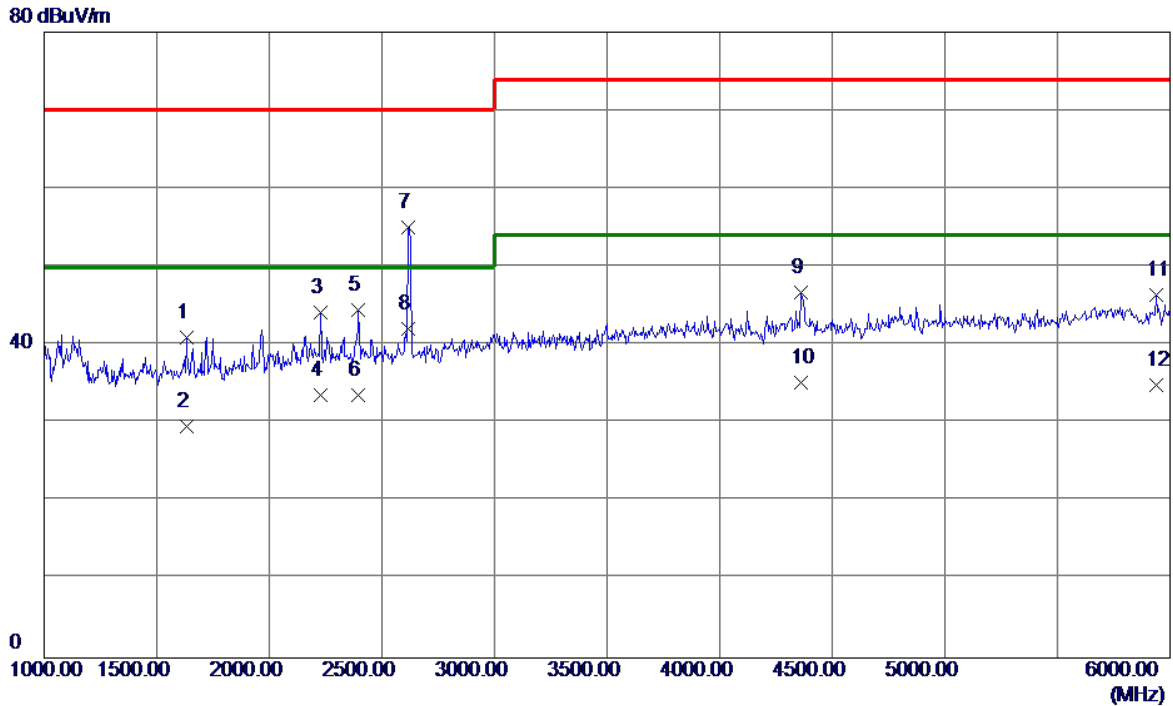

Figure C.2 – Boundary of EUT, Local AE and associated cabling

4.2.6 TEST RESULTS (ABOVE 1 GHZ)

Test Voltage	AC 230V/50Hz	Polarization	Vertical
Test Mode	HDMI 1920*1080/60Hz 1.8m		



No.	Freq. MHz	Reading Level dBuV/m	Correct Factor dB	Measure ment dBuV/m	Limit dBuV/m	Margin dB	Detector
1	1632.5000	43.09	-2.14	40.95	70.00	-29.05	Peak
2	1632.5000	31.77	-2.14	29.63	50.00	-20.37	AVG
3	2227.5000	43.16	1.04	44.20	70.00	-25.80	Peak
4	2227.5000	32.50	1.04	33.54	50.00	-16.46	AVG
5	2395.0000	42.78	1.64	44.42	70.00	-25.58	Peak
6	2395.0000	31.98	1.64	33.62	50.00	-16.38	AVG
7	2617.5000	52.50	2.57	55.07	70.00	-14.93	Peak
8 *	2617.5000	39.56	2.57	42.13	50.00	-7.87	AVG
9	4362.5000	37.90	8.87	46.77	74.00	-27.23	Peak
10	4362.5000	26.39	8.87	35.26	54.00	-18.74	AVG
11	5937.5000	33.48	12.94	46.42	74.00	-27.58	Peak
12	5937.5000	21.92	12.94	34.86	54.00	-19.14	AVG

Test Voltage	AC 230V/50Hz	Polarization	Horizontal
Test Mode	HDMI 1920*1080/60Hz 1.8m		

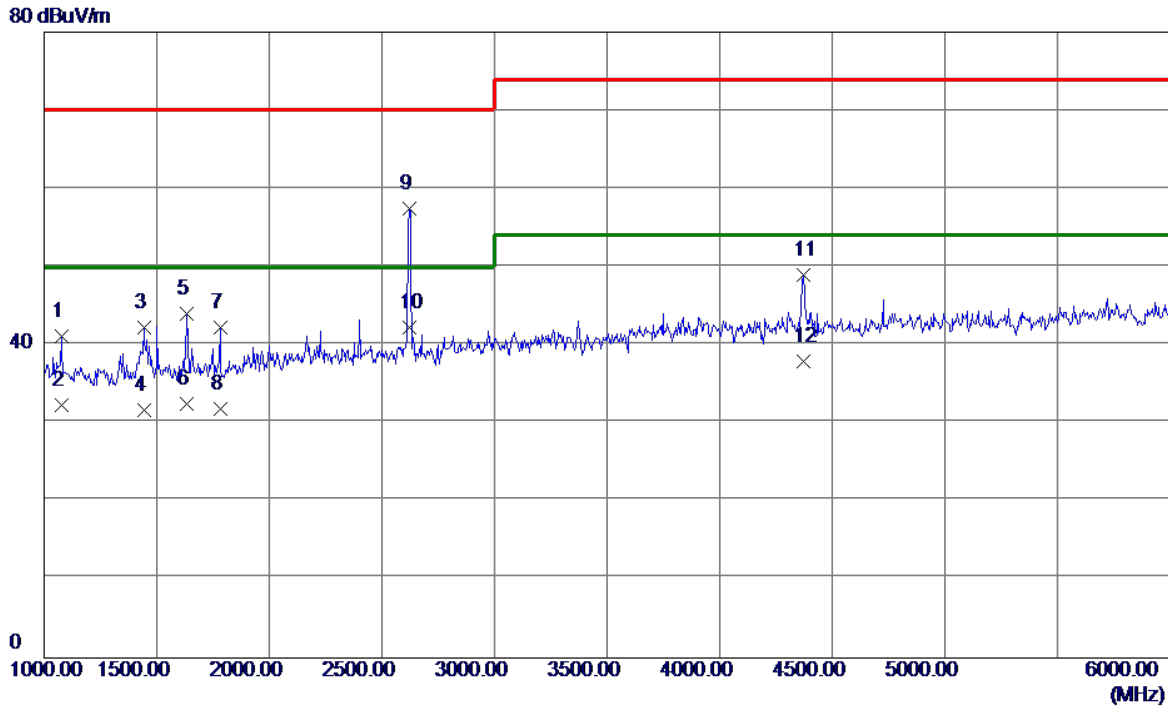

No.	Freq. MHz	Reading Level dBuV/m	Correct Factor dB	Measure ment dBuV/m	Limit dBuV/m	Margin dB	Detector
1	1077.5000	45.92	-4.81	41.11	70.00	-28.89	Peak
2	1077.5000	37.06	-4.81	32.25	50.00	-17.75	AVG
3	1442.5000	45.47	-3.24	42.23	70.00	-27.77	Peak
4	1442.5000	34.90	-3.24	31.66	50.00	-18.34	AVG
5	1635.0000	46.07	-2.12	43.95	70.00	-26.05	Peak
6	1635.0000	34.53	-2.12	32.41	50.00	-17.59	AVG
7	1782.5000	43.35	-1.17	42.18	70.00	-27.82	Peak
8	1782.5000	33.02	-1.17	31.85	50.00	-18.15	AVG
9	2622.5000	54.80	2.60	57.40	70.00	-12.60	Peak
10 *	2622.5000	39.71	2.60	42.31	50.00	-7.69	AVG
11	4372.5000	40.05	8.89	48.94	74.00	-25.06	Peak
12	4372.5000	28.96	8.89	37.85	54.00	-16.15	AVG

4.3 CONDUCTED EMISSION MEASUREMENT AT AC MAINS POWER PORTS

4.3.1 LIMITS

Requirements for conducted emissions from AC mains power ports of Class B equipment

Frequency Range MHz	Coupling Device	Detector Type / bandwidth	Class B Limits (dB(μV))
0.15 - 0.5	AMN	Quasi Peak / 9 kHz	66-56
0.5 - 5			56
5 - 30			60
0.15 - 0.5	AMN	Average / 9 kHz	56-46
0.5 - 5			46
5 - 30			50

NOTE:

(1) The test result calculated as following:

Measurement Value = Reading Level + Correct Factor

Correct Factor = Insertion Loss + Cable Loss + Attenuator Factor(if use)

Margin Level = Measurement Value – Limit Value

4.3.2 MEASUREMENT INSTRUMENTS LIST

Item	Kind of Equipment	Manufacturer	Type No.	Series Model	Calibrated until
1	50Ω Terminator	SHX	TF2-3G-A	8122901	Feb. 28, 2021
2	TWO-LINE V-NETWORK	R&S	ENV216	100526	Mar. 01, 2021
3	EMI Test Receiver	R&S	ESR3	101862	Aug. 03, 2020
4	Artificial-Mains Network	SCHWARZBECK	NSLK 8127	8127685	Mar. 01, 2021
5	TRANSIENT LIMITER	EM	EM-7600	772	Mar. 01, 2021
6	Cable	N/A	RG400	N/A(12m)	Mar. 10, 2021
7	Measurement Software	Farad	EZ-EMC Ver.NB-03A1-01	N/A	N/A

Remark: "N/A" denotes no model name, serial no. or calibration specified.

All calibration period of equipment list is one year.

4.3.3 TEST PROCEDURE

- The EUT was placed 0.8 meters from the horizontal ground plane with EUT being connected to the power mains through a line impedance stabilization network (LISN). All other support equipments powered from additional LISN(s). The LISN provide 50 Ohm/ 50uH of coupling impedance for the measuring instrument.
- Interconnecting cables that hang closer than 40 cm to the ground plane shall be folded back and forth in the center forming a bundle 30 to 40 cm long.
- I/O cables that are not connected to a peripheral shall be bundled in the center. The end of the cable may be terminated, if required, using the correct terminating impedance. The overall length shall not exceed 1 m.
- LISN at least 80 cm from nearest part of EUT chassis.
- For the actual test configuration, please refer to the related Item –EUT Test Photos.

4.3.4 DEVIATION FROM TEST STANDARD

No deviation

4.3.5 TEST SETUP

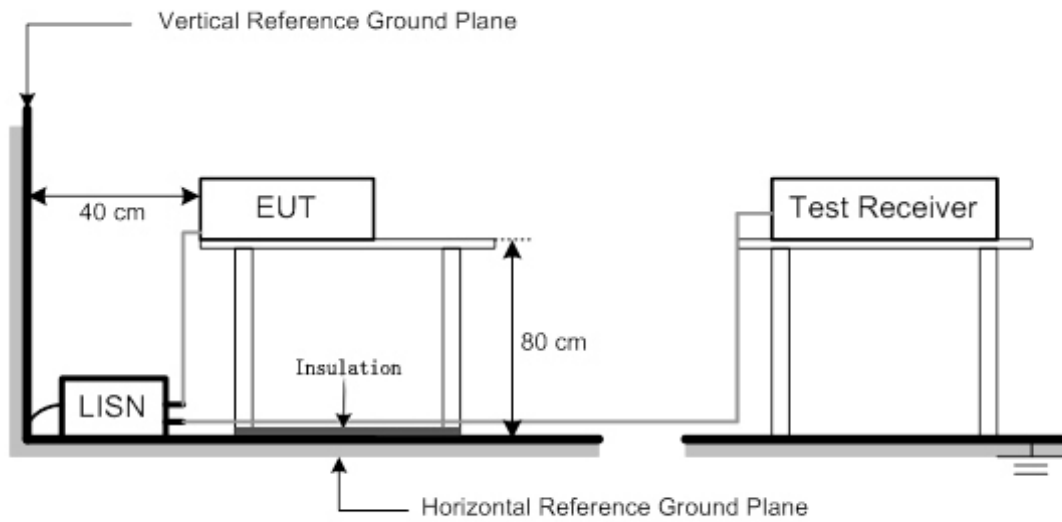

4.3.6 TEST RESULTS

Test Voltage	AC 230V/50Hz	Phase	Line
Test Mode	HDMI 1920*1080/60Hz 1.8m		

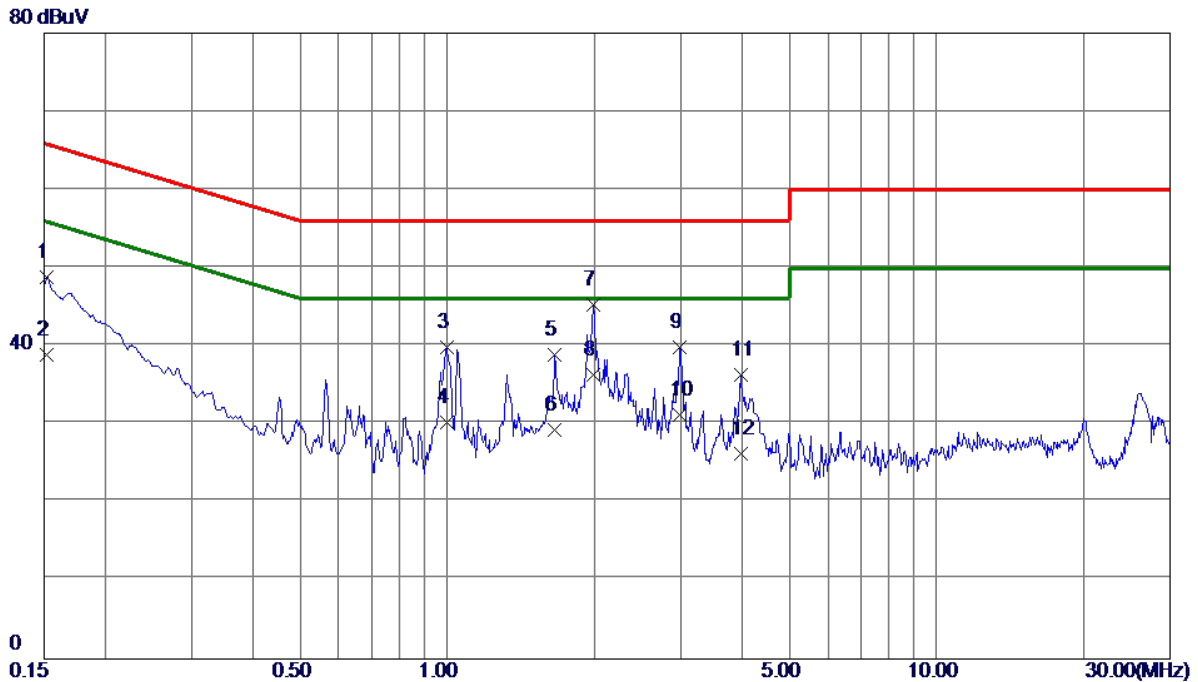

No.	Freq. MHz	Reading Level dBuV	Correct Factor dB	Measure ment dBuV	Limit dBuV	Margin dB	Detector
1	0.1522	39.22	9.59	48.81	65.88	-17.07	QP
2	0.1522	29.31	9.59	38.90	55.88	-16.98	AVG
3	0.9960	30.15	9.67	39.82	56.00	-16.18	QP
4	0.9960	20.50	9.67	30.17	46.00	-15.83	AVG
5	1.6598	29.14	9.73	38.87	56.00	-17.13	QP
6	1.6598	19.60	9.73	29.33	46.00	-16.67	AVG
7	1.9928	35.55	9.75	45.30	56.00	-10.70	QP
8 *	1.9928	26.60	9.75	36.35	46.00	-9.65	AVG
9	2.9805	30.03	9.83	39.86	56.00	-16.14	QP
10	2.9805	21.40	9.83	31.23	46.00	-14.77	AVG
11	3.9818	26.37	9.90	36.27	56.00	-19.73	QP
12	3.9818	16.40	9.90	26.30	46.00	-19.70	AVG

Test Voltage	AC 230V/50Hz	Phase	Neutral
Test Mode	HDMI 1920*1080/60Hz 1.8m		

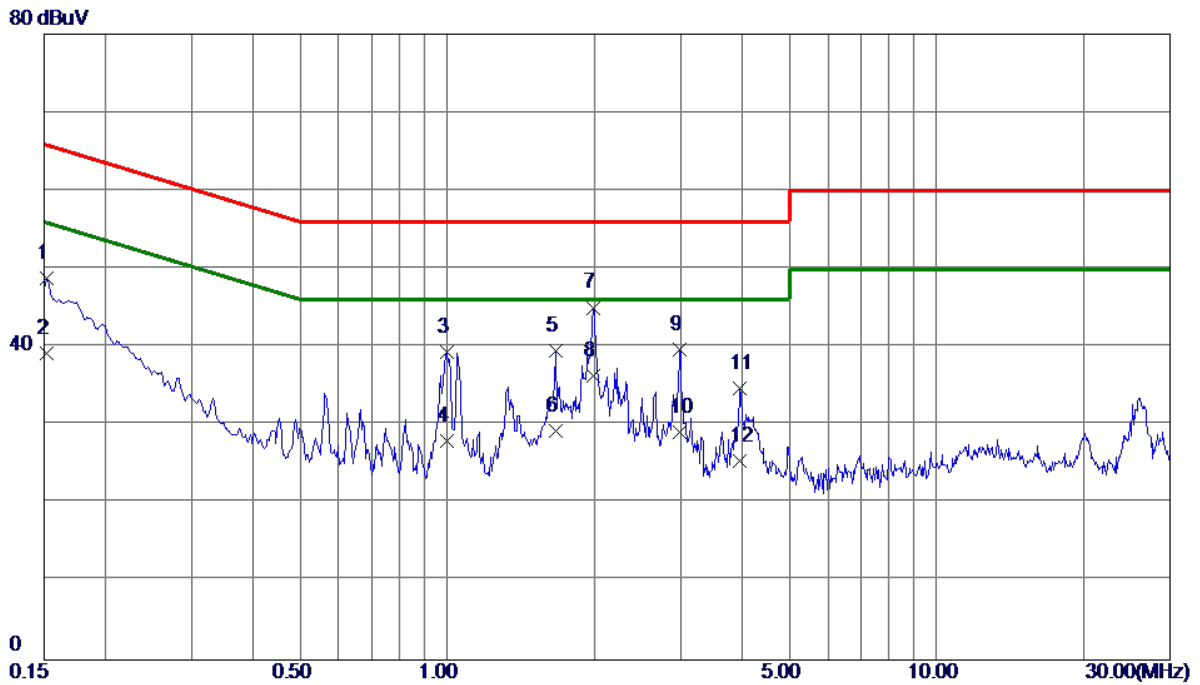

No.	Freq. MHz	Reading Level dBuV	Correct Factor dB	Measure ment dBuV	Limit dBuV	Margin dB	Detector
1	0.1522	39.17	9.56	48.73	65.88	-17.15	QP
2	0.1522	29.61	9.56	39.17	55.88	-16.71	AVG
3	0.9960	29.76	9.66	39.42	56.00	-16.58	QP
4	0.9960	18.40	9.66	28.06	46.00	-17.94	AVG
5	1.6620	29.85	9.71	39.56	56.00	-16.44	QP
6	1.6620	19.50	9.71	29.21	46.00	-16.79	AVG
7	1.9883	35.30	9.74	45.04	56.00	-10.96	QP
8 *	1.9883	26.60	9.74	36.34	46.00	-9.66	AVG
9	2.9782	29.92	9.82	39.74	56.00	-16.26	QP
10	2.9782	19.30	9.82	29.12	46.00	-16.88	AVG
11	3.9705	24.89	9.89	34.78	56.00	-21.22	QP
12	3.9705	15.50	9.89	25.39	46.00	-20.61	AVG

5. HARMONIC AND FLICKER TEST

5.1 HARMONIC CURRENT EMISSIONS

5.1.1 LIMITS

The power consumption is less than 75W, there is no limit applied.

5.1.2 MEASUREMENT INSTRUMENTS LIST

Item	Kind of Equipment	Manufacturer	Type No.	Series Model	Calibrated until
1	Harmonics and Flicker Analyzer	California Instruments	PACS-1	72344	Aug. 03, 2020
2	3KVA AC Power source	California Instruments	3001ix	56309	Aug. 03, 2020
3	Measurement Software	California	CTS4.0 Version 4.21	N/A	N/A

Remark: "N/A" denotes no model no., no serial No. or no calibration specified.

All calibration period of equipment list is one year.

5.1.3 TEST PROCEDURE

- The EUT was placed on the top of a wooden table 0.8 meters above the ground and operated to produce the maximum harmonic components under normal operating conditions.
- The correspondent test program of test instrument to measure the current harmonics emanated from EUT is chosen. The measure time shall be not less than the time necessary for the EUT to be exercised.

5.1.4 DEVIATION FROM TEST STANDARD

No deviation

5.1.5 TEST SETUP

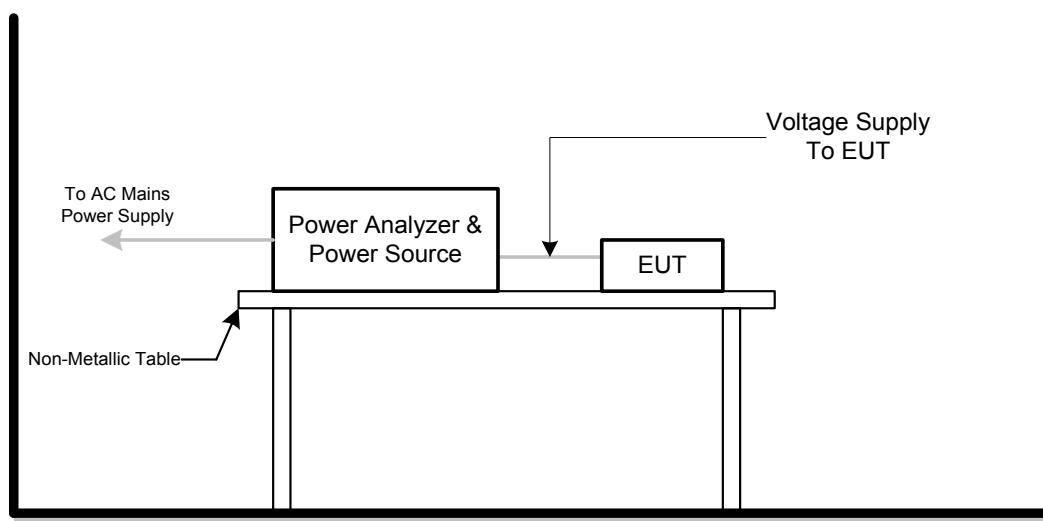

5.1.6 TEST RESULTS

Harmonic - Class D	
Test Voltage	AC 230V/50Hz
Test Mode	HDMI 1920*1080/60Hz 1.8m

Current & voltage waveforms

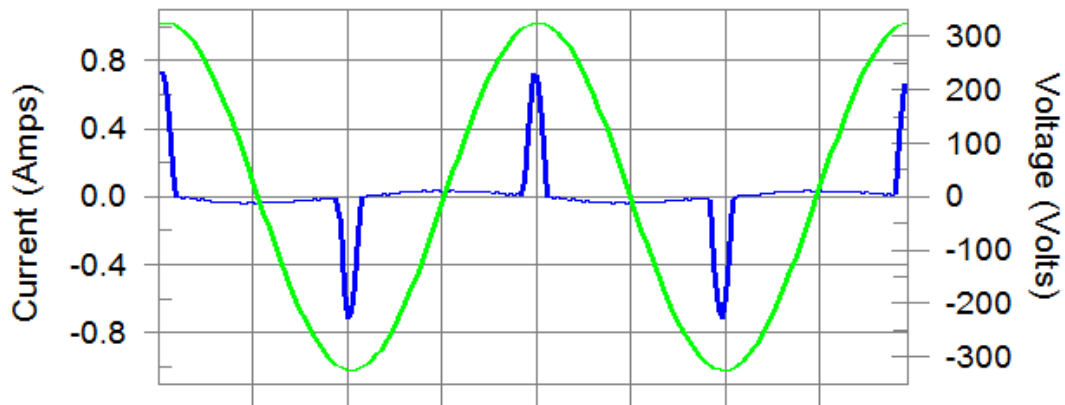

Harmonics and Class D limit line European Limits

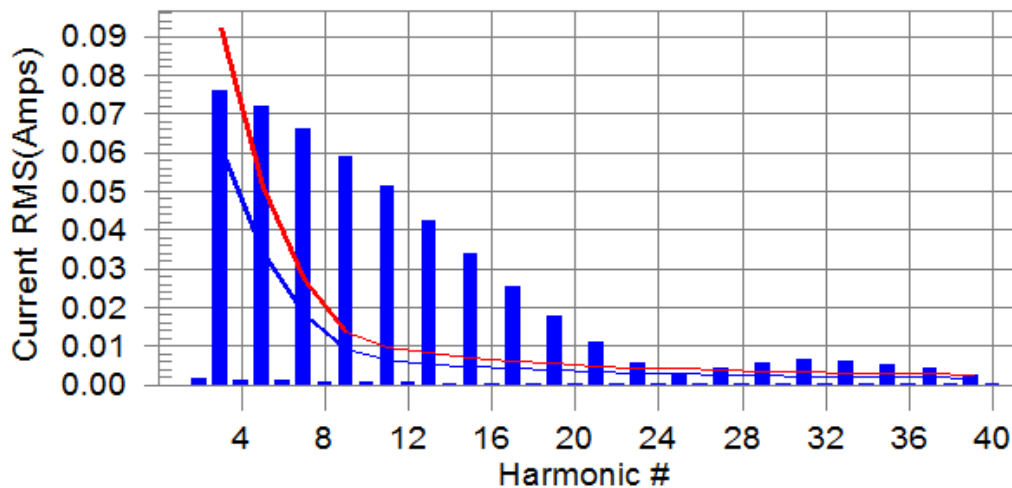

Test result: N/L Worst harmonics H0-0.0% of 150% limit, H0-0% of 100% limit

Current Test Result Summary (Run time)

Test Voltage	AC 230V/50Hz
Test Mode	HDMI 1920*1080/60Hz 1.8m

Highest parameter values during test:

V_RMS (Volts):	229.92	Frequency(Hz):	50.00
I_Peak (Amps):	0.749	I_RMS (Amps):	0.181
I_Fund (Amps):	0.083	Crest Factor:	4.154
Power (Watts):	18.0	Power Factor:	0.438

Harm#	Harms(avg)	100%Limit	%of Limit	Harms(max)	150%Limit	%of Limit	Status
2	0.002	0.000	N/A	0.002	0.000	N/A	N/L
3	0.076	0.061	N/A	0.077	0.092	N/A	N/L
4	0.001	0.000	N/A	0.002	0.000	N/A	N/L
5	0.072	0.034	N/A	0.072	0.051	N/A	N/L
6	0.001	0.000	N/A	0.001	0.000	N/A	N/L
7	0.066	0.018	N/A	0.066	0.027	N/A	N/L
8	0.001	0.000	N/A	0.001	0.000	N/A	N/L
9	0.059	0.009	N/A	0.059	0.014	N/A	N/L
10	0.001	0.000	N/A	0.001	0.000	N/A	N/L
11	0.051	0.006	N/A	0.051	0.009	N/A	N/L
12	0.001	0.000	N/A	0.001	0.000	N/A	N/L
13	0.043	0.005	N/A	0.043	0.008	N/A	N/L
14	0.000	0.000	N/A	0.001	0.000	N/A	N/L
15	0.034	0.005	N/A	0.034	0.007	N/A	N/L
16	0.000	0.000	N/A	0.000	0.000	N/A	N/L
17	0.025	0.004	N/A	0.026	0.006	N/A	N/L
18	0.000	0.000	N/A	0.000	0.000	N/A	N/L
19	0.018	0.004	N/A	0.018	0.005	N/A	N/L
20	0.000	0.000	N/A	0.001	0.000	N/A	N/L
21	0.011	0.003	N/A	0.011	0.005	N/A	N/L
22	0.000	0.000	N/A	0.001	0.000	N/A	N/L
23	0.006	0.003	N/A	0.006	0.005	N/A	N/L
24	0.000	0.000	N/A	0.001	0.000	N/A	N/L
25	0.003	0.003	N/A	0.003	0.004	N/A	N/L
26	0.000	0.000	N/A	0.000	0.000	N/A	N/L
27	0.004	0.003	N/A	0.004	0.004	N/A	N/L
28	0.000	0.000	N/A	0.000	0.000	N/A	N/L
29	0.006	0.002	N/A	0.006	0.004	N/A	N/L
30	0.000	0.000	N/A	0.000	0.000	N/A	N/L
31	0.006	0.002	N/A	0.006	0.003	N/A	N/L
32	0.000	0.000	N/A	0.000	0.000	N/A	N/L
33	0.006	0.002	N/A	0.006	0.003	N/A	N/L
34	0.000	0.000	N/A	0.000	0.000	N/A	N/L
35	0.005	0.002	N/A	0.005	0.003	N/A	N/L
36	0.000	0.000	N/A	0.000	0.000	N/A	N/L
37	0.004	0.002	N/A	0.004	0.003	N/A	N/L
38	0.000	0.000	N/A	0.000	0.000	N/A	N/L
39	0.003	0.002	N/A	0.003	0.003	N/A	N/L
40	0.000	0.000	N/A	0.000	0.000	N/A	N/L

Note: The EUT power level is below 75.0 Watts and therefore has no defined limits

Voltage Source Verification Data (Run time)	
Test Voltage	AC 230V/50Hz
Test Mode	HDMI 1920*1080/60Hz 1.8m

Highest parameter values during test:

Voltage (Vrms):	229.92	Frequency(Hz):	50.00
I_Peak (Amps):	0.749	I_RMS (Amps):	0.181
I_Fund (Amps):	0.083	Crest Factor:	4.154
Power (Watts):	18.0	Power Factor:	0.438

Harm#	Harmonics V-rms	Limit V-rms	% of Limit	Status
2	0.118	0.460	25.64	OK
3	0.525	2.069	25.36	OK
4	0.064	0.460	13.82	OK
5	0.041	0.920	4.50	OK
6	0.028	0.460	5.99	OK
7	0.050	0.690	7.20	OK
8	0.021	0.460	4.61	OK
9	0.019	0.460	4.17	OK
10	0.023	0.460	4.96	OK
11	0.043	0.230	18.52	OK
12	0.018	0.230	8.04	OK
13	0.032	0.230	13.78	OK
14	0.015	0.230	6.71	OK
15	0.028	0.230	12.23	OK
16	0.016	0.230	6.99	OK
17	0.023	0.230	10.06	OK
18	0.013	0.230	5.55	OK
19	0.024	0.230	10.62	OK
20	0.016	0.230	7.06	OK
21	0.010	0.230	4.52	OK
22	0.012	0.230	5.24	OK
23	0.013	0.230	5.75	OK
24	0.006	0.230	2.66	OK
25	0.007	0.230	2.95	OK
26	0.008	0.230	3.61	OK
27	0.013	0.230	5.60	OK
28	0.008	0.230	3.52	OK
29	0.014	0.230	6.00	OK
30	0.005	0.230	2.36	OK
31	0.011	0.230	4.64	OK
32	0.005	0.230	2.37	OK
33	0.011	0.230	4.67	OK
34	0.003	0.230	1.35	OK
35	0.009	0.230	3.95	OK
36	0.004	0.230	1.55	OK
37	0.011	0.230	4.83	OK
38	0.004	0.230	1.59	OK
39	0.007	0.230	2.94	OK
40	0.006	0.230	2.80	OK

5.2 VOLTAGE CHANGES, VOLTAGE FLUCTUATIONS AND FLICKER TEST

5.2.1 LIMITS

Tests	Limits	Descriptions
	EN 61000-3-3	
Pst	≤ 1.0 , $T_p= 10$ min.	Short Term Flicker Indicator
Plt	≤ 0.65 , $T_p=2$ hr.	Long Term Flicker Indicator
dc	$\leq 3.3\%$	Relative Steady-State V-Chang
dmax	$\leq 4\%$	Maximum Relative V-change
d (t)	≤ 500 ms	Relative V-change characteristic

5.2.2 MEASUREMENT INSTRUMENTS LIST

Item	Kind of Equipment	Manufacturer	Type No.	Series Model	Calibrated until
1	Harmonics and Flicker Analyzer	California Instruments	PACS-1	72344	Aug. 03, 2020
2	3KVA AC Power source	California Instruments	3001ix	56309	Aug. 03, 2020
3	Measurement Software	California	CTS4.0 Version 4.21	N/A	N/A

Remark: "N/A" denotes no model no., no serial No. or no calibration specified.

All calibration period of equipment list is one year.

5.2.3 TEST PROCEDURE

- Tests was performed according to the Test Conditions/Assessment of Voltage Fluctuations specified in EN 61000-3-3 depend on which standard adopted for compliance measurement.
- All types of harmonic current and/or voltage fluctuation in this report are assessed by direct measurement using flicker-meter.

5.2.4 DEVIATION FROM TEST STANDARD

No deviation

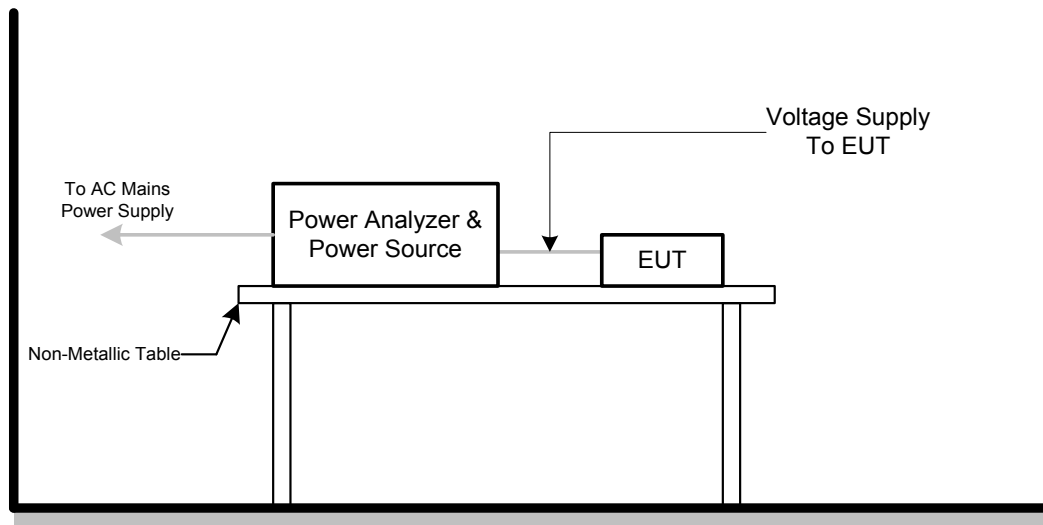
5.2.5 TEST SETUP

5.2.6 TEST RESULTS

Test Voltage	AC 230V/50Hz
Test Mode	HDMI 1920*1080/60Hz 1.8m

Pst and limit line

European Limits



Plt and limit line

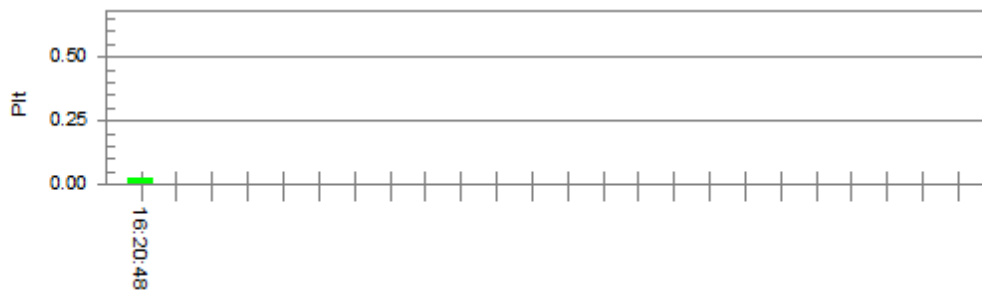

Parameter values recorded during the test:

Vrms at the end of test (Volt):	229.84		
T-max (mS):	0	Test limit (mS):	500.0 Pass
Highest dc (%):	0.00	Test limit (%):	3.30 Pass
Highest dmax (%):	0.00	Test limit (%):	4.00 Pass
Highest Pst (10 min. period):	0.064	Test limit:	1.000 Pass
Highest Plt (2 hr. period):	0.028	Test limit:	0.650 Pass

6. EMC IMMUNITY TEST

6.1 STANDARD COMPLIANCE/SEVERITY LEVEL/CRITERIA

Tests Standard No.	Test Specification Level / Test Mode	Test Ports	Criteria
Electrostatic discharge IEC 61000-4-2 (ESD)	±8kV air discharge ±4kV contact discharge (Direct Mode)	Enclosure	B
	±4kV HCP discharge ±4kV VCP discharge (Indirect Mode)	Enclosure	B
Continuous RF electromagnetic field disturbances, swept test IEC 61000-4-3 (RS)	80 MHz to 1000 MHz 3V/m(unmodulated, r.m.s), 1 kHz, 80%, AM modulated	Enclosure	A
Continuous RF electromagnetic field disturbances, spot test IEC 61000-4-3 (RS)	1800 MHz, 2600MHz, 3500 MHz, 5000MHz(±1 %) 3V/m(unmodulated, r.m.s), 1 kHz, 80%, AM modulated	Enclosure	A
Electrical fast transient/burst immunity IEC 61000-4-4 (EFT)	±0.5kV(peak) 5/50ns Tr/Th 5kHz Repetition Frequency (100kHz Repetition Frequency for xDSL port)	Analogue/digital data ports (NOTE 2)	B
	±0.5kV(peak) 5/50ns Tr/Th 5kHz Repetition Frequency	DC network power ports (NOTE 2)	B
	±1 kV(peak) 5/50ns Tr/Th 5kHz Repetition Frequency	AC mains power ports	B

Surge immunity IEC 61000-4-5 (Surge)	Port Type: unshielded symmetrical		
	Apply: lines to ground		
	Primary protection is Intended ±1 kV 10/700(5/320)Tr/Th µs	Analogue/digital data ports (NOTE 1) & (NOTE 2)	C
	Primary protection is not Intended ±1 kV 10/700(5/320) Tr/Th µs		C
	Port type: coaxial or shielded		
	Apply: shield to ground		
±0.5 kV 1.2/50(8/20) Tr/Th µs	Analogue/digital data ports (NOTE 1) & (NOTE 2)	B	
line to reference ground for each individual line: ±0.5 kV(peak) 1.2/50(8/20) Tr/Th µs	DC network power ports (NOTE 2)	B	
±1 kV(peak) 1.2/50(8/20) Tr/Th µs (line to line) ±2 kV(peak) 1.2/50(8/20) Tr/Th µs (line to earth or ground)	AC mains power ports	B	
Continuous induced RF disturbances IEC 61000-4-6 (CS)	0.15 MHz to 10 MHz 3V(unmodulated, r.m.s), 10 MHz to 30 MHz 3V to 1V(unmodulated, r.m.s), 30 MHz to 80 MHz 1V(unmodulated, r.m.s), 1kHz 80%, AM 150Ω source impedance	Analogue/digital data ports (NOTE 2)	A
	0.15 MHz to 10 MHz 3V(unmodulated, r.m.s), 10 MHz to 30 MHz 3V to 1V(unmodulated, r.m.s), 30 MHz to 80 MHz 1V(unmodulated, r.m.s), 1kHz 80%, AM 150Ω source impedance	DC network power ports (NOTE 2)	A
	0.15 MHz to 10 MHz 3V(unmodulated, r.m.s), 10 MHz to 30 MHz 3V to 1V(unmodulated, r.m.s), 30 MHz to 80 MHz 1V(unmodulated, r.m.s), 1kHz 80%, AM 150Ω source impedance	AC mains power ports	A

Power frequency magnetic field immunity IEC 61000-4-8 (PFMF)	50 Hz or 60Hz, 1A/m(r.m.s)	Enclosure	A
Voltage dips, short interruptions and voltage variations immunity IEC 61000-4-11 (Dips)	Voltage dips: Residual voltage < 5% 0.5 cycle Residual voltage < 70% 25 cycle(50Hz), 30 cycle (60Hz) Voltage interruptions: Residual voltage < 5% 250 cycle (50Hz), 300 cycle (60Hz)	AC Power Ports	B C C
Broadband impulse noise disturbances, repetitive (BIN-R)	0.15MHz to 0.5 MHz 107dBuV 0.5 MHz to 10 MHz 107dBuV to 36dBuV 10 MHz to 30 MHz 36dBuV to 30 dBuV	Analogue/digital data ports (Applicable only to CPE xDSL ports)	A
	0.70 ms 8.3 ms(for 60Hz) 10 ms(for 50Hz)	Analogue/digital data ports (Apply period based on the AC mains frequency)	A
Broadband impulse noise disturbances, isolated (BIN-I)	0.15MHz to 30 MHz 110dBuV	Analogue/digital data ports (Applicable only to CPE xDSL ports)	B
	0.24 ms 10 ms 300 ms	Analogue/digital data ports (Apply all burst durations)	B

Note.

- 1) Applicable only to ports which, according to the manufacturer's specification, may connect directly to outdoor cables.
- 2) Applicable only to ports which, according to the manufacturer's specification, support cable lengths greater than 3 m.

6.2 GENERAL PERFORMANCE CRITERIA

According to **EN55035** standard, the general performance criteria as following:

Criterion A	<p>The equipment shall continue to operate as intended without operator intervention. No degradation of performance, loss of function or change of operating state is allowed below a performance level specified by the manufacturer when the equipment is used as intended. The performance level may be replaced by a permissible loss of performance. If the minimum performance level or the permissible performance loss is not specified by the manufacturer, then either of these may be derived from the product description and documentation, and by what the user may reasonably expect from the equipment if used as intended.</p>
Criterion B	<p>During the application of the disturbance, degradation of performance is allowed. However, nonintended change of actual operating state or stored data is allowed to persist after the test.</p> <p>After the test, the equipment shall continue to operate as intended without operator intervention; no degradation of performance or loss of function is allowed, below a performance level specified by the manufacturer, when the equipment is used as intended. The performance level may be replaced by a permissible loss of performance. If the minimum performance level (or the permissible performance loss), or recovery time, is not specified by the manufacturer, then either of these may be derived from the product description and documentation, and by what the user may reasonably expect from the equipment if used as intended.</p>
Criterion C	<p>Loss of function is allowed, provided the function is self-recoverable, or can be restored by the operation of the controls by the user in accordance with the manufacturer's instructions. Areboot or re-start operation is allowed.</p> <p>Information stored in non-volatile memory, or protected by a battery backup, shall not be lost.</p>

6.3 ANNEX D (NORMATIVE) - DISPLAY AND DISPLAY OUTPUT FUNCTION

6.3.1 PERFORMANCE CRITERIA

Performance criterion A

for continuous radiated and conducted disturbances tests:

Apply criterion A as defined in GENERAL PERFORMANCE CRITERIA. Additionally, an increase in any degradation greater than

just perceptible by observation of the image shall not occur as a consequence of the application of the test. Examples of such degradations are:

- superimposed patterning;
- positional disturbances due to synchronisation errors;
- geometric distortion;
- change of contrast or brightness;
- picture artefacts;
- freezing or disturbance of motion;
- image loss;
- video data or decoding errors.

Performance criterion A

for the power frequency magnetic field tests:

Alternative 1: A continuous magnetic field of 1 A/m:

The jitter (in mm) shall not exceed the value
$$\frac{(\text{character height in mm} + 0,3) \times 2,5}{33,3}$$

Performance criterion B:

Apply criterion B as defined in GENERAL PERFORMANCE CRITERIA.

Performance criterion C:

Apply criterion C as defined in GENERAL PERFORMANCE CRITERIA.

6.4 ANNEX G (NORMATIVE) - AUDIO OUTPUT FUNCTION

6.4.1 PERFORMANCE CRITERIA

Performance criterion A:

For devices that support telephony functions the limits of Table G.3 shall apply.

With respect to Table G.3:

- the interference ratio (electrical or acoustic) shall meet the limits in column 3; or,
- the acoustic level of the demodulated audio shall be less than the limits in column 4; or,
- the digitally coded level of demodulated audio shall be less than limits in column 5; or,
- the analogue level of the demodulated audio shall be less than the limits in column 6.

Table G.3 – Performance criterion A – Limits for devices supporting telephony

Type of immunity test	Frequency range MHz	Acoustic or electrical interference ratio	Equivalent direct measurement		
			dB (SPL)	Digital dBm0	Analogue dBm
Conducted	0,15 to 30	-20 dB	55	-50	-50
	30 to 80	-10 dB	65	-40	-40
Radiated	80 to 1000	0 dB	75	-30	-30

For terminals connected to digital wired network ports (such as Ethernet, ISDN), measurements of the demodulated 1 kHz may be performed on a remote AE, ideally of the same design.

For all other devices:

The measured acoustic interference ratio and/or the measured electrical interference ratio during the test shall be –20 dB or better.

Performance criterion B:

Use the general performance criterion B. See GENERAL PERFORMANCE CRITERIA.

Performance criterion C:

Use the general performance criterion C. See GENERAL PERFORMANCE CRITERIA.

6.5 ELECTROSTATIC DISCHARGE IMMUNITY TEST (ESD)

6.5.1 TEST SPECIFICATION

Basic Standard	IEC 61000-4-2
Discharge Impedance	330 ohm / 150 pF
Required Performance	B
Discharge Voltage	Air Discharge: $\pm 2\text{kV}$, $\pm 4\text{kV}$, $\pm 8\text{kV}$ Contact Discharge: $\pm 2\text{kV}$, $\pm 4\text{kV}$
Polarity	Positive & Negative
Number of Discharge	20 times at each test point
Discharge Mode	Single Discharge
Discharge Period	1 second

6.5.2 MEASUREMENT INSTRUMENTS

Item	Kind of Equipment	Manufacturer	Type No.	Series Model	Calibrated until
1	ESD Generator	TESEQ AG	NSG 437	450	Sep. 07, 2020

Remark: "N/A" denotes no model no., no serial No. or no calibration specified.

All calibration period of equipment list is one year.

6.5.3 TEST PROCEDURE

The test generator necessary to perform direct and indirect application of discharges to the EUT in the following manner:

- a. The test shall be performed with single discharges. On each pre-selected point at least 10 single discharges (in the most sensitive polarity) shall be applied.

NOTE 1 The minimum number of discharges applied is depending on the EUT; for products with synchronized circuits the number of discharges should be larger.

For the time interval between successive single discharges an initial value of 1 s is recommended. Longer intervals may be necessary to determine whether a system failure has occurred.

NOTE 2 The points to which the discharges should be applied may be selected by means of an exploration carried out at a repetition rate of 20 discharges per second, or more.

Vertical Coupling Plane (VCP):

The coupling plane, of dimensions 0.5m x 0.5m, is placed parallel to, and positioned at a distance 0.1m from, the EUT, with the Discharge Electrode touching the coupling plane.

The four faces of the EUT will be performed with electrostatic discharge.

Horizontal Coupling Plane (HCP):

The coupling plane is placed under to the EUT. The generator shall be positioned vertically at a distance of 0.1m from the EUT, with the Discharge Electrode touching the coupling plane.

The four faces of the EUT will be performed with electrostatic discharge.

- b. For TABLE-TOP equipment:

The configuration consisted of a wooden table 0.8 meters high standing on the Ground Reference Plane. The GRP consisted of a sheet of aluminum at least 0.25mm thick, and 2.5 meters square connected to the protective grounding system. A Horizontal Coupling Plane (1.6m x 0.8m) was placed on the table and attached to the GRP by means of a cable with 940k total impedance. The equipment under test was installed in a representative system as described in IEC 61000-4-2, and its cables were placed on the HCP and isolated by an insulating support of 0.5mm thickness. A distance of 1-meter minimum was provided between the EUT and the walls of the laboratory and any other metallic structure.

6.5.4 DEVIATION FROM TEST STANDARD

No deviation

6.5.5 TEST SETUP

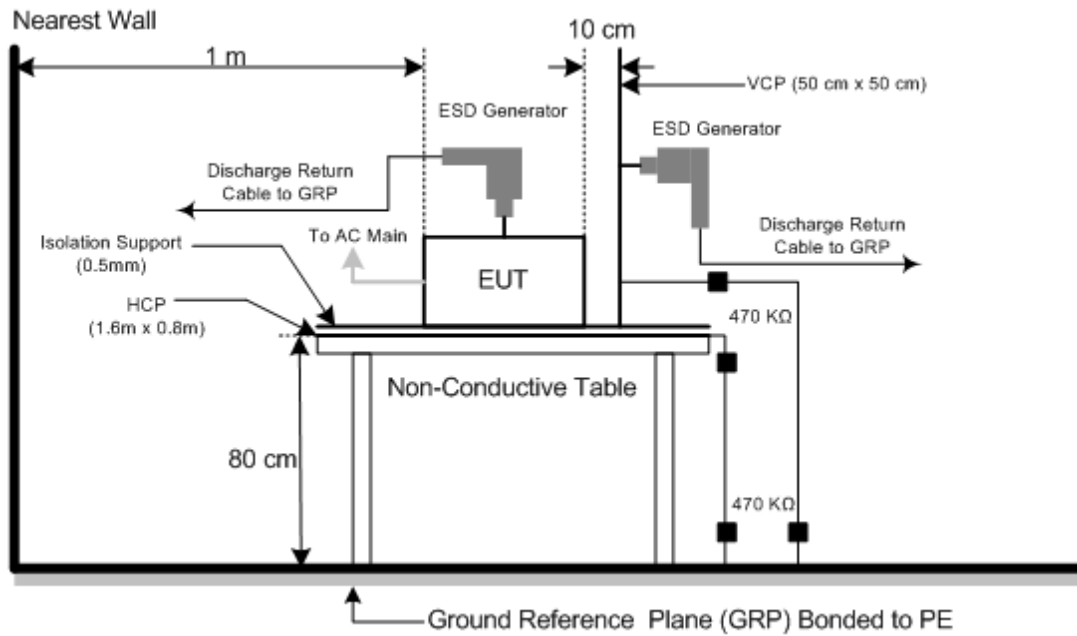

6.5.6 TEST RESULTS

Test Voltage	AC 230V/50Hz
Test Mode	Mode 1 ~ Mode 3, Mode 6, Mode 7

Mode	Air Discharge								Contact Discharge					
	2kV		4kV		8kV		- kV		2kV		4kV		- kV	
Location	P	N	P	N	P	N	P	N	P	N	P	N	P	N
1	A	A	A	A	B	B	-	-	A	A	B	B	-	-
2	A	A	A	A	B	B	-	-	-	-	-	-	-	-
3	A	A	A	A	B	B	-	-	-	-	-	-	-	-
4	A	A	A	A	A	A	-	-	-	-	-	-	-	-
5	A	A	A	A	A	A	-	-	-	-	-	-	-	-
Criteria	B						-		B				-	
Result	B						-		B				-	

Mode	HCP Contact Discharge						VCP Contact Discharge					
	2kV		4kV		- kV		2kV		4kV		- kV	
Location	P	N	P	N	P	N	P	N	P	N	P	N
Left side	A	A	A	A	-	-	A	A	A	A	-	-
Right side	A	A	A	A	-	-	A	A	A	A	-	-
Front side	A	A	A	A	-	-	A	A	A	A	-	-
Rear side	A	A	A	A	-	-	A	A	A	A	-	-
Criteria	B				-		B				-	
Result	A				-		A				-	

Note:

- 1) P/N denotes the Positive/Negative polarity of the output voltage.
- 2) N/A - denotes test is not applicable in this test report

PHOTO(S) SHOWN THE LOCATION(S) OF ESD EVALUATED

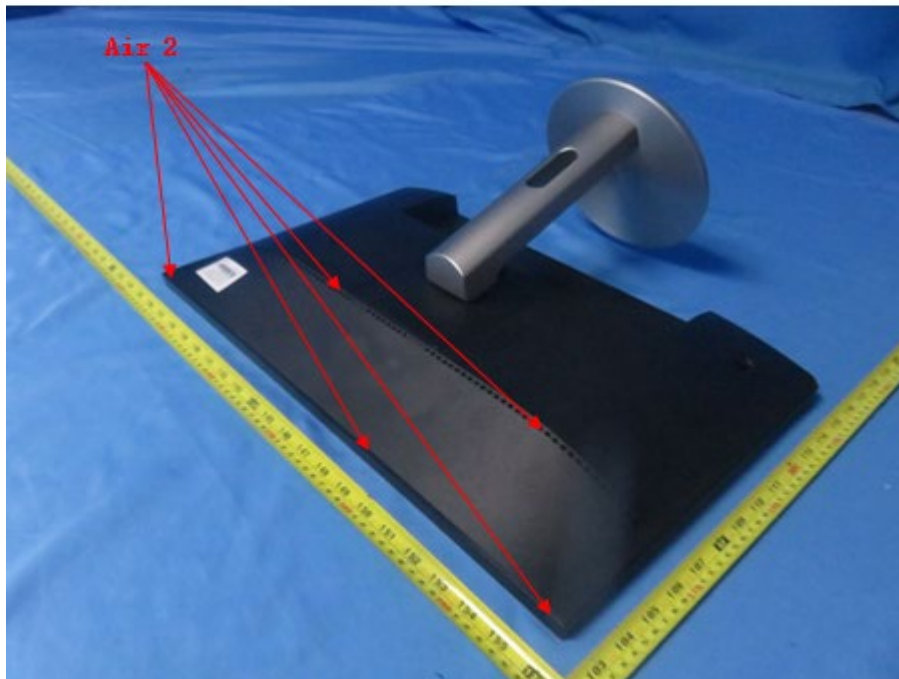
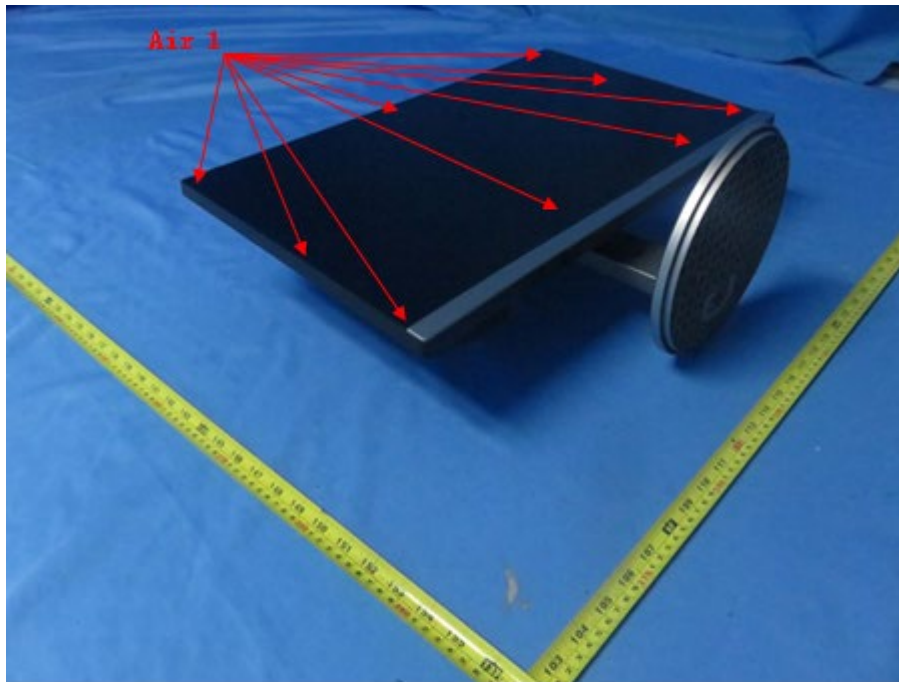

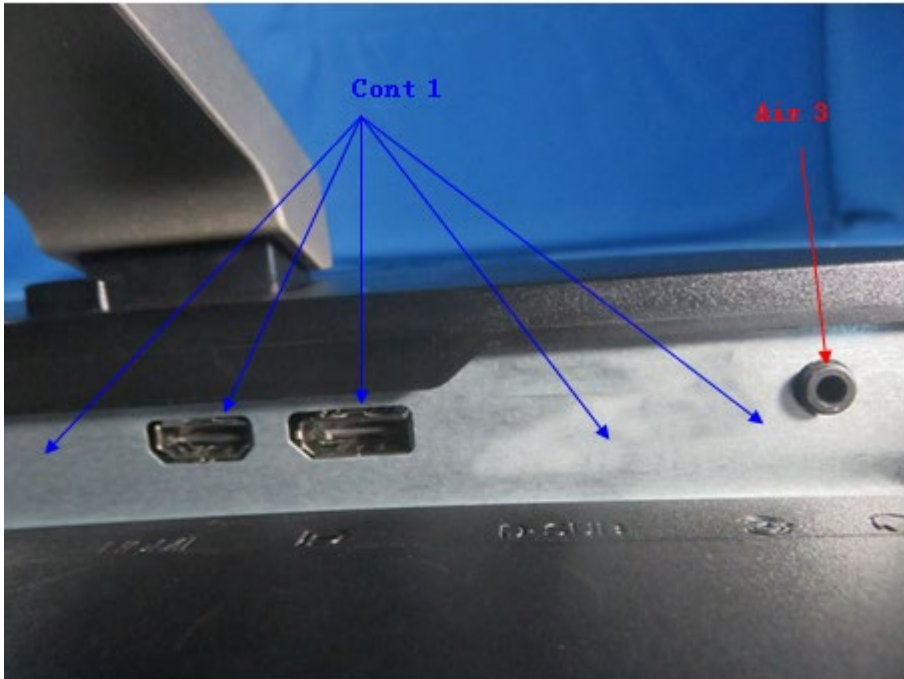

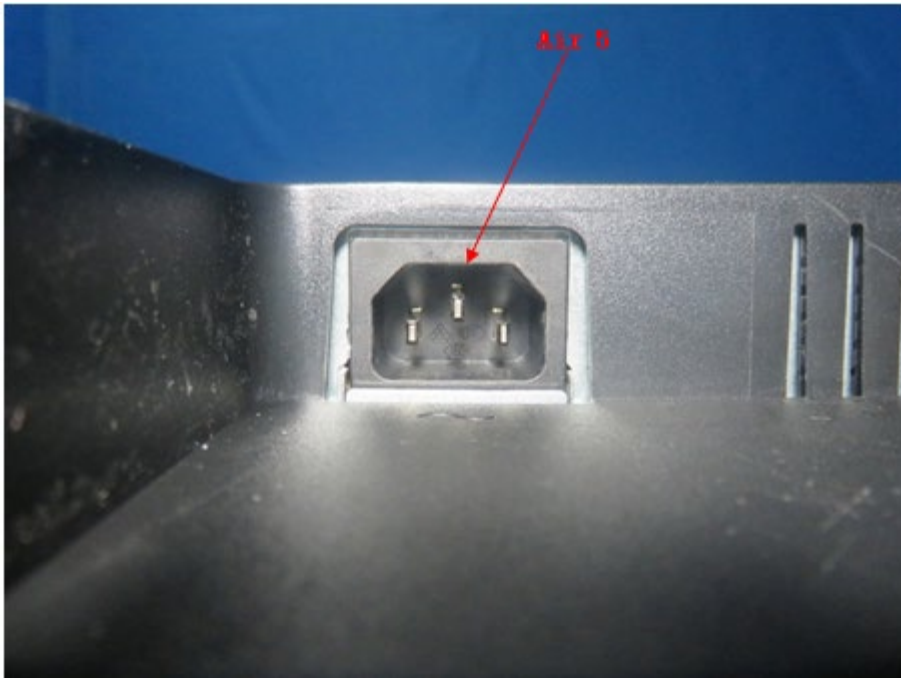

6.6 RADIATED, RADIO-FREQUENCY, ELECTROMAGNETIC FIELD IMMUNITY TEST (RS)

6.6.1 TEST SPECIFICATION

Basic Standard	IEC 61000-4-3
Required Performance	A
Frequency Range	80 MHz - 1000 MHz, 1800 MHz, 2600 MHz, 3500 MHz, 5000MHz
Field Strength	3 V/m(unmodulated, r.m.s)
Modulation	1 kHz Sine Wave, 80%, AM Modulation
Frequency Step	1% of fundamental
Polarity of Antenna	Horizontal and Vertical
Test Distance	3 m
Antenna Height	1.55 m
Dwell Time	3 seconds

6.6.2 MEASUREMENT INSTRUMENTS

Item	Kind of Equipment	Manufacturer	Type No.	Series Model	Calibrated until
1	Antenna	ETS	3142C	66462	Mar. 23, 2021
2*	Amplifier	AR	50S1G4A	326720	Apr. 08, 2021
3	MXG Analog Signal Generator	Agilent	N5181A	MY49060710	Aug. 03, 2020
4*	Power amplifier	MILMEGA	AS1860-50	1064834	Aug. 20, 2020
5	Microwave Log.-Per. Antenna	TESEQ	STLP 9149	9149-277	Apr. 14, 2021
6*	Power amplifier	MILMEGA	80RF1000-250	1064833	Aug. 20, 2020
7	Measurement Software	TOYO	IM5/RS Ver 3.8.050	N/A	N/A
8	Conditioning Amplifier	B&K	_2690__0F2_	2723746	Jun. 18, 2021
9	Free-field 1/2` Microphone	B&K	4190-L-001	2878077	Jun. 17, 2021

Remark: "N/A" denotes no model no., no serial No. or no calibration specified.

"**" calibration period of equipment list is three year.

Except * item, all calibration period of equipment list is one year.

6.6.3 TEST PROCEDURE

The EUT and support equipment are in a fully-anechoic chamber.

The testing distance from antenna to the EUT was 3 meters.

For TABLE-TOP equipment:

The EUT installed in a representative system as described in IEC 61000-4-3 was placed on a non-conductive table 0.8 meters in height. The system under test was connected to the power and signal wire according to relevant installation instructions.

The other condition as following manner:

- The field strength level was 3 V/m(unmodulated, r.m.s).
- The frequency range is swept from 80 MHz to 1000 MHz, with the signal 80%amplitude modulated with a 1 kHz sine wave. The rate of sweep did not exceed 1.5×10^{-3} decade/s. Where the frequency range is swept incrementally, the step size was 1% of fundamental.
- The dwell time at each frequency shall be not less than the time necessary for the EUT to be able to respond.
- The test was performed with the EUT exposed to both vertically and horizontally polarized fields on each of the four sides.

For Display and display output functions:

- a. The display quality evaluated by direct observation.
- b. For display output function evaluation, a suitable display device shall be connected. This device shall meet the immunity requirements for displays specified in this document. The screen size shall be typical for the display output. the diagonal screen size shall be at least 0,50 m.
- c. The display shall be observed under normal viewing conditions including viewing distance using a reduced ambient light level preferably in the range 15 lx to 20 lx. The viewing distance or settings of the video camera monitoring system shall be sufficient to provide visibility of the whole display. In the case of direct observation the selected viewing distance shall be recorded in the test report.

For Acoustic measurements:

- a. Apply an appropriate input signal to the EUT so that a sine wave (tone) at the frequency that will be used to modulate the applied disturbance (typically 1 kHz) is generated from the port under test at a level equal to the acoustic reference level.
- b. Record the resulting dB (SPL) level (or other appropriate dB unit) as the value of L_0 . (BTL lab uses the software to take L_0 as the reference value and make it return to zero.)
- c. Change the input to the EUT so that the port under test is silent, or represents silence. This change shall not alter the terminating impedance at the EUT's input.
- d. Apply the RF disturbance to the applicable port of the EUT and record the resulting demodulated audio level in dB (SPL) (or other dB unit used in step d)) as the value of L_1 .
- e. Ensure that non-linear processing does not impact the measurements.
- f. Calculate the acoustic interference ratio using the following formula:
 Acoustic interference ratio = $L_1 - L_0$.
 (For step e-g, BTL lab proceeds the test with software and calculate Acoustic interference ratio = $L_1 - L_0$).

6.6.4 DEVIATION FROM TEST STANDARD

No deviation

6.6.5 TEST SETUP

- a) For Continuous induced RF disturbances

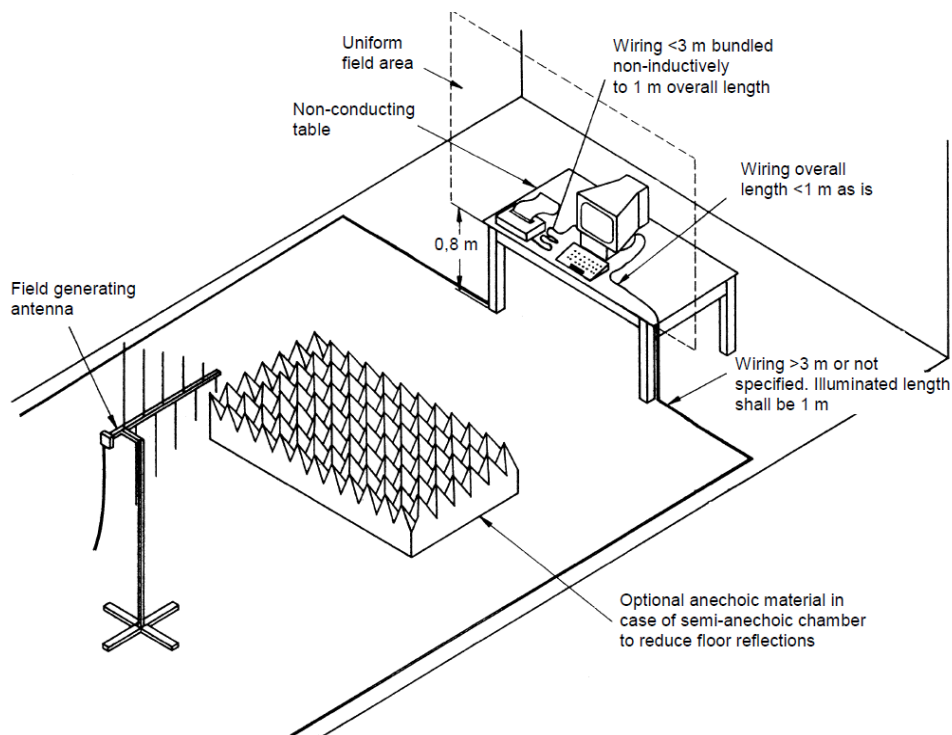

For Audio output function

(1) Audio output port

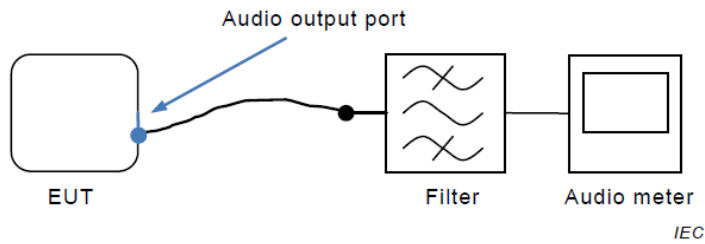

The filter is the audio filter specified in G.6.1 and is typically incorporated into the audio meter. Additional filtering might be necessary to ensure that the RF disturbance signal does not interfere with the measurement.

(2) Loudspeaker

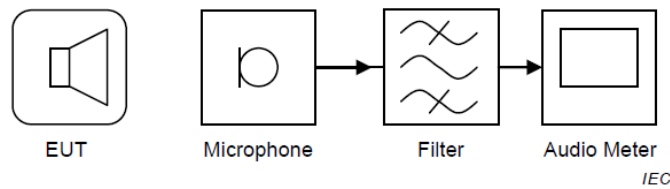

The filter is the audio filter specified in G.6.1 and is typically incorporated into the audio meter. Additional filtering might be necessary to ensure that the RF disturbance signal does not interfere with the measurement.

6.6.6 TEST RESULTS

Test Voltage	AC 230V/50Hz
Test Mode	Mode 1 ~ Mode 3, Mode 6, Mode 7

Frequency Range (MHz)	RF Field Position	R.F. Field Strength	Modulation	Azimuth	Criterion	Result
80 - 1000	H / V	3V/m	AM Modulated 1000Hz, 80%	0	A	A
				90		
				180		
				270		
1800, 2600, 3500, 5000 (±1%)	H / V	3V/m	AM Modulated 1000Hz, 80%	0	A	A
				90		
				180		
				270		

For Audio output function

(1) Audio output port:

Test Voltage	AC 230V/50Hz
Test Mode	Mode 1_Vertical_Front

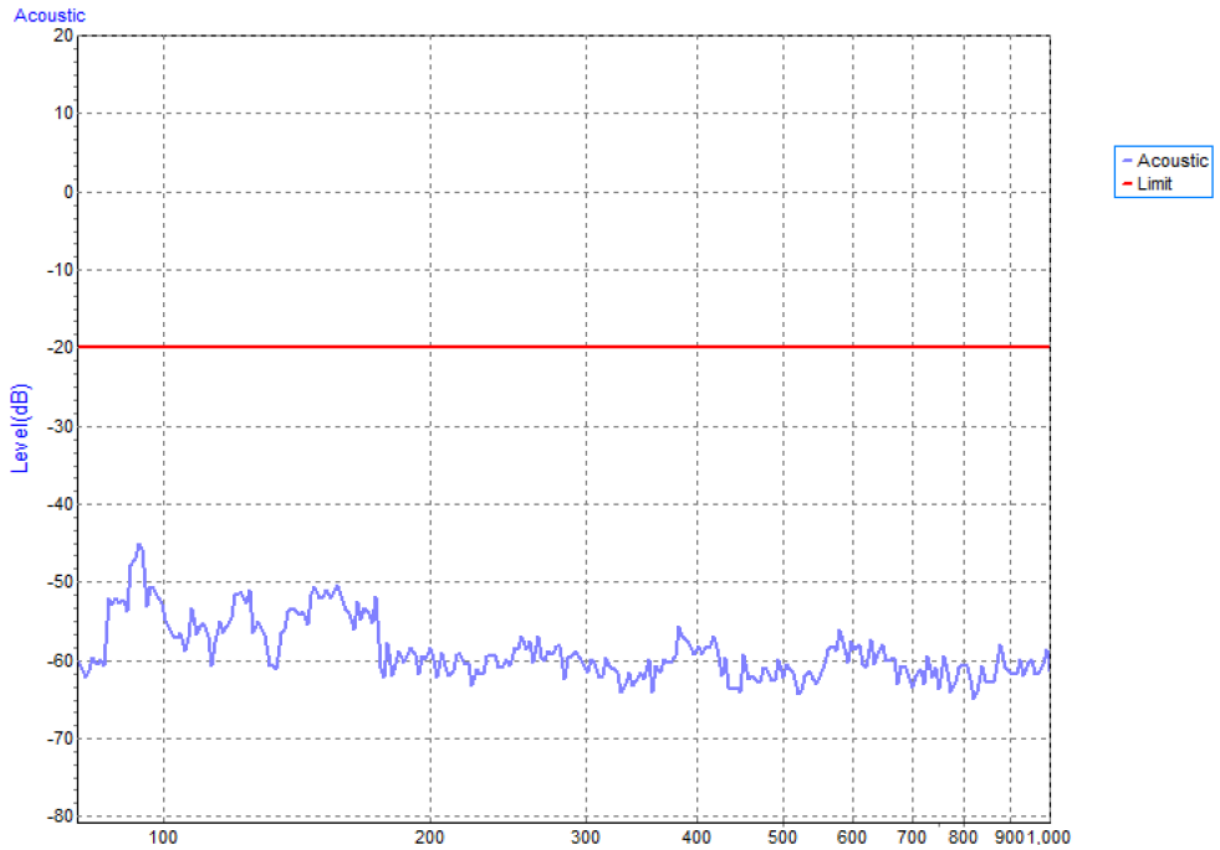

Test Voltage	AC 230V/50Hz
Test Mode	Mode 1_Horizontal_Front

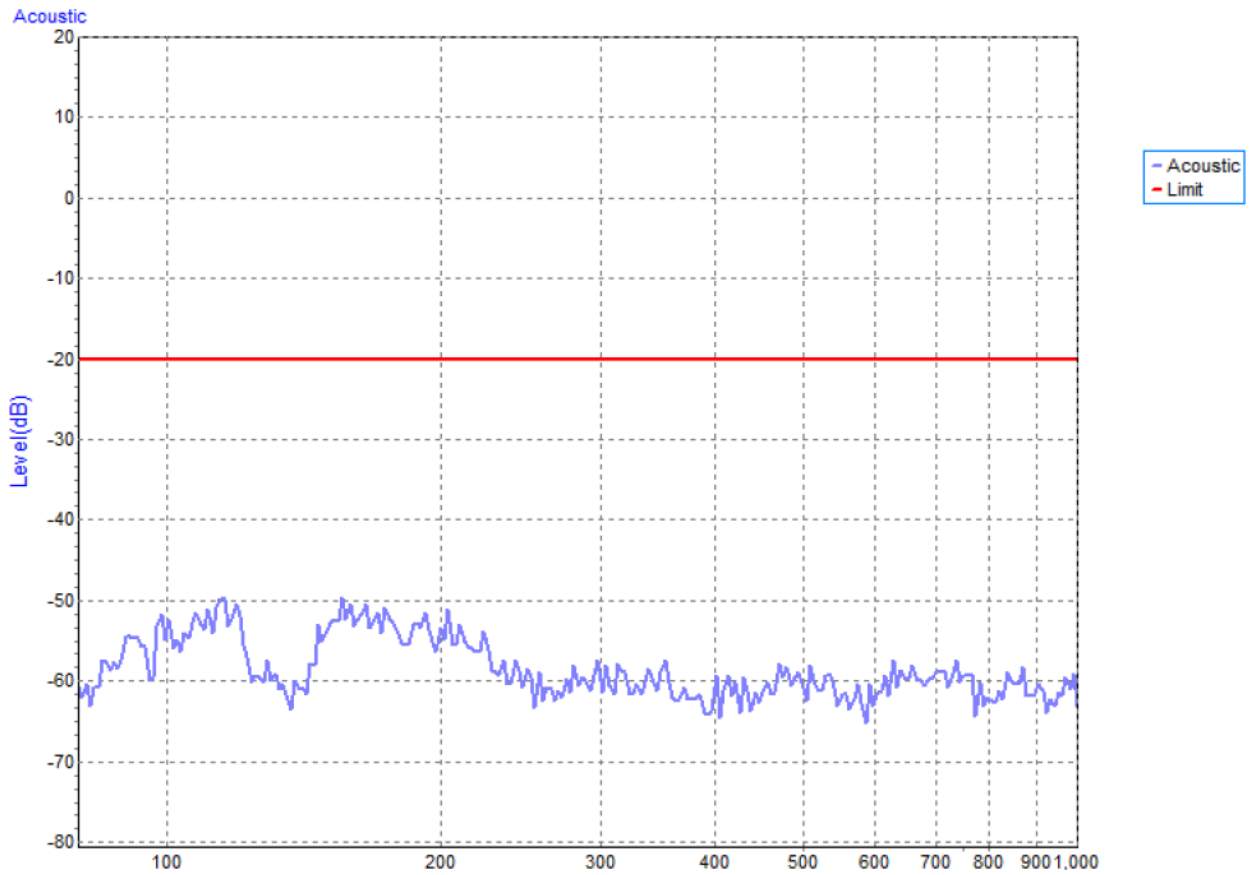

(2) Loudspeaker:

Test Voltage	AC 230V/50Hz
Test Mode	Mode 1_Vertical_Rear

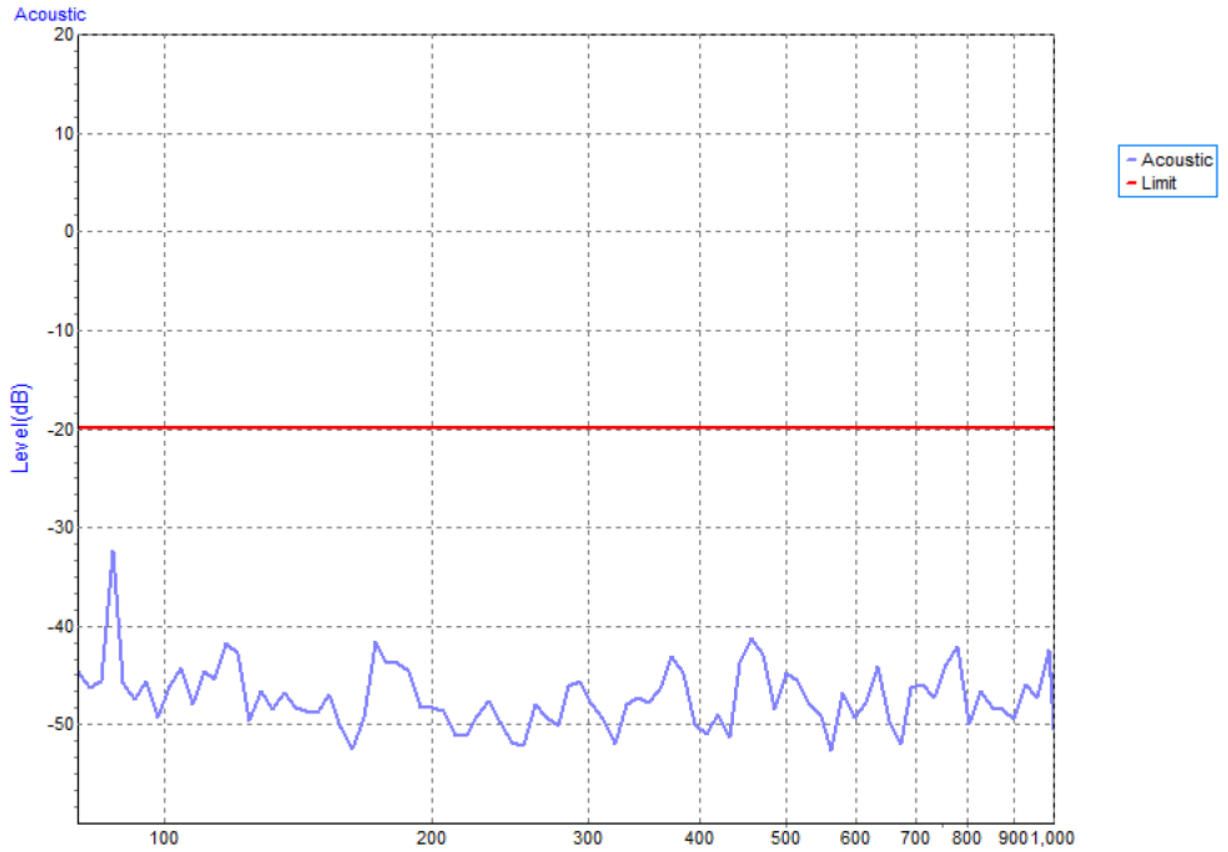

Test Voltage	AC 230V/50Hz
Test Mode	Mode 1_Horizontal_Rear

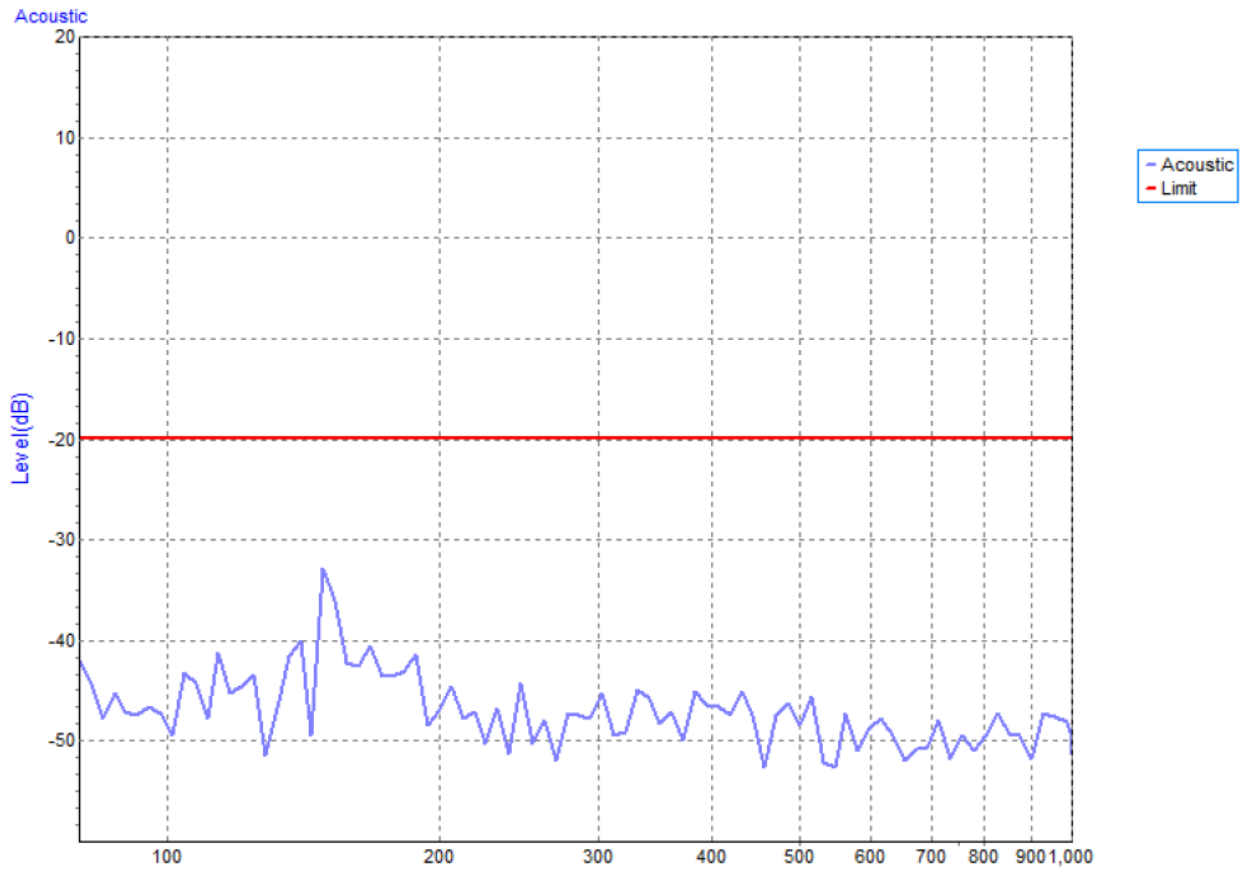

6.7 ELECTRICAL FAST TRANSIENT/BURST IMMUNITY TEST (EFT/BURST)

6.7.1 TEST SPECIFICATION

Basic Standard	IEC 61000-4-4
Required Performance	B
Test Voltage	AC Power Ports:±1 kV
Polarity	Positive & Negative
Impulse Frequency	5 kHz: except for xDSL ports.
Impulse Wave shape	5/50 ns
Burst Duration	15 ms
Burst Period	300 ms
Test Duration	1 min.

6.7.2 MEASUREMENT INSTRUMENTS

Item	Kind of Equipment	Manufacturer	Type No.	Series Model	Calibrated until
1	Fast Transient Burst Simulator	Prima	EFT61004TA	PR190741004	Aug. 27, 2020

Remark: "N/A" denotes no model no., no serial No. or no calibration specified.

All calibration period of equipment list is one year.

6.7.3 TEST PROCEDURE

For TABLE-TOP equipment:

The configuration consisted of a wooden table (0.8m high) standing on the Ground Reference Plane and should be located 0.1 m+/- 0.01m above the Ground Reference Plane. The GRP consisted of a sheet of aluminum (at least 0.25mm thick and 2.5m square) connected to the protective grounding system. A minimum distance of 0.5m was provided between the EUT and the walls of the laboratory or any other metallic structure.

The other condition as following manner:

- a. Both positive and negative polarity discharges were applied.
- b. The duration time of each test sequential was 1 minute.

6.7.4 DEVIATION FROM TEST STANDARD

No deviation

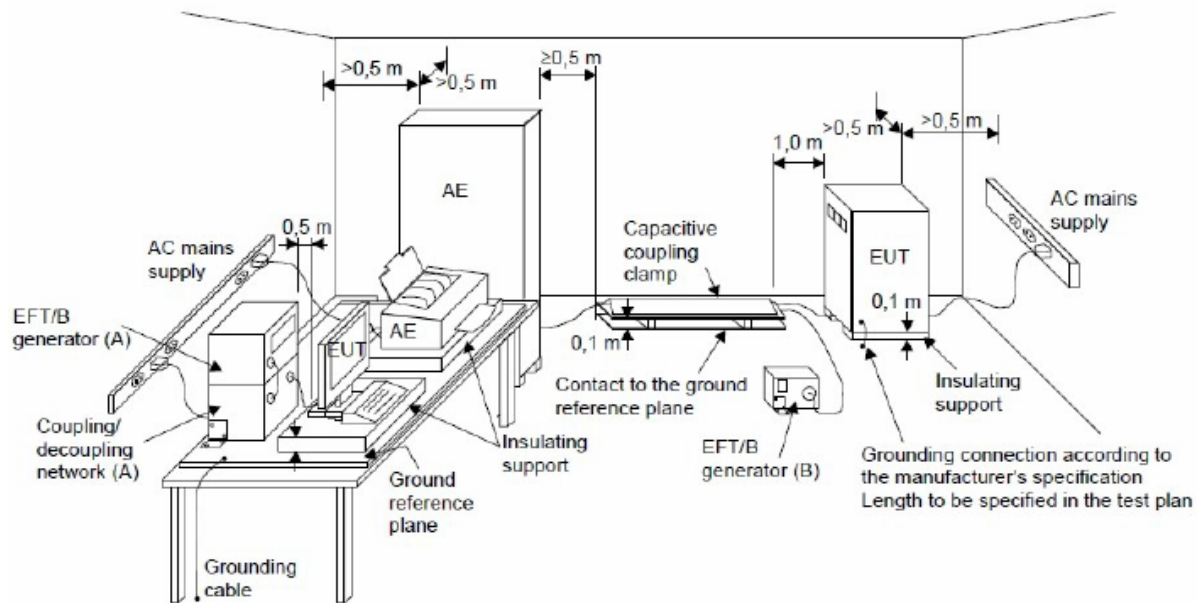
6.7.5 TEST SETUP

6.7.6 TEST RESULTS

Test Voltage	AC 230V/50Hz
Test Mode	Mode 1 ~ Mode 3, Mode 6, Mode 7

EUT Ports Tested	Polarity	Repetition Frequency	Test Level	Criterion	Result	
			1kV			
AC Power Port	Line (L)	+	5 kHz	A	B	A
		-	5 kHz	A		
	Neutral (N)	+	5 kHz	A	B	A
		-	5 kHz	A		
	Ground (PE)	+	5 kHz	A	B	A
		-	5 kHz	A		
	L+N	+	5 kHz	A	B	A
		-	5 kHz	A		
	L+PE	+	5 kHz	A	B	A
		-	5 kHz	A		
	N+PE	+	5 kHz	A	B	A
		-	5 kHz	A		
	L+N+PE	+	5 kHz	A	B	A
		-	5 kHz	A		

6.8 SURGE IMMUNITY TEST

6.8.1 TEST SPECIFICATION

Basic Standard	IEC 61000-4-5
Required Performance	B
Wave-Shape	1.2/50(8/20) Tr/Th μ s combination wave
Test Voltage	AC Power Port: ± 0.5 kV, ± 1 kV, ± 2 kV
Generator Source Impedance	2 Ω of the low-voltage power supply network. 12 Ω (10 Ω +2 Ω) of the low-voltage power supply network and ground.
Phase Angle, Polarity and Number of Tests	Five positive pulses line-to-neutral at 90° phase Five negative pulses line-to-neutral at 270° phase Five positive pulses line-to-earth at 90° phase Five negative pulses line-to-earth at 270° phase Five negative pulses neutral-to-earth at 90° phase Five positive pulses neutral-to-earth at 270° phase
Pulse Repetition Rate	1 time / min.

6.8.2 MEASUREMENT INSTRUMENTS

Item	Kind of Equipment	Manufacturer	Type No.	Series Model	Calibrated until
1	Lightning Surge Generator	Prima	SUG61005TB	PR190854067	Aug. 27, 2020

Remark: "N/A" denotes no model no., no serial No. or no calibration specified.

All calibration period of equipment list is one year.

6.8.3 TEST PROCEDURE

a. For EUT power supply:

The surge is to be applied to the EUT power supply terminals via the capacitive coupling network. Decoupling networks are required in order to avoid possible adverse effects on equipment not under test that may be powered by the same lines, and to provide sufficient decoupling impedance to the surge wave. The power cord between the EUT and the coupling/decoupling networks shall be 2 meters in length (or shorter).

b. For test applied to unshielded unsymmetrically operated interconnection lines of EUT :

The surge is applied to the lines via the capacitive coupling. The coupling /decoupling networks shall not influence the specified functional conditions of the EUT. The interconnection line between the EUT and the coupling/decoupling networks shall be 2 meters in length (or shorter).

c. For test applied to unshielded symmetrically operated interconnection /telecommunication lines of EUT :

The surge is applied to the lines via gas arrestors coupling. Test levels below the ignition point of the coupling arrestor cannot be specified. The interconnection line between the EUT and the coupling/decoupling networks shall be 2 meters in length (or shorter).

6.8.4 DEVIATION FROM TEST STANDARD

No deviation

6.8.5 TEST SETUP

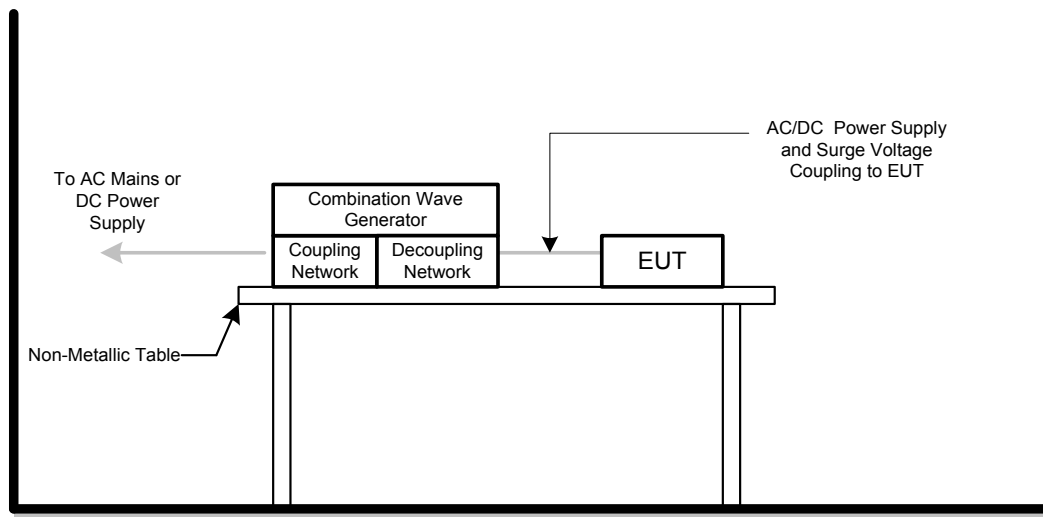

6.8.6 TEST RESULTS

Test Voltage	AC 230V/50Hz
Test Mode	Mode 1 ~ Mode 3, Mode 6, Mode 7

Wave Form EUT Ports Tested		1.2/50(8/20)Tr/Th μ s						Criterion	Result
		Polarity	Phase	Voltage					
				0.5kV	1kV	-- kV	-- kV		
AC	L - N	+	90°	A	A	-	-	B	A
		-	270°	A	A	-	-		

Wave Form EUT Ports Tested		1.2/50(8/20)Tr/Th μ s						Criterion	Result
		Polarity	Phase	Voltage					
				0.5kV	1kV	2kV	-- kV		
AC	L - PE	+	90°	A	A	A	-	B	A
		-	270°	A	A	A	-		
	N - PE	-	90°	A	A	A	-	B	A
		+	270°	A	A	A	-		

6.9 IMMUNITY TO CONDUCTED DISTURBANCES, INDUCED BY RADIO-FREQUENCY FIELDS TEST (CS)

6.9.1 TEST SPECIFICATION

Basic Standard	IEC 61000-4-6
Required Performance	A
Frequency Range&Field Strength	0.15 MHz - 10 MHz: 3V (unmodulated, r.m.s.) 10 MHz - 30 MHz: 3V to 1V (unmodulated, r.m.s.) 30 MHz - 80 MHz: 1V (unmodulated, r.m.s.)
Modulation	1 kHz Sine Wave, 80%, AM Modulation
Frequency Step	1% of fundamental
Dwell Time	3 seconds

6.9.2 MEASUREMENT INSTRUMENTS

Item	Kind of Equipment	Manufacturer	Type No.	Series Model	Calibrated until
1	Power CDN	FCC	FCC-801-M2/ M3-16A	100270	Feb. 28, 2021
2	TEST SYSTEM FOR CONDUCTED AND RADIATED IMMUNITY	TESEQ	NSG 4070B	37513	Aug. 03, 2020
3	Measurement Software	Farad	EZ-CS (V2.0.1.2)	N/A	N/A
4	Conditioning Amplifier	B&K	2690 0F2	2723746	Jun. 18, 2021
5	Free-field 1/2" Microphone	B&K	4190-L-001	2878077	Jun. 17, 2021

Remark: "N/A" denotes no model no., no serial No. or no calibration specified.

All calibration period of equipment list is one year.

6.9.3 TEST PROCEDURE

The equipment to be tested is placed on an insulating support of 0.1m height above a reference ground plane. All cables exiting the EUT shall be supported at a height of at least 30 mm above the reference ground plane. All relevant cables shall be provided with the appropriate coupling and decoupling devices at a distance between 0.1 meters and 0.3 meters from the projected geometry of the EUT on the ground reference plane.

The other condition as following manner:

- The field strength level was 3 V (unmodulated, r.m.s.)
- The frequency range is swept from 150 kHz to 80 MHz, with the signal 80%amplitude modulated with a 1 kHz sine wave. The rate of sweep did not exceed 1.5x 10⁻³ decade/s. Where the frequency range is swept incrementally, the step size was 1% of fundamental.
- The dwell time at each frequency shall be not less than the time necessary for the EUT to be able to respond.

For Display and display output functions:

- The display quality evaluated by direct observation.
- For display output function evaluation, a suitable display device shall be connected. This device shall meet the immunity requirements for displays specified in this document. The screen size shall be typical for the display output.the diagonal screen size shall be at least 0,50 m.
- The display shall be observed under normal viewing conditions including viewing distance using a reduced ambient light level preferably in the range 15 lx to 20 lx. The viewing distance or settings of the video camera monitoring system shall be sufficient to provide visibility of the whole display. In the case of direct observation the selected viewing distance shall be recorded in the test report.

For Acoustic measurements:

- a. Apply an appropriate input signal to the EUT so that a sine wave (tone) at the frequency that will be used to modulate the applied disturbance (typically 1 kHz) is generated from the port under test at a level equal to the acoustic reference level.
- b. Record the resulting dB (SPL) level (or other appropriate dB unit) as the value of L_0 . (BTL lab uses the software to take L_0 as the reference value and make it return to zero.)
- c. Change the input to the EUT so that the port under test is silent, or represents silence. This change shall not alter the terminating impedance at the EUT's input.
- d. Apply the RF disturbance to the applicable port of the EUT and record the resulting demodulated audio level in dB (SPL) (or other dB unit used in step d)) as the value of L_1 .
- e. Ensure that non-linear processing does not impact the measurements.
- f. Calculate the acoustic interference ratio using the following formula:
 Acoustic interference ratio = $L_1 - L_0$.
 (For step e-g, BTL lab proceeds the test with software and calculate Acoustic interference ratio = $L_1 - L_0$).

6.9.4 DEVIATION FROM TEST STANDARD

No deviation

6.9.5 TEST SETUP

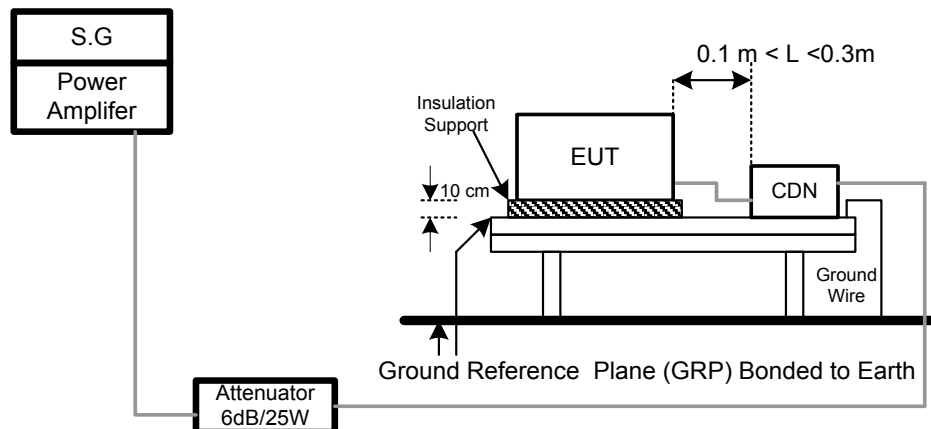

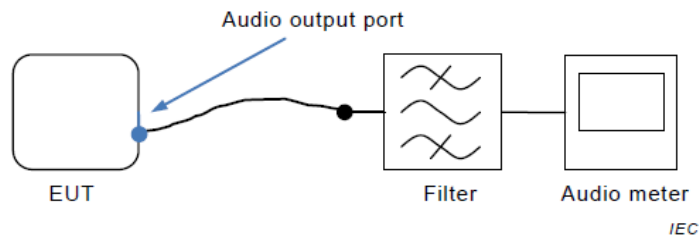
For Audio output function**(1) Audio output port**

The filter is the audio filter specified in G.6.1 and is typically incorporated into the audio meter. Additional filtering might be necessary to ensure that the RF disturbance signal does not interfere with the measurement.

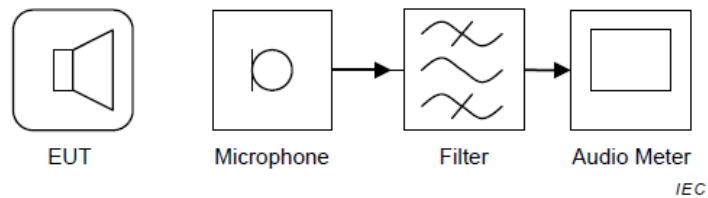
(2) Loudspeaker

The filter is the audio filter specified in G.6.1 and is typically incorporated into the audio meter. Additional filtering might be necessary to ensure that the RF disturbance signal does not interfere with the measurement.

6.9.6 TEST RESULTS

Test Voltage	AC 230V/50Hz
Test Mode	Mode 1 ~ Mode 3, Mode 6, Mode 7

Test Ports (Mode)	Freq.Range (MHz)	Field Strength	Modulation	Criteria	Results
AC mains power ports	0.15 - 10	3V	AM Modulated 1000Hz, 80%	A	A
	10 - 30	3V to 1V			
	30 - 80	1V			

(1) Audio output port:

Test Voltage	AC 230V/50Hz
Test Mode	Mode 1_CDN M3

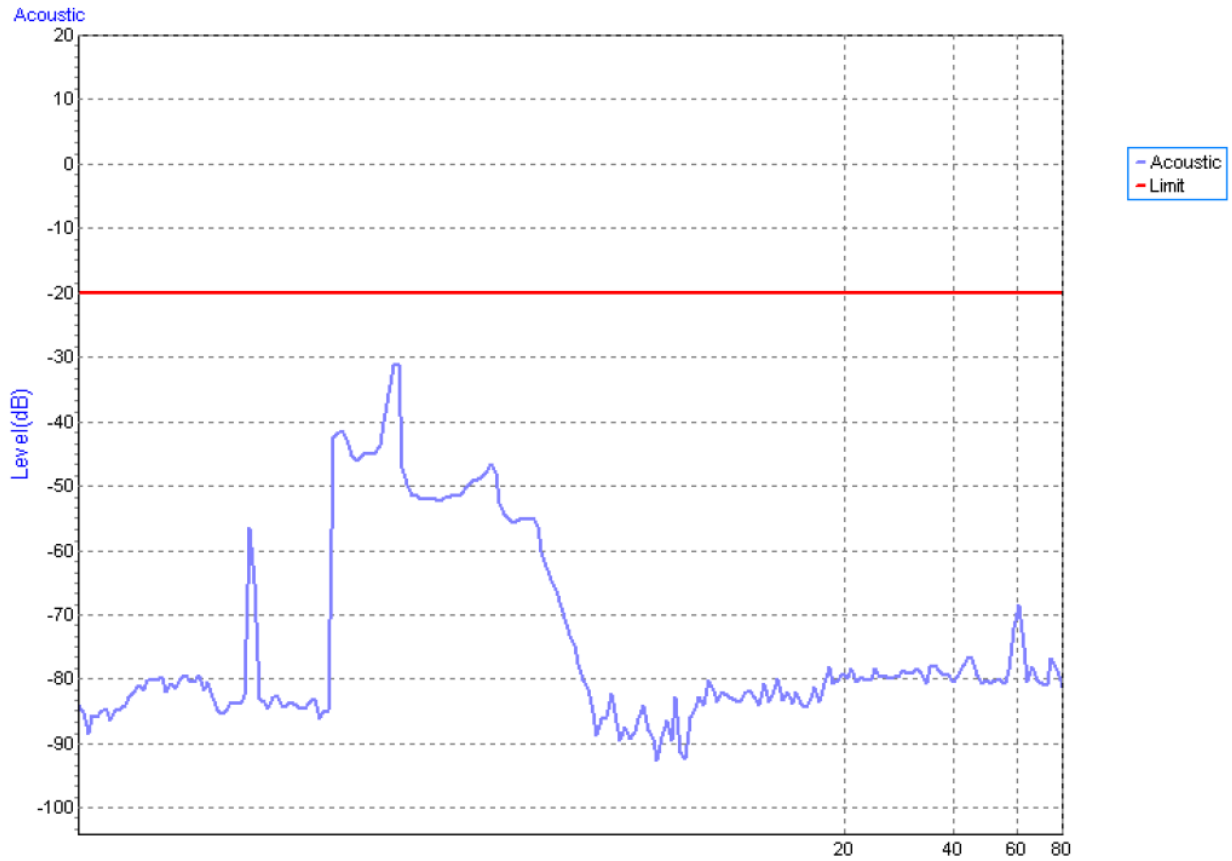

(2) Loudspeaker:

Test Voltage	AC 230V/50Hz
Test Mode	Mode 1_CDN M3

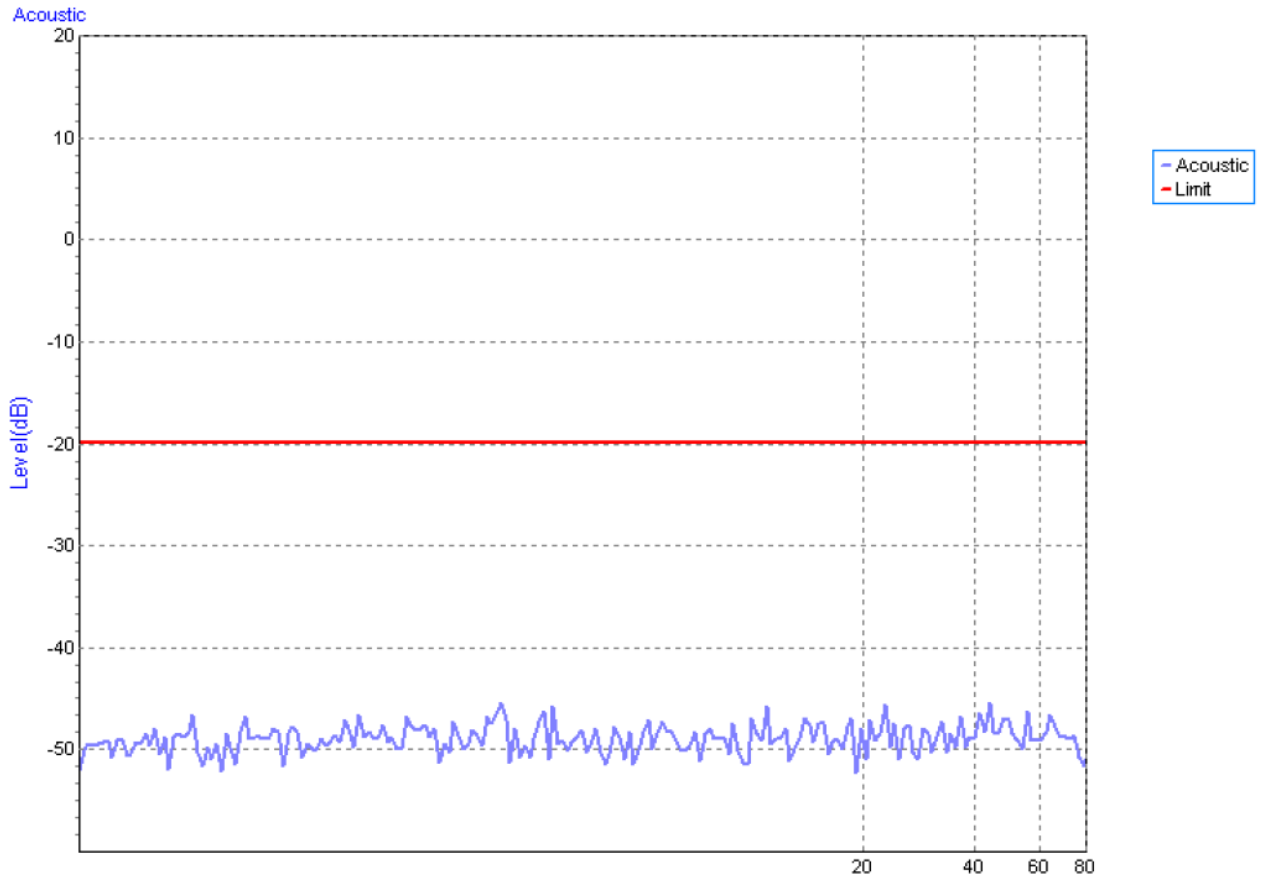

6.10 POWER FREQUENCY MAGNETIC FIELD IMMUNITY TEST (PFMF)

6.10.1 TEST SPECIFICATION

Basic Standard	IEC 61000-4-8
Required Performance	A
Frequency Range	50/60 Hz
Field Strength	1 A/m
Observation Time	1 minute
Inductance Coil	Rectangular type, 1mx1m

6.10.2 MEASUREMENT INSTRUMENTS

Item	Kind of Equipment	Manufacturer	Type No.	Series Model	Calibrated until
1	Magnetic Field test Generator	FCC	F-1000-4-8-G-125A	4032	Mar. 01, 2021
2	Magnetic Field immunity loop	Thermo KeyTek	F-1000-4-8/9/10-L-1M	4024	Mar. 01, 2021

Remark: "N/A" denotes no model no., no serial No. or no calibration specified.

All calibration period of equipment list is one year.

6.10.3 TEST PROCEDURE

For TABLE-TOP equipment:

The equipment shall be subjected to the test magnetic field by using the induction coil of standard dimension (1 m x 1 m). The induction coil shall then be rotated by 90 degrees in order to expose the EUT to the test field with different orientations.

The other condition as following manner:

- a. The equipment cabinets shall be connected to the safety earth directly on the GRP via the earth terminal of the EUT.
- b. The cables supplied or recommended by the equipment manufacturer shall be used. 1 meter of all cables used shall be exposed to the magnetic field.

6.10.4 DEVIATION FROM TEST STANDARD

No deviation

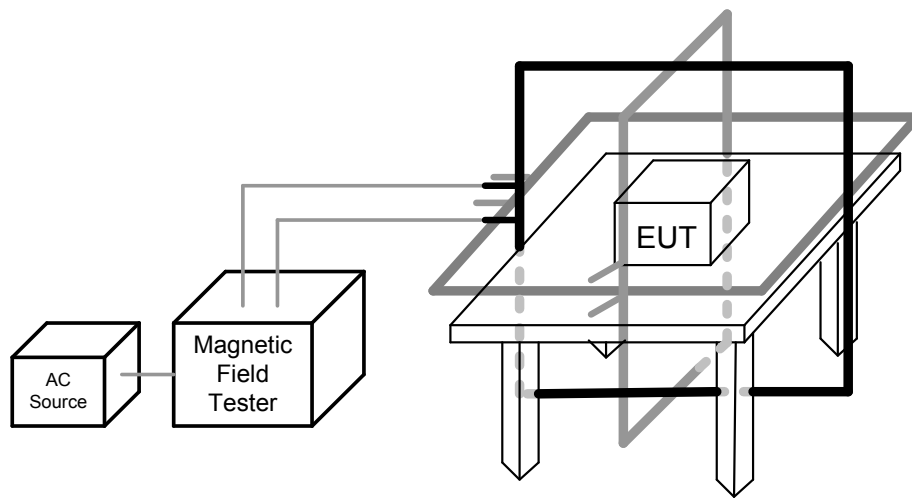
6.10.5 TEST SETUP

6.10.6 TEST RESULTS

Test Voltage	AC 230V/50Hz
Test Mode	Mode 1 ~ Mode 3, Mode 6, Mode 7

50Hz

Test Mode	Test Level	Antenna aspect	Duration (s)	Criteria	Results
Enclosure	1 A/m	X	60	A	A
Enclosure	1 A/m	Y	60	A	A
Enclosure	1 A/m	Z	60	A	A

60Hz

Test Mode	Test Level	Antenna aspect	Duration (s)	Criteria	Results
Enclosure	1 A/m	X	60	A	A
Enclosure	1 A/m	Y	60	A	A
Enclosure	1 A/m	Z	60	A	A

6.11 VOLTAGE DIPS, SHORT INTERRUPTIONS AND VOLTAGE VARIATIONS IMMUNITY TEST (DIPS)

6.11.1 TEST SPECIFICATION

Basic Standard	IEC 61000-4-11
Required Performance	Voltage dips: B (For <5% residual voltage, dips) C (For 70% residual voltage, dips) C (For <5% residual voltage, Interruptions)
Interval between Event	Ten seconds
Phase Angle	0°/180°
Test Cycle	3 times

6.11.2 MEASUREMENT INSTRUMENTS

Item	Kind of Equipment	Manufacturer	Type No.	Series Model	Calibrated until
1	Cycle Sag Simulator	Prima	DRP61011TA	PR19076452	Aug. 27, 2020

Remark: "N/A" denotes no model no., no serial No. or no calibration specified.

All calibration period of equipment list is one year.

6.11.3 TEST PROCEDURE

The EUT shall be tested for each selected combination of test levels and duration with a sequence of three dips/interruptions with intervals of 10 s minimum (between each test event). Each representative mode of operation shall be tested. Abrupt changes in supply voltage shall occur at zero crossings of the voltage waveform.

6.11.4 DEVIATION FROM TEST STANDARD

No deviation

6.11.5 TEST SETUP

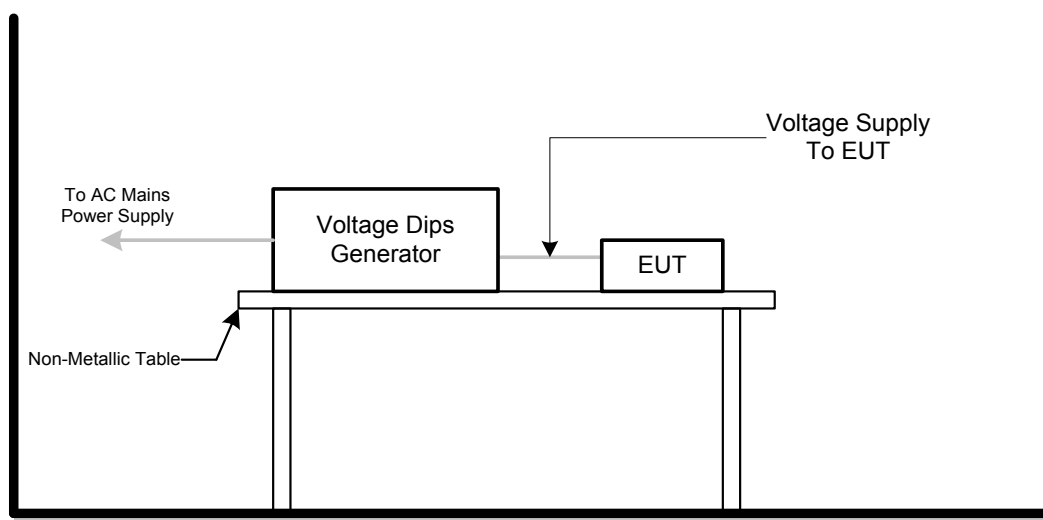

6.11.6 TEST RESULTS

Test Voltage	AC 100V/50Hz, AC 230V/50Hz, AC 240V/50Hz
Test Mode	Mode 1 ~ Mode 3, Mode 6, Mode 7

AC 100V/50Hz				
Item	Residual Voltage	Cycle	Criteria	Results
Voltage dips	<5%	0.5	B	A
Voltage dips	70%	25	C	A
Voltage Interruption	<5%	250	C	C

AC 230V/50Hz				
Item	Residual Voltage	Cycle	Criteria	Results
Voltage dips	<5%	0.5	B	A
Voltage dips	70%	25	C	A
Voltage Interruption	<5%	250	C	C

AC 240V/50Hz				
Item	Residual Voltage	Cycle	Criteria	Results
Voltage dips	<5%	0.5	B	A
Voltage dips	70%	25	C	A
Voltage Interruption	<5%	250	C	C

7. EUT TEST PHOTO

EN 55032:2010+AC:2013

Radiated emissions up to 1 GHz

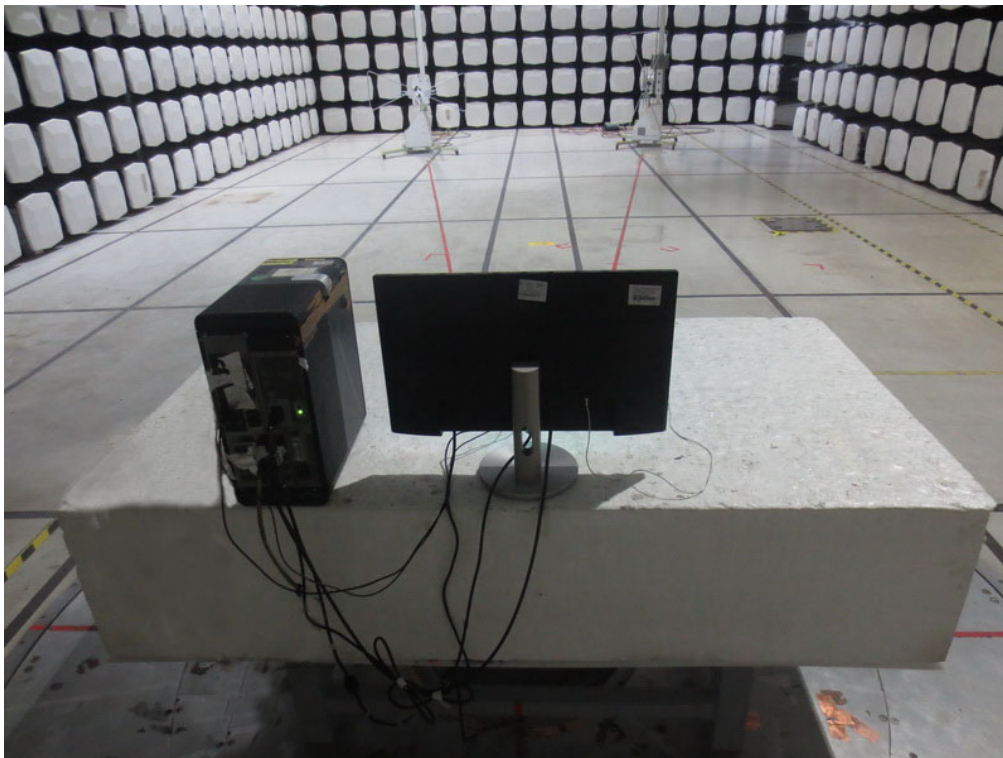
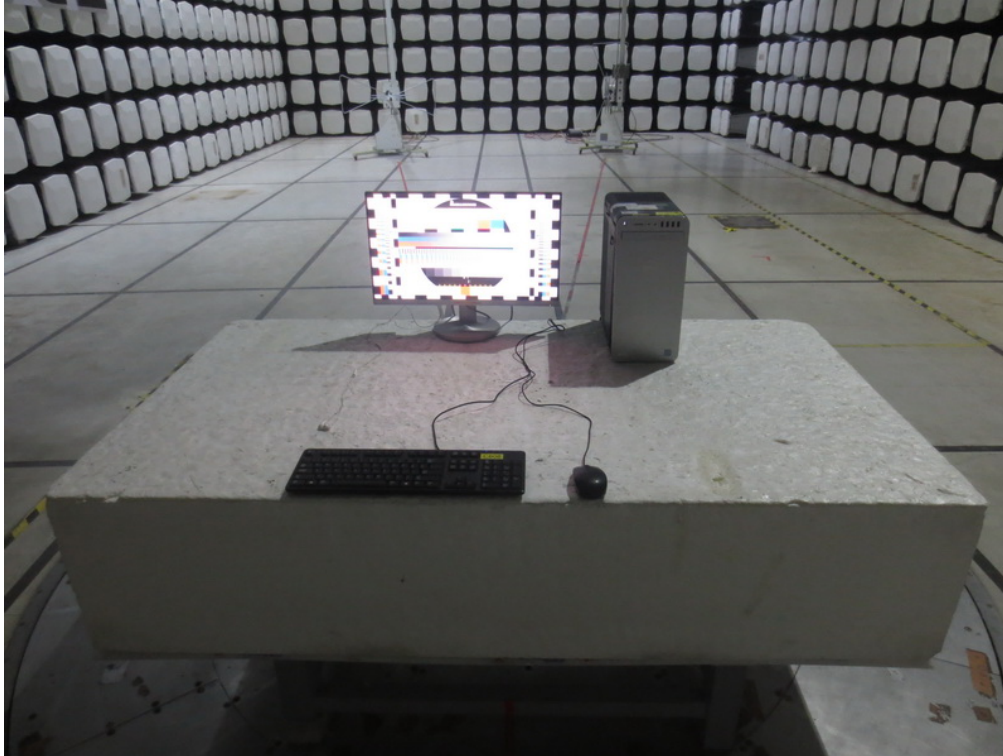

Radiated emissions above 1 GHz

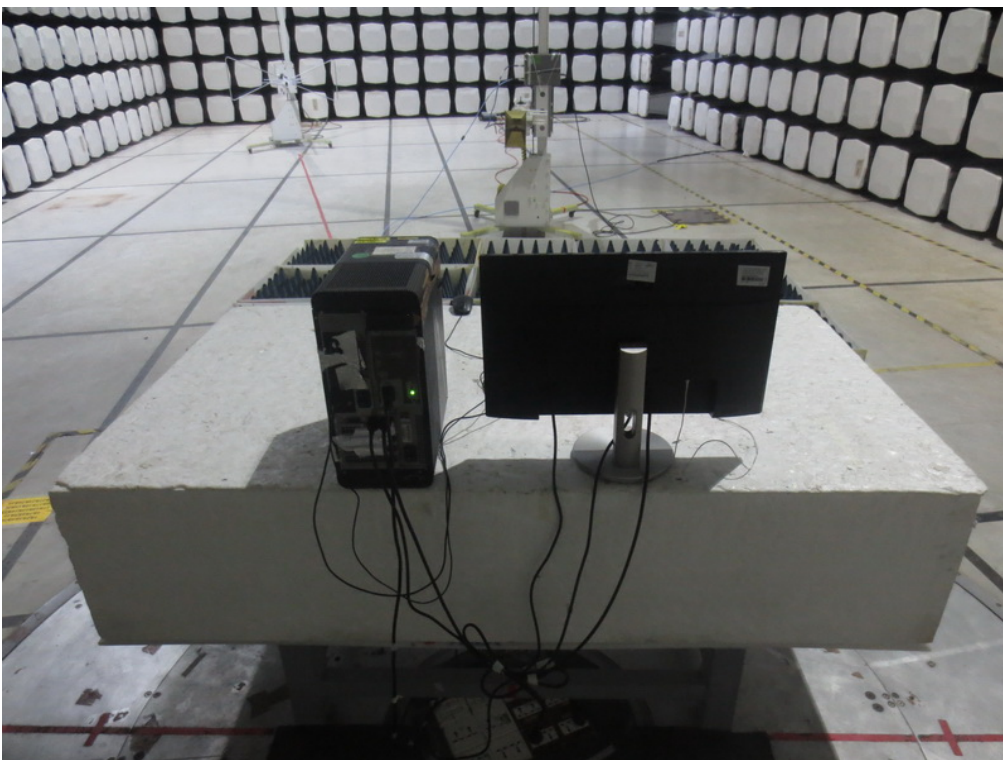
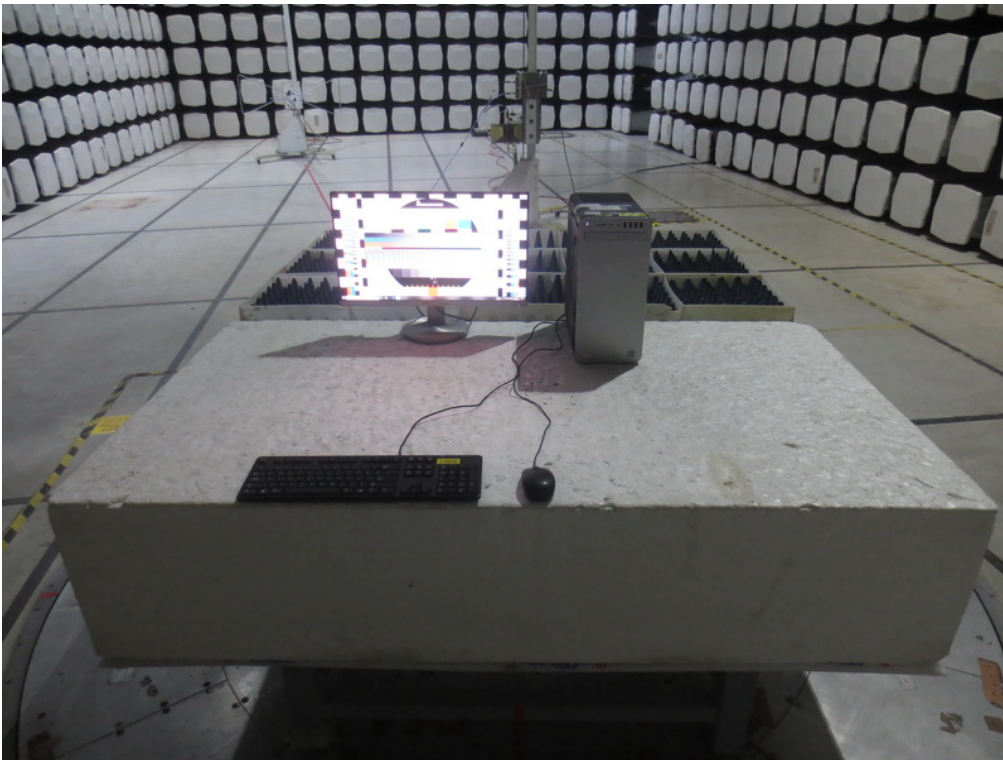

Conducted emissions AC mains power port



EN 55032:2015+AC:2016

Radiated emissions up to 1 GHz

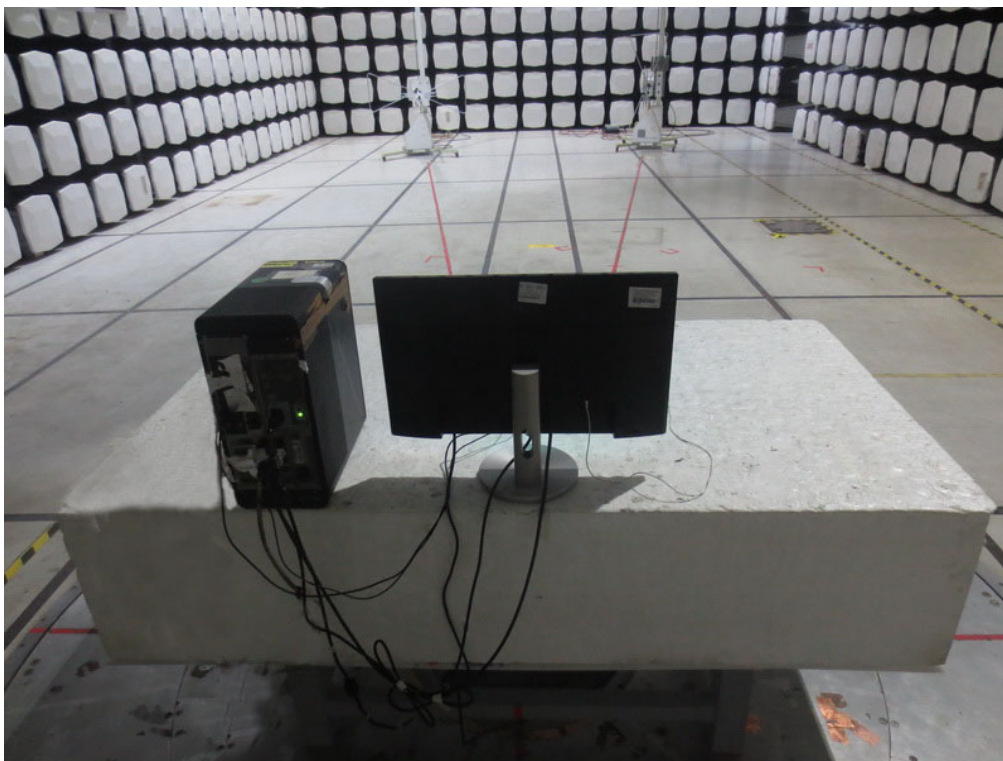
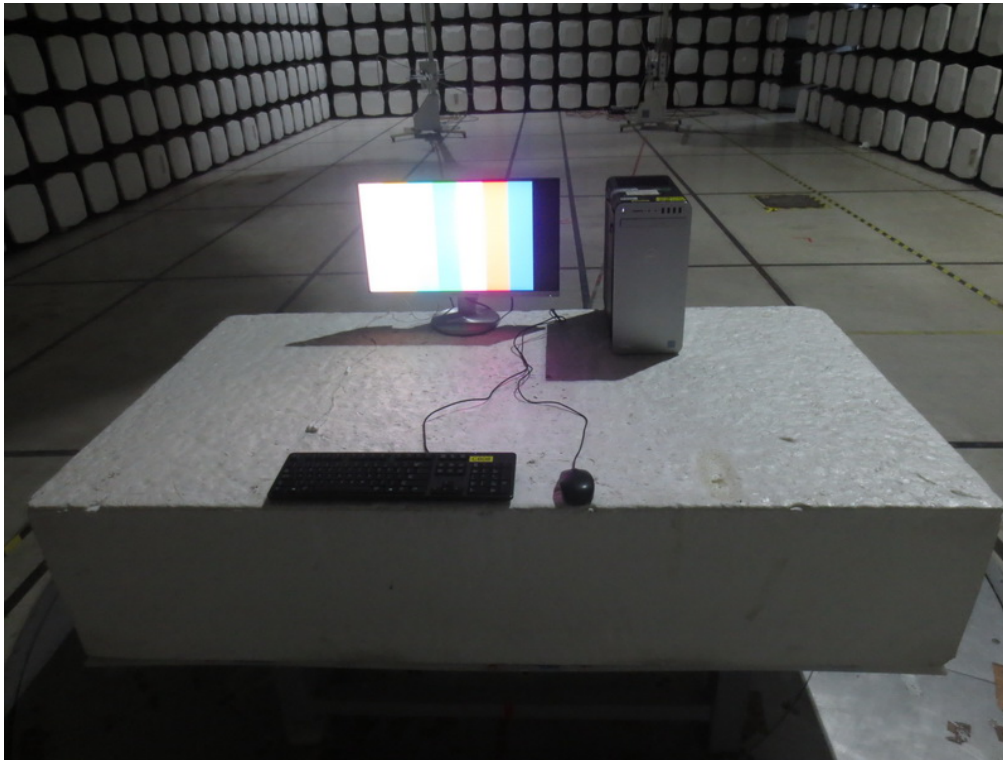

Radiated emissions above 1 GHz

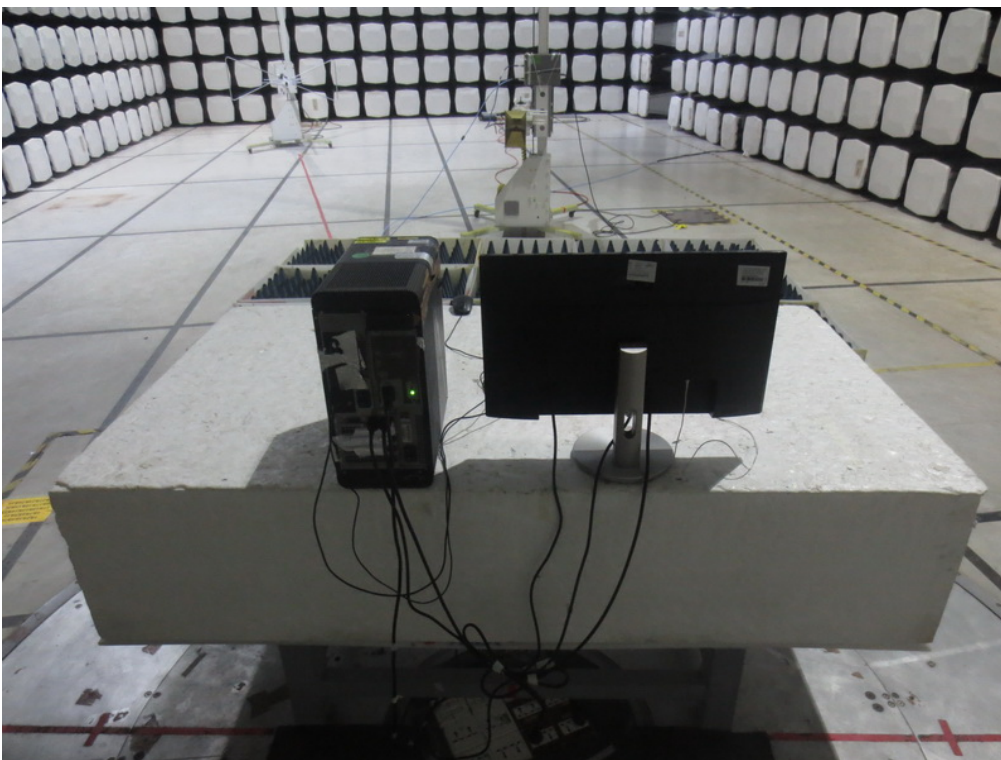

Conducted emissions AC mains power port

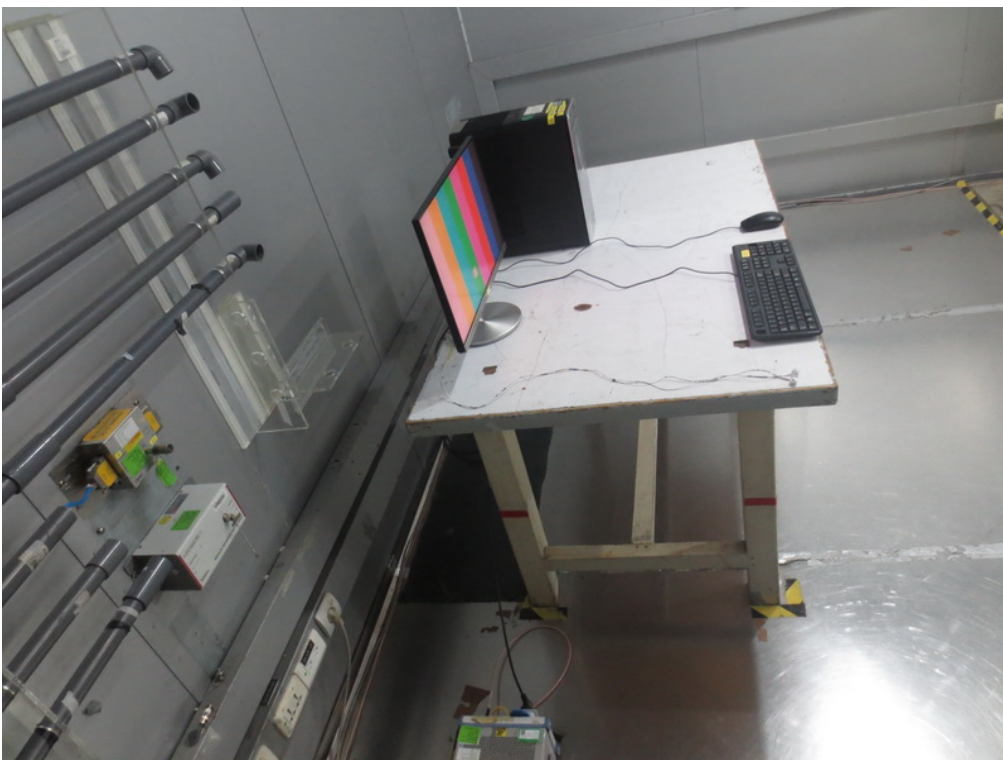
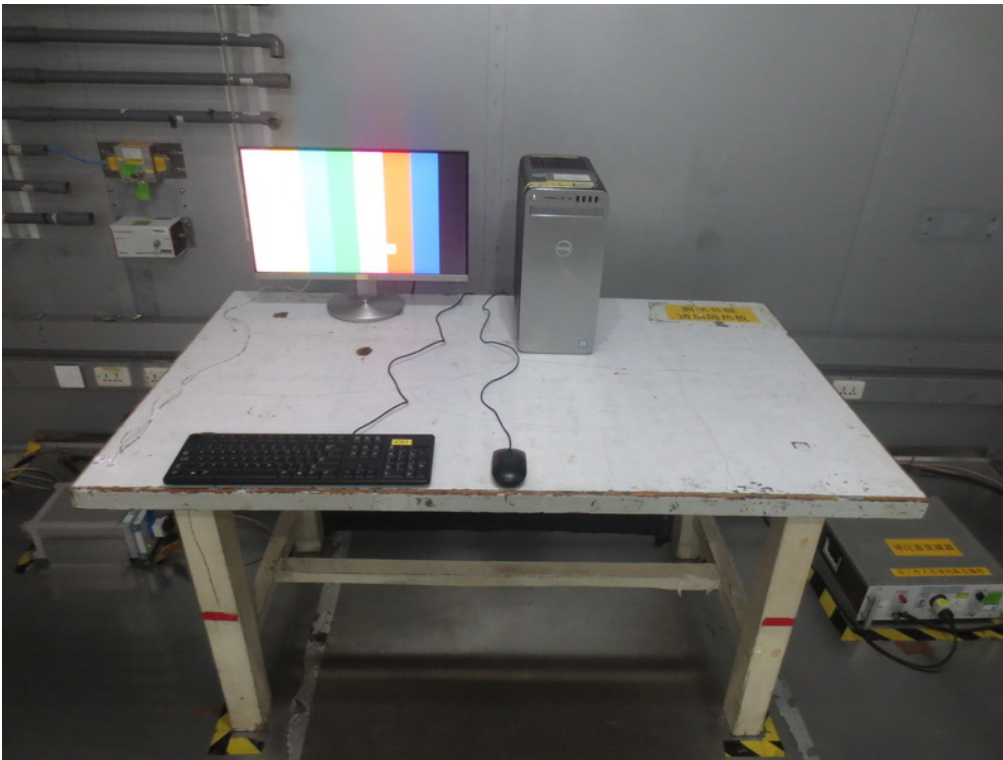

Harmonic current emissions



Voltage fluctuations (Flicker)



Electrostatic discharge immunity



Radiated, radio-frequency, electromagnetic field immunity – up to 1GHz



Radiated, radio-frequency, electromagnetic field immunity – above 1GHz



Electrical fast transient/burst immunity



Surge immunity



Immunity to conducted disturbances, induced by radio-frequency fields



Power frequency magnetic field immunity

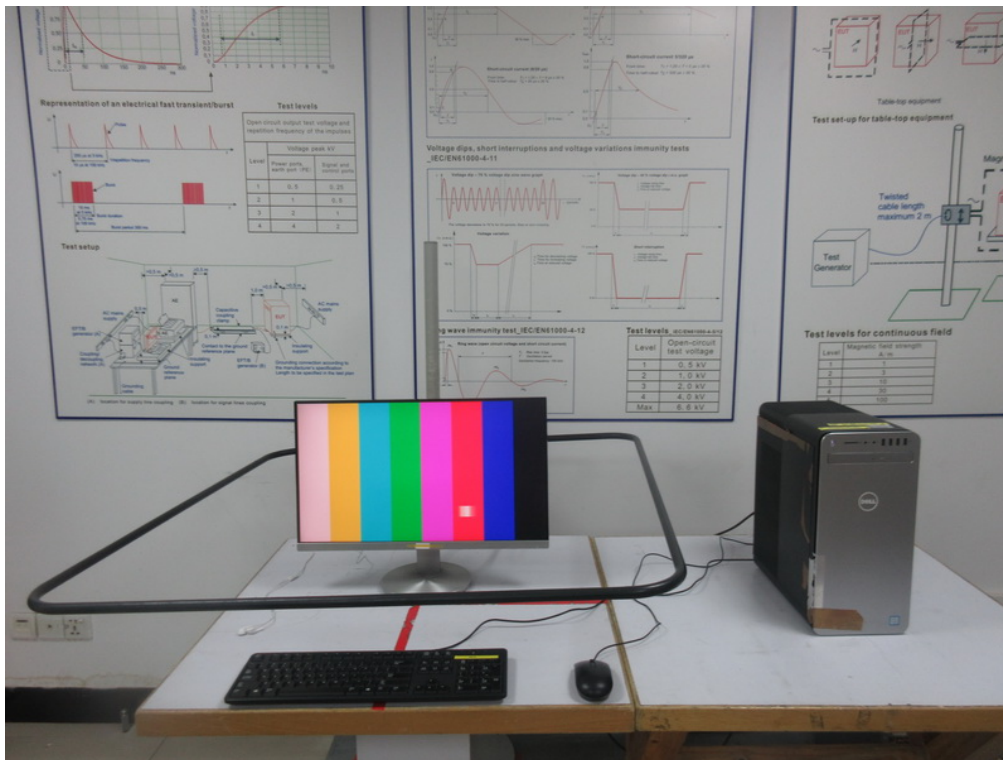

Voltage dips, short interruptions and voltage variations immunity



End of Test Report