

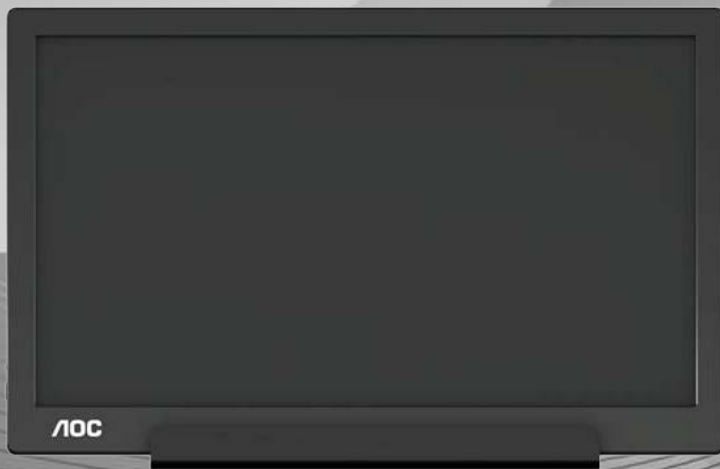

# LCD Monitor User Manual

**I1601P** LED backlight



---

Safety.....	3
National Conventions.....	3
Installation.....	4
Cleaning.....	5
Other.....	6
Setup .....	7
Contents in Box .....	7
Adjusting Viewing Angle.....	8
Connecting the Monitor.....	9
Adjusting .....	10
Hotkeys.....	10
OSD Setting.....	11
Driver .....	12
i-Menu.....	12
e-Saver .....	13
Screen+ .....	14
Troubleshoot.....	15
Specification.....	16
General Specification.....	16
Preset Display Modes.....	17
Plug and Play.....	18

---

# Safety

## National Conventions

The following subsections describe notational conventions used in this document.

### Notes, Cautions, and Warnings

Throughout this guide, blocks of text may be accompanied by an icon and printed in bold type or in italic type. These blocks are notes, cautions, and warnings, and they are used as follows:



**NOTE:** A NOTE indicates important information that helps you make better use of your computer system.



**CAUTION:** A CAUTION indicates either potential damage to hardware or loss of data and tells you how to avoid the problem.



**WARNING:** A WARNING indicates the potential for bodily harm and tells you how to avoid the problem. Some warnings may appear in alternate formats and may be unaccompanied by an icon. In such cases, the specific presentation of the warning is mandated by regulatory authority.

---

## Installation

**!** Do not place the monitor on an unstable cart, stand, tripod, bracket, or table. If the monitor falls, it can injure a person and cause serious damage to this product. Use only a cart, stand, tripod, bracket, or table recommended by the manufacturer or sold with this product. Follow the manufacturer's instructions when installing the product and use mounting accessories recommended by the manufacturer. A product and cart combination should be moved with care.

**!** Never push any object into the slot on the monitor cabinet. It could damage circuit parts causing a fire or electric shock. Never spill liquids on the monitor.

**!** Do not place the front of the product on the floor.

**!** Leave some space around the monitor as shown below. Otherwise, air-circulation may be inadequate hence overheating may cause a fire or damage to the monitor.

**!** To avoid potential damage, for example the panel peeling from the bezel, ensure that the monitor does not tilt downward by more than -5 degrees. If the -5 degree downward tilt angle maximum is exceeded, the monitor damage will not be covered under warranty.

See below the recommended ventilation areas around the monitor when the monitor is installed with the stand:

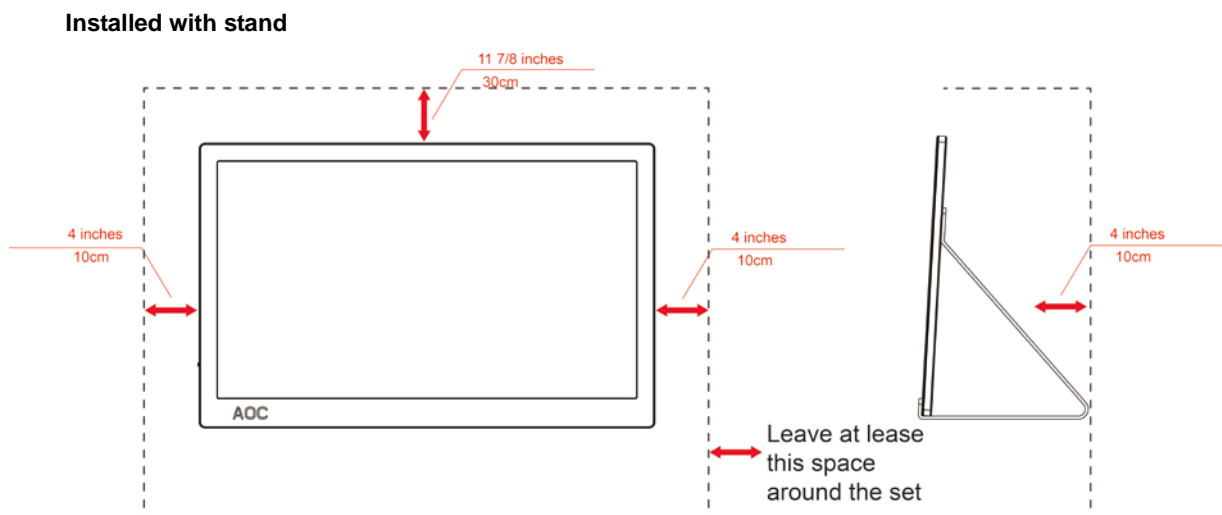

---

## Cleaning

 Clean the cabinet regularly with cloth. You can use soft-detergent to wipe out the stain, instead of strong-detergent which will cauterize the product cabinet.

 When cleaning, make sure no detergent is leaked into the product. The cleaning cloth should not be too rough as it will scratch the screen surface.

 Please disconnect the power cord before cleaning the product.





---

## Other

 If the product is emitting a strange smell, sound or smoke, disconnect the power plug IMMEDIATELY and contact a Service Center.

 Make sure that the ventilating openings are not blocked by a table or curtain.

 Do not engage the LCD monitor in severe vibration or high impact conditions during operation.

 Do not knock or drop the monitor during operation or transportation.

 For display with glossy bezel the user should consider the placement of the display as the bezel may cause disturbing reflections from surrounding light and bright surfaces.

---

# Setup

## Contents in Box

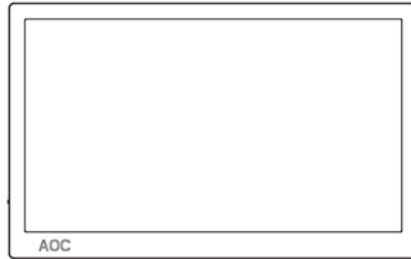

Monitor

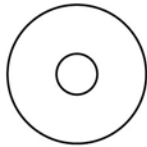

CD Manual

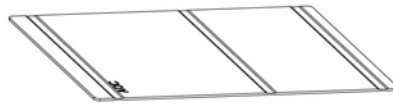

Smart Cover



USB Type-C/A cable

---

## Adjusting Viewing Angle

For optimal viewing, it is recommended to look at the full face of the monitor, and then adjust the monitor's angle to your own preference.

Hold the Smart Cover and Monitor so you will not topple the monitor when you change the monitor's angle.

You are able to adjust the monitor's angle from 5° to 25°.

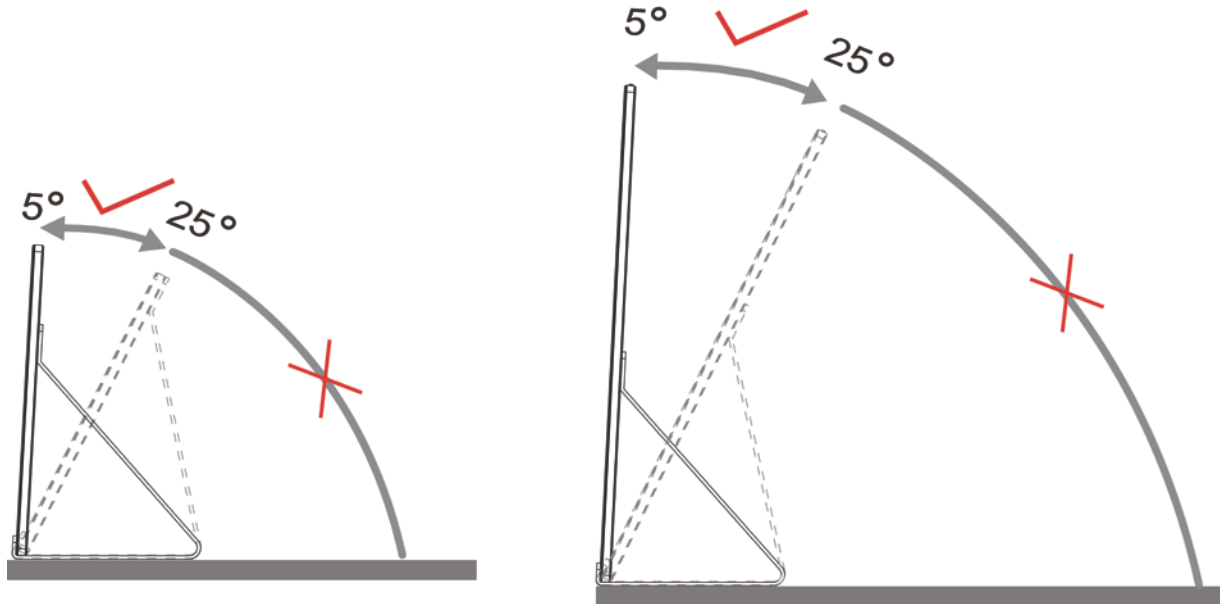

### NOTE:

1. Do not adjust the viewing angle over 5~25 degrees in order to avoid damage.
2. Hold the Smart Cover and Monitor so you will not topple the monitor when you change the monitor's angle.
3. Do not touch the LCD screen when you change the angle. It may cause damage or break the LCD screen.

AOC I1601P monitor supports an auto-pivot function to keep the display upright as the monitor is rotated between portrait and landscape position.

**Important:** Install I-MENU (Version 2.0 or upper) from CD-ROM or AOC website.

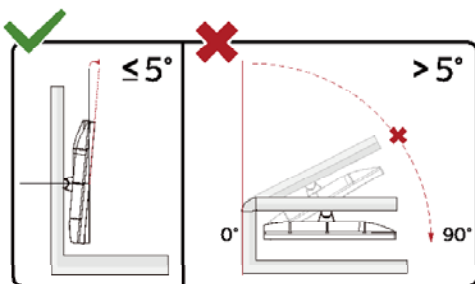

\* Display design may differ from those illustrated.

### WARNING:

1. To avoid potential screen damage, such as panel peeling, ensure that the monitor does not tilt downward by more than -5 degrees.
2. Do not press the screen while adjusting the angle of the monitor. Grasp only the bezel.



---

## Connecting the Monitor

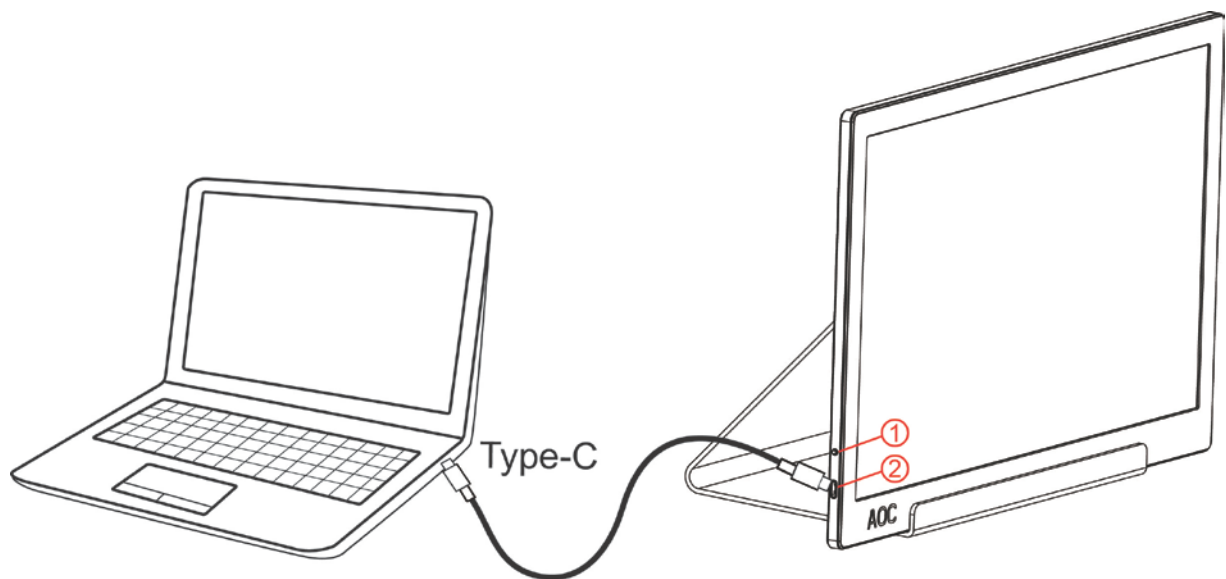

- 1 Power Button
- 2 USB Type-C/A

To protect equipment, always turn off the PC and LCD monitor before connecting.

1. Connect one end of the USB cable to the USB Monitor and the other end of USB cable to the computer.
2. Your computer should detect the USB Monitor automatically.

If your monitor displays an image, installation is complete. If it does not display an image, please refer Troubleshooting.

Use Type C to Type C cable, OSD show USB C

Use Type C to Type A , OSD show Display link

---

# Adjusting

## Hotkeys

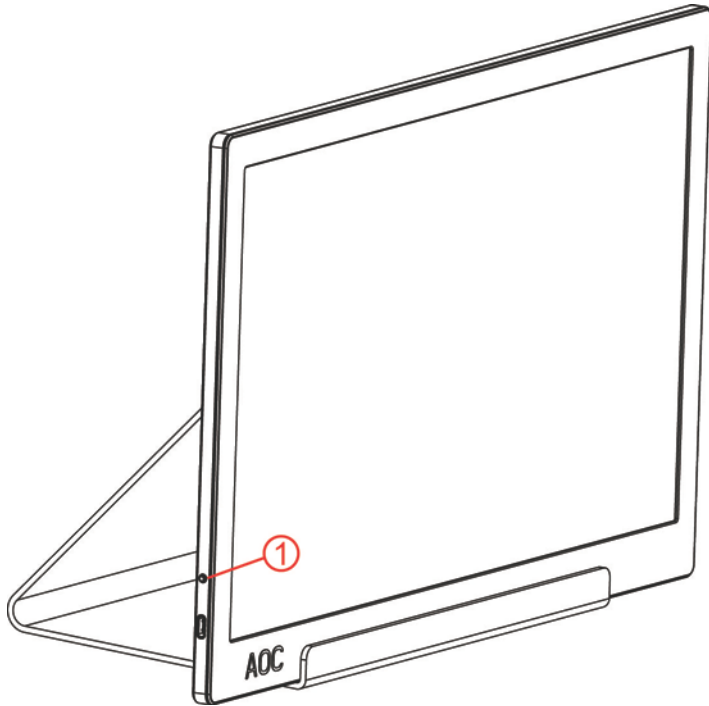

1	Power /Menu/Increase
---	----------------------

### **Power/Menu/Increase**

When Power off, press  button to turn on the monitor.

When Power on, press  button to display OSD or navigate towards the right direction.







When Power on, press  button continuously about 3 seconds to turn off the monitor.

# OSD Setting

Basic and simple instruction on the control keys.



- 1). Press the bottom key  to activate the OSD window.
- 2). You can now select any one of the functions by quickly repeat-pressing the bottom key . The blue box will navigate towards the right as you press the key. You can release once the blue box highlights the option you want to choose. Note that the selection is one way loop always moving one direction and then returning at beginning of the menu. The blue box will remain on the selected function for about 3 seconds and the function icon will flash three times to confirm the choice visible on the 1st layer of the OSD and activate it.

Brightness		0-100	Adjust brightness from 0~100
Contrast		0-100	Adjust contrast from 0~100
Overdrive		Off	Adjust the response time.
		Weak	
		Medium	
		Strong	
LowBlue Mode		Off	Decrease blue light wave by controlling color temperature
		Multimedia	
		Internet	
		Office	
		Reading	
HDR Mode		Off	Adjust contrast HDR Mode
		HDR Picture	
		HDR Movie	
		HDR Game	
Language		English Français Español Português Deutsch Italiano Nederlands Svenska Suomi Polski Čeština Русский 한국어 Türkçe Українська 繁體中文 简体中文 日本語	Select the OSD language Default is English.
Exit			Exit the main OSD

1. Main menu will disappear if no action for about 3 seconds..
2. Sub menu will disappear if no action for about 3 seconds..
3. Before entering OSD menu, monitor will be powered off when continually pressing the bottom key for more than 3 seconds.

---

# Driver

## i-Menu



Welcome to "i-Menu" software by AOC. i-Menu makes it easy to adjust your monitor display setting by using on screen menus instead of the OSD button on the monitor. To complete installation, please follow the installation guide. (Some devices are not compatible.)

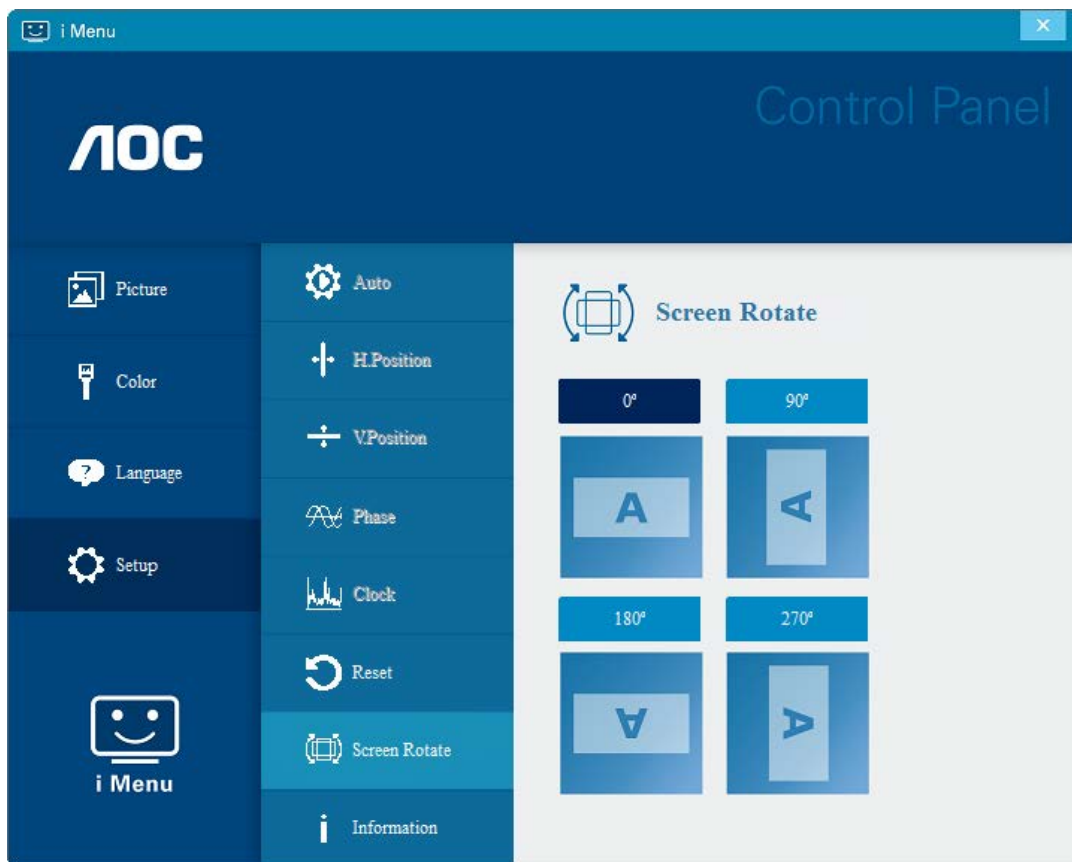

## e-Saver



Welcome to use AOC e-Saver monitor power management software! The AOC e-Saver features Smart Shutdown functions for your monitors, allows your monitor to timely shutdown when PC unit is at any status (On, Off, Sleep or Screen Saver); the actual shutdown time depends on your preferences (see example below).

Please click on "driver/e-Saver/setup.exe" to start installing the e-Saver software, follow the install wizard to complete software installation.

Under each of the four PC status, you may choose from the pull-down menu the desired time (in minutes) you're your monitor to automatically shut down. The example above illustrated:

- 1) The monitor will never shutdown when the PC is powered on.
- 2) The monitor will automatically shutdown 5 minutes after the PC is powered off.
- 3) The monitor will automatically shutdown 10 minutes after the PC is in sleep/stand-by mode.
- 4) The monitor will automatically shutdown 20 minutes after the screen saver appears.

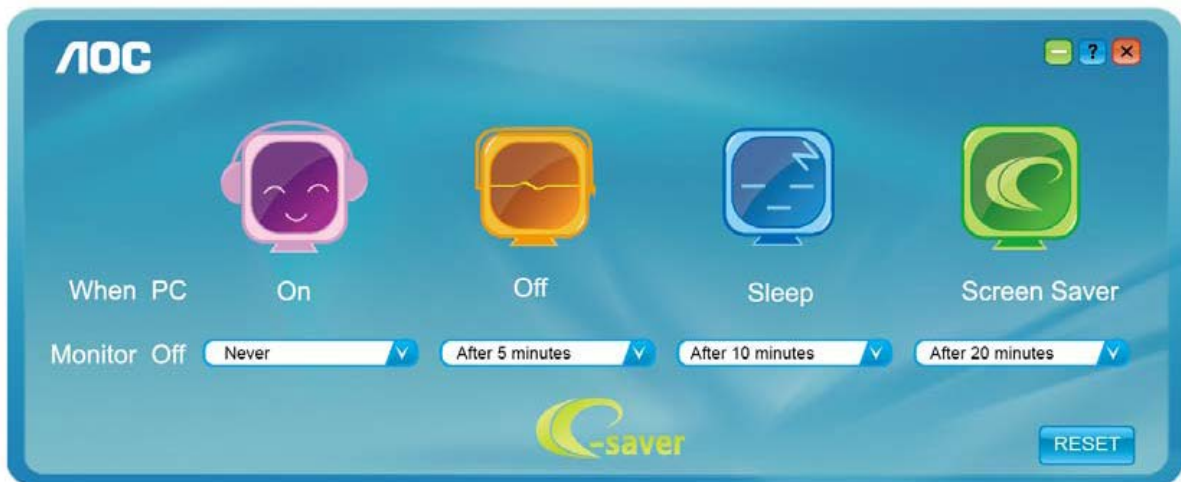

You can click "RESET" to set the e-Saver to its default settings like below.

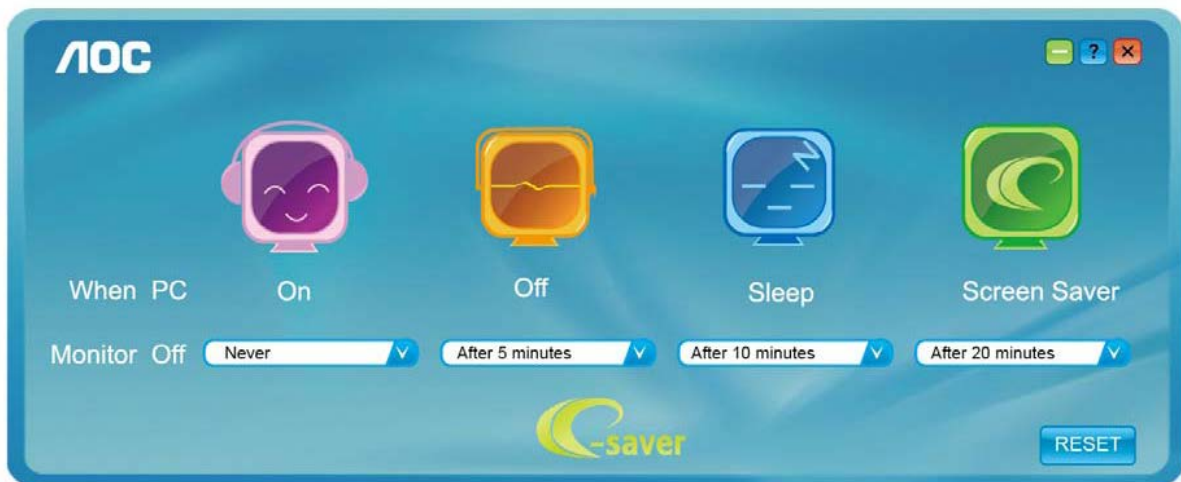

---

# Screen+



Welcome to “Screen+” software by AOC. Screen+ software is a desktop screen splitting tool; it splits the desktop into different panels, and each panel displays a different window. You only need to drag the window to a corresponding panel when you want to access it. It supports multiple monitor display to make your task easier. Please follow the installation software to install it. The software Supported operating systems: Windows 10, Windows 8, Windows 7.

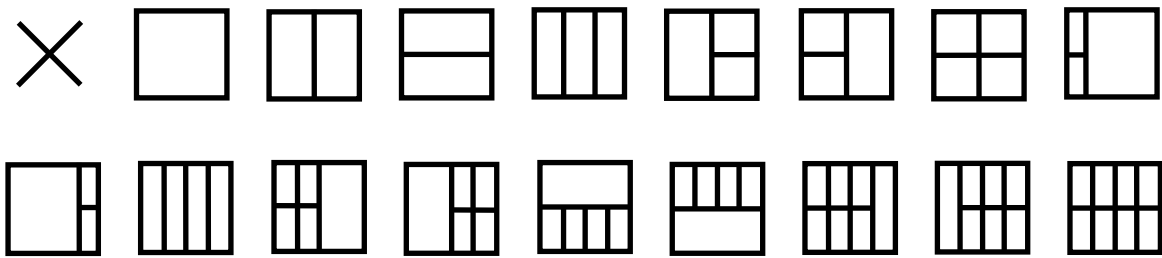

---

# Troubleshoot

This section provides tips for correcting problems, should any occur. It also describes how to contact AOC should you encounter problems that you cannot resolve. Before you call AOC service center, please read the troubleshooting advice in this manual and in your computer User's Manual. You may also want to consult with your system administrator or company technical support staff.

<b>Problem &amp; Question</b>	<b>Possible Solutions</b>
<b>The monitor does not turn on</b>	Check the connectors. Make sure the USB cable is firmly connected to the monitor Disconnect and reconnect the USB cable again. Check the condition of the USB cable. If the cable is frayed or damaged, replace the cable. If the connectors are soiled, wipe them with a clean cloth.
<b>The screen is blank, although the computer power is on</b>	Make sure the USB cable is properly connected the computer. Make sure the computer is on and working. The computer may be in sleep or power-saving mode, or displaying a blank screen saver. Move the mouse to "wake up" the computer.
<b>The picture "bounces" or moves in a wave-like pattern</b>	Move electrical devices that may cause electrical interference away from the monitor.
<b>The monitor display does not rotate when you rotate the monitor.</b>	Make sure the right I-MENU is properly installed.
<b>Regulation &amp; Service</b>	Please refer to Regulation & Service Information which is in the CD manual or <a href="http://www.aoc.com">www.aoc.com</a> (to find the model you purchase in your country and to find Regulation & Service Information in Support page).

# Specification

## General Specification

Panel	Model name	I1601P		
	Driving system	TFT Color LCD		
	Viewable Image Size	39.49cm diagonal		
	Pixel pitch	0.17925 (H)mm x 0.17925 (V)mm		
	Display Color	262K Colors		
	Dot Clock	148.5MHz		
Others	Horizontal scan range	30k~83kHz		
	Horizontal scan Size(Maximum)	344.16 mm		
	Vertical scan range	48Hz-75Hz		
	Vertical scan Size(Maximum)	193.59 mm		
	Optimal preset resolution	1920x1080@60Hz		
	Plug & Play	VESA DDC2B/CI		
	Input Connector	USB Type-C (DP Alt mode)		
	Power Source	Notebook USB 5V		
	Power Consumption	Typical (Brightness = 90, Contrast = 50)	8W	
		(Brightness = 100, Contrast = 100)	9W	
Standby mode		0.3W		
Off timer	0-24 hrs			
Dimensions & Weight:	Height (with base)	235.2mm		
	Width	376.2mm		
	Depth	8.5 mm		
	Weight (monitor only)	824g		
Environmental	Temperature:	Operating	0° to 40°C	
		Non-Operating	-25° to 55°C	
	Humidity:	Operating	10% to 85% (non-condensing)	
		Non-Operating	5% to 93% (non-condensing)	
	Altitude:	Operating	0~ 5000m(0~ 16404 ft)	
		Non-Operating	0~ 12192m (0~ 40000 ft )	
Support OS	Windows 7			
	Windows 8			
	Windows 10			
	MacBook IOS at least 10.12.1 or more			

PS: I1601P only as a display device.





## Preset Display Modes

Standard	Resolution	H. Frequency (kHz)	V. Frequency (Hz)
VGA	640x480@60Hz	31.469	59.94
VGA	640x480@72Hz	37.861	72.809
VGA	640x480@75Hz	37.5	75
SVGA	800x600@56Hz	35.156	56.25
SVGA	800x600@60Hz	37.879	60.317
SVGA	800x600@72Hz	48.077	72.188
SVGA	800x600@75Hz	46.875	75
XGA	1024x768@60Hz	48.363	60.004
XGA	1024x768@70Hz	56.476	70.069
XGA	1024x768@75Hz	60.023	75.029
SXGA	1280x1024@60Hz	63.981	60.02
SXGA	1280x1024@75Hz	79.976	75.025
WXGA+	1440x900@60Hz	55.935	59.887
WSXGA	1680x1050@60Hz	65.29	59.954
WSXGA	1680x1050@60Hz	64.674	59.883
HD	1920x1080@60Hz	67.5	60
***	1280x960@60Hz	60	60
IBM MODES DOS	720x400@70Hz	31.469	70.087
MAC MODES VGA	640x480@67Hz	35	66.667
MAC MODES SVGA	832x624@75Hz	49.725	74.551
MAC MODES XGA	1024x768@75Hz	60.241	74.927

---

# Plug and Play

## Plug & Play DDC2B Feature

This monitor is equipped with VESA DDC2B capabilities according to the VESA DDC STANDARD. It allows the monitor to inform the host system of its identity and, depending on the level of DDC used, communicate additional information about its display capabilities.

The DDC2B is a bi-directional data channel based on the I2C protocol. The host can request EDID information over the DDC2B channel.