

EMC Test Report

Project No. : 1801C228
Equipment : LCD Monitor
Model Name : (1)X24P1, (2)24P1, (3)**24*****(*=A-Z,a-z,0-9,/ ,or blank)
Applicant : TPV Electronics (Fujian) Co., Ltd.
Address : Rongqiao Economic and Technological Development Zone, Fuqing City, Fujian Province, P.R. China

Date of Receipt : Jan. 29, 2018
Date of Test : Jan. 31, 2018 ~ Feb. 11, 2018
Issued Date : Apr. 19, 2018
Tested by : BTL Inc.

Testing Engineer : Jason Yang
(Jason Yang)
Technical Manager : Bill Zhang
(Bill Zhang)
Authorized Signatory : Kevin Li
(Kevin Li)

B T L I N C .

No.3, Jinshagang 1st Road, Shixia, Dalang Town, Dongguan, Guangdong, China.

TEL: +86-769-8318-3000 FAX: +86-769-8319-6000



Declaration

BTL represents to the client that testing is done in accordance with standard procedures as applicable and that test instruments used has been calibrated with standards traceable to international standard(s) and/or national standard(s).

BTL's reports apply only to the specific samples tested under conditions. It is manufacture's responsibility to ensure that additional production units of this model are manufactured with the identical electrical and mechanical components. **BTL** shall have no liability for any declarations, inferences or generalizations drawn by the client or others from **BTL** issued reports.

BTL's report must not be used by the client to claim product certification, approval, or endorsement by NVLAP, NIST, or any agency of the Federal Government.

This report is the confidential property of the client. As a mutual protection to the clients, the public and **BTL-self**, extracts from the test report shall not be reproduced except in full with **BTL's** authorized written approval.

BTL's laboratory quality assurance procedures are in compliance with the **ISO Guide 17025** requirements, and accredited by the conformity assessment authorities listed in this test report.

Limitation

For the use of the authority's logo is limited unless the Test Standard(s)/Scope(s)/Item(s) mentioned in this test report is (are) included in the conformity assessment authorities acceptance respective.

Table of Contents**Page**

REPORT ISSUED HISTORY	6
1 . CERTIFICATION	7
2 . SUMMARY OF TEST RESULTS	8
2.1 TEST FACILITY	10
2.2 MEASUREMENT UNCERTAINTY	10
3 . GENERAL INFORMATION	12
3.1 GENERAL DESCRIPTION OF EUT	12
3.2 DESCRIPTION OF TEST MODES	13
3.3 EUT OPERATING CONDITIONS	15
3.4 BLOCK DIAGRAM SHOWING THE CONFIGURATION OF SYSTEM TESTED	15
3.5 DESCRIPTION OF SUPPORT UNITS	16
4 . EMC EMISSION TEST - EN55032:2012+AC:2013 & 2015	17
4.1 RADIATED EMISSION	17
4.1.1 LIMITS	17
4.1.2 MEASUREMENT INSTRUMENTS LIST	18
4.1.3 TEST PROCEDURE	19
4.1.4 DEVIATION FROM TEST STANDARD	20
4.1.5 TEST SETUP	20
4.1.6 MEASUREMENT DISTANCE	21
4.1.7 TEST RESULTS (UP TO 1 GHZ)	22
4.1.8 TEST RESULTS (ABOVE 1 GHZ)	34
4.2 CONDUCTED EMISSION MEASUREMENT AT AC MAINS POWER PORTS	46
4.2.1 LIMITS	46
4.2.2 MEASUREMENT INSTRUMENTS LIST	46
4.2.3 TEST PROCEDURE	47
4.2.4 DEVIATION FROM TEST STANDARD	47
4.2.5 TEST SETUP	47
4.2.6 TEST RESULTS	48
5 . EMC EMISSION TEST- EN 55032:2015+AC:2016	60
5.1 RADIATED EMISSION	60
5.1.1 LIMITS	60
5.1.2 MEASUREMENT INSTRUMENTS LIST	62
5.1.3 TEST PROCEDURE	63
5.1.4 DEVIATION FROM TEST STANDARD	64
5.1.5 TEST SETUP	64
5.1.6 MEASUREMENT DISTANCE	65
5.1.7 TEST RESULTS (UP TO 1 GHZ)	66

Table of Contents	Page
5.1.8 TEST RESULTS (ABOVE 1 GHZ)	68
5.2 CONDUCTED EMISSION MEASUREMENT AT AC MAINS POWER PORTS	70
5.2.1 LIMITS	70
5.2.2 MEASUREMENT INSTRUMENTS LIST	70
5.2.3 TEST PROCEDURE	71
5.2.4 DEVIATION FROM TEST STANDARD	71
5.2.5 TEST SETUP	71
5.2.6 TEST RESULTS	72
6 . HARMONIC CURRENT EMISSIONS TEST	74
6.1 LIMITS	74
6.2 MEASUREMENT INSTRUMENTS LIST	74
6.3 TEST PROCEDURE	75
6.4 DEVIATION FROM TEST STANDARD	75
6.5 TEST SETUP	75
6.6 TEST RESULTS	76
7 . VOLTAGE CHANGES, VOLTAGE FLUCTUATIONS AND FLICKER TEST	82
7.1 LIMITS	82
7.2 MEASUREMENT INSTRUMENTS LIST	82
7.3 TEST PROCEDURE	82
7.4 DEVIATION FROM TEST STANDARD	82
7.5 TEST SETUP	83
7.6 TEST RESULTS	84
8 . EMC IMMUNITY TEST	86
8.1 STANDARD COMPLIANCE/SEVERITY LEVEL/CRITERIA	86
8.2 GENERAL PERFORMANCE CRITERIA	88
8.3 ELECTROSTATIC DISCHARGE IMMUNITY TEST (ESD)	89
8.3.1 TEST SPECIFICATION	89
8.3.2 MEASUREMENT INSTRUMENTS	89
8.3.3 TEST PROCEDURE	89
8.3.4 DEVIATION FROM TEST STANDARD	90
8.3.5 TEST SETUP	90
8.3.6 TEST RESULTS	91
8.4 RADIATED, RADIO-FREQUENCY, ELECTROMAGNETIC FIELD IMMUNITY TEST (RS)	94
8.4.1 TEST SPECIFICATION	94
8.4.2 MEASUREMENT INSTRUMENTS	94
8.4.3 TEST PROCEDURE	94
8.4.4 DEVIATION FROM TEST STANDARD	94
8.4.5 TEST SETUP	95
8.4.6 TEST RESULTS	96
8.5 ELECTRICAL FAST TRANSIENT/BURST IMMUNITY TEST (EFT/BURST)	97

Table of Contents	Page
8.5.1 TEST SPECIFICATION	97
8.5.2 MEASUREMENT INSTRUMENTS	97
8.5.3 TEST PROCEDURE	97
8.5.4 DEVIATION FROM TEST STANDARD	97
8.5.5 TEST SETUP	98
8.5.6 TEST RESULTS	99
8.6 SURGE IMMUNITY TEST	100
8.6.1 TEST SPECIFICATION	100
8.6.2 MEASUREMENT INSTRUMENTS	100
8.6.3 TEST PROCEDURE	101
8.6.4 DEVIATION FROM TEST STANDARD	101
8.6.5 TEST SETUP	101
8.6.6 TEST RESULTS	102
8.7 IMMUNITY TO CONDUCTED DISTURBANCES, INDUCED BY	
RADIO-FREQUENCY FIELDS TEST (CS)	103
8.7.1 TEST SPECIFICATION	103
8.7.2 MEASUREMENT INSTRUMENTS	103
8.7.3 TEST PROCEDURE	103
8.7.4 DEVIATION FROM TEST STANDARD	103
8.7.5 TEST SETUP	104
8.7.6 TEST RESULTS	105
8.8 POWER FREQUENCY MAGNETIC FIELD IMMUNITY TEST (PFMF)	106
8.8.1 TEST SPECIFICATION	106
8.8.2 MEASUREMENT INSTRUMENTS	106
8.8.3 TEST PROCEDURE	106
8.8.4 DEVIATION FROM TEST STANDARD	106
8.8.5 TEST SETUP	107
8.8.6 TEST RESULTS	108
8.9 VOLTAGE DIPS, SHORT INTERRUPTIONS AND VOLTAGE VARIATIONS	
IMMUNITY TEST	109
8.9.1 TEST SPECIFICATION	109
8.9.2 MEASUREMENT INSTRUMENTS	109
8.9.3 TEST PROCEDURE	109
8.9.4 DEVIATION FROM TEST STANDARD	109
8.9.5 TEST SETUP	110
8.9.6 TEST RESULTS	111
9 . EUT TEST PHOTO	112

REPORT ISSUED HISTORY

Issued No.	Description	Issued Date
BTL-EMC-1-1801C228	Original Issue.	Feb. 26, 2018
MDG1804010	Added up model name 24P1.	Apr. 19, 2018

1. CERTIFICATION

Equipment : LCD Monitor
Brand Name : N/A
Model Name : (1)X24P1, (2)24P1, (3)**24*****(*=A-Z,a-z,0-9,/ ,or blank)
Applicant : TPV Electronics (Fujian) Co., Ltd.
Date of Test : Jan. 31, 2018 ~ Feb. 11, 2018
Test Sample : Engineering Sample
Standard(s) : EN 55032: 2012+AC:2013 Class B
EN 55032: 2015 Class B
EN 55032: 2015+AC:2016 Class B
AS/NZS CISPR 32: 2015 / CISPR 32: 2015
EN 61000-3-2: 2014 / IEC 61000-3-2: 2014 Class D
EN 61000-3-3: 2013 / IEC 61000-3-3: 2013
EN 55024: 2010
EN 55024: 2010+A1:2015
IEC 61000-4-2: 2008 / EN 61000-4-2:2009
IEC 61000-4-3: 2006+A1: 2007+A2: 2010 /
EN 61000-4-3: 2006+A1: 2008+A2: 2010
IEC 61000-4-4: 2012 / EN 61000-4-4: 2012
IEC 61000-4-5: 2014 / EN 61000-4-5: 2014
IEC 61000-4-6: 2013 / EN 61000-4-6: 2014+AC:2015
IEC 61000-4-8: 2009 / EN 61000-4-8:2010
IEC 61000-4-11: 2004 / EN 61000-4-11: 2004

The above equipment has been tested and found compliance with the requirement of the relative standards by BTL Inc.

The test data, data evaluation, and equipment configuration contained in our test report (Ref No. BTL-EMC-1-1801C228) were obtained utilizing the test procedures, test instruments, test sites that has been accredited by the Authority of TAF according to the ISO-17025 quality assessment standard and technical standard(s).

2. SUMMARY OF TEST RESULTS

Test procedures according to the technical standards:

Emission					
Standard(s)	Test Item	Limit	Judgment	Remark	
EN 55032: 2012+AC:2013 EN 55032:2015 EN 55032:2015+AC:2016	Radiated emissions up to 1 GHz	Class B	PASS		
	Radiated emissions above 1 GHz	Class B	PASS	NOTE (2)	
	Radiated emissions from FM receivers	-----	N/A	NOTE (1) NOTE (6)	
	Conducted emissions AC mains power port	Class B	PASS	NOTE (7)	
	Asymmetric mode conducted emissions	AAN	-----	N/A	NOTE (1) NOTE (8)
		Current Probe	-----	N/A	
		CVP	-----	N/A	
Conducted differential voltage emissions	-----	N/A	NOTE (1) NOTE (9)		

Standard	Test Item	Limit	Judgment	Remark
EN 61000-3-2:2014	Harmonic current emissions	Class D	PASS	NOTE (3)
EN 61000-3-3:2013	Voltage changes, voltage fluctuations and flicker	-----	PASS	

Immunity EN 55024: 2010/ EN 55024: 2010+A1:2015				
Section(s)	Test Item	Performance Criterion	Judgment	Remark
EN 61000-4-2:2009	Electrostatic discharge immunity	B	PASS	
EN 61000-4-3: 2006+A1:2008+A2:2010	Radiated, radio-frequency, electromagnetic field immunity	A	PASS	
EN 61000-4-4:2012	Electrical fast transient/burst immunity	B	PASS	
EN 61000-4-5:2014	Surge immunity	B/C	PASS	NOTE (4)
EN 61000-4-6: 2014+AC :2015	Immunity to conducted disturbances, induced by radio-frequency fields	A	PASS	
EN 61000-4-8:2010	Power frequency magnetic field immunity	A	PASS	
EN 61000-4-11:2004	Voltage dips, short interruptions and voltage variations immunity	B / C / C	PASS	NOTE (5)

NOTE:

- (1) "N/A" denotes test is not applicable to this device.
- (2) The EUT's max operating frequency is 148.5 MHz which does exceed 108 MHz, so the test will be performed.
- (3) If the power consumption is less than 75W, there is no limit applied.
- (4) Performance Criterion C for signal ports and telecommunication ports.
Performance Criterion B for input d.c. power port and a.c. power ports.
- (5) Voltage Dips: >95% reduction – Performance Criterion B
Voltage Dips: 30% reduction – Performance Criterion C
Voltage Interruptions: >95% reduction – Performance Criterion C
- (6) If the EUT has FM function the test will be performed.
- (7) If the EUT has AC power mains port the test will be performed.
- (8)

Cable Type	Number of pairs	Measurement type	Procedures
Balanced Unscreened	1 (2 wire) ;2 (4 wire); 3 (6 wire) ;4 (8 wire)	Voltage	AAN
Balanced Unscreened	See a)	Voltage and Current	CP+CVP
Screened or Coaxial	n/a	Voltage	AAN
Screened or Coaxial	n/a	Voltage or Current	CP or CVP
Unbalanced cables	n/a	Voltage and Current	CP+CVP

Ports connected to cables with more than 4 balanced pairs or where the port is unable to function correctly when connected through an AAN.

- (9) If the EUT has tuner port the test will be performed.
- (10) The requirement followed by the client's specification.

2.1 TEST FACILITY

The test facilities used to collect the test data in this report is at the location of No.3, Jinshagang 1st Road, Shixia, Dalang Town, Dongguan, Guangdong, China.

2.2 MEASUREMENT UNCERTAINTY

Where relevant, the following measurement uncertainty levels have been estimated for tests performed on the EUT as specified in CISPR 16-4-2, The BTL measurement uncertainty is less than the CISPR 16-4-2 U_{cispr} requirement.

The reported uncertainty of measurement $y \pm U$, where expanded uncertainty U is based on a standard uncertainty multiplied by a coverage factor of $k=2$, providing a level of confidence of approximately **95%**.

A. Radiated emissions up to 1 GHz measurement:

Test Site	Method	Measurement Frequency Range	Ant. H / V	U, (dB)
DG-CB08 (10m)	CISPR	30MHz ~ 200MHz	V	4.66
		30MHz ~ 200MHz	H	4.64
		200MHz ~ 1,000MHz	V	4.88
		200MHz ~ 1,000MHz	H	4.86

B. Radiated emissions above 1 GHz measurement:

Test Site	Method	Measurement Frequency Range	U, (dB)
DG-CB08 (3m)	CISPR	1 ~ 6 GHz	4.26
		6 ~ 18 GHz	5.30

C. Conducted emissions AC mains power port measurement:

Test Site	Method	Measurement Frequency Range	U, (dB)
DG-C01	CISPR	150 kHz ~ 30MHz	3.16

D. Harmonic current emissions / Voltage changes, voltage fluctuations and flicker measurement:

Test Site	Method	Measurement Frequency Range	U, (dB)
DG-C01	EN 61000-3-2	Voltage	0.774
	EN 61000-3-3	Current	0.782

E. Immunity Measurement:

Test Site	Method	Measurement Frequency Range	U, (dB)
DG-SR02	EN 61000-4-2	Rise time tr	14.6 %
		Peak current Ip	7.70 %
		Current at 30 ns	7.72 %
		Current at 60 ns	7.72 %
DG-CB05	EN 61000-4-3	80MHz~1GHz	2.175 dB
		Electrical measurements	2.267 dB
		Measuring the demodulation on analogue wired network lines	2.267 dB
DG-SR05	EN 61000-4-4	Voltage rise time (tr)	10.4 %
		Voltage peak value(V _P)	8.2 %
		Voltage pulse width(tw)	6.0 %
DG-SR05	EN 61000-4-5	Voltage front time (T _{fv})	5.8 %
		Voltage peak value(V _P)	3.9 %
		Voltage duration(t _d)	0.6 %
DG-CB06	EN 61000-4-6	CDN	3.25 dB
		EM Clamp	4.410 dB
		Electrical measurements	3.258 dB
		measuring the demodulation on analogue wired network lines	3.258 dB
DG-SR05	EN 61000-4-8	Magnetic Field Level	3.787 %
DG-SR05	EN 61000-4-11	voltage fall time (T _f)	2 %

Note: Unless specifically mentioned, the uncertainty of measurement has not been taken into account to declare the compliance or non-compliance to the specification.

3. GENERAL INFORMATION

3.1 GENERAL DESCRIPTION OF EUT

Equipment	LCD Monitor
Brand Name	N/A
Model Name	(1)X24P1, (2)24P1, (3)**24*****(*=A-Z,a-z,0-9,/,or blank)
Model Difference	Different model disbute to different area.
Power Source	AC Mains.
Power Rating	100-240V~ 50-60Hz 1.5A
Connecting I/O port(s)	5* USB port 1* D-SUB port 1* DVI port 1* HDMI port 1* Display port 2* Audio port 1* AC port

Cable Type	Shielded Type	Ferrite Core	Length(m)	Note
D-SUB	Shielded	YES	1.2/1.5/1.8	Bonded two Ferrite Cores
HDMI	Shielded	NO	1.2/1.5/1.8	
Display	Shielded	NO	1.2/1.5/1.8	
DVI	Shielded	NO	1.2/1.5/1.8	Bonded two Ferrite Cores
Audio	Shielded	NO	1.2/1.5/1.8	
AC Power Cord	Non-shielded	NO	1.2/1.5/1.8	1.8m is worst case Detachable (3 Pin)

Note:

1. For a more detailed features description, please refer to the manufacturer's specifications or the user's manual.
2. Power cable 1.8m, 1.5m and 1.2m length, worst case is Power cable 1.8m with D-SUB+HDMI+Display+DVI+Audio 1.8m, 1.5m and 1.2m length testing and recording in test report.

3.2 DESCRIPTION OF TEST MODES

To investigate the maximum EMI emission characteristics generates from EUT, the test system was pre-scanning tested base on the consideration of following EUT operation mode or test configuration mode which possible have effect on EMI emission level. Each of these EUT operation mode(s) or test configuration mode(s) mentioned above was evaluated respectively.

Pretest Mode	Description
Mode 1	D-SUB 1920*1080/60Hz
Mode 2	D-SUB 1280*1024/75Hz
Mode 3	D-SUB 640*480/60Hz
Mode 4	HDMI 1920*1080/60Hz
Mode 5	HDMI 1280*1024/75Hz
Mode 6	HDMI 640*480/60Hz
Mode 7	HDMI 1080P
Mode 8	HDMI 576P
Mode 9	HDMI 480I
Mode 10	Display 1920*1080/60Hz
Mode 11	Display 1280*1024/75Hz
Mode 12	Display 640*480/60Hz
Mode 13	DVI 1920*1080/60Hz
Mode 14	DVI 1280*1024/75Hz
Mode 15	DVI 640*480/60Hz

For Radiated Test	
Final Test Mode	Description
Mode 1	D-SUB 1920*1080/60Hz
Mode 4	HDMI 1920*1080/60Hz
Mode 7	HDMI 1080P

For Conducted Test	
Final Test Mode	Description
Mode 1	D-SUB 1920*1080/60Hz
Mode 4	HDMI 1920*1080/60Hz
Mode 7	HDMI 1080P

For Harmonics / Flickers Test	
Final Test Mode	Description
Mode 4	HDMI 1920*1080/60Hz

For EMS Test	
Final Test Mode	Description
Mode 4	HDMI 1920*1080/60Hz

Note:

1. The worst case is evaluated and recorded in test report.

3.3 EUT OPERATING CONDITIONS

The EUT exercise program used during radiated and/or conducted emission measurement was designed to exercise the various system components in a manner similar to a typical use. The standard test signals and output signal as following:

1. EUT connected to HDD via USB cable.
2. EUT connected to earphone via earphone cable.
3. PC connected to keyboard and mouse via USB cable.
4. EUT connected to PC via HDMI, D-SUB, Display, DVI, USB and Audio cable.

3.4 BLOCK DIAGRAM SHOWING THE CONFIGURATION OF SYSTEM TESTED

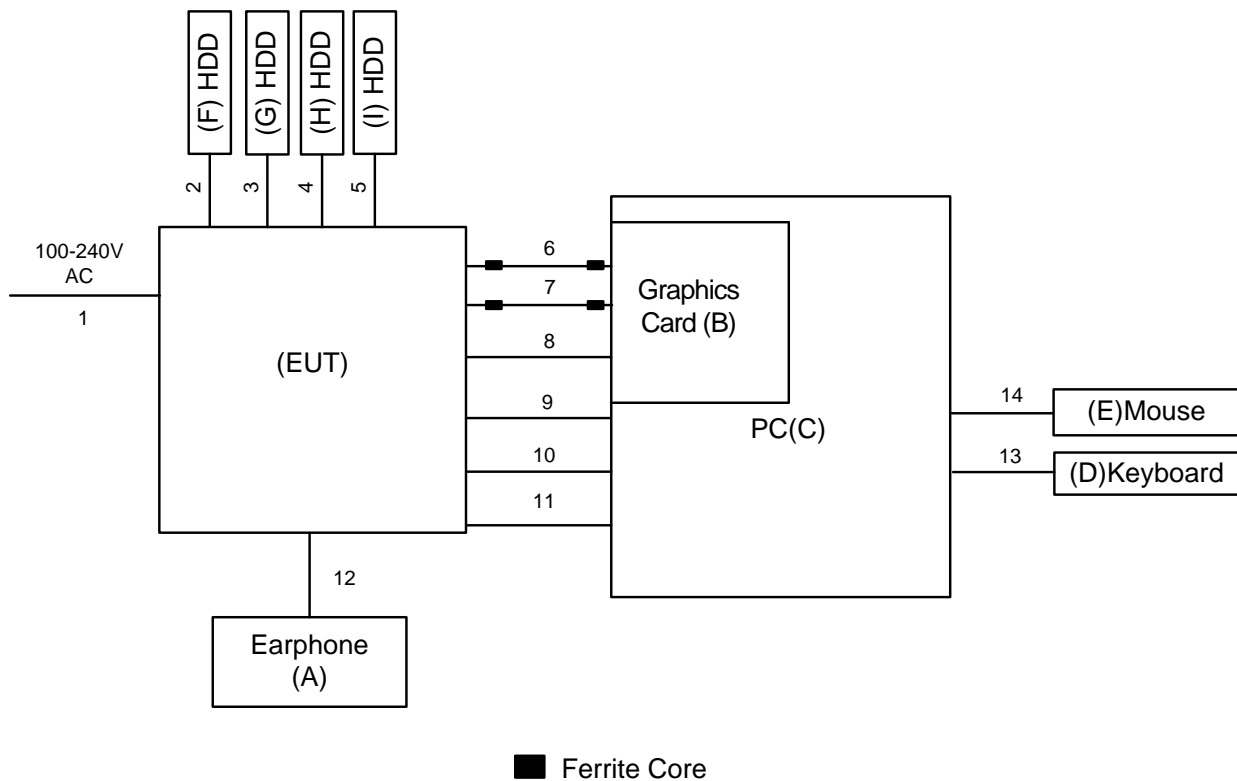

3.5 DESCRIPTION OF SUPPORT UNITS

The EUT has been tested as an independent unit together with other necessary accessories or support units. The following support units or accessories were used to form a representative test configuration during the tests.

Item	Equipment	Mfr/Brand	Model/Type No.	FCC ID	Series No.
A	Earphone	Apple	N/A	VER	N/A
B	Graphics Card	DELL	ATI 3650	DOC	2.60832E+11
C	PC	DELL	Vostro 470	DOC	28747261333
D	USB Keyboard	DELL	KB212-B	DOC	CN0HTXH97158125004DXA01
E	USB Mouse	DELL	MS111-P	DOC	CN011D3V715812790LOT
F	HDD	WD	WDBLUZ5000ASL	DOC	WJ1E74X7D92
G	HDD	WD	WDBLUZ5000ASL	DOC	WX51AB3N8785
H	HDD	WD	WDBLUZ5000ASL	DOC	WXX1E7405LYS
I	HDD	WD	WDBBLW5000AAL	DOC	WXM1A81M8113

Item	Shielded Type	Ferrite Core	Length	Note
1	NO	NO	1.8m/1.5m/1.2m	AC Cable
2	YES	NO	1m	USB Cable
3	YES	NO	1m	USB Cable
4	YES	NO	1m	USB Cable
5	YES	NO	1m	USB Cable
6	YES	YES	1.8m/1.5m/1.2m	D-SUB Cable
7	YES	YES	1.8m/1.5m/1.2m	DVI Cable
8	YES	NO	1.8m/1.5m/1.2m	HDMI Cable
9	YES	NO	1.8m	USB Cable
10	YES	NO	1.8m/1.5m/1.2m	Display Cable
11	YES	NO	1.8m/1.5m/1.2m	Audio Cable
12	NO	NO	1.2m	Earphone Cable
13	YES	NO	1.8m	USB Cable
14	YES	NO	1.8m	USB Cable

4. EMC EMISSION TEST - EN55032:2012+AC:2013 & 2015

4.1 RADIATED EMISSION

4.1.1 LIMITS

Class A equipment up to 1000MHz

Table clause	Frequency MHz	Measurement		Class A limit dB(uV/m)
		Distance m	Detector type/bandwidth	OATS/SAC
A2.1	30-230	10	Quasi peak / 120 kHz	40
	230-1000			47
A2.2	30-230	3		50
	230-1000			57

Class A equipment above 1000MHz

Table clause	Frequency MHz	Measurement		Class A limit dB(uV/m)
		Distance m	Detector type/bandwidth	FSOATS
A3.1	1000-3000	3	Average / 1 MHz	56
	3000-6000			60
A3.2	1000-3000		Peak / 1 MHz	76
	3000-6000			80

Class B equipment up to 1000MHz

Table clause	Frequency MHz	Measurement		Class B limit dB(uV/m)
		Distance m	Detector type/bandwidth	OATS/SAC
A4.1	30-230	10	Quasi peak / 120 kHz	30
	230-1000			37
A4.2	30-230	3		40
	230-1000			47

Class B equipment above 1000MHz

Table clause	Frequency MHz	Measurement		Class B limit dB(uV/m)
		Distance m	Detector type/bandwidth	FSOATS
A5.1	1000-3000	3	Average / 1 MHz	50
	3000-6000			54
A5.2	1000-3000		Peak / 1 MHz	70
	3000-6000			74

Notes:

- (1) The limit for radiated test was performed according to as following: EN 55032
- (2) The tighter limit applies at the band edges.
- (3) Emission level (dBuV/m)=20log Emission level (uV/m).
- (4) The test result calculated as following:
 Measurement Value = Reading Level + Correct Factor
 Correct Factor = Antenna Factor + Cable Loss - Amplifier Gain(if use)
 Margin Level = Measurement Value - Limit Value

Required highest frequency for radiated measurement

Highest internal frequency (F _x) MHz	Highest measured frequency MHz
F _x ≤ 108	1000
108 < F _x ≤ 500	2000
500 < F _x ≤ 1000	5000
F _x > 1000	5 th up to a maximum 6 GHz,

Note for FM and TV broadcast receiver, F_x is determined from the highest frequency generated or used excluding the local oscillator and tuned frequencies.

4.1.2 MEASUREMENT INSTRUMENTS LIST

Up to 1GHz:

Item	Kind of Equipment	Manufacturer	Type No.	Serial No.	Calibrated until
1	Pre-Amplifier	Mini-Circuits	EMC 9135	980284	Mar. 26, 2018
2	Pre-Amplifier	Mini-Circuits	EMC 9135	980283	Mar. 26, 2018
3	Trilog-Broadband Antenna	Schwarzbeck	VULB9168	586	Mar. 26, 2018
4	Trilog-Broadband Antenna	Schwarzbeck	VULB9168	587	Mar. 26, 2018
5	Cable	emci	LMR-400(5 m+11m+15 m)	N/A	Nov. 03, 2018
6	Cable	emci	LMR-400(5 m+8m+15 m)	N/A	Nov. 03, 2018
7	Measurement Software	Farad	EZ-EMC Ver.BTL-2A NT-1	N/A	N/A
8	Multi-Device Controller	ETS-Lindgren	2090	N/A	N/A
9	Attenuator	N/A	SA18N-06	6dB	Apr. 14, 2018
10	Attenuator	N/A	SA18N-06	6dB	Apr. 14, 2018
11	Receiver	Keysight	N9038A	MY54450004	Aug. 15, 2018
12	MXE EMI Receiver	Agilent	N9038A	MY53220133	Jun. 20, 2018

Remark: "N/A" denotes no model name, no serial no. or no calibration specified.
 All calibration period of equipment list is one year.

Above 1GHz:

Item	Kind of Equipment	Manufacturer	Type No.	Serial No.	Calibrated until
1	Measurement Software	Farad	EZ-EMC Ver.BTL-2A NT-1	N/A	N/A
2	Cable	emci	SUCOFLE X_15m_5m (0.01GHz – 26.5GHz)	N/A	Nov. 03, 2018
3	Multi-Device Controller	ETS-Lindgren	2090	N/A	N/A
4	Controller	MF	MF-7802	MF7802081 59	N/A
5	Horn Antenna	EMCO	3115	9605-4803	Mar. 26, 2018
6	Amplifier	Agilent	8449B	3008A02584	Aug. 20, 2018
7	MXE EMI Receiver	Agilent	N9038A	MY5322013 3	Jun. 20, 2018

Remark: “N/A” denotes no model name, no serial no. or no calibration specified.
All calibration period of equipment list is one year.

4.1.3 TEST PROCEDURE

- a. The measuring distance of 10 m shall be used for measurements. The EUT was placed on the top of a rotating table 0.8 meter above the ground at a 10 meter semi-anechoic chamber. The table was rotated 360 degrees to determine the position of the highest radiation.(below 1GHz).
- b. The measuring distance of 3 m shall be used for measurements. The EUT was placed on the top of a rotating table 0.8 meter above the ground at a 10 meter semi-anechoic chamber. The table was rotated 360 degrees to determine the position of the highest radiation.(above 1GHz)
- c. The height of the equipment or of the substitution antenna shall be 0.8 m, the height of the test antenna shall vary between 1 m to 4 m. Both horizontal and vertical polarizations of the antenna are set to make the measurement.
- d. The initial step in collecting radiated emission data is a receiver peak detector mode pre-scanning the measurement frequency range. Significant peaks are then marked and then Quasi Peak detector mode re-measured.
- e. All readings are Peak unless otherwise stated QP in column of Note. Peak denotes that the Peak reading compliance with the QP Limits and then QP Mode measurement didn't perform. (below 1GHz)
- f. All readings are Peak Mode value unless otherwise stated AVG in column of Note. If the Peak Mode Measured value compliance with the Peak Limits and lower than AVG Limits, the EUT shall be deemed to meet both Peak & AVG Limits and then only Peak Mode was measured, but AVG Mode didn't perform. (above 1GHz)
- g. For the actual test configuration, please refer to the related Item - Block Diagram of system tested (please refer to 3.3).

4.1.4 DEVIATION FROM TEST STANDARD

No deviation

4.1.5 TEST SETUP

UP TO 1 GHZ

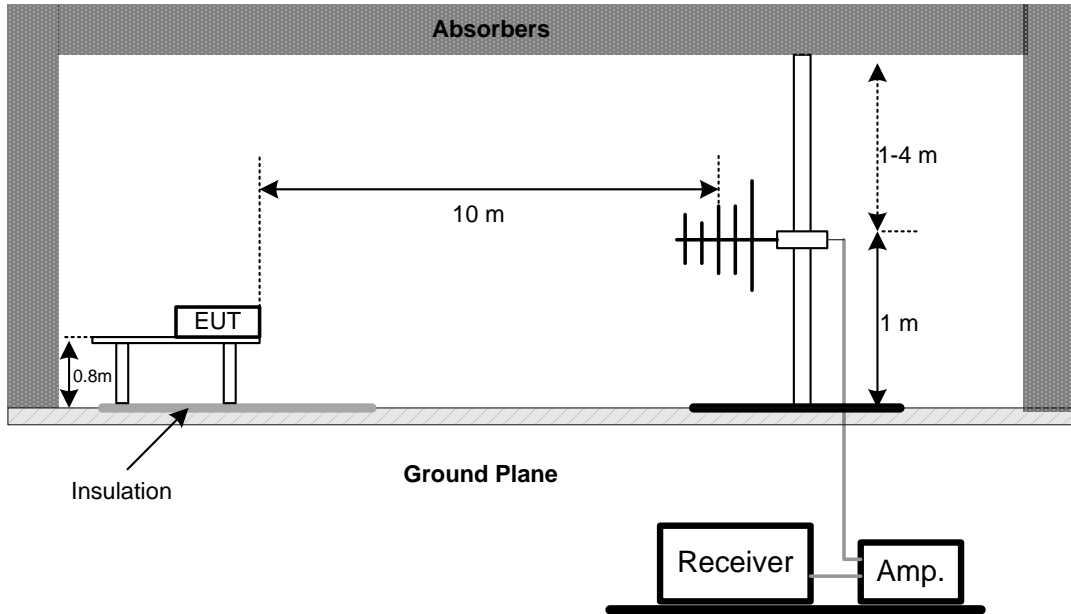

Note: The antenna can be moved between 1 to 4 meters above the ground.

ABOVE 1 GHZ

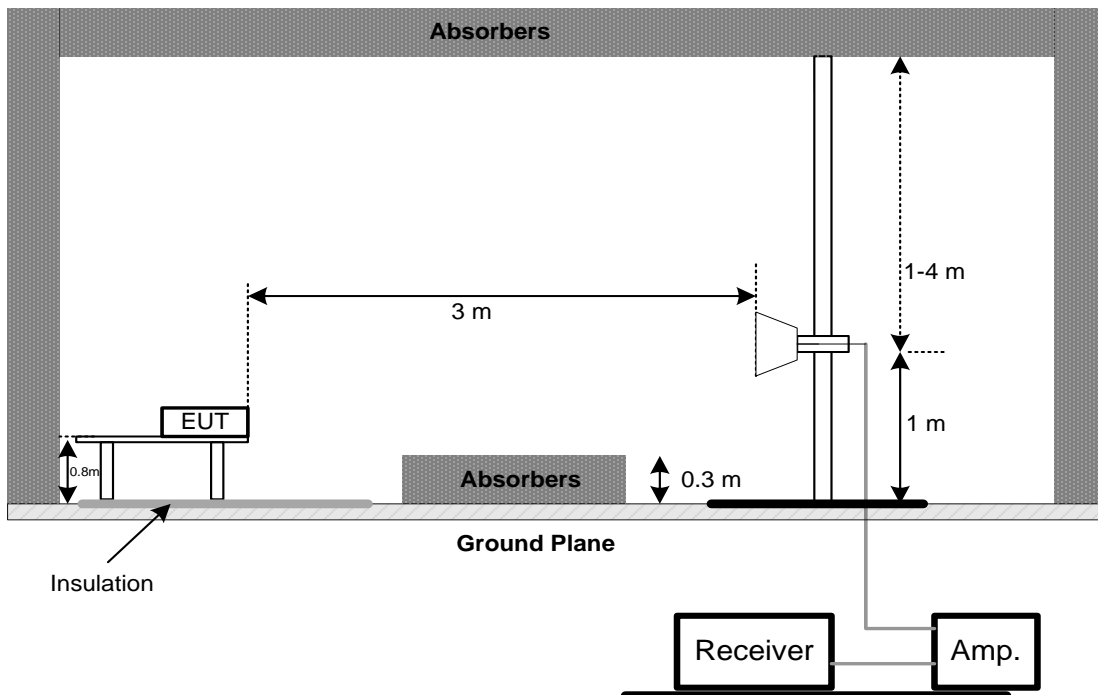

4.1.6 MEASUREMENT DISTANCE

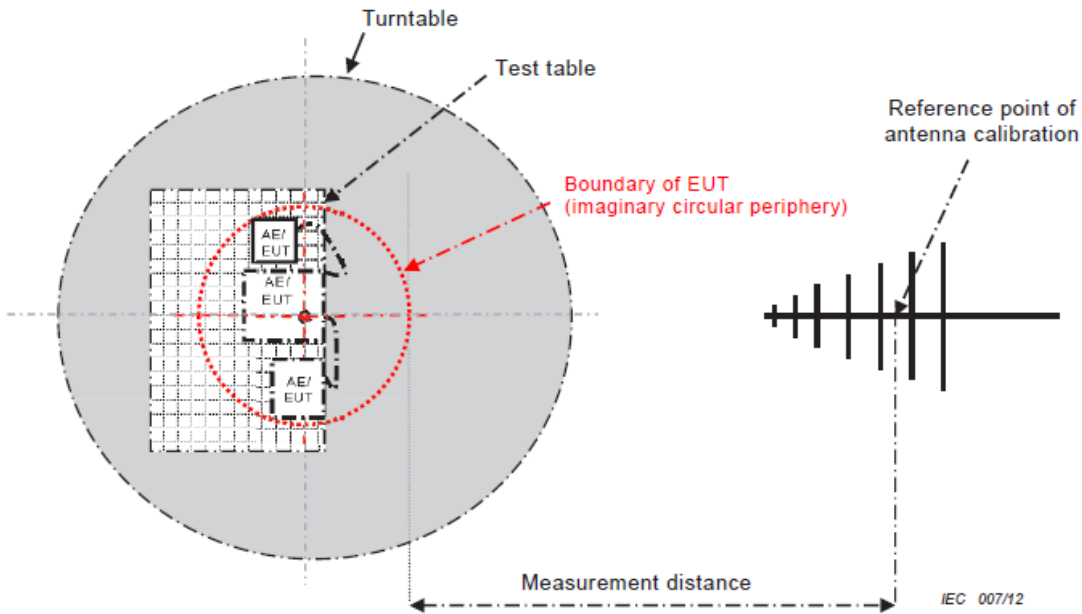

- 34 -

CISPR 32 © IEC:2012

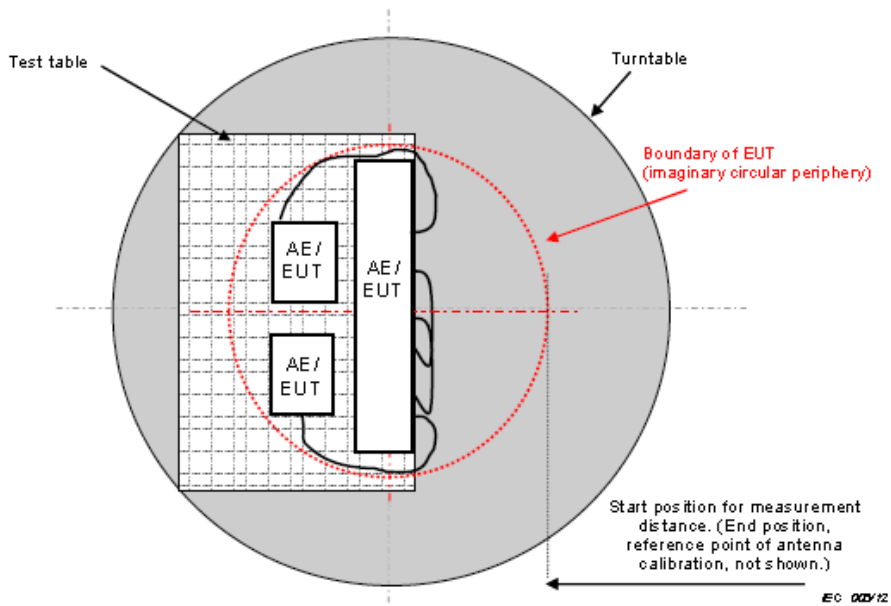
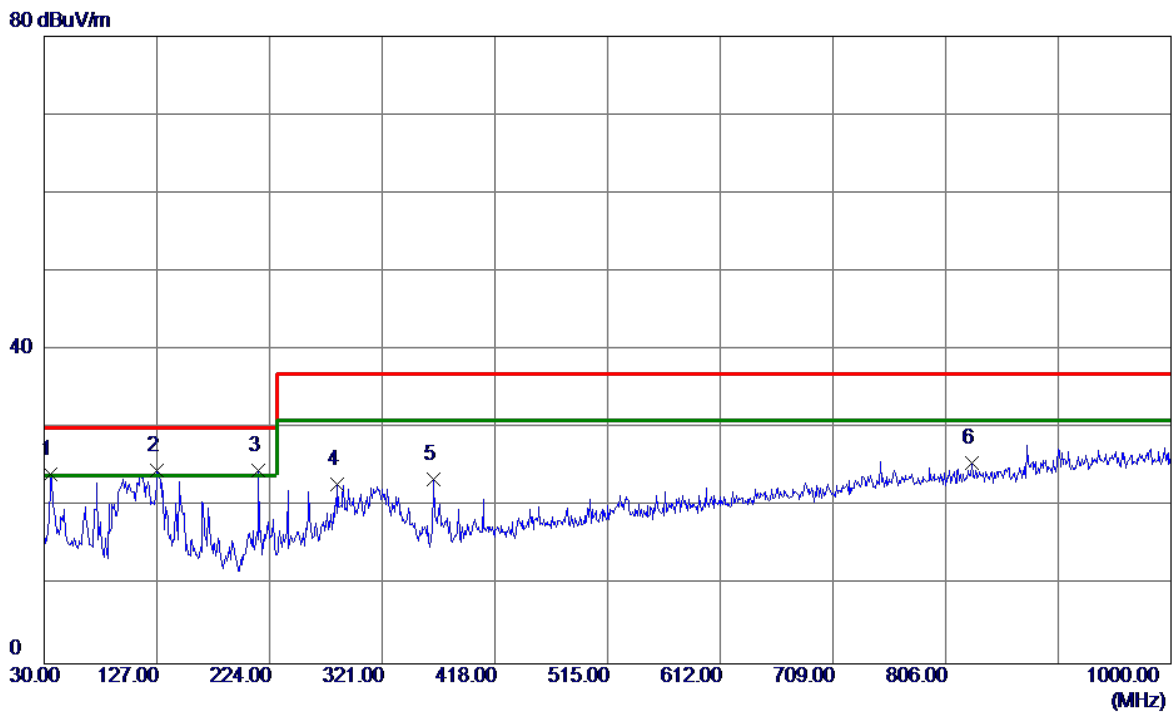

Figure C.2 – Boundary of EUT, Local AE and associated cabling

4.1.7 TEST RESULTS (UP TO 1 GHZ)

EUT	LCD Monitor	Model Name	X24P1
Temperature	25°C	Relative Humidity	60%
Test Voltage	AC 230V/50Hz	Polarization	Vertical
Test Mode	D-SUB 1920*1080/60Hz		
Note	Cable:1.8m		
Test Engineer	Jason Yang		
Panel(Brand/Model)	H		



No.	Freq. MHz	Reading Level dBuV/m	Correct Factor dB	Measure ment dBuV/m	Limit dBuV/m	Margin dB	Detector
1	35.8200	48.14	-23.95	24.19	30.00	-5.81	QP
2	127.0000	48.31	-23.71	24.60	30.00	-5.40	QP
3 *	214.7850	49.77	-25.08	24.69	30.00	-5.31	QP
4	282.2000	44.47	-21.63	22.84	37.00	-14.16	QP
5	365.6200	43.32	-19.79	23.53	37.00	-13.47	QP
6	828.3100	37.33	-11.78	25.55	37.00	-11.45	QP

EUT	LCD Monitor	Model Name	X24P1
Temperature	25°C	Relative Humidity	60%
Test Voltage	AC 230V/50Hz	Polarization	Horizontal
Test Mode	D-SUB 1920*1080/60Hz		
Note	Cable:1.8m		
Test Engineer	Jason Yang		
Panel(Brand/Model)	H		

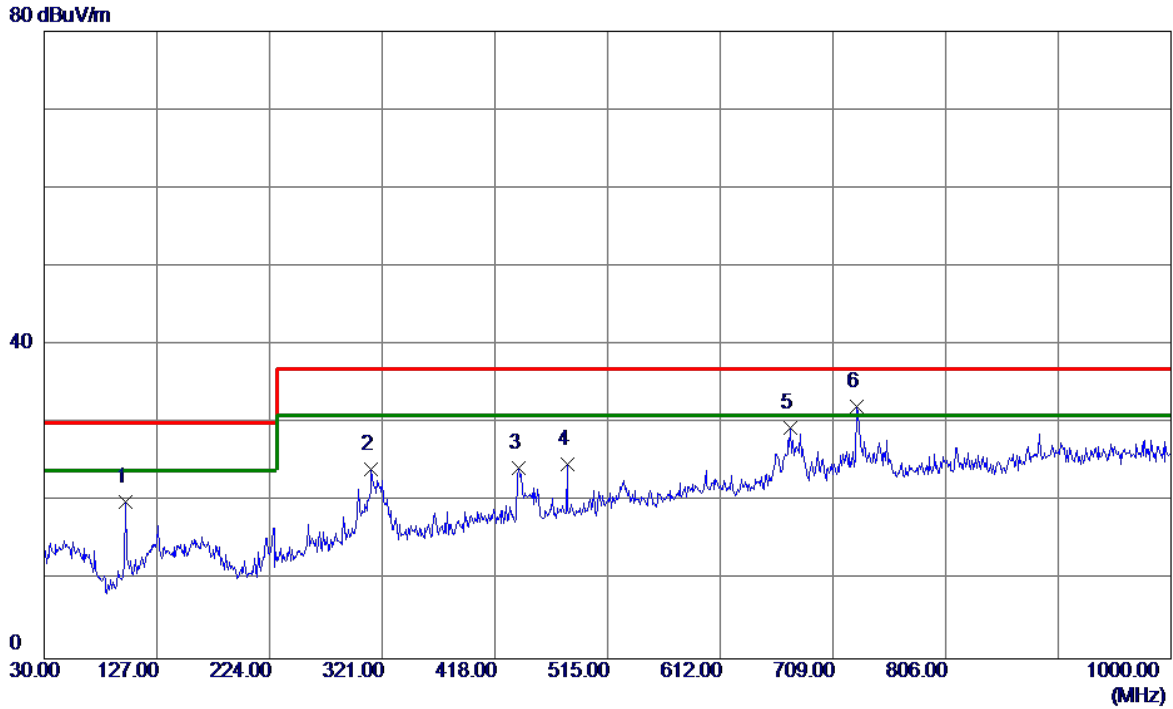

No.	Freq. MHz	Reading Level dBuV/m	Correct Factor dB	Measure ment dBuV/m	Limit dBuV/m	Margin dB	Detector
1	99.8399	40.99	-20.92	20.07	30.00	-9.93	QP
2	311.3000	38.97	-14.76	24.21	37.00	-12.79	QP
3	438.3700	35.92	-11.61	24.31	37.00	-12.69	QP
4	480.0800	35.62	-10.89	24.73	37.00	-12.27	QP
5	672.1400	36.79	-7.40	29.39	37.00	-7.61	QP
6 *	729.3700	38.63	-6.47	32.16	37.00	-4.84	QP

EUT	LCD Monitor	Model Name	X24P1
Temperature	25°C	Relative Humidity	60%
Test Voltage	AC 230V/50Hz	Polarization	Vertical
Test Mode	HDMI 1920*1080/60Hz		
Note	Cable:1.8m		
Test Engineer	Jason Yang		
Panel(Brand/Model)	H		

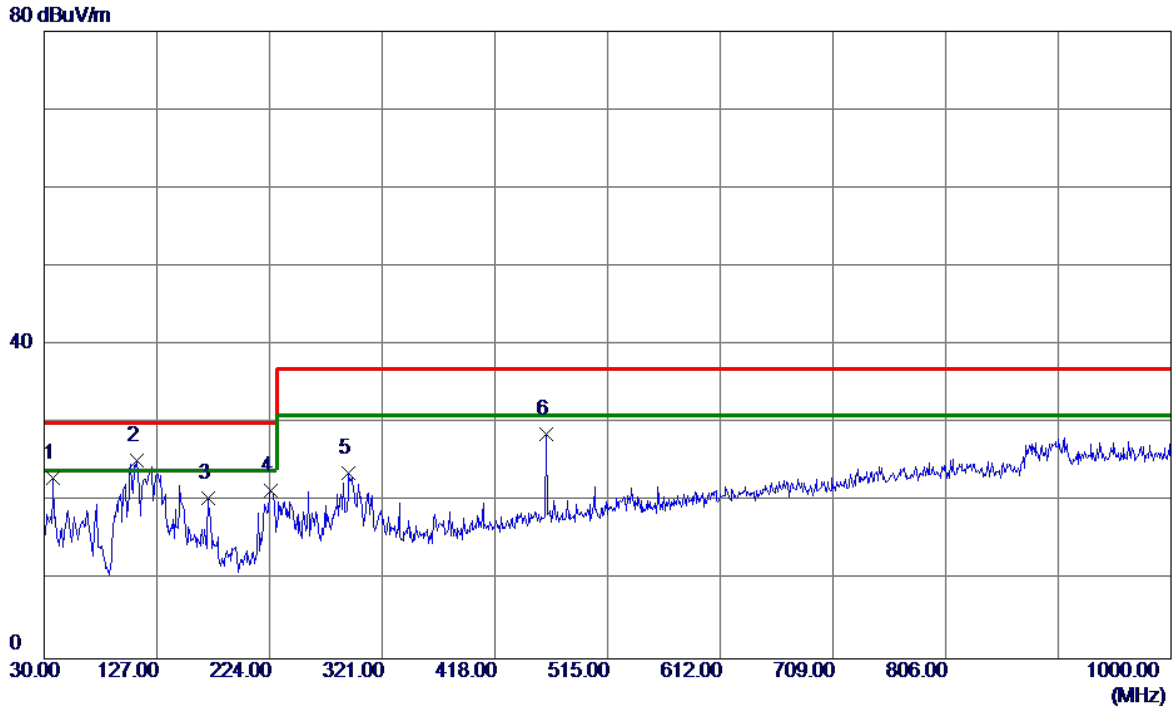

No.	Freq. MHz	Reading Level dBuV/m	Correct Factor dB	Measure ment dBuV/m	Limit dBuV/m	Margin dB	Detector
1	37.7599	46.73	-23.68	23.05	30.00	-6.95	QP
2 *	110.0250	50.43	-25.21	25.22	30.00	-4.78	QP
3	171.6200	43.21	-22.69	20.52	30.00	-9.48	QP
4	224.9700	46.24	-24.85	21.39	30.00	-8.61	QP
5	292.3850	45.05	-21.40	23.65	37.00	-13.35	QP
6	462.1350	45.98	-17.37	28.61	37.00	-8.39	QP

EUT	LCD Monitor	Model Name	X24P1
Temperature	25°C	Relative Humidity	60%
Test Voltage	AC 230V/50Hz	Polarization	Horizontal
Test Mode	HDMI 1920*1080/60Hz		
Note	Cable:1.8m		
Test Engineer	Jason Yang		
Panel(Brand/Model)	H		

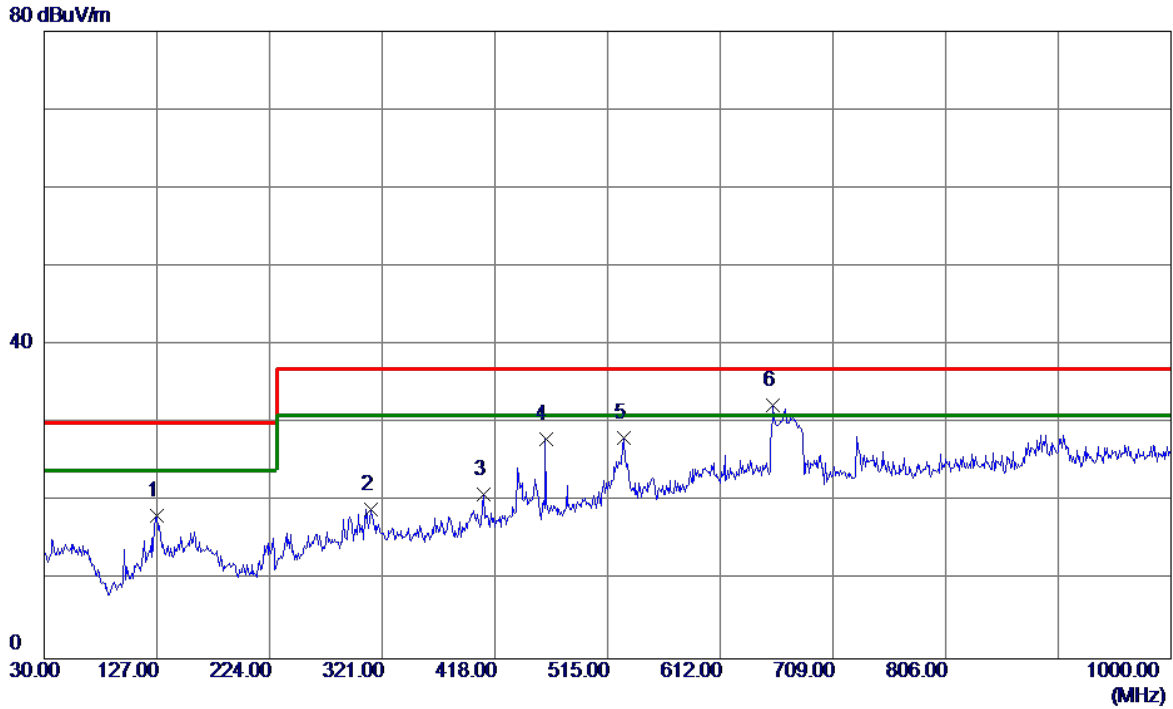

No.	Freq. MHz	Reading Level dBuV/m	Correct Factor dB	Measure ment dBuV/m	Limit dBuV/m	Margin dB	Detector
1	127.0000	35.74	-17.48	18.26	30.00	-11.74	QP
2	311.3000	33.83	-14.76	19.07	37.00	-17.93	QP
3	408.3000	33.26	-12.31	20.95	37.00	-16.05	QP
4	461.6500	39.20	-11.17	28.03	37.00	-8.97	QP
5	528.5800	38.38	-10.17	28.21	37.00	-8.79	QP
6 *	657.5900	40.01	-7.62	32.39	37.00	-4.61	QP

EUT	LCD Monitor	Model Name	X24P1
Temperature	25°C	Relative Humidity	60%
Test Voltage	AC 230V/50Hz	Polarization	Vertical
Test Mode	HDMI 1920*1080/60Hz		
Note	Cable:1.5m		
Test Engineer	Jason Yang		
Panel(Brand/Model)	H		

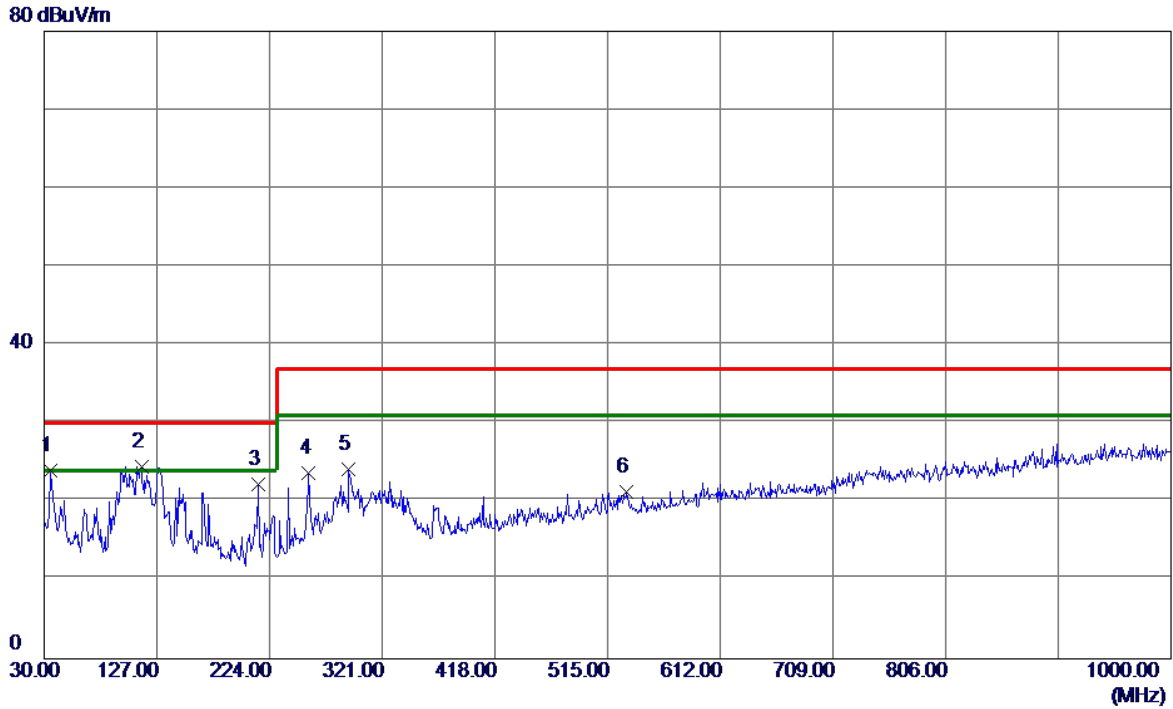

No.	Freq. MHz	Reading Level dBuV/m	Correct Factor dB	Measure ment dBuV/m	Limit dBuV/m	Margin dB	Detector
1	35.3350	48.09	-24.02	24.07	30.00	-5.93	QP
2 *	113.9050	49.37	-24.87	24.50	30.00	-5.50	QP
3	214.7850	47.28	-25.08	22.20	30.00	-7.80	QP
4	257.9500	46.33	-22.71	23.62	37.00	-13.38	QP
5	292.3850	45.61	-21.40	24.21	37.00	-12.79	QP
6	531.4900	37.72	-16.50	21.22	37.00	-15.78	QP

EUT	LCD Monitor	Model Name	X24P1
Temperature	25°C	Relative Humidity	60%
Test Voltage	AC 230V/50Hz	Polarization	Horizontal
Test Mode	HDMI 1920*1080/60Hz		
Note	Cable:1.5m		
Test Engineer	Jason Yang		
Panel(Brand/Model)	H		

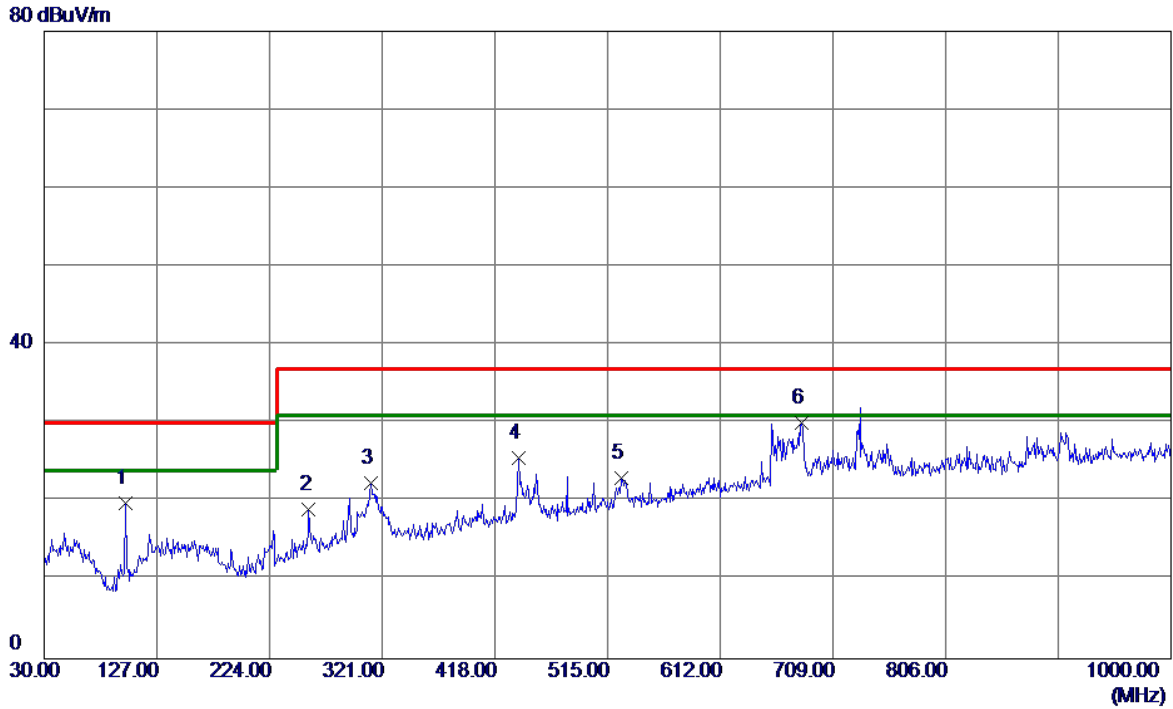

No.	Freq. MHz	Reading Level dBuV/m	Correct Factor dB	Measure ment dBuV/m	Limit dBuV/m	Margin dB	Detector
1	99.8399	40.74	-20.92	19.82	30.00	-10.18	QP
2	257.9500	35.77	-16.77	19.00	37.00	-18.00	QP
3	311.3000	37.22	-14.76	22.46	37.00	-14.54	QP
4	438.3700	37.19	-11.61	25.58	37.00	-11.42	QP
5	526.6400	33.31	-10.20	23.11	37.00	-13.89	QP
6 *	681.8400	37.26	-7.25	30.01	37.00	-6.99	QP

EUT	LCD Monitor	Model Name	X24P1
Temperature	25°C	Relative Humidity	60%
Test Voltage	AC 230V/50Hz	Polarization	Vertical
Test Mode	HDMI 1920*1080/60Hz		
Note	Cable:1.2m		
Test Engineer	Jason Yang		
Panel(Brand/Model)	H		

80 dBuV/m

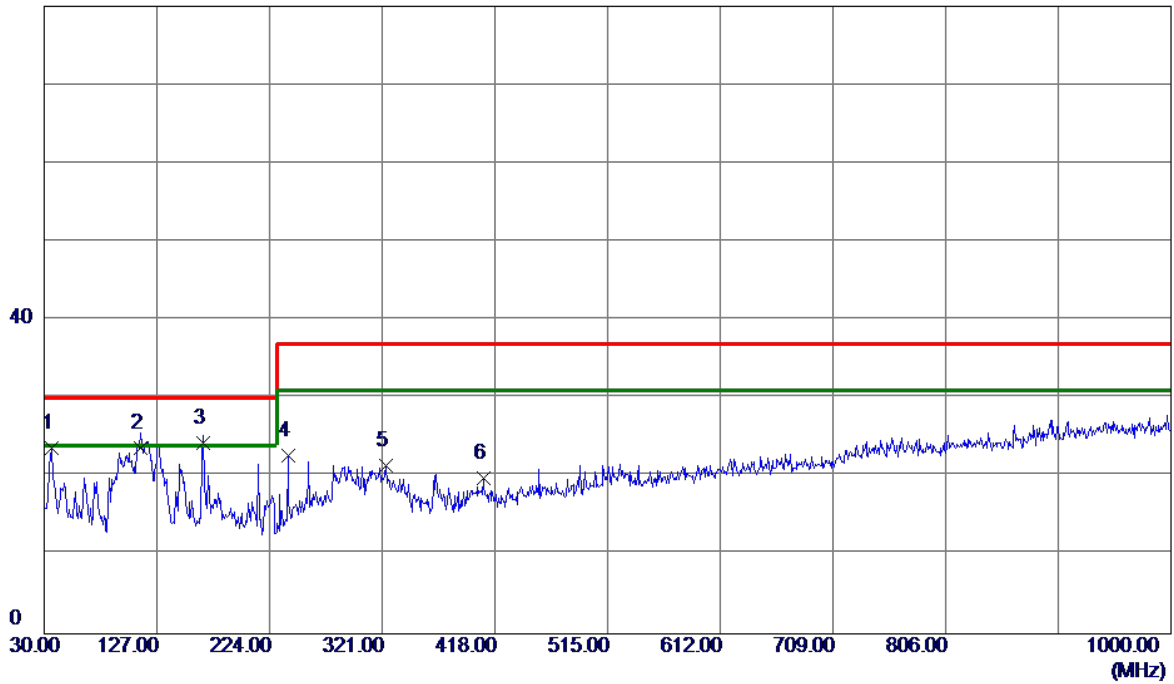

No.	Freq. MHz	Reading Level dBuV/m	Correct Factor dB	Measure ment dBuV/m	Limit dBuV/m	Margin dB	Detector
1	36.7900	47.51	-23.81	23.70	30.00	-6.30	QP
2	113.4200	48.52	-24.91	23.61	30.00	-6.39	QP
3 *	166.7700	46.64	-22.37	24.27	30.00	-5.73	QP
4	240.0050	46.13	-23.40	22.73	37.00	-14.27	QP
5	324.3950	42.17	-20.72	21.45	37.00	-15.55	QP
6	407.8150	38.50	-18.71	19.79	37.00	-17.21	QP

EUT	LCD Monitor	Model Name	X24P1
Temperature	25°C	Relative Humidity	60%
Test Voltage	AC 230V/50Hz	Polarization	Horizontal
Test Mode	HDMI 1920*1080/60Hz		
Note	Cable:1.2m		
Test Engineer	Jason Yang		
Panel(Brand/Model)	H		

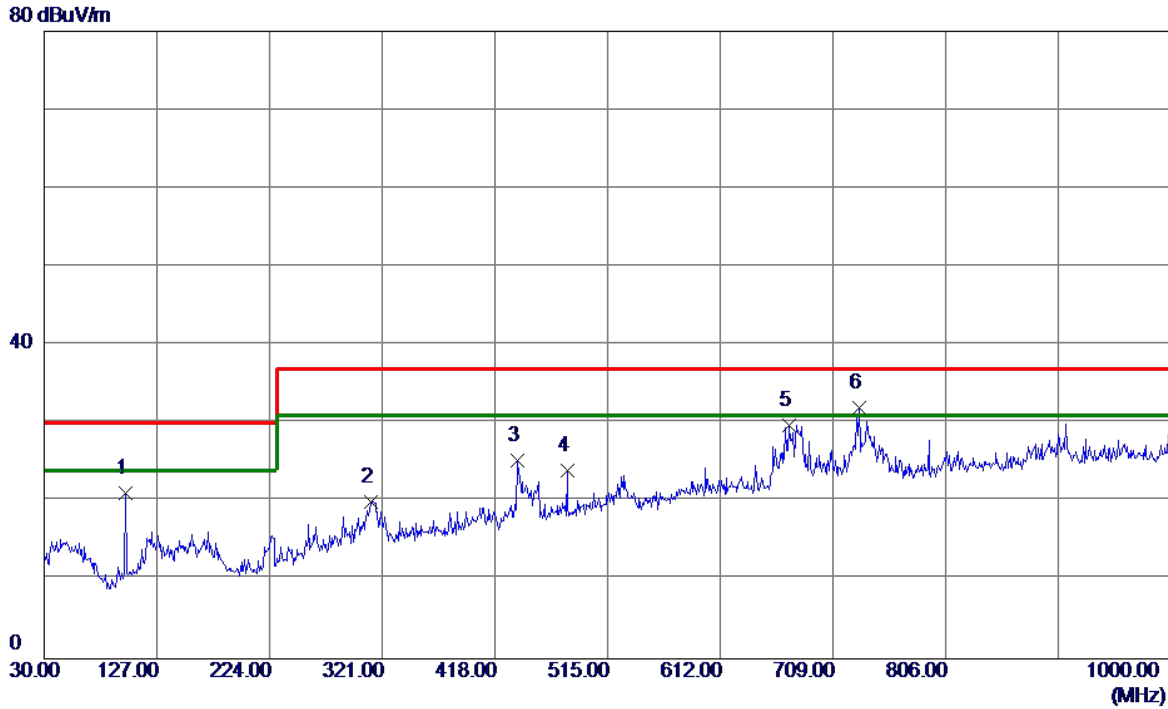

No.	Freq. MHz	Reading Level dBuV/m	Correct Factor dB	Measure ment dBuV/m	Limit dBuV/m	Margin dB	Detector
1	99.8399	42.10	-20.92	21.18	30.00	-8.82	QP
2	311.3000	34.83	-14.76	20.07	37.00	-16.93	QP
3	437.4000	36.85	-11.63	25.22	37.00	-11.78	QP
4	480.0800	34.93	-10.89	24.04	37.00	-12.96	QP
5	671.1700	37.23	-7.41	29.82	37.00	-7.18	QP
6 *	731.3100	38.41	-6.44	31.97	37.00	-5.03	QP

EUT	LCD Monitor	Model Name	X24P1
Temperature	25°C	Relative Humidity	60%
Test Voltage	AC 110V/60Hz	Polarization	Vertical
Test Mode	HDMI 1920*1080/60Hz		
Note	Cable:1.8m		
Test Engineer	Jason Yang		
Panel(Brand/Model)	H		

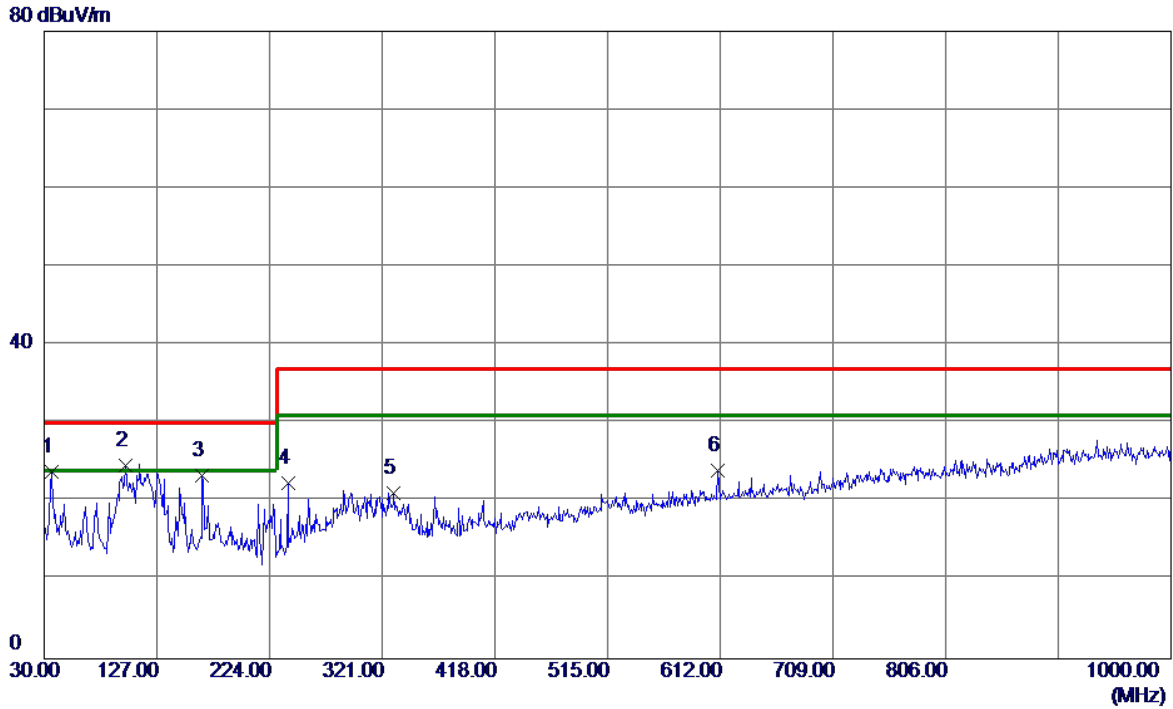

No.	Freq. MHz	Reading Level dBuV/m	Correct Factor dB	Measure ment dBuV/m	Limit dBuV/m	Margin dB	Detector
1	36.3050	47.70	-23.88	23.82	30.00	-6.18	QP
2 *	99.8399	51.63	-26.92	24.71	30.00	-5.29	QP
3	166.2850	45.76	-22.35	23.41	30.00	-6.59	QP
4	240.0050	45.85	-23.40	22.45	37.00	-14.55	QP
5	330.7000	41.67	-20.59	21.08	37.00	-15.92	QP
6	610.0600	38.68	-14.73	23.95	37.00	-13.05	QP

EUT	LCD Monitor	Model Name	X24P1
Temperature	25°C	Relative Humidity	60%
Test Voltage	AC 110V/60Hz	Polarization	Horizontal
Test Mode	HDMI 1920*1080/60Hz		
Note	Cable:1.8m		
Test Engineer	Jason Yang		
Panel(Brand/Model)	H		

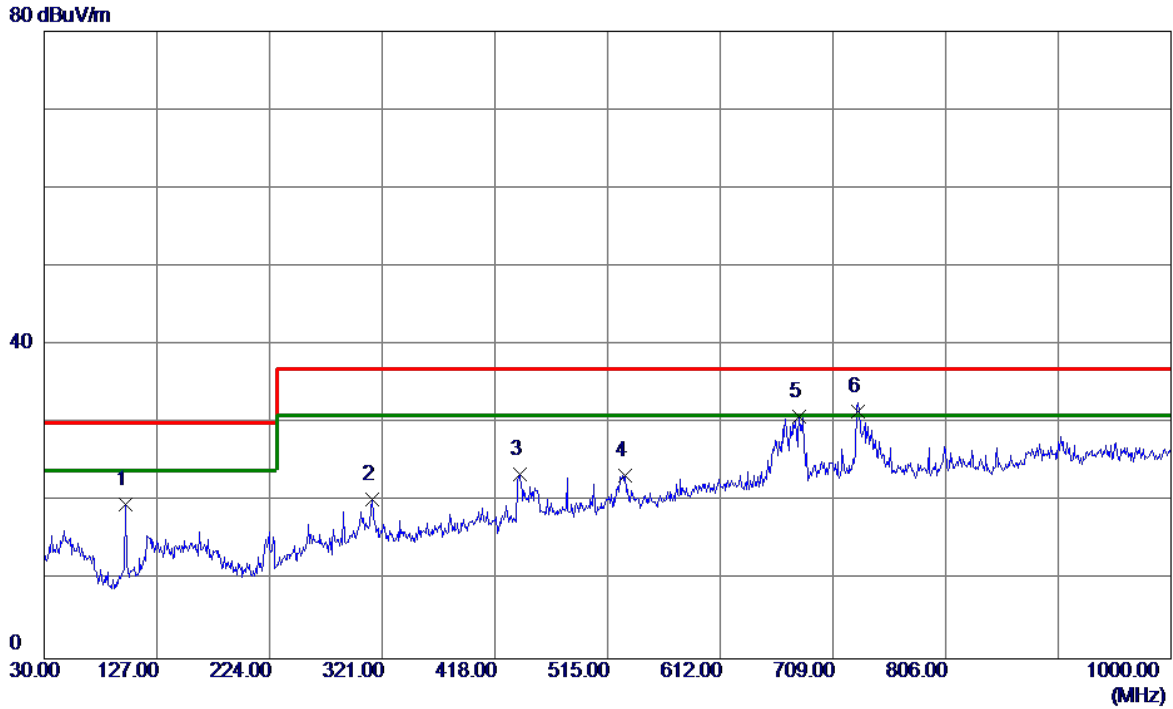

No.	Freq. MHz	Reading Level dBuV/m	Correct Factor dB	Measure ment dBuV/m	Limit dBuV/m	Margin dB	Detector
1	99.8399	40.64	-20.92	19.72	30.00	-10.28	QP
2	312.2700	34.99	-14.74	20.25	37.00	-16.75	QP
3	439.3400	35.07	-11.59	23.48	37.00	-13.52	QP
4	530.5200	33.56	-10.14	23.42	37.00	-13.58	QP
5	679.9000	38.17	-7.28	30.89	37.00	-6.11	QP
6 *	730.3400	37.99	-6.45	31.54	37.00	-5.46	QP

EUT	LCD Monitor	Model Name	X24P1
Temperature	25°C	Relative Humidity	60%
Test Voltage	AC 230V/50Hz	Polarization	Vertical
Test Mode	HDMI 1080P		
Note	Cable:1.8m		
Test Engineer	Jason Yang		
Panel(Brand/Model)	H		

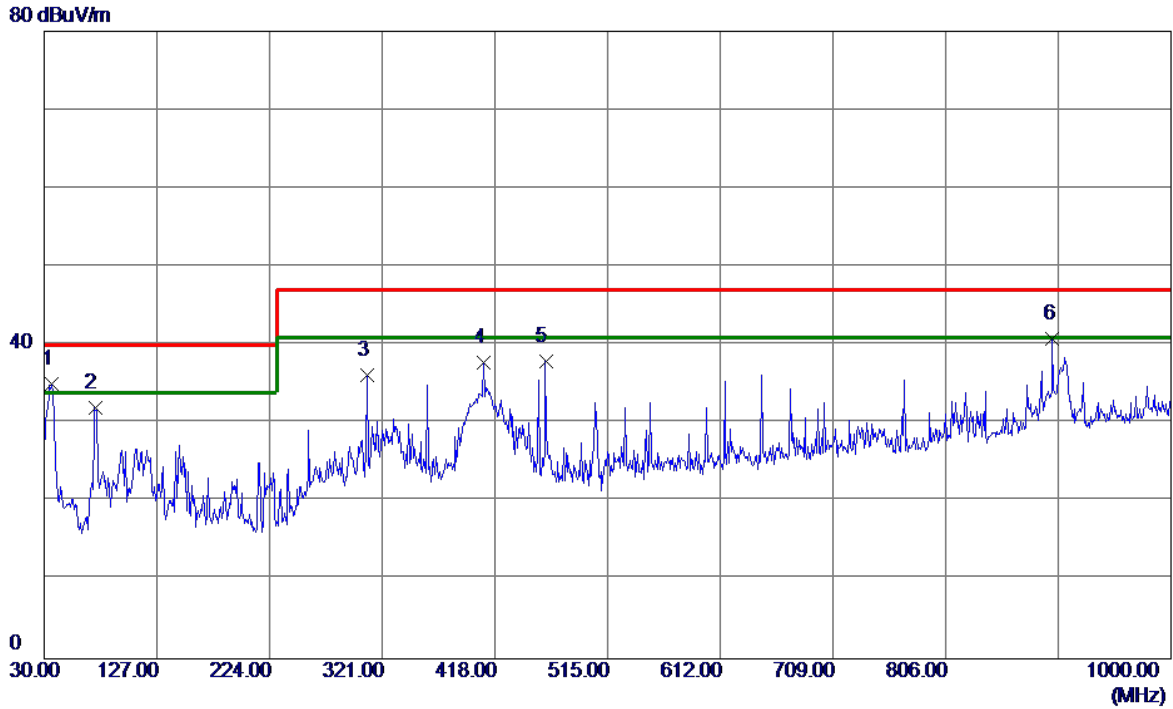

No.	Freq. MHz	Reading Level dBuV/m	Correct Factor dB	Measure ment dBuV/m	Limit dBuV/m	Margin dB	Detector
1 *	36.7900	47.97	-12.99	34.98	40.00	-5.02	QP
2	73.6500	47.39	-15.46	31.93	40.00	-8.07	QP
3	308.3900	46.57	-10.41	36.16	47.00	-10.84	QP
4	408.3000	45.66	-7.91	37.75	47.00	-9.25	QP
5	461.6500	44.60	-6.61	37.99	47.00	-9.01	QP
6	898.1500	38.00	2.86	40.86	47.00	-6.14	QP

EUT	LCD Monitor	Model Name	X24P1
Temperature	25°C	Relative Humidity	60%
Test Voltage	AC 230V/50Hz	Polarization	Horizontal
Test Mode	HDMI 1080P		
Note	Cable:1.8m		
Test Engineer	Jason Yang		
Panel(Brand/Model)	H		

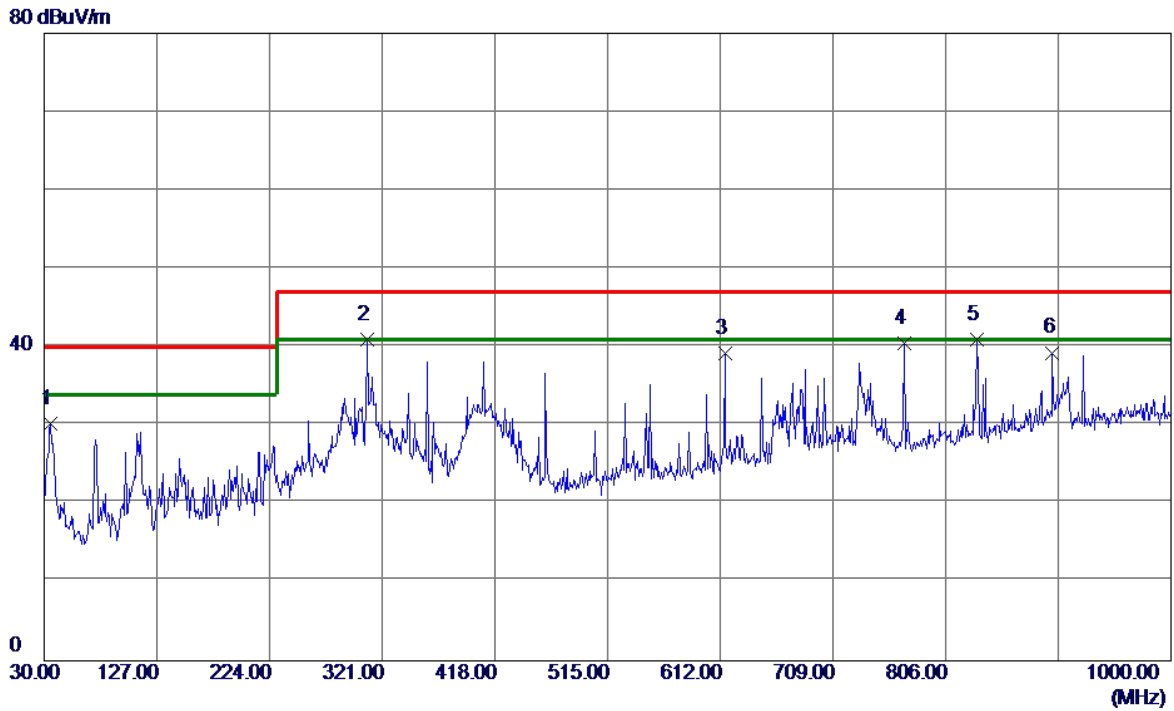

No.	Freq. MHz	Reading Level dBuV/m	Correct Factor dB	Measure ment dBuV/m	Limit dBuV/m	Margin dB	Detector
1	35.8200	43.36	-13.11	30.25	40.00	-9.75	QP
2 *	308.3900	51.41	-10.41	41.00	47.00	-6.00	QP
3	615.8800	42.42	-3.17	39.25	47.00	-7.75	QP
4	770.1100	40.11	0.31	40.42	47.00	-6.58	QP
5	833.1599	39.39	1.59	40.98	47.00	-6.02	QP
6	898.1500	36.42	2.86	39.28	47.00	-7.72	QP

4.1.8 TEST RESULTS (ABOVE 1 GHZ)

EUT	LCD Monitor	Model Name	X24P1
Temperature	25°C	Relative Humidity	60%
Test Voltage	AC 230V/50Hz	Polarization	Vertical
Test Mode	D-SUB 1920*1080/60Hz		
Note	Cable:1.8m		
Test Engineer	Jason Yang		
Panel(Brand/Model)	H		

100 dBuV/m

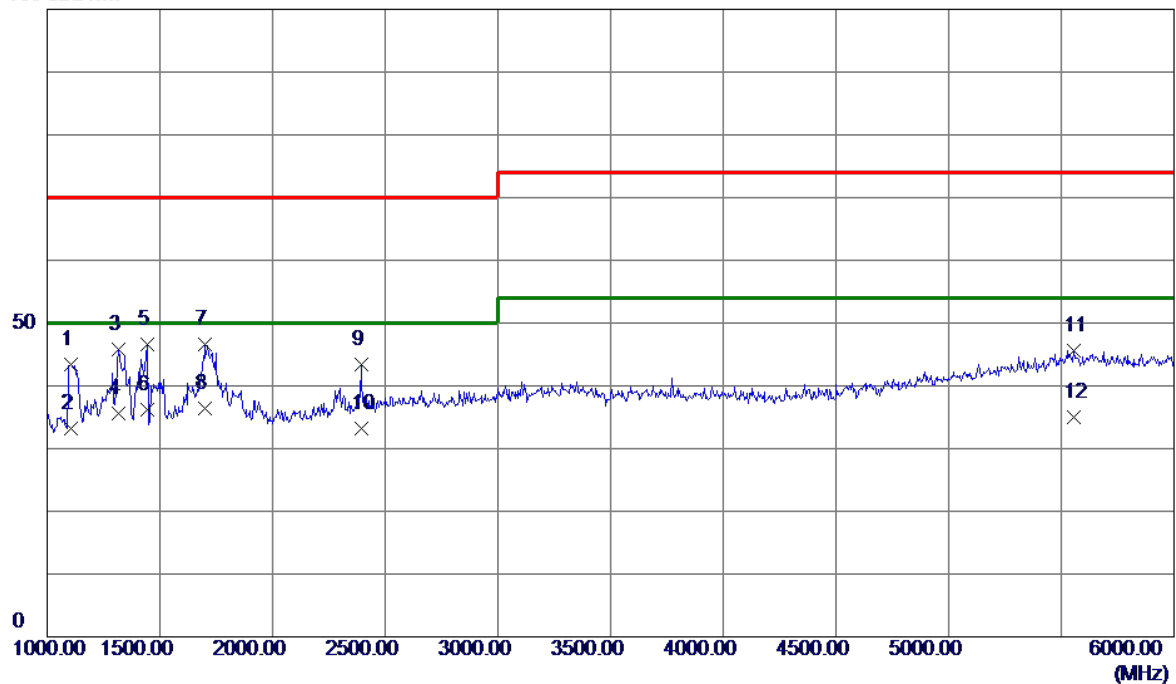

No.	Freq. MHz	Reading Level dBuV/m	Correct Factor dB	Measure ment dBuV/m	Limit dBuV/m	Margin dB	Detector
1	1105.0000	48.09	-4.78	43.31	70.00	-26.69	Peak
2	1105.0000	38.05	-4.78	33.27	50.00	-16.73	AVG
3	1315.0000	49.51	-3.63	45.88	70.00	-24.12	Peak
4	1315.0000	39.27	-3.63	35.64	50.00	-14.36	AVG
5	1442.5000	49.45	-2.93	46.52	70.00	-23.48	Peak
6	1442.5000	39.22	-2.93	36.29	50.00	-13.71	AVG
7	1702.5000	48.75	-2.19	46.56	70.00	-23.44	Peak
8 *	1702.5000	38.57	-2.19	36.38	50.00	-13.62	AVG
9	2392.5000	42.24	1.20	43.44	70.00	-26.56	Peak
10	2392.5000	31.95	1.20	33.15	50.00	-16.85	AVG
11	5557.5000	31.84	13.84	45.68	74.00	-28.32	Peak
12	5557.5000	21.24	13.84	35.08	54.00	-18.92	AVG

EUT	LCD Monitor	Model Name	X24P1
Temperature	25°C	Relative Humidity	60%
Test Voltage	AC 230V/50Hz	Polarization	Horizontal
Test Mode	D-SUB 1920*1080/60Hz		
Note	Cable:1.8m		
Test Engineer	Jason Yang		
Panel(Brand/Model)	H		

100 dBuV/m

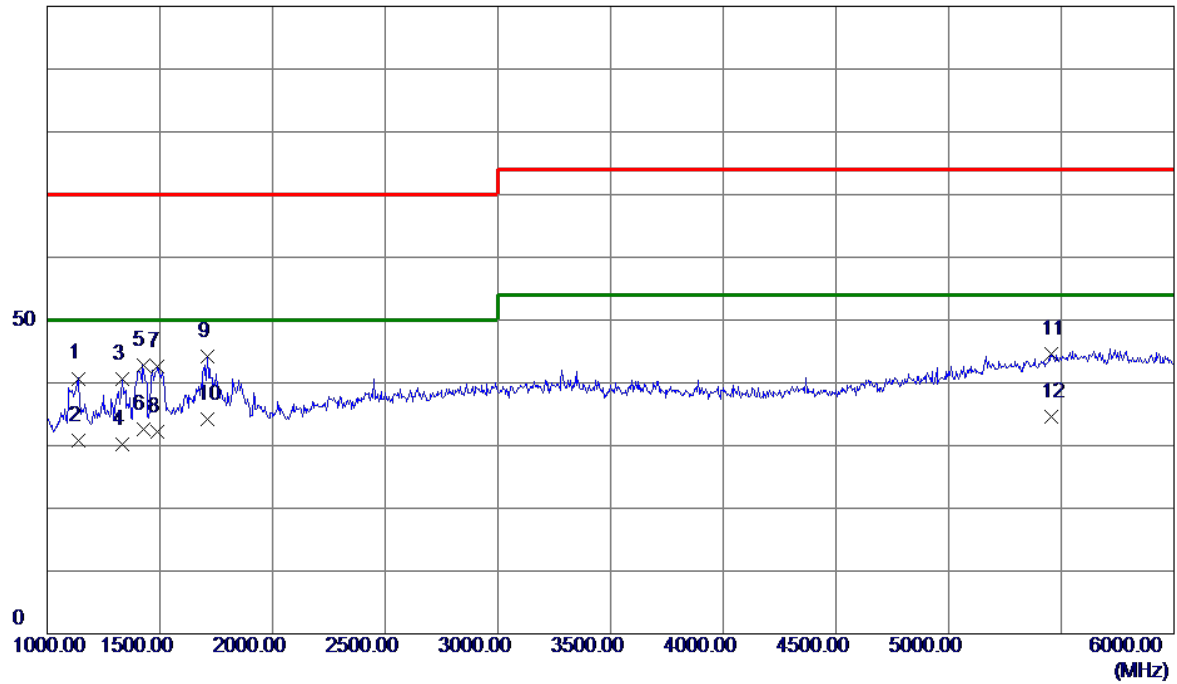

No.	Freq. MHz	Reading Level dBuV/m	Correct Factor dB	Measure ment dBuV/m	Limit dBuV/m	Margin dB	Detector
1	1137.5000	45.30	-4.60	40.70	70.00	-29.30	Peak
2	1137.5000	35.38	-4.60	30.78	50.00	-19.22	AVG
3	1335.0000	44.04	-3.52	40.52	70.00	-29.48	Peak
4	1335.0000	33.77	-3.52	30.25	50.00	-19.75	AVG
5	1425.0000	45.86	-3.03	42.83	70.00	-27.17	Peak
6	1425.0000	35.67	-3.03	32.64	50.00	-17.36	AVG
7	1490.0000	45.35	-2.67	42.68	70.00	-27.32	Peak
8	1490.0000	34.86	-2.67	32.19	50.00	-17.81	AVG
9	1710.0000	46.42	-2.18	44.24	70.00	-25.76	Peak
10 *	1710.0000	36.46	-2.18	34.28	50.00	-15.72	AVG
11	5455.0000	31.17	13.51	44.68	74.00	-29.32	Peak
12	5455.0000	21.16	13.51	34.67	54.00	-19.33	AVG

EUT	LCD Monitor	Model Name	X24P1
Temperature	25°C	Relative Humidity	60%
Test Voltage	AC 230V/50Hz	Polarization	Vertical
Test Mode	HDMI 1920*1080/60Hz		
Note	Cable:1.8m		
Test Engineer	Jason Yang		
Panel(Brand/Model)	H		

100 dBuV/m

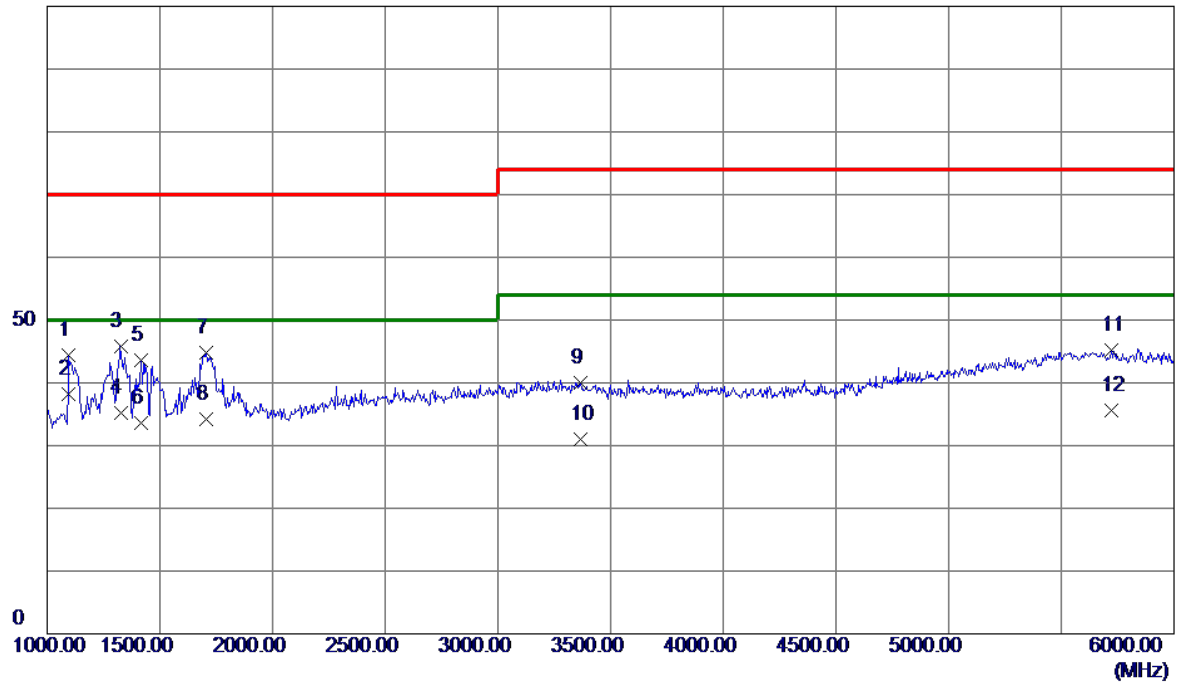

No.	Freq. MHz	Reading Level dBuV/m	Correct Factor dB	Measure ment dBuV/m	Limit dBuV/m	Margin dB	Detector
1	1095.0000	49.31	-4.83	44.48	70.00	-25.52	Peak
2 *	1095.0000	42.98	-4.83	38.15	50.00	-11.85	AVG
3	1325.0000	49.34	-3.58	45.76	70.00	-24.24	Peak
4	1325.0000	38.74	-3.58	35.16	50.00	-14.84	AVG
5	1415.0000	46.66	-3.08	43.58	70.00	-26.42	Peak
6	1415.0000	36.77	-3.08	33.69	50.00	-16.31	AVG
7	1707.5000	47.05	-2.18	44.87	70.00	-25.13	Peak
8	1707.5000	36.35	-2.18	34.17	50.00	-15.83	AVG
9	3365.0000	34.77	5.25	40.02	74.00	-33.98	Peak
10	3365.0000	25.72	5.25	30.97	54.00	-23.03	AVG
11	5720.0000	31.38	13.81	45.19	74.00	-28.81	Peak
12	5720.0000	21.88	13.81	35.69	54.00	-18.31	AVG

EUT	LCD Monitor	Model Name	X24P1
Temperature	25°C	Relative Humidity	60%
Test Voltage	AC 230V/50Hz	Polarization	Horizontal
Test Mode	HDMI 1920*1080/60Hz		
Note	Cable:1.8m		
Test Engineer	Jason Yang		
Panel(Brand/Model)	H		

100 dBuV/m

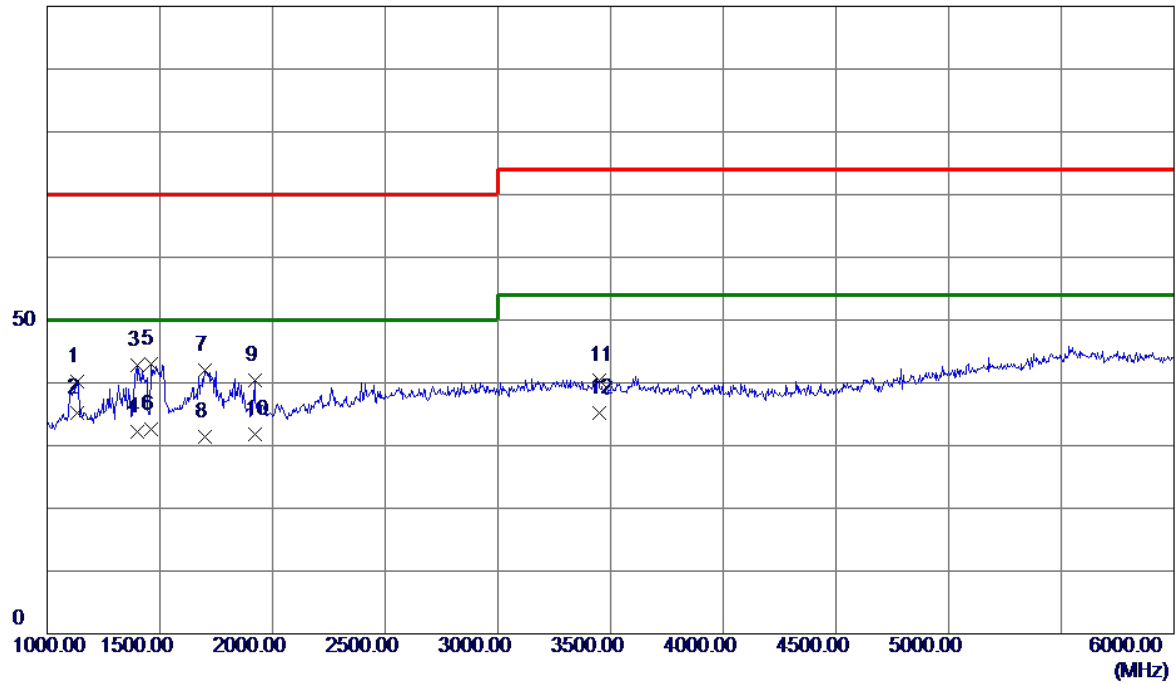

No.	Freq. MHz	Reading Level dBuV/m	Correct Factor dB	Measure ment dBuV/m	Limit dBuV/m	Margin dB	Detector
1	1132.5000	44.84	-4.63	40.21	70.00	-29.79	Peak
2 *	1132.5000	39.81	-4.63	35.18	50.00	-14.82	AVG
3	1397.5000	45.89	-3.18	42.71	70.00	-27.29	Peak
4	1397.5000	35.33	-3.18	32.15	50.00	-17.85	AVG
5	1460.0000	45.82	-2.84	42.98	70.00	-27.02	Peak
6	1460.0000	35.48	-2.84	32.64	50.00	-17.36	AVG
7	1702.5000	44.16	-2.19	41.97	70.00	-28.03	Peak
8	1702.5000	33.66	-2.19	31.47	50.00	-18.53	AVG
9	1920.0000	42.11	-1.74	40.37	70.00	-29.63	Peak
10	1920.0000	33.56	-1.74	31.82	50.00	-18.18	AVG
11	3447.5000	35.01	5.45	40.46	74.00	-33.54	Peak
12	3447.5000	29.71	5.45	35.16	54.00	-18.84	AVG

EUT	LCD Monitor	Model Name	X24P1
Temperature	25°C	Relative Humidity	60%
Test Voltage	AC 230V/50Hz	Polarization	Vertical
Test Mode	HDMI 1920*1080/60Hz		
Note	Cable:1.5m		
Test Engineer	Jason Yang		
Panel(Brand/Model)	H		

100 dBuV/m

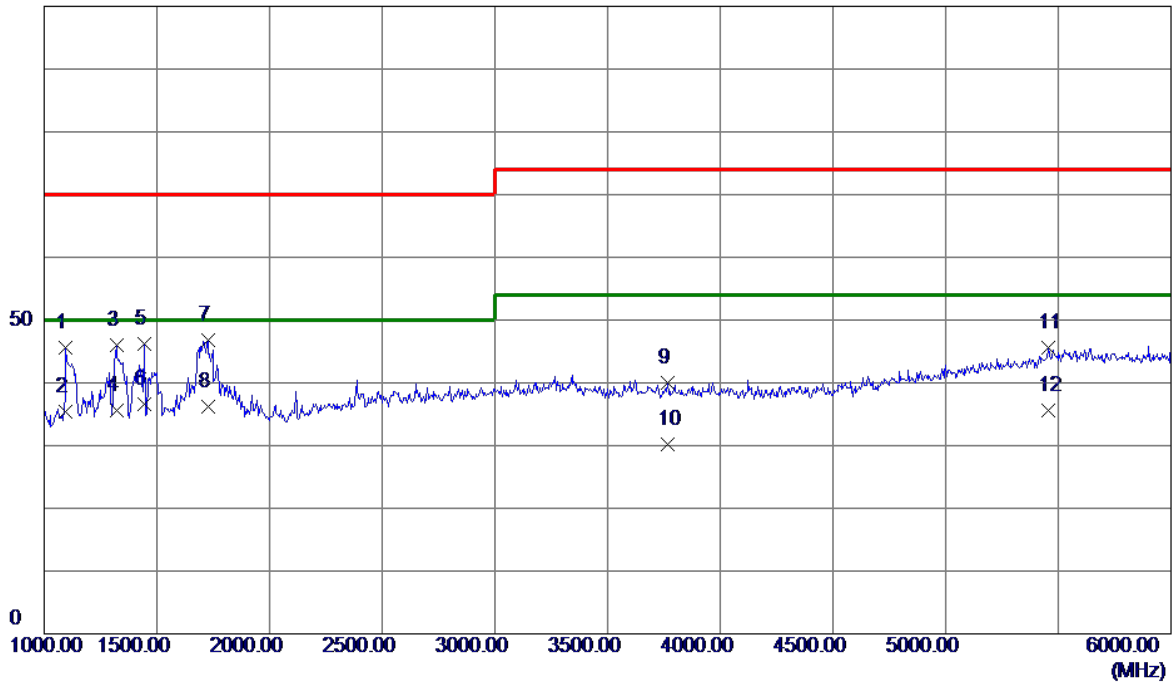

No.	Freq. MHz	Reading Level dBuV/m	Correct Factor dB	Measure ment dBuV/m	Limit dBuV/m	Margin dB	Detector
1	1095.0000	50.34	-4.83	45.51	70.00	-24.49	Peak
2	1095.0000	40.30	-4.83	35.47	50.00	-14.53	AVG
3	1322.5000	49.52	-3.59	45.93	70.00	-24.07	Peak
4	1322.5000	39.28	-3.59	35.69	50.00	-14.31	AVG
5	1442.5000	49.21	-2.93	46.28	70.00	-23.72	Peak
6 *	1442.5000	39.44	-2.93	36.51	50.00	-13.49	AVG
7	1727.5000	48.85	-2.14	46.71	70.00	-23.29	Peak
8	1727.5000	38.34	-2.14	36.20	50.00	-13.80	AVG
9	3765.0000	34.13	5.87	40.00	74.00	-34.00	Peak
10	3765.0000	24.28	5.87	30.15	54.00	-23.85	AVG
11	5457.5000	32.13	13.53	45.66	74.00	-28.34	Peak
12	5457.5000	22.12	13.53	35.65	54.00	-18.35	AVG

EUT	LCD Monitor	Model Name	X24P1
Temperature	25°C	Relative Humidity	60%
Test Voltage	AC 230V/50Hz	Polarization	Horizontal
Test Mode	HDMI 1920*1080/60Hz		
Note	Cable:1.5m		
Test Engineer	Jason Yang		
Panel(Brand/Model)	H		

100 dBuV/m

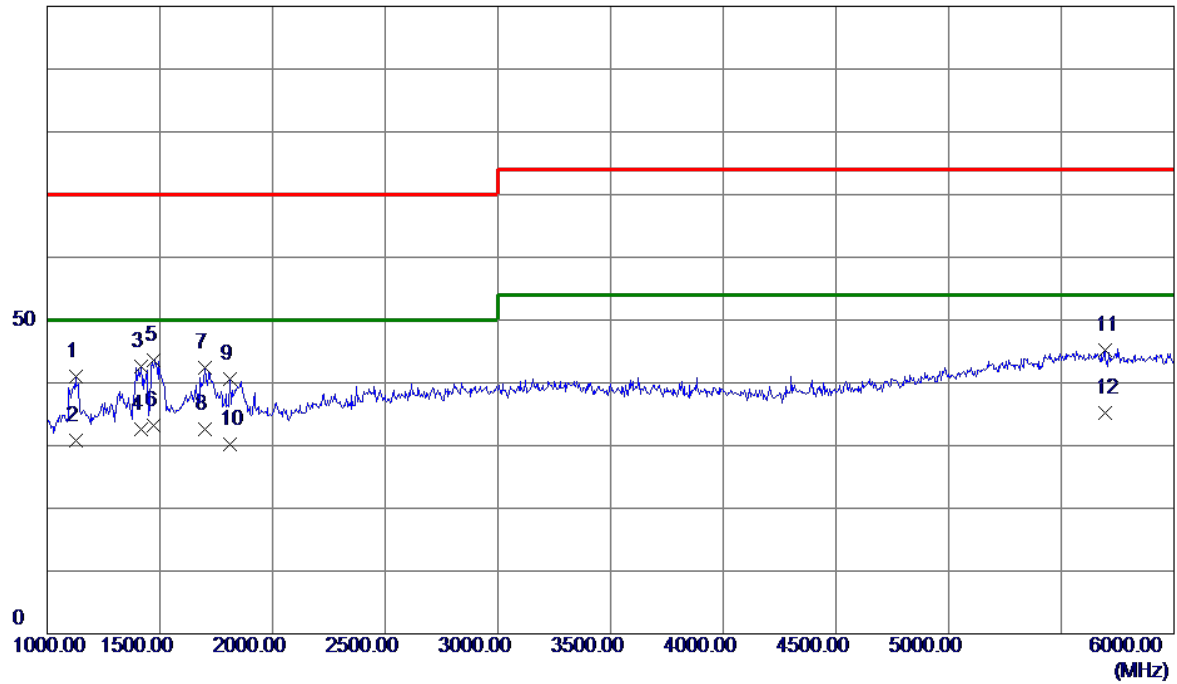

No.	Freq. MHz	Reading Level dBuV/m	Correct Factor dB	Measure ment dBuV/m	Limit dBuV/m	Margin dB	Detector
1	1127.5000	45.62	-4.65	40.97	70.00	-29.03	Peak
2	1127.5000	35.43	-4.65	30.78	50.00	-19.22	AVG
3	1415.0000	45.61	-3.08	42.53	70.00	-27.47	Peak
4	1415.0000	35.77	-3.08	32.69	50.00	-17.31	AVG
5	1475.0000	46.42	-2.76	43.66	70.00	-26.34	Peak
6 *	1475.0000	35.92	-2.76	33.16	50.00	-16.84	AVG
7	1702.5000	44.67	-2.19	42.48	70.00	-27.52	Peak
8	1702.5000	34.73	-2.19	32.54	50.00	-17.46	AVG
9	1812.5000	42.64	-1.96	40.68	70.00	-29.32	Peak
10	1812.5000	32.14	-1.96	30.18	50.00	-19.82	AVG
11	5692.5000	31.34	13.81	45.15	74.00	-28.85	Peak
12	5692.5000	21.47	13.81	35.28	54.00	-18.72	AVG

EUT	LCD Monitor	Model Name	X24P1
Temperature	25°C	Relative Humidity	60%
Test Voltage	AC 230V/50Hz	Polarization	Vertical
Test Mode	HDMI 1920*1080/60Hz		
Note	Cable:1.2m		
Test Engineer	Jason Yang		
Panel(Brand/Model)	H		

100 dBuV/m

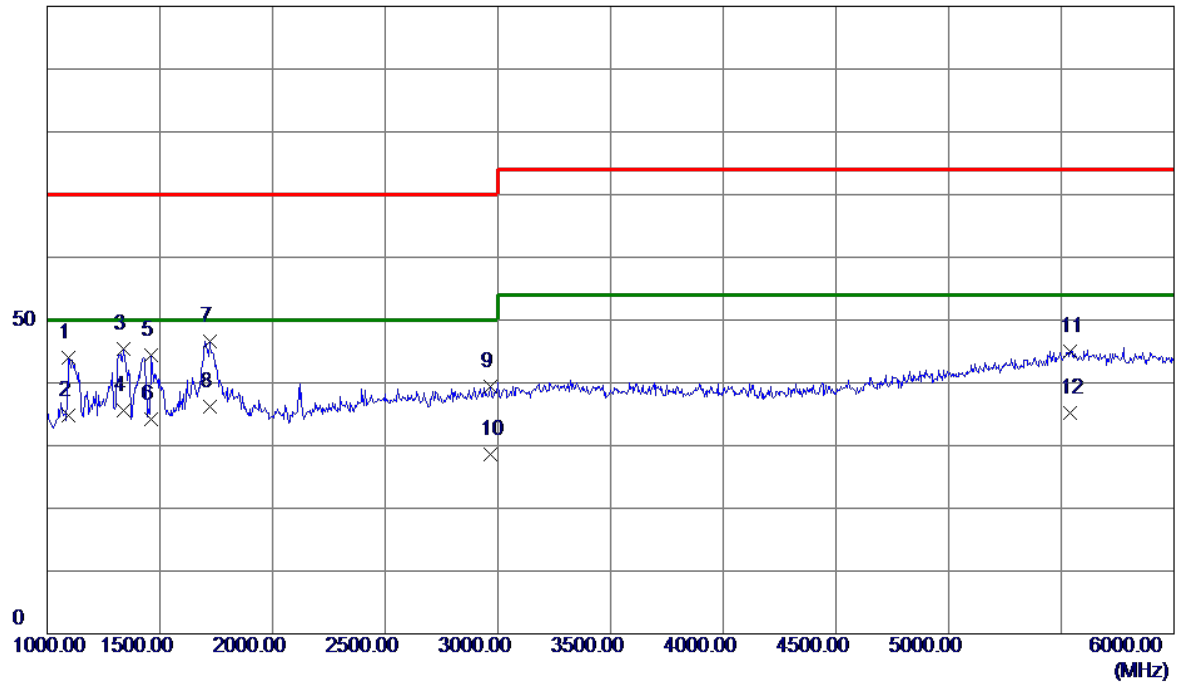

No.	Freq. MHz	Reading Level dBuV/m	Correct Factor dB	Measure ment dBuV/m	Limit dBuV/m	Margin dB	Detector
1	1095.0000	48.91	-4.83	44.08	70.00	-25.92	Peak
2	1095.0000	39.62	-4.83	34.79	50.00	-15.21	AVG
3	1340.0000	48.84	-3.49	45.35	70.00	-24.65	Peak
4	1340.0000	39.13	-3.49	35.64	50.00	-14.36	AVG
5	1460.0000	47.26	-2.84	44.42	70.00	-25.58	Peak
6	1460.0000	37.02	-2.84	34.18	50.00	-15.82	AVG
7	1720.0000	48.78	-2.16	46.62	70.00	-23.38	Peak
8 *	1720.0000	38.36	-2.16	36.20	50.00	-13.80	AVG
9	2967.5000	35.28	4.21	39.49	70.00	-30.51	Peak
10	2967.5000	24.35	4.21	28.56	50.00	-21.44	AVG
11	5540.0000	31.25	13.84	45.09	74.00	-28.91	Peak
12	5540.0000	21.35	13.84	35.19	54.00	-18.81	AVG

EUT	LCD Monitor	Model Name	X24P1
Temperature	25°C	Relative Humidity	60%
Test Voltage	AC 230V/50Hz	Polarization	Horizontal
Test Mode	HDMI 1920*1080/60Hz		
Note	Cable:1.2m		
Test Engineer	Jason Yang		
Panel(Brand/Model)	H		

100 dBuV/m

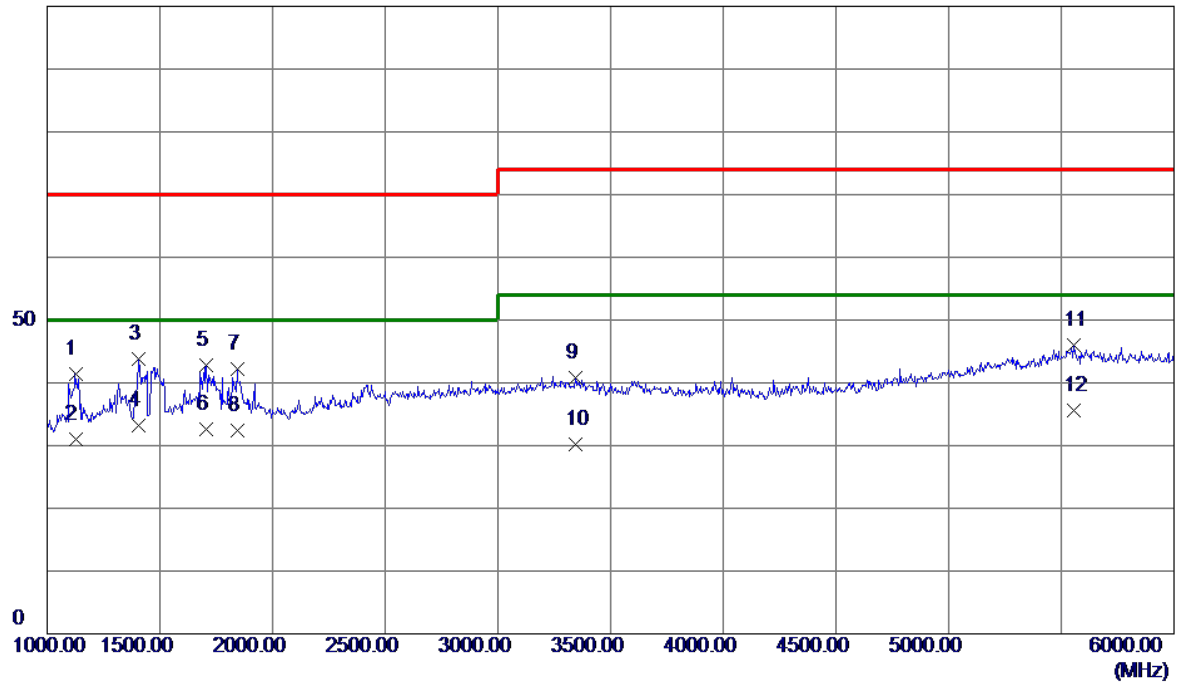

No.	Freq. MHz	Reading Level dBuV/m	Correct Factor dB	Measure ment dBuV/m	Limit dBuV/m	Margin dB	Detector
1	1125.0000	46.11	-4.67	41.44	70.00	-28.56	Peak
2	1125.0000	35.69	-4.67	31.02	50.00	-18.98	AVG
3	1405.0000	46.89	-3.14	43.75	70.00	-26.25	Peak
4 *	1405.0000	36.40	-3.14	33.26	50.00	-16.74	AVG
5	1707.5000	44.89	-2.18	42.71	70.00	-27.29	Peak
6	1707.5000	34.85	-2.18	32.67	50.00	-17.33	AVG
7	1842.5000	44.11	-1.90	42.21	70.00	-27.79	Peak
8	1842.5000	34.38	-1.90	32.48	50.00	-17.52	AVG
9	3342.5000	35.66	5.20	40.86	74.00	-33.14	Peak
10	3342.5000	24.95	5.20	30.15	54.00	-23.85	AVG
11	5555.0000	32.09	13.84	45.93	74.00	-28.07	Peak
12	5555.0000	21.85	13.84	35.69	54.00	-18.31	AVG

EUT	LCD Monitor	Model Name	X24P1
Temperature	25°C	Relative Humidity	60%
Test Voltage	AC 110V/60Hz	Polarization	Vertical
Test Mode	HDMI 1920*1080/60Hz		
Note	Cable:1.8m		
Test Engineer	Jason Yang		
Panel(Brand/Model)	H		

100 dBuV/m

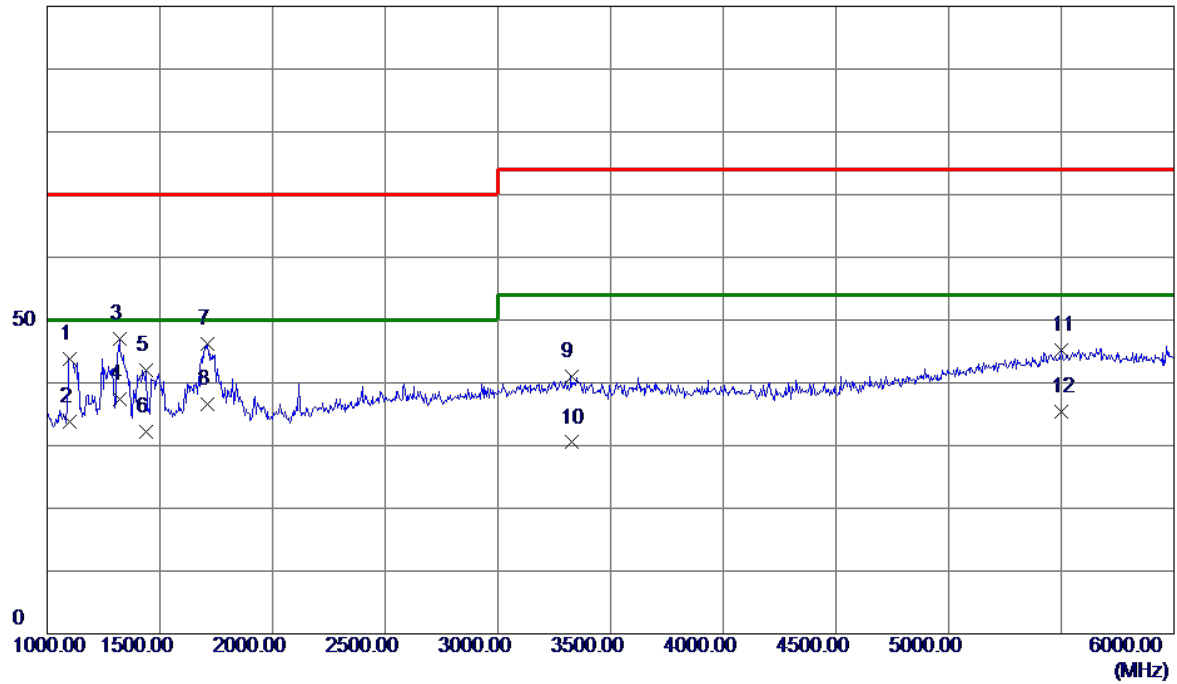

No.	Freq. MHz	Reading Level dBuV/m	Correct Factor dB	Measure ment dBuV/m	Limit dBuV/m	Margin dB	Detector
1	1102.5000	48.68	-4.79	43.89	70.00	-26.11	Peak
2	1102.5000	38.52	-4.79	33.73	50.00	-16.27	AVG
3	1322.5000	50.66	-3.59	47.07	70.00	-22.93	Peak
4 *	1322.5000	41.04	-3.59	37.45	50.00	-12.55	AVG
5	1440.0000	45.03	-2.95	42.08	70.00	-27.92	Peak
6	1440.0000	35.13	-2.95	32.18	50.00	-17.82	AVG
7	1712.5000	48.38	-2.17	46.21	70.00	-23.79	Peak
8	1712.5000	38.79	-2.17	36.62	50.00	-13.38	AVG
9	3325.0000	35.76	5.15	40.91	74.00	-33.09	Peak
10	3325.0000	25.35	5.15	30.50	54.00	-23.50	AVG
11	5502.5000	31.38	13.85	45.23	74.00	-28.77	Peak
12	5502.5000	21.58	13.85	35.43	54.00	-18.57	AVG

EUT	LCD Monitor	Model Name	X24P1
Temperature	25°C	Relative Humidity	60%
Test Voltage	AC 110V/60Hz	Polarization	Horizontal
Test Mode	HDMI 1920*1080/60Hz		
Note	Cable:1.8m		
Test Engineer	Jason Yang		
Panel(Brand/Model)	H		

100 dBuV/m

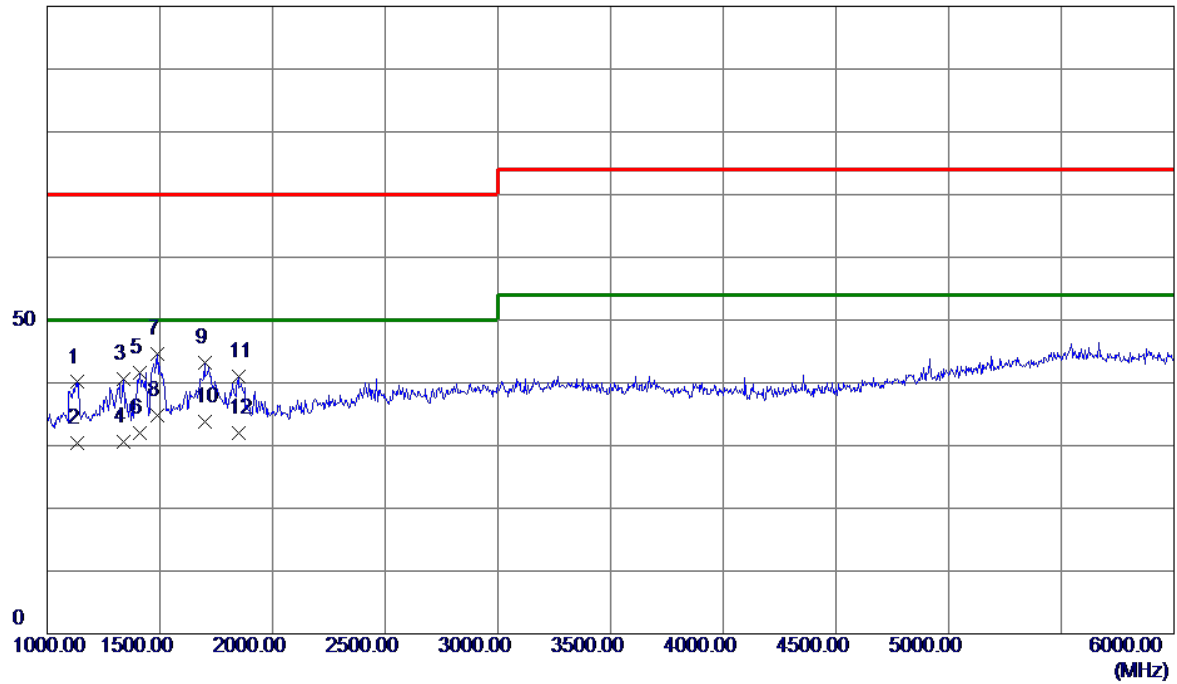

No.	Freq. MHz	Reading Level dBuV/m	Correct Factor dB	Measure ment dBuV/m	Limit dBuV/m	Margin dB	Detector
1	1132.5000	44.73	-4.63	40.10	70.00	-29.90	Peak
2	1132.5000	35.11	-4.63	30.48	50.00	-19.52	AVG
3	1337.5000	44.04	-3.51	40.53	70.00	-29.47	Peak
4	1337.5000	34.13	-3.51	30.62	50.00	-19.38	AVG
5	1410.0000	44.73	-3.11	41.62	70.00	-28.38	Peak
6	1410.0000	35.03	-3.11	31.92	50.00	-18.08	AVG
7	1487.5000	47.31	-2.69	44.62	70.00	-25.38	Peak
8 *	1487.5000	37.45	-2.69	34.76	50.00	-15.24	AVG
9	1697.5000	45.34	-2.21	43.13	70.00	-26.87	Peak
10	1697.5000	36.02	-2.21	33.81	50.00	-16.19	AVG
11	1847.5000	42.89	-1.89	41.00	70.00	-29.00	Peak
12	1847.5000	33.84	-1.89	31.95	50.00	-18.05	AVG

EUT	LCD Monitor	Model Name	X24P1
Temperature	25°C	Relative Humidity	60%
Test Voltage	AC 230V/50Hz	Polarization	Vertical
Test Mode	HDMI 1080P		
Note	Cable:1.8m		
Test Engineer	Jason Yang		
Panel(Brand/Model)	H		

100 dBuV/m

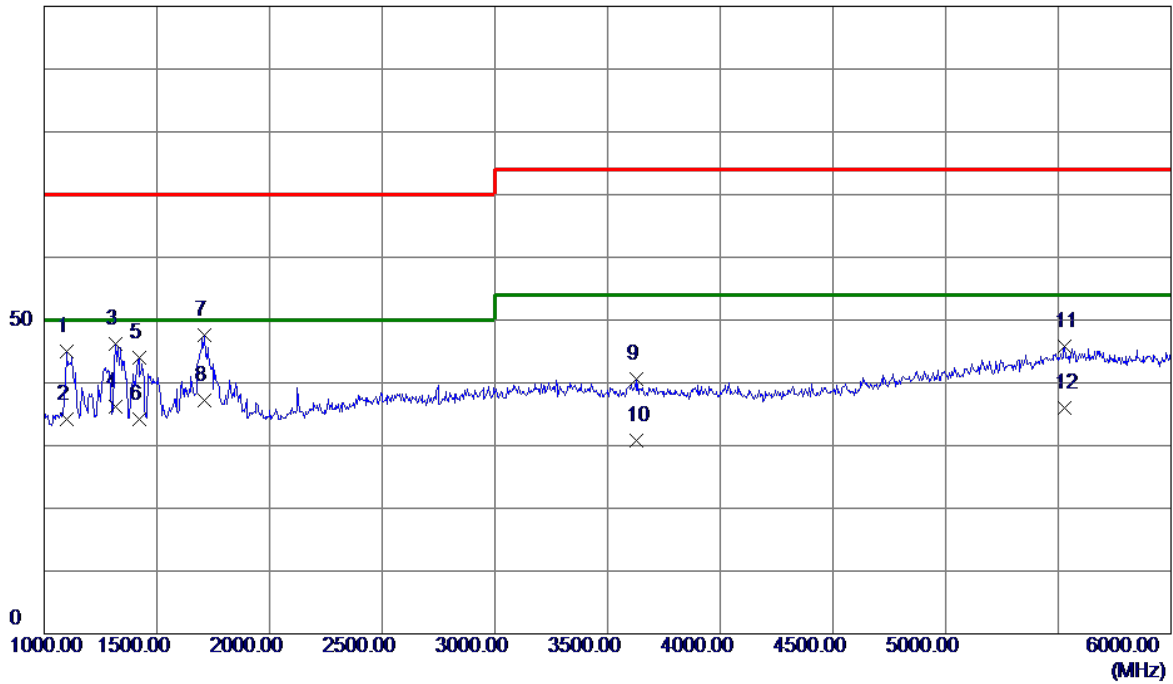

No.	Freq. MHz	Reading Level dBuV/m	Correct Factor dB	Measure ment dBuV/m	Limit dBuV/m	Margin dB	Detector
1	1097.5000	49.74	-4.82	44.92	70.00	-25.08	Peak
2	1097.5000	38.99	-4.82	34.17	50.00	-15.83	AVG
3	1317.5000	49.91	-3.62	46.29	70.00	-23.71	Peak
4	1317.5000	39.90	-3.62	36.28	50.00	-13.72	AVG
5	1420.0000	47.15	-3.06	44.09	70.00	-25.91	Peak
6	1420.0000	37.21	-3.06	34.15	50.00	-15.85	AVG
7	1712.5000	49.70	-2.17	47.53	70.00	-22.47	Peak
8 *	1712.5000	39.42	-2.17	37.25	50.00	-12.75	AVG
9	3630.0000	34.80	5.72	40.52	74.00	-33.48	Peak
10	3630.0000	25.16	5.72	30.88	54.00	-23.12	AVG
11	5530.0000	31.94	13.84	45.78	74.00	-28.22	Peak
12	5530.0000	22.10	13.84	35.94	54.00	-18.06	AVG

EUT	LCD Monitor	Model Name	X24P1
Temperature	25°C	Relative Humidity	60%
Test Voltage	AC 230V/50Hz	Polarization	Horizontal
Test Mode	HDMI 1080P		
Note	Cable:1.8m		
Test Engineer	Jason Yang		
Panel(Brand/Model)	H		

100 dBuV/m

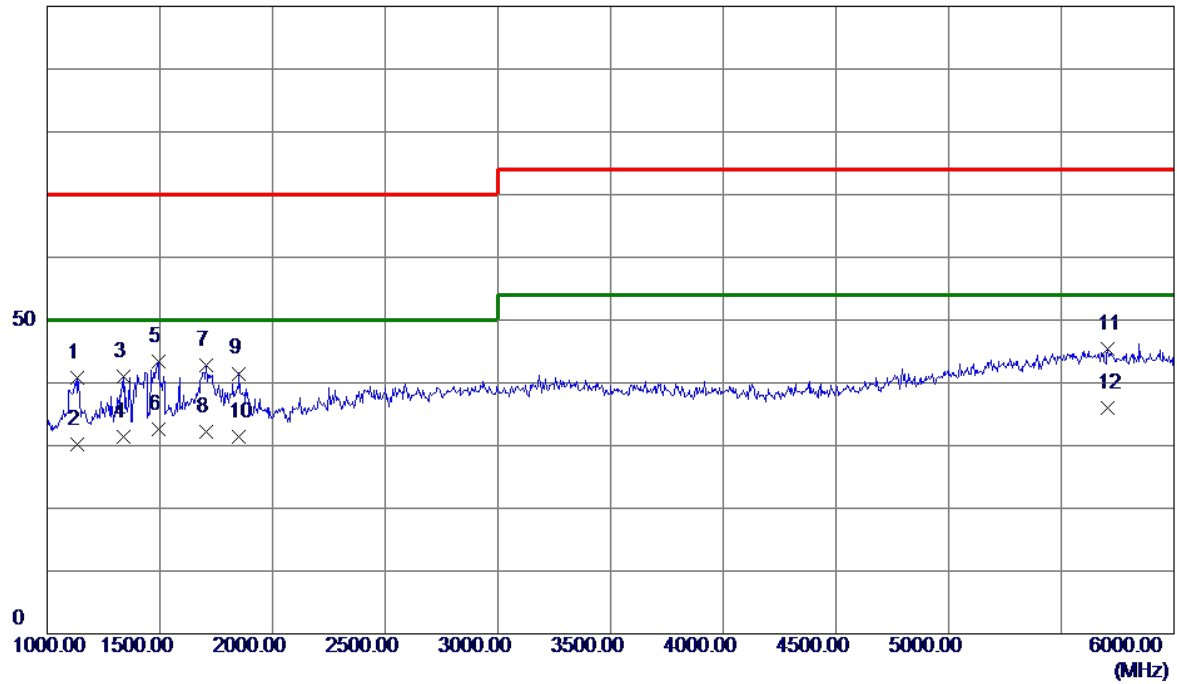

No.	Freq. MHz	Reading Level dBuV/m	Correct Factor dB	Measure ment dBuV/m	Limit dBuV/m	Margin dB	Detector
1	1132.5000	45.43	-4.63	40.80	70.00	-29.20	Peak
2	1132.5000	34.81	-4.63	30.18	50.00	-19.82	AVG
3	1337.5000	44.51	-3.51	41.00	70.00	-29.00	Peak
4	1337.5000	34.96	-3.51	31.45	50.00	-18.55	AVG
5	1492.5000	45.98	-2.66	43.32	70.00	-26.68	Peak
6 *	1492.5000	35.31	-2.66	32.65	50.00	-17.35	AVG
7	1707.5000	44.98	-2.18	42.80	70.00	-27.20	Peak
8	1707.5000	34.33	-2.18	32.15	50.00	-17.85	AVG
9	1852.5000	43.38	-1.88	41.50	70.00	-28.50	Peak
10	1852.5000	33.35	-1.88	31.47	50.00	-18.53	AVG
11	5705.0000	31.59	13.81	45.40	74.00	-28.60	Peak
12	5705.0000	22.19	13.81	36.00	54.00	-18.00	AVG

4.2 CONDUCTED EMISSION MEASUREMENT AT AC MAINS POWER PORTS

4.2.1 LIMITS

Requirements for conducted emissions from AC mains power ports of Class A equipment

Table clause	Frequency Range MHz	Coupling Device	Detector Type / bandwidth	Class A Limits (dB(μV))
A8.1	0.15 - 0.5	AMN	Quasi Peak / 9 kHz	79
	0.5 - 30			73
A8.2	0.15 - 0.5	AMN	Average / 9 kHz	66
	0.5 - 30			60

Requirements for conducted emissions from AC mains power ports of Class B equipment

Table clause	Frequency Range MHz	Coupling Device	Detector Type / bandwidth	Class B Limits (dB(μV))
A9.1	0.15 - 0.5	AMN	Quasi Peak / 9 kHz	66-56
	0.5 - 5			56
	5 - 30			60
A9.2	0.15 - 0.5	AMN	Average / 9 kHz	56-46
	0.5 - 5			46
	5 - 30			50

NOTE:

- (1) The test result calculated as following:
 Measurement Value = Reading Level + Correct Factor
 Correct Factor = Insertion Loss + Cable Loss + Attenuator Factor(if use)
 Margin Level = Measurement Value – Limit Value

4.2.2 MEASUREMENT INSTRUMENTS LIST

Item	Kind of Equipment	Manufacturer	Type No.	Serial No.	Calibrated until
1	Measurement Software	Farad	EZ-EMC Ver.NB-03A 1-01	N/A	N/A
2	50Ω Terminator	SHX	TF2-3G-A	08122901	Mar. 26, 2018
3	TWO-LINE V-NETWORK	R&S	ENV216	100526	Mar. 26, 2018
4	EMI Test Receiver	R&S	ESR3	101862	Aug. 15, 2018
5	Artificial-Mains Network	SCHWARZBECK	NSLK 8127	8127685	Aug. 20, 2018
6	Cable	N/A	RG400 12m	N/A	Mar. 07, 2018

Remark: "N/A" denotes no model name, no serial no. or no calibration specified.

All calibration period of equipment list is one year.

4.2.3 TEST PROCEDURE

- The EUT was placed 0.8 meters from the horizontal ground plane with EUT being connected to the power mains through a line impedance stabilization network (LISN). All other support equipments powered from additional LISN(s). The LISN provide 50 Ohm/ 50uH of coupling impedance for the measuring instrument.
- Interconnecting cables that hang closer than 40 cm to the ground plane shall be folded back and forth in the center forming a bundle 30 to 40 cm long.
- I/O cables that are not connected to a peripheral shall be bundled in the center. The end of the cable may be terminated, if required, using the correct terminating impedance. The overall length shall not exceed 1 m.
- LISN at least 80 cm from nearest part of EUT chassis.
- For the actual test configuration, please refer to the related Item –EUT Test Photos.

4.2.4 DEVIATION FROM TEST STANDARD

No deviation

4.2.5 TEST SETUP

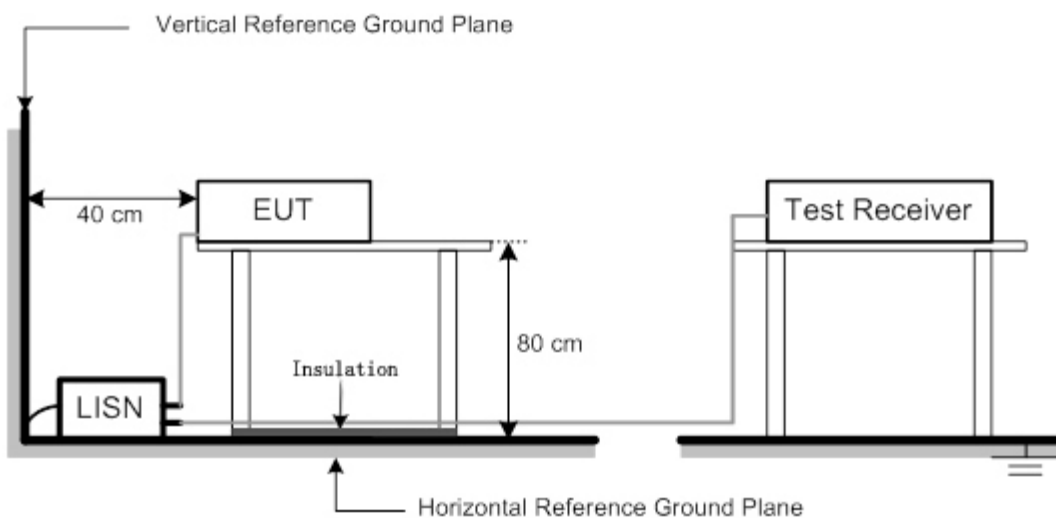

4.2.6 TEST RESULTS

EUT	LCD Monitor	Model Name	X24P1
Temperature	25°C	Relative Humidity	53%
Test Voltage	AC 230V/50Hz	Phase	Line
Test Mode	D-SUB 1920*1080/60Hz		
Note	Cable:1.8m		
Test Engineer	Jason Yang		

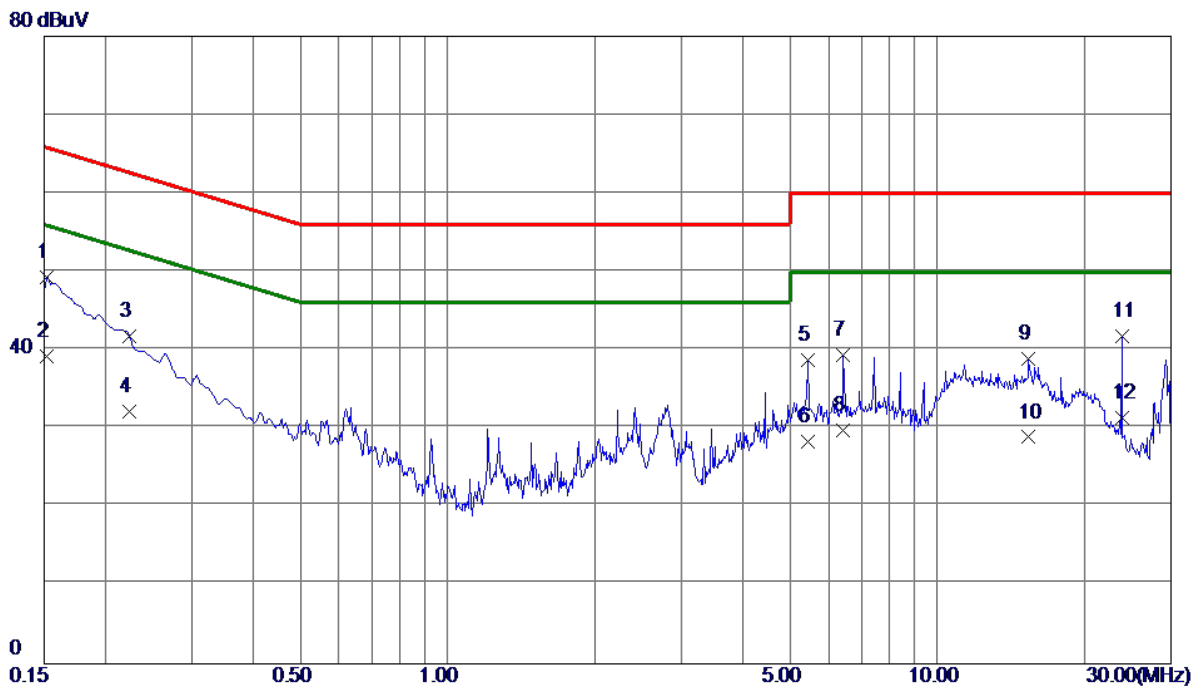

No.	Freq. MHz	Reading Level dBuV	Correct Factor dB	Measure ment dBuV	Limit dBuV	Margin dB	Detector
1	0.1522	39.59	9.67	49.26	65.88	-16.62	QP
2 *	0.1522	29.60	9.67	39.27	55.88	-16.61	AVG
3	0.2243	32.06	9.69	41.75	62.66	-20.91	QP
4	0.2243	22.40	9.69	32.09	52.66	-20.57	AVG
5	5.4375	28.60	10.06	38.66	60.00	-21.34	QP
6	5.4375	18.20	10.06	28.26	50.00	-21.74	AVG
7	6.4252	29.28	10.12	39.40	60.00	-20.60	QP
8	6.4252	19.60	10.12	29.72	50.00	-20.28	AVG
9	15.3240	28.36	10.47	38.83	60.00	-21.17	QP
10	15.3240	18.41	10.47	28.88	50.00	-21.12	AVG
11	23.8110	30.91	10.84	41.75	60.00	-18.25	QP
12	23.8110	20.50	10.84	31.34	50.00	-18.66	AVG

EUT	LCD Monitor	Model Name	X24P1
Temperature	25°C	Relative Humidity	53%
Test Voltage	AC 230V/50Hz	Phase	Neutral
Test Mode	D-SUB 1920*1080/60Hz		
Note	Cable:1.8m		
Test Engineer	Jason Yang		

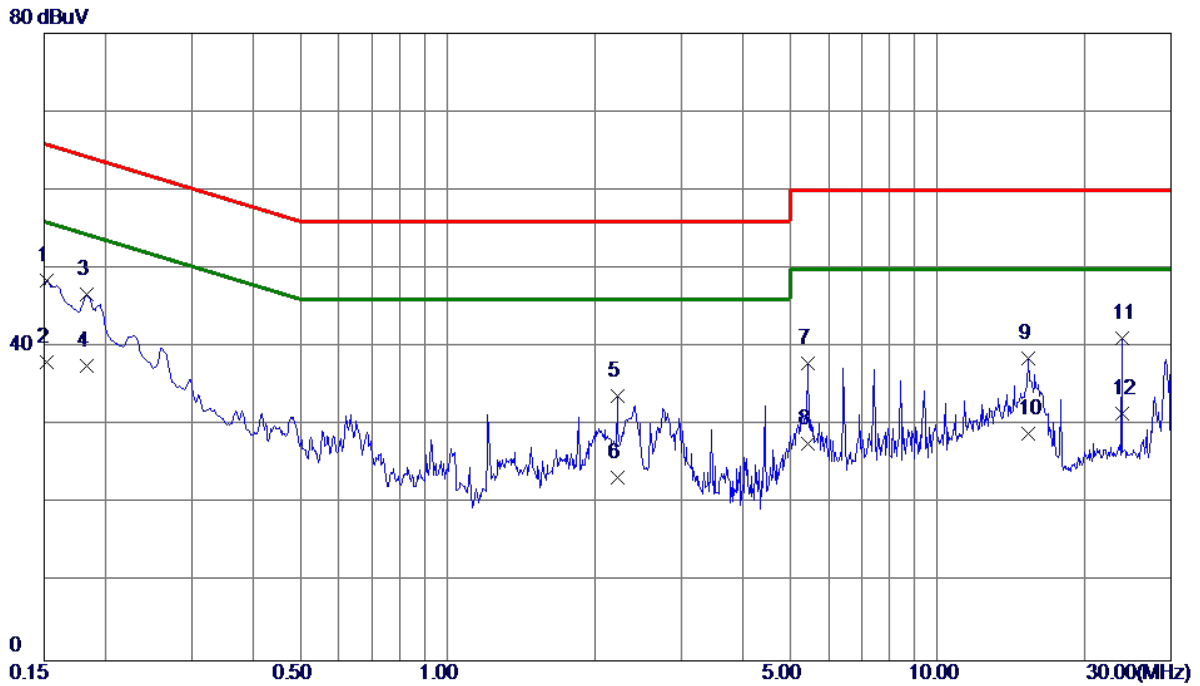

No.	Freq. MHz	Reading Level dBuV	Correct Factor dB	Measure ment dBuV	Limit dBuV	Margin dB	Detector
1	0.1522	38.81	9.66	48.47	65.88	-17.41	QP
2	0.1522	28.40	9.66	38.06	55.88	-17.82	AVG
3	0.1836	37.07	9.67	46.74	64.32	-17.58	QP
4 *	0.1836	27.90	9.67	37.57	54.32	-16.75	AVG
5	2.2222	23.95	9.86	33.81	56.00	-22.19	QP
6	2.2222	13.50	9.86	23.36	46.00	-22.64	AVG
7	5.4375	27.86	10.05	37.91	60.00	-22.09	QP
8	5.4375	17.60	10.05	27.65	50.00	-22.35	AVG
9	15.3217	28.04	10.58	38.62	60.00	-21.38	QP
10	15.3217	18.40	10.58	28.98	50.00	-21.02	AVG
11	23.8110	30.02	11.03	41.05	60.00	-18.95	QP
12	23.8110	20.50	11.03	31.53	50.00	-18.47	AVG

EUT	LCD Monitor	Model Name	X24P1
Temperature	25°C	Relative Humidity	53%
Test Voltage	AC 230V/50Hz	Phase	Line
Test Mode	HDMI 1920*1080/60Hz		
Note	Cable:1.8m		
Test Engineer	Jason Yang		

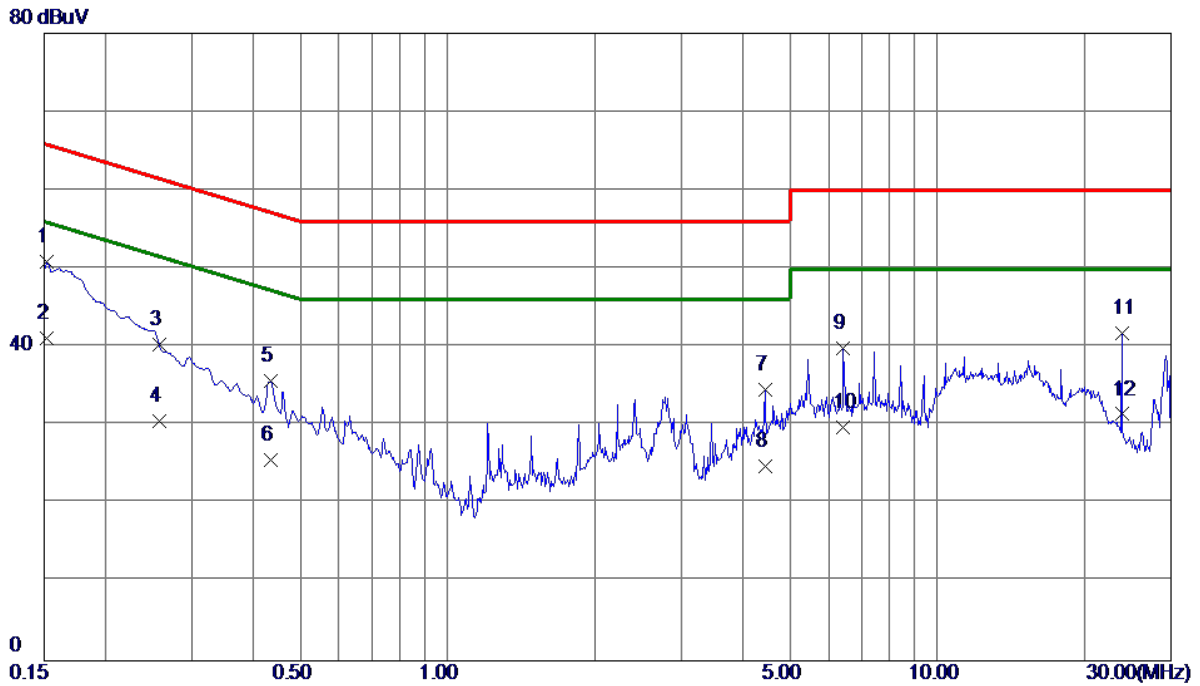

No.	Freq. MHz	Reading Level dBuV	Correct Factor dB	Measure ment dBuV	Limit dBuV	Margin dB	Detector
1	0.1522	41.19	9.67	50.86	65.88	-15.02	QP
2 *	0.1522	31.50	9.67	41.17	55.88	-14.71	AVG
3	0.2580	30.66	9.69	40.35	61.50	-21.15	QP
4	0.2580	20.90	9.69	30.59	51.50	-20.91	AVG
5	0.4357	25.91	9.72	35.63	57.14	-21.51	QP
6	0.4357	15.90	9.72	25.62	47.14	-21.52	AVG
7	4.4497	24.52	10.00	34.52	56.00	-21.48	QP
8	4.4497	14.79	10.00	24.79	46.00	-21.21	AVG
9	6.4274	29.71	10.12	39.83	60.00	-20.17	QP
10	6.4274	19.70	10.12	29.82	50.00	-20.18	AVG
11	23.8110	30.88	10.84	41.72	60.00	-18.28	QP
12	23.8110	20.60	10.84	31.44	50.00	-18.56	AVG

EUT	LCD Monitor	Model Name	X24P1
Temperature	25°C	Relative Humidity	53%
Test Voltage	AC 230V/50Hz	Phase	Neutral
Test Mode	HDMI 1920*1080/60Hz		
Note	Cable:1.8m		
Test Engineer	Jason Yang		

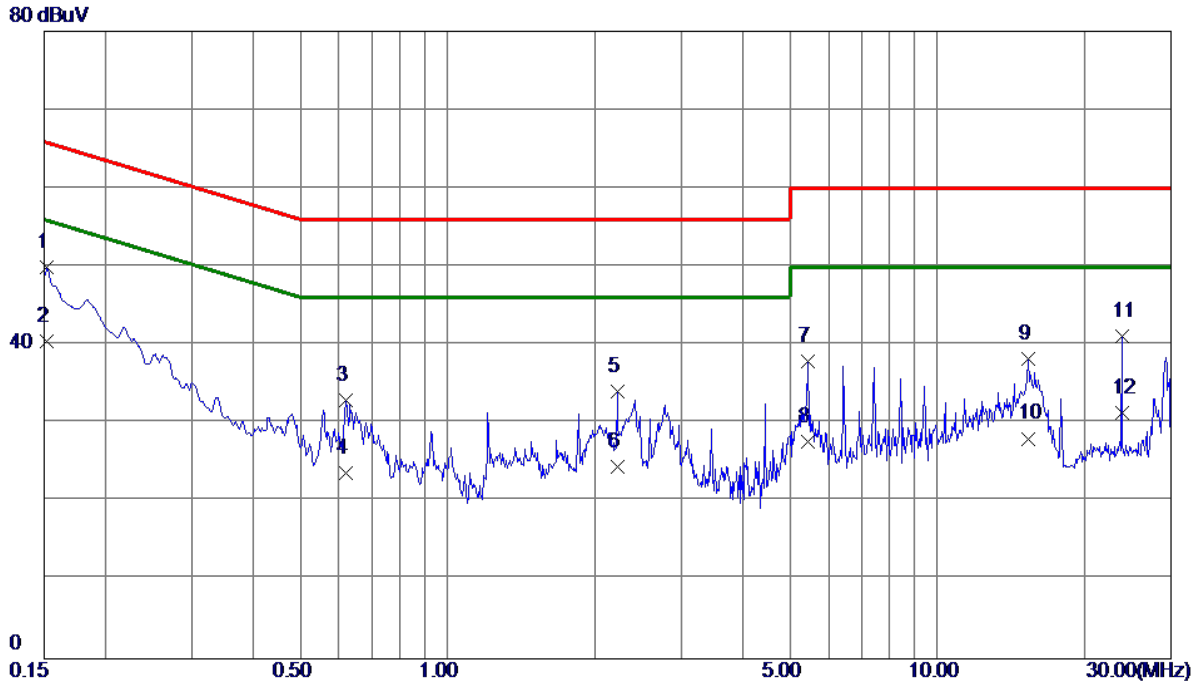

No.	Freq. MHz	Reading Level dBuV	Correct Factor dB	Measure ment dBuV	Limit dBuV	Margin dB	Detector
1	0.1522	40.18	9.66	49.84	65.88	-16.04	QP
2 *	0.1522	30.80	9.66	40.46	55.88	-15.42	AVG
3	0.6202	23.28	9.73	33.01	56.00	-22.99	QP
4	0.6202	13.90	9.73	23.63	46.00	-22.37	AVG
5	2.2222	24.15	9.86	34.01	56.00	-21.99	QP
6	2.2222	14.60	9.86	24.46	46.00	-21.54	AVG
7	5.4375	27.86	10.05	37.91	60.00	-22.09	QP
8	5.4375	17.60	10.05	27.65	50.00	-22.35	AVG
9	15.3240	27.71	10.58	38.29	60.00	-21.71	QP
10	15.3240	17.50	10.58	28.08	50.00	-21.92	AVG
11	23.8110	30.07	11.03	41.10	60.00	-18.90	QP
12	23.8110	20.40	11.03	31.43	50.00	-18.57	AVG

EUT	LCD Monitor	Model Name	X24P1
Temperature	25°C	Relative Humidity	53%
Test Voltage	AC 230V/50Hz	Phase	Line
Test Mode	HDMI 1920*1080/60Hz		
Note	Cable:1.5m		
Test Engineer	Jason Yang		

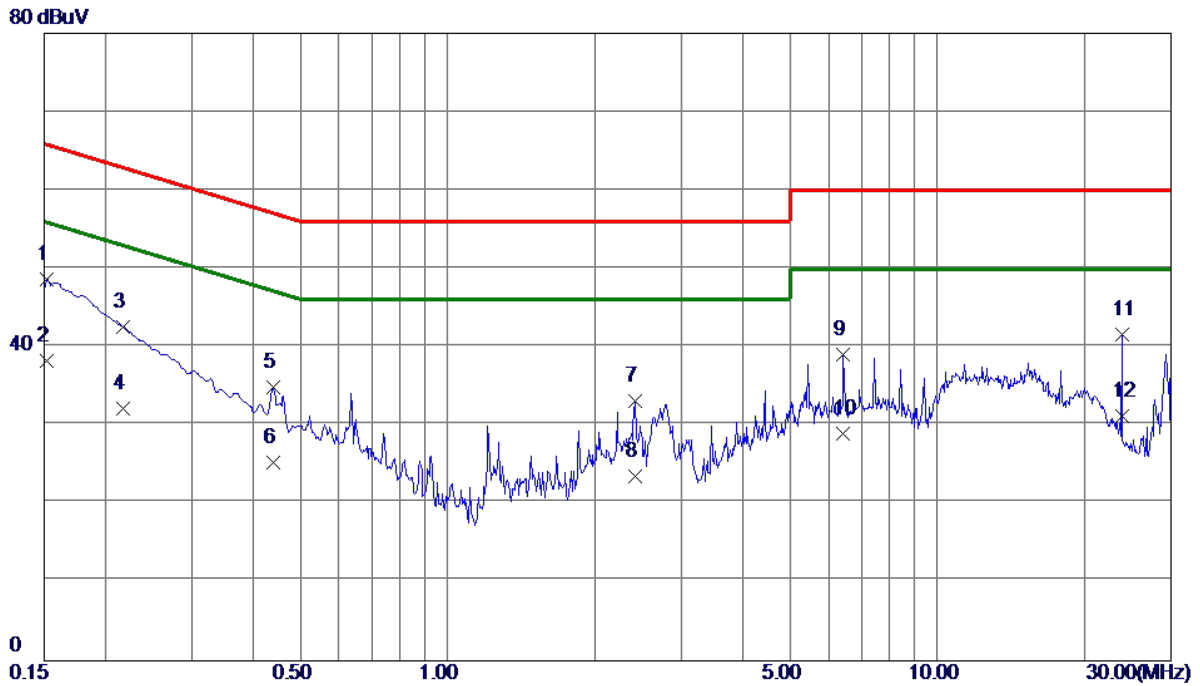

No.	Freq. MHz	Reading Level dBuV	Correct Factor dB	Measure ment dBuV	Limit dBuV	Margin dB	Detector
1 *	0.1522	38.99	9.67	48.66	65.88	-17.22	QP
2	0.1522	28.60	9.67	38.27	55.88	-17.61	AVG
3	0.2175	32.90	9.69	42.59	62.91	-20.32	QP
4	0.2175	22.40	9.69	32.09	52.91	-20.82	AVG
5	0.4402	25.12	9.72	34.84	57.06	-22.22	QP
6	0.4402	15.60	9.72	25.32	47.06	-21.74	AVG
7	2.4157	23.22	9.87	33.09	56.00	-22.91	QP
8	2.4157	13.60	9.87	23.47	46.00	-22.53	AVG
9	6.4274	28.91	10.12	39.03	60.00	-20.97	QP
10	6.4274	18.80	10.12	28.92	50.00	-21.08	AVG
11	23.8110	30.83	10.84	41.67	60.00	-18.33	QP
12	23.8110	20.40	10.84	31.24	50.00	-18.76	AVG

EUT	LCD Monitor	Model Name	X24P1
Temperature	25°C	Relative Humidity	53%
Test Voltage	AC 230V/50Hz	Phase	Neutral
Test Mode	HDMI 1920*1080/60Hz		
Note	Cable:1.5m		
Test Engineer	Jason Yang		

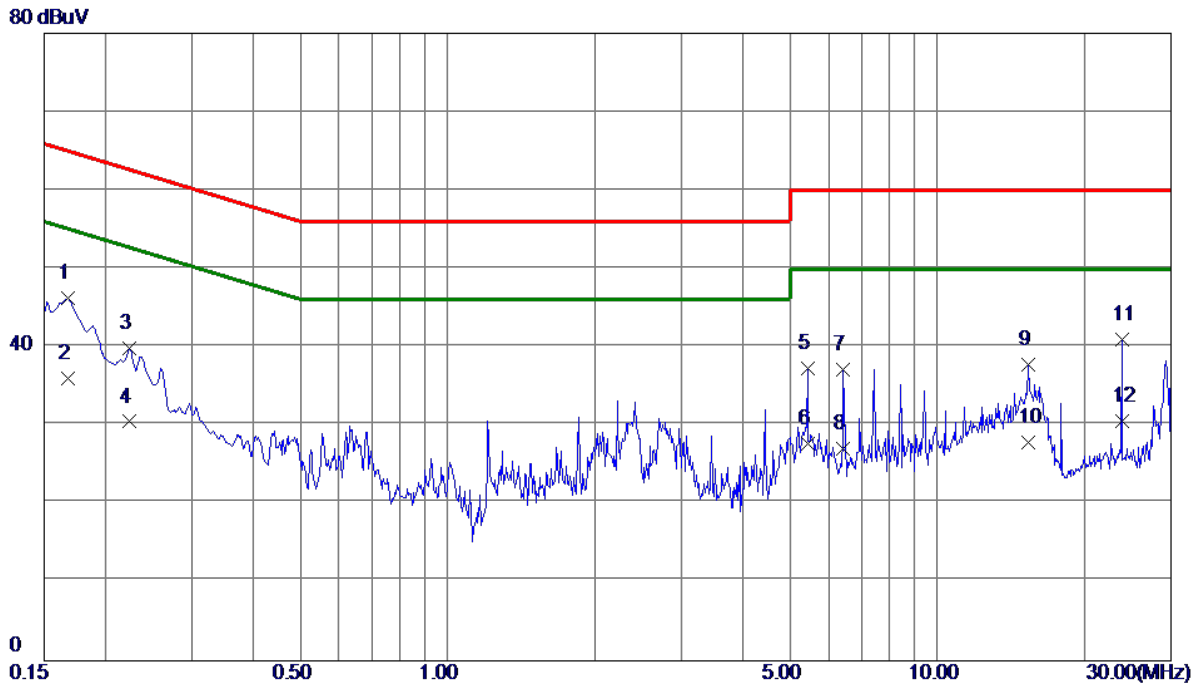

No.	Freq. MHz	Reading Level dBuV	Correct Factor dB	Measure ment dBuV	Limit dBuV	Margin dB	Detector
1 *	0.1680	36.51	9.66	46.17	65.06	-18.89	QP
2	0.1680	26.40	9.66	36.06	55.06	-19.00	AVG
3	0.2242	30.22	9.68	39.90	62.66	-22.76	QP
4	0.2242	20.80	9.68	30.48	52.66	-22.18	AVG
5	5.4375	27.24	10.05	37.29	60.00	-22.71	QP
6	5.4375	17.60	10.05	27.65	50.00	-22.35	AVG
7	6.4252	26.97	10.13	37.10	60.00	-22.90	QP
8	6.4252	16.90	10.13	27.03	50.00	-22.97	AVG
9	15.3240	27.13	10.58	37.71	60.00	-22.29	QP
10	15.3240	17.20	10.58	27.78	50.00	-22.22	AVG
11	23.8110	29.90	11.03	40.93	60.00	-19.07	QP
12	23.8110	19.50	11.03	30.53	50.00	-19.47	AVG

EUT	LCD Monitor	Model Name	X24P1
Temperature	25°C	Relative Humidity	53%
Test Voltage	AC 230V/50Hz	Phase	Line
Test Mode	HDMI 1920*1080/60Hz		
Note	Cable:1.2m		
Test Engineer	Jason Yang		

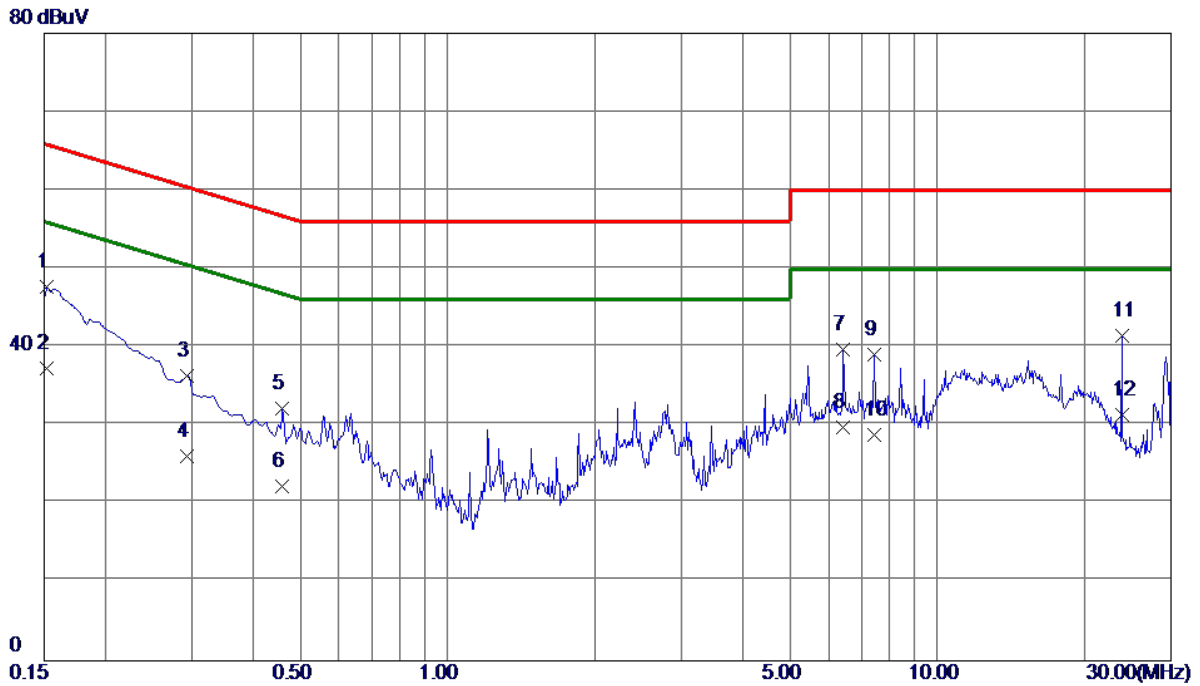

No.	Freq. MHz	Reading Level dBuV	Correct Factor dB	Measure ment dBuV	Limit dBuV	Margin dB	Detector
1 *	0.1522	37.94	9.67	47.61	65.88	-18.27	QP
2	0.1522	27.60	9.67	37.27	55.88	-18.61	AVG
3	0.2940	26.64	9.69	36.33	60.41	-24.08	QP
4	0.2940	16.40	9.69	26.09	50.41	-24.32	AVG
5	0.4604	22.40	9.73	32.13	56.69	-24.56	QP
6	0.4604	12.50	9.73	22.23	46.69	-24.46	AVG
7	6.4274	29.62	10.12	39.74	60.00	-20.26	QP
8	6.4274	19.60	10.12	29.72	50.00	-20.28	AVG
9	7.4152	28.92	10.18	39.10	60.00	-20.90	QP
10	7.4152	18.60	10.18	28.78	50.00	-21.22	AVG
11	23.8110	30.54	10.84	41.38	60.00	-18.62	QP
12	23.8110	20.50	10.84	31.34	50.00	-18.66	AVG

EUT	LCD Monitor	Model Name	X24P1
Temperature	25°C	Relative Humidity	53%
Test Voltage	AC 230V/50Hz	Phase	Neutral
Test Mode	HDMI 1920*1080/60Hz		
Note	Cable:1.2m		
Test Engineer	Jason Yang		

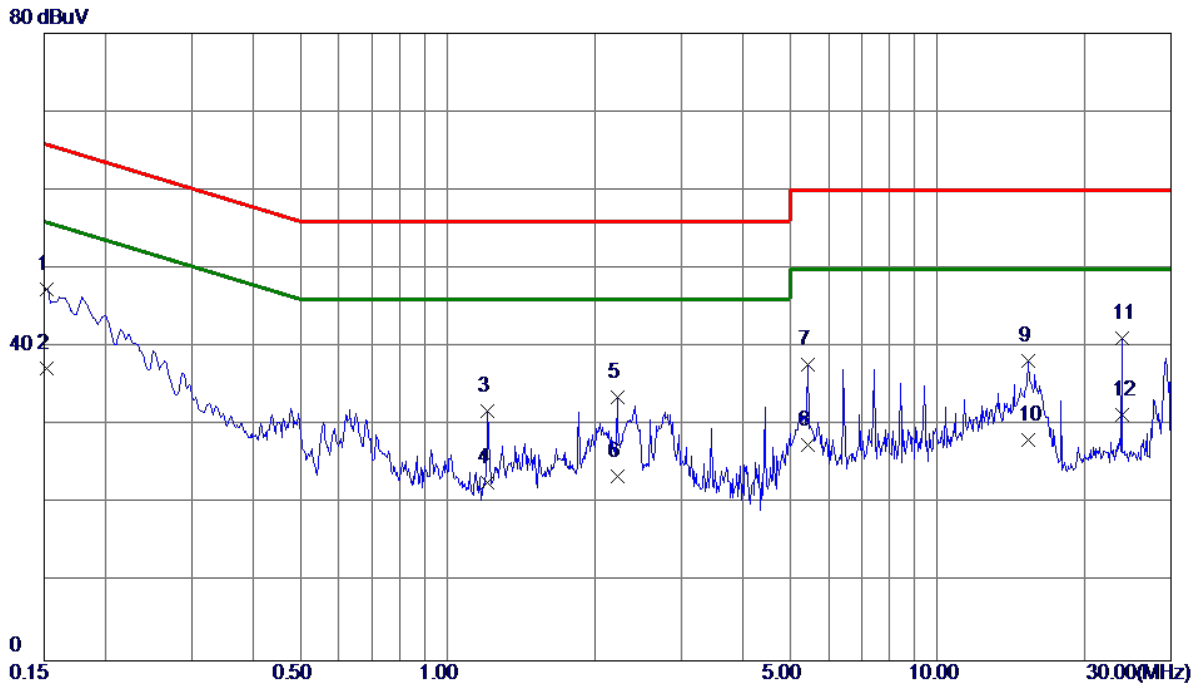

No.	Freq. MHz	Reading Level dBuV	Correct Factor dB	Measure ment dBuV	Limit dBuV	Margin dB	Detector
1 *	0.1522	37.77	9.66	47.43	65.88	-18.45	QP
2	0.1522	27.60	9.66	37.26	55.88	-18.62	AVG
3	1.2074	22.03	9.79	31.82	56.00	-24.18	QP
4	1.2074	12.90	9.79	22.69	46.00	-23.31	AVG
5	2.2222	23.75	9.86	33.61	56.00	-22.39	QP
6	2.2222	13.60	9.86	23.46	46.00	-22.54	AVG
7	5.4352	27.76	10.05	37.81	60.00	-22.19	QP
8	5.4352	17.50	10.05	27.55	50.00	-22.45	AVG
9	15.3217	27.60	10.58	38.18	60.00	-21.82	QP
10	15.3217	17.60	10.58	28.18	50.00	-21.82	AVG
11	23.8110	30.10	11.03	41.13	60.00	-18.87	QP
12	23.8110	20.40	11.03	31.43	50.00	-18.57	AVG

EUT	LCD Monitor	Model Name	X24P1
Temperature	25°C	Relative Humidity	53%
Test Voltage	AC 110V/60Hz	Phase	Line
Test Mode	HDMI 1920*1080/60Hz		
Note	Cable:1.8m		
Test Engineer	Jason Yang		

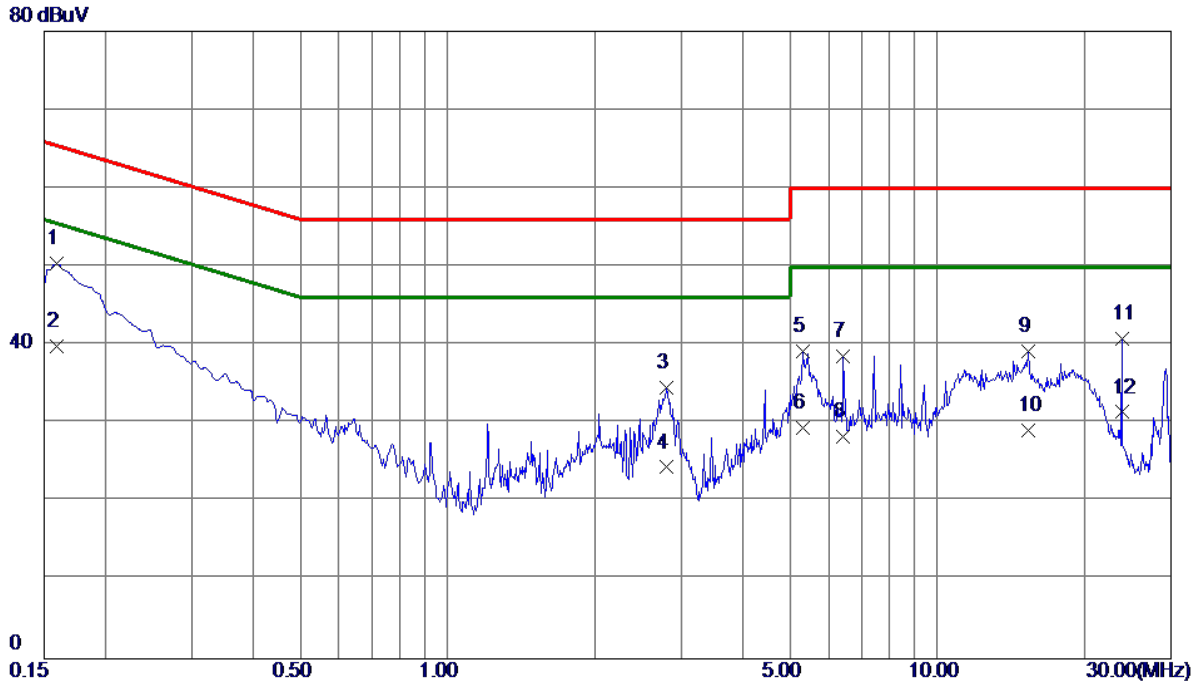

No.	Freq. MHz	Reading Level dBuV	Correct Factor dB	Measure ment dBuV	Limit dBuV	Margin dB	Detector
1 *	0.1590	40.68	9.68	50.36	65.52	-15.16	QP
2	0.1590	30.16	9.68	39.84	55.52	-15.68	AVG
3	2.7960	24.67	9.89	34.56	56.00	-21.44	QP
4	2.7960	14.51	9.89	24.40	46.00	-21.60	AVG
5	5.3137	29.11	10.06	39.17	60.00	-20.83	QP
6	5.3137	19.40	10.06	29.46	50.00	-20.54	AVG
7	6.4252	28.50	10.12	38.62	60.00	-21.38	QP
8	6.4252	18.20	10.12	28.32	50.00	-21.68	AVG
9	15.3217	28.79	10.47	39.26	60.00	-20.74	QP
10	15.3217	18.61	10.47	29.08	50.00	-20.92	AVG
11	23.8110	30.00	10.84	40.84	60.00	-19.16	QP
12	23.8110	20.60	10.84	31.44	50.00	-18.56	AVG

EUT	LCD Monitor	Model Name	X24P1
Temperature	25°C	Relative Humidity	53%
Test Voltage	AC 110V/60Hz	Phase	Neutral
Test Mode	HDMI 1920*1080/60Hz		
Note	Cable:1.8m		
Test Engineer	Jason Yang		

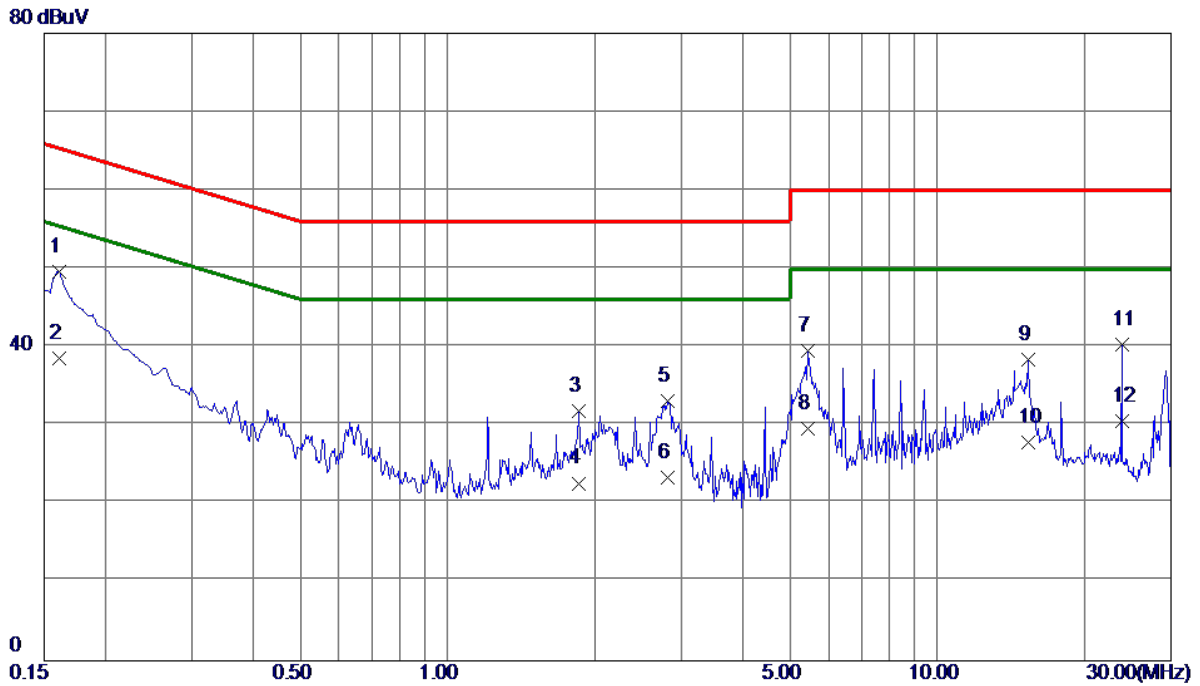

No.	Freq. MHz	Reading Level dBuV	Correct Factor dB	Measure ment dBuV	Limit dBuV	Margin dB	Detector
1 *	0.1612	40.00	9.66	49.66	65.40	-15.74	QP
2	0.1612	28.90	9.66	38.56	55.40	-16.84	AVG
3	1.8510	22.05	9.84	31.89	56.00	-24.11	QP
4	1.8510	12.80	9.84	22.64	46.00	-23.36	AVG
5	2.8162	23.16	9.89	33.05	56.00	-22.95	QP
6	2.8162	13.50	9.89	23.39	46.00	-22.61	AVG
7	5.4352	29.52	10.05	39.57	60.00	-20.43	QP
8	5.4352	19.50	10.05	29.55	50.00	-20.45	AVG
9	15.3217	27.83	10.58	38.41	60.00	-21.59	QP
10	15.3217	17.20	10.58	27.78	50.00	-22.22	AVG
11	23.8110	29.26	11.03	40.29	60.00	-19.71	QP
12	23.8110	19.60	11.03	30.63	50.00	-19.37	AVG

EUT	LCD Monitor	Model Name	X24P1
Temperature	25°C	Relative Humidity	53%
Test Voltage	AC 230V/50Hz	Phase	Line
Test Mode	HDMI 1080P		
Note	Cable:1.8m		
Test Engineer	Jason Yang		

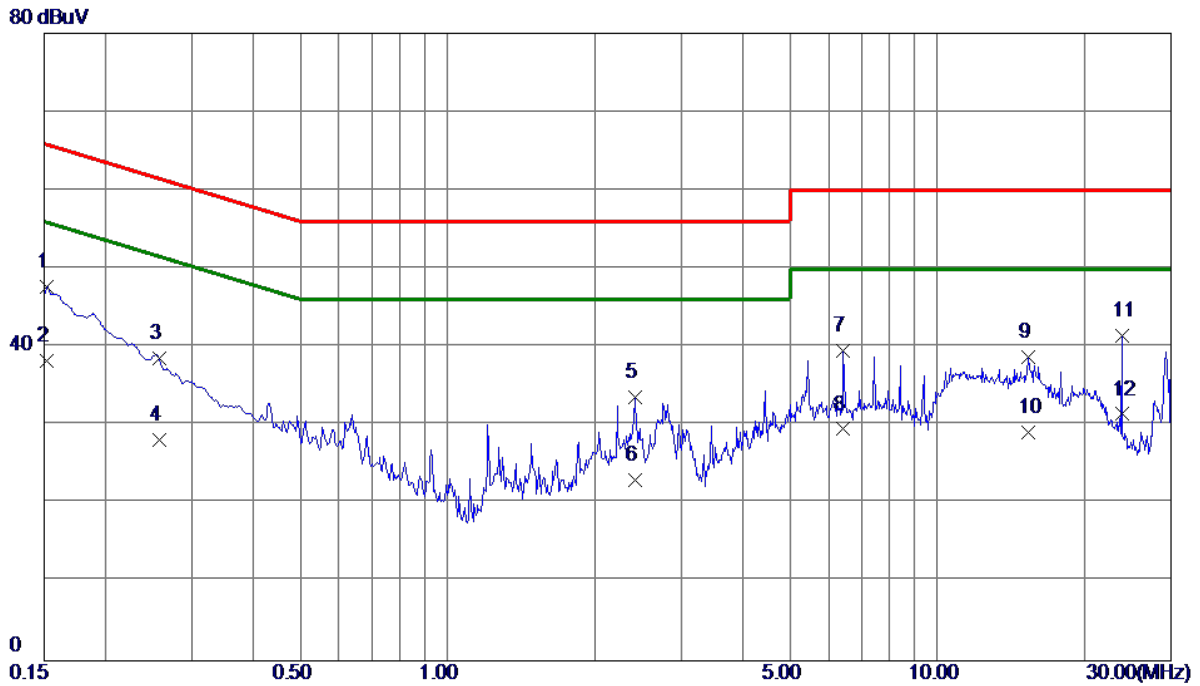

No.	Freq. MHz	Reading Level dBuV	Correct Factor dB	Measure ment dBuV	Limit dBuV	Margin dB	Detector
1	0.1522	38.06	9.67	47.73	65.88	-18.15	QP
2 *	0.1522	28.60	9.67	38.27	55.88	-17.61	AVG
3	0.2580	28.83	9.69	38.52	61.50	-22.98	QP
4	0.2580	18.40	9.69	28.09	51.50	-23.41	AVG
5	2.4157	23.74	9.87	33.61	56.00	-22.39	QP
6	2.4157	13.20	9.87	23.07	46.00	-22.93	AVG
7	6.4274	29.42	10.12	39.54	60.00	-20.46	QP
8	6.4274	19.40	10.12	29.52	50.00	-20.48	AVG
9	15.3217	28.24	10.47	38.71	60.00	-21.29	QP
10	15.3217	18.61	10.47	29.08	50.00	-20.92	AVG
11	23.8110	30.65	10.84	41.49	60.00	-18.51	QP
12	23.8110	20.60	10.84	31.44	50.00	-18.56	AVG

EUT	LCD Monitor	Model Name	X24P1
Temperature	25°C	Relative Humidity	53%
Test Voltage	AC 230V/50Hz	Phase	Neutral
Test Mode	HDMI 1080P		
Note	Cable:1.8m		
Test Engineer	Jason Yang		

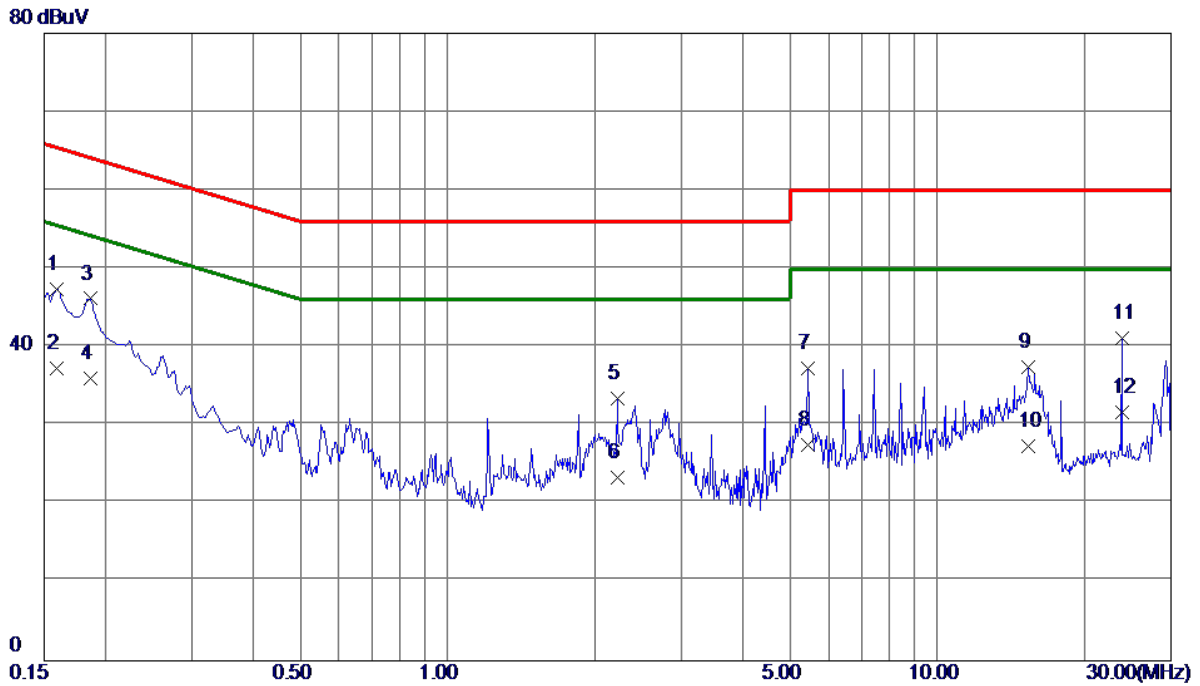

No.	Freq. MHz	Reading Level dBuV	Correct Factor dB	Measure ment dBuV	Limit dBuV	Margin dB	Detector
1	0.1590	37.77	9.66	47.43	65.52	-18.09	QP
2	0.1590	27.60	9.66	37.26	55.52	-18.26	AVG
3 *	0.1860	36.49	9.67	46.16	64.21	-18.05	QP
4	0.1860	26.40	9.67	36.07	54.21	-18.14	AVG
5	2.2222	23.65	9.86	33.51	56.00	-22.49	QP
6	2.2222	13.50	9.86	23.36	46.00	-22.64	AVG
7	5.4375	27.24	10.05	37.29	60.00	-22.71	QP
8	5.4375	17.50	10.05	27.55	50.00	-22.45	AVG
9	15.3240	26.86	10.58	37.44	60.00	-22.56	QP
10	15.3240	16.80	10.58	27.38	50.00	-22.62	AVG
11	23.8110	30.06	11.03	41.09	60.00	-18.91	QP
12	23.8110	20.60	11.03	31.63	50.00	-18.37	AVG

5. EMC EMISSION TEST- EN 55032:2015+AC:2016

5.1 RADIATED EMISSION

5.1.1 LIMITS

Class A equipment up to 1000MHz

Table clause	Frequency range MHz	Measurement			Class A limits dB(μ V/m)
		Facility (see Table A.1)	Distance m	Detector type/ bandwidth	
A2.1	30-230	OATS/SAC	10	Quasi peak / 120 kHz	40
	230-1000				47
A2.2	30-230	OATS/SAC	3		50
	230-1000				57
A2.3	30-230	FAR	10	Quasi peak / 120 kHz	42 to 35
	230-1000				42
A2.4	30-230	FAR	3		52 to 45
	230-1000				52

Apply only A2.1 or A2.2 or A2.3 or A2.4 across the entire frequency range.

Class A equipment above 1000MHz

Table clause	Frequency range MHz	Measurement			Class A limits dB(μ V/m)
		Facility (see Table A.1)	Distance m	Detector type/ bandwidth	
A3.1	1000-3000	FSOATS	3	Average / 1 MHz	56
	3000-6000				60
A3.2	1000-3000			Peak / 1 MHz	76
	3000-6000				80

Apply A3.1 and A3.2 across the frequency range from 1 000 MHz to the highest required frequency of measurement derived from Table 1.

Class B equipment up to 1000MHz

Table clause	Frequency range MHz	Measurement			Class B limits dB(μV/m)
		Facility (see Table A.1)	Distance m	Detector type/ bandwidth	
A4.1	30-230	OATS/SAC	10	Quasi peak / 120 kHz	30
	230-1000				37
A4.2	30-230	OATS/SAC	3		40
	230-1000				47
A4.3	30-230	FAR	10	32 to 25	
	230-1000			32	
A4.4	30-230	FAR	3	42 to 35	
	230-1000			42	

Apply only table clause A4.1 or A4.2 or A4.3 or A4.4 across the entire frequency range. These requirements are not applicable to the local oscillator and harmonics frequencies of equipment covered by Table A.6.

Class B equipment above 1000MHz

Table clause	Frequency range MHz	Measurement			Class B limits dB(μV/m)
		Facility (see Table A.1)	Distance m	Detector type/ bandwidth	
A5.1	1000-3000	FSOATS	3	Average / 1 MHz	50
	3000-6000				54
A5.2	1000-3000			Peak / 1 MHz	70
	3000-6000				74

Apply A5.1 and A5.2 across the frequency range from 1 000 MHz to the highest required frequency of measurement derived from Table 1.

Notes:

- (1) The limit for radiated test was performed according to as following: EN 55032
- (2) The tighter limit applies at the band edges.
- (3) Emission level (dBuV/m)=20log Emission level (uV/m).
- (4) The test result calculated as following:
 Measurement Value = Reading Level + Correct Factor
 Correct Factor = Antenna Factor + Cable Loss - Amplifier Gain(if use)
 Margin Level = Measurement Value - Limit Value

Required highest frequency for radiated measurement

Highest internal frequency (F_x) MHz	Highest measured frequency MHz
$F_x \leq 108$	1000
$108 < F_x \leq 500$	2000
$500 < F_x \leq 1000$	5000
$F_x > 1000$	5 th up to a maximum 6 GHz,

Note for FM and TV broadcast receiver, F_x is determined from the highest frequency generated or used excluding the local oscillator and tuned frequencies.

5.1.2 MEASUREMENT INSTRUMENTS LIST

Item	Kind of Equipment	Manufacturer	Type No.	Serial No.	Calibrated until
1	Pre-Amplifier	Mini-Circuits	EMC 9135	980284	Mar. 26, 2018
2	Pre-Amplifier	Mini-Circuits	EMC 9135	980283	Mar. 26, 2018
3	Trilog-Broadband Antenna	Schwarzbeck	VULB9168	586	Mar. 26, 2018
4	Trilog-Broadband Antenna	Schwarzbeck	VULB9168	587	Mar. 26, 2018
5	Cable	emci	LMR-400(5m +11m+15m)	N/A	Nov. 03, 2018
6	Cable	emci	LMR-400(5m +8m+15m)	N/A	Nov. 03, 2018
7	Measurement Software	Farad	EZ-EMC Ver.BTL-2AN T-1	N/A	N/A
8	Multi-Device Controller	ETS-Lindgren	2090	N/A	N/A
9	Attenuator	N/A	SA18N-06	6dB	Apr. 14, 2018
10	Attenuator	N/A	SA18N-06	6dB	Apr. 14, 2018
11	Receiver	Keysight	N9038A	MY54450004	Aug. 15, 2018
12	MXE EMI Receiver	Agilent	N9038A	MY53220133	Jun. 20, 2018

Remark: "N/A" denotes no model name, no serial no. or no calibration specified.

All calibration period of equipment list is one year.

Above 1GHz:

Item	Kind of Equipment	Manufacturer	Type No.	Serial No.	Calibrated until
1	Measurement Software	Farad	EZ-EMC Ver.BTL-2A NT-1	N/A	N/A
2	Cable	emci	SUCOFLE X_15m_5m (0.01GHz – 26.5GHz)	N/A	Nov. 03, 2018
3	Multi-Device Controller	ETS-Lindgren	2090	N/A	N/A
4	Controller	MF	MF-7802	MF780208159	N/A
5	Horn Antenna	EMCO	3115	9605-4803	Mar. 26, 2018
6	Amplifier	Agilent	8449B	3008A02584	Aug. 20, 2018
7	MXE EMI Receiver	Agilent	N9038A	MY53220133	Jun. 20, 2018

5.1.3 TEST PROCEDURE

- h. The measuring distance of 10 m shall be used for measurements. The EUT was placed on the top of a rotating table 0.8 meter above the ground at a 10 meter semi-anechoic chamber. The table was rotated 360 degrees to determine the position of the highest radiation.(below 1GHz).
- i. The measuring distance of 3 m shall be used for measurements. The EUT was placed on the top of a rotating table 0.8 meter above the ground at a 10 meter semi-anechoic chamber. The table was rotated 360 degrees to determine the position of the highest radiation.(above 1GHz)
- j. The height of the equipment or of the substitution antenna shall be 0.8 m, the height of the test antenna shall vary between 1 m to 4 m. Both horizontal and vertical polarizations of the antenna are set to make the measurement.
- k. The initial step in collecting radiated emission data is a receiver peak detector mode pre-scanning the measurement frequency range. Significant peaks are then marked and then Quasi Peak detector mode re-measured.
- l. All readings are Peak unless otherwise stated QP in column of Note. Peak denotes that the Peak reading compliance with the QP Limits and then QP Mode measurement didn't perform. (below 1GHz)
- m. All readings are Peak Mode value unless otherwise stated AVG in column of Note. If the Peak Mode Measured value compliance with the Peak Limits and lower than AVG Limits, the EUT shall be deemed to meet both Peak & AVG Limits and then only Peak Mode was measured, but AVG Mode didn't perform. (above 1GHz)
- n. For the actual test configuration, please refer to the related Item - Block Diagram of system tested (please refer to 3.3).

5.1.4 DEVIATION FROM TEST STANDARD

No deviation

5.1.5 TEST SETUP

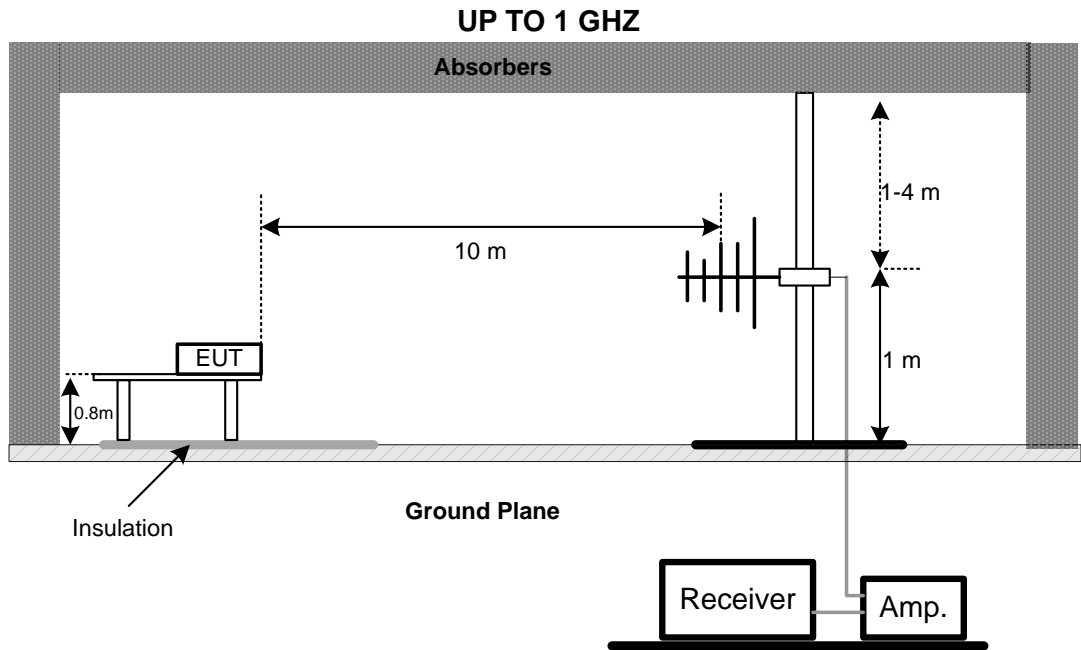

Note: The antenna can be moved between 1 to 4 meters above the ground.

ABOVE 1 GHZ

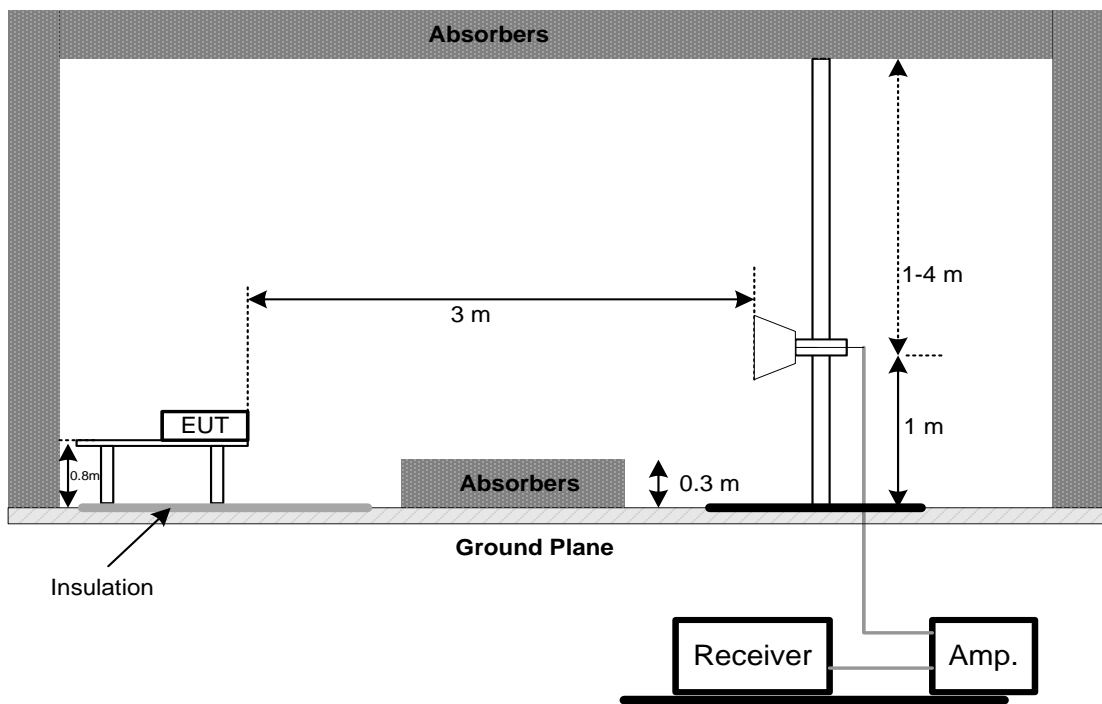

5.1.6 MEASUREMENT DISTANCE

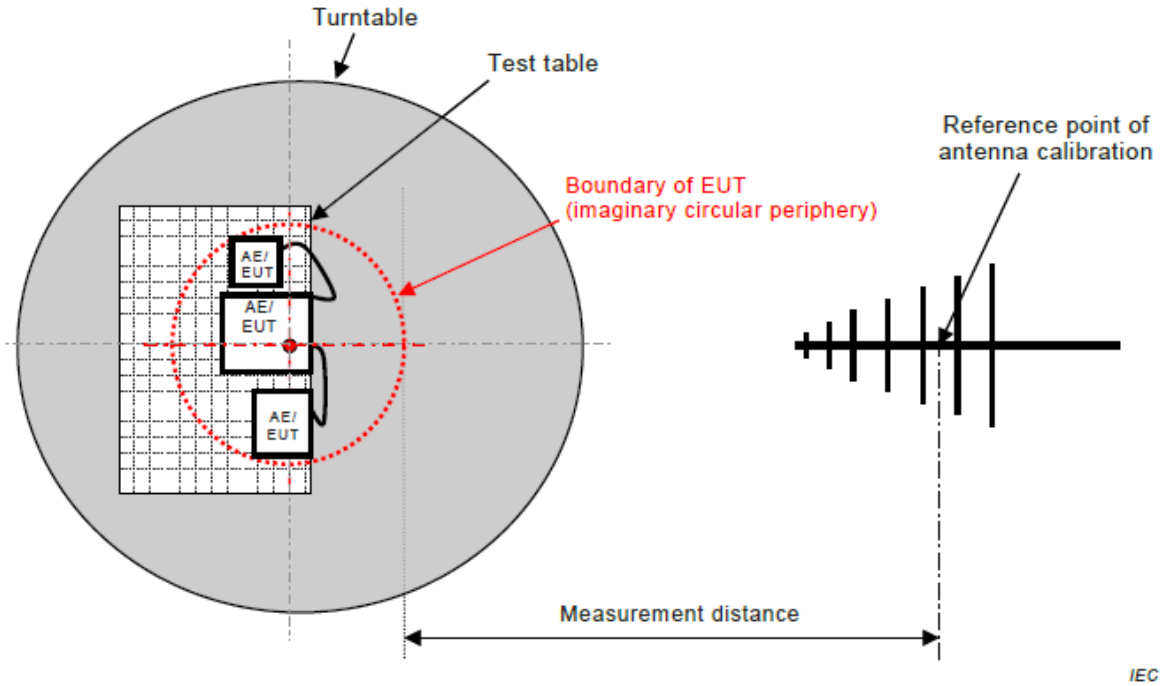

Figure C.1 – Measurement distance

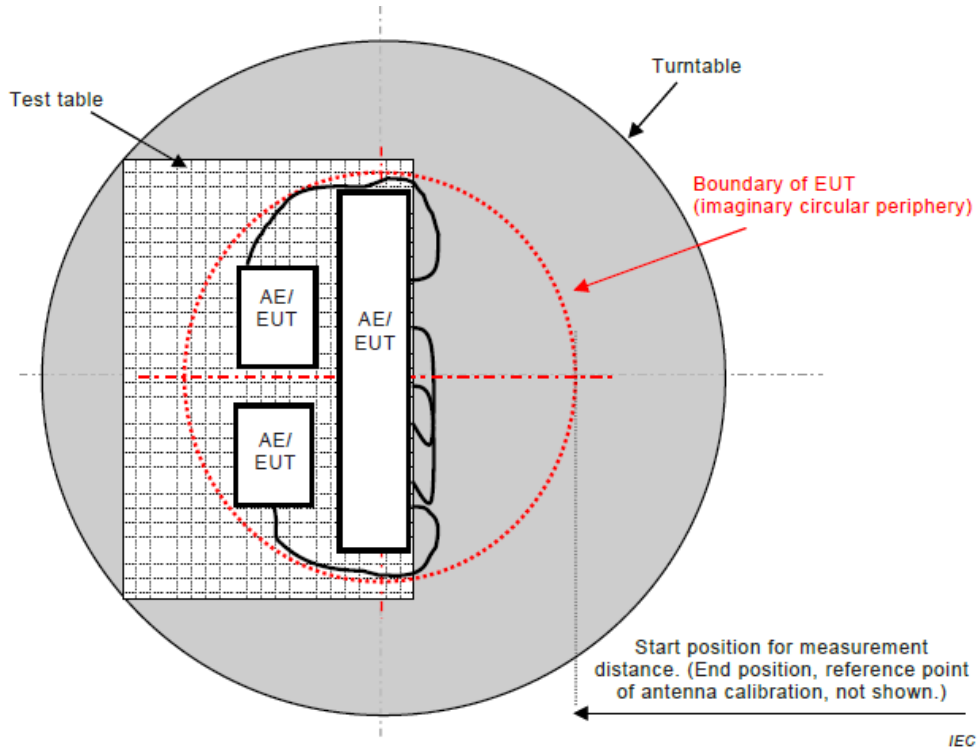
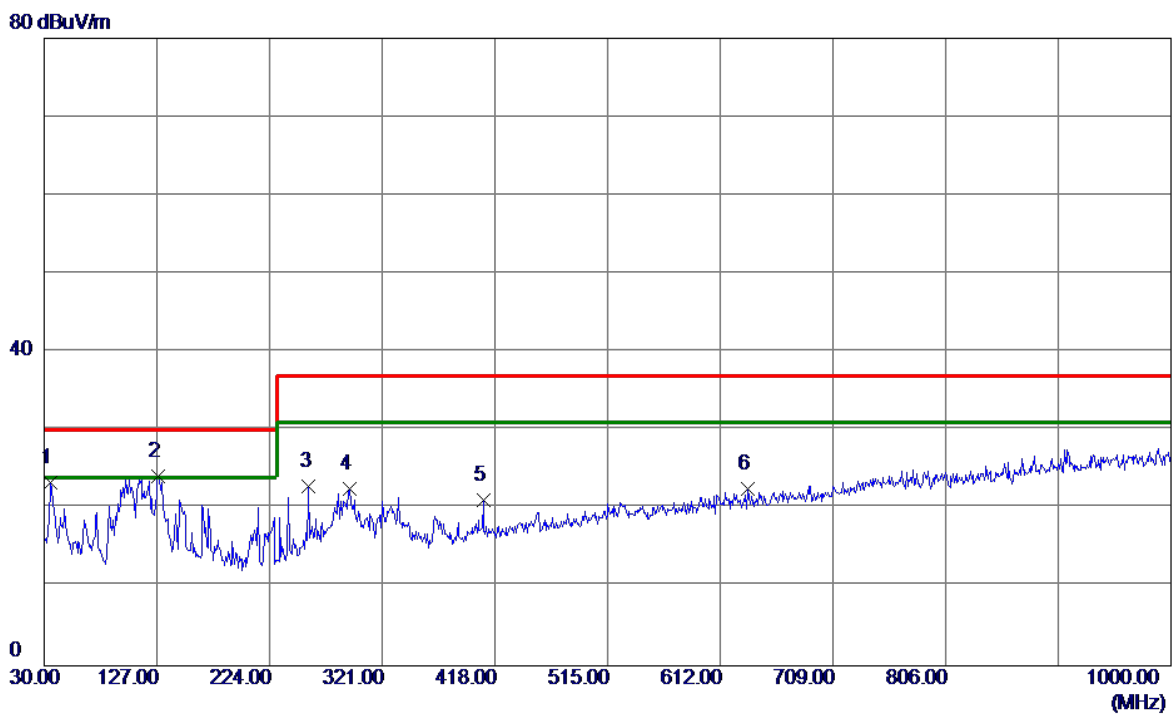

Figure C.2 – Boundary of EUT, Local AE and associated cabling

5.1.7 TEST RESULTS (UP TO 1 GHZ)

EUT	LCD Monitor	Model Name	X24P1
Temperature	25°C	Relative Humidity	60%
Test Voltage	AC 230V/50Hz	Polarization	Vertical
Test Mode	HDMI 1920*1080/60Hz		
Note	Cable:1.8m		
Test Engineer	Jason Yang		
Panel(Brand/Model)	H		



No.	Freq. MHz	Reading Level dBuV/m	Correct Factor dB	Measure ment dBuV/m	Limit dBuV/m	Margin dB	Detector
1	35.8200	47.26	-23.95	23.31	30.00	-6.69	QP
2 *	128.4550	47.79	-23.59	24.20	30.00	-5.80	QP
3	257.9500	45.55	-22.71	22.84	37.00	-14.16	QP
4	292.8700	43.90	-21.39	22.51	37.00	-14.49	QP
5	407.8150	39.88	-18.71	21.17	37.00	-15.83	QP
6	635.2800	36.92	-14.37	22.55	37.00	-14.45	QP

EUT	LCD Monitor	Model Name	X24P1
Temperature	25°C	Relative Humidity	60%
Test Voltage	AC 230V/50Hz	Polarization	Horizontal
Test Mode	HDMI 1920*1080/60Hz		
Note	Cable:1.8m		
Test Engineer	Jason Yang		
Panel(Brand/Model)	H		

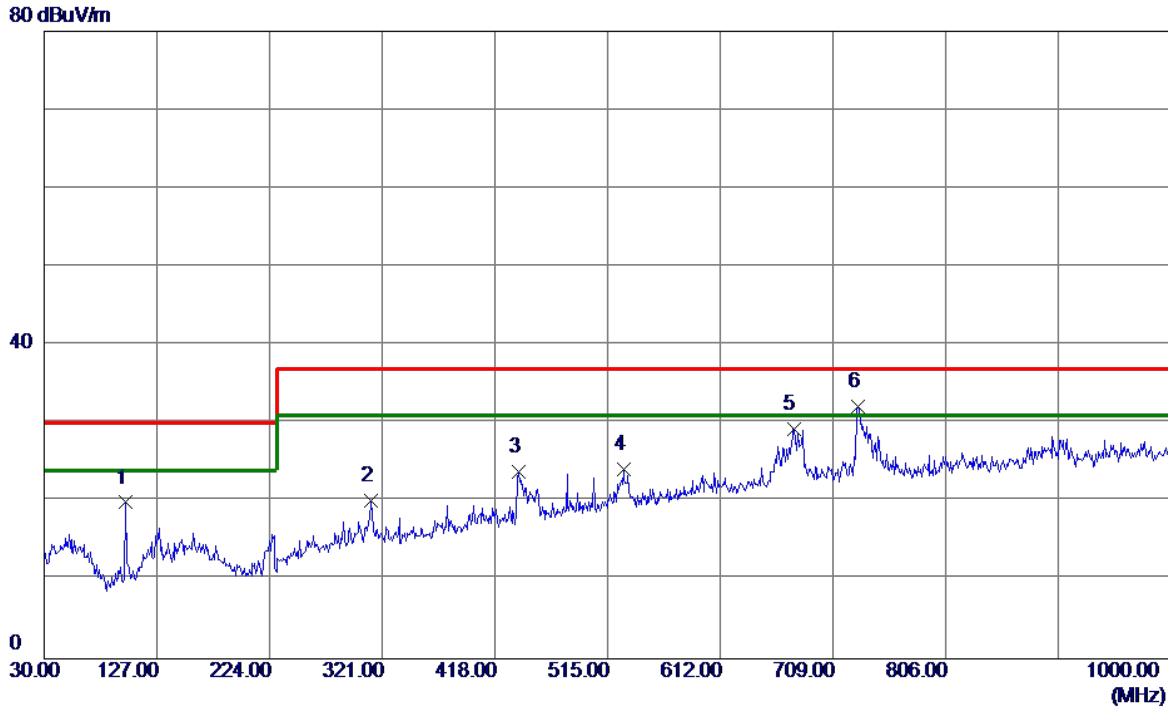

No.	Freq. MHz	Reading Level dBuV/m	Correct Factor dB	Measure ment dBuV/m	Limit dBuV/m	Margin dB	Detector
1	99.8399	40.84	-20.92	19.92	30.00	-10.08	QP
2	311.3000	34.90	-14.76	20.14	37.00	-16.86	QP
3	438.3700	35.41	-11.61	23.80	37.00	-13.20	QP
4	529.0650	34.28	-10.16	24.12	37.00	-12.88	QP
5	675.0500	36.69	-7.35	29.34	37.00	-7.66	QP
6 *	730.3400	38.60	-6.45	32.15	37.00	-4.85	QP

5.1.8 TEST RESULTS (ABOVE 1 GHZ)

EUT	LCD Monitor	Model Name	X24P1
Temperature	25°C	Relative Humidity	60%
Test Voltage	AC 230V/50Hz	Polarization	Vertical
Test Mode	HDMI 1920*1080/60Hz		
Note	Cable:1.8m		
Test Engineer	Jason Yang		
Panel(Brand/Model)	H		

100 dBuV/m

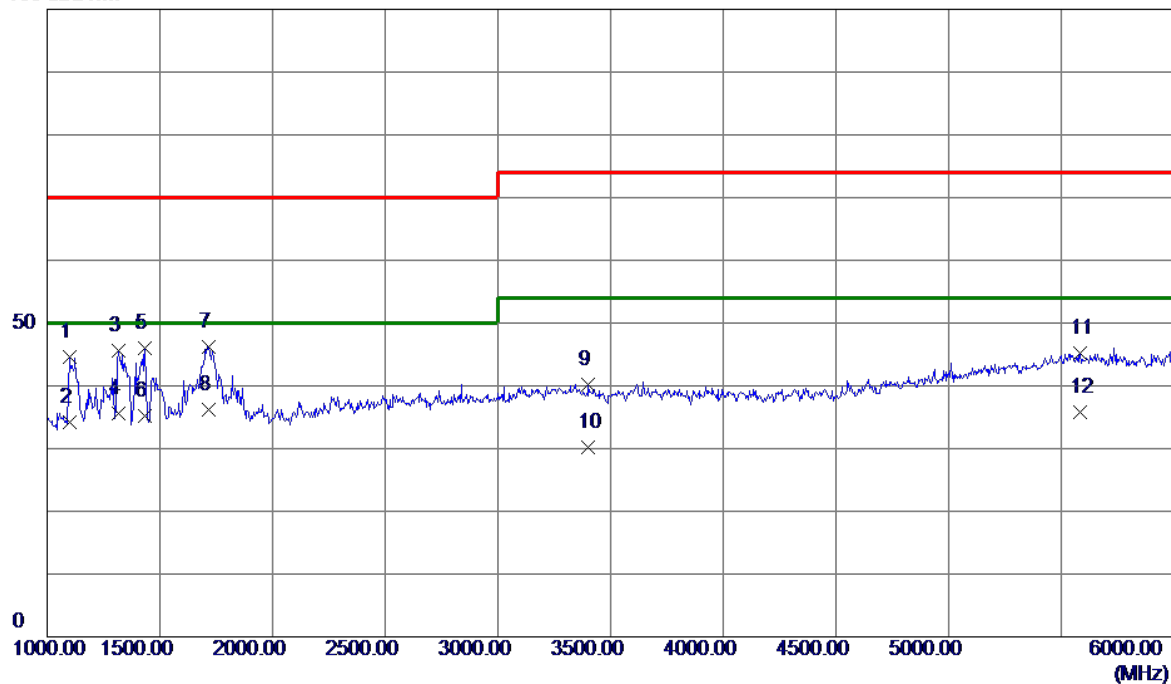

No.	Freq. MHz	Reading Level dBuV/m	Correct Factor dB	Measure ment dBuV/m	Limit dBuV/m	Margin dB	Detector
1	1097.5000	49.45	-4.82	44.63	70.00	-25.37	Peak
2	1097.5000	39.00	-4.82	34.18	50.00	-15.82	AVG
3	1315.0000	49.26	-3.63	45.63	70.00	-24.37	Peak
4	1315.0000	39.32	-3.63	35.69	50.00	-14.31	AVG
5	1435.0000	48.94	-2.98	45.96	70.00	-24.04	Peak
6	1435.0000	38.15	-2.98	35.17	50.00	-14.83	AVG
7	1715.0000	48.34	-2.17	46.17	70.00	-23.83	Peak
8 *	1715.0000	38.46	-2.17	36.29	50.00	-13.71	AVG
9	3402.5000	34.88	5.34	40.22	74.00	-33.78	Peak
10	3402.5000	24.80	5.34	30.14	54.00	-23.86	AVG
11	5585.0000	31.33	13.83	45.16	74.00	-28.84	Peak
12	5585.0000	22.04	13.83	35.87	54.00	-18.13	AVG

EUT	LCD Monitor	Model Name	X24P1
Temperature	25°C	Relative Humidity	60%
Test Voltage	AC 230V/50Hz	Polarization	Horizontal
Test Mode	HDMI 1920*1080/60Hz		
Note	Cable:1.8m		
Test Engineer	Jason Yang		
Panel(Brand/Model)	H		

100 dBuV/m

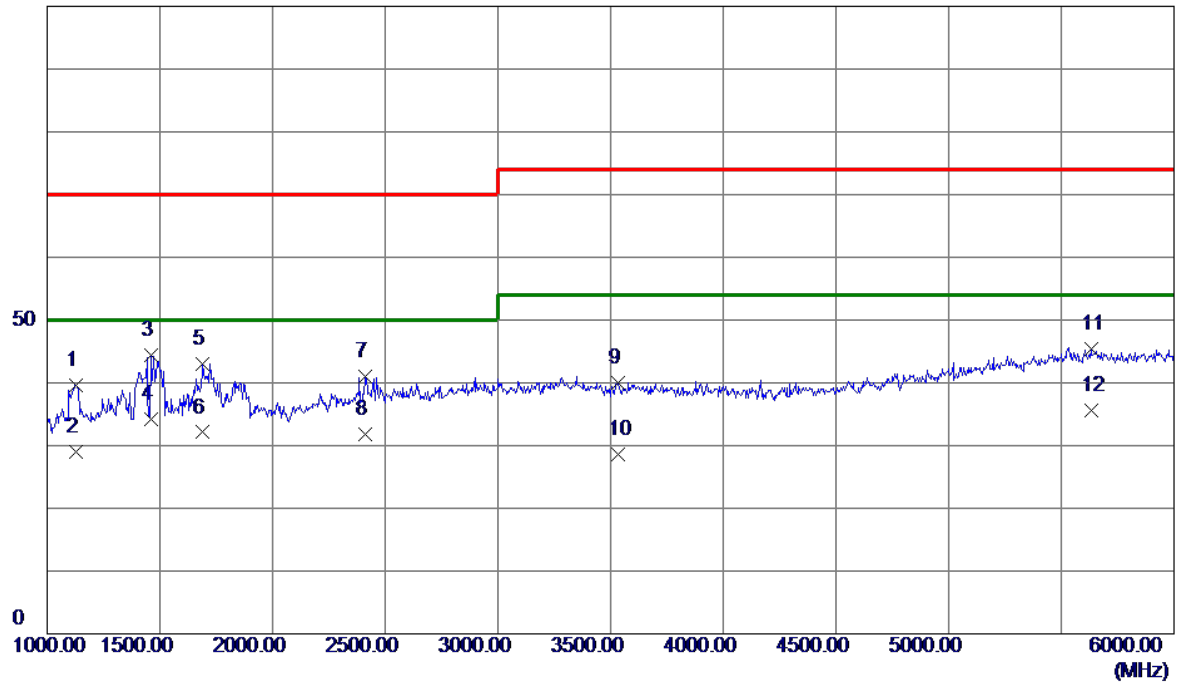

No.	Freq. MHz	Reading Level dBuV/m	Correct Factor dB	Measure ment dBuV/m	Limit dBuV/m	Margin dB	Detector
1	1130.0000	44.25	-4.64	39.61	70.00	-30.39	Peak
2	1130.0000	33.58	-4.64	28.94	50.00	-21.06	AVG
3	1460.0000	47.26	-2.84	44.42	70.00	-25.58	Peak
4 *	1460.0000	37.09	-2.84	34.25	50.00	-15.75	AVG
5	1690.0000	45.17	-2.22	42.95	70.00	-27.05	Peak
6	1690.0000	34.32	-2.22	32.10	50.00	-17.90	AVG
7	2412.5000	39.68	1.34	41.02	70.00	-28.98	Peak
8	2412.5000	30.44	1.34	31.78	50.00	-18.22	AVG
9	3535.0000	34.31	5.61	39.92	74.00	-34.08	Peak
10	3535.0000	22.97	5.61	28.58	54.00	-25.42	AVG
11	5632.5000	31.59	13.82	45.41	74.00	-28.59	Peak
12	5632.5000	21.84	13.82	35.66	54.00	-18.34	AVG

5.2 CONDUCTED EMISSION MEASUREMENT AT AC MAINS POWER PORTS

5.2.1 LIMITS

Requirements for conducted emissions from AC mains power ports of Class A equipment

Table clause	Frequency Range MHz	Coupling Device	Detector Type / bandwidth	Class A Limits (dB(μV))
A9.1	0.15 - 0.5	AMN	Quasi Peak / 9 kHz	79
	0.5 - 30			73
A9.2	0.15 - 0.5	AMN	Average / 9 kHz	66
	0.5 - 30			60

Apply A9.1 and A9.2 across the entire frequency range.

Requirements for conducted emissions from AC mains power ports of Class B equipment

Table clause	Frequency Range MHz	Coupling Device	Detector Type / bandwidth	Class B Limits (dB(μV))
A10.1	0.15 - 0.5	AMN	Quasi Peak / 9 kHz	66-56
	0.5 - 5			56
	5 - 30			60
A10.2	0.15 - 0.5	AMN	Average / 9 kHz	56-46
	0.5 - 5			46
	5 - 30			50

Apply A10.1 and A10.2 across the entire frequency range.

NOTE:

(1) The test result calculated as following:

Measurement Value = Reading Level + Correct Factor

Correct Factor = Insertion Loss + Cable Loss + Attenuator Factor(if use)

Margin Level = Measurement Value – Limit Value

5.2.2 MEASUREMENT INSTRUMENTS LIST

Item	Kind of Equipment	Manufacturer	Type No.	Serial No.	Calibrated until
1	Measurement Software	Farad	EZ-EMC Ver.NB-03A 1-01	N/A	N/A
2	50Ω Terminator	SHX	TF2-3G-A	08122901	Mar. 26, 2018
3	TWO-LINE V-NETWORK	R&S	ENV216	100526	Mar. 26, 2018
4	EMI Test Receiver	R&S	ESR3	101862	Aug. 15, 2018
5	Artificial-Mains Network	SCHWARZBECK	NSLK 8127	8127685	Aug. 20, 2018
6	Cable	N/A	RG400 12m	N/A	Mar. 07, 2018

Remark: "N/A" denotes no model name, no serial no. or no calibration specified.

All calibration period of equipment list is one year.

5.2.3 TEST PROCEDURE

- a. The EUT was placed 0.8 meters from the horizontal ground plane with EUT being connected to the power mains through a line impedance stabilization network (LISN). All other support equipments powered from additional LISN(s). The LISN provide 50 Ohm/ 50uH of coupling impedance for the measuring instrument.
- b. Interconnecting cables that hang closer than 40 cm to the ground plane shall be folded back and forth in the center forming a bundle 30 to 40 cm long.
- c. I/O cables that are not connected to a peripheral shall be bundled in the center. The end of the cable may be terminated, if required, using the correct terminating impedance. The overall length shall not exceed 1 m.
- d. LISN at least 80 cm from nearest part of EUT chassis.
- e. For the actual test configuration, please refer to the related Item –EUT Test Photos.

5.2.4 DEVIATION FROM TEST STANDARD

No deviation

5.2.5 TEST SETUP

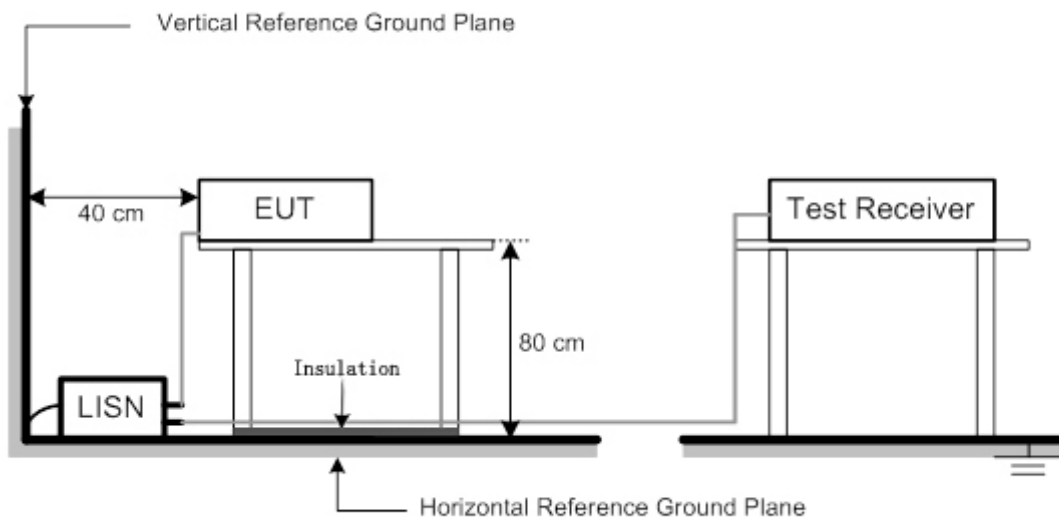

5.2.6 TEST RESULTS

EUT	LCD Monitor	Model Name	X24P1
Temperature	25°C	Relative Humidity	53%
Test Voltage	AC 230V/50Hz	Phase	Line
Test Mode	HDMI 1920*1080/60Hz		
Note	Cable:1.8m		
Test Engineer	Jason Yang		

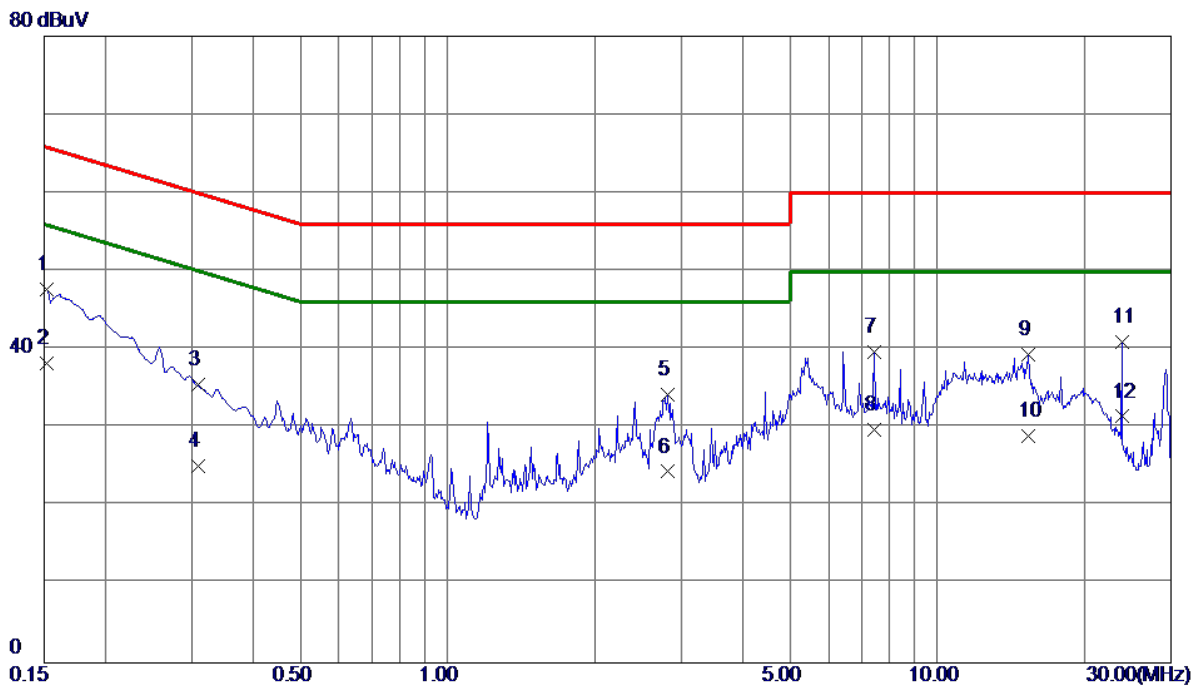

No.	Freq. MHz	Reading Level dBuV	Correct Factor dB	Measure ment dBuV	Limit dBuV	Margin dB	Detector
1	0.1522	38.02	9.67	47.69	65.88	-18.19	QP
2 *	0.1522	28.60	9.67	38.27	55.88	-17.61	AVG
3	0.3097	25.79	9.69	35.48	59.98	-24.50	QP
4	0.3097	15.40	9.69	25.09	49.98	-24.89	AVG
5	2.8140	24.32	9.89	34.21	56.00	-21.79	QP
6	2.8140	14.51	9.89	24.40	46.00	-21.60	AVG
7	7.4130	29.54	10.18	39.72	60.00	-20.28	QP
8	7.4130	19.60	10.18	29.78	50.00	-20.22	AVG
9	15.3217	28.86	10.47	39.33	60.00	-20.67	QP
10	15.3217	18.51	10.47	28.98	50.00	-21.02	AVG
11	23.8110	30.13	10.84	40.97	60.00	-19.03	QP
12	23.8110	20.60	10.84	31.44	50.00	-18.56	AVG

EUT	LCD Monitor	Model Name	X24P1
Temperature	25°C	Relative Humidity	53%
Test Voltage	AC 230V/50Hz	Phase	Neutral
Test Mode	HDMI 1920*1080/60Hz		
Note	Cable:1.8m		
Test Engineer	Jason Yang		

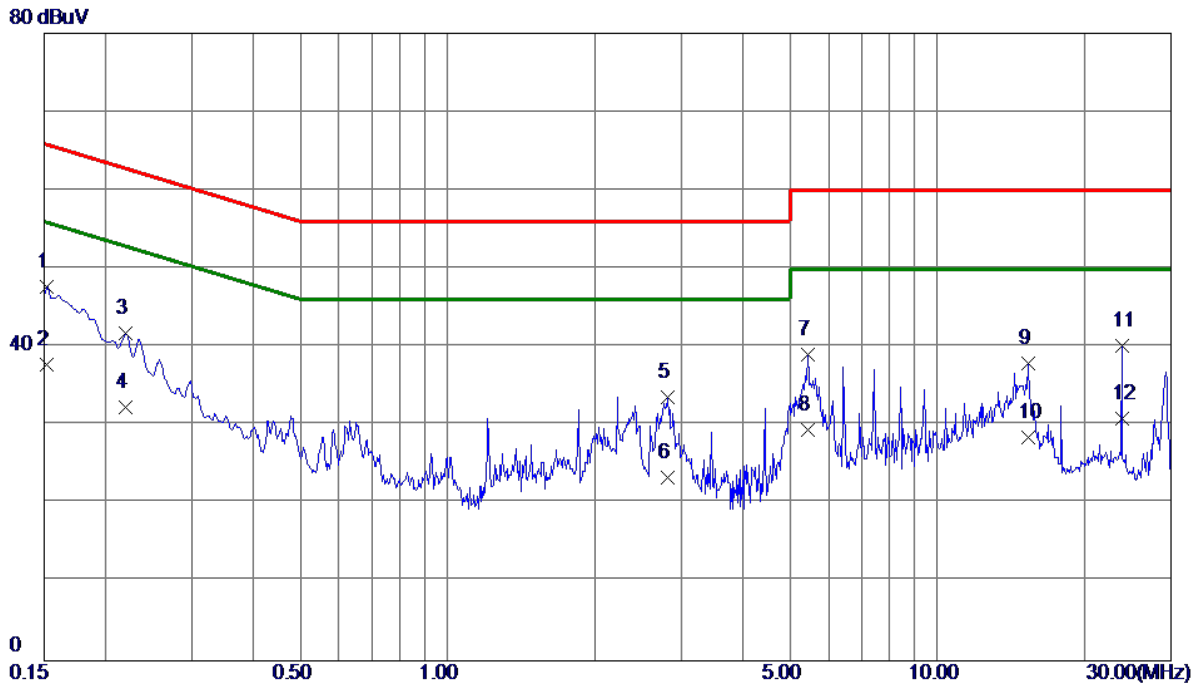

No.	Freq. MHz	Reading Level dBuV	Correct Factor dB	Measure ment dBuV	Limit dBuV	Margin dB	Detector
1	0.1522	38.06	9.66	47.72	65.88	-18.16	QP
2 *	0.1522	28.10	9.66	37.76	55.88	-18.12	AVG
3	0.2197	32.02	9.68	41.70	62.83	-21.13	QP
4	0.2197	22.60	9.68	32.28	52.83	-20.55	AVG
5	2.8140	23.69	9.89	33.58	56.00	-22.42	QP
6	2.8140	13.50	9.89	23.39	46.00	-22.61	AVG
7	5.4375	29.05	10.05	39.10	60.00	-20.90	QP
8	5.4375	19.40	10.05	29.45	50.00	-20.55	AVG
9	15.3217	27.31	10.58	37.89	60.00	-22.11	QP
10	15.3217	17.90	10.58	28.48	50.00	-21.52	AVG
11	23.8110	29.12	11.03	40.15	60.00	-19.85	QP
12	23.8110	19.80	11.03	30.83	50.00	-19.17	AVG

6. HARMONIC CURRENT EMISSIONS TEST

6.1 LIMITS

EN 61000-3-2						
Equipment Category	Harmonic Order n	Max. Permissible Harmonic Current A	Equipment Category	Harmonic Order n	Max. Permissible Harmonic Current A mA/w	
Class A	Odd Harmonics		Class D	Odd Harmonics only		
	3	2.30		3	2.30	3.4
	5	1.14		5	1.14	1.9
	7	0.77		7	0.77	1.0
	9	0.40		9	0.40	0.5
	11	0.33		11	0.33	0.35
	13	0.21		13	0.21	0.30
	15≤n≤39	0.15 x 15/n		15≤n≤39	0.15 x 15/n	3.85/n
	Even Harmonics					
	2	1.08				
	4	0.43				
	6	0.30				
	8≤n≤40	0.23 x 8/n				

6.2 MEASUREMENT INSTRUMENTS LIST

Item	Kind of Equipment	Manufacturer	Type No.	Serial No.	Calibrated until
1	Harmonics and Flicker Analyzer	California Instruments	PACS-1	72344	Aug. 15, 2018
2	3KVA AC Power source	California Instruments	3001ix	56309	Aug. 15, 2018
3	Measurement Software	California	CTS4.0 Version 4.9	N/A	N/A

Remark: "N/A" denotes no model name, no serial No. or no calibration specified.
All calibration period of equipment list is one year.

6.3 TEST PROCEDURE

- a. The EUT was placed on the top of a wooden table 0.8 meters above the ground and operated to produce the maximum harmonic components under normal operating conditions.
- b. The classification of EUT is according to of EN 61000-3-2. The EUT is classified as follows:
 - Class A: Balanced three-phase equipment, Household appliances excluding equipment as Class D, Tools excluding portable tools, Dimmers for incandescent lamps, audio equipment, equipment not specified in one of the three other classes.
 - Class B: Portable tools; Arc welding equipment which is not professional equipment.
 - Class C: Lighting equipment.
 - Class D: Equipment having a specified power less than or equal to 600 W of the following types: Personal computers and personal computer monitors and television receivers.
- c. The correspondent test program of test instrument to measure the current harmonics emanated from EUT is chosen. The measure time shall be not less than the time necessary for the EUT to be exercised.

6.4 DEVIATION FROM TEST STANDARD

No deviation

6.5 TEST SETUP

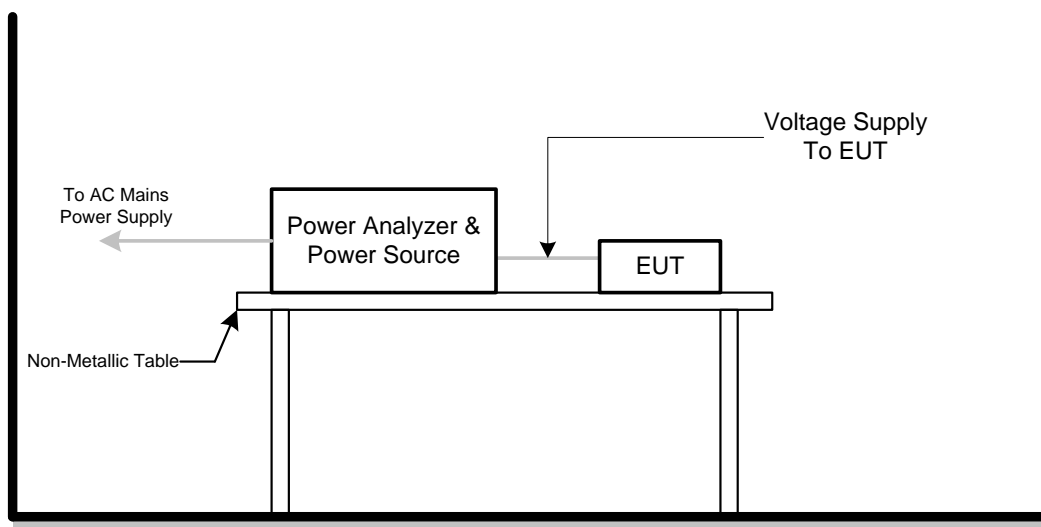

6.6 TEST RESULTS

Harmonic - Class D			
EUT	LCD Monitor	Model Name	X24P1
Temperature	25°C	Relative Humidity	55%
Test Voltage	AC 230V/50Hz		
Test Mode	HDMI 1920*1080/60Hz		
Note	EN 55032:2012+AC:2013 & 2015		

Current & voltage waveforms

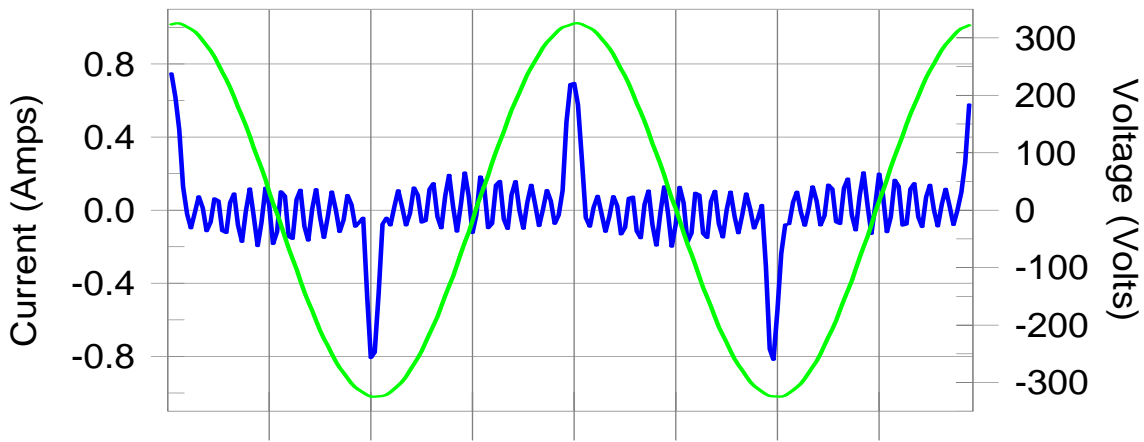

Harmonics and Class D limit line European Limits

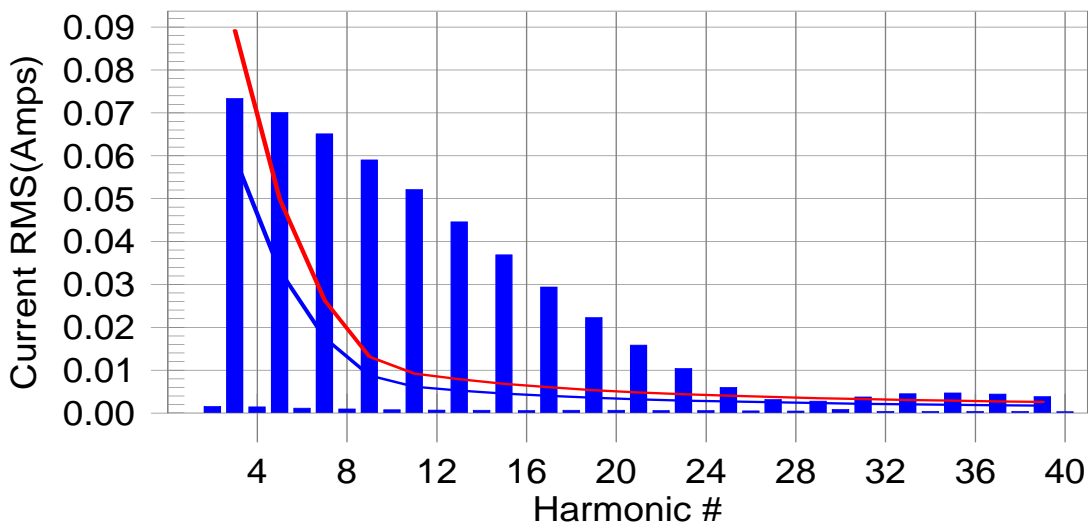

Test result: N/L Worst harmonic was #11 with 850.5% of the limit.

Current Test Result Summary (Run time)			
EUT	LCD Monitor	Model Name	X24P1
Temperature	25°C	Relative Humidity	55%
Test Voltage	AC 230V/50Hz		
Test Mode	HDMI 1920*1080/60Hz		
Note	EN 55032:2012+AC:2013 & 2015		

V_RMS (Volts): 229.85
 I_Peak (Amps): 0.866
 I_Fund (Amps): 0.081
 Power (Watts): 17.5

Frequency(Hz): 50.00
 I_RMS (Amps): 0.204
 Crest Factor: 4.417
 Power Factor: 0.380

Harm#	Harms(avg)	100%Limit	%of Limit	Harms(max)	150%Limit	%of Limit	Status
2	0.002	0.000	N/A	0.002	0.000	N/A	N/L
3	0.073	0.060	N/A	0.075	0.089	N/A	N/L
4	0.001	0.000	N/A	0.002	0.000	N/A	N/L
5	0.070	0.033	N/A	0.071	0.050	N/A	N/L
6	0.001	0.000	N/A	0.002	0.000	N/A	N/L
7	0.065	0.018	N/A	0.065	0.026	N/A	N/L
8	0.001	0.000	N/A	0.001	0.000	N/A	N/L
9	0.059	0.009	N/A	0.059	0.013	N/A	N/L
10	0.001	0.000	N/A	0.001	0.000	N/A	N/L
11	0.052	0.006	N/A	0.053	0.009	N/A	N/L
12	0.001	0.000	N/A	0.001	0.000	N/A	N/L
13	0.045	0.005	N/A	0.045	0.008	N/A	N/L
14	0.001	0.000	N/A	0.001	0.000	N/A	N/L
15	0.037	0.005	N/A	0.038	0.007	N/A	N/L
16	0.001	0.000	N/A	0.001	0.000	N/A	N/L
17	0.029	0.004	N/A	0.030	0.006	N/A	N/L
18	0.001	0.000	N/A	0.001	0.000	N/A	N/L
19	0.022	0.004	N/A	0.023	0.005	N/A	N/L
20	0.001	0.000	N/A	0.001	0.000	N/A	N/L
21	0.016	0.003	N/A	0.017	0.005	N/A	N/L
22	0.001	0.000	N/A	0.001	0.000	N/A	N/L
23	0.010	0.003	N/A	0.011	0.004	N/A	N/L
24	0.001	0.000	N/A	0.001	0.000	N/A	N/L
25	0.006	0.003	N/A	0.007	0.004	N/A	N/L
26	0.001	0.000	N/A	0.001	0.000	N/A	N/L
27	0.003	0.003	N/A	0.004	0.004	N/A	N/L
28	0.000	0.000	N/A	0.001	0.000	N/A	N/L
29	0.003	0.002	N/A	0.003	0.003	N/A	N/L
30	0.001	0.000	N/A	0.001	0.000	N/A	N/L
31	0.004	0.002	N/A	0.004	0.003	N/A	N/L
32	0.000	0.000	N/A	0.001	0.000	N/A	N/L
33	0.004	0.002	N/A	0.005	0.003	N/A	N/L
34	0.000	0.000	N/A	0.000	0.000	N/A	N/L
35	0.005	0.002	N/A	0.005	0.003	N/A	N/L
36	0.000	0.000	N/A	0.000	0.000	N/A	N/L
37	0.004	0.002	N/A	0.005	0.003	N/A	N/L
38	0.000	0.000	N/A	0.000	0.000	N/A	N/L
39	0.004	0.002	N/A	0.004	0.003	N/A	N/L
40	0.000	0.000	N/A	0.000	0.000	N/A	N/L

Note: The EUT power level is below 75.0 Watts and therefore has no defined limits

Voltage Source Verification Data (Run time)			
EUT	LCD Monitor	Model Name	X24P1
Temperature	25°C	Relative Humidity	55%
Test Voltage	AC 230V/50Hz		
Test Mode	HDMI 1920*1080/60Hz		
Note	EN 55032:2012+AC:2013 & 2015		

Highest parameter values during test:

Voltage (Vrms):229.85	Frequency(Hz): 50.00
I_Peak (Amps):0.866	I_RMS (Amps): 0.204
I_Fund (Amps):0.081	Crest Factor: 4.417
Power (Watts): 17.5	Power Factor: 0.380

Harm#	Harmonics V-rms	Limit V-rms	% of Limit	Status
2	0.141	0.460	30.72	OK
3	0.158	2.068	7.64	OK
4	0.076	0.460	16.48	OK
5	0.251	0.919	27.28	OK
6	0.034	0.460	7.37	OK
7	0.045	0.689	6.56	OK
8	0.019	0.459	4.24	OK
9	0.022	0.460	4.75	OK
10	0.017	0.460	3.61	OK
11	0.040	0.230	17.45	OK
12	0.018	0.230	7.93	OK
13	0.031	0.230	13.63	OK
14	0.013	0.230	5.59	OK
15	0.030	0.230	13.25	OK
16	0.013	0.230	5.53	OK
17	0.021	0.230	9.03	OK
18	0.010	0.230	4.37	OK
19	0.025	0.230	10.84	OK
20	0.017	0.230	7.41	OK
21	0.016	0.230	6.93	OK
22	0.014	0.230	6.09	OK
23	0.017	0.230	7.43	OK
24	0.005	0.230	2.29	OK
25	0.008	0.230	3.28	OK
26	0.007	0.230	3.25	OK
27	0.009	0.230	3.73	OK
28	0.008	0.230	3.27	OK
29	0.008	0.230	3.62	OK
30	0.005	0.230	2.28	OK
31	0.007	0.230	2.98	OK
32	0.006	0.230	2.40	OK
33	0.010	0.230	4.19	OK
34	0.003	0.230	1.40	OK
35	0.006	0.230	2.74	OK
36	0.004	0.230	1.53	OK
37	0.011	0.230	4.69	OK
38	0.003	0.230	1.16	OK
39	0.007	0.230	2.96	OK
40	0.006	0.230	2.41	OK

Harmonic - Class D			
EUT	LCD Monitor	Model Name	X24P1
Temperature	25°C	Relative Humidity	55%
Test Voltage	AC 230V/50Hz		
Test Mode	HDMI 1920*1080/60Hz		
Note	EN 55032: 2015+AC:2016		

Current & voltage waveforms

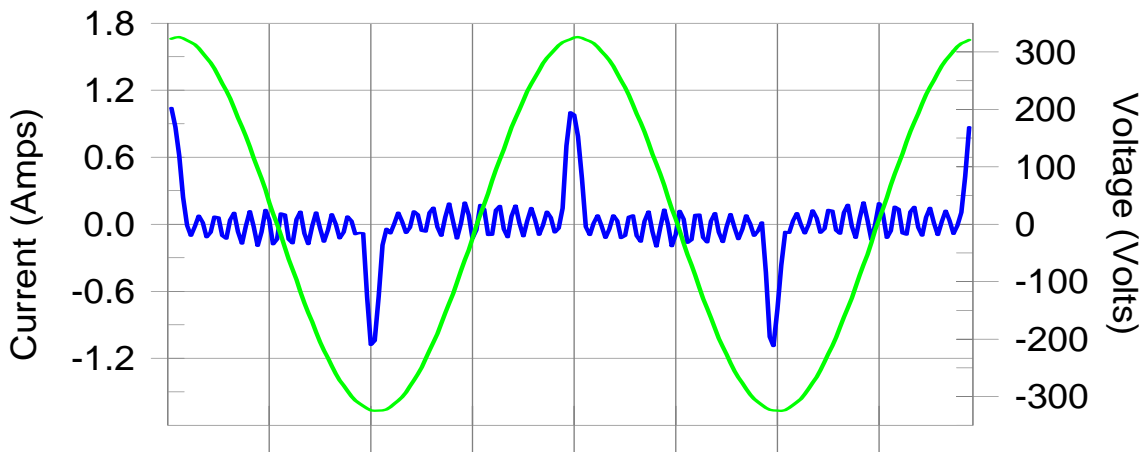

Harmonics and Class D limit line European Limits

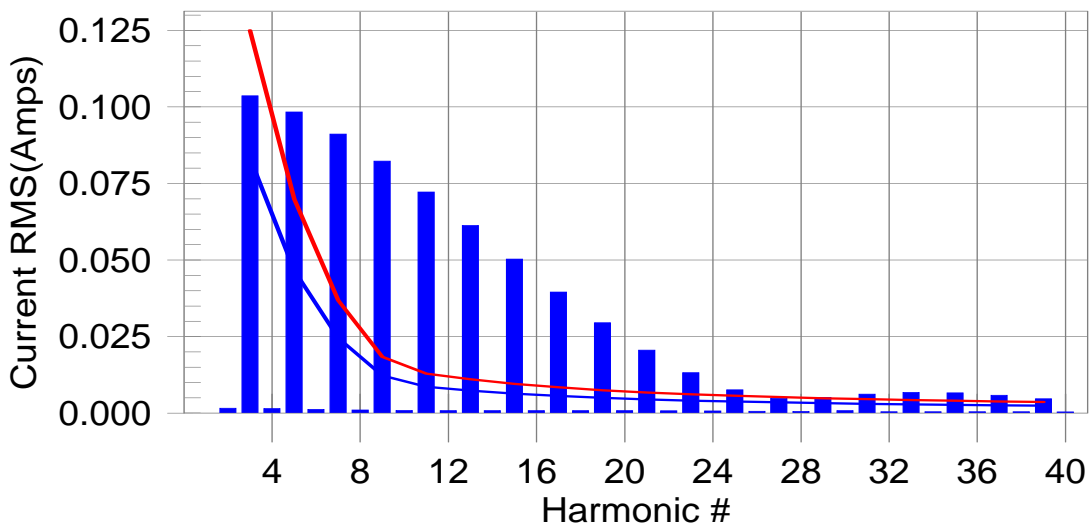

Test result: N/L Worst harmonic was #11 with 841.5% of the limit.

Current Test Result Summary (Run time)			
EUT	LCD Monitor	Model Name	X24P1
Temperature	25°C	Relative Humidity	55%
Test Voltage	AC 230V/50Hz		
Test Mode	HDMI 1920*1080/60Hz		
Note	EN 55032: 2015+AC:2016		

V_RMS (Volts): 229.89	Frequency(Hz): 50.00
I_Peak (Amps): 1.159	I_RMS (Amps): 0.267
I_Fund (Amps): 0.111	Crest Factor: 4.359
Power (Watts): 24.5	Power Factor: 0.402

Harm#	Harms(avg)	100%Limit	%of Limit	Harms(max)	150%Limit	%of Limit	Status
2	0.002	0.000	N/A	0.002	0.000	N/A	N/L
3	0.104	0.083	N/A	0.105	0.125	N/A	N/L
4	0.002	0.000	N/A	0.002	0.000	N/A	N/L
5	0.098	0.047	N/A	0.099	0.070	N/A	N/L
6	0.001	0.000	N/A	0.002	0.000	N/A	N/L
7	0.091	0.025	N/A	0.091	0.037	N/A	N/L
8	0.001	0.000	N/A	0.001	0.000	N/A	N/L
9	0.082	0.012	N/A	0.082	0.018	N/A	N/L
10	0.001	0.000	N/A	0.001	0.000	N/A	N/L
11	0.072	0.009	N/A	0.072	0.013	N/A	N/L
12	0.001	0.000	N/A	0.001	0.000	N/A	N/L
13	0.061	0.007	N/A	0.061	0.011	N/A	N/L
14	0.001	0.000	N/A	0.001	0.000	N/A	N/L
15	0.050	0.006	N/A	0.050	0.010	N/A	N/L
16	0.001	0.000	N/A	0.001	0.000	N/A	N/L
17	0.040	0.006	N/A	0.040	0.008	N/A	N/L
18	0.001	0.000	N/A	0.001	0.000	N/A	N/L
19	0.030	0.005	N/A	0.030	0.007	N/A	N/L
20	0.001	0.000	N/A	0.001	0.000	N/A	N/L
21	0.021	0.004	N/A	0.021	0.007	N/A	N/L
22	0.001	0.000	N/A	0.001	0.000	N/A	N/L
23	0.013	0.004	N/A	0.013	0.006	N/A	N/L
24	0.001	0.000	N/A	0.001	0.000	N/A	N/L
25	0.008	0.004	N/A	0.008	0.006	N/A	N/L
26	0.001	0.000	N/A	0.001	0.000	N/A	N/L
27	0.005	0.004	N/A	0.005	0.005	N/A	N/L
28	0.001	0.000	N/A	0.001	0.000	N/A	N/L
29	0.005	0.003	N/A	0.005	0.005	N/A	N/L
30	0.001	0.000	N/A	0.001	0.000	N/A	N/L
31	0.006	0.003	N/A	0.006	0.005	N/A	N/L
32	0.000	0.000	N/A	0.001	0.000	N/A	N/L
33	0.007	0.003	N/A	0.007	0.004	N/A	N/L
34	0.000	0.000	N/A	0.001	0.000	N/A	N/L
35	0.007	0.003	N/A	0.007	0.004	N/A	N/L
36	0.000	0.000	N/A	0.001	0.000	N/A	N/L
37	0.006	0.003	N/A	0.006	0.004	N/A	N/L
38	0.000	0.000	N/A	0.001	0.000	N/A	N/L
39	0.005	0.002	N/A	0.005	0.004	N/A	N/L
40	0.000	0.000	N/A	0.000	0.000	N/A	N/L

Note: The EUT power level is below 75.0 Watts and therefore has no defined limits

Voltage Source Verification Data (Run time)			
EUT	LCD Monitor	Model Name	X24P1
Temperature	25°C	Relative Humidity	55%
Test Voltage	AC 230V/50Hz		
Test Mode	HDMI 1920*1080/60Hz		
Note	EN 55032: 2015+AC:2016		

Highest parameter values during test:

Voltage (Vrms):229.89	Frequency(Hz): 50.00
I_Peak (Amps):1.159	I_RMS (Amps): 0.267
I_Fund (Amps):0.111	Crest Factor: 4.359
Power (Watts): 24.5	Power Factor: 0.402

Harm#	Harmonics V-rms	Limit V-rms	% of Limit	Status
2	0.119	0.460	25.94	OK
3	0.167	2.069	8.06	OK
4	0.076	0.460	16.44	OK
5	0.268	0.919	29.16	OK
6	0.034	0.460	7.43	OK
7	0.047	0.690	6.85	OK
8	0.016	0.460	3.58	OK
9	0.026	0.460	5.71	OK
10	0.023	0.460	4.97	OK
11	0.052	0.230	22.72	OK
12	0.019	0.230	8.11	OK
13	0.038	0.230	16.35	OK
14	0.012	0.230	5.04	OK
15	0.042	0.230	18.49	OK
16	0.016	0.230	6.96	OK
17	0.030	0.230	13.22	OK
18	0.014	0.230	5.92	OK
19	0.030	0.230	13.20	OK
20	0.016	0.230	6.86	OK
21	0.021	0.230	9.27	OK
22	0.012	0.230	5.19	OK
23	0.022	0.230	9.79	OK
24	0.008	0.230	3.45	OK
25	0.010	0.230	4.17	OK
26	0.010	0.230	4.17	OK
27	0.006	0.230	2.61	OK
28	0.009	0.230	3.98	OK
29	0.013	0.230	5.72	OK
30	0.005	0.230	2.27	OK
31	0.010	0.230	4.28	OK
32	0.006	0.230	2.71	OK
33	0.016	0.230	6.88	OK
34	0.004	0.230	1.73	OK
35	0.010	0.230	4.42	OK
36	0.004	0.230	1.62	OK
37	0.012	0.230	5.12	OK
38	0.003	0.230	1.35	OK
39	0.007	0.230	3.21	OK
40	0.006	0.230	2.51	OK

7. VOLTAGE CHANGES, VOLTAGE FLUCTUATIONS AND FLICKER TEST

7.1 LIMITS

Tests	Limits	Descriptions
	EN 61000-3-3	
Pst	≤ 1.0 , $T_p= 10$ min.	Short Term Flicker Indicator
Plt	≤ 0.65 , $T_p=2$ hr.	Long Term Flicker Indicator
dc	$\leq 3.3\%$	Relative Steady-State V-Chang
dmax	$\leq 4\%$	Maximum Relative V-change
d (t)	$\leq 3.3\%$ for > 500 ms	Relative V-change characteristic

7.2 MEASUREMENT INSTRUMENTS LIST

Item	Kind of Equipment	Manufacturer	Type No.	Serial No.	Calibrated until
1	Harmonics and Flicker Analyzer	California Instruments	PACS-1	72344	Aug. 15, 2018
2	3KVA AC Power source	California Instruments	3001ix	56309	Aug. 15, 2018
3	Measurement Software	California	CTS4.0 Version 4.9	N/A	N/A

Remark: "N/A" denotes no model name, no serial No. or no calibration specified.

All calibration period of equipment list is one year.

7.3 TEST PROCEDURE

- Tests was performed according to the Test Conditions/Assessment of Voltage Fluctuations specified in EN 61000-3-3 depend on which standard adopted for compliance measurement.
- All types of harmonic current and/or voltage fluctuation in this report are assessed by direct measurement using flicker-meter.

7.4 DEVIATION FROM TEST STANDARD

No deviation

7.5 TESTSETUP

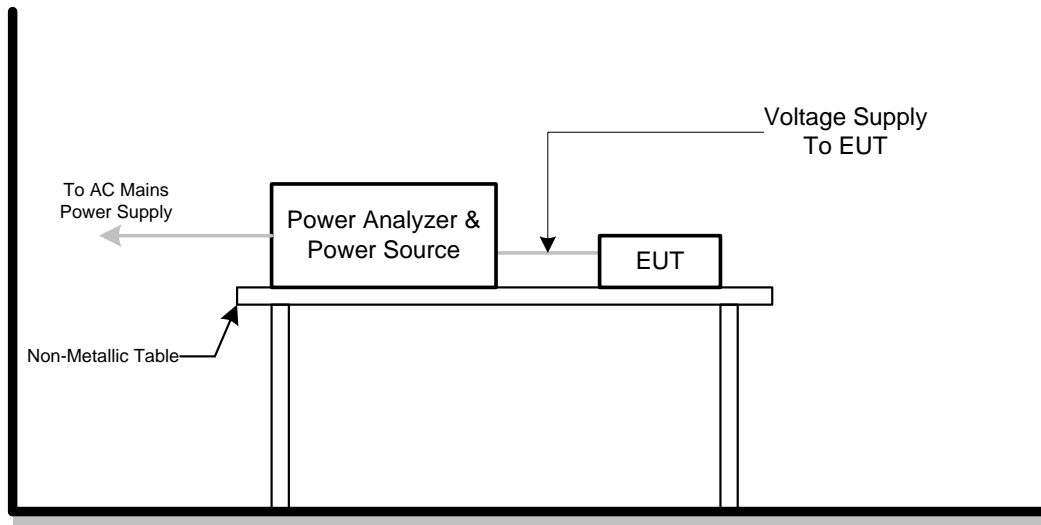

7.6 TEST RESULTS

EUT	LCD Monitor	Model Name	X24P1
Temperature	25°C	Relative Humidity	55%
Test Voltage	AC 230V/50Hz		
Test Mode	HDMI 1920*1080/60Hz		
Note	EN 55032:2012+AC:2013 & 2015		

Psti and limit line

European Limits

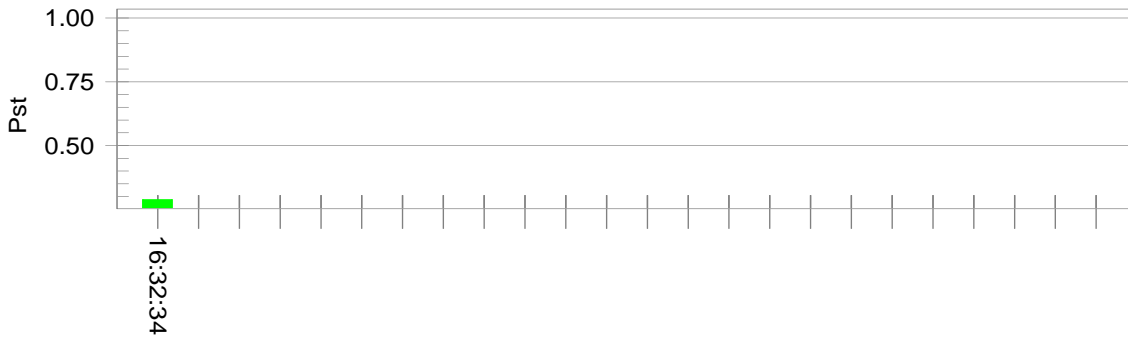

Plt and limit line

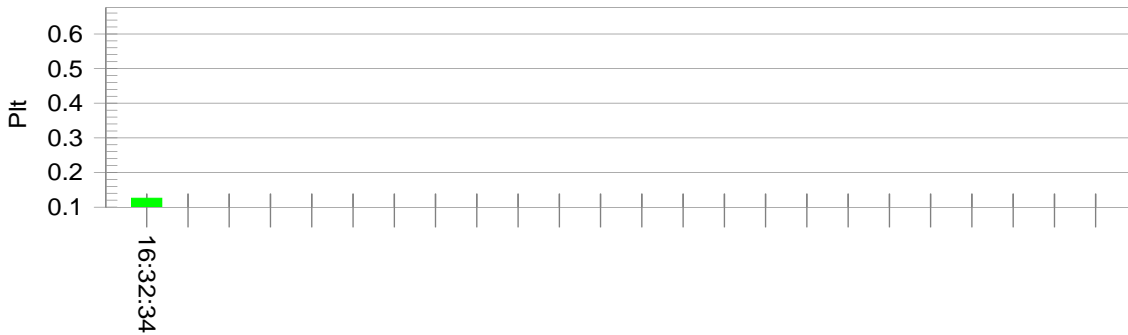

Parameter values recorded during the test:

Vrms at the end of test (Volt):229.78

Highest dt (%):	0.00	Test limit (%):	N/A	N/A
T-max (mS):	0	Test limit (mS):	500.0	Pass
Highest dc (%):	0.00	Test limit (%):	3.30	Pass
Highest dmax (%):	-0.06	Test limit (%):	4.00	Pass
Highest Pst (10 min. period):	0.288	Test limit:	1.000	Pass
Highest Plt (2 hr. period):	0.126	Test limit:	0.650	Pass

EUT	LCD Monitor	Model Name	X24P1
Temperature	25°C	Relative Humidity	55%
Test Voltage	AC 230V/50Hz		
Test Mode	HDMI 1920*1080/60Hz		
Note	EN 55032: 2015+AC:2016		

Psti and limit line

European Limits

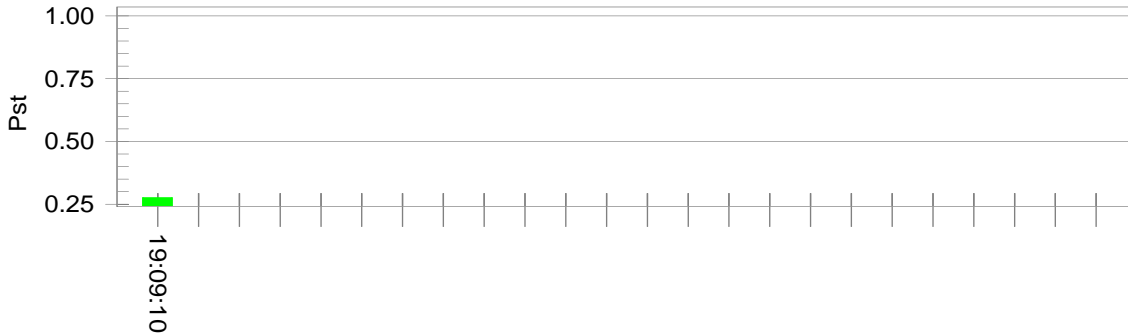

Plt and limit line



Parameter values recorded during the test:

Vrms at the end of test (Volt):229.78

Highest dt (%):	0.00	Test limit (%):	N/A	N/A
T-max (mS):	0	Test limit (mS):	500.0	Pass
Highest dc (%):	0.00	Test limit (%):	3.30	Pass
Highest dmax (%):	0.06	Test limit (%):	4.00	Pass
Highest Pst (10 min. period):	0.277	Test limit:	1.000	Pass
Highest Plt (2 hr. period):	0.121	Test limit:	0.650	Pass

8. EMC IMMUNITY TEST

8.1 STANDARD COMPLIANCE/SEVERITY LEVEL/CRITERIA

Tests Standard No.	Test Specification Level / Test Mode	Test Ports	Criteria
Electrostatic discharge EN 61000-4-2 (ESD)	±8 kV air discharge ±4 kV contact discharge (Direct Mode)	Enclosure	B
	±4kV HCP discharge ±4kV VCP discharge (Indirect Mode)	Enclosure	B
Radiated, radio-frequency, electromagnetic field immunity EN 61000-4-3 (RS)	80 MHz to 1000 MHz 3V/m(unmodulated, r.m.s), 1 kHz, 80%, AM modulated	Enclosure	A
Electrical fast transient/burst immunity EN 61000-4-4 (EFT/Burst)	±0.5kV(peak) 5/50ns Tr/Th 5kHz Repetition Frequency (100kHz Repetition Frequency for xDSL equipment)	Signal ports and telecommunication ports (Only applicable to cable length>3 m)	B
	±0.5kV(peak) 5/50ns Tr/Th 5kHz Repetition Frequency	DC Power Ports	B
	±1 kV(peak) 5/50ns Tr/Th 5kHz Repetition Frequency	AC Power Ports	B
Surge immunity EN 61000-4-5 (Surges)	±1 kV(peak) 10/700 Tr/Th μs(NOTE) (without primary protection)	Signal ports and telecommunication ports (applicable only to ports connect directly to outdoor cables)	C
	±4 kV(peak) 10/700 Tr/Th μs(NOTE) (with primary protectors fitted)		C
	±0.5 kV(peak) 1.2/50(8/20) Tr/Th μs	DC Power Ports (applicable only to ports connect directly to outdoor cables)	B
	±1 kV(peak) 1.2/50(8/20) Tr/Th μs (line to line)	AC Power Ports	B
	±2 kV(peak) 1.2/50(8/20) Tr/Th μs (line to earth or ground)		B

Immunity to conducted disturbances, induced by radio-frequency fields EN 61000-4-6 (Injected Current)	0.15 MHz to 80 MHz 3V(unmodulated, r.m.s), 1kHz 80%, AM 150Ω source impedance	Signal ports and telecommunication ports (Only applicable to cable length>3 m)	A
	0.15 MHz to 80 MHz 3V(unmodulated, r.m.s), 1kHz 80%, AM 150Ω source impedance	DC Power Ports	A
	0.15 MHz to 80 MHz 3V(unmodulated, r.m.s), 1kHz 80%, AM 150Ω source impedance	AC Power Ports	A
Power frequency magnetic field immunity EN 61000-4-8 (PFMF)	50 Hz or 60Hz, 1A/m(r.m.s) μs	Enclosure	A
Voltage dips, short interruptions and voltage variations immunity EN 61000-4-11 (Voltage Interruption/Dips)	Voltage reduction > 95% 0.5 period Voltage reduction 30% 25 periods Voltage reduction > 95% 250 periods	AC Power Ports	B C C

Note.

Where the coupling network for the 10/700 μs waveform affects the functioning of high speed data ports, the test shall be carried out using a 1,2/50 (8/20) μs waveform and appropriate coupling network.

8.2 GENERAL PERFORMANCE CRITERIA

According to **EN55024** standard, the general performance criteria as following:

<p>Criterion A</p>	<p>The equipment shall continue to operate as intended without operator intervention. No degradation of performance or loss of function is allowed below a performance level specified by the manufacturer when the equipment is used as intended. The performance level may be replaced by a permissible loss of performance.</p> <p>If the minimum performance level or the permissible performance loss is not specified by the manufacturer, then either of these may be derived from the product description and documentation, and by what the user product description and documentation, and by what the user may reasonably expect from the equipment if used as intended.</p>
<p>Criterion B</p>	<p>After the test, the equipment shall continue to operate as intended without operator intervention. No degradation of performance or loss of function is allowed, after the application of the phenomenon below a performance level specified by the manufacturer, when the equipment is used as intended. The performance level may be replaced by a permissible loss of performance.</p> <p>During the test, degradation of performance is allowed. However, no change of operating state if stored data allowed to persist after the test. If the minimum performance level (or the permissible performance loss) is not specified by the manufacturer, then either of these may be derived from the product description and documentation, and by what the user may reasonably expect from the equipment if used as intended.</p>
<p>Criterion C</p>	<p>Loss of function is allowed, provided the function is self-recoverable, or can be restored by the operation of the controls by the user in accordance with the manufacturer's instructions.</p> <p>Functions, and/or information stored in non-volatile memory, or protected by a battery backup, shall not be lost.</p>

8.3 ELECTROSTATIC DISCHARGE IMMUNITY TEST (ESD)

8.3.1 TEST SPECIFICATION

Basic Standard	EN 61000-4-2
Discharge Impedance	330 ohm / 150 pF
Required Performance	B
Discharge Voltage	Air Discharge: ± 2 kV, ± 4 kV, ± 8 kV (Direct) Contact Discharge: ± 2 kV, ± 4 kV (Direct/Indirect)
Polarity	Positive & Negative
Number of Discharge	Air Discharge: min. 20 times at each test point Contact Discharge: min. 200 times in total
Discharge Mode	Single Discharge
Discharge Period	1 second minimum

8.3.2 MEASUREMENT INSTRUMENTS

Item	Kind of Equipment	Manufacturer	Type No.	Serial No.	Calibrated until
1	ESD Generator	TESEQ AG	NSG 437	450	Nov. 01, 2018

Remark: "N/A" denotes no model name, no serial No. or no calibration specified.

All calibration period of equipment list is one year.

8.3.3 TEST PROCEDURE

The test generator necessary to perform direct and indirect application of discharges to the EUT in the following manner:

- a. Contact discharge was applied to conductive surfaces (Direct) and coupling planes (Indirect) of the EUT.

During the test, it was performed with single discharges. For the single discharge time between successive single discharges was at least 1 second. The EUT shall be exposed to at least 200 discharges, 100 each at negative and positive polarity, at a minimum of four test points. One of the test points shall be subjected to at least 50 indirect discharges to the center of the front edge of the horizontal coupling plane. The remaining three test points shall each receive at least 50 direct contact discharges.

If no direct contact test points are available, then at least 200 indirect discharges shall be applied in the indirect mode. Test shall be performed at a maximum repetition rate of one discharge per second.

Vertical Coupling Plane (VCP):

The coupling plane, of dimensions 0.5m x 0.5m, is placed parallel to, and positioned at a distance 0.1m from, the EUT, with the Discharge Electrode touching the coupling plane.

The four faces of the EUT will be performed with electrostatic discharge.

Horizontal Coupling Plane (HCP):

The coupling plane is placed under to the EUT. The generator shall be positioned vertically at a distance of 0.1m from the EUT, with the Discharge Electrode touching the coupling plane.

The four faces of the EUT will be performed with electrostatic discharge.

- b. Air discharges at insulation surfaces of the EUT.

It was at least ten single discharges with positive and negative at the same selected point.

8.3.4 DEVIATION FROM TEST STANDARD

No deviation

8.3.5 TEST SETUP

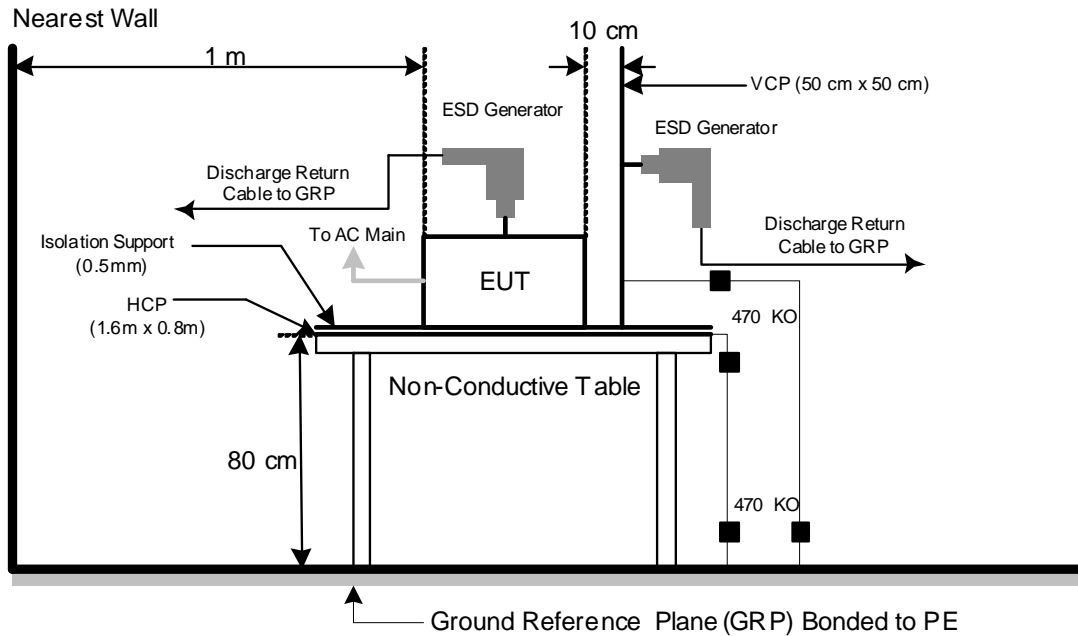

Note:

TABLE-TOP EQUIPMENT

The configuration consisted of a wooden table 0.8 meters high standing on the Ground Reference Plane. The GRP consisted of a sheet of aluminum at least 0.25mm thick, and 2.5 meters square connected to the protective grounding system. A Horizontal Coupling Plane (1.6m x 0.8m) was placed on the table and attached to the GRP by means of a cable with 940k total impedance. The equipment under test was installed in a representative system as described in EN 61000-4-2, and its cables were placed on the HCP and isolated by an insulating support of 0.5mm thickness. A distance of 1-meter minimum was provided between the EUT and the walls of the laboratory and any other metallic structure.

FLOOR-STANDING EQUIPMENT

The equipment under test was installed in a representative system as described in EN 61000-4-2, and its cables were isolated from the Ground Reference Plane by an insulating support of 0.1-meter thickness. The GRP consisted of a sheet of aluminum that is at least 0.25mm thick, and 2.5meters square connected to the protective grounding system and extended at least 0.5 meters from the EUT on all sides.

8.3.6 TEST RESULTS

EUT	LCD Monitor	Model Name	X24P1
Temperature	25°C	Relative Humidity	48%
Test Voltage	AC 230V/50Hz	Pressure	1010hPa
Test Mode	HDMI 1920*1080/60Hz		

Mode	Air Discharge								Contact Discharge						
	2kV		4kV		8kV		- kV		2kV		4kV		- kV		
Location	P	N	P	N	P	N	P	N	P	N	P	N	P	N	
1	A	A	A	A	B	B	-	-	A	A	A	A	-	-	
2	A	A	A	A	A	A	-	-	A	A	A	A	-	-	
3	A	A	A	A	A	A	-	-	-	-	-	-	-	-	
4	A	A	A	A	A	A	-	-	-	-	-	-	-	-	
5	A	A	A	A	A	A	-	-	-	-	-	-	-	-	
Criteria	B								-		B				-
Result	B								-		A				-
Judgment	PASS								-		PASS				-

Mode	HCP Contact Discharge						VCP Contact Discharge						
	2kV		4kV		- kV		2kV		4kV		- kV		
Location	P	N	P	N	P	N	P	N	P	N	P	N	
1	A	A	A	A	-	-	A	A	A	A	-	-	
2	A	A	A	A	-	-	A	A	A	A	-	-	
3	A	A	A	A	-	-	A	A	A	A	-	-	
4	A	A	A	A	-	-	A	A	A	A	-	-	
Criteria	B						-		B				-
Result	A						-		A				-
Judgment	PASS						-		PASS				-

Note:

- 1) P/N denotes the Positive/Negative polarity of the output voltage.
- 2) Test condition:
 Direct/Indirect(HCP/VCP) discharges: Minimum 50 times (Positive/Negative) at eachpoint.
 Air discharges: Minimum 20 times (Positive/Negative) at each point.
- 3) Test location(s) in which discharge (Air and contact discharge) to be applied illustrated by photos shown in next page(s)
- 4) The Indirect (HCP/VCP) discharges description of test point as following:
 1.left side; 2.right side; 3.front side; 4.rear side.
- 5) N/A - denotes test is not applicable in this test report
- 6) Criterion A: No observation of any performance degradation.
- 7) Criterion B: Some degradation of performance is observed but the equipment continues to operate as intended.
- 8) Criterion C: Loss of functionality, but self-recoverable by user, without loss of information or settings.

PHOTO(S) SHOWN THE LOCATION(S) OF ESD EVALUATED

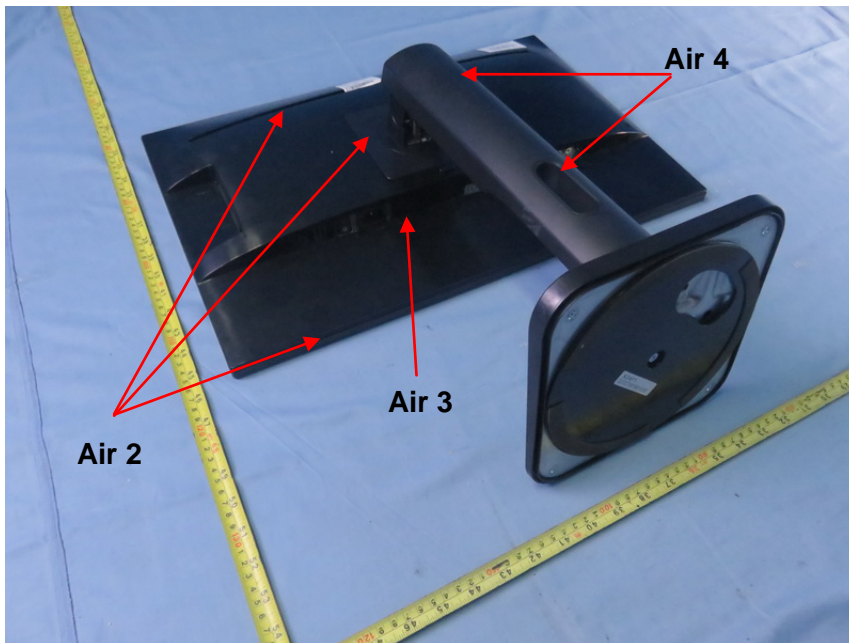
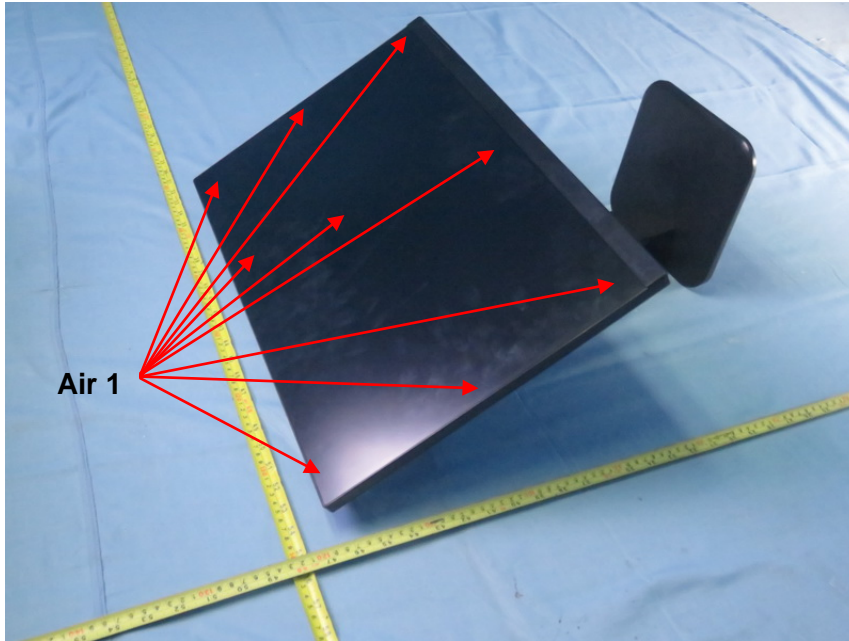

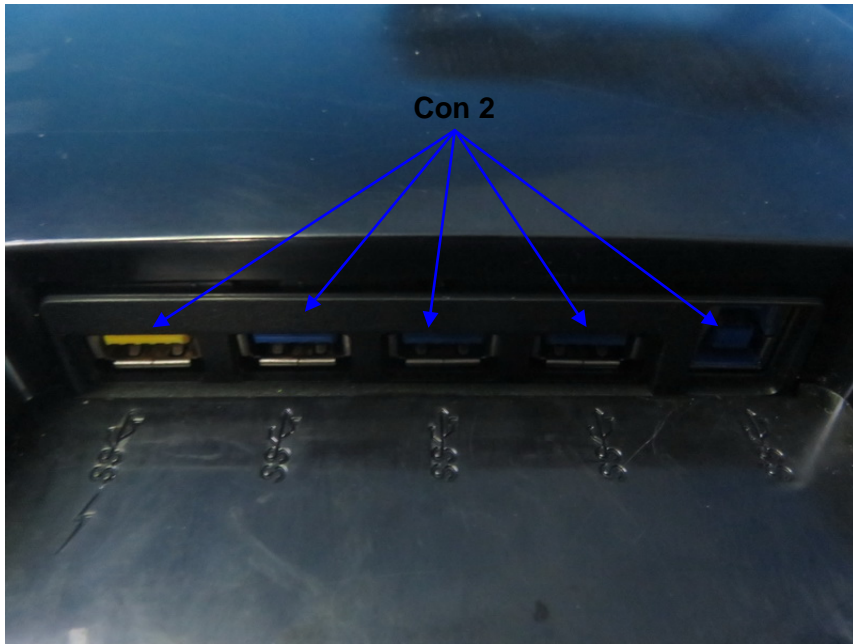
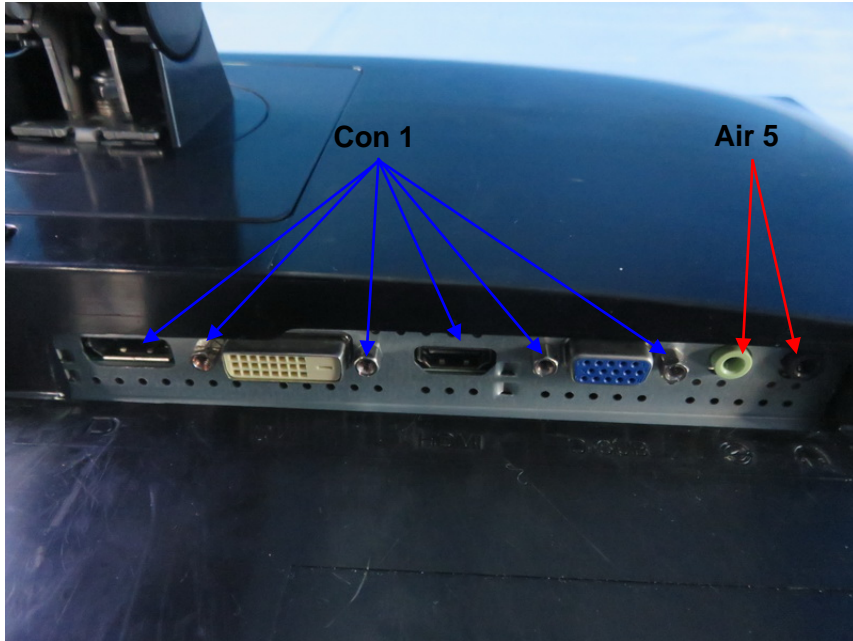

8.4 RADIATED, RADIO-FREQUENCY, ELECTROMAGNETIC FIELD IMMUNITY TEST (RS)

8.4.1 TEST SPECIFICATION

Basic Standard	EN 61000-4-3
Required Performance	A
Frequency Range	80 MHz - 1000 MHz
Field Strength	3 V/m(unmodulated, r.m.s)
Modulation	1 kHz Sine Wave, 80%, AM Modulation
Frequency Step	1% of fundamental
Polarity of Antenna	Horizontal and Vertical
Test Distance	3 m
Antenna Height	1.5 m
Dwell Time	at least 3 seconds

8.4.2 MEASUREMENT INSTRUMENTS

Item	Kind of Equipment	Manufacturer	Type No.	Serial No.	Calibrated until
1	MXG Analog Signal Generator	Agilent	N5181A	MY49060710	Aug. 20, 2018
2*	Power amplifier	MILMEGA	80RF1000-250	1064833	Aug. 20, 2020
3	Antenna	ETS	3142C	00047662	Mar. 26, 2018
4	Measurement Software	TOYO	IM5/RS Ver 3.8.050	N/A	N/A

Remark: "N/A" denotes no model name, no serial No. or no calibration specified.

All calibration period of equipment list is one year.

"*" calibration period of equipment list is three year.

8.4.3 TEST PROCEDURE

The EUT and support equipment, which are placed on a table that is 0.8 meter above ground and the testing was performed in a fully-anechoic chamber.

The testing distance from antenna to the EUT was 3 meters.

The other condition as following manner:

- a. The field strength level was 3 V/m(unmodulated, r.m.s).
- b. The frequency range is swept from 80 MHz to 1000 MHz, with the signal 80%amplitude modulated with a 1 kHz sine wave. The rate of sweep did not exceed 1.5×10^{-3} decade/s. Where the frequency range is swept incrementally, the step size was 1% of fundamental.
- c. The dwell time at each frequency shall be not less than the time necessary for the EUT to be able to respond.
- d. The test was performed with the EUT exposed to both vertically and horizontally polarized fields on each of the four sides.

8.4.4 DEVIATION FROM TEST STANDARD

No deviation

8.4.5 TEST SETUP

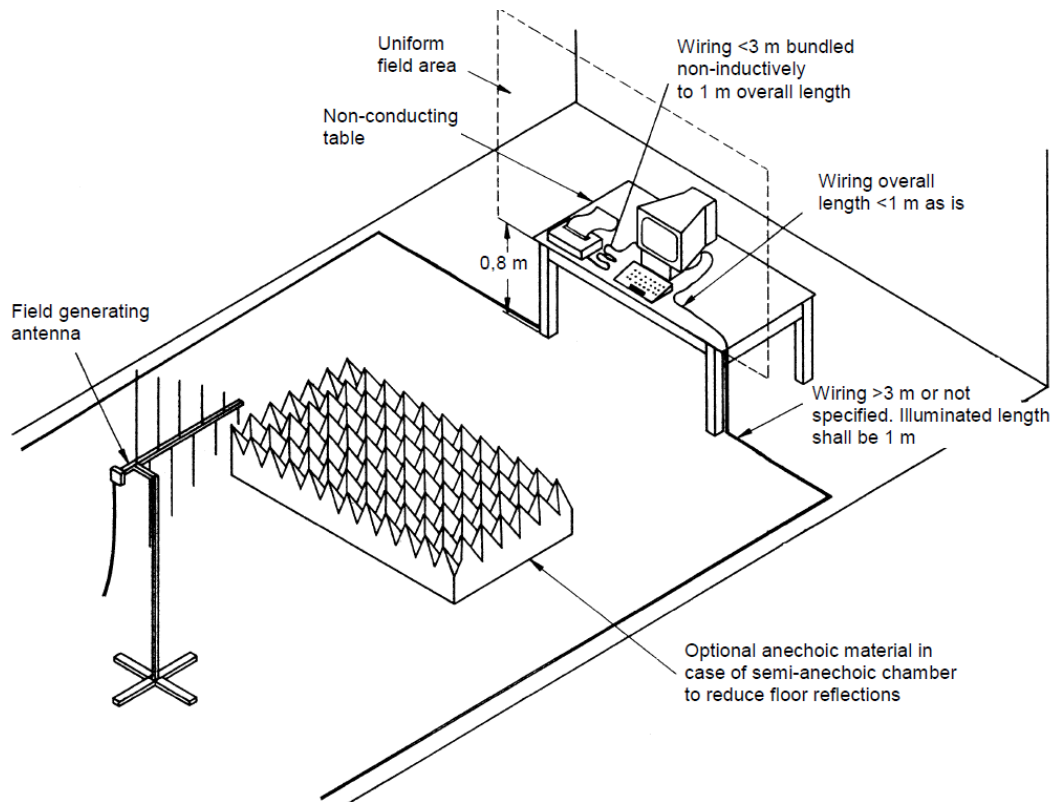

Note:

TABLE-TOP EQUIPMENT

The EUT installed in a representative system as described in EN 61000-4-3 was placed on a non-conductive table 0.8 meters in height. The system under test was connected to the power and signal wire according to relevant installation instructions.

FLOOR-STANDING EQUIPMENT

The EUT installed in a representative system as described in EN 61000-4-3 was placed on a non-conductive wood support 0.1 meters in height. The system under test was connected to the power and signal wire according to relevant installation instructions.

8.4.6 TEST RESULTS

EUT	LCD Monitor	Model Name	X24P1
Temperature	25°C	Relative Humidity	56%
Test Voltage	AC 230V/50Hz		
Test Mode	HDMI 1920*1080/60Hz		

Frequency Range (MHz)	RF Field Position	R.F. Field Strength	Azimuth	Criterion	Result	Judgment
80 - 1000	H / V	3V (unmodulated, r.m.s) AM Modulated 1000Hz, 80%	0	A	A	PASS
			90			
			180			
			270			

Note:

- 1) P/N denotes the Positive/Negative polarity of the output voltage.
- 2) N/A - denotes test is not applicable in this test report.
- 3) Criterion A: No observation of any performance degradation.
- 4) Criterion B: Some degradation of performance is observed but the equipment continues to operate as intended.
- 5) Criterion C: Loss of functionality, but self-recoverable by user, without loss of information or settings.

8.5 ELECTRICAL FAST TRANSIENT/BURST IMMUNITY TEST (EFT/BURST)

8.5.1 TEST SPECIFICATION

Basic Standard	EN 61000-4-4
Required Performance	B
Test Voltage	Power Line: ± 1 kV
Polarity	Positive & Negative
Impulse Frequency	5 kHz: except for xDSL equipment 100 kHz: only for single lines of xDSL equipment.
Impulse Wave shape	5/50 ns
Burst Duration	15 ms
Burst Period	300 ms
Test Duration	Not less than 1 min.

8.5.2 MEASUREMENT INSTRUMENTS

Item	Kind of Equipment	Manufacturer	Type No.	Serial No.	Calibrated until
1	THE MODULAR SOLUTION FOR 6 KV APPLICATIONS	Teseq	NSG 3060	1423	Aug. 20, 2018
2	Measurement Software	Teseq	Win 3000 Version 1.2.0	N/A	N/A

Remark: "N/A" denotes no model name, no serial No. or no calibration specified.
All calibration period of equipment list is one year.

8.5.3 TEST PROCEDURE

The EUT and support equipment(s) are placed on a table that is 0.8 meter high above a metal ground plane and should be located 0.1 m \pm 0.01m high above the Ground Reference Plane (1m*1m min. and 0.65mm thick min).

The other condition as following manner:

- a. The length of power cord between the coupling device and the EUT should not exceed 1 meter.
- b. Both positive and negative polarity discharges were applied.
- c. The duration time of each test sequential was 1 minute

8.5.4 DEVIATION FROM TEST STANDARD

No deviation

8.5.5 TEST SETUP

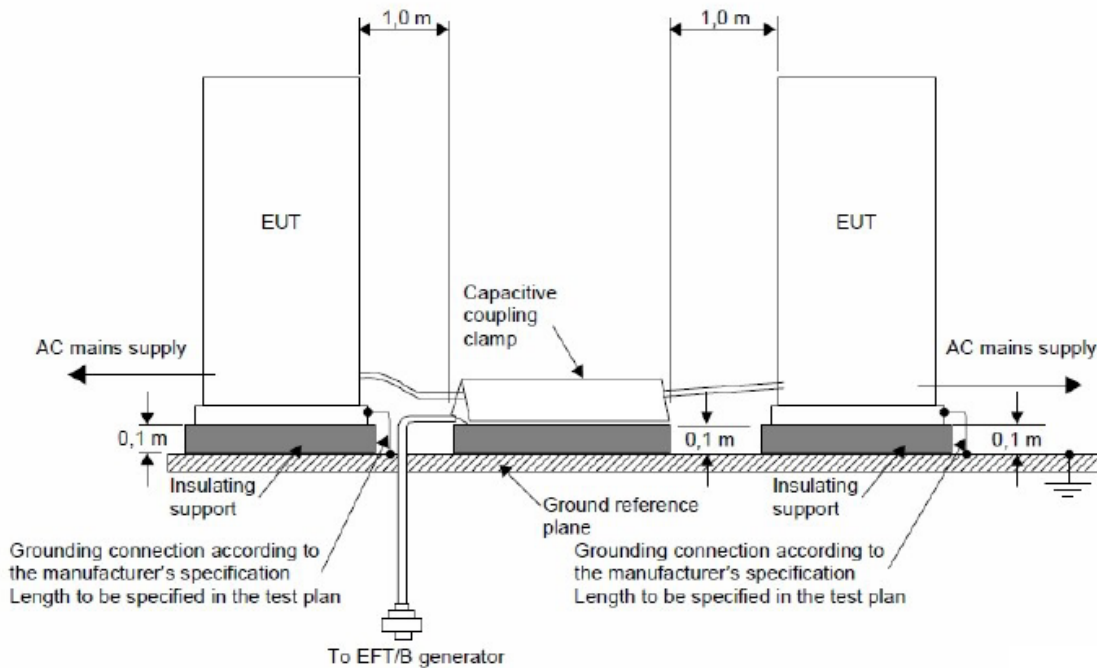
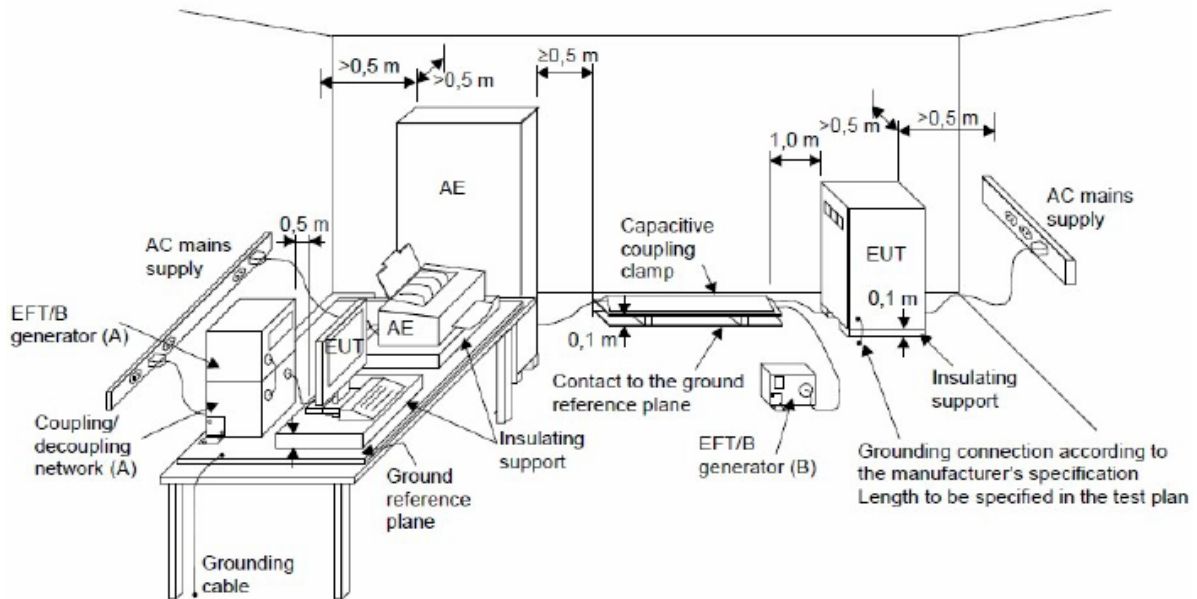

Note:

TABLE-TOP EQUIPMENT

The configuration consisted of a wooden table (0.8m high) standing on the Ground Reference Plane and should be located 0.1 m+/- 0.01m above the Ground Reference Plane. The GRP consisted of a sheet of aluminum (at least 0.25mm thick and 2.5m square) connected to the protective grounding system. A minimum distance of 0.5m was provided between the EUT and the walls of the laboratory or any other metallic structure.

FLOOR-STANDING EQUIPMENT

The EUT installed in a representative system as described in EN 61000-4-4 and its cables were isolated from the Ground Reference Plane by an insulating support that is 0.1-meter thick. The GRP consisted of a sheet of aluminum (at least 0.25mm thick and 2.5m square) connected to the protective grounding system.

8.5.6 TEST RESULTS

EUT	LCD Monitor	Model Name	X24P1
Temperature	25°C	Relative Humidity	53%
Test Voltage	AC 230V/50Hz		
Test Mode	HDMI 1920*1080/60Hz		

EUT Ports Tested		Polarity	Repetition Frequency	Test Level 1kV	Criterion	Result	Judgment
AC Power Port	Line (L)	+	5 kHz	A	B	A	PASS
		-	5 kHz	A			
	Neutral (N)	+	5 kHz	A	B	A	PASS
		-	5 kHz	A			
	Ground (PE)	+	5 kHz	A	B	A	PASS
		-	5 kHz	A			

Note:

- 1) P/N denotes the Positive/Negative polarity of the output voltage.
- 2) N/A - denotes test is not applicable in this test report
- 3) Criterion A: No observation of any performance degradation.
- 4) Criterion B: Some degradation of performance is observed but the equipment continues to operate as intended.
- 5) Criterion C: Loss of functionality, but self-recoverable by user, without loss of information or settings.

8.6 SURGE IMMUNITY TEST

8.6.1 TEST SPECIFICATION

Basic Standard	EN 61000-4-5
Required Performance	B
Wave-Shape	Combination Wave for power lines 1.2/50 us Open Circuit Voltage 8 /20 us Short Circuit Current
Test Voltage	Power Line: ± 0.5 kV, ± 1 kV, ± 2 kV
Surge Input/Output	L-N, L-PE, N-PE
Generator Source Impedance	2 ohm between networks 12 ohm between network and ground
Polarity	Positive/Negative
Phase Angle:	AC Port: $0^\circ/90^\circ/180^\circ/270^\circ$
Pulse Repetition Rate	1 time / min. (maximum)
Number of Tests	5 positive and 5 negative at selected points

8.6.2 MEASUREMENT INSTRUMENTS

Item	Kind of Equipment	Manufacturer	Type No.	Serial No.	Calibrated until
1	THE MODULAR SOLUTION FOR 6 KV APPLICATIONS	Teseq	NSG 3060	1423	Aug. 20, 2018
2	Measurement Software	Teseq	Win 3000 Version 1.2.0	N/A	N/A

Remark: "N/A" denotes no model name, no serial No. or no calibration specified.
All calibration period of equipment list is one year.

8.6.3 TEST PROCEDURE

a. For EUT power supply:

The surge is to be applied to the EUT power supply terminals via the capacitive coupling network. Decoupling networks are required in order to avoid possible adverse effects on equipment not under test that may be powered by the same lines, and to provide sufficient decoupling impedance to the surge wave. The power cord between the EUT and the coupling/decoupling networks shall be 2meters in length (or shorter).

b. For test applied to unshielded unsymmetrically operated interconnection lines of EUT :

The surge is applied to the lines via the capacitive coupling. The coupling /decoupling networks shall not influence the specified functional conditions of the EUT. The interconnection line between the EUT and the coupling/decoupling networks shall be 2 meters in length (or shorter).

c. For test applied to unshielded symmetrically operated interconnection /telecommunication lines of EUT :

The surge is applied to the lines via gas arrestors coupling. Test levels below the ignition point of the coupling arrester cannot be specified. The interconnection line between the EUT and the coupling/decoupling networks shall be 2 meters in length (or shorter).

8.6.4 DEVIATION FROM TEST STANDARD

No deviation

8.6.5 TEST SETUP

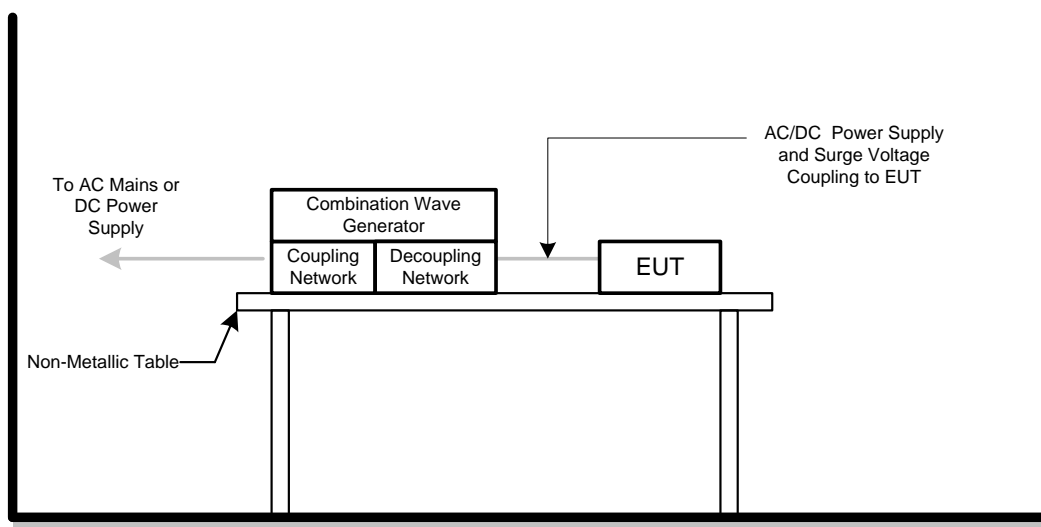

8.6.6 TEST RESULTS

EUT	LCD Monitor	Model Name	X24P1
Temperature	25°C	Relative Humidity	53%
Test Voltage	AC 230V/50Hz		
Test Mode	HDMI 1920*1080/60Hz		

Wave Form EUT Ports Tested		1.2/50(8/20)Tr/Thµs						Criterion	Result	Judgment
		Polarity	Phase	Voltage						
				0.5kV	1kV	-- kV	-- kV			
AC	L – N (2 ohm)	+/-	0°	A	A	-	-	B	A	PASS
		+/-	90°	A	A	-	-			
		+/-	180°	A	A	-	-			
		+/-	270°	A	A	-	-			

Wave Form EUT Ports Tested		1.2/50(8/20)Tr/Thµs						Criterion	Result	Judgment
		Polarity	Phase	Voltage						
				0.5kV	1kV	2kV	-- kV			
AC	L – PE (12 ohm)	+/-	0°	A	A	A	-	B	A	PASS
		+/-	90°	A	A	A	-			
		+/-	180°	A	A	A	-			
		+/-	270°	A	A	A	-			
	N – PE (12 ohm)	+/-	0°	A	A	A	-	B	A	PASS
		+/-	90°	A	A	A	-			
		+/-	180°	A	A	A	-			
		+/-	270°	A	A	A	-			

Note:

- 1) Polarity and Numbers of Impulses: 5 Pst / Ngt at each tested mode
- 2) N/A - denotes test is not applicable in this Test Report
- 3) Criterion A: No observation of any performance degradation.
- 4) Criterion B: Some degradation of performance is observed but the equipment continues to operate as intended.
- 5) Criterion C: Loss of functionality, but self-recoverable by user, without loss of information or settings.

8.7 IMMUNITY TO CONDUCTED DISTURBANCES, INDUCED BY RADIO-FREQUENCY FIELDS TEST (CS)

8.7.1 TEST SPECIFICATION

Basic Standard	EN 61000-4-6
Required Performance	A
Frequency Range	0.15 MHz - 80 MHz
Field Strength	3 V (unmodulated, r.m.s.)
Modulation	1 kHz Sine Wave, 80%, AM Modulation
Frequency Step	1% of fundamental
Dwell Time	at least 3 seconds

8.7.2 MEASUREMENT INSTRUMENTS

Item	Kind of Equipment	Manufacturer	Type No.	Serial No.	Calibrated until
1	Measurement Software	Farad	EZ-CS(V2.0.1.2)	N/A	N/A
2	Power CDN	FCC	FCC-801-M2/M3-16A	100270	Mar. 26, 2018
3	Power CDN	FCC	FCC-801-M2/M3-16A	100271	Mar. 26, 2018
4	Power Amplifier	Teseq	CBA230M-080	T43748	Mar. 26, 2018
5	Signal Generator	HP	8648A	3636A02964	Mar. 26, 2018

Remark: "N/A" denotes no model name, no serial No. or no calibration specified.

All calibration period of equipment list is one year.

8.7.3 TEST PROCEDURE

The EUT and support equipment, are placed on a table that is 0.8 meter above a metal ground plane measured 1m*1m min. and 0.65mm thick min.

The other condition as following manner:

- a. The field strength level was 3 V (unmodulated, r.m.s.)
- b. The frequency range is swept from 150 kHz to 80 MHz, with the signal 80%amplitude modulated with a 1 kHz sine wave. The rate of sweep did not exceed 1.5×10^{-3} decade/s. Where the frequency range is swept incrementally, the step size was 1% of fundamental.
- c. The dwell time at each frequency shall be not less than the time necessary for the EUT to be able to respond.

8.7.4 DEVIATION FROM TEST STANDARD

No deviation

8.7.5 TEST SETUP

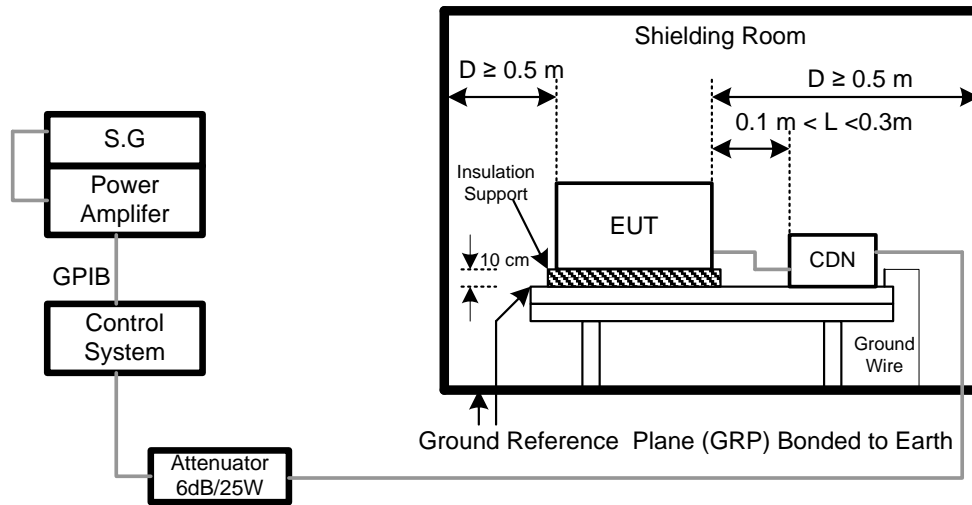

NOTE:

FLOOR-STANDING EQUIPMENT

The equipment to be tested is placed on an insulating support of 0.1 meters height above a ground reference plane. All relevant cables shall be provided with the appropriate coupling and decoupling devices at a distance between 0.1 meters and 0.3 meters from the projected geometry of the EUT on the ground reference plane.

8.7.6 TEST RESULTS

EUT	LCD Monitor	Model Name	X24P1
Temperature	25°C	Relative Humidity	52%
Test Voltage	AC 230V/50Hz		
Test Mode	HDMI 1920*1080/60Hz		

Test Ports (Mode)	Freq.Range (MHz)	Field Strength	Criteria	Results	Judgment
Input/ Output AC.PowerPort	0.15 ---80	3V(unmodulated, r.m.s) AM Modulated 1000Hz, 80%	A	A	PASS
Input/ Output DC. PowerPort	0.15 --- 80		A	N/A	N/A
Signal Line (N/A)	0.15 --- 80		A	N/A	N/A

Note:

- 1). N/A - denotes test is not applicable in this test report.
- 2) Criterion A: No observation of any performance degradation.
- 3) Criterion B: Some degradation of performance is observed but the equipment continues to operate as intended.
- 4) Criterion C: Loss of functionality, but self-recoverable by user, without loss of information or settings.

8.8 POWER FREQUENCY MAGNETIC FIELD IMMUNITY TEST (PFMF)

8.8.1 TEST SPECIFICATION

Basic Standard	EN 61000-4-8
Required Performance	A
Frequency Range	50/60 Hz
Field Strength	1 A/m
Observation Time	1 minute
Inductance Coil	Rectangular type, 1mx1m

8.8.2 MEASUREMENT INSTRUMENTS

Item	Kind of Equipment	Manufacturer	Type No.	Serial No.	Calibrated until
1	Magnetic Field test Generator	FCC	F-1000-4-8-G-125A	04032	Mar. 26, 2018
2	Magnetic Field immunity loop	Thermo KeyTek	F-1000-4-8/9/10-L-1M	04024	Mar. 26, 2018

Remark: "N/A" denotes no model name, no serial No. or no calibration specified.
All calibration period of equipment list is one year.

8.8.3 TEST PROCEDURE

The EUT and support equipment, are placed on a table that is 0.8 meter above a metal ground plane measured 1m*1m min. and 0.65mm thick min.

The other condition as following manner:

- a. The equipment cabinets shall be connected to the safety earth directly on the GRP via the earth terminal of the EUT.
- b. The cables supplied or recommended by the equipment manufacturer shall be used. 1 meter of all cables used shall be exposed to the magnetic field.

8.8.4 DEVIATION FROM TEST STANDARD

No deviation

8.8.5 TEST SETUP

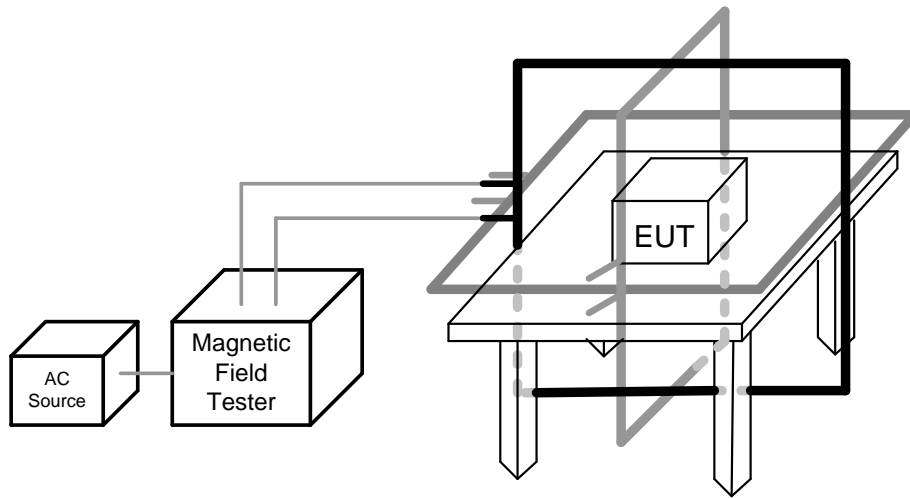

Note:

TABLE-TOP EQUIPMENT

The equipment shall be subjected to the test magnetic field by using the induction coil of standard dimension (1 m x 1 m). The induction coil shall then be rotated by 90 degrees in order to expose the EUT to the test field with different orientations.

FLOOR-STANDING EQUIPMENT

The equipment shall be subjected to the test magnetic field by using induction coils of suitable dimensions. The test shall be repeated by moving and shifting the induction coils, in order to test the whole volume of the EUT for each orthogonal direction. The test shall be repeated with the coil shifted to different positions along the side of the EUT, in steps corresponding to 50 percent of the shortest side of the coil. The induction coil shall then be rotated by 90 degrees in order to expose the EUT to the test field with different orientations.

8.8.6 TEST RESULTS

EUT	LCD Monitor	Model Name	X24P1
Temperature	25°C	Relative Humidity	58%
Test Voltage	AC 230V/50Hz		
Test Mode	HDMI 1920*1080/60Hz		

50Hz

Test Mode	Test Level	Antenna aspect	Duration (s)	Criteria	Results	Judgment
Enclosure	1 A/m	X	60	A	A	PASS
Enclosure	1 A/m	Y	60	A	A	PASS
Enclosure	1 A/m	Z	60	A	A	PASS

60Hz

Test Mode	Test Level	Antenna aspect	Duration (s)	Criteria	Results	Judgment
Enclosure	1 A/m	X	60	A	A	PASS
Enclosure	1 A/m	Y	60	A	A	PASS
Enclosure	1 A/m	Z	60	A	A	PASS

Note:

- 1). N/A - denotes test is not applicable in this test report.
- 2) Criterion A: No observation of any performance degradation.
- 3) Criterion B: Some degradation of performance is observed but the equipment continues to operate as intended.
- 4) Criterion C: Loss of functionality, but self-recoverable by user, without loss of information or settings.

8.9 VOLTAGE DIPS, SHORT INTERRUPTIONS AND VOLTAGE VARIATIONS IMMUNITY TEST

8.9.1 TEST SPECIFICATION

Basic Standard	EN 61000-4-11
Required Performance	B (For >95% Voltage Dips) C (For 30% Voltage Dips) C (For >95% Voltage Interruptions)
Test Duration Time	Minimum three test events in sequence
Interval between Event	Minimum ten seconds
Phase Angle	0°/180°
Test Cycle	3 times

8.9.2 MEASUREMENT INSTRUMENTS

Item	Kind of Equipment	Manufacturer	Type No.	Serial No.	Calibrated until
1	THE MODULAR SOLUTION FOR 6 KV APPLICATIONS	Teseq	NSG 3060	1423	Aug. 20, 2018
2	Measurement Software	Teseq	Win 3000 Version 1.2.0	N/A	N/A

Remark: "N/A" denotes no model name, no serial No. or no calibration specified.

All calibration period of equipment list is one year.

8.9.3 TEST PROCEDURE

The EUT shall be tested for each selected combination of test levels and duration with a sequence of three dips/interruptions with intervals of 10 s minimum (between each test event). Each representative mode of operation shall be tested. Abrupt changes in supply voltage shall occur at zero crossings of the voltage waveform.

8.9.4 DEVIATION FROM TEST STANDARD

No deviation

8.9.5 TEST SETUP

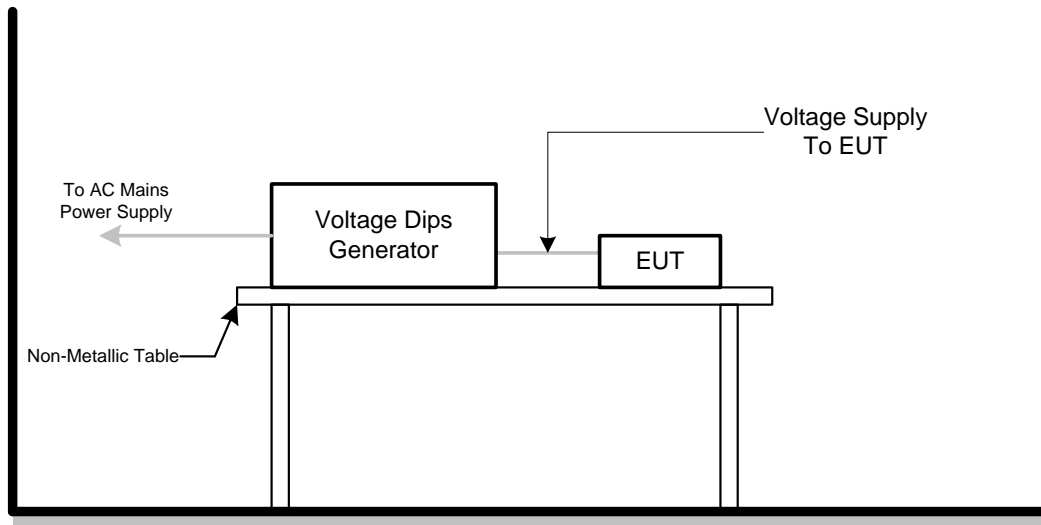

8.9.6 TEST RESULTS

EUT	LCD Monitor	Model Name	X24P1
Temperature	25°C	Relative Humidity	53%
Test Voltage	AC 100V/50Hz, AC 230V/50Hz, AC 240V/50Hz		
Test Mode	HDMI 1920*1080/60Hz		

AC 100V/50Hz				
Voltage Reduction	Periods	Criteria	Results	Judgment
Voltage dip > 95%	0.5	B	A	PASS
Voltage dip 30%	25	C	A	PASS
Interruption > 95%	250	C	C	PASS

AC 230V/50Hz				
Voltage Reduction	Periods	Criteria	Results	Judgment
Voltage dip > 95%	0.5	B	A	PASS
Voltage dip 30%	25	C	A	PASS
Interruption > 95%	250	C	C	PASS

AC 240V/50Hz				
Voltage Reduction	Periods	Criteria	Results	Judgment
Voltage dip > 95%	0.5	B	A	PASS
Voltage dip 30%	25	C	A	PASS
Interruption > 95%	250	C	C	PASS

Note:

- 1). N/A - denotes test is not applicable in this test report.
- 2) Criterion A: No observation of any performance degradation.
- 3) Criterion B: Some degradation of performance is observed but the equipment continues to operate as intended.
- 4) Criterion C: Loss of functionality, but self-recoverable by user, without loss of information or settings.

9. EUT TEST PHOTO

EN 55032:2012+AC:2013 & 2015

Radiated emissions up to 1 GHz

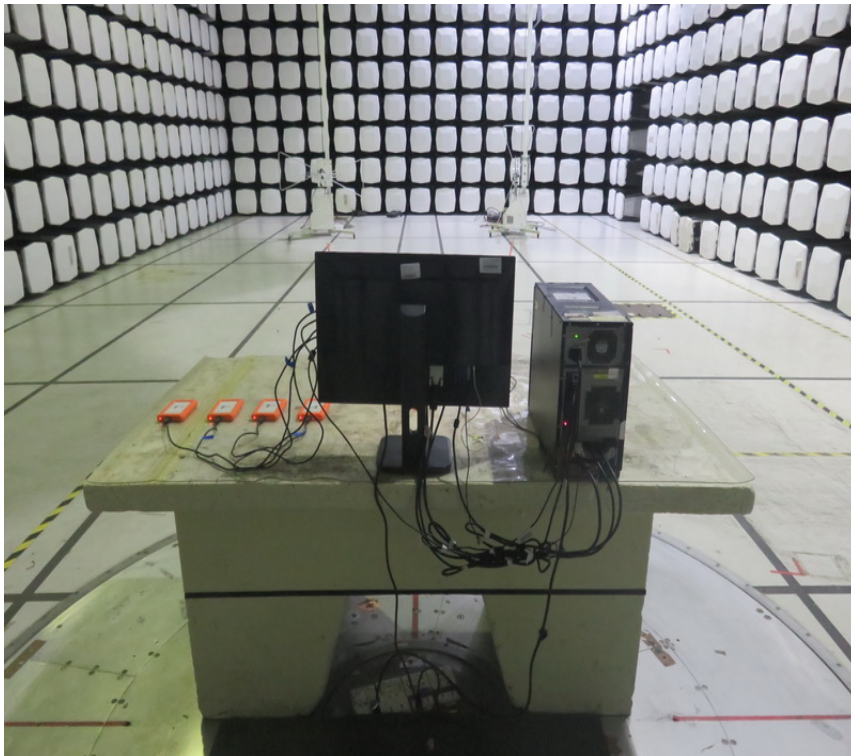

Radiated emissions above 1 GHz

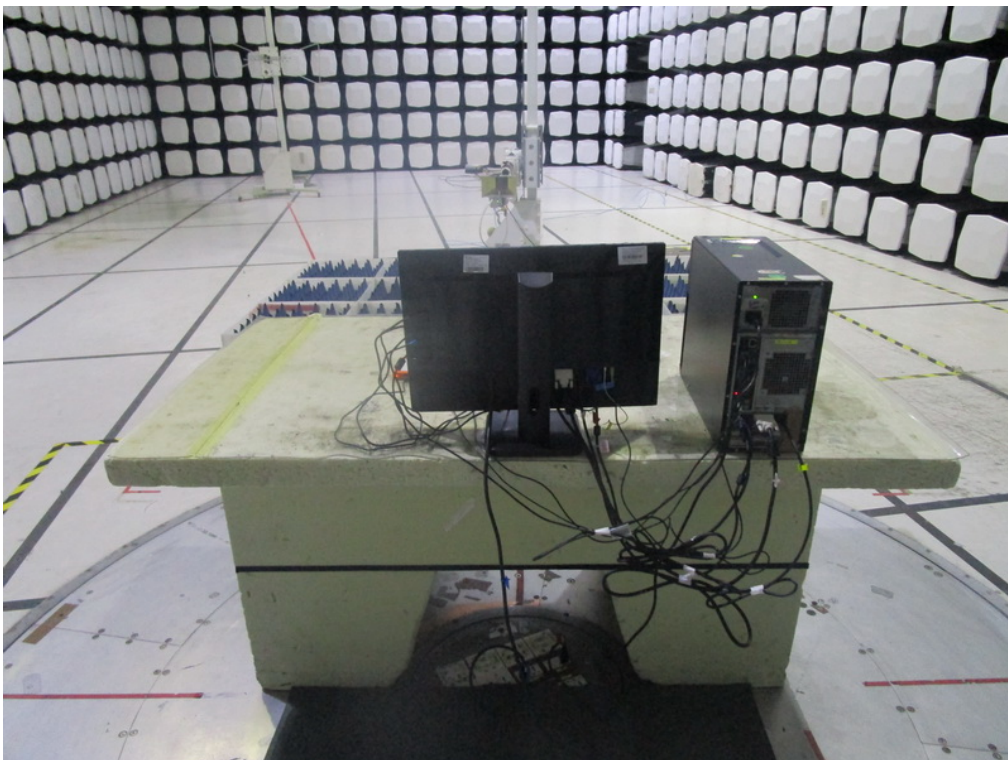
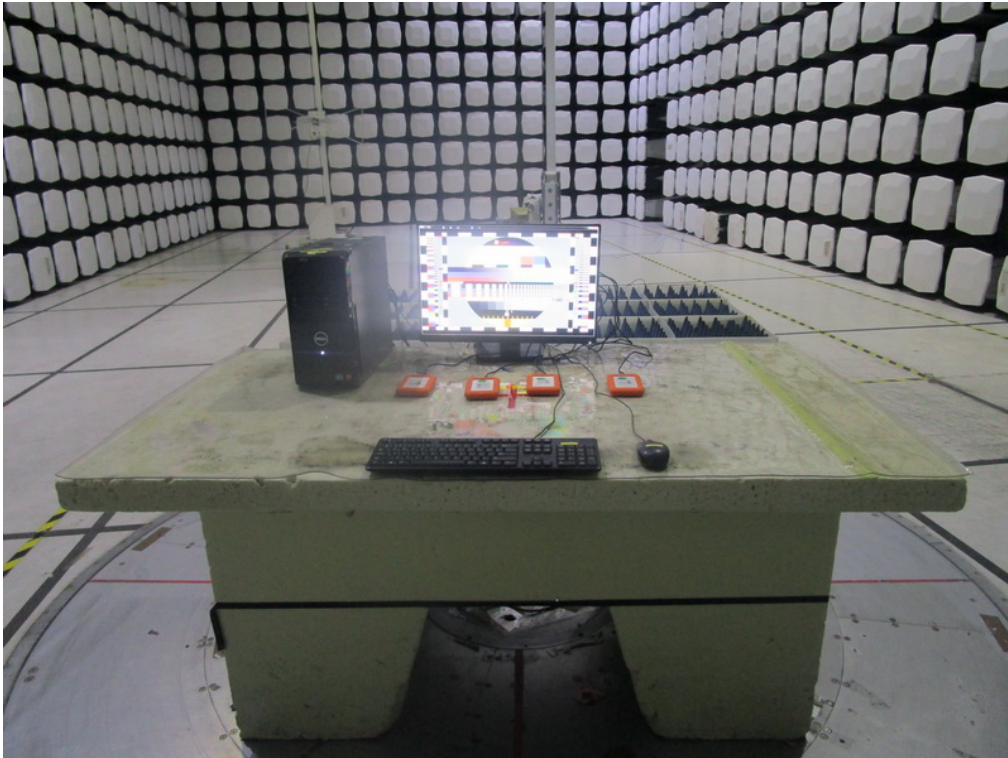

Conducted emissions AC mains power port

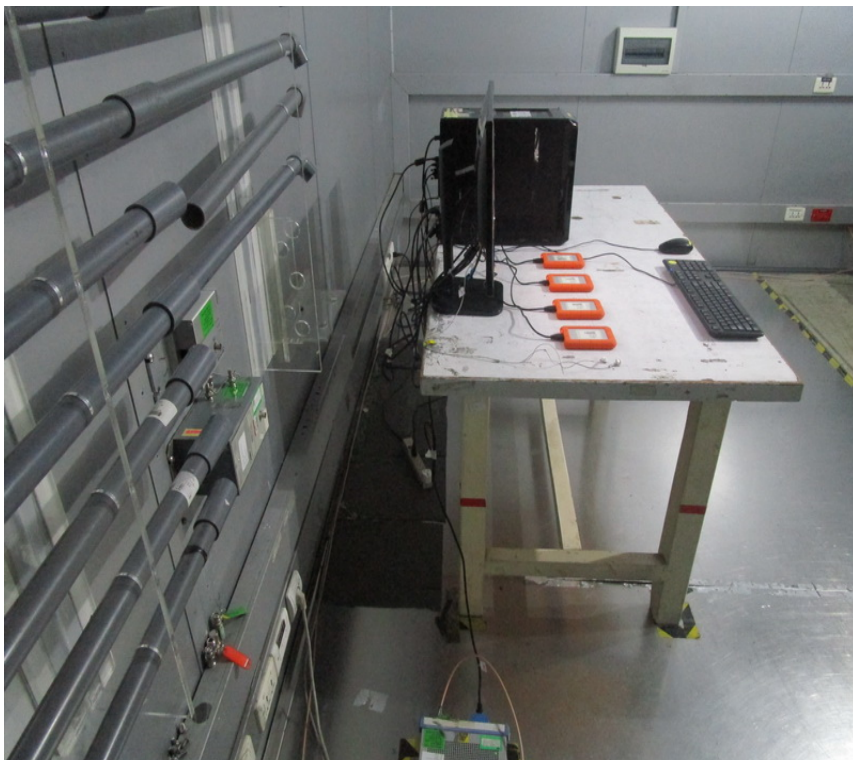

Harmonic current emissions



Voltage changes, voltage fluctuations and flicker



EN 55032:2015+AC:2016
Radiated emissions up to 1 GHz

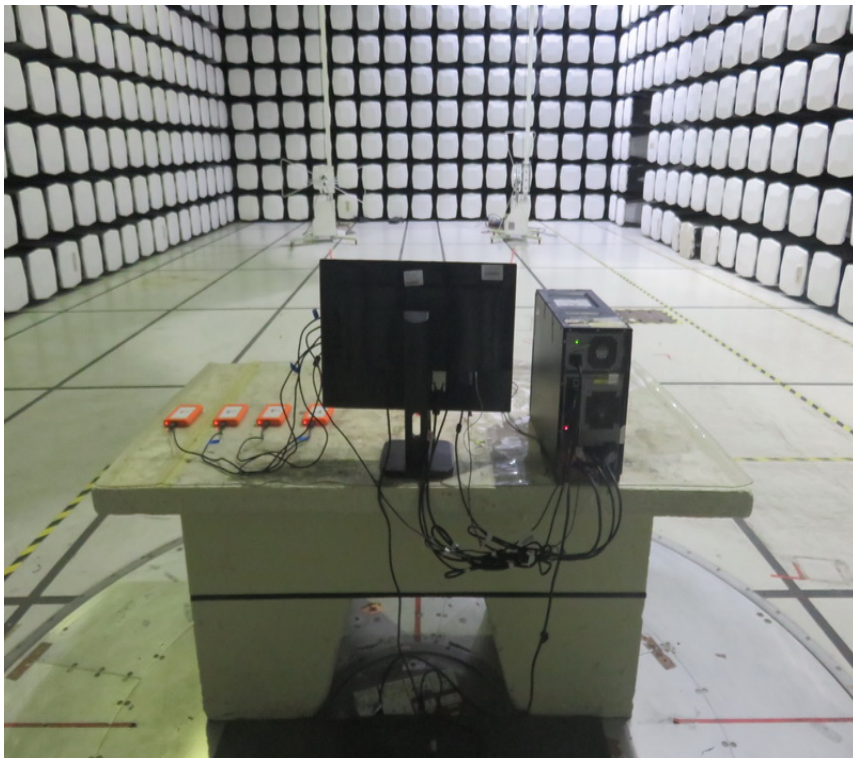
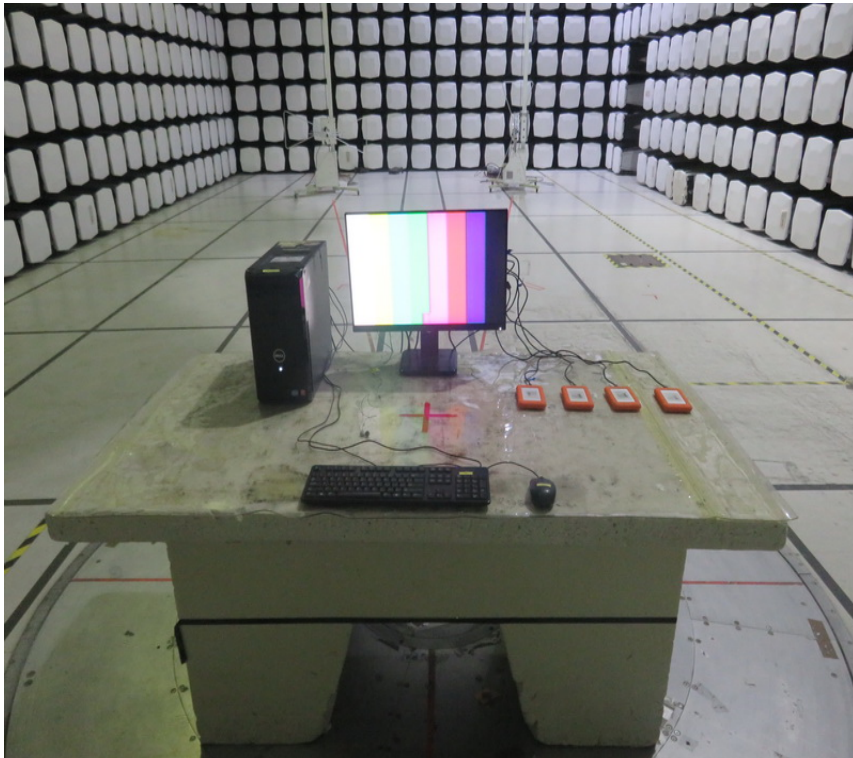

Radiated emissions above 1 GHz

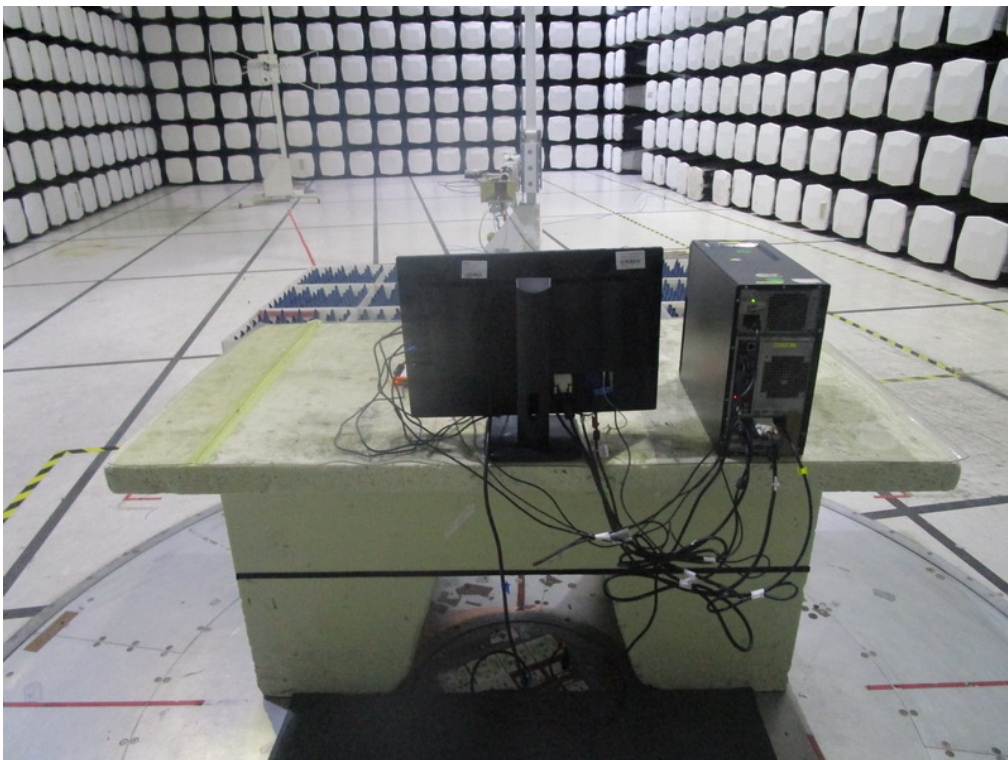
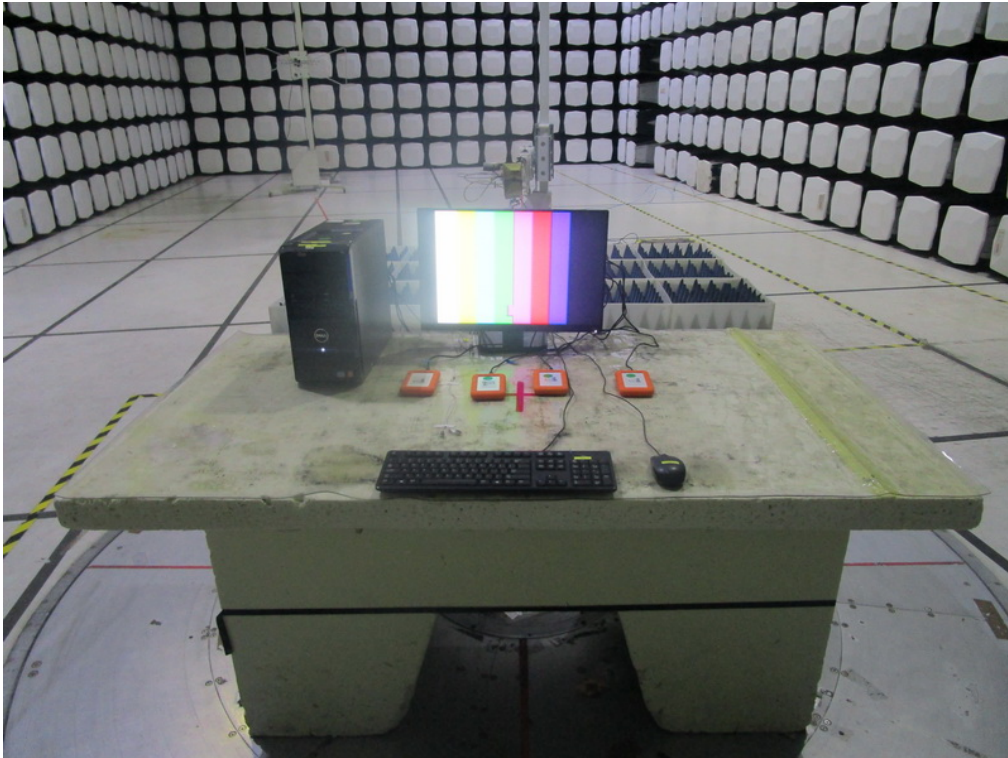

Conducted emissions AC mains power port



Harmonic current emissions



Voltage changes, voltage fluctuations and flicker



Electrostatic discharge immunity



Radiated, radio-frequency, electromagnetic field immunity

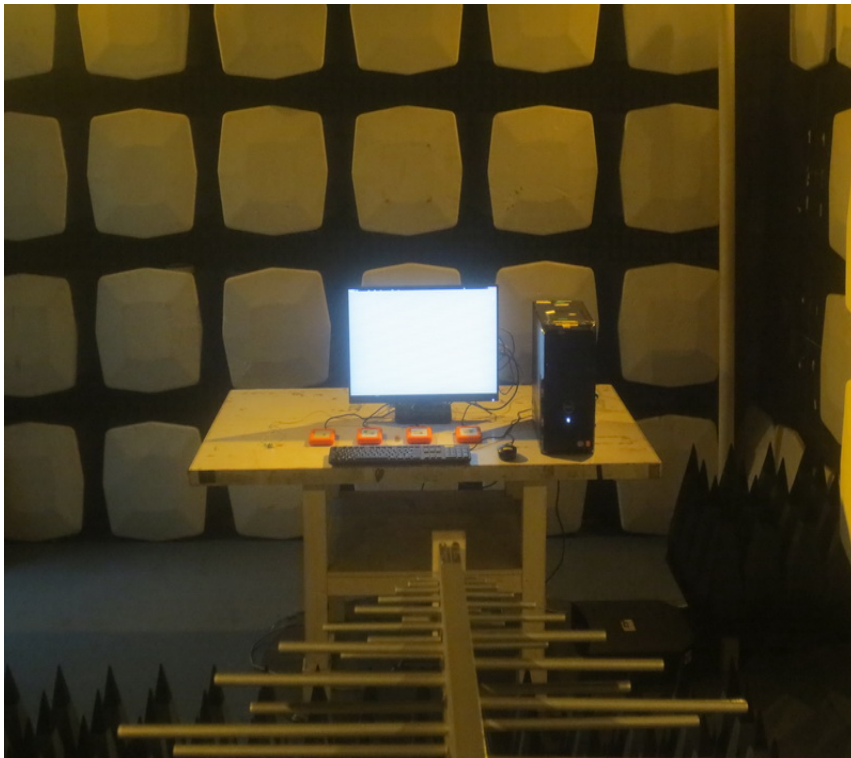

Electrical fast transient/burst immunity



Surge immunity



Immunity to conducted disturbances, induced by radio-frequency fields



Power frequency magnetic field immunity



Voltage dips, short interruptions and voltage variations immunity

