

CE&UKCA EMC Test Report

Project No. : 2012C231B
Equipment : LCD Monitor
Brand Name : N/A
Test Model : **34G3*****(*=0-9,A-Z,a-z,+,-,/,\ or blank)
Series Model : **34E2*****(*=0-9,A-Z,a-z,+,-,/,\ or blank)
Applicant : TPV Electronics (Fujian) Co., Ltd.
Address : Rongqiao Economic and Technological Development Zone, Fuqing City, Fujian Province, P.R. China
Date of Receipt : Jul. 11, 2022
Date of Test : Jul. 14, 2022 ~ Aug. 03, 2022
Issued Date : Aug. 23, 2022
Report Version : R00
Test Sample : Engineering Sample No.: DG2022071233
Standard(s) : Please refer to Page 2.

The above equipment has been tested and found compliance with the requirement of the relative standards by BTL Inc.

Derek Tong

Prepared by : Derek Tong

Kang Zhang

Approved by : Kang Zhang



TESTING CERT #5123.02

BTL Inc.

No. 3 Jinshagang 1st Rd. Shixia, Dalang Town Dongguan City, Guangdong 523792 People's Republic of China.

Tel: +86-769-8318-3000 Web: www.newbtl.com Service mail: btl_qa@newbtl.com

Standard(s) : EN 55032:2015, Class B
EN 55032:2015+A11:2020, Class B
EN 55032:2015+A1:2020, Class B
CISPR 32:2015 / CISPR 32:2015+AMD1:2019
AS/NZS CISPR 32:2015 / AS/NZS CISPR 32:2015+AMD1:2020
EN 61000-3-2:2014 / IEC 61000-3-2:2013, Class D
EN IEC 61000-3-2:2019 / IEC 61000-3-2:2018, Class D
EN IEC 61000-3-2:2019+A1:2021, Class D
EN 61000-3-3:2013/IEC 61000-3-3:2013
EN 61000-3-3:2013+A1:2019/IEC 61000-3-3:2013+AMD1:2017
EN 55035:2017/CISPR 35:2016
EN 55035:2017+A11:2020

BS EN 55032:2015, Class B
BS EN 55032:2015+A1:2020, Class B
BS EN IEC 61000-3-2:2019+A1:2021, Class D
BS EN 61000-3-3:2013+A1:2019
BS EN 55035:2017+A11:2020

Declaration

BTL represents to the client that testing is done in accordance with standard procedures as applicable and that test instruments used has been calibrated with standards traceable to international standard(s) and/or national standard(s).

BTL's reports apply only to the specific samples tested under conditions. It is manufacture's responsibility to ensure that additional production units of this model are manufactured with the identical electrical and mechanical components. **BTL** shall have no liability for any declarations, inferences or generalizations drawn by the client or others from **BTL** issued reports.

The report must not be used by the client to claim product certification, approval, or endorsement by NVLAP, NIST, A2LA, or any agency of the U.S. Government.

This report is the confidential property of the client. As a mutual protection to the clients, the public and ourselves, the test report shall not be reproduced, except in full, without our written approval.

BTL's laboratory quality assurance procedures are in compliance with the **ISO/IEC 17025** requirements, and accredited by the conformity assessment authorities listed in this test report.

BTL is not responsible for the sampling stage, so the results only apply to the sample as received.

The information, data and test plan are provided by manufacturer which may affect the validity of results, so it is manufacturer's responsibility to ensure that the apparatus meets the essential requirements of applied standards and in all the possible configurations as representative of its intended use.

Limitation

For the use of the authority's logo is limited unless the Test Standard(s)/Scope(s)/Item(s) mentioned in this test report is (are) included in the conformity assessment authorities acceptance respective.

Please note that the measurement uncertainty is provided for informational purpose only and are not use in determining the Pass/Fail results.

Table of Contents	Page
REPORT ISSUED HISTORY	8
1 . SUMMARY OF TEST RESULTS	9
1.1 TEST FACILITY	11
1.2 MEASUREMENT UNCERTAINTY	11
1.3 TEST ENVIRONMENT CONDITIONS	13
2 . GENERAL INFORMATION	14
2.1 GENERAL DESCRIPTION OF EUT	14
2.2 DESCRIPTION OF TEST MODES	15
2.3 EUT OPERATING CONDITIONS	16
2.4 BLOCK DIAGRAM SHOWING THE CONFIGURATION OF SYSTEM TESTED	16
2.5 DESCRIPTION OF SUPPORT UNITS	17
3 . EMC EMISSION TEST- EN 55032:2015	18
3.1 RADIATED EMISSION UP TO 1 GHZ	18
3.1.1 LIMITS	18
3.1.2 MEASUREMENT INSTRUMENTS LIST	18
3.1.3 TEST PROCEDURE	19
3.1.4 DEVIATION FROM TEST STANDARD	19
3.1.5 TEST SETUP	19
3.1.6 MEASUREMENT DISTANCE	20
3.1.7 TEST RESULTS (UP TO 1 GHZ)	21
3.2 RADIATED EMISSION ABOVE 1 GHZ	23
3.2.1 LIMITS	23
3.2.2 MEASUREMENT INSTRUMENTS LIST	23
3.2.3 TEST PROCEDURE	24
3.2.4 DEVIATION FROM TEST STANDARD	24
3.2.5 TEST SETUP	24
3.2.6 MEASUREMENT DISTANCE	25
3.2.7 TEST RESULTS (ABOVE 1 GHZ)	26
3.3 CONDUCTED EMISSION MEASUREMENT AT AC MAINS POWER PORTS	28
3.3.1 LIMITS	28
3.3.2 MEASUREMENT INSTRUMENTS LIST	28
3.3.3 TEST PROCEDURE	28
3.3.4 DEVIATION FROM TEST STANDARD	28
3.3.5 TEST SETUP	28
3.3.6 TEST RESULTS	30
4 . EMC EMISSION TEST- EN 55032:2015+A11:2020/EN 55032:2015+A1:202032	
4.1 RADIATED EMISSIONS UP TO 1 GHZ	32

Table of Contents	Page
4.1.1 LIMITS	32
4.1.2 MEASUREMENT INSTRUMENTS LIST	32
4.1.3 TEST PROCEDURE	33
4.1.4 DEVIATION FROM TEST STANDARD	33
4.1.5 TEST SETUP	33
4.1.6 MEASUREMENT DISTANCE	34
4.1.7 TEST RESULTS (UP TO 1 GHZ)	35
4.2 RADIATED EMISSIONS ABOVE 1 GHZ	41
4.2.1 LIMITS	41
4.2.1 MEASUREMENT INSTRUMENTS LIST	42
4.2.1.1 TEST PROCEDURE	42
4.2.1.2 DEVIATION FROM TEST STANDARD	42
4.2.1.3 TEST SETUP	43
4.2.1.4 MEASUREMENT DISTANCE	44
4.2.1.5 TEST RESULTS (ABOVE 1 GHZ)	45
4.3 CONDUCTED EMISSION MEASUREMENT AT AC MAINS POWER PORTS	53
4.3.1 LIMITS	53
4.3.2 MEASUREMENT INSTRUMENTS LIST	53
4.3.3 TEST PROCEDURE	53
4.3.4 TEST SETUP	54
4.3.5 TEST RESULTS	55
5 . HARMONIC AND FLICKER TEST	59
5.1 HARMONIC CURRENT EMISSIONS	59
5.1.1 LIMITS	59
5.1.2 MEASUREMENT INSTRUMENTS LIST	59
5.1.3 TEST PROCEDURE	59
5.1.4 DEVIATION FROM TEST STANDARD	59
5.1.5 TEST SETUP	59
5.1.6 TEST RESULTS	60
5.2 VOLTAGE CHANGES, VOLTAGE FLUCTUATIONS AND FLICKER TEST	63
5.2.1 LIMITS	63
5.2.2 MEASUREMENT INSTRUMENTS LIST	63
5.2.3 TEST PROCEDURE	63
5.2.4 DEVIATION FROM TEST STANDARD	63
5.2.5 TEST SETUP	64
5.2.6 TEST RESULTS	65
6 . EMC IMMUNITY TEST	66
6.1 STANDARD COMPLIANCE/SEVERITY LEVEL/CRITERIA	66
6.2 GENERAL PERFORMANCE CRITERIA	69
6.3 ANNEX D (NORMATIVE) - DISPLAY AND DISPLAY OUTPUT FUNCTION	70
6.3.1 PERFORMANCE CRITERIA	70

Table of Contents	Page
6.4 ANNEX G (NORMATIVE) - AUDIO OUTPUT FUNCTION	71
6.4.1 PERFORMANCE CRITERIA	71
6.5 ELECTROSTATIC DISCHARGE IMMUNITY TEST (ESD)	72
6.5.1 TEST SPECIFICATION	72
6.5.2 MEASUREMENT INSTRUMENTS	72
6.5.3 TEST PROCEDURE	72
6.5.4 DEVIATION FROM TEST STANDARD	73
6.5.5 TEST SETUP	73
6.5.6 TEST RESULTS	74
6.6 RADIATED, RADIO-FREQUENCY, ELECTROMAGNETIC FIELD IMMUNITY TEST (RS)	78
6.6.1 TEST SPECIFICATION	78
6.6.2 MEASUREMENT INSTRUMENTS	78
6.6.3 TEST PROCEDURE	78
6.6.4 DEVIATION FROM TEST STANDARD	79
6.6.5 TEST SETUP	79
6.6.6 TEST RESULTS	81
6.7 ELECTRICAL FAST TRANSIENT/BURST IMMUNITY TEST (EFT/BURST)	84
6.7.1 TEST SPECIFICATION	84
6.7.2 MEASUREMENT INSTRUMENTS	84
6.7.3 TEST PROCEDURE	84
6.7.4 DEVIATION FROM TEST STANDARD	84
6.7.5 TEST SETUP	85
6.7.6 TEST RESULTS	86
6.8 SURGE IMMUNITY TEST	87
6.8.1 TEST SPECIFICATION	87
6.8.2 MEASUREMENT INSTRUMENTS	87
6.8.3 TEST PROCEDURE	87
6.8.4 DEVIATION FROM TEST STANDARD	88
6.8.5 TEST SETUP	88
6.8.6 TEST RESULTS	89
6.9 IMMUNITY TO CONDUCTED DISTURBANCES, INDUCED BY RADIO-FREQUENCY FIELDS TEST (CS)	90
6.9.1 TEST SPECIFICATION	90
6.9.2 MEASUREMENT INSTRUMENTS	90
6.9.3 TEST PROCEDURE	90
6.9.4 DEVIATION FROM TEST STANDARD	91
6.9.5 TEST SETUP	91
6.9.6 TEST RESULTS	93
6.10 POWER FREQUENCY MAGNETIC FIELD IMMUNITY TEST (PFMF)	95
6.10.1 TEST SPECIFICATION	95
6.10.2 MEASUREMENT INSTRUMENTS	95
6.10.3 TEST PROCEDURE	95

Table of Contents	Page
6.10.4 DEVIATION FROM TEST STANDARD	95
6.10.5 TEST SETUP	96
6.10.6 TEST RESULTS	97
6.11 VOLTAGE DIPS, SHORT INTERRUPTIONS AND VOLTAGE VARIATIONS IMMUNITY	
TEST (DIPS)	98
6.11.1 TEST SPECIFICATION	98
6.11.2 MEASUREMENT INSTRUMENTS	98
6.11.3 TEST PROCEDURE	98
6.11.4 DEVIATION FROM TEST STANDARD	98
6.11.5 TEST SETUP	99
6.11.6 TEST RESULTS	100
7 . EUT TEST PHOTO	101

REPORT ISSUED HISTORY

Report No.	Version	Description	Issued Date	Note
BTL-EMC-1-2012C231B	R00	Compared with original report (BTL-EMC-1-2012C231A), 1. Added the series model. 2. Added the new base(Type B) for the new model, with the same height and material as the original base. 3. Added a mainboard (model: 715GD177) and powerboard (model:715GA864), so the EMI& Harmonic current&Flicker used the original worst case to tested, the EMS have been re-evaluated and recorded in the test report. In this report only recorded the test results of the new test results.The original test results please refer to original report.	Aug. 23, 2022	Valid

1. SUMMARY OF TEST RESULTS

Test procedures according to the technical standards:

Emission			
Standard(s)	Test Item	Result	
EN 55032:2015 EN 55032:2015+A11:2020 EN 55032:2015+A1:2020 CISPR 32:2015 CISPR 32:2015+AMD1:2019 AS/NZS CISPR 32:2015 AS/NZS CISPR 32:2015+AMD1:2020 BS EN 55032:2015 BS EN 55032:2015+A1:2020	Radiated emissions up to 1 GHz	PASS	
	Radiated emissions above 1 GHz	PASS	
	Radiated emissions from FM receivers	N/A	
	Conducted emissions AC mains power port	PASS	
	Asymmetric mode conducted emissions	AAN	N/A
		Current Probe	N/A
		CP+CVP	N/A
	Conducted differential voltage emissions	N/A	

Standard(s)	Test Item	Result
EN 61000-3-2:2014 IEC 61000-3-2:2013 EN IEC 61000-3-2:2019 IEC 61000-3-2:2018 EN IEC 61000-3-2:2019+A1:2021 BS EN IEC 61000-3-2:2019+A1:2021	Harmonic current	PASS
EN 61000-3-3:2013 IEC 61000-3-3:2013 EN 61000-3-3:2013+A1:2019 IEC 61000-3-3:2013+AMD1:2017 BS EN 61000-3-3:2013+A1:2019	Voltage fluctuations (Flicker)	PASS

Immunity			
Standard(s)	Ref Standard(s)	Test Item	Result
EN 55035:2017/CISPR 35:2016 EN 55035:2017+A11:2020 BS EN 55035:2017+A11:2020 EN 55024:2010+A1:2015 BS EN 55024:2010+A1:2015	IEC 61000-4-2:2008 EN 61000-4-2:2009	ESD	PASS
	IEC 61000-4-3:2020 EN IEC 61000-4-3:2020	RS	PASS
	IEC 61000-4-4:2012 EN 61000-4-4:2012	EFT	PASS
	IEC 61000-4-5:2014+AMD1:2017 EN 61000-4-5:2014+A1:2017	Surge	PASS
	IEC 61000-4-6:2013 EN 61000-4-6:2014+AC:2015	CS	PASS
	IEC 61000-4-8:2009 EN 61000-4-8:2010	PFMF	PASS
	IEC 61000-4-11:2020 EN IEC 61000-4-11:2020	Dips	PASS

Standard(s)	Ref Standard(s)	Test Item	Result
EN 55035:2017/CISPR 35:2016 EN 55035:2017+A11:2020 BS EN 55035:2017+A11:2020	4.2.7	Broadband impulse noise disturbances, repetitive	N/A
	4.2.7	Broadband impulse noise disturbances, isolated	N/A

NOTE:

- (1) "N/A" denotes test is not applicable to this device.

1.1 TEST FACILITY

The test facilities used to collect the test data in this report is at the location of No. 3 Jinshagang 1st Rd. Shixia, Dalang Town Dongguan City, Guangdong 523792 People's Republic of China.

1.2 MEASUREMENT UNCERTAINTY

Where relevant, the following measurement uncertainty levels have been estimated for tests performed on the EUT as specified in CISPR 16-4-2, The BTL measurement uncertainty is less than the CISPR 16-4-2 U_{cispr} requirement.

The reported uncertainty of measurement $y \pm U$, where expanded uncertainty U is based on a standard uncertainty multiplied by a coverage factor of $k=2$, providing a level of confidence of approximately **95%**.

A. Radiated emissions up to 1 GHz measurement:

Test Site	Method	Measurement Frequency Range	Ant. H / V	U,(dB)
DG-CB08 (10m)	CISPR	30MHz ~ 200MHz	V	4.72
		30MHz ~ 200MHz	H	4.40
		200MHz ~ 1,000MHz	V	4.58
		200MHz ~ 1,000MHz	H	3.70

B. Radiated emissions above 1 GHz measurement:

Test Site	Method	Measurement Frequency Range	U,(dB)
DG-CB08 (3m)	CISPR	1GHz ~ 6GHz	3.94

C. Conducted emissions AC mains power port measurement:

Test Site	Method	Measurement Frequency Range	U,(dB)
DG-C02	CISPR	150kHz ~ 30MHz	2.60

D. Harmonic/ Flicker Measurement:

Test Site	Method	Item	U (%)
DG-C01	EN 61000-3-2	Current	0.593
	EN 61000-3-3	Voltage	0.595

E. Immunity Measurement:

Test Site	Method	Item	U
DG-SR02	IEC 61000-4-2	Rise time tr	6.30%
		Peak current Ip	6.70%
		Current at 30 ns	6.40%
		Current at 60 ns	6.90%
DG-CB05	IEC 61000-4-3 (80MHz~6GHz)	Electromagnetic field immunity test	2.00dB
		On-ear acoustic & Acoustic measurements on loudspeakers	2.00dB
		Electrical measurements	2.00dB
DG-SR05	IEC 61000-4-4	Peak voltage (VP)	3.8%
		Rise time (tr)	4.4%
		Pulse width(tw)	4.2%
		Pulse Freq.(kHz)	0.7%
		Burst Duration(ms)	1.5%
		Burst Period(ms)	1.4%
DG-SR05	IEC 61000-4-5	Open-Circuit Output Voltage (1.2/50us)	4.0%
		Open circuit front time (1.2/50us)	6.2%
		Open circuit time of half value (1.2/50us)	4.8%
DG-CB06	IEC 61000-4-6 (150kHz-80MHz)	CDN	1.32dB
		EM clamp	3.14dB
		On-ear acoustic & Acoustic measurements on loudspeakers	1.34dB
		Electrical measurements	1.32dB
DG-SR05	IEC 61000-4-8	Magnetic Field Strength	2.38%
DG-SR01	IEC 61000-4-11	DIP Amplitude	3.6%
		DIP Time Event	4.0%

Note: Unless specifically mentioned, the uncertainty of measurement has not been taken into account to declare the compliance or non-compliance to the specification.

1.3 TEST ENVIRONMENT CONDITIONS

Test Item	Temperature	Humidity	Tested By
Radiated emissions up to 1 GHz	26°C	50%	Larry Yuan
Radiated emissions above 1 GHz	26°C	50%	Larry Yuan
Conducted emissions AC mains power port	23°C	51%	Eli Chen
Harmonic current	22°C	55%	Eli Chen
Voltage fluctuations (Flicker)	22°C	55%	Eli Chen

Test Item	Temperature	Humidity	Pressure	Tested By
ESD	23°C	53%	1017hPa	Cole Chen
RS	24-25°C	47-50%	/	Robert Luo
EFT	25°C	55%	/	Wade Liang
Surge	25°C	55%	/	Wade Liang
CS	28°C	40%	/	Jayce Yao
PFMF	25°C	55%	/	Wade Liang
Dips	24°C	48%	/	Karl Wu

2. GENERAL INFORMATION

2.1 GENERAL DESCRIPTION OF EUT

Equipment	LCD Monitor
Brand Name	N/A
Test Model	**34G3*****(*=0-9,A-Z,a-z,+,-,/,\ or blank)
Series Model	**34E2*****(*=0-9,A-Z,a-z,+,-,/,\ or blank)
Model Difference(s)	Only differ in model name, mainboard and power board due to marketing purpose.
Power Source	AC Mains.
Power Rating	100-240V ~ 50-60Hz
Connecting I/O Port(s)	Mainboard: 715GA661 1* AC port 1* Earphone port 2* DP port 2* HDMI port 5* USB port Mainboard: 715GD177 1* AC port 1* Earphone port 1* DP port 2* HDMI port
Classification Of EUT	Class B
Highest Internal Frequency(Fx)	600MHz

Cable Type	Shielded Type	Ferrite Core	Length(m)	Note
AC Power Cord	Non-shielded	NO	1.8/1.5	1.8m is worst case Detachable
HDMI	Shielded	NO	1.8/1.5	-
DP	Shielded	NO	1.8/1.5	-
USB (Mainboard:715GA661)	Shielded	NO	1.8/1.5	-

Note:

- For a more detailed features description, please refer to the manufacturer's specifications or the user's manual.
- Power cable 1.8m, 1.5m length, worst case is Power cable 1.8m with HDMI+DP length testing and recording in test report.

2.2 DESCRIPTION OF TEST MODES

To investigate the maximum EMI emission characteristics generates from EUT, the test system was pre-scanning tested base on the consideration of following EUT operation mode or test configuration mode which possible have effect on EMI emission level. Each of these EUT operation mode(s) or test configuration mode(s) mentioned above was evaluated respectively.

Pretest Mode	Description
Mode 1	HDMI1 3440*1440/100Hz 1.8m
Mode 2	HDMI2 3440*1440/100Hz 1.8m
Mode 3	DP 3440*1440/100Hz 1.8m
Mode 4	HDMI1 1080P 1.8m
Mode 5	HDMI1 3440*1440/100Hz 1.5m
Mode 6	HDMI1 3440*1440/100Hz 1.8m(without earphone)

Radiated emissions up to 1 GHz test	
Final Test Mode	Description
Mode 1	HDMI1 3440*1440/100Hz 1.8m
Mode 6	HDMI1 3440*1440/100Hz 1.8m(without earphone)

Radiated emissions above 1 GHz test	
Final Test Mode	Description
Mode 1	HDMI1 3440*1440/100Hz 1.8m
Mode 6	HDMI1 3440*1440/100Hz 1.8m(without earphone)

Conducted emissions AC mains power port test	
Final Test Mode	Description
Mode 1	HDMI1 3440*1440/100Hz 1.8m

Harmonic current & Voltage fluctuations (Flicker) Test	
Final Test Mode	Description
Mode 1	HDMI1 3440*1440/100Hz 1.8m

Immunity Test	
Final Test Mode	Description
Mode 1	HDMI1 3440*1440/100Hz 1.8m
Mode 2	HDMI2 3440*1440/100Hz 1.8m
Mode 3	DP 3440*1440/100Hz 1.8m
Mode 4	HDMI1 1080P 1.8m
Mode 5	HDMI1 3440*1440/100Hz 1.5m

Evaluation description:

1. According to the client's requirement, so the radiated emissions added and tested the without earphone mode in the test report.
2. RS Acoudtic: The Front, Rear, Left and Right were evaluated. The worst placement direction is Rear and recorded in this report.

2.3 EUT OPERATING CONDITIONS

The EUT exercise program used during radiated and/or conducted emission measurement was designed to exercise the various system components in a manner similar to a typical use. The standard test signals and output signal as following:

1. EUT connected to Earphone via Earphone cable.
2. EUT connected to PC via DP&HDMI cable.
3. Mouse and Keyboard connected to PC via USB cable.

2.4 BLOCK DIAGRAM SHOWING THE CONFIGURATION OF SYSTEM TESTED

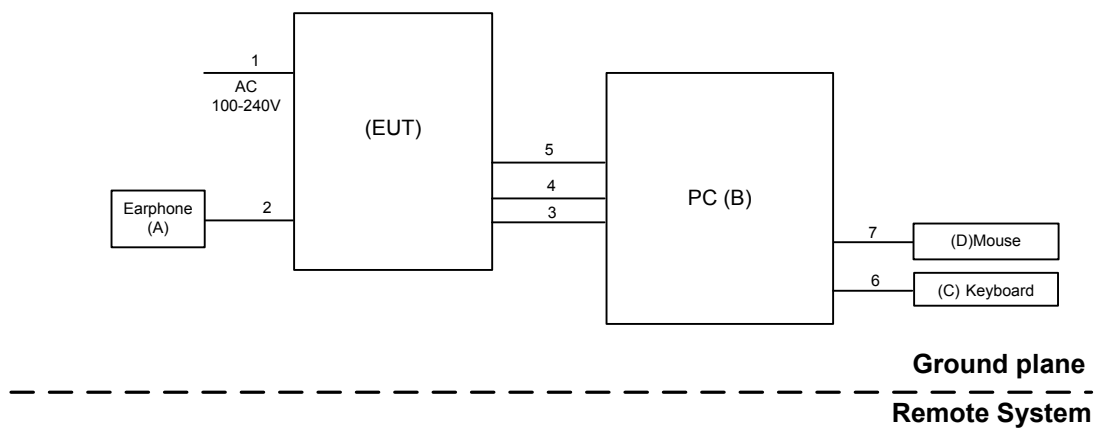

2.5 DESCRIPTION OF SUPPORT UNITS

The EUT has been tested as an independent unit together with other necessary accessories or support units. The following support units or accessories were used to form a representative test configuration during the tests.

Item	Equipment	Mfr/Brand	Model/Type No.	Series No.
A	Earphone	APPLE	N/A	N/A
B	PC	DELL	8920-D16N8S	GZS91L2
C	Keyboard	DELL	KB212-B	CN0HTXH97158125004DXA01
D	Mouse	DELL	MS111-P	CN011D3V71581279OLOT

Item	Cable Type	Shielded Type	Ferrite Core	Length
1	AC Cable	NO	NO	1.8/1.5m
2	Earphone Cable	NO	NO	1.2m
3	HDMI Cable	YES	NO	1.8/1.5/m
4	DP Cable	YES	NO	1.8/1.5/m
5	HDMI Cable	YES	NO	1.8/1.5/m
6	USB Cable	YES	NO	1.8m
7	USB Cable	YES	NO	1.8m

3. EMC EMISSION TEST- EN 55032:2015

3.1 RADIATED EMISSION UP TO 1 GHZ

3.1.1 LIMITS

Class B equipment up to 1000MHz

Frequency MHz	Measurement		Class B limit dB(uV/m)
	Distance m	Detector type/bandwidth	SAC
30-230	10	Quasi peak / 120 kHz	30
230-1000			37

Notes:

- (1) The limit for radiated test was performed according to as following: EN 55032
- (2) The tighter limit applies at the band edges.
- (3) Emission level (dBuV/m)=20log Emission level (uV/m).
- (4) The test result calculated as following:
 Measurement Value = Reading Level + Correct Factor
 Correct Factor = Antenna Factor + Cable Loss - Amplifier Gain(if use)
 Margin Level = Measurement Value - Limit Value

3.1.2 MEASUREMENT INSTRUMENTS LIST

Item	Kind of Equipment	Manufacturer	Type No.	Series Model	Calibrated until
1	Receiver	Keysight	N9038A	MY54450004	Jul. 03, 2023
2	MXE EMI Receiver	Agilent	N9038A	MY53220133	Jan. 22, 2023
3	Pre-Amplifier	EMC INSTRUMENT	EMC 9135	980284	Jul. 03, 2023
4	Pre-Amplifier	EMC INSTRUMENT	EMC 9135	980283	Jul. 03, 2023
5	Trilog-Broadband Antenna	Schwarzbeck	VULB9168	947	Oct. 19, 2022
6	Trilog-Broadband Antenna	Schwarzbeck	VULB9168	946	Sep. 11, 2022
7	Cable	emci	LMR-400 (5m+8m+8m)	N/A	Jan. 06, 2023
8	Cable	emci	LMR-400 (5m+8m+8m)	N/A	Jan. 06, 2023
9	Measurement Software	Farad	EZ-EMC Ver.BTL-2ANT-1	N/A	N/A
10	Multi-Device Controller	ETS-Lindgren	2090	N/A	N/A
11	Controller	MF	MF-7802	MF780208159	N/A
12	Attenuator	EMCI	EMCI-N-6-06	AT-N0671	Sep. 11, 2022
13	Attenuator	EMCI	EMCI-N-6-06	AT-N0670	Oct. 19, 2022

Remark: "N/A" denotes no model no., no serial no. or no calibration specified.

All calibration period of equipment list is one year.

3.1.3 TEST PROCEDURE

- a. The measuring distance of 10 m shall be used for measurements. The EUT was placed on the top of a rotating table 0.8 meter above the ground at a 10 meter semi-anechoic chamber. The table was rotated 360 degrees to determine the position of the highest radiation.
- c. The height of the equipment or of the substitution antenna shall be 0.8 m, the height of the test antenna shall vary between 1 m to 4 m. Both horizontal and vertical polarizations of the antenna are set to make the measurement.
- d. The initial step in collecting radiated emission data is a receiver peak detector mode pre-scanning the measurement frequency range. Significant peaks are then marked and then Quasi Peak detector mode re-measured.
- e. All readings are Peak unless otherwise stated QP in column of Note. Peak denotes that the Peak reading compliance with the QP Limits and then QP Mode measurement didn't perform.
- g. For the actual test configuration, please refer to the related Item - Block Diagram of system tested.

3.1.4 DEVIATION FROM TEST STANDARD

No deviation

3.1.5 TEST SETUP

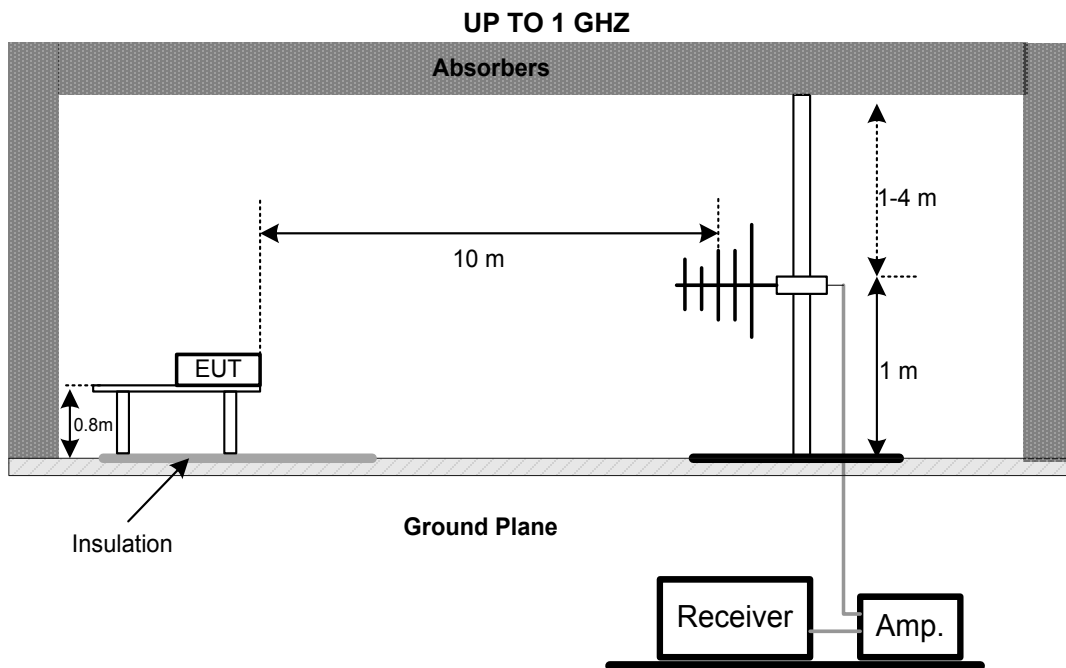

Note: The antenna can be moved between 1 to 4 meters above the ground.

3.1.6 MEASUREMENT DISTANCE

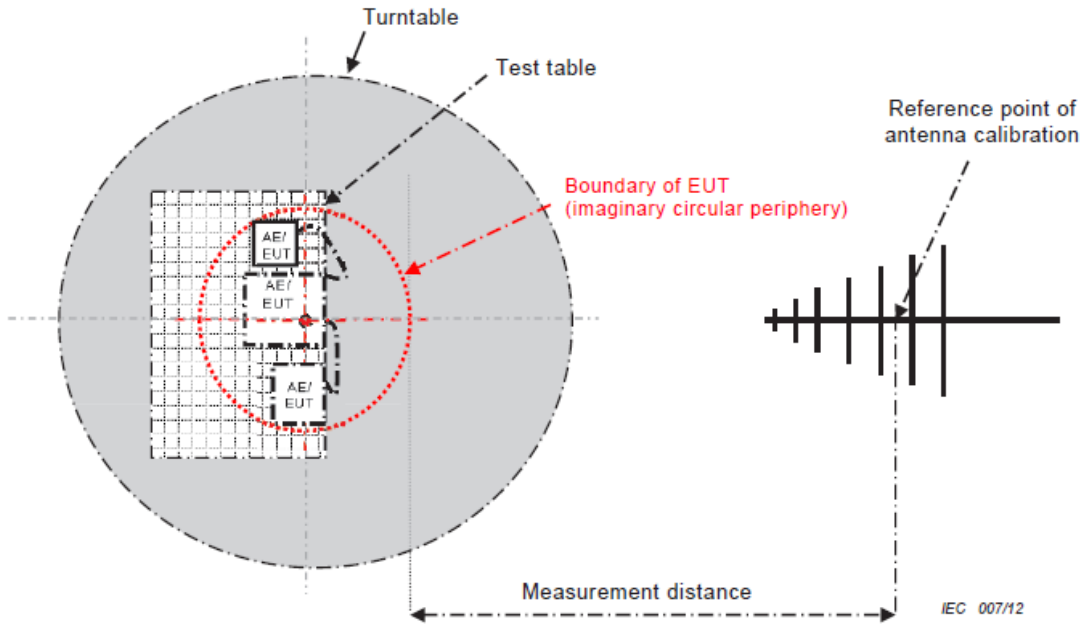

- 34 -

CISPR 32 © IEC:2012

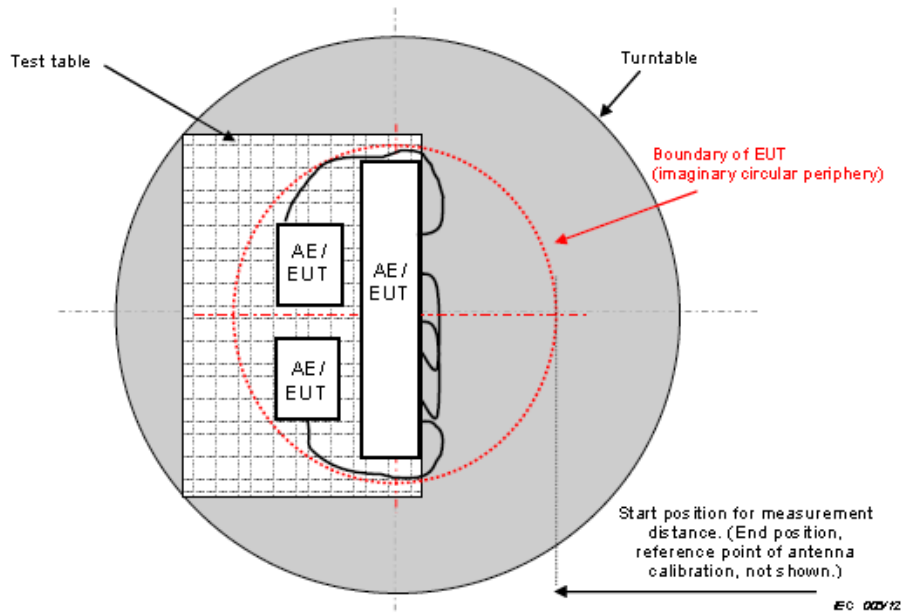
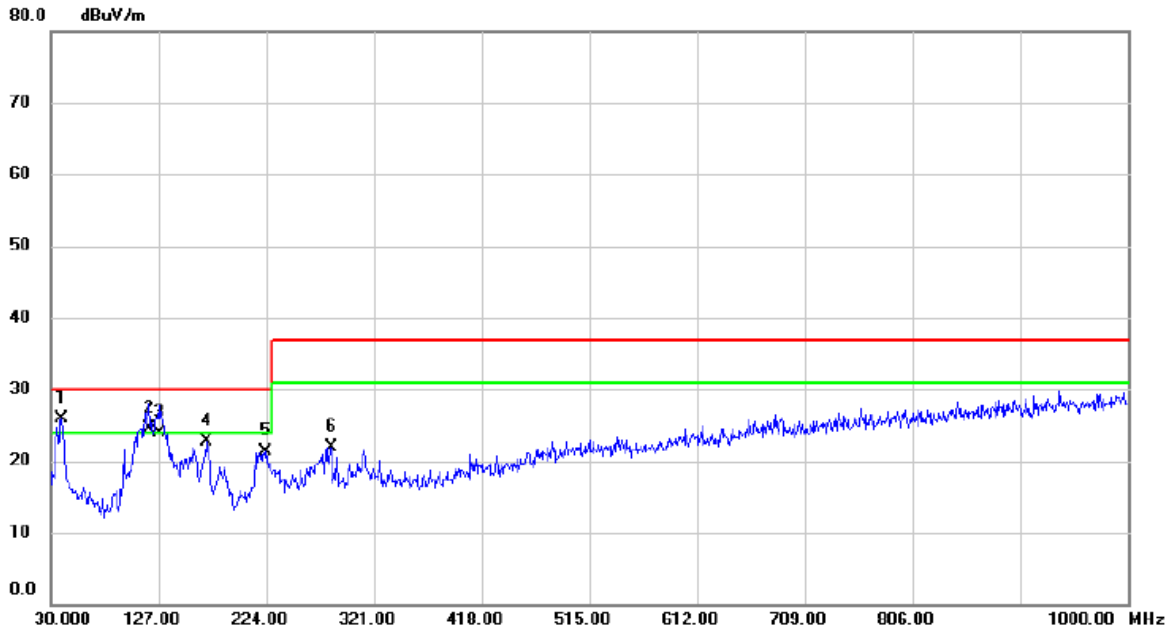

Figure C.2 – Boundary of EUT, Local AE and associated cabling

3.1.7 TEST RESULTS (UP TO 1 GHZ)

Test Voltage	AC 230V/50Hz	Polarization	Vertical
Test Voltage	Mode 1		



No.	Mk.	Freq. MHz	Reading Level dBuV	Correct Factor dB	Measure- ment dBuV/m	Limit dBuV/m	Margin dB	Detector	Comment
1	*	39.7000	43.64	-17.73	25.91	30.00	-4.09	QP	
2	!	118.2700	42.90	-18.39	24.51	30.00	-5.49	QP	
3		127.0000	41.65	-17.76	23.89	30.00	-6.11	QP	
4		169.6800	39.06	-16.40	22.66	30.00	-7.34	QP	
5		223.0300	40.04	-18.70	21.34	30.00	-8.66	QP	
6		282.2000	37.26	-15.34	21.92	37.00	-15.08	QP	

Test Voltage	AC 230V/50Hz	Polarization	Horizontal
Test Voltage	Mode 1		

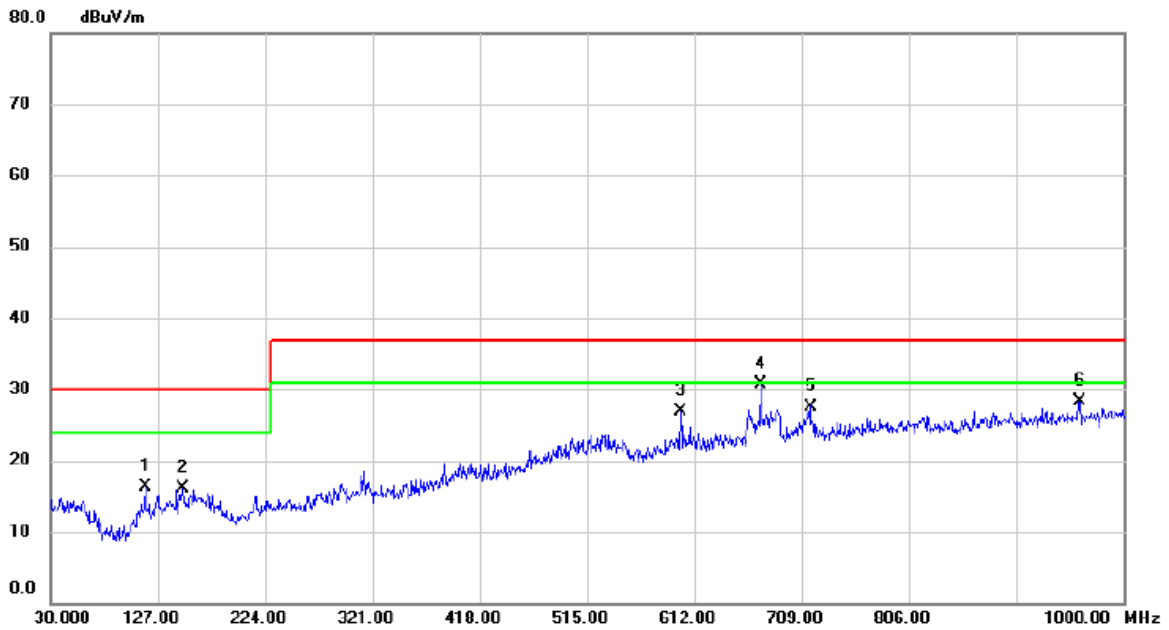

No.	Mk.	Freq. MHz	Reading Level dBuV	Correct Factor dB	Measure- ment dBuV/m	Limit dBuV/m	Margin dB	Detector	Comment
1		115.3600	36.39	-20.04	16.35	30.00	-13.65	QP	
2		149.3100	32.42	-16.29	16.13	30.00	-13.87	QP	
3		599.8750	35.63	-8.64	26.99	37.00	-10.01	QP	
4	*	672.1400	38.75	-7.98	30.77	37.00	-6.23	QP	
5		716.7600	35.26	-7.66	27.60	37.00	-9.40	QP	
6		960.2300	33.38	-5.16	28.22	37.00	-8.78	QP	

3.2 RADIATED EMISSION ABOVE 1 GHZ

3.2.1 LIMITS

Class B equipment above 1000MHz

Frequency MHz	Measurement		Class B limit dB(uV/m)
	Distance m	Detector type/bandwidth	FSOATS
1000-3000	3	Average / 1 MHz	50
3000-6000			54
1000-3000		Peak / 1 MHz	70
3000-6000			74

Notes:

- (1) The limit for radiated test was performed according to as following: EN 55032
- (2) The tighter limit applies at the band edges.
- (3) Emission level (dBuV/m)=20log Emission level (uV/m).
- (4) The test result calculated as following:
 Measurement Value = Reading Level + Correct Factor
 Correct Factor = Antenna Factor + Cable Loss - Amplifier Gain(if use)
 Margin Level = Measurement Value - Limit Value

Required highest frequency for radiated measurement

Highest internal frequency (F_x) MHz	Highest measured frequency MHz
$F_x \leq 108$	1000
$108 < F_x \leq 500$	2000
$500 < F_x \leq 1000$	5000
$F_x > 100$	5 th up to a maximum 6 GHz

Note for FM and TV broadcast receiver, F_x is determined from the highest frequency generated or used excluding the local oscillator and tuned frequencies.

3.2.2 MEASUREMENT INSTRUMENTS LIST

Item	Kind of Equipment	Manufacturer	Type No.	Series Model	Calibrated until
1	Horn Antenna	EMCO	3115(3m)	9605-4803	Jun. 16, 2023
2	Amplifier	Agilent	8449B	3008A02333	Jan. 22, 2023
3	MXE EMI Receiver	Agilent	N9038A	MY53220133	Jan. 22, 2023
4	Measurement Software	Farad	EZ-EMC Ver.BTL-2ANT-1	N/A	N/A
5	Multi-Device Controller	ETS-Lindgren	2090	N/A	N/A
6	Controller	MF	MF-7802	MF780208159	N/A
7	Cable	Micable	RWLP50-4.0A-S MSM-12M-KJ	20191107 002	Mar. 04, 2023

Remark: "N/A" denotes no model no., no serial no. or no calibration specified.

All calibration period of equipment list is one year.

3.2.3 TEST PROCEDURE

- a. The measuring distance of 3 m shall be used for measurements. The EUT was placed on the top of a rotating table 0.8 meter above the ground at a 10 meter semi-anechoic chamber. The table was rotated 360 degrees to determine the position of the highest radiation.
- b. The height of the equipment or of the substitution antenna shall be 0.8 m, the height of the test antenna shall vary between 1 m to 4 m. Both horizontal and vertical polarizations of the antenna are set to make the measurement.
- c. The initial step in collecting radiated emission data is a receiver peak detector mode pre-scanning the measurement frequency range. Significant peaks are then marked and then Quasi Peak detector mode re-measured.
- d. All readings are Peak Mode value unless otherwise stated AVG in column of Note. If the Peak Mode Measured value compliance with the Peak Limits and lower than AVG Limits, the EUT shall be deemed to meet both Peak & AVG Limits and then only Peak Mode was measured, but AVG Mode didn't perform.
- f. For the actual test configuration, please refer to the related Item - Block Diagram of system tested.

3.2.4 DEVIATION FROM TEST STANDARD

No deviation

3.2.5 TEST SETUP

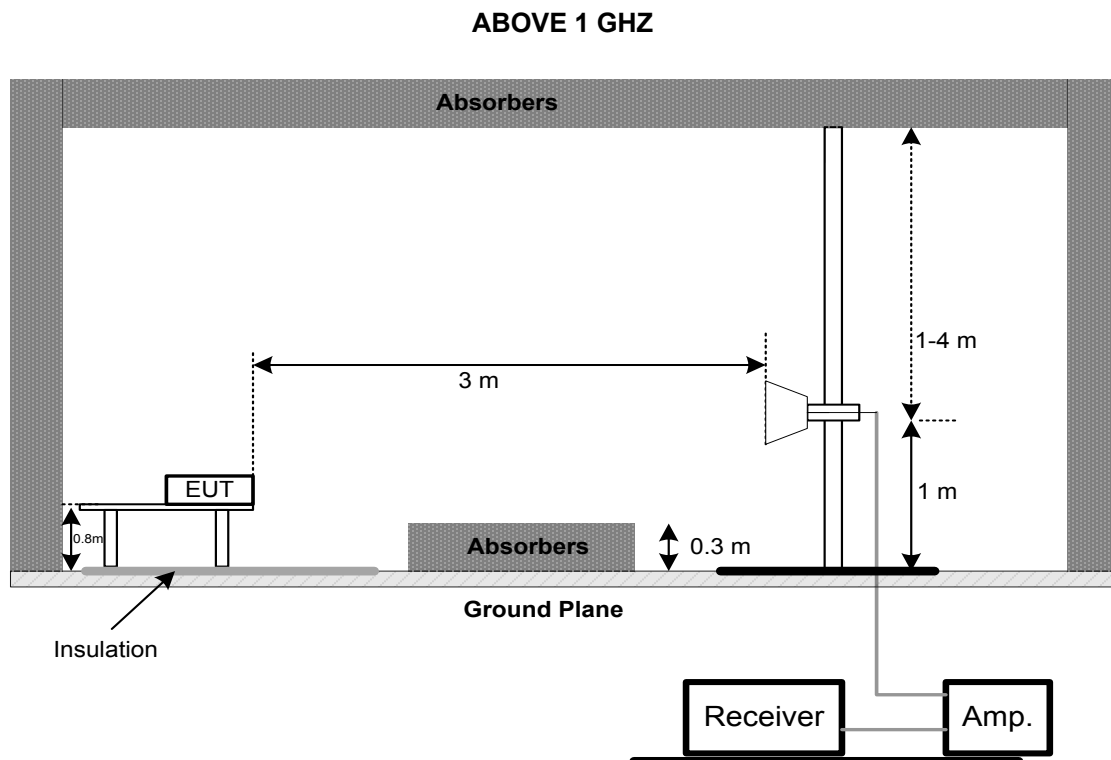

3.2.6 MEASUREMENT DISTANCE

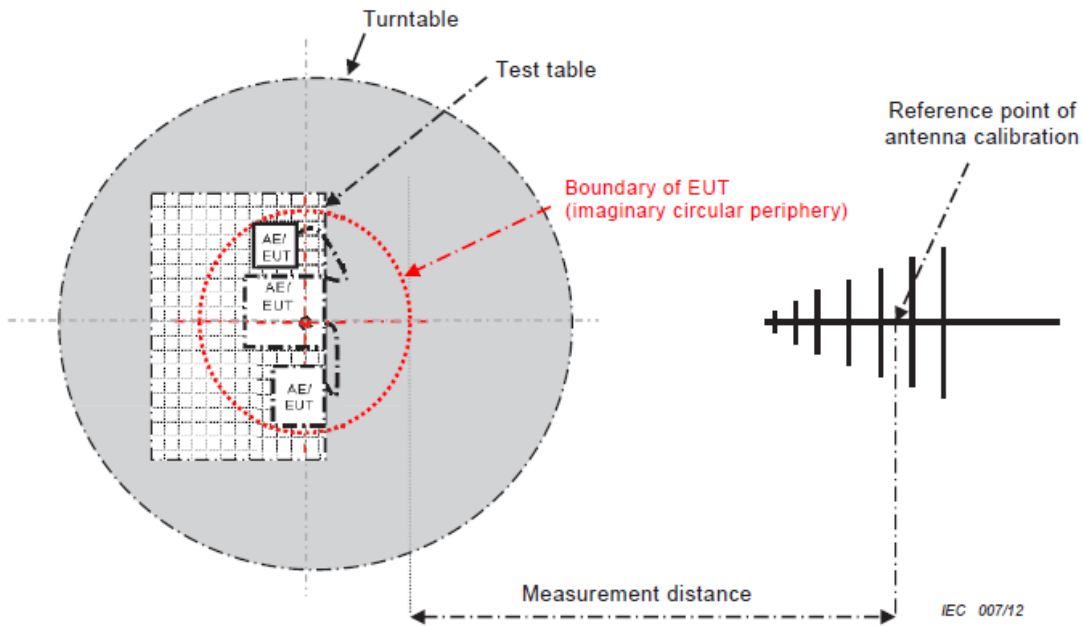

- 34 -

CISPR 32 © IEC:2012

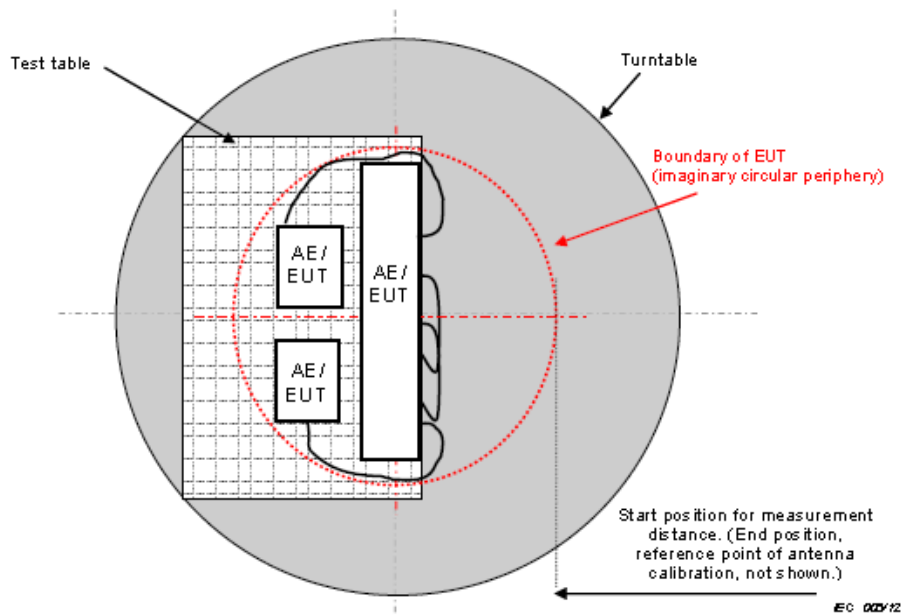
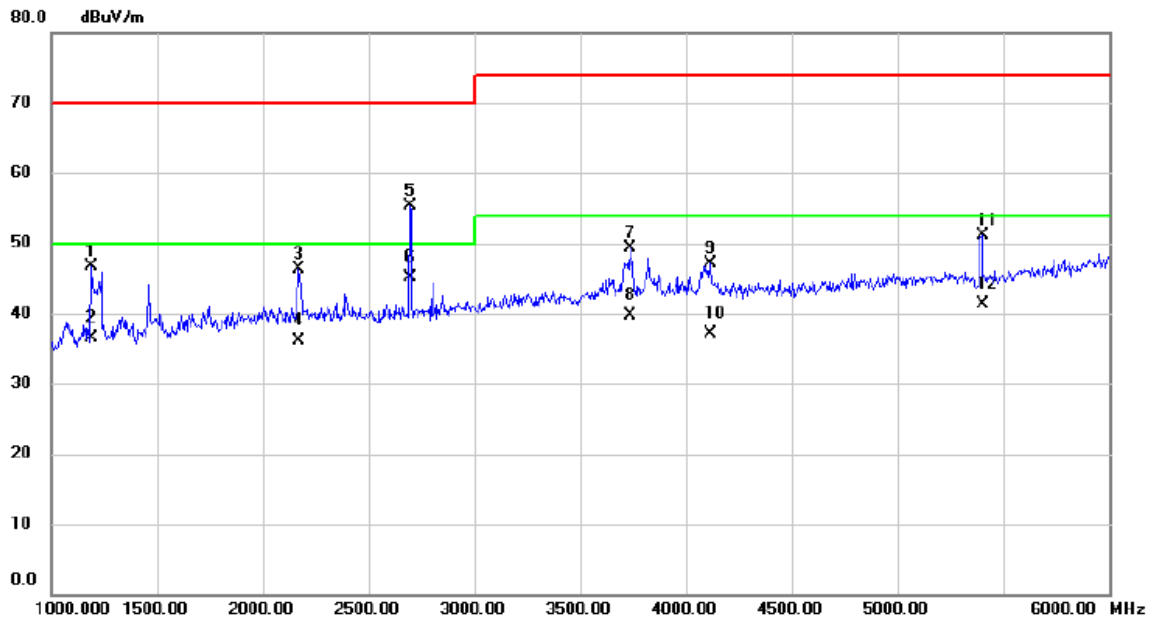

Figure C.2 – Boundary of EUT, Local AE and associated cabling

3.2.7 TEST RESULTS (ABOVE 1 GHZ)

Test Voltage	AC 230V/50Hz	Polarization	Vertical
Test Voltage	Mode 1		



No.	Mk.	Freq. MHz	Reading Level dBuV	Correct Factor dB	Measure- ment dBuV/m	Limit dBuV/m	Margin dB	Detector	Comment
1		1190.000	50.43	-3.71	46.72	70.00	-23.28	peak	
2		1190.000	40.27	-3.71	36.56	50.00	-13.44	AVG	
3		2167.500	43.75	2.57	46.32	70.00	-23.68	peak	
4		2167.500	33.54	2.57	36.11	50.00	-13.89	AVG	
5		2695.000	51.32	3.98	55.30	70.00	-14.70	peak	
6	*	2695.000	41.10	3.98	45.08	50.00	-4.92	AVG	
7		3737.500	41.35	8.05	49.40	74.00	-24.60	peak	
8		3737.500	31.61	8.05	39.66	54.00	-14.34	AVG	
9		4117.500	38.14	8.94	47.08	74.00	-26.92	peak	
10		4117.500	28.19	8.94	37.13	54.00	-16.87	AVG	
11		5400.000	38.05	12.97	51.02	74.00	-22.98	peak	
12		5400.000	28.28	12.97	41.25	54.00	-12.75	AVG	

Test Voltage	AC 230V/50Hz	Polarization	Horizontal
Test Voltage	Mode 1		

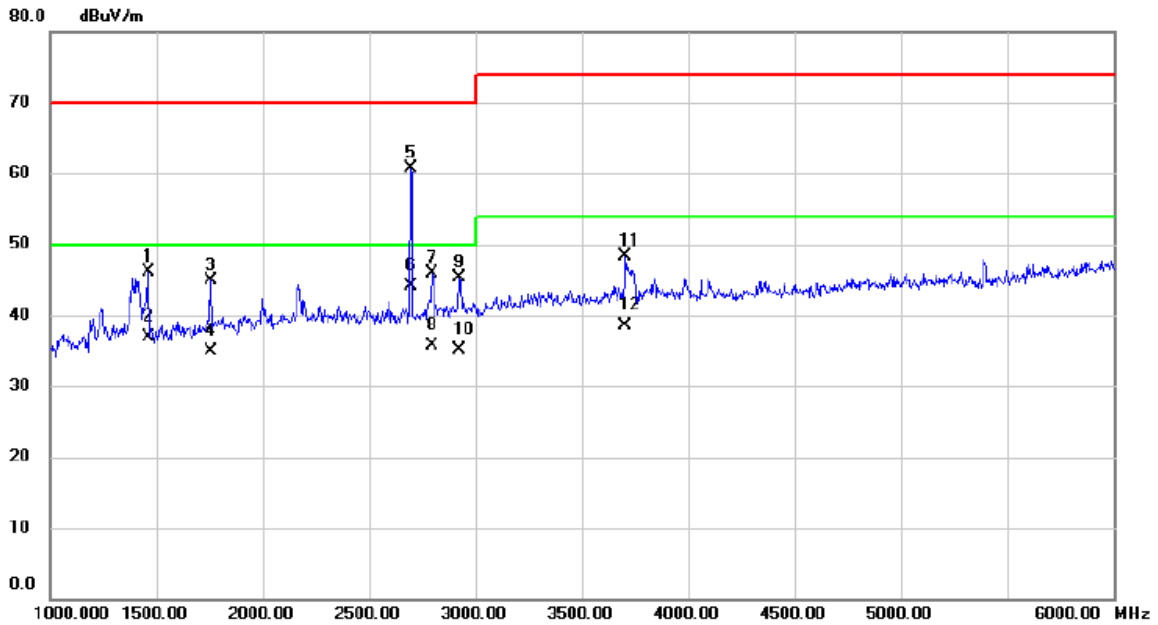

No.	Mk.	Freq. MHz	Reading Level dBuV	Correct Factor dB	Measure- ment dBuV/m	Limit dBuV/m	Margin dB	Detector	Comment
1		1460.000	47.98	-1.91	46.07	70.00	-23.93	peak	
2		1460.000	38.77	-1.91	36.86	50.00	-13.14	AVG	
3		1755.000	44.54	0.35	44.89	70.00	-25.11	peak	
4		1755.000	34.64	0.35	34.99	50.00	-15.01	AVG	
5		2697.500	56.69	3.99	60.68	70.00	-9.32	peak	
6	*	2697.500	40.19	3.99	44.18	50.00	-5.82	AVG	
7		2797.500	41.60	4.38	45.98	70.00	-24.02	peak	
8		2797.500	31.23	4.38	35.61	50.00	-14.39	AVG	
9		2922.500	40.48	4.88	45.36	70.00	-24.64	peak	
10		2922.500	30.23	4.88	35.11	50.00	-14.89	AVG	
11		3705.000	40.28	7.99	48.27	74.00	-25.73	peak	
12		3705.000	30.54	7.99	38.53	54.00	-15.47	AVG	

3.3 CONDUCTED EMISSION MEASUREMENT AT AC MAINS POWER PORTS

3.3.1 LIMITS

Requirements for conducted emissions from AC mains power ports of Class B equipment

Frequency Range MHz	Coupling Devic	Detector Type/ bandwidth	Class B Limits (dB(μV))
0.15 - 0.5	AMN	Quasi Peak / 9 kHz	66-56
0.5 - 5			56
5 - 30			60
0.15 - 0.5	AMN	Average / 9 kHz	56-46
0.5 - 5			46
5 - 30			50

NOTE:

(1) The test result calculated as following:

Measurement Value = Reading Level + Correct Factor

Correct Factor = Insertion Loss + Cable Loss + Attenuator Factor(if use)

Margin Level = Measurement Value – Limit Value

3.3.2 MEASUREMENT INSTRUMENTS LIST

Item	Kind of Equipment	Manufacturer	Type No.	Series Model	Calibrated until
1	EMI Test Receiver	R&S	ESCI	100382	Jan. 22, 2023
2	LISN	EMCO	3816/2	52765	Jan. 23, 2023
3	TWO-LINE V-NETWORK	R&S	ENV216	101447	Jan. 23, 2023
4	Measurement Software	Farad	EZ-EMC Ver.NB-03A1-01	N/A	N/A
5	Cable	N/A	RG223	12m	Mar. 08, 2023

Remark: "N/A" denotes no model name, serial no. or calibration specified.

All calibration period of equipment list is one year.

3.3.3 TEST PROCEDURE

- The EUT was placed 0.8 meters from the horizontal ground plane with EUT being connected to the power mains through a line impedance stabilization network (LISN). All other support equipments powered from additional LISN(s). The LISN provide 50 Ohm/ 50uH of coupling impedance for the measuring instrument.
- Interconnecting cables that hang closer than 40 cm to the ground plane shall be folded back and forth in the center forming a bundle 30 to 40 cm long.
- I/O cables that are not connected to a peripheral shall be bundled in the center. The end of the cable may be terminated, if required, using the correct terminating impedance. The overall length shall not exceed 1 m.
- LISN at least 80 cm from nearest part of EUT chassis.
- For the actual test configuration, please refer to the related Item –EUT Test Photos.

3.3.4 DEVIATION FROM TEST STANDARD

No deviation

3.3.5 TEST SETUP

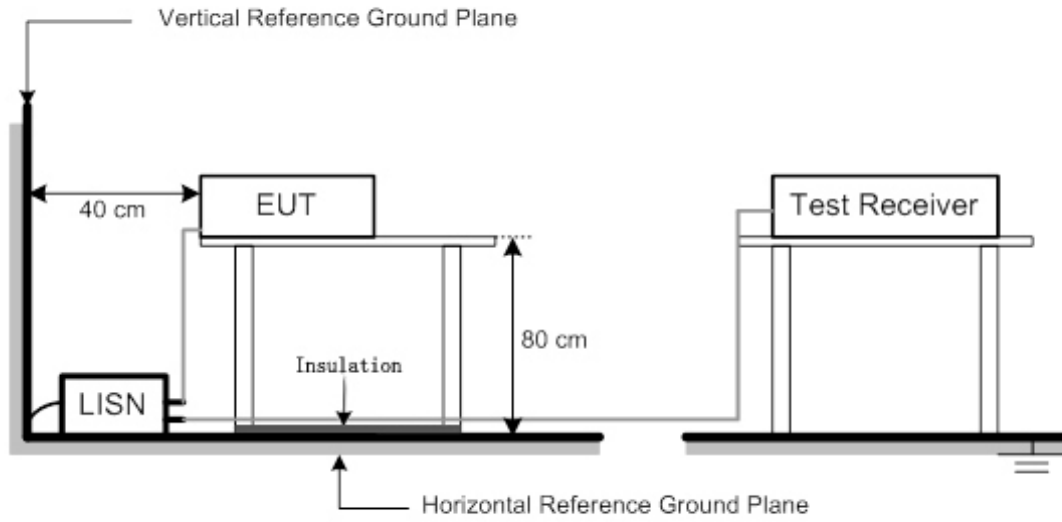

3.3.6 TEST RESULTS

Test Voltage	AC 230V/50Hz	Phase	Line
Test Mode	Mode 1		

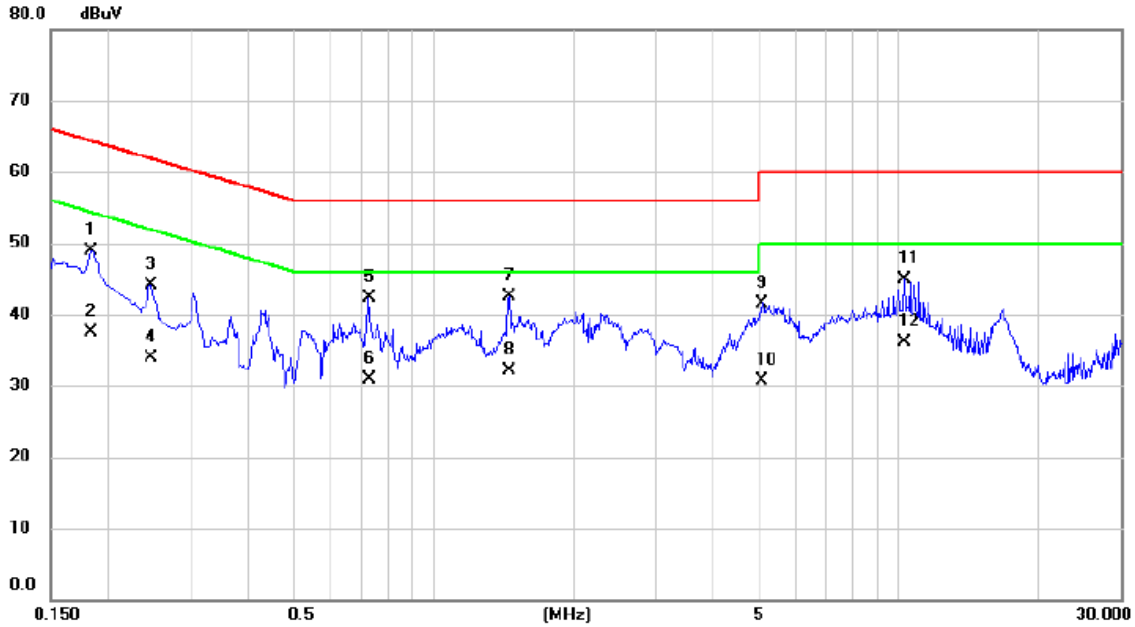

No.	Mk.	Freq. MHz	Reading Level dBuV	Correct Factor dB	Measure- ment dBuV	Limit dBuV	Margin dB	Detector	Comment
1		0.1838	39.30	9.68	48.98	64.31	-15.33	QP	
2		0.1838	27.80	9.68	37.48	54.31	-16.83	AVG	
3		0.2468	34.47	9.70	44.17	61.86	-17.69	QP	
4		0.2468	24.30	9.70	34.00	51.86	-17.86	AVG	
5		0.7260	32.41	9.80	42.21	56.00	-13.79	QP	
6		0.7260	21.10	9.80	30.90	46.00	-15.10	AVG	
7	*	1.4505	32.60	9.85	42.45	56.00	-13.55	QP	
8		1.4505	22.20	9.85	32.05	46.00	-13.95	AVG	
9		5.0933	31.47	10.12	41.59	60.00	-18.41	QP	
10		5.0933	20.60	10.12	30.72	50.00	-19.28	AVG	
11		10.2615	34.50	10.49	44.99	60.00	-15.01	QP	
12		10.2615	25.70	10.49	36.19	50.00	-13.81	AVG	

Test Voltage	AC 230V/50Hz	Phase	Neutral
Test Mode	Mode 1		

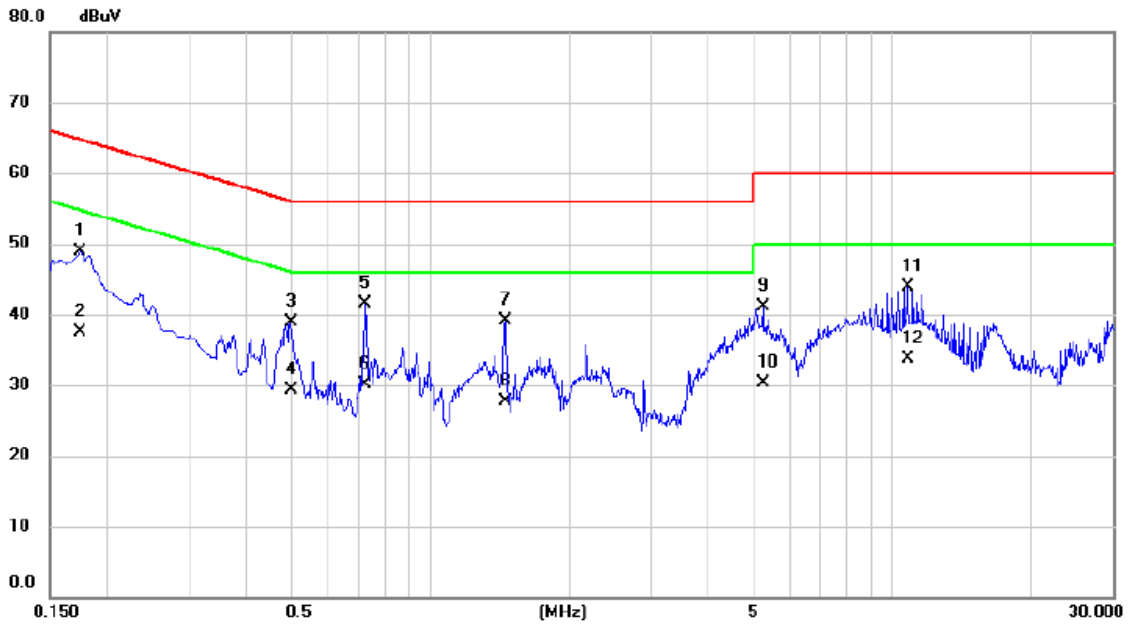

No. Mk.	Freq. MHz	Reading Level dBuV	Correct Factor dB	Measure- ment dBuV	Limit dBuV	Margin dB	Detector	Comment
1	0.1748	39.27	9.71	48.98	64.73	-15.75	QP	
2	0.1748	27.80	9.71	37.51	54.73	-17.22	AVG	
3	0.4987	29.07	9.79	38.86	56.02	-17.16	QP	
4	0.4987	19.60	9.79	29.39	46.02	-16.63	AVG	
5 *	0.7236	31.69	9.83	41.52	56.00	-14.48	QP	
6	0.7236	20.30	9.83	30.13	46.00	-15.87	AVG	
7	1.4505	29.20	9.89	39.09	56.00	-16.91	QP	
8	1.4505	17.80	9.89	27.69	46.00	-18.31	AVG	
9	5.2418	30.95	10.17	41.12	60.00	-18.88	QP	
10	5.2418	20.20	10.17	30.37	50.00	-19.63	AVG	
11	10.7858	33.35	10.50	43.85	60.00	-16.15	QP	
12	10.7858	23.30	10.50	33.80	50.00	-16.20	AVG	

4. EMC EMISSION TEST- EN 55032:2015+A11:2020/EN 55032:2015+A1:2020

4.1 RADIATED EMISSIONS UP TO 1 GHZ

4.1.1 LIMITS

Class B equipment up to 1000MHz

Frequency Range MHz	Measurement			Class B limits dB(μV/m)
	Facility	Distance m	Detector type/ bandwidth	
30 - 230	SAC	10	Quasi peak / 120 kHz	30
230 - 1000				37

Notes:

- (1) The limit for radiated test was performed according to as following: EN 55032
- (2) The tighter limit applies at the band edges.
- (3) Emission level (dBuV/m)=20log Emission level (uV/m).
- (4) The test result calculated as following:
 Measurement Value = Reading Level + Correct Factor
 Correct Factor = Antenna Factor + Cable Loss - Amplifier Gain(if use)
 Margin Level = Measurement Value - Limit Value

4.1.2 MEASUREMENT INSTRUMENTS LIST

Item	Kind of Equipment	Manufacturer	Type No.	Series Model	Calibrated until
1	Receiver	Keysight	N9038A	MY54450004	Jul. 03, 2023
2	MXE EMI Receiver	Agilent	N9038A	MY53220133	Jan. 22, 2023
3	Pre-Amplifier	EMC INSTRUMENT	EMC 9135	980284	Jul. 03, 2023
4	Pre-Amplifier	EMC INSTRUMENT	EMC 9135	980283	Jul. 03, 2023
5	Trilog-Broadband Antenna	Schwarzbeck	VULB9168	947	Oct. 19, 2022
6	Trilog-Broadband Antenna	Schwarzbeck	VULB9168	946	Sep. 11, 2022
7	Cable	emci	LMR-400 (5m+8m+8m)	N/A	Jan. 06, 2023
8	Cable	emci	LMR-400 (5m+8m+8m)	N/A	Jan. 06, 2023
9	Measurement Software	Farad	EZ-EMC Ver.BTL-2ANT-1	N/A	N/A
10	Multi-Device Controller	ETS-Lindgren	2090	N/A	N/A
11	Controller	MF	MF-7802	MF780208159	N/A
12	Attenuator	EMCI	EMCI-N-6-06	AT-N0671	Sep. 11, 2022
13	Attenuator	EMCI	EMCI-N-6-06	AT-N0670	Oct. 19, 2022

Remark: "N/A" denotes no model no., no serial no. or no calibration specified.

All calibration period of equipment list is one year.

4.1.3 TEST PROCEDURE

- The measuring distance of 10 m shall be used for measurements. The EUT was placed on the top of a rotating table 0.8 meter above the ground at a 10 meter semi-anechoic chamber. The table was rotated 360 degrees to determine the position of the highest radiation.
- The height of the equipment or of the substitution antenna shall be 0.8 m, the height of the test antenna shall vary between 1 m to 4 m. Both horizontal and vertical polarizations of the antenna are set to make the measurement.
- The initial step in collecting radiated emission data is a receiver peak detector mode pre-scanning the measurement frequency range. Significant peaks are then marked and then Quasi Peak detector mode re-measured.
- All readings are Peak unless otherwise stated QP in column of Note. Peak denotes that the Peak reading compliance with the QP Limits and then QP Mode measurement didn't perform.
- For the actual test configuration, please refer to the related Item - Block Diagram of system tested.

4.1.4 DEVIATION FROM TEST STANDARD

No deviation

4.1.5 TEST SETUP

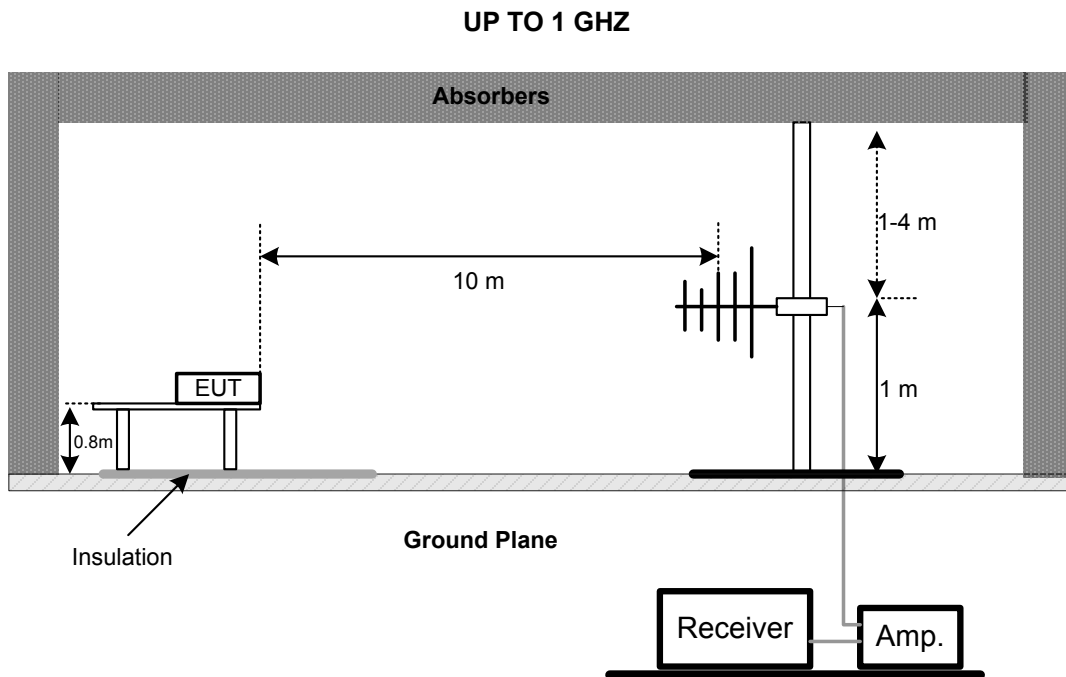

4.1.6 MEASUREMENT DISTANCE

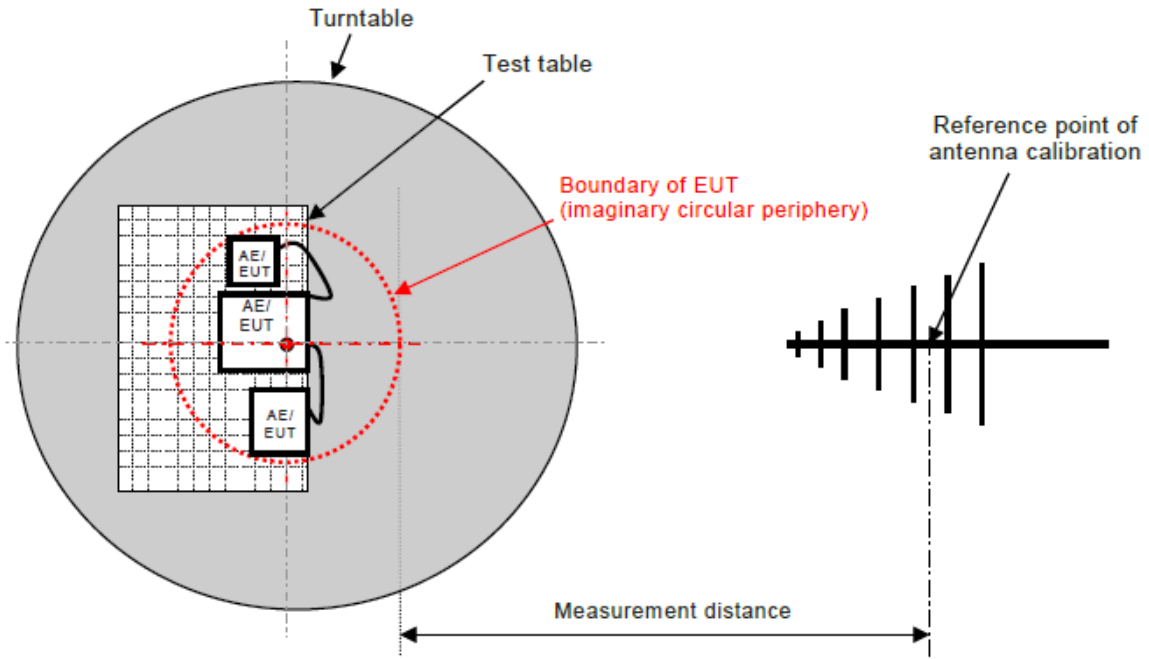

IEC

Figure C.1 – Measurement distance

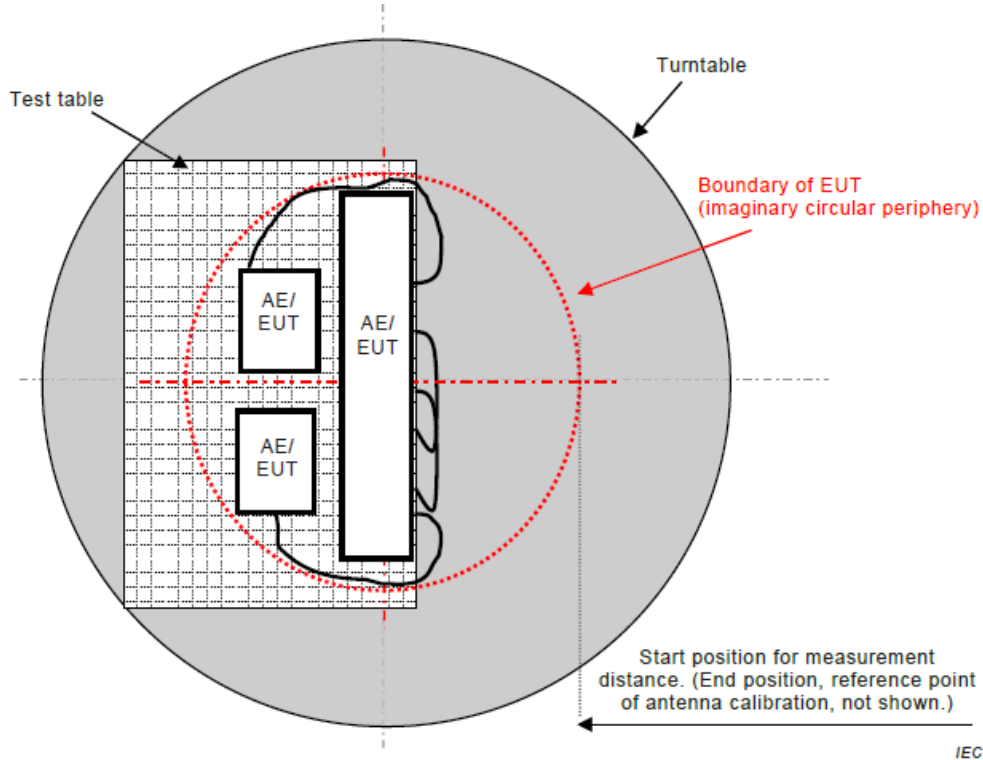

IEC

Figure C.2 – Boundary of EUT, Local AE and associated cabling

4.1.7 TEST RESULTS (UP TO 1 GHZ)

Test Voltage	AC 230V/50Hz	Polarization	Vertical
Test Voltage	Mode 1		

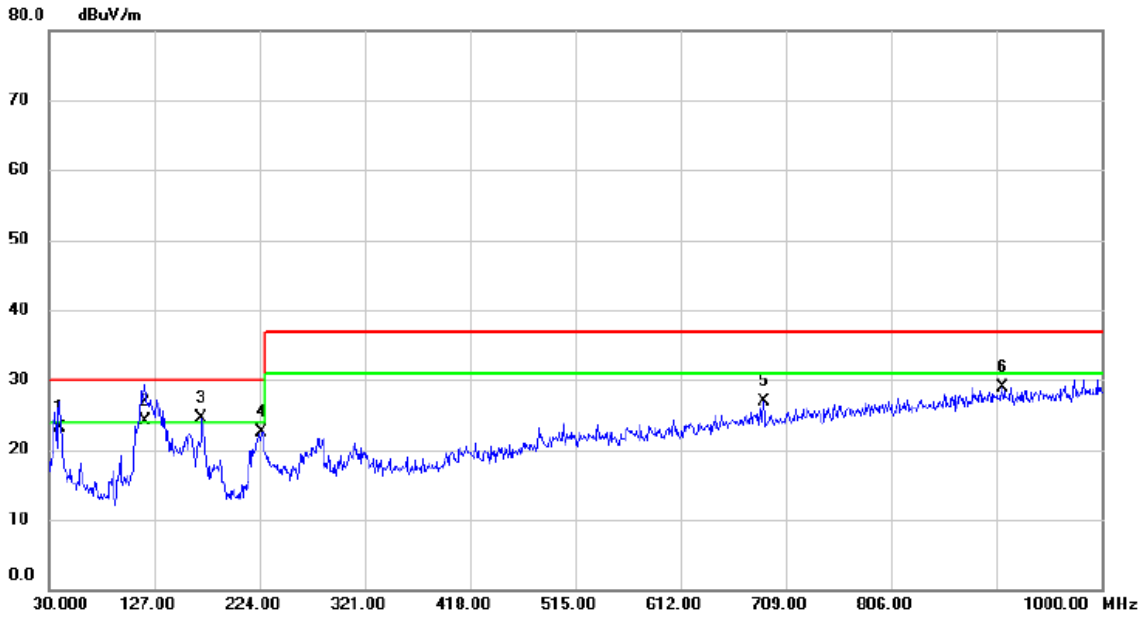

No.	Mk.	Freq. MHz	Reading Level dBuV	Correct Factor dB	Measure- ment dBuV/m	Limit dBuV/m	Margin dB	Detector	Comment
1		39.7000	40.92	-17.73	23.19	30.00	-6.81	QP	
2	!	118.2700	42.52	-18.39	24.13	30.00	-5.87	QP	
3	*	170.6500	41.06	-16.46	24.60	30.00	-5.40	QP	
4		225.9400	41.00	-18.41	22.59	30.00	-7.41	QP	
5		688.6300	33.77	-6.84	26.93	37.00	-10.07	QP	
6		908.8200	33.61	-4.62	28.99	37.00	-8.01	QP	

Test Voltage	AC 230V/50Hz	Polarization	Horizontal
Test Voltage	Mode 1		

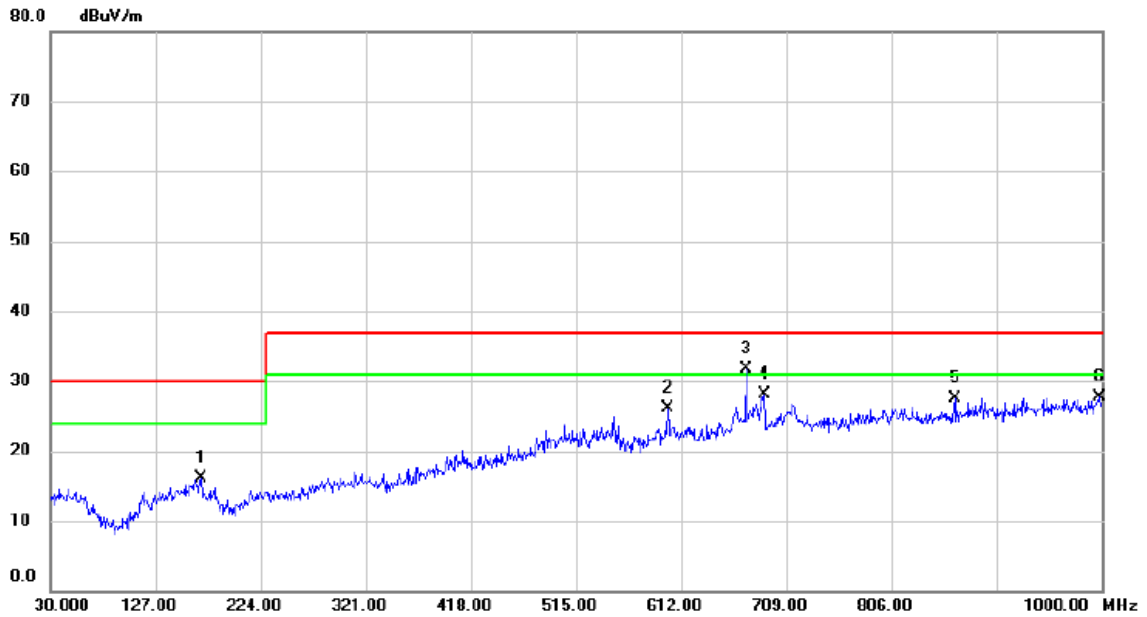

No.	Mk.	Freq. MHz	Reading Level dBuV	Correct Factor dB	Measure- ment dBuV/m	Limit dBuV/m	Margin dB	Detector	Comment
1		168.7100	32.67	-16.59	16.08	30.00	-13.92	QP	
2		599.3900	34.82	-8.66	26.16	37.00	-10.84	QP	
3	*	672.1400	39.59	-7.98	31.61	37.00	-5.39	QP	
4		688.6300	35.97	-7.96	28.01	37.00	-8.99	QP	
5		864.2000	33.84	-6.41	27.43	37.00	-9.57	QP	
6		998.0600	31.97	-4.23	27.74	37.00	-9.26	QP	

Test Voltage	AC 230V/50Hz	Polarization	Vertical
Test Voltage	Mode 6		

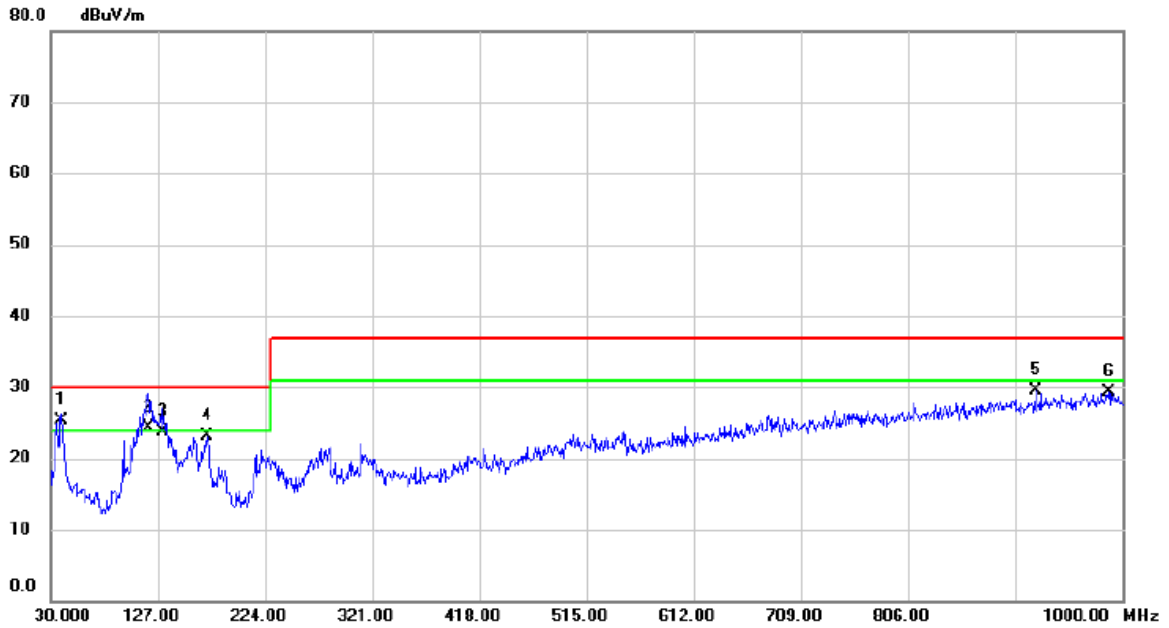

No.	Mk.	Freq. MHz	Reading Level dBuV	Correct Factor dB	Measure- ment dBuV/m	Limit dBuV/m	Margin dB	Detector	Comment
1	*	39.7000	43.04	-17.73	25.31	30.00	-4.69	QP	
2	!	118.2700	42.78	-18.39	24.39	30.00	-5.61	QP	
3		131.8500	41.15	-17.46	23.69	30.00	-6.31	QP	
4		171.6200	39.71	-16.53	23.18	30.00	-6.82	QP	
5		921.4300	33.96	-4.48	29.48	37.00	-7.52	QP	
6		987.3900	32.75	-3.40	29.35	37.00	-7.65	QP	

Test Voltage	AC 230V/50Hz	Polarization	Horizontal
Test Voltage	Mode 6		

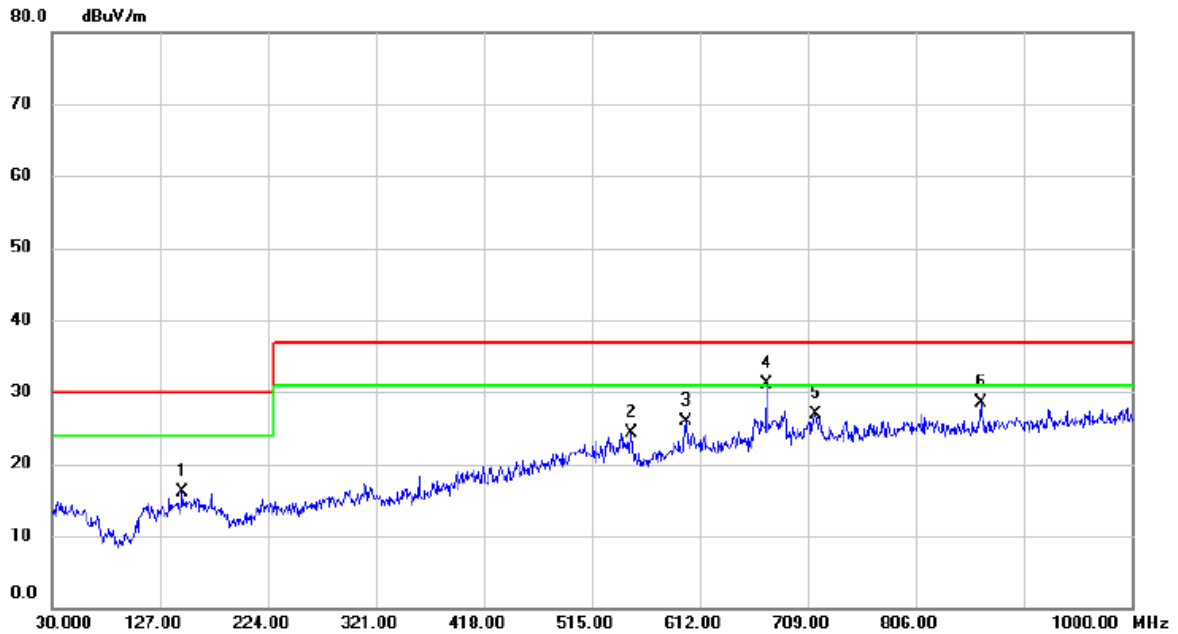

No.	Mk.	Freq. MHz	Reading Level dBuV	Correct Factor dB	Measure- ment dBuV/m	Limit dBuV/m	Margin dB	Detector	Comment
1		147.3700	32.57	-16.49	16.08	30.00	-13.92	QP	
2		550.8900	34.37	-10.12	24.25	37.00	-12.75	QP	
3		599.3900	34.65	-8.66	25.99	37.00	-11.01	QP	
4	*	672.1400	39.10	-7.98	31.12	37.00	-5.88	QP	
5		715.7900	34.65	-7.67	26.98	37.00	-10.02	QP	
6		864.2000	35.01	-6.41	28.60	37.00	-8.40	QP	

Test Voltage	AC 110V/60Hz	Polarization	Vertical
Test Voltage	Mode 1		

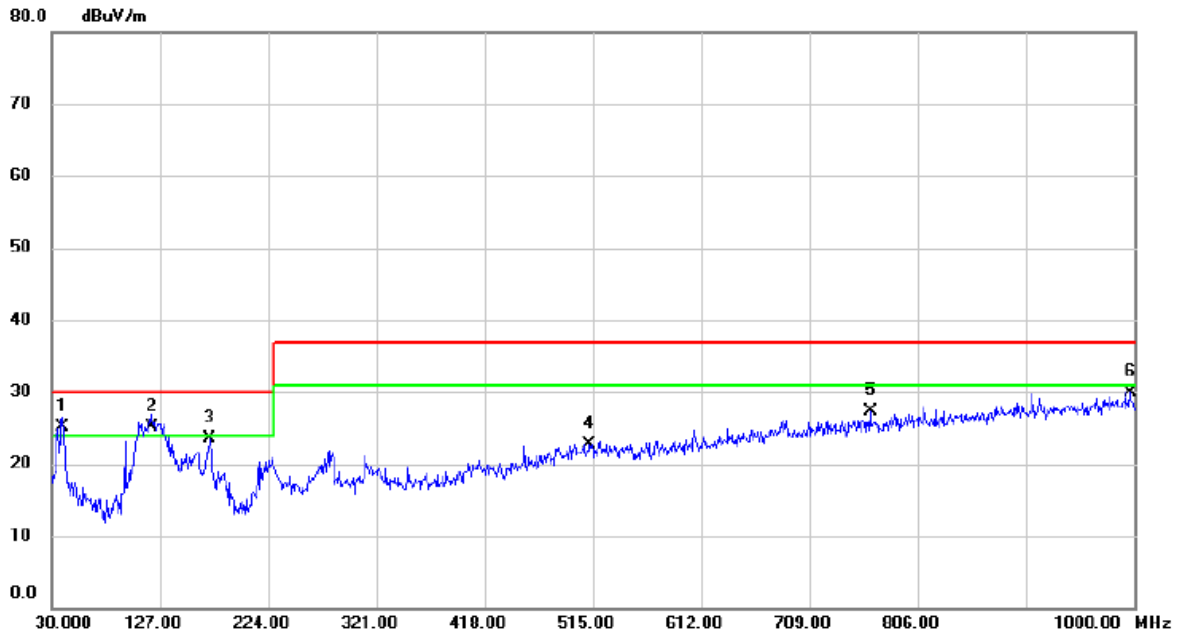

No.	Mk.	Freq. MHz	Reading Level dBuV	Correct Factor dB	Measure- ment dBuV/m	Limit dBuV/m	Margin dB	Detector	Comment
1	*	39.7000	42.87	-17.73	25.14	30.00	-4.86	QP	
2	!	119.2400	43.35	-18.29	25.06	30.00	-4.94	QP	
3		171.6200	39.96	-16.53	23.43	30.00	-6.57	QP	
4		512.0900	32.30	-9.55	22.75	37.00	-14.25	QP	
5		763.3200	33.28	-5.89	27.39	37.00	-9.61	QP	
6		996.1200	33.19	-3.23	29.96	37.00	-7.04	QP	

Test Voltage	AC 110V/60Hz	Polarization	Horizontal
Test Voltage	Mode 1		

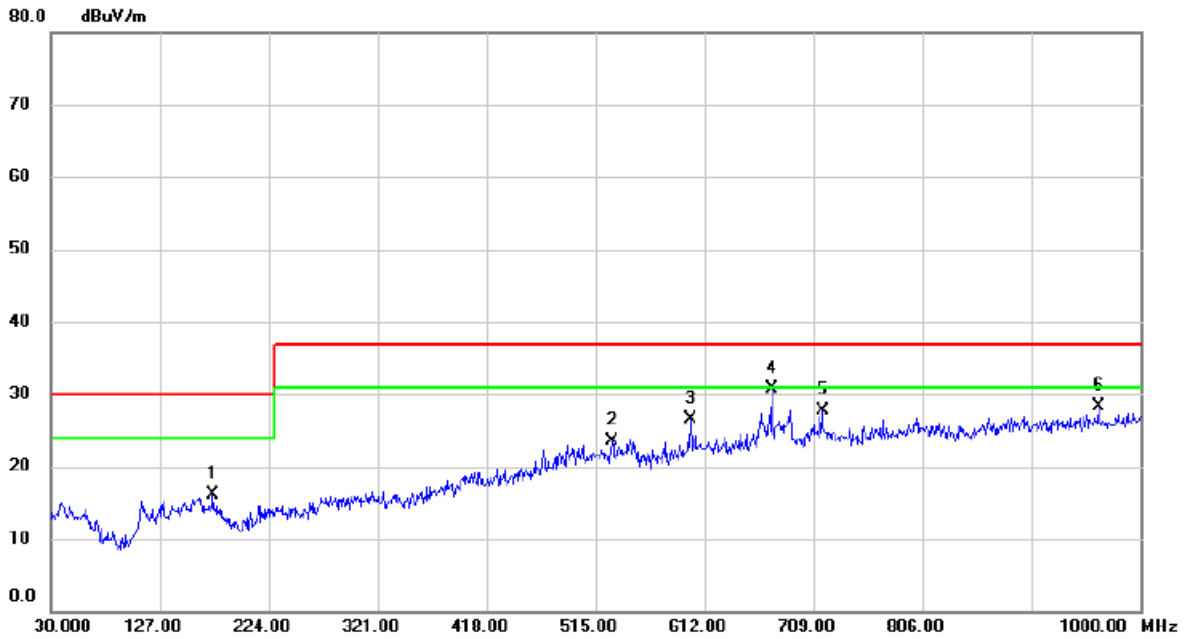

No.	Mk.	Freq. MHz	Reading Level dBuV	Correct Factor dB	Measure- ment dBuV/m	Limit dBuV/m	Margin dB	Detector	Comment
1		174.5300	33.02	-16.97	16.05	30.00	-13.95	QP	
2		529.5500	33.86	-10.37	23.49	37.00	-13.51	QP	
3		599.8750	35.19	-8.64	26.55	37.00	-10.45	QP	
4	*	672.1400	38.71	-7.98	30.73	37.00	-6.27	QP	
5		716.7600	35.45	-7.66	27.79	37.00	-9.21	QP	
6		962.6550	33.32	-5.10	28.22	37.00	-8.78	QP	

4.2 RADIATED EMISSIONS ABOVE 1 GHZ

4.2.1 LIMITS

Class B equipment above 1000MHz

Limit For EN 55032:2015+A11:2020

Frequency Range MHz	Measurement			Class B limits dB(μ V/m)
	Facility	Distance m	Detector type/bandwidth	
1000 - 3000	FSOATS	3	Average / 1 MHz	50
3000 - 6000				54
1000 - 3000			Peak / 1 MHz	70
3000 - 6000				74

Limit For EN 55032:2015+A1:2020

Frequency Range MHz	Measurement			Class B limits dB(μ V/m)
	Facility	Distance m	Detector type/bandwidth	
1000 - 6000	FSOATS	3	Average / 1 MHz	54
1000 - 6000			Peak / 1 MHz	74

Notes:

- (1) The limit for radiated test was performed according to as following: EN 55032
- (2) The tighter limit applies at the band edges.
- (3) Emission level (dBuV/m)=20log Emission level (uV/m).
- (4) The test result calculated as following:
 Measurement Value = Reading Level + Correct Factor
 Correct Factor = Antenna Factor + Cable Loss - Amplifier Gain(if use)
 Margin Level = Measurement Value - Limit Value

Required highest frequency for radiated measurement

Highest internal frequency (F_x)	Highest measured frequency
$F_x \leq 108$ MHz	1 GHz
$108 < F_x \leq 500$ MHz	2 GHz
$500 < F_x \leq 1000$ MHz	5 GHz
$F_x > 1$ GHz	$5 \times F_x$ up to a maximum of 6 GHz

4.2.1 MEASUREMENT INSTRUMENTS LIST

Item	Kind of Equipment	Manufacturer	Type No.	Series Model	Calibrated until
1	Horn Antenna	EMCO	3115(3m)	9605-4803	Jun. 16, 2023
2	Amplifier	Agilent	8449B	3008A02333	Jan. 22, 2023
3	MXE EMI Receiver	Agilent	N9038A	MY53220133	Jan. 22, 2023
4	Measurement Software	Farad	EZ-EMC Ver.BTL-2ANT-1	N/A	N/A
5	Multi-Device Controller	ETS-Lindgren	2090	N/A	N/A
6	Controller	MF	MF-7802	MF780208159	N/A
7	Cable	Micable	RWLP50-4.0A-S MSM-12M-KJ	20191107 002	Mar. 04, 2023

Remark: "N/A" denotes no model no., no serial no. or no calibration specified.

All calibration period of equipment list is one year.

4.2.1.1 TEST PROCEDURE

- a. The measuring distance of 3 m shall be used for measurements. The EUT was placed on the top of a rotating table 0.8 meter above the ground at a 10 meter semi-anechoic chamber. The table was rotated 360 degrees to determine the position of the highest radiation.
- b. The height of the equipment or of the substitution antenna shall be 0.8 m, the height of the test antenna shall vary between 1 m to 4 m. Both horizontal and vertical polarizations of the antenna are set to make the measurement.
- c. The initial step in collecting radiated emission data is a receiver peak detector mode pre-scanning the measurement frequency range. Significant peaks are then marked and then Quasi Peak detector mode re-measured.
- d. All readings are Peak Mode value unless otherwise stated AVG in column of Note. If the Peak Mode Measured value compliance with the Peak Limits and lower than AVG Limits, the EUT shall be deemed to meet both Peak & AVG Limits and then only Peak Mode was measured, but AVG Mode didn't perform.
- e. For the actual test configuration, please refer to the related Item - Block Diagram of system tested.

4.2.1.2 DEVIATION FROM TEST STANDARD

No deviation

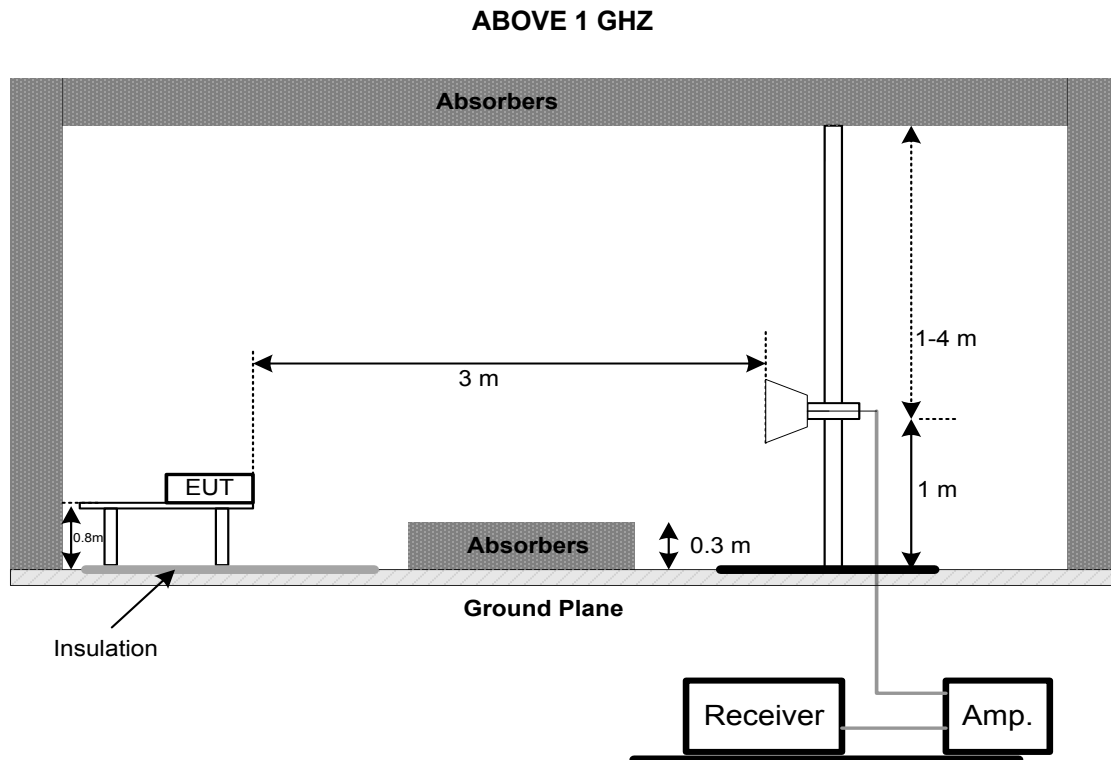
4.2.1.3 TEST SETUP

4.2.1.4 MEASUREMENT DISTANCE

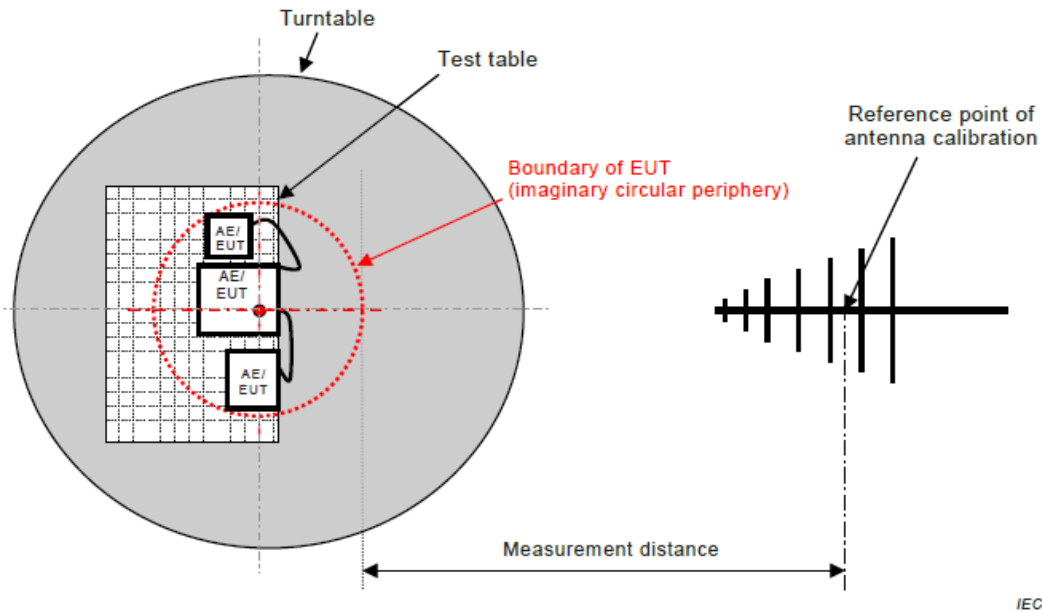

Figure C.1 – Measurement distance

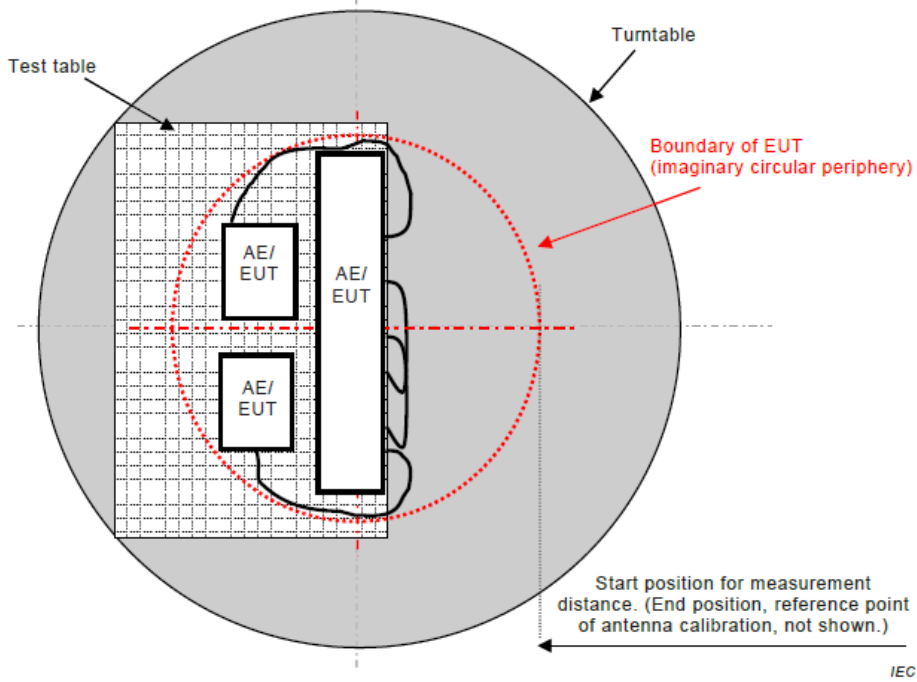
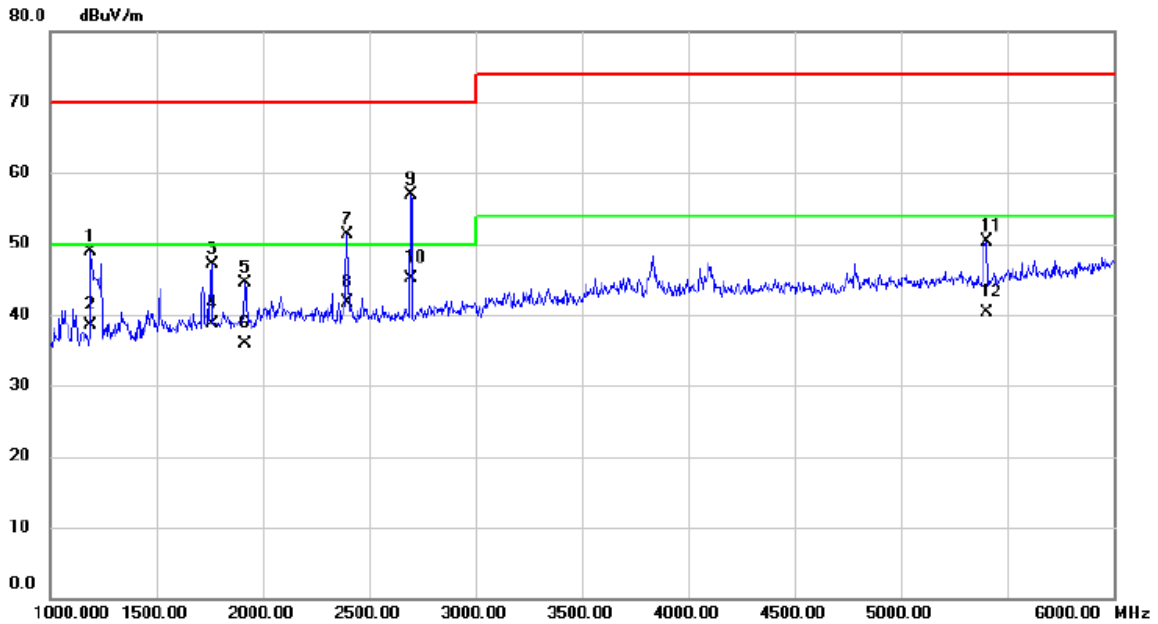

Figure C.2 – Boundary of EUT, Local AE and associated cabling

4.2.1.5 TEST RESULTS (ABOVE 1 GHZ)

For EN 55032:2015+A11:2020

Test Voltage	AC 230V/50Hz	Polarization	Vertical
Test Voltage	Mode 1		



No.	Mk.	Freq. MHz	Reading Level dBuV	Correct Factor dB	Measure- ment dBuV/m	Limit dBuV/m	Margin dB	Detector	Comment
1		1190.000	52.61	-3.71	48.90	70.00	-21.10	peak	
2		1190.000	42.14	-3.71	38.43	50.00	-11.57	AVG	
3		1760.000	46.79	0.39	47.18	70.00	-22.82	peak	
4		1760.000	38.36	0.39	38.75	50.00	-11.25	AVG	
5		1915.000	42.95	1.60	44.55	70.00	-25.45	peak	
6		1915.000	34.38	1.60	35.98	50.00	-14.02	AVG	
7		2397.500	48.20	3.02	51.22	70.00	-18.78	peak	
8		2397.500	38.75	3.02	41.77	50.00	-8.23	AVG	
9		2695.000	52.84	3.98	56.82	70.00	-13.18	peak	
10	*	2695.000	41.21	3.98	45.19	50.00	-4.81	AVG	
11		5400.000	37.33	12.97	50.30	74.00	-23.70	peak	
12		5400.000	27.29	12.97	40.26	54.00	-13.74	AVG	

Test Voltage	AC 230V/50Hz	Polarization	Horizontal
Test Voltage	Mode 1		

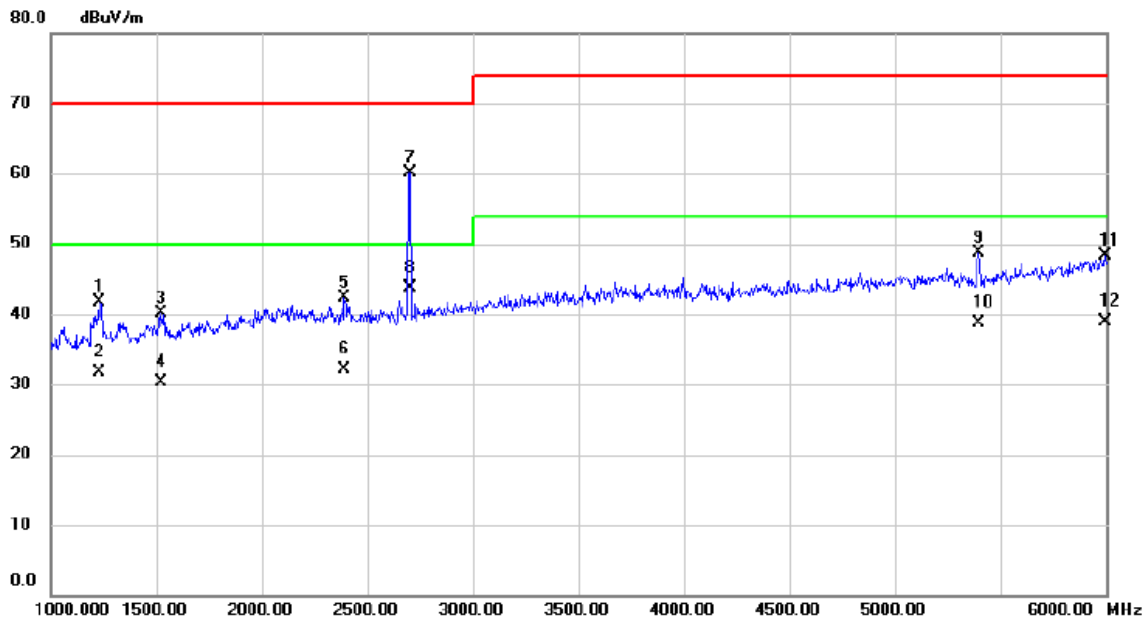

No. Mk.	Freq. MHz	Reading Level dBuV	Correct Factor dB	Measure- ment dBuV/m	Limit dBuV/m	Margin dB	Detector	Comment
1	1232.500	45.03	-3.42	41.61	70.00	-28.39	peak	
2	1232.500	35.19	-3.42	31.77	50.00	-18.23	AVG	
3	1520.000	41.63	-1.49	40.14	70.00	-29.86	peak	
4	1520.000	31.77	-1.49	30.28	50.00	-19.72	AVG	
5	2390.000	39.28	3.00	42.28	70.00	-27.72	peak	
6	2390.000	29.19	3.00	32.19	50.00	-17.81	AVG	
7	2700.000	56.12	4.00	60.12	70.00	-9.88	peak	
8 *	2700.000	39.63	4.00	43.63	50.00	-6.37	AVG	
9	5395.000	35.70	12.95	48.65	74.00	-25.35	peak	
10	5395.000	25.82	12.95	38.77	54.00	-15.23	AVG	
11	5997.500	32.74	15.48	48.22	74.00	-25.78	peak	
12	5997.500	23.44	15.48	38.92	54.00	-15.08	AVG	

Test Voltage	AC 230V/50Hz	Polarization	Vertical
Test Voltage	Mode 6		

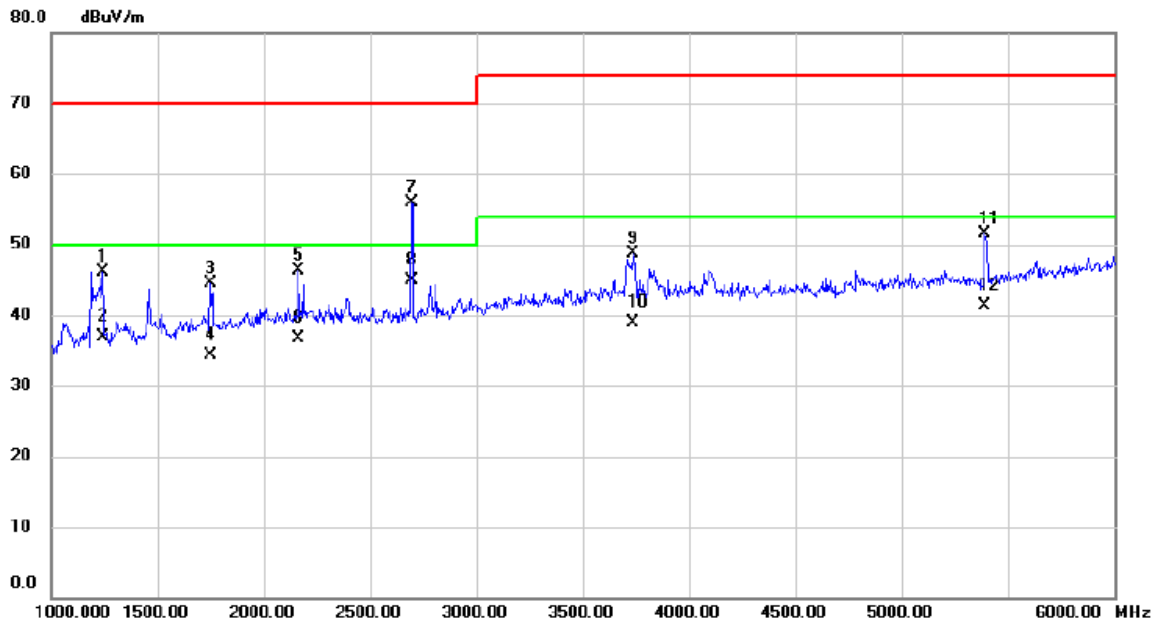

No.	Mk.	Freq. MHz	Reading Level dBuV	Correct Factor dB	Measure- ment dBuV/m	Limit dBuV/m	Margin dB	Detector	Comment
1		1240.000	49.51	-3.37	46.14	70.00	-23.86	peak	
2		1240.000	40.32	-3.37	36.95	50.00	-13.05	AVG	
3		1752.500	44.12	0.32	44.44	70.00	-25.56	peak	
4		1752.500	33.89	0.32	34.21	50.00	-15.79	AVG	
5		2165.000	43.64	2.57	46.21	70.00	-23.79	peak	
6		2165.000	34.21	2.57	36.78	50.00	-13.22	AVG	
7		2697.500	51.93	3.99	55.92	70.00	-14.08	peak	
8	*	2697.500	41.00	3.99	44.99	50.00	-5.01	AVG	
9		3737.500	40.69	8.05	48.74	74.00	-25.26	peak	
10		3737.500	30.94	8.05	38.99	54.00	-15.01	AVG	
11		5390.000	38.51	12.95	51.46	74.00	-22.54	peak	
12		5390.000	28.28	12.95	41.23	54.00	-12.77	AVG	

Test Voltage	AC 230V/50Hz	Polarization	Horizontal
Test Voltage	Mode 6		

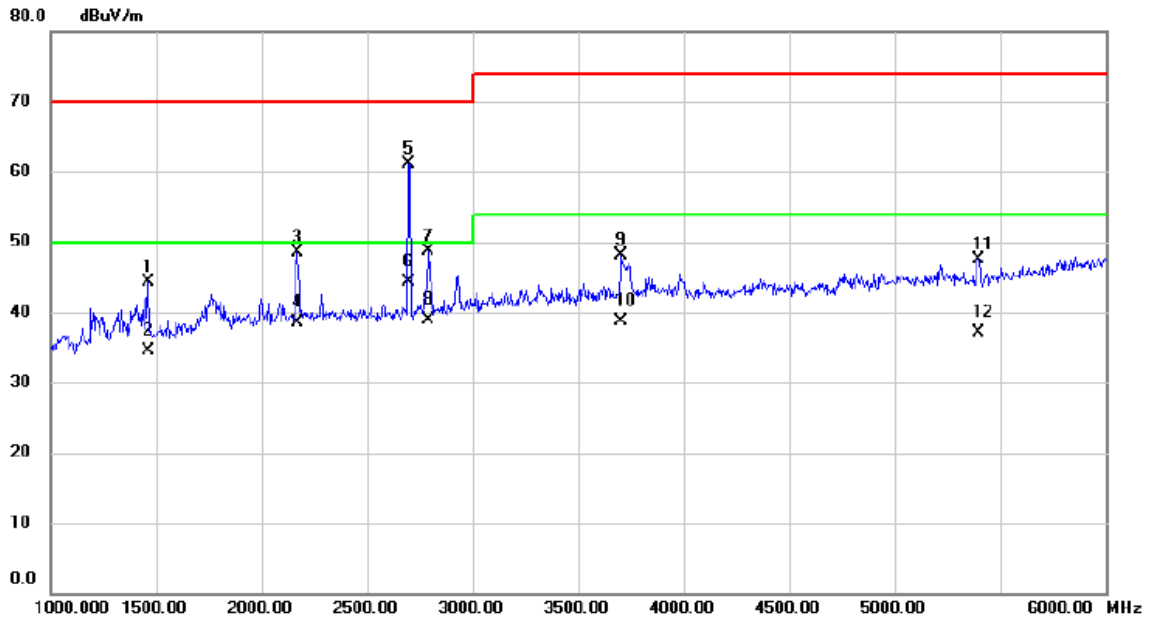

No. Mk.	Freq. MHz	Reading Level dBuV	Correct Factor dB	Measurement dBuV/m	Limit dBuV/m	Margin dB	Detector	Comment
1	1462.500	46.29	-1.90	44.39	70.00	-25.61	peak	
2	1462.500	36.33	-1.90	34.43	50.00	-15.57	AVG	
3	2170.000	45.88	2.58	48.46	70.00	-21.54	peak	
4	2170.000	35.94	2.58	38.52	50.00	-11.48	AVG	
5	2697.500	57.05	3.99	61.04	70.00	-8.96	peak	
6 *	2697.500	40.30	3.99	44.29	50.00	-5.71	AVG	
7	2787.500	44.44	4.34	48.78	70.00	-21.22	peak	
8	2787.500	34.57	4.34	38.91	50.00	-11.09	AVG	
9	3705.000	40.11	7.99	48.10	74.00	-25.90	peak	
10	3705.000	30.64	7.99	38.63	54.00	-15.37	AVG	
11	5395.000	34.65	12.95	47.60	74.00	-26.40	peak	
12	5395.000	24.15	12.95	37.10	54.00	-16.90	AVG	

Test Voltage	AC 110V/60Hz	Polarization	Vertical
Test Voltage	Mode 1		

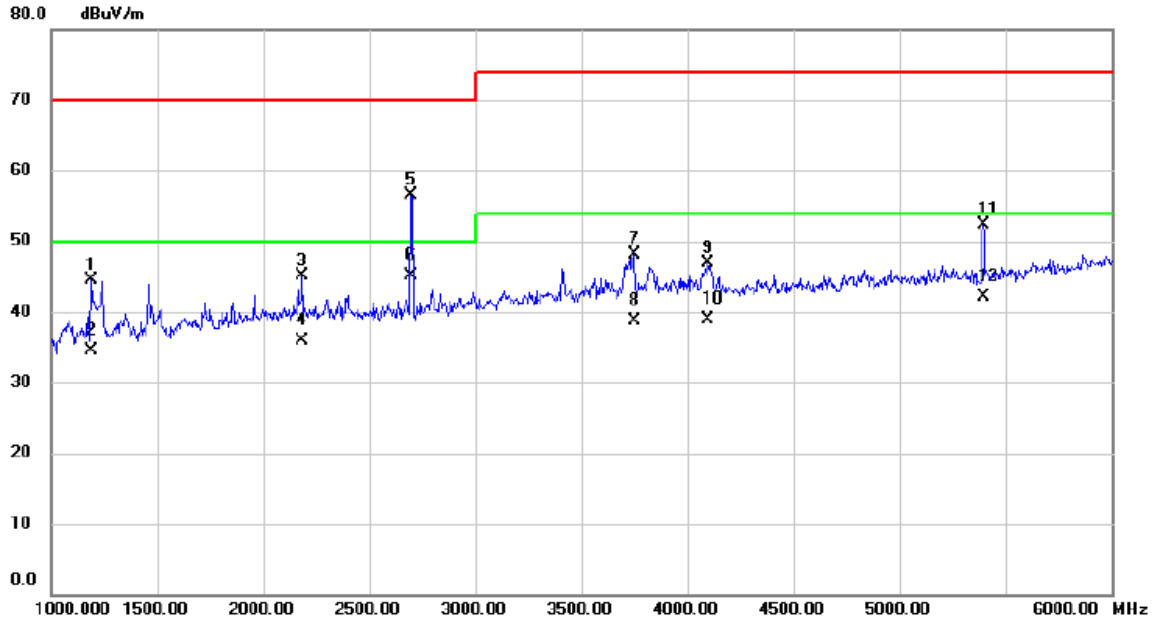

No.	Mk.	Freq. MHz	Reading Level dBuV	Correct Factor dB	Measure- ment dBuV/m	Limit dBuV/m	Margin dB	Detector	Comment
1		1190.000	48.15	-3.71	44.44	70.00	-25.56	peak	
2		1190.000	38.23	-3.71	34.52	50.00	-15.48	AVG	
3		2185.000	42.57	2.60	45.17	70.00	-24.83	peak	
4		2185.000	33.28	2.60	35.88	50.00	-14.12	AVG	
5		2697.500	52.44	3.99	56.43	70.00	-13.57	peak	
6	*	2697.500	41.15	3.99	45.14	50.00	-4.86	AVG	
7		3750.000	40.01	8.08	48.09	74.00	-25.91	peak	
8		3750.000	30.54	8.08	38.62	54.00	-15.38	AVG	
9		4097.500	38.12	8.88	47.00	74.00	-27.00	peak	
10		4097.500	30.04	8.88	38.92	54.00	-15.08	AVG	
11		5397.500	39.34	12.97	52.31	74.00	-21.69	peak	
12		5397.500	29.16	12.97	42.13	54.00	-11.87	AVG	

Test Voltage	AC 110V/60Hz	Polarization	Horizontal
Test Voltage	Mode 1		

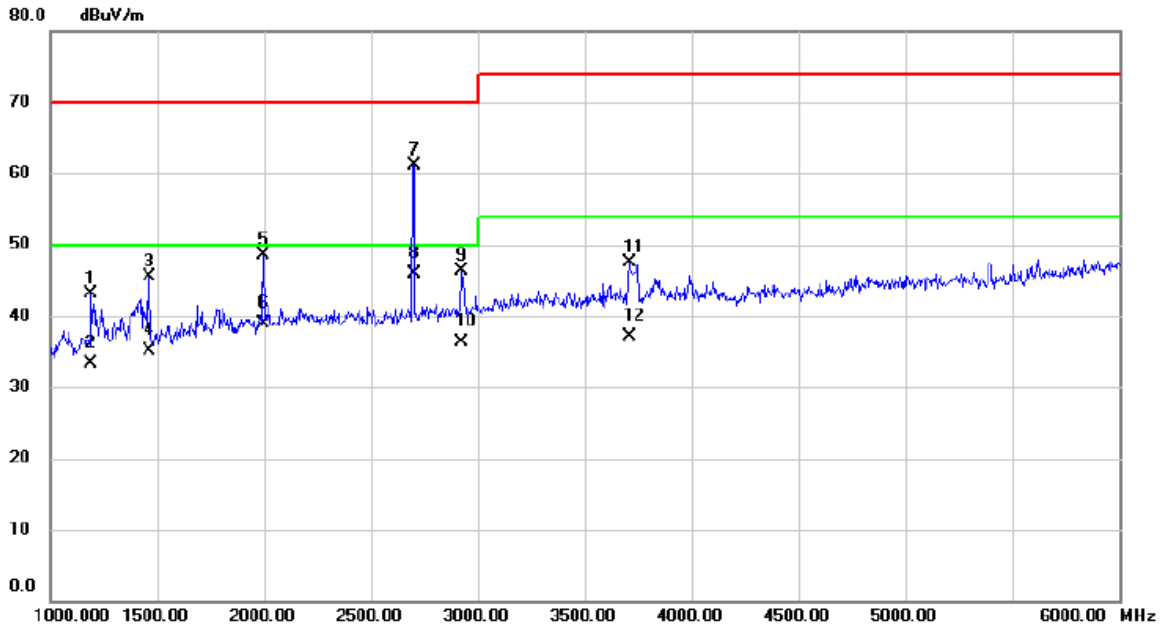

No.	Mk.	Freq. MHz	Reading Level dBuV	Correct Factor dB	Measure- ment dBuV/m	Limit dBuV/m	Margin dB	Detector	Comment
1		1190.000	46.83	-3.71	43.12	70.00	-26.88	peak	
2		1190.000	36.94	-3.71	33.23	50.00	-16.77	AVG	
3		1460.000	47.48	-1.91	45.57	70.00	-24.43	peak	
4		1460.000	37.04	-1.91	35.13	50.00	-14.87	AVG	
5		1997.500	46.22	2.24	48.46	70.00	-21.54	peak	
6		1997.500	36.66	2.24	38.90	50.00	-11.10	AVG	
7		2700.000	57.15	4.00	61.15	70.00	-8.85	peak	
8	*	2700.000	41.98	4.00	45.98	50.00	-4.02	AVG	
9		2920.000	41.48	4.87	46.35	70.00	-23.65	peak	
10		2920.000	31.36	4.87	36.23	50.00	-13.77	AVG	
11		3707.500	39.53	7.99	47.52	74.00	-26.48	peak	
12		3707.500	29.12	7.99	37.11	54.00	-16.89	AVG	

For EN 55032:2015+A1:2020

Test Voltage	AC 230V/50Hz	Polarization	Vertical
Test Voltage	Mode 1		

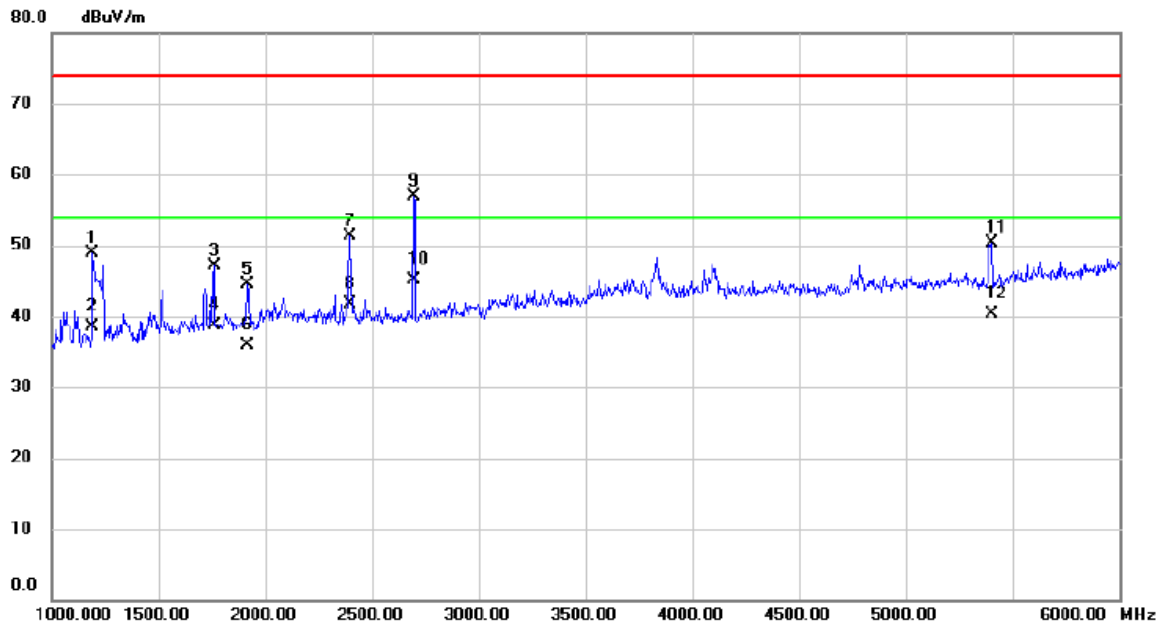

No.	Mk.	Freq. MHz	Reading Level dBuV	Correct Factor dB	Measure- ment dBuV/m	Limit dBuV/m	Margin dB	Detector	Comment
1		1190.000	52.61	-3.71	48.90	74.00	-25.10	peak	
2		1190.000	42.14	-3.71	38.43	54.00	-15.57	AVG	
3		1760.000	46.79	0.39	47.18	74.00	-26.82	peak	
4		1760.000	38.36	0.39	38.75	54.00	-15.25	AVG	
5		1915.000	42.95	1.60	44.55	74.00	-29.45	peak	
6		1915.000	34.38	1.60	35.98	54.00	-18.02	AVG	
7		2397.500	48.20	3.02	51.22	74.00	-22.78	peak	
8		2397.500	38.75	3.02	41.77	54.00	-12.23	AVG	
9		2695.000	52.84	3.98	56.82	74.00	-17.18	peak	
10	*	2695.000	41.21	3.98	45.19	54.00	-8.81	AVG	
11		5400.000	37.33	12.97	50.30	74.00	-23.70	peak	
12		5400.000	27.29	12.97	40.26	54.00	-13.74	AVG	

Test Voltage	AC 230V/50Hz	Polarization	Horizontal
Test Voltage	Mode 1		

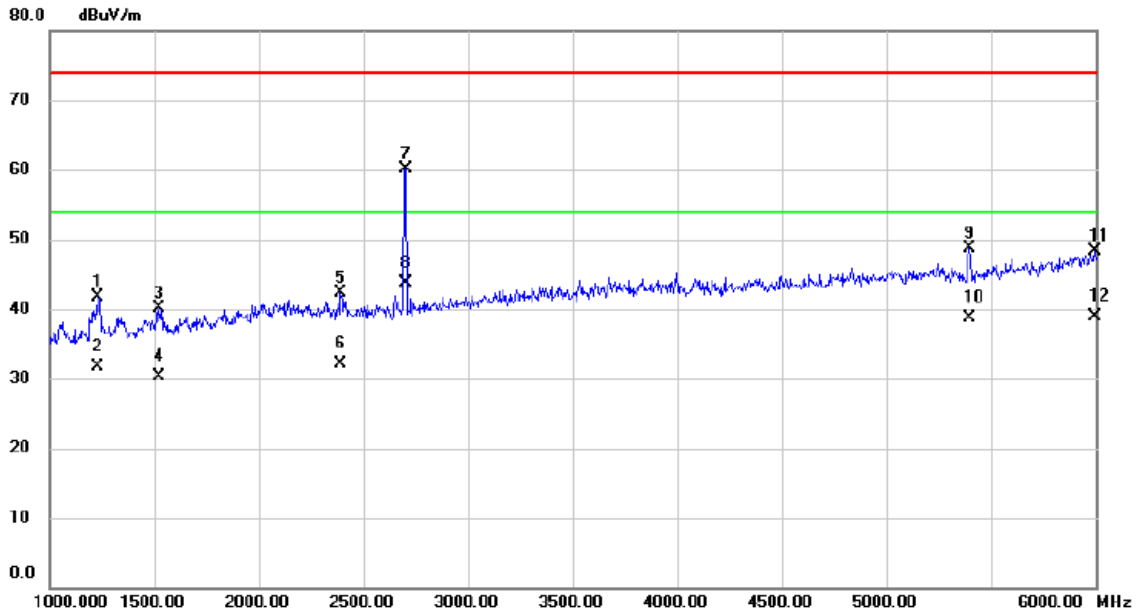

No.	Mk.	Freq. MHz	Reading Level dBuV	Correct Factor dB	Measure- ment dBuV/m	Limit dBuV/m	Margin dB	Detector	Comment
1		1232.500	45.03	-3.42	41.61	74.00	-32.39	peak	
2		1232.500	35.19	-3.42	31.77	54.00	-22.23	AVG	
3		1520.000	41.63	-1.49	40.14	74.00	-33.86	peak	
4		1520.000	31.77	-1.49	30.28	54.00	-23.72	AVG	
5		2390.000	39.28	3.00	42.28	74.00	-31.72	peak	
6		2390.000	29.19	3.00	32.19	54.00	-21.81	AVG	
7		2700.000	56.12	4.00	60.12	74.00	-13.88	peak	
8	*	2700.000	39.63	4.00	43.63	54.00	-10.37	AVG	
9		5395.000	35.70	12.95	48.65	74.00	-25.35	peak	
10		5395.000	25.82	12.95	38.77	54.00	-15.23	AVG	
11		5997.500	32.74	15.48	48.22	74.00	-25.78	peak	
12		5997.500	23.44	15.48	38.92	54.00	-15.08	AVG	

4.3 CONDUCTED EMISSION MEASUREMENT AT AC MAINS POWER PORTS

4.3.1 LIMITS

Requirements for conducted emissions from AC mains power ports of Class B equipment

Frequency Range MHz	Coupling Device	Detector Type / bandwidth	Class B Limits (dB(μV))
0.15 - 0.5	AMN	Quasi Peak / 9 kHz	66-56
0.5 - 5			56
5 - 30			60
0.15 - 0.5	AMN	Average / 9 kHz	56-46
0.5 - 5			46
5 - 30			50

NOTE:

(1) The test result calculated as following:

Measurement Value = Reading Level + Correct Factor

Correct Factor = Insertion Loss + Cable Loss + Attenuator Factor(if use)

Margin Level = Measurement Value – Limit Value

4.3.2 MEASUREMENT INSTRUMENTS LIST

Item	Kind of Equipment	Manufacturer	Type No.	Series Model	Calibrated until
1	EMI Test Receiver	R&S	ESCI	100382	Jan. 22, 2023
2	LISN	EMCO	3816/2	52765	Jan. 23, 2023
3	TWO-LINE V-NETWORK	R&S	ENV216	101447	Jan. 23, 2023
4	Measurement Software	Farad	EZ-EMC Ver.NB-03A1-01	N/A	N/A
5	Cable	N/A	RG223	12m	Mar. 08, 2023

Remark: "N/A" denotes no model name, serial no. or calibration specified.

All calibration period of equipment list is one year.

4.3.3 TEST PROCEDURE

- a. The EUT was placed 0.8 meters from the horizontal ground plane with EUT being connected to the power mains through a line impedance stabilization network (LISN). All other support equipments powered from additional LISN(s). The LISN provide 50 Ohm/ 50uH of coupling impedance for the measuring instrument.
- b. Interconnecting cables that hang closer than 40 cm to the ground plane shall be folded back and forth in the center forming a bundle 30 to 40 cm long.
- c. I/O cables that are not connected to a peripheral shall be bundled in the center. The end of the cable may be terminated, if required, using the correct terminating impedance. The overall length shall not exceed 1 m.
- d. LISN at least 80 cm from nearest part of EUT chassis.
- e. For the actual test configuration, please refer to the related Item –EUT Test Photos.

4.3.4 TEST SETUP

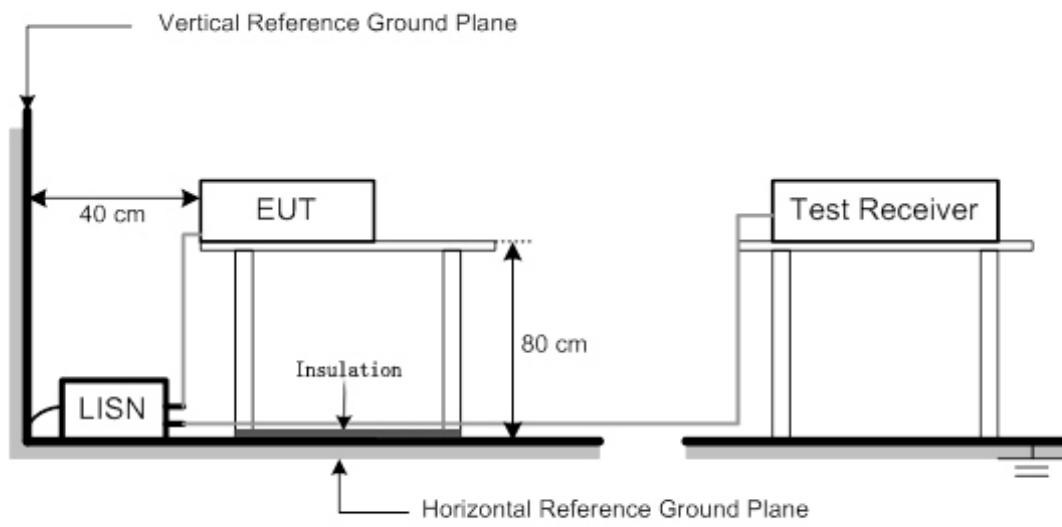

4.3.5 TEST RESULTS

Test Voltage	AC 230V/50Hz	Phase	Line
Test Mode	Mode 1		

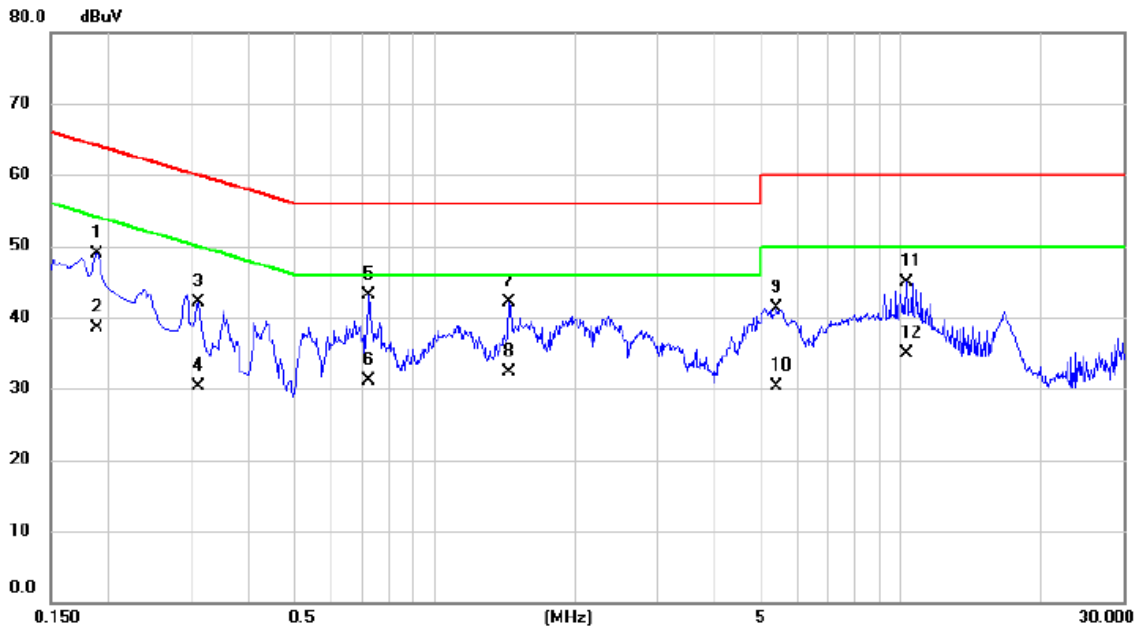

No.	Mk.	Freq. MHz	Reading Level dBuV	Correct Factor dB	Measure- ment dBuV	Limit dBuV	Margin dB	Detector	Comment
1		0.1883	39.18	9.69	48.87	64.11	-15.24	QP	
2		0.1883	28.80	9.69	38.49	54.11	-15.62	AVG	
3		0.3120	32.44	9.72	42.16	59.92	-17.76	QP	
4		0.3120	20.60	9.72	30.32	49.92	-19.60	AVG	
5	*	0.7236	33.36	9.80	43.16	56.00	-12.84	QP	
6		0.7236	21.30	9.80	31.10	46.00	-14.90	AVG	
7		1.4483	32.19	9.85	42.04	56.00	-13.96	QP	
8		1.4483	22.40	9.85	32.25	46.00	-13.75	AVG	
9		5.3902	31.06	10.15	41.21	60.00	-18.79	QP	
10		5.3902	20.20	10.15	30.35	50.00	-19.65	AVG	
11		10.2660	34.42	10.49	44.91	60.00	-15.09	QP	
12		10.2660	24.50	10.49	34.99	50.00	-15.01	AVG	

Test Voltage	AC 230V/50Hz	Phase	Neutral
Test Mode	Mode 1		

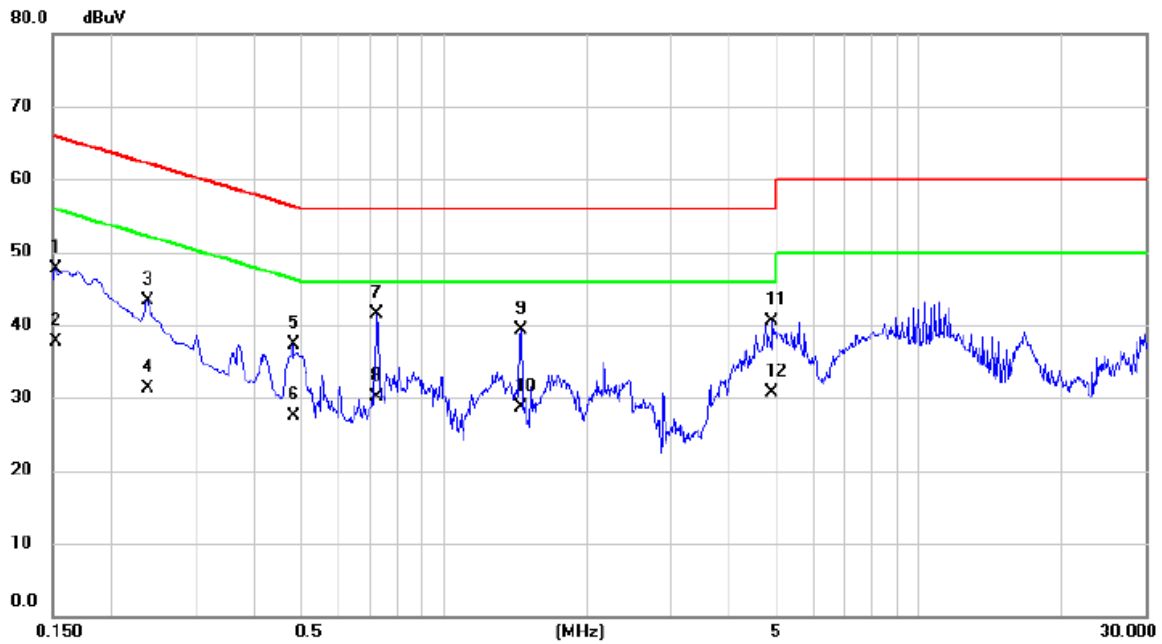

No.	Mk.	Freq. MHz	Reading Level dBuV	Correct Factor dB	Measure- ment dBuV	Limit dBuV	Margin dB	Detector	Comment
1		0.1522	38.01	9.71	47.72	65.88	-18.16	QP	
2		0.1522	27.90	9.71	37.61	55.88	-18.27	AVG	
3		0.2378	33.56	9.74	43.30	62.17	-18.87	QP	
4		0.2378	21.60	9.74	31.34	52.17	-20.83	AVG	
5		0.4830	27.54	9.79	37.33	56.29	-18.96	QP	
6		0.4830	17.80	9.79	27.59	46.29	-18.70	AVG	
7	*	0.7236	31.76	9.83	41.59	56.00	-14.41	QP	
8		0.7236	20.20	9.83	30.03	46.00	-15.97	AVG	
9		1.4505	29.37	9.89	39.26	56.00	-16.74	QP	
10		1.4505	18.90	9.89	28.79	46.00	-17.21	AVG	
11		4.9110	30.45	10.15	40.60	56.00	-15.40	QP	
12		4.9110	20.60	10.15	30.75	46.00	-15.25	AVG	

Test Voltage	AC 110V/60Hz	Phase	Line
Test Mode	Mode 1		

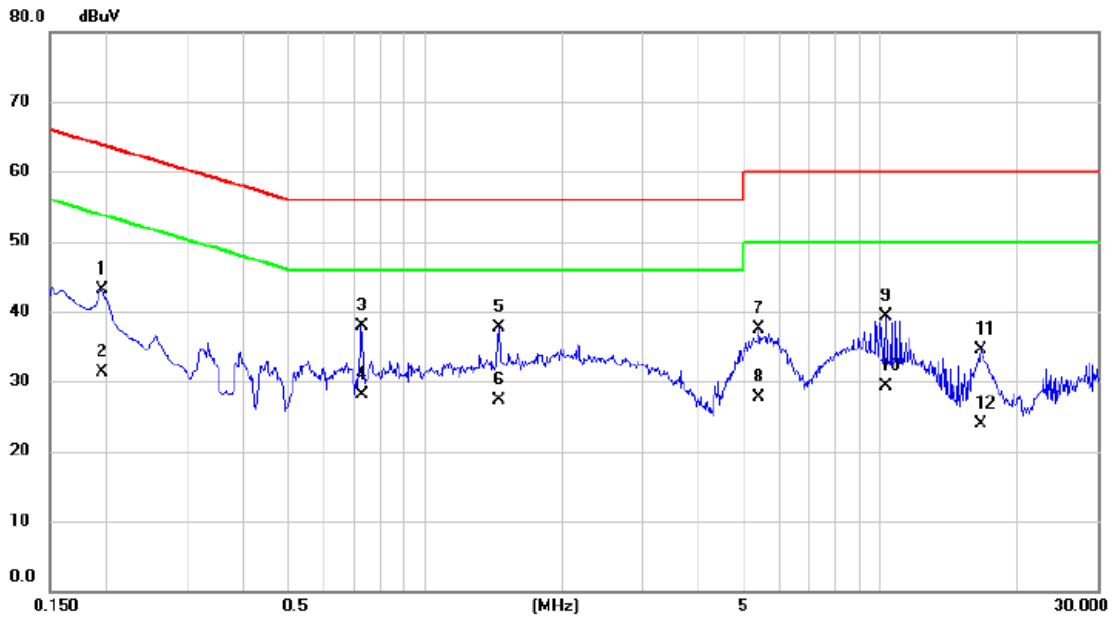

No.	Mk.	Freq. MHz	Reading Level dBuV	Correct Factor dB	Measure- ment dBuV	Limit dBuV	Margin dB	Detector	Comment
1		0.1950	33.36	9.69	43.05	63.82	-20.77	QP	
2		0.1950	21.60	9.69	31.29	53.82	-22.53	AVG	
3		0.7260	28.02	9.80	37.82	56.00	-18.18	QP	
4	*	0.7260	18.30	9.80	28.10	46.00	-17.90	AVG	
5		1.4505	27.95	9.85	37.80	56.00	-18.20	QP	
6		1.4505	17.40	9.85	27.25	46.00	-18.75	AVG	
7		5.4060	27.41	10.15	37.56	60.00	-22.44	QP	
8		5.4060	17.50	10.15	27.65	50.00	-22.35	AVG	
9		10.2818	28.91	10.49	39.40	60.00	-20.60	QP	
10		10.2818	18.90	10.49	29.39	50.00	-20.61	AVG	
11		16.6064	23.79	10.65	34.44	60.00	-25.56	QP	
12		16.6064	13.20	10.65	23.85	50.00	-26.15	AVG	

Test Voltage	AC 110V/60Hz	Phase	Neutral
Test Mode	Mode 1		

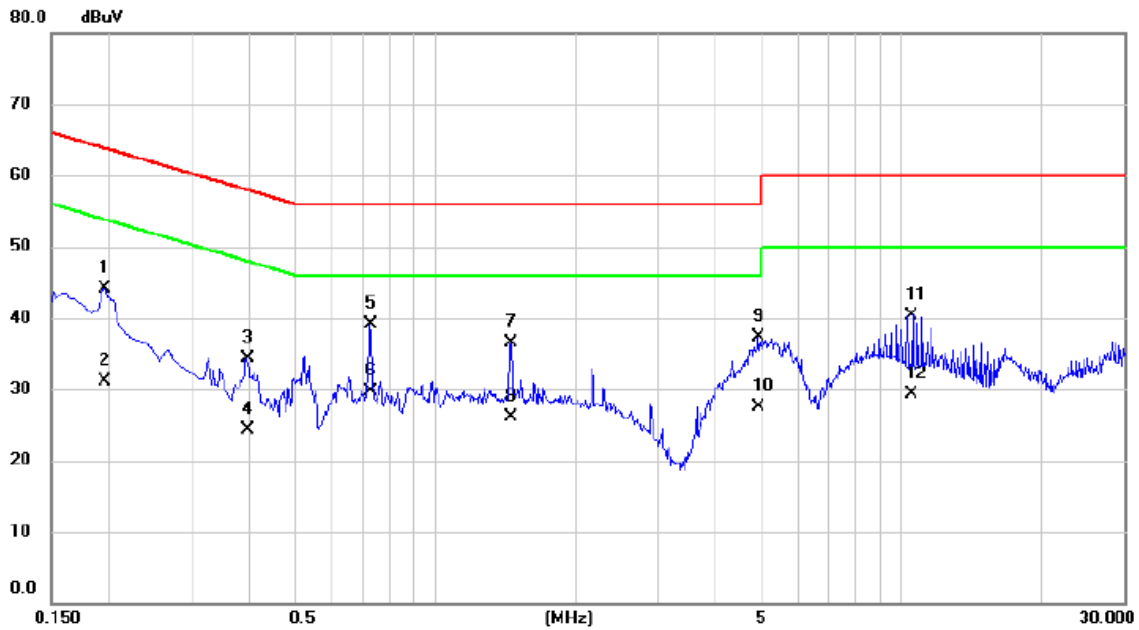

No.	Mk.	Freq. MHz	Reading Level dBuV	Correct Factor dB	Measure- ment dBuV	Limit dBuV	Margin dB	Detector	Comment
1		0.1950	34.43	9.73	44.16	63.82	-19.66	QP	
2		0.1950	21.30	9.73	31.03	53.82	-22.79	AVG	
3		0.3952	24.49	9.79	34.28	57.95	-23.67	QP	
4		0.3952	14.50	9.79	24.29	47.95	-23.66	AVG	
5		0.7260	29.32	9.83	39.15	56.00	-16.85	QP	
6	*	0.7260	19.80	9.83	29.63	46.00	-16.37	AVG	
7		1.4505	26.71	9.89	36.60	56.00	-19.40	QP	
8		1.4505	16.30	9.89	26.19	46.00	-19.81	AVG	
9		4.9245	27.16	10.15	37.31	56.00	-18.69	QP	
10		4.9245	17.40	10.15	27.55	46.00	-18.45	AVG	
11		10.5405	29.91	10.49	40.40	60.00	-19.60	QP	
12		10.5405	18.90	10.49	29.39	50.00	-20.61	AVG	

5. HARMONIC AND FLICKER TEST

5.1 HARMONIC CURRENT EMISSIONS

5.1.1 LIMITS

The power consumption is less than 75W, there is no limit applied.

5.1.2 MEASUREMENT INSTRUMENTS LIST

Item	Kind of Equipment	Manufacturer	Type No.	Series Model	Calibrated until
1	Harmonics and Flicker Analyzer	California Instruments	PACS-1	72344	Jul. 03, 2023
2	3KVA AC Power source	California Instruments	3001ix	56309	Jul. 03, 2023
3	Measurement Software	California	CTS4.0 Version 4.29	N/A	N/A

Remark: "N/A" denotes no model no., no serial No. or no calibration specified.

All calibration period of equipment list is one year.

5.1.3 TEST PROCEDURE

- The EUT was placed on the top of a wooden table 0.8 meters above the ground and operated to produce the maximum harmonic components under normal operating conditions.
- The classification of EUT is according to of EN 61000-3-2. The EUT is classified as Class D.
- The correspondent test program of test instrument to measure the current harmonics emanated from EUT is chosen. The measure time shall be not less than the time necessary for the EUT to be exercised.

5.1.4 DEVIATION FROM TEST STANDARD

No deviation

5.1.5 TEST SETUP

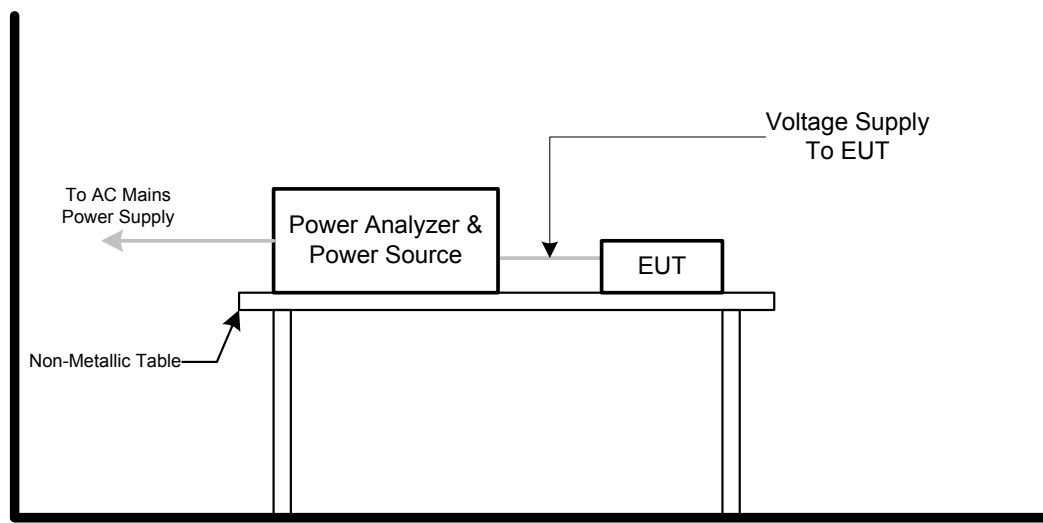

5.1.6 TEST RESULTS

Harmonic - Class D	
Test Voltage	AC 230V/50Hz
Test Mode	Mode 1

Current & voltage waveforms



Harmonics and Class D limit line European Limits

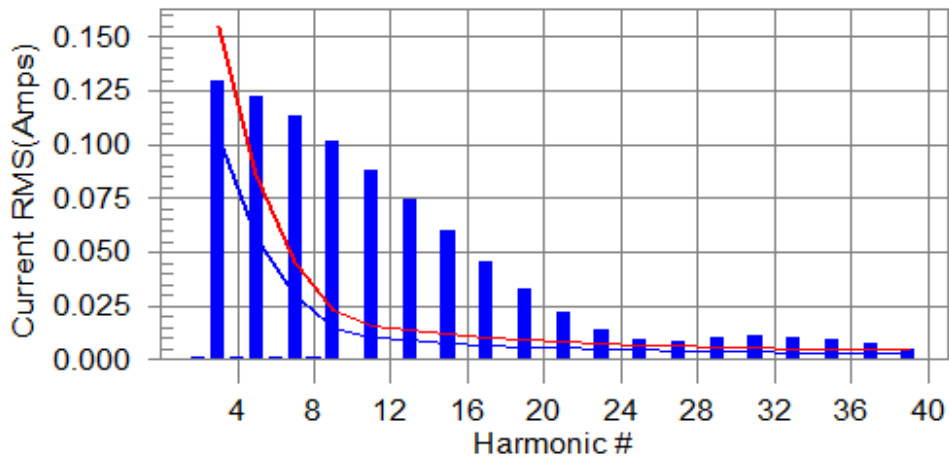

Test result: N/L Worst harmonics H0-0.0% of 150% limit, H0-0% of 100% limit

Current Test Result Summary (Run time)

Test Voltage	AC 230V/50Hz
Test Mode	Mode 1

Highest parameter values during test:

V _{RMS} (Volts):	229.93	Frequency(Hz):	50.00
I _{Peak} (Amps):	1.331	I _{RMS} (Amps):	0.309
I _{Fund} (Amps):	0.138	Crest Factor:	4.312
Power (Watts):	30.4	Power Factor:	0.431

Harm#	Harms(avg)	100%Limit	%of Limit	Harms(max)	150%Limit	%of Limit	Status
2	0.002	0.000	N/A	0.002	0.000	N/A	N/L
3	0.129	0.103	N/A	0.131	0.155	N/A	N/L
4	0.001	0.000	N/A	0.002	0.000	N/A	N/L
5	0.122	0.058	N/A	0.123	0.087	N/A	N/L
6	0.001	0.000	N/A	0.002	0.000	N/A	N/L
7	0.113	0.030	N/A	0.113	0.046	N/A	N/L
8	0.001	0.000	N/A	0.001	0.000	N/A	N/L
9	0.101	0.015	N/A	0.102	0.023	N/A	N/L
10	0.001	0.000	N/A	0.001	0.000	N/A	N/L
11	0.088	0.011	N/A	0.089	0.016	N/A	N/L
12	0.001	0.000	N/A	0.001	0.000	N/A	N/L
13	0.074	0.009	N/A	0.075	0.014	N/A	N/L
14	0.001	0.000	N/A	0.001	0.000	N/A	N/L
15	0.060	0.008	N/A	0.060	0.012	N/A	N/L
16	0.001	0.000	N/A	0.001	0.000	N/A	N/L
17	0.046	0.007	N/A	0.047	0.010	N/A	N/L
18	0.001	0.000	N/A	0.001	0.000	N/A	N/L
19	0.033	0.006	N/A	0.034	0.009	N/A	N/L
20	0.001	0.000	N/A	0.001	0.000	N/A	N/L
21	0.022	0.006	N/A	0.023	0.008	N/A	N/L
22	0.001	0.000	N/A	0.001	0.000	N/A	N/L
23	0.014	0.005	N/A	0.014	0.008	N/A	N/L
24	0.001	0.000	N/A	0.001	0.000	N/A	N/L
25	0.009	0.005	N/A	0.010	0.007	N/A	N/L
26	0.001	0.000	N/A	0.001	0.000	N/A	N/L
27	0.009	0.004	N/A	0.009	0.007	N/A	N/L
28	0.001	0.000	N/A	0.001	0.000	N/A	N/L
29	0.010	0.004	N/A	0.010	0.006	N/A	N/L
30	0.000	0.000	N/A	0.001	0.000	N/A	N/L
31	0.011	0.004	N/A	0.011	0.006	N/A	N/L
32	0.000	0.000	N/A	0.001	0.000	N/A	N/L
33	0.011	0.004	N/A	0.011	0.005	N/A	N/L
34	0.000	0.000	N/A	0.000	0.000	N/A	N/L
35	0.009	0.003	N/A	0.009	0.005	N/A	N/L
36	0.000	0.000	N/A	0.000	0.000	N/A	N/L
37	0.007	0.003	N/A	0.008	0.005	N/A	N/L
38	0.000	0.000	N/A	0.000	0.000	N/A	N/L
39	0.005	0.003	N/A	0.005	0.005	N/A	N/L
40	0.000	0.000	N/A	0.000	0.000	N/A	N/L

Note: The EUT power level is below 75.0 Watts and therefore has no defined limits

Voltage Source Verification Data (Run time)	
Test Voltage	AC 230V/50Hz
Test Mode	Mode 1

Highest parameter values during test:

Voltage (Vrms):	229.93	Frequency(Hz):	50.00
I_Peak (Amps):	1.331	I_RMS (Amps):	0.309
I_Fund (Amps):	0.138	Crest Factor:	4.312
Power (Watts):	30.4	Power Factor:	0.431

Harm#	Harmonics V-rms	Limit V-rms	% of Limit	Status
2	0.106	0.460	23.01	OK
3	0.555	2.069	26.80	OK
4	0.065	0.460	14.07	OK
5	0.036	0.919	3.95	OK
6	0.037	0.460	8.00	OK
7	0.069	0.690	10.04	OK
8	0.019	0.460	4.13	OK
9	0.042	0.460	9.15	OK
10	0.021	0.460	4.59	OK
11	0.062	0.230	27.10	OK
12	0.019	0.230	8.08	OK
13	0.050	0.230	21.85	OK
14	0.019	0.230	8.06	OK
15	0.051	0.230	22.15	OK
16	0.017	0.230	7.30	OK
17	0.035	0.230	15.21	OK
18	0.014	0.230	6.03	OK
19	0.039	0.230	16.97	OK
20	0.018	0.230	7.70	OK
21	0.021	0.230	9.16	OK
22	0.013	0.230	5.60	OK
23	0.019	0.230	8.36	OK
24	0.006	0.230	2.53	OK
25	0.013	0.230	5.46	OK
26	0.008	0.230	3.41	OK
27	0.013	0.230	5.76	OK
28	0.008	0.230	3.42	OK
29	0.021	0.230	9.13	OK
30	0.006	0.230	2.42	OK
31	0.017	0.230	7.54	OK
32	0.007	0.230	2.94	OK
33	0.021	0.230	8.94	OK
34	0.004	0.230	1.78	OK
35	0.016	0.230	6.85	OK
36	0.003	0.230	1.43	OK
37	0.015	0.230	6.50	OK
38	0.003	0.230	1.36	OK
39	0.008	0.230	3.40	OK
40	0.006	0.230	2.77	OK

5.2 VOLTAGE CHANGES, VOLTAGE FLUCTUATIONS AND FLICKER TEST

5.2.1 LIMITS

Tests	Limits	Descriptions
	EN 61000-3-3	
Pst	≤ 1.0 , $T_p= 10$ min.	Short Term Flicker Indicator
Plt	≤ 0.65 , $T_p=2$ hr.	Long Term Flicker Indicator
dc	$\leq 3.3\%$	Relative Steady-State V-Chang
dmax	$\leq 4\%$	Maximum Relative V-change
d (t)	≤ 500 ms	Relative V-change characteristic

5.2.2 MEASUREMENT INSTRUMENTS LIST

Item	Kind of Equipment	Manufacturer	Type No.	Series Model	Calibrated until
1	Harmonics and Flicker Analyzer	California Instruments	PACS-1	72344	Jul. 03, 2023
2	3KVA AC Power source	California Instruments	3001ix	56309	Jul. 03, 2023
3	Measurement Software	California	CTS4.0 Version 4.29	N/A	N/A

Remark: "N/A" denotes no model no., no serial No. or no calibration specified.

All calibration period of equipment list is one year.

5.2.3 TEST PROCEDURE

- Tests was performed according to the Test Conditions/Assessment of Voltage Fluctuations specified in EN 61000-3-3 depend on which standard adopted for compliance measurement.
- All types of harmonic current and/or voltage fluctuation in this report are assessed by direct measurement using flicker-meter.

5.2.4 DEVIATION FROM TEST STANDARD

No deviation

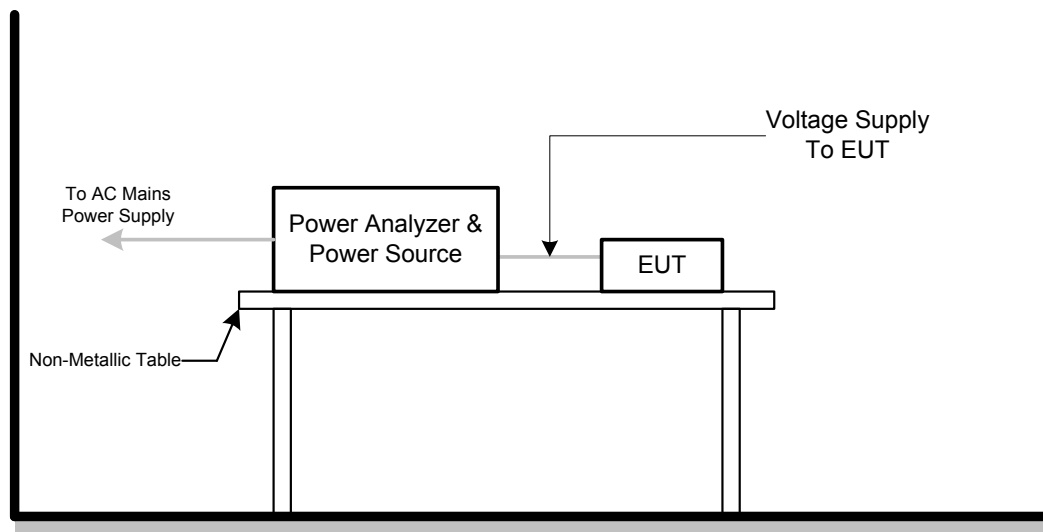
5.2.5 TEST SETUP

5.2.6 TEST RESULTS

Test Voltage	AC 230V/50Hz
Test Mode	Mode 1

Pst and limit line

European Limits

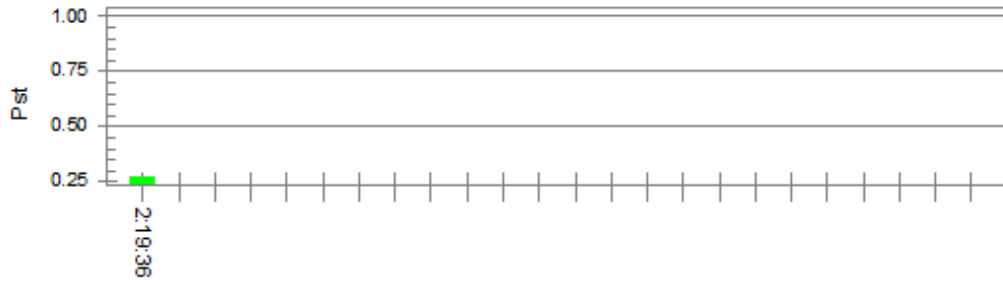

Plt and limit line

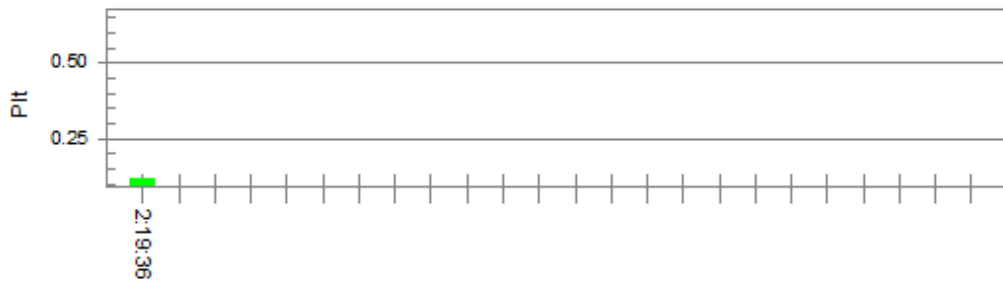

Parameter values recorded during the test:

Vrms at the end of test (Volt): 229.81

Highest dt (%):

T-max (mS): 0

Highest dc (%): 0.00

Highest dmax (%): 0.00

Highest Pst (10 min. period): 0.273

Highest Plt (2 hr. period): 0.119

Test limit (%):

Test limit (mS): 500.0 Pass

Test limit (%): 3.30 Pass

Test limit (%): 4.00 Pass

Test limit: 1.000 Pass

Test limit: 0.650 Pass

6. EMC IMMUNITY TEST

6.1 STANDARD COMPLIANCE/SEVERITY LEVEL/CRITERIA

Tests Standard No.	Test Specification Level / Test Mode	Test Ports	Criteria
Electrostatic discharge IEC 61000-4-2 (ESD)	±8kV air discharge ±4kV contact discharge (Direct Mode)	Enclosure	B
	±4kV HCP discharge ±4kV VCP discharge (Indirect Mode)	Enclosure	B
Continuous RF electromagnetic field disturbances,swept test IEC 61000-4-3 (RS)	80 MHz to 1000 MHz 3V/m(unmodulated, r.m.s), 1 kHz, 80%, AM modulated	Enclosure	A
Continuous RF electromagnetic field disturbances,spot test IEC 61000-4-3 (RS)	1800 MHz, 2600MHz, 3500 MHz, 5000MHz(±1 %) 3V/m(unmodulated, r.m.s), 1 kHz, 80%, AM modulated	Enclosure	A
Electrical fast transient/burst immunity IEC 61000-4-4 (EFT)	±0.5kV(peak) 5/50ns Tr/Th 5kHz Repetition Frequency (100kHz Repetition Frequency for xDSL port)	Analogue/digital data ports (NOTE 2)	B
	±0.5kV(peak) 5/50ns Tr/Th 5kHz Repetition Frequency	DC network power ports (NOTE 2)	B
	±1 kV(peak) 5/50ns Tr/Th 5kHz Repetition Frequency	AC mains power ports	B

Surge immunity IEC 61000-4-5 (Surge)	Port Type: unshielded symmetrical		
	Apply: lines to ground		
	Primary protection is Intended ±1 kV 10/700(5/320)Tr/Th µs	Analogue/digital data ports (NOTE 1) & (NOTE 2)	C
	Primary protection is not Intended ±1 kV 10/700(5/320) Tr/Th µs		C
	Port type: coaxial or shielded		
	Apply: shield to ground		
±0.5 kV 1.2/50(8/20) Tr/Th µs	Analogue/digital data ports (NOTE 1) & (NOTE 2)	B	
line to reference ground for each individual line: ±0.5 kV(peak) 1.2/50(8/20) Tr/Th µs	DC network power ports (NOTE 2)	B	
±1 kV(peak) 1.2/50(8/20) Tr/Th µs (line to line) ±2 kV(peak) 1.2/50(8/20) Tr/Th µs (line to earth or ground)	AC mains power ports	B	
Continuous induced RF disturbances IEC 61000-4-6 (CS)	0.15 MHz to 10 MHz 3V(unmodulated, r.m.s), 10 MHz to 30 MHz 3V to 1V(unmodulated, r.m.s), 30 MHz to 80 MHz 1V(unmodulated, r.m.s), 1kHz 80%, AM 150Ω source impedance	Analogue/digital data ports (NOTE 2)	A
	0.15 MHz to 10 MHz 3V(unmodulated, r.m.s), 10 MHz to 30 MHz 3V to 1V(unmodulated, r.m.s), 30 MHz to 80 MHz 1V(unmodulated, r.m.s), 1kHz 80%, AM 150Ω source impedance	DC network power ports (NOTE 2)	A
	0.15 MHz to 10 MHz 3V(unmodulated, r.m.s), 10 MHz to 30 MHz 3V to 1V(unmodulated, r.m.s), 30 MHz to 80 MHz 1V(unmodulated, r.m.s), 1kHz 80%, AM 150Ω source impedance	AC mains power ports	A

Power frequency magnetic field immunity IEC 61000-4-8 (PFMF)	50 Hz or 60Hz, 1A/m(r.m.s)	Enclosure	A
Voltage dips, short interruptions and voltage variations immunity IEC 61000-4-11 (Dips)	Voltage dips: Residual voltage < 5% 0.5 cycle Residual voltage < 70% 25 cycle(50Hz), 30 cycle (60Hz) Voltage interruptions: Residual voltage < 5% 250 cycle (50Hz), 300 cycle (60Hz)	AC Power Ports	B C C
Broadband impulse noise disturbances, repetitive (BIN-R)	0.15MHz to 0.5 MHz 107dBuV 0.5 MHz to 10 MHz 107dBuV to 36dBuV 10 MHz to 30 MHz 36dBuV to 30 dBuV	Analogue/digital data ports (Applicable only to CPE xDSL ports)	A
	0.70 ms 8.3 ms(for 60Hz) 10 ms(for 50Hz)	Analogue/digital data ports (Apply period based on the AC mains frequency)	A
Broadband impulse noise disturbances, isolated (BIN-I)	0.15MHz to 30 MHz 110dBuV	Analogue/digital data ports (Applicable only to CPE xDSL ports)	B
	0.24 ms 10 ms 300 ms	Analogue/digital data ports (Apply all burst durations)	B

Note.

- 1) Applicable only to ports which, according to the manufacturer's specification, may connect directly to outdoor cables.
- 2) Applicable only to ports which, according to the manufacturer's specification, support cable lengths greater than 3 m.

6.2 GENERAL PERFORMANCE CRITERIA

According to **EN55035** standard, the general performance criteria as following:

Criterion A	<p>The equipment shall continue to operate as intended without operator intervention. No degradation of performance, loss of function or change of operating state is allowed below a performance level specified by the manufacturer when the equipment is used as intended. The performance level may be replaced by a permissible loss of performance. If the minimum performance level or the permissible performance loss is not specified by the manufacturer, then either of these may be derived from the product description and documentation, and by what the user may reasonably expect from the equipment if used as intended.</p>
Criterion B	<p>During the application of the disturbance, degradation of performance is allowed. However, nonintended change of actual operating state or stored data is allowed to persist after the test.</p> <p>After the test, the equipment shall continue to operate as intended without operator intervention; no degradation of performance or loss of function is allowed, below a performance level specified by the manufacturer, when the equipment is used as intended. The performance level may be replaced by a permissible loss of performance. If the minimum performance level (or the permissible performance loss), or recovery time, is not specified by the manufacturer, then either of these may be derived from the product description and documentation, and by what the user may reasonably expect from the equipment if used as intended.</p>
Criterion C	<p>Loss of function is allowed, provided the function is self-recoverable, or can be restored by the operation of the controls by the user in accordance with the manufacturer's instructions. Areboot or re-start operation is allowed.</p> <p>Information stored in non-volatile memory, or protected by a battery backup, shall not be lost.</p>

6.3 ANNEX D (NORMATIVE) - DISPLAY AND DISPLAY OUTPUT FUNCTION

6.3.1 PERFORMANCE CRITERIA

Performance criterion A

for continuous radiated and conducted disturbances tests:

Apply criterion A as defined in GENERAL PERFORMANCE CRITERIA. Additionally, an increase in any degradation greater than just perceptible by observation of the image shall not occur as a consequence of the application of the test. Examples of such degradations are:

- superimposed patterning;
- positional disturbances due to synchronisation errors;
- geometric distortion;
- change of contrast or brightness;
- picture artefacts;
- freezing or disturbance of motion;
- image loss;
- video data or decoding errors.

Performance criterion A

for the power frequency magnetic field tests:

Alternative 1: A continuous magnetic field of 1 A/m:

The jitter (in mm) shall not exceed the value
$$\frac{(\text{character height in mm} + 0,3) \times 2,5}{33,3}$$

Performance criterion B:

Apply criterion B as defined in GENERAL PERFORMANCE CRITERIA.

Performance criterion C:

Apply criterion C as defined in GENERAL PERFORMANCE CRITERIA.

6.4 ANNEX G (NORMATIVE) - AUDIO OUTPUT FUNCTION

6.4.1 PERFORMANCE CRITERIA

Performance criterion A:

For devices that support telephony functions the limits of Table G.3 shall apply.

With respect to Table G.3:

- the interference ratio (electrical or acoustic) shall meet the limits in column 3; or,
- the acoustic level of the demodulated audio shall be less than the limits in column 4; or,
- the digitally coded level of demodulated audio shall be less than limits in column 5; or,
- the analogue level of the demodulated audio shall be less than the limits in column 6.

Table G.3 – Performance criterion A – Limits for devices supporting telephony

Type of immunity test	Frequency range MHz	Acoustic or electrical interference ratio	Equivalent direct measurement		
			dB (SPL)	Digital dBm0	Analogue dBm
Conducted	0,15 to 30	-20 dB	55	-50	-50
	30 to 80	-10 dB	65	-40	-40
Radiated	80 to 1000	0 dB	75	-30	-30

For terminals connected to digital wired network ports (such as Ethernet, ISDN), measurements of the demodulated 1 kHz may be performed on a remote AE, ideally of the same design.

For all other devices:

The measured acoustic interference ratio and/or the measured electrical interference ratio during the test shall be –20 dB or better.

Performance criterion B:

Use the general performance criterion B. See GENERAL PERFORMANCE CRITERIA.

Performance criterion C:

Use the general performance criterion C. See GENERAL PERFORMANCE CRITERIA.

6.5 ELECTROSTATIC DISCHARGE IMMUNITY TEST (ESD)

6.5.1 TEST SPECIFICATION

Basic Standard	IEC 61000-4-2
Discharge Impedance	330 ohm / 150 pF
Required Performance	B
Discharge Voltage	Air Discharge: $\pm 2\text{kV}$, $\pm 4\text{kV}$, $\pm 8\text{kV}$ Contact Discharge: $\pm 2\text{kV}$, $\pm 4\text{kV}$
Polarity	Positive & Negative
Number of Discharge	20 times at each test point
Discharge Mode	Single Discharge
Discharge Period	1 second

6.5.2 MEASUREMENT INSTRUMENTS

Item	Kind of Equipment	Manufacturer	Type No.	Series Model	Calibrated until
1	ESD Generator	TESEQ AG	NSG 437	450	Dec. 01, 2022

Remark: "N/A" denotes no model no., no serial No. or no calibration specified.

All calibration period of equipment list is one year.

6.5.3 TEST PROCEDURE

The test generator necessary to perform direct and indirect application of discharges to the EUT in the following manner:

- a. The test shall be performed with single discharges. On each pre-selected point at least 10 single discharges (in the most sensitive polarity) shall be applied.

NOTE 1 The minimum number of discharges applied is depending on the EUT; for products with synchronized circuits the number of discharges should be larger.

For the time interval between successive single discharges an initial value of 1 s is recommended. Longer intervals may be necessary to determine whether a system failure has occurred.

NOTE 2 The points to which the discharges should be applied may be selected by means of an exploration carried out at a repetition rate of 20 discharges per second, or more.

Vertical Coupling Plane (VCP):

The coupling plane, of dimensions 0.5m x 0.5m, is placed parallel to, and positioned at a distance 0.1m from, the EUT, with the Discharge Electrode touching the coupling plane.

The four faces of the EUT will be performed with electrostatic discharge.

Horizontal Coupling Plane (HCP):

The coupling plane is placed under to the EUT. The generator shall be positioned vertically at a distance of 0.1m from the EUT, with the Discharge Electrode touching the coupling plane.

The four faces of the EUT will be performed with electrostatic discharge.

- b. For TABLE-TOP equipment:

The configuration consisted of a wooden table 0.8 meters high standing on the Ground Reference Plane. The GRP consisted of a sheet of aluminum at least 0.25mm thick, and 2.5 meters square connected to the protective grounding system. A Horizontal Coupling Plane (1.6m x 0.8m) was placed on the table and attached to the GRP by means of a cable with 940k total impedance. The equipment under test was installed in a representative system as described in IEC 61000-4-2, and its cables were placed on the HCP and isolated by an insulating support of 0.5mm thickness. A distance of 1-meter minimum was provided between the EUT and the walls of the laboratory and any other metallic structure.

6.5.4 DEVIATION FROM TEST STANDARD

No deviation

6.5.5 TEST SETUP

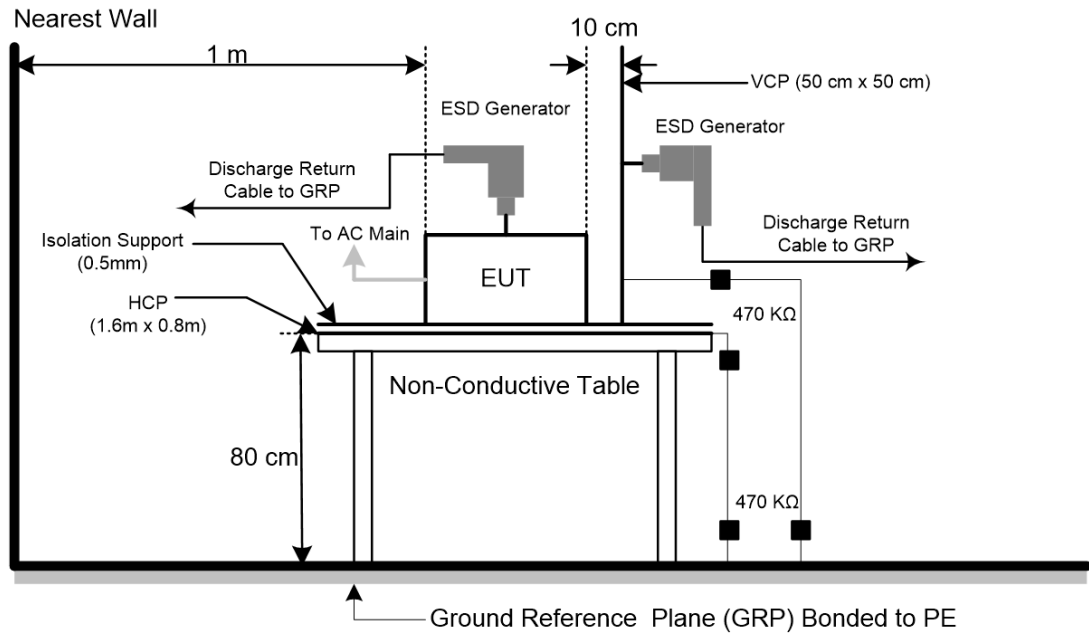

6.5.6 TEST RESULTS

Test Voltage	AC 230V/50Hz
Test Mode	Mode 1-5

Mode	Air Discharge								Contact Discharge					
	2kV		4kV		8kV		- kV		2kV		4kV		- kV	
Location	P	N	P	N	P	N	P	N	P	N	P	N	P	N
1	A	A	B	B	B	B	-	-	A	A	B	B	-	-
2	A	A	A	A	B	B	-	-	-	-	-	-	-	-
3	A	A	A	A	A	A	-	-	-	-	-	-	-	-
4	A	A	A	A	A	A	-	-	-	-	-	-	-	-
5	A	A	A	A	A	A	-	-	-	-	-	-	-	-
Criteria	B						-		B				-	
Result	B						-		B				-	

Mode	HCP Contact Discharge						VCP Contact Discharge					
	2kV		4kV		- kV		2kV		4kV		- kV	
Location	P	N	P	N	P	N	P	N	P	N	P	N
Left side	A	A	B	B	-	-	A	A	B	B	-	-
Right side	A	A	A	A	-	-	A	A	A	A	-	-
Front side	A	A	A	A	-	-	A	A	A	A	-	-
Rear side	A	A	A	A	-	-	A	A	A	A	-	-
Criteria	B				-		B				-	
Result	B				-		B				-	

Note:

- 1) P/N denotes the Positive/Negative polarity of the output voltage.
- 2) N/A - denotes test is not applicable in this test report

PHOTO(S) SHOWN THE LOCATION(S) OF ESD EVALUATED

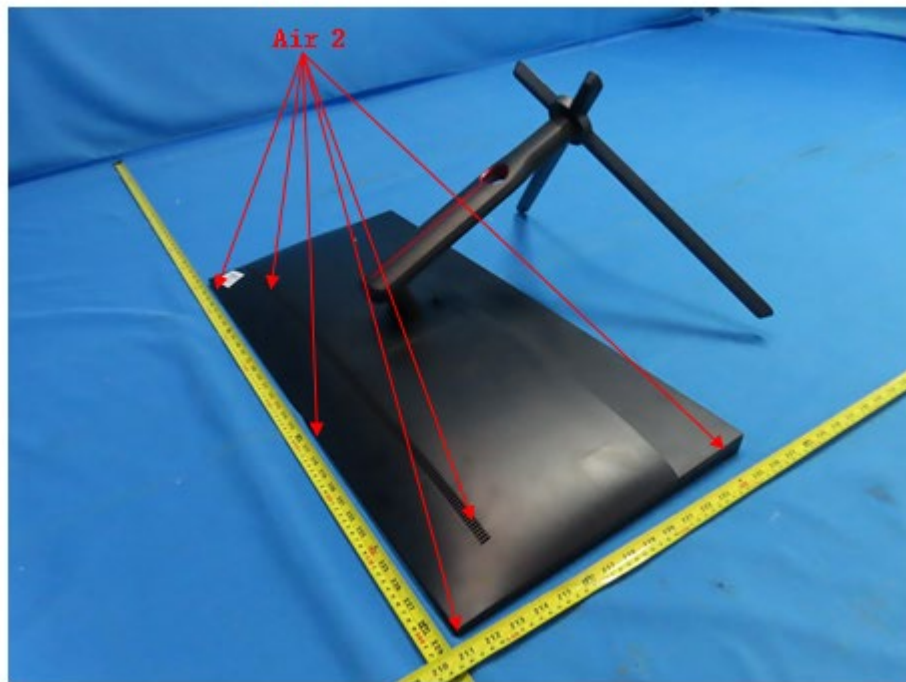
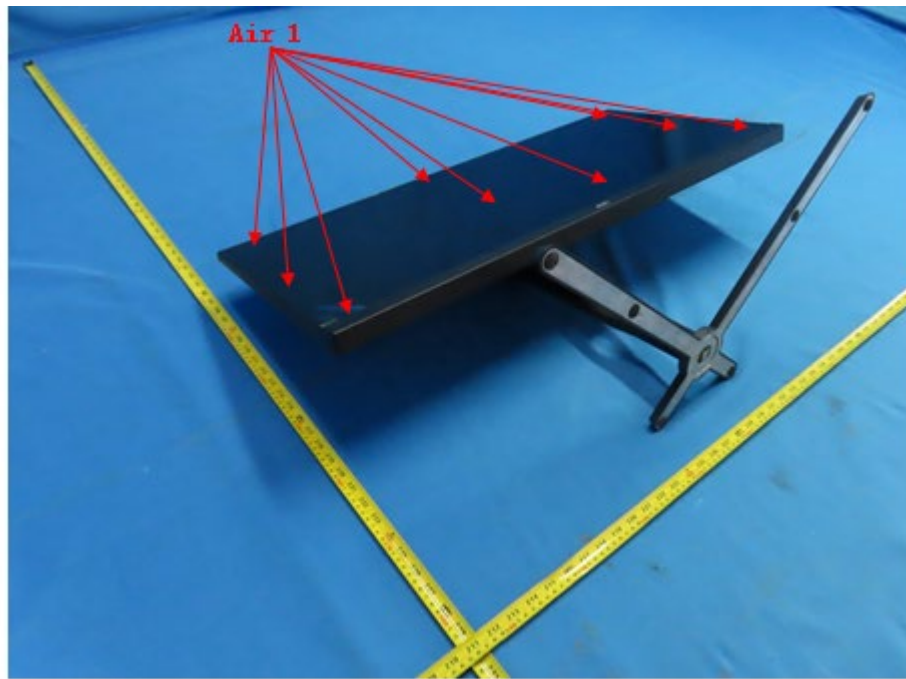

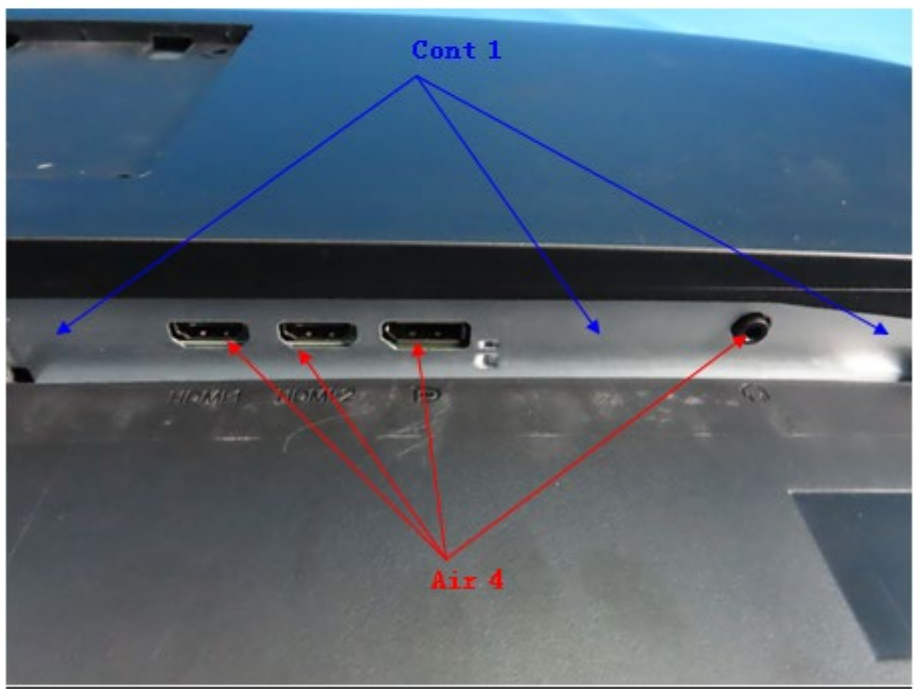
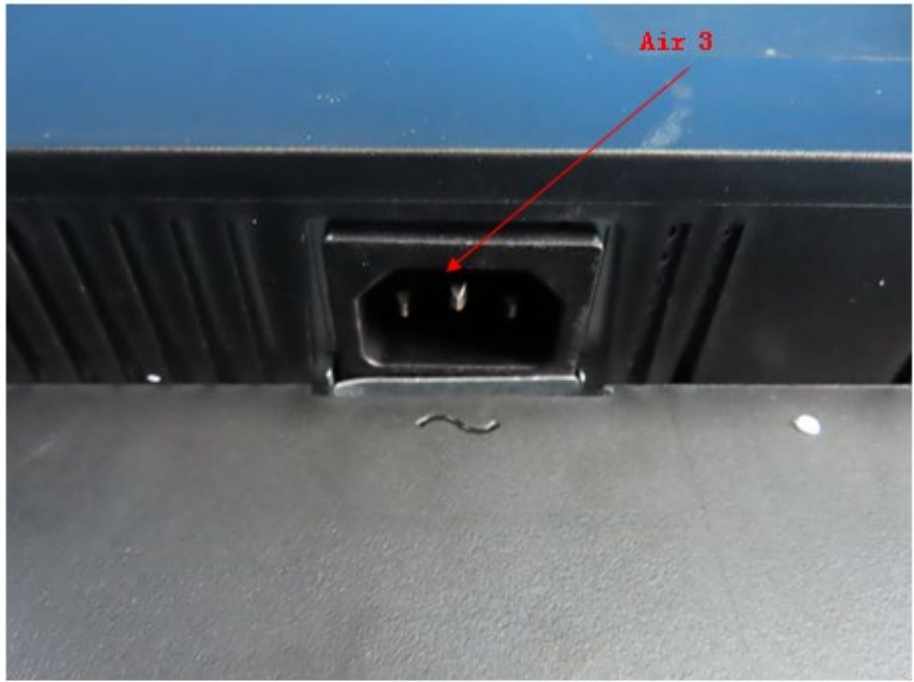



6.6 RADIATED, RADIO-FREQUENCY, ELECTROMAGNETIC FIELD IMMUNITY TEST (RS)

6.6.1 TEST SPECIFICATION

Basic Standard	IEC 61000-4-3
Required Performance	A
Frequency Range	80 MHz - 1000 MHz, 1800 MHz, 2600 MHz, 3500 MHz, 5000MHz(±1%)
Field Strength	3 V/m(unmodulated, r.m.s)
Modulation	1 kHz Sine Wave, 80%, AM Modulation
Frequency Step	1% of fundamental
Polarity of Antenna	Horizontal and Vertical
Test Distance	3 m
Antenna Height	1.55 m
Dwell Time	3 seconds

6.6.2 MEASUREMENT INSTRUMENTS

Item	Kind of Equipment	Manufacturer	Type No.	Series Model	Calibrated until
1	Antenna	ETS	3142C	47662	Jan. 11, 2023
2	Amplifier	AR	50S1G4A	326720	Jan. 23, 2023
3	MXG Analog Signal Generator	Agilent	N5181A	MY49060710	Jul. 03, 2023
4	Power amplifier	MILMEGA	AS1860-50	1064834	Jan. 23, 2023
5	Microwave Log.-Per. Antenna	Schwarzbeck	STLP 9149	9149-277	Apr. 18, 2023
6	Power amplifier	MILMEGA	80RF1000-250	1064833	Jan. 23, 2023
7	Measurement Software	Farad	(EZ-RS)V2.0.1.3	N/A	N/A
8	Conditioning Amplifier	B&K	_2690__0F2_	2723746	Jun. 09, 2023
9	Free-field 1/2` Microphone	B&K	4190-L-001	2878077	Jun. 11, 2023
10	UPV Audio Analyzer	R&S	UPV	104259	Jan. 23, 2023

Remark: "N/A" denotes no model no., no serial No. or no calibration specified.

All calibration period of equipment list is one year.

6.6.3 TEST PROCEDURE

The EUT and support equipment are in a fully-anechoic chamber.

The testing distance from antenna to the EUT was 3 meters.

For TABLE-TOP equipment:

The EUT installed in a representative system as described in IEC 61000-4-3 was placed on a non-conductive table 0.8 meters in height. The system under test was connected to the power and signal wire according to relevant installation instructions.

The other condition as following manner:

- The field strength level was 3 V/m(unmodulated, r.m.s).
- The frequency range is swept from 80 MHz to 1000 MHz, with the signal 80%amplitude modulated with a 1 kHz sine wave. The rate of sweep did not exceed 1.5×10^{-3} decade/s. Where the frequency range is swept incrementally, the step size was 1% of fundamental.
- The dwell time at each frequency shall be not less than the time necessary for the EUT to be able to respond.
- The test was performed with the EUT exposed to both vertically and horizontally polarized fields on each of the four sides.

For Display and display output functions:

- a. The display quality evaluated by direct observation.
- b. For display output function evaluation, a suitable display device shall be connected. This device shall meet the immunity requirements for displays specified in this document. The screen size shall be typical for the display output. the diagonal screen size shall be at least 0,50 m.
- c. The display shall be observed under normal viewing conditions including viewing distance using a reduced ambient light level preferably in the range 15 lx to 20 lx. The viewing distance or settings of the video camera monitoring system shall be sufficient to provide visibility of the whole display. In the case of direct observation the selected viewing distance shall be recorded in the test report.

For Acoustic measurements:

- a. Apply an appropriate input signal to the EUT so that a sine wave (tone) at the frequency that will be used to modulate the applied disturbance (typically 1 kHz) is generated from the port under test at a level equal to the acoustic reference level.
- b. Record the resulting dB (SPL) level (or other appropriate dB unit) as the value of L_0 . (BTL lab uses the software to take L_0 as the reference value and make it return to zero.)
- c. Change the input to the EUT so that the port under test is silent, or represents silence. This change shall not alter the terminating impedance at the EUT's input.
- d. Apply the RF disturbance to the applicable port of the EUT and record the resulting demodulated audio level in dB (SPL) (or other dB unit used in step d)) as the value of L_1 .
- e. Ensure that non-linear processing does not impact the measurements.
- f. Calculate the acoustic interference ratio using the following formula:
 Acoustic interference ratio = $L_1 - L_0$.
 (For step e-g, BTL lab proceeds the test with software and calculate Acoustic interference ratio = $L_1 - L_0$).

6.6.4 DEVIATION FROM TEST STANDARD

No deviation

6.6.5 TEST SETUP

- a) For Continuous induced RF disturbances

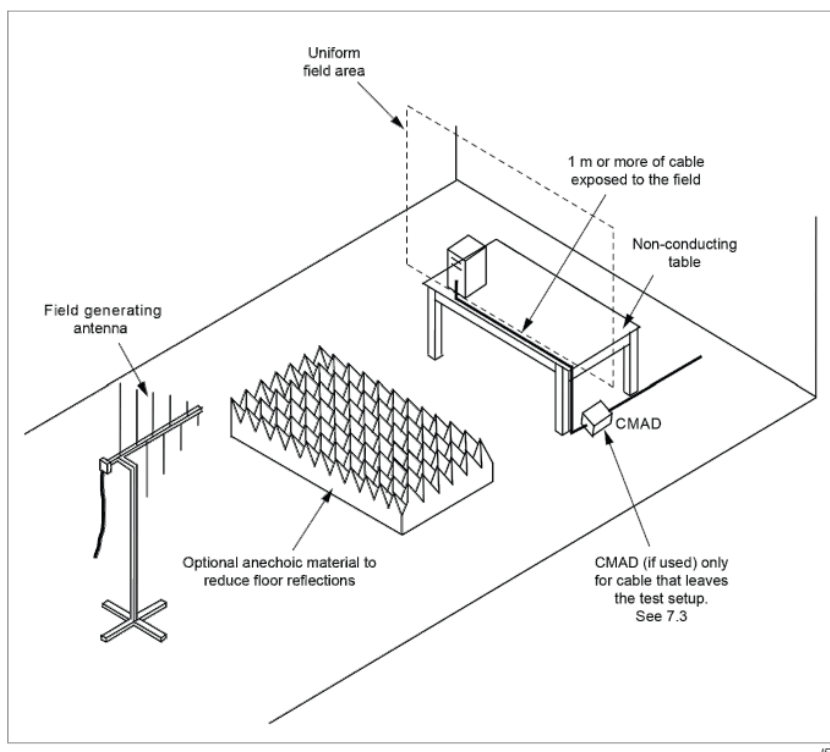

For Audio output function

(1) Audio output port

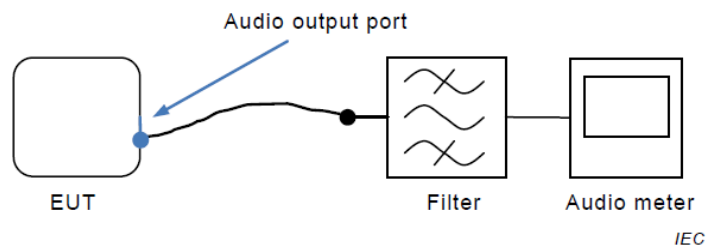

The filter is the audio filter specified in G.6.1 and is typically incorporated into the audio meter. Additional filtering might be necessary to ensure that the RF disturbance signal does not interfere with the measurement.

6.6.6 TEST RESULTS

Test Voltage	AC 230V/50Hz
Test Mode	Mode 1-5

Frequency Range (MHz)	RF Field Position	R.F. Field Strength	Modulation	Azimuth	Criterion	Result
80 - 1000	H / V	3V/m	AM Modulated 1000Hz, 80%	0	A	A
				90		
				180		
				270		
1800, 2600, 3500, 5000 (±1%)	H / V	3V/m	AM Modulated 1000Hz, 80%	0	A	A
				90		
				180		
				270		

For Audio output function

(1) Audio output port:

Test Voltage	AC 230V/50Hz
Test Mode	Vertical_ Rear

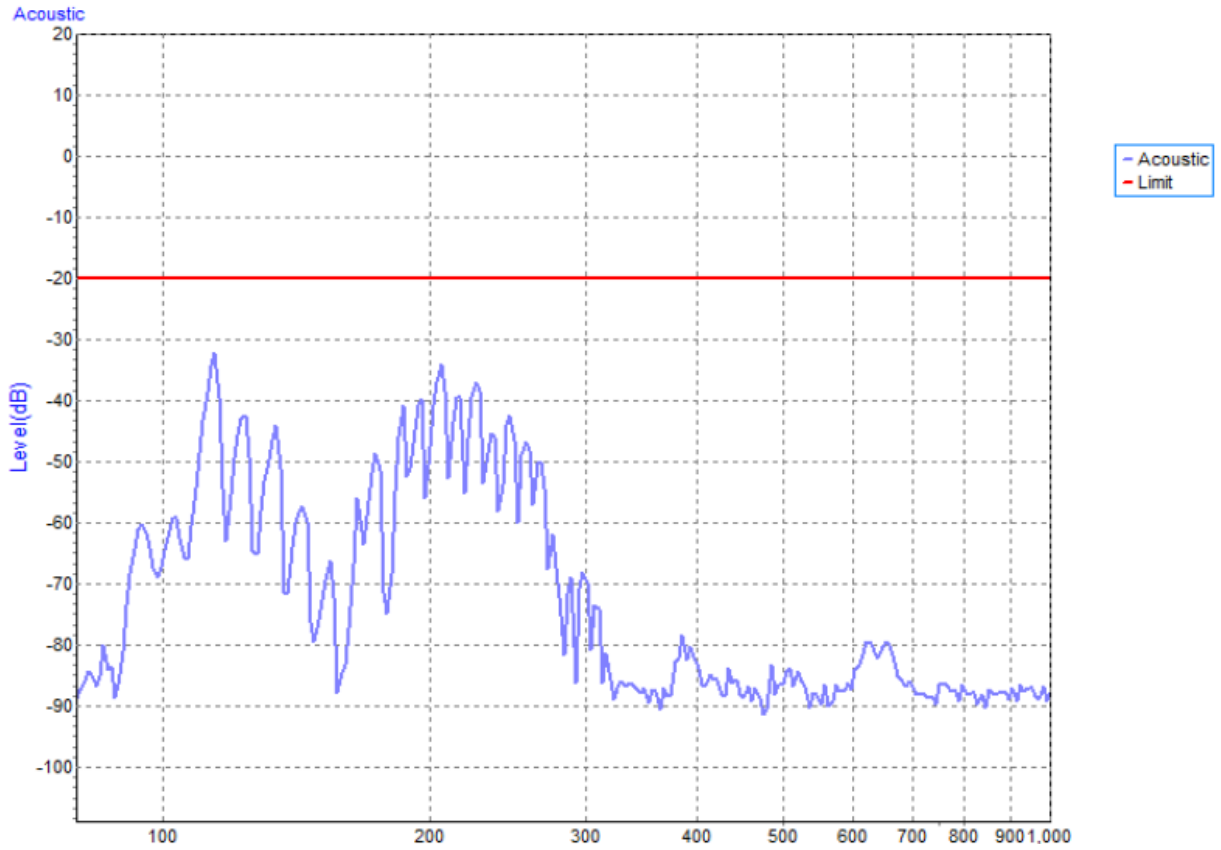

Test Voltage	AC 230V/50Hz
Test Mode	Horizontal_Rear

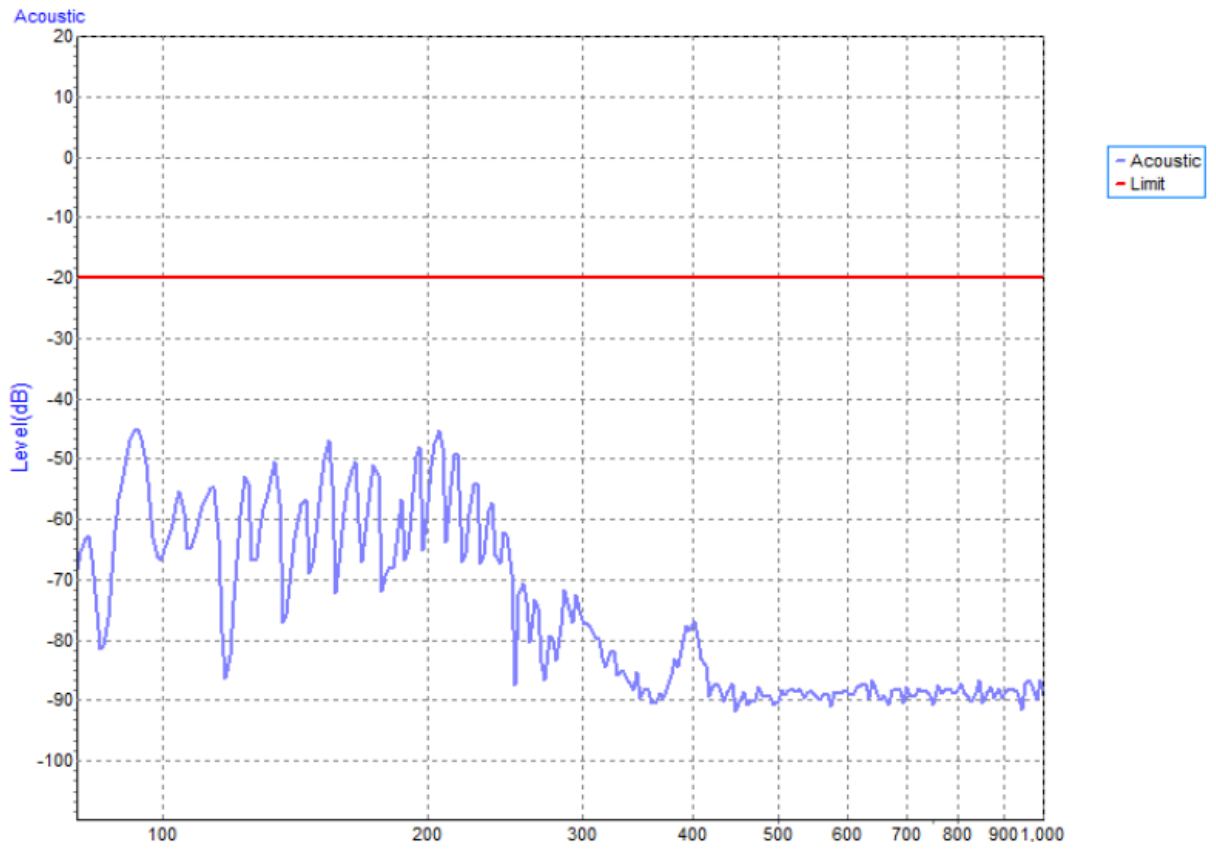

6.7 ELECTRICAL FAST TRANSIENT/BURST IMMUNITY TEST (EFT/BURST)

6.7.1 TEST SPECIFICATION

Basic Standard	IEC 61000-4-4
Required Performance	B
Test Voltage	AC Power Ports:±1 kV
Polarity	Positive & Negative
Impulse Frequency	5 kHz
Impulse Wave shape	5/50 ns
Burst Duration	15 ms
Burst Period	300 ms
Test Duration	1 min.

6.7.2 MEASUREMENT INSTRUMENTS

Item	Kind of Equipment	Manufacturer	Type No.	Series Model	Calibrated until
1	Fast Transient Burst Simulator	Prima	EFT61004TA	PR190741004	Jul. 03, 2023
2	EFT	Prima	EFT_Series V1.0.0.0.201 80710	N/A	N/A

Remark: "N/A" denotes no model no., no serial No. or no calibration specified.

All calibration period of equipment list is one year.

6.7.3 TEST PROCEDURE

For TABLE-TOP equipment:

The configuration consisted of a wooden table (0.8m high) standing on the Ground Reference Plane and should be located 0.1 m+/- 0.01m above the Ground Reference Plane. The GRP consisted of a sheet of aluminum (at least 0.25mm thick and 2.5m square) connected to the protective grounding system. A minimum distance of 0.5m was provided between the EUT and the walls of the laboratory or any other metallic structure.

The other condition as following manner:

- a. Both positive and negative polarity discharges were applied.
- b. The duration time of each test sequential was 1 minute.

6.7.4 DEVIATION FROM TEST STANDARD

No deviation

6.7.5 TEST SETUP

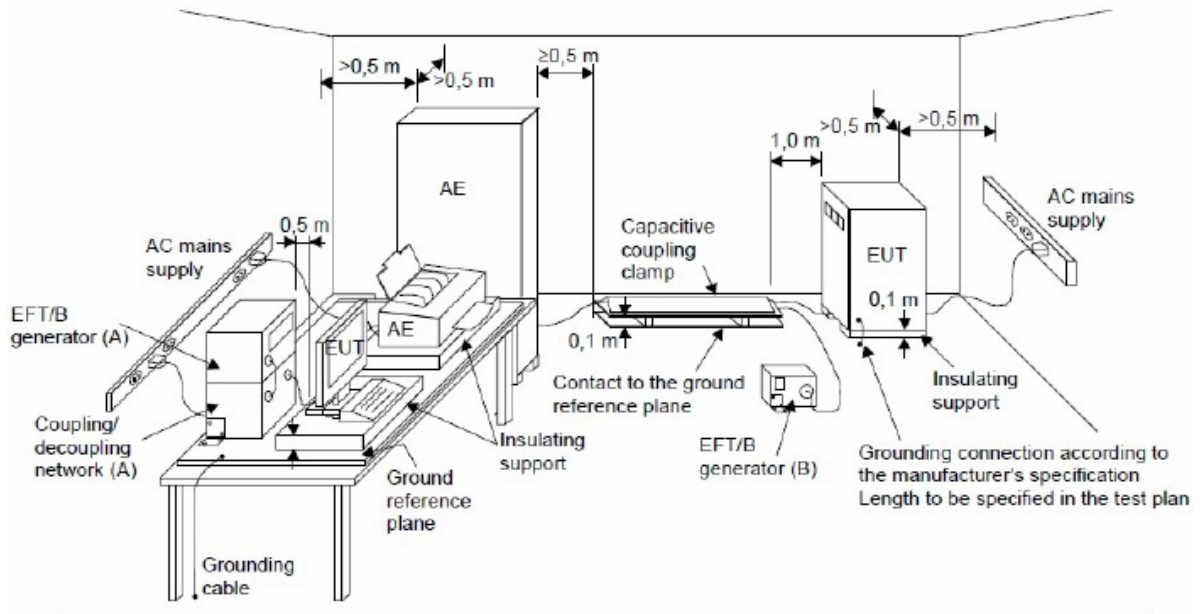

6.7.6 TEST RESULTS

Test Voltage	AC 230V/50Hz
Test Mode	Mode 1-5

EUT Ports Tested		Polarity	Repetition Frequency	Test Level	Criterion	Result
				1kV		
AC Power Port	Line (L)	+	5 kHz	B	B	B
		-	5 kHz	B		
	Neutral (N)	+	5 kHz	B	B	B
		-	5 kHz	B		
	Ground (PE)	+	5 kHz	B	B	B
		-	5 kHz	B		
	L+N	+	5 kHz	B	B	B
		-	5 kHz	B		
	L+PE	+	5 kHz	B	B	B
		-	5 kHz	B		
	N+PE	+	5 kHz	B	B	B
		-	5 kHz	B		
	L+N+PE	+	5 kHz	B	B	B
		-	5 kHz	B		

6.8 SURGE IMMUNITY TEST

6.8.1 TEST SPECIFICATION

Basic Standard	IEC 61000-4-5
Required Performance	B(AC mains power ports)
Wave-Shape	1.2/50(8/20) Tr/Th μ s combination wave
Test Voltage	AC Power Port: ± 0.5 kV, ± 1 kV, ± 2 kV
Generator Source Impedance	2 Ω of the low-voltage power supply network. 12 Ω (10 Ω +2 Ω) of the low-voltage power supply network and ground.
Phase Angle, Polarity and Number of Tests	Five positive pulses line-to-neutral at 90° phase Five negative pulses line-to-neutral at 270° phase Five positive pulses line-to-earth at 90° phase Five negative pulses line-to-earth at 270° phase Five negative pulses neutral-to-earth at 90° phase Five positive pulses neutral-to-earth at 270° phase
Pulse Repetition Rate	1 time / min.

6.8.2 MEASUREMENT INSTRUMENTS

Item	Kind of Equipment	Manufacturer	Type No.	Series Model	Calibrated until
1	Lightning Surge Generator	Prima	SUG61005TB	PR190854067	Jul. 03, 2023
2	Surge	Prima	SUG_Series V1.0.0.7.2019 0827	N/A	N/A

Remark: "N/A" denotes no model no., no serial No. or no calibration specified.

All calibration period of equipment list is one year.

6.8.3 TEST PROCEDURE

a. For EUT power supply:

The surge is to be applied to the EUT power supply terminals via the capacitive coupling network. Decoupling networks are required in order to avoid possible adverse effects on equipment not under test that may be powered by the same lines, and to provide sufficient decoupling impedance to the surge wave. The power cord between the EUT and the coupling/decoupling networks shall be 2 meters in length (or shorter).

b. For test applied to unshielded unsymmetrically operated interconnection lines of EUT :

The surge is applied to the lines via the capacitive coupling. The coupling /decoupling networks shall not influence the specified functional conditions of the EUT. The interconnection line between the EUT and the coupling/decoupling networks shall be 2 meters in length (or shorter).

c. For test applied to unshielded symmetrically operated interconnection /telecommunication lines of EUT :

The surge is applied to the lines via gas arrestors coupling. Test levels below the ignition point of the coupling arrestor cannot be specified. The interconnection line between the EUT and the coupling/decoupling networks shall be 2 meters in length (or shorter).

6.8.4 DEVIATION FROM TEST STANDARD

No deviation

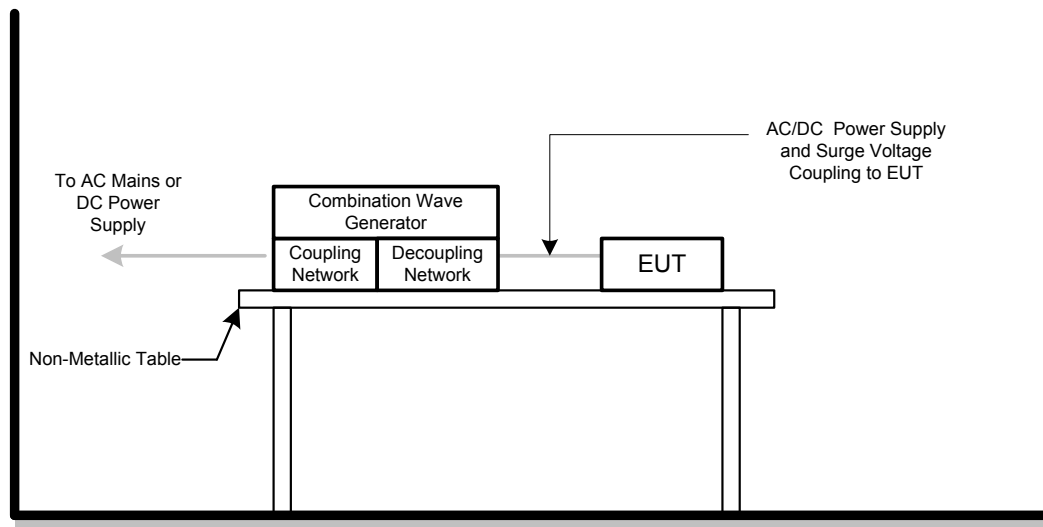
6.8.5 TEST SETUP

6.8.6 TEST RESULTS

Test Voltage	AC 230V/50Hz
Test Mode	Mode 1-5

Wave Form EUT Ports Tested		1.2/50(8/20)Tr/Th μ s						Criterion	Result
		Polarity	Phase	Voltage					
				0.5kV	1kV	-- kV	-- kV		
AC	L – N	+	90°	A	B	-	-	B	B
		-	270°	A	B	-	-		

Wave Form EUT Ports Tested		1.2/50(8/20)Tr/Th μ s						Criterion	Result
		Polarity	Phase	Voltage					
				0.5kV	1kV	2kV	-- kV		
AC	L – PE	+	90°	A	B	B	-	B	B
		-	270°	A	B	B	-		
	N – PE	-	90°	A	B	B	-	B	B
		+	270°	A	B	B	-		

6.9 IMMUNITY TO CONDUCTED DISTURBANCES, INDUCED BY RADIO-FREQUENCY FIELDS TEST (CS)

6.9.1 TEST SPECIFICATION

Basic Standard	IEC 61000-4-6
Required Performance	A
Frequency Range&Field Strength	0.15 MHz - 10 MHz: 3V (unmodulated, r.m.s.) 10 MHz - 30 MHz: 3V to 1V (unmodulated, r.m.s.) 30 MHz - 80 MHz: 1V (unmodulated, r.m.s.)
Modulation	1 kHz Sine Wave, 80%, AM Modulation
Frequency Step	1% of fundamental
Dwell Time	3 seconds

6.9.2 MEASUREMENT INSTRUMENTS

Item	Kind of Equipment	Manufacturer	Type No.	Series Model	Calibrated until
1	Power CDN	FCC	FCC-801-M2/M3-16A	100270	Jan. 23, 2023
2	TEST SYSTEM FOR CONDUCTED AND RADIATED IMMUNITY	TESEQ	NSG 4070B	37513	Jul. 03, 2023
3	Measurement Software	Farad	EZ-CS (V2.0.1.4)	N/A	N/A
4	Conditioning Amplifier	B&K	2690_0F2	2723746	Jun. 09, 2023
5	Free-field 1/2" Microphone	B&K	4190-L-001	2878077	Jun. 11, 2023
6	UPV Audio Analyzer	R&S	UPV	104259	Jan. 23, 2023

Remark: "N/A" denotes no model no., no serial No. or no calibration specified.

All calibration period of equipment list is one year.

6.9.3 TEST PROCEDURE

The equipment to be tested is placed on an insulating support of 0.1m height above a reference ground plane. All cables exiting the EUT shall be supported at a height of at least 30 mm above the reference ground plane. All relevant cables shall be provided with the appropriate coupling and decoupling devices at a distance between 0.1 meters and 0.3 meters from the projected geometry of the EUT on the ground reference plane.

The other condition as following manner:

- a. The field strength level was 3 V (unmodulated, r.m.s.)
- b. The frequency range is swept from 150 kHz to 80 MHz, with the signal 80% amplitude modulated with a 1 kHz sine wave. The rate of sweep did not exceed 1.5×10^{-3} decade/s. Where the frequency range is swept incrementally, the step size was 1% of fundamental.
- c. The dwell time at each frequency shall be not less than the time necessary for the EUT to be able to respond.

For Display and display output functions:

- a. The display quality evaluated by direct observation.
- b. For display output function evaluation, a suitable display device shall be connected. This device shall meet the immunity requirements for displays specified in this document. The screen size shall be typical for the display output. the diagonal screen size shall be at least 0,50 m.
- c. The display shall be observed under normal viewing conditions including viewing distance using a reduced ambient light level preferably in the range 15 lx to 20 lx. The viewing distance or settings of the video camera monitoring system shall be sufficient to provide visibility of the whole display. In the case of direct observation the selected viewing distance shall be recorded in the test report.

For Acoustic measurements:

- a. Apply an appropriate input signal to the EUT so that a sine wave (tone) at the frequency that will be used to modulate the applied disturbance (typically 1 kHz) is generated from the port under test at a level equal to the acoustic reference level.
- b. Record the resulting dB (SPL) level (or other appropriate dB unit) as the value of L_0 . (BTL lab uses the software to take L_0 as the reference value and make it return to zero.)
- c. Change the input to the EUT so that the port under test is silent, or represents silence. This change shall not alter the terminating impedance at the EUT's input.
- d. Apply the RF disturbance to the applicable port of the EUT and record the resulting demodulated audio level in dB (SPL) (or other dB unit used in step d)) as the value of L_1 .
- e. Ensure that non-linear processing does not impact the measurements.
- f. Calculate the acoustic interference ratio using the following formula:
Acoustic interference ratio = $L_1 - L_0$.
(For step e-g, BTL lab proceeds the test with software and calculate Acoustic interference ratio = $L_1 - L_0$).

6.9.4 DEVIATION FROM TEST STANDARD

No deviation

6.9.5 TEST SETUP

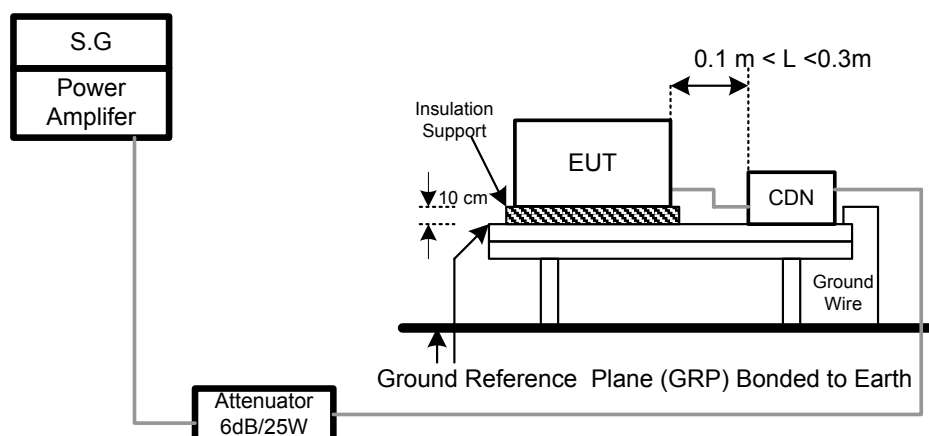

For Audio output function

(1) Audio output port

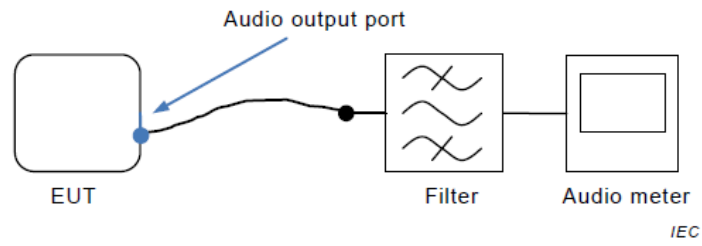

The filter is the audio filter specified in G.6.1 and is typically incorporated into the audio meter. Additional filtering might be necessary to ensure that the RF disturbance signal does not interfere with the measurement.

6.9.6 TEST RESULTS

Test Voltage	AC 230V/50Hz
Test Mode	Mode 1-5

Test Ports (Mode)	Freq.Range (MHz)	Field Strength	Modulation	Criteria	Results
AC mains power ports	0.15 - 10	3V	AM Modulated 1000Hz, 80%	A	A
	10 - 30	3V to 1V			
	30 - 80	1V			

(1) Audio output port:

Test Voltage	AC 230V/50Hz
Test Mode	CDN_M3

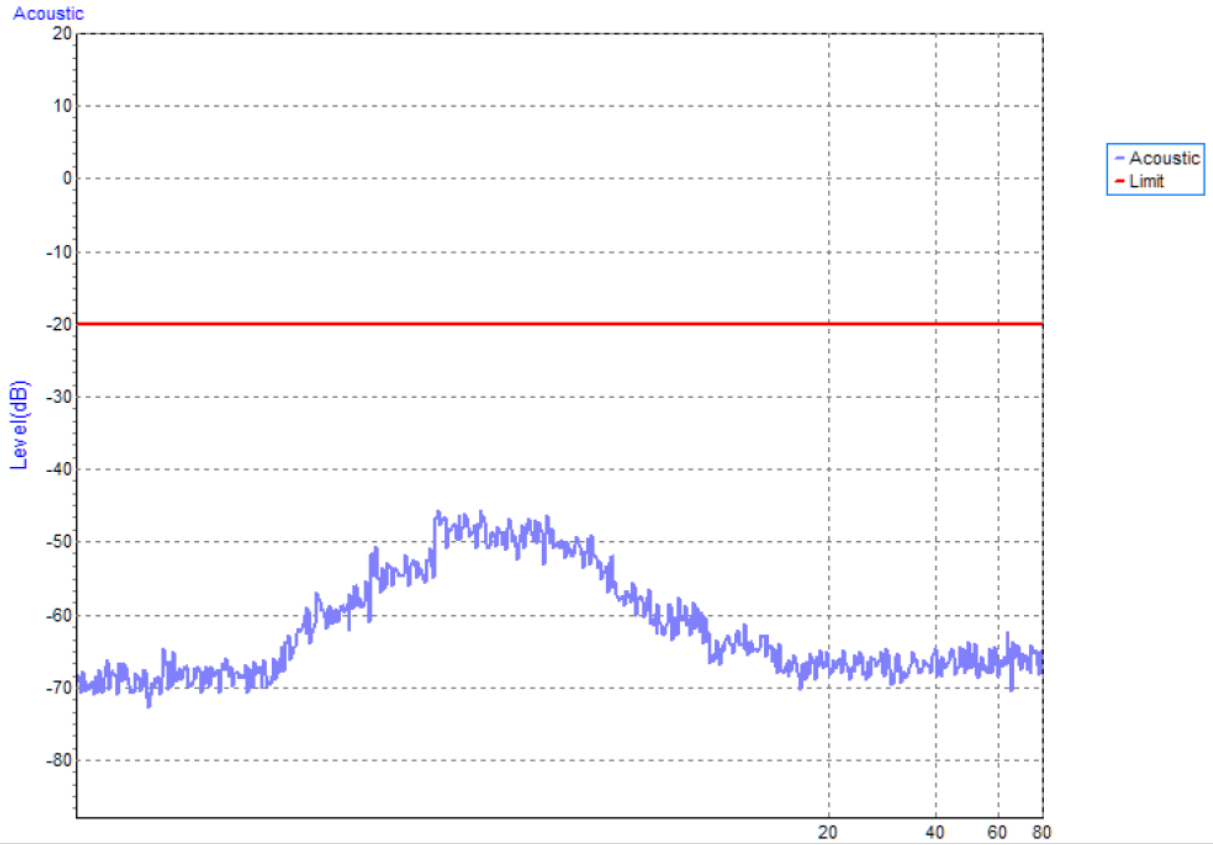

6.10 POWER FREQUENCY MAGNETIC FIELD IMMUNITY TEST (PFMF)

6.10.1 TEST SPECIFICATION

Basic Standard	IEC 61000-4-8
Required Performance	A
Frequency Range	50/60 Hz
Field Strength	1 A/m
Observation Time	1 minute
Inductance Coil	Rectangular type, 1mx1m

6.10.2 MEASUREMENT INSTRUMENTS

Item	Kind of Equipment	Manufacturer	Type No.	Series Model	Calibrated until
1	Magnetic Field test Generator	FCC	F-1000-4-8-G-125A	4032	Jan. 23, 2023
2	Magnetic Field immunity loop	Thermo KeyTek	F-1000-4-8/9/10-L-1M	4024	Jan. 23, 2023

Remark: "N/A" denotes no model no., no serial No. or no calibration specified.

All calibration period of equipment list is one year.

6.10.3 TEST PROCEDURE

For TABLE-TOP equipment:

The equipment shall be subjected to the test magnetic field by using the induction coil of standard dimension (1 m x 1 m). The induction coil shall then be rotated by 90 degrees in order to expose the EUT to the test field with different orientations.

The other condition as following manner:

- a. The equipment cabinets shall be connected to the safety earth directly on the GRP via the earth terminal of the EUT.
- b. The cables supplied or recommended by the equipment manufacturer shall be used. 1 meter of all cables used shall be exposed to the magnetic field.

6.10.4 DEVIATION FROM TEST STANDARD

No deviation

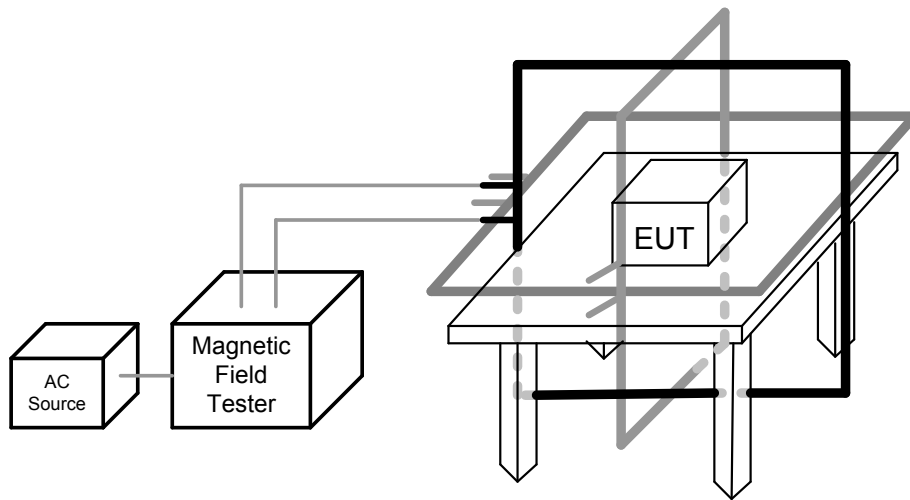
6.10.5 TEST SETUP

6.10.6 TEST RESULTS

Test Voltage	AC 230V/50Hz
Test Mode	Mode 1-5

50Hz

Test Mode	Test Level	Antenna aspect	Duration (s)	Criteria	Results
Enclosure	1 A/m	X	60	A	A
Enclosure	1 A/m	Y	60	A	A
Enclosure	1 A/m	Z	60	A	A

60Hz

Test Mode	Test Level	Antenna aspect	Duration (s)	Criteria	Results
Enclosure	1 A/m	X	60	A	A
Enclosure	1 A/m	Y	60	A	A
Enclosure	1 A/m	Z	60	A	A

6.11 VOLTAGE DIPS, SHORT INTERRUPTIONS AND VOLTAGE VARIATIONS IMMUNITY TEST (DIPS)

6.11.1 TEST SPECIFICATION

Basic Standard	IEC 61000-4-11
Required Performance	Voltage dips: B (For <5% residual voltage, dips) C (For 70% residual voltage, dips) C (For <5% residual voltage, Interruptions)
Interval between Event	Ten seconds
Phase Angle	0°/180°
Test Cycle	3 times

6.11.2 MEASUREMENT INSTRUMENTS

Item	Kind of Equipment	Manufacturer	Type No.	Series Model	Calibrated until
1	Cycle Sag Simulator	Prima	DRP61011TA	PR19076452	Dec. 01, 2022
2	Measurement Software	Prima	DRP_Series V1.0.0.3.201 90123	N/A	N/A

Remark: "N/A" denotes no model no., no serial No. or no calibration specified.

All calibration period of equipment list is one year.

6.11.3 TEST PROCEDURE

The EUT shall be tested for each selected combination of test levels and duration with a sequence of three dips/interruptions with intervals of 10 s minimum (between each test event). Each representative mode of operation shall be tested. Abrupt changes in supply voltage shall occur at zero crossings of the voltage waveform.

6.11.4 DEVIATION FROM TEST STANDARD

No deviation

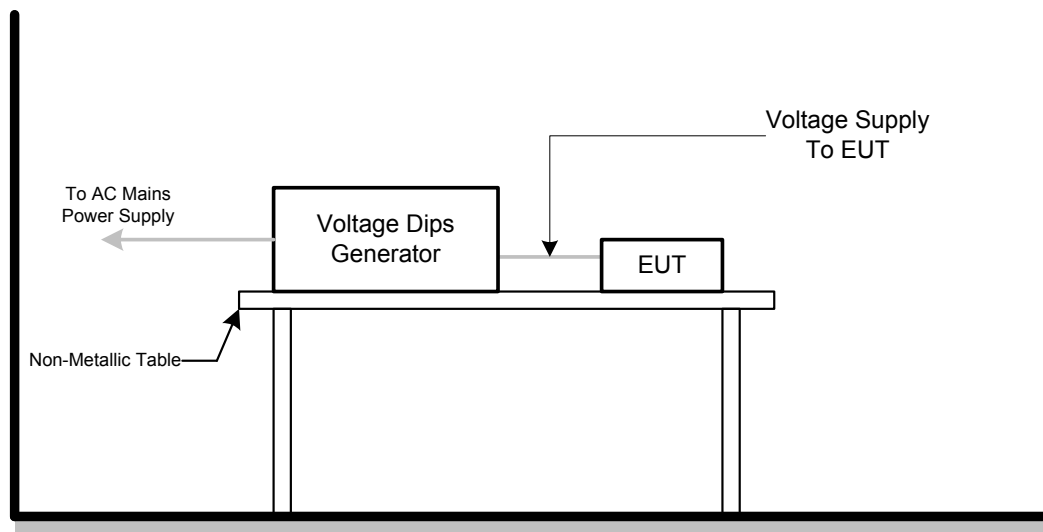
6.11.5 TEST SETUP

6.11.6 TEST RESULTS

Test Voltage	AC 100V/50Hz, AC 230V/50Hz, AC 240V/50Hz
Test Mode	Mode 1-5

AC 100V/50Hz				
Item	Residual Voltage	Cycle	Criteria	Results
Voltage dips	<5%	0.5	B	A
Voltage dips	70%	25	C	A
Voltage Interruption	<5%	250	C	C

AC 230V/50Hz				
Item	Residual Voltage	Cycle	Criteria	Results
Voltage dips	<5%	0.5	B	A
Voltage dips	70%	25	C	A
Voltage Interruption	<5%	250	C	C

AC 240V/50Hz				
Item	Residual Voltage	Cycle	Criteria	Results
Voltage dips	<5%	0.5	B	A
Voltage dips	70%	25	C	A
Voltage Interruption	<5%	250	C	C

7. EUT TEST PHOTO

EN 55032:2015

Radiated emissions up to 1 GHz

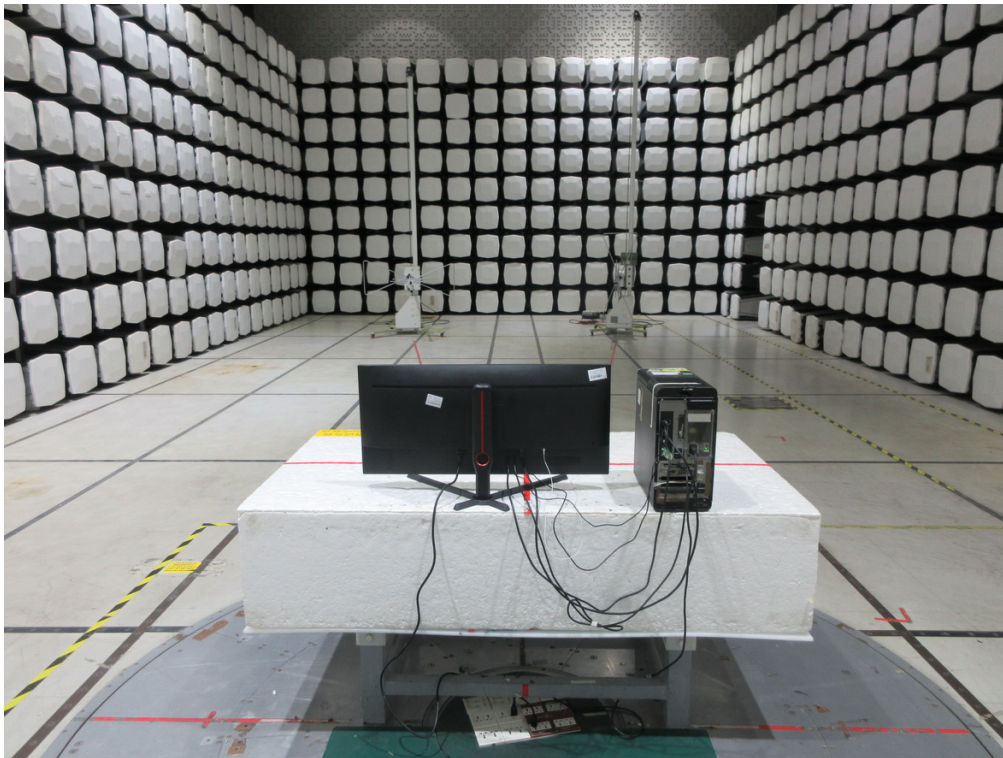
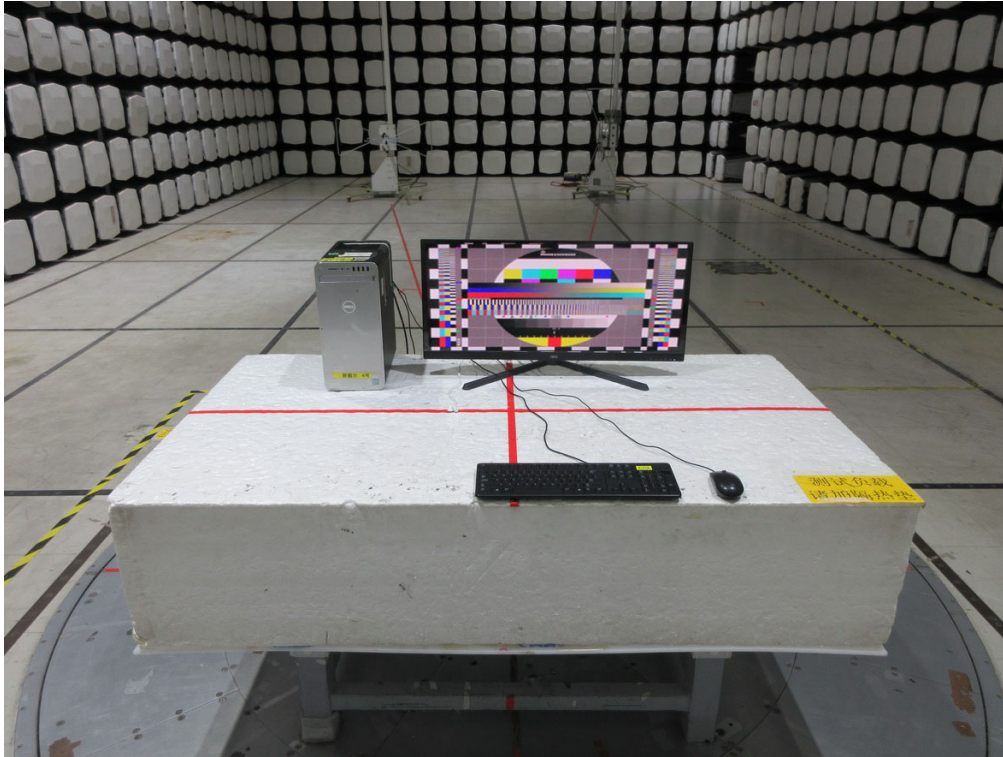

Radiated emissions above 1 GHz

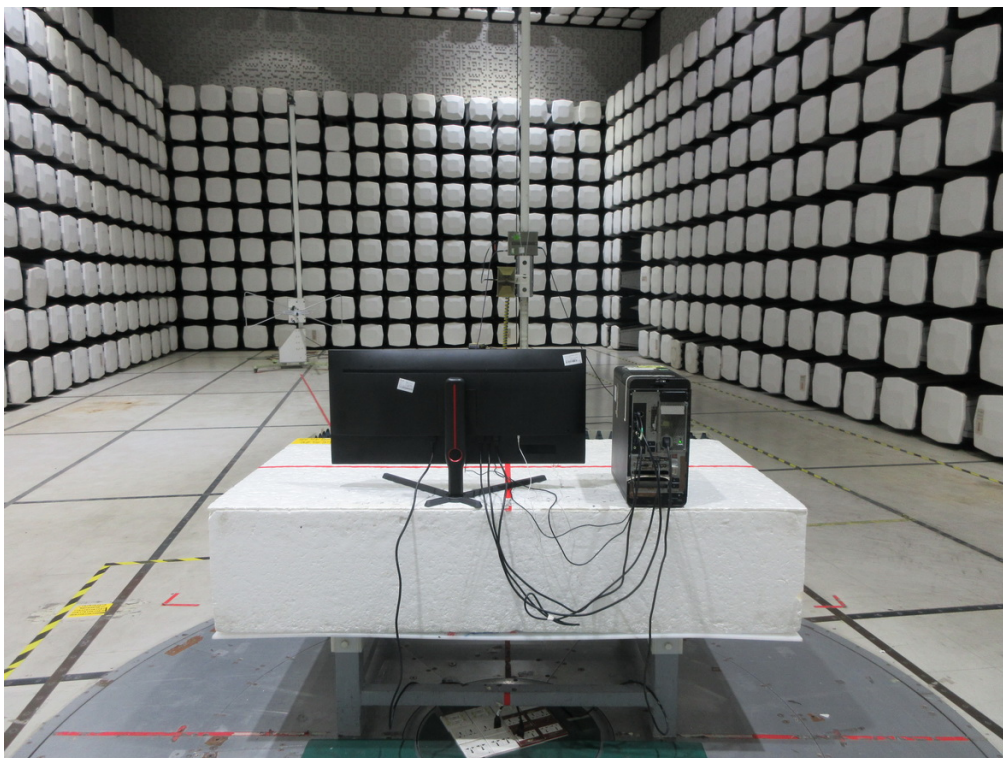
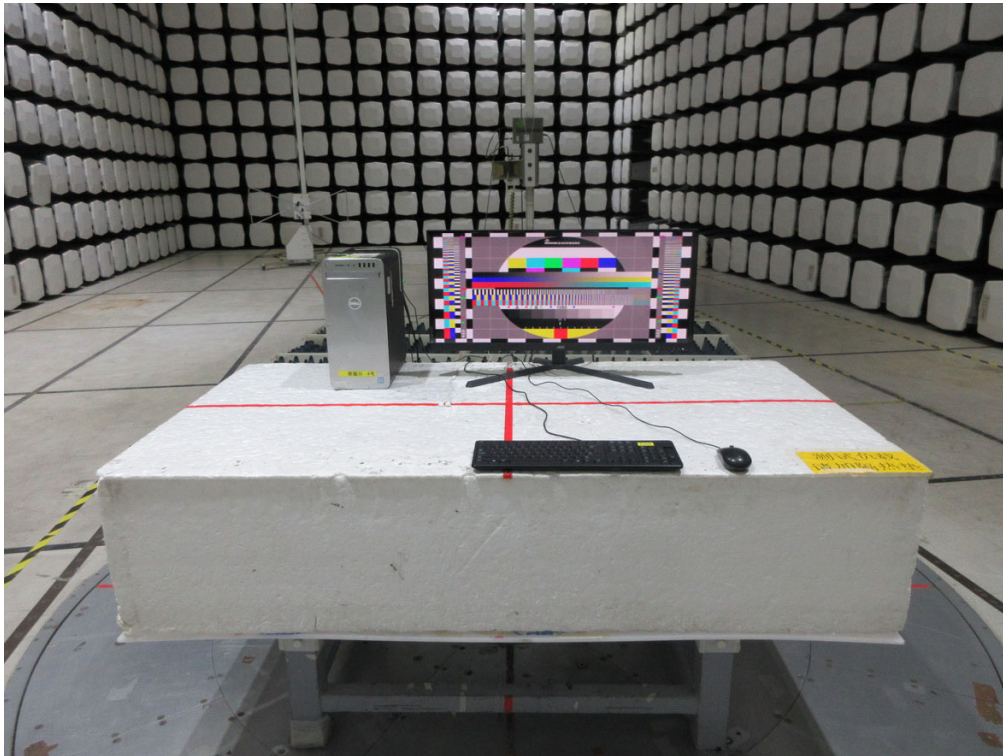

Conducted emissions AC mains power port

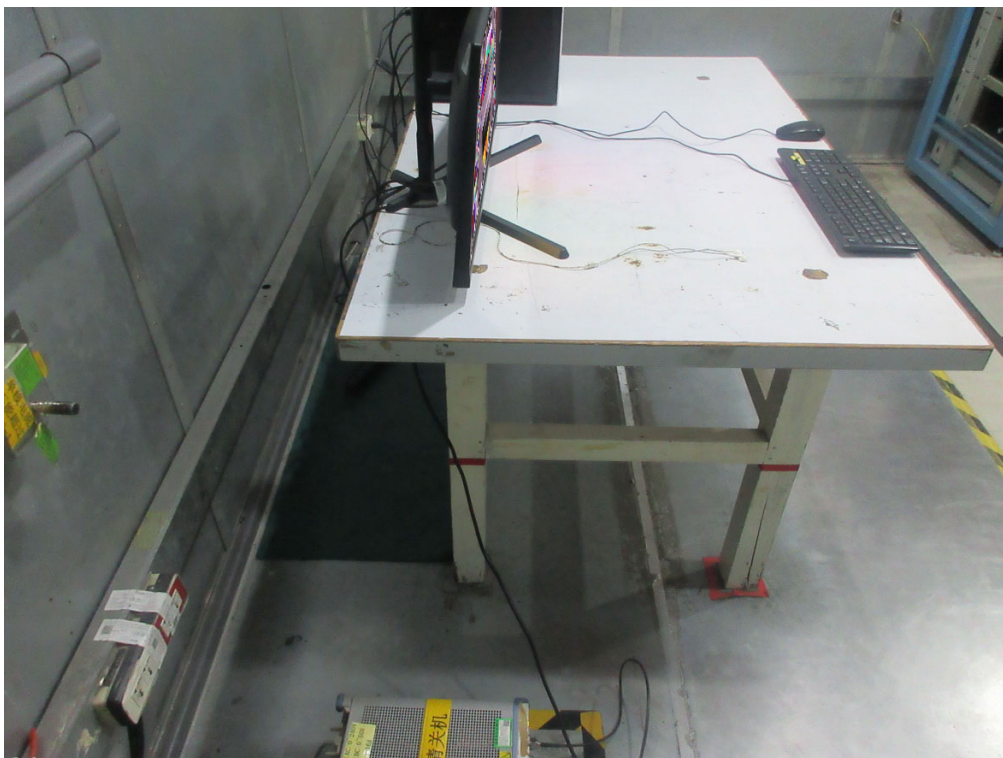

EN 55032:2015+A11:2020/EN 55032:2015+A1:2020

Radiated emissions up to 1 GHz

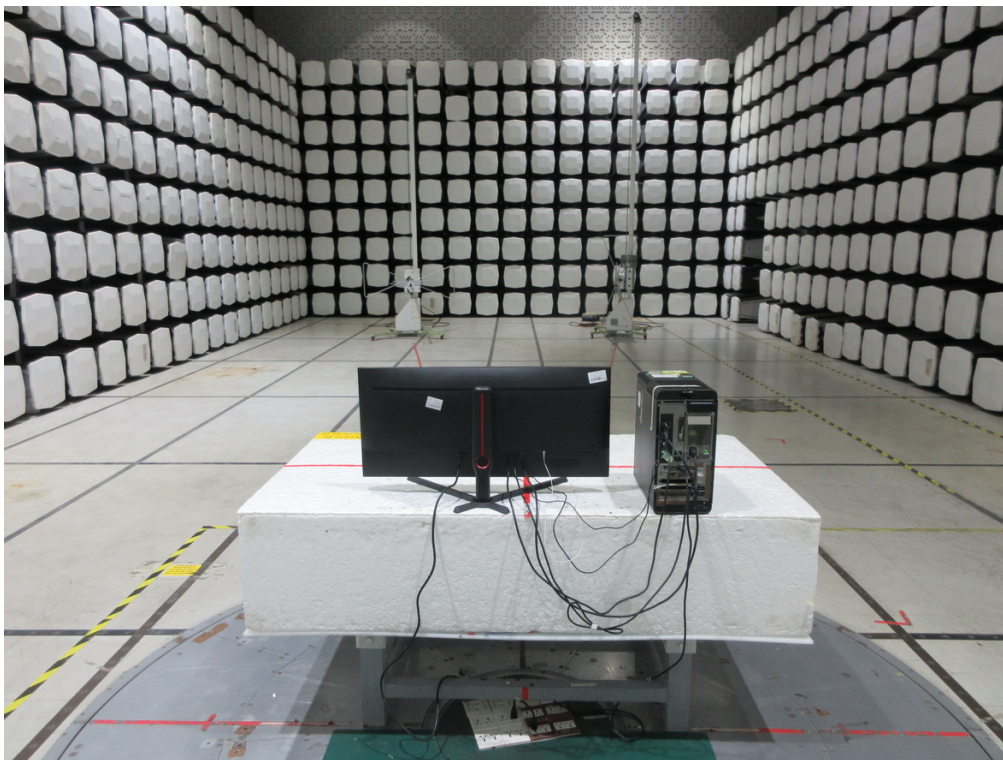
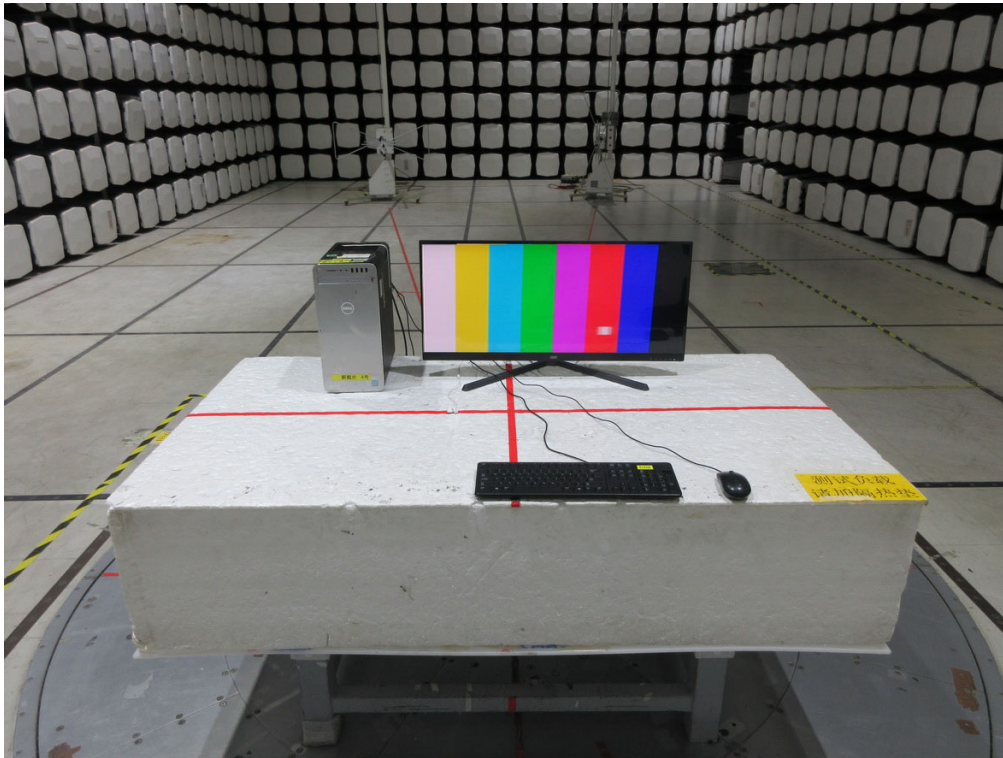

Radiated emissions above 1 GHz

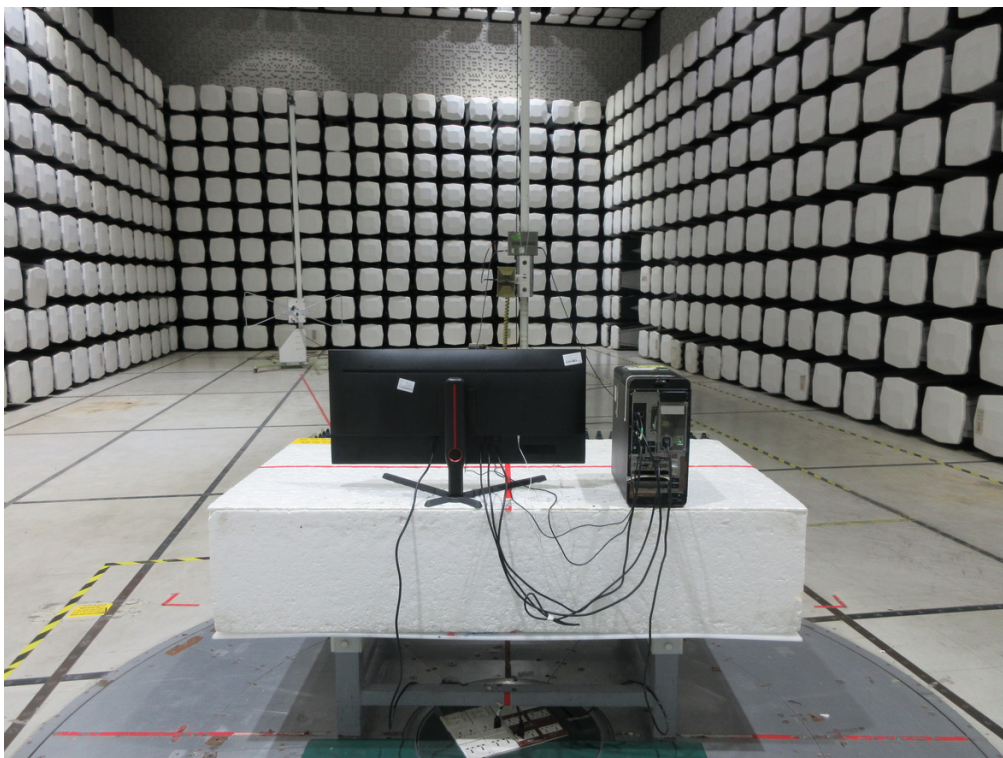
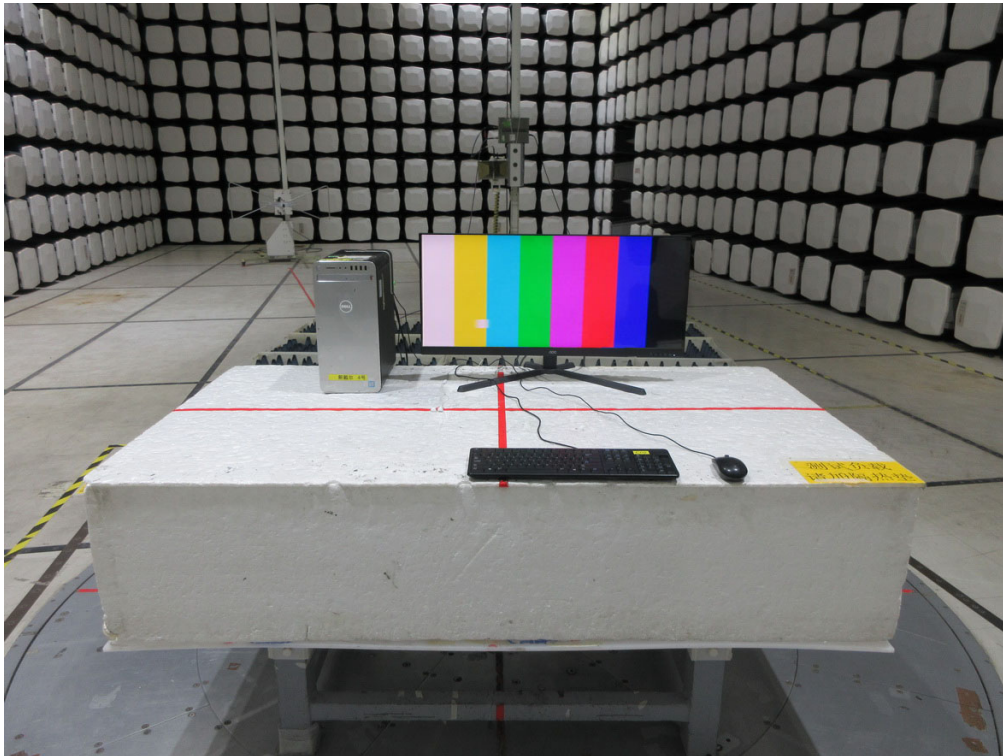

Conducted emissions AC mains power port

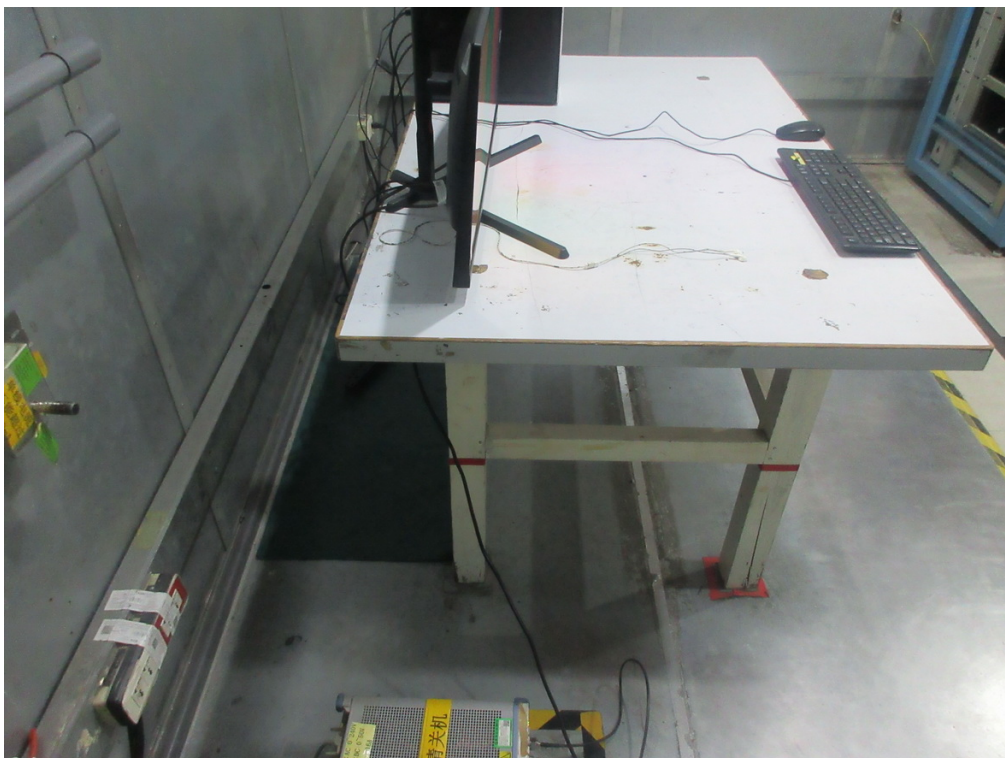

Harmonic current emissions

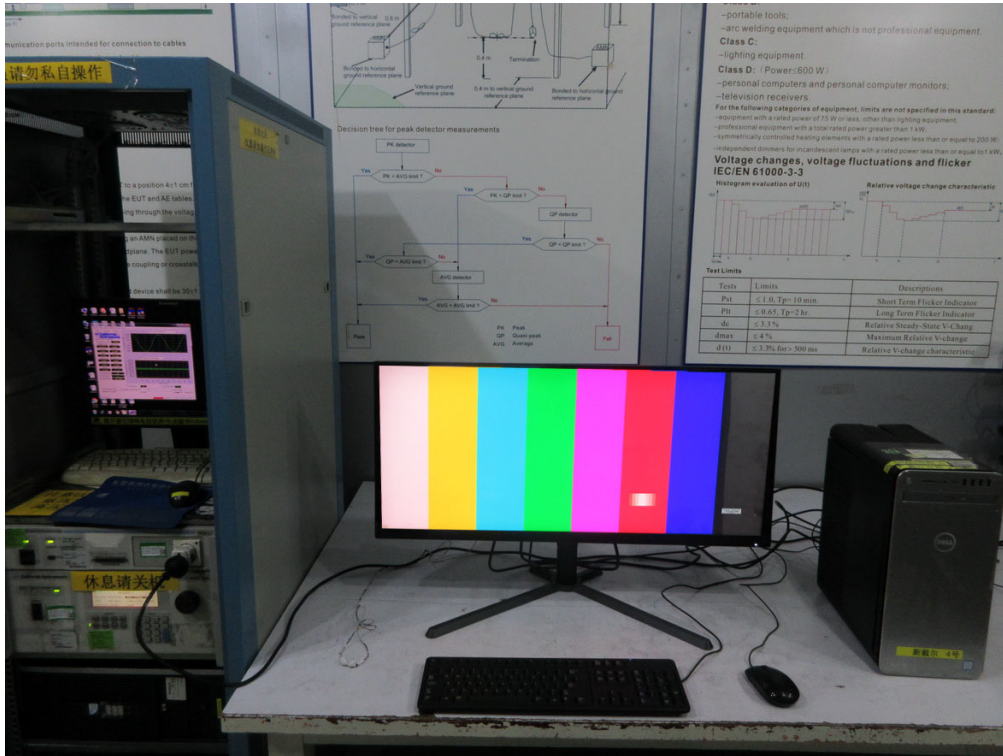

Voltage fluctuations (Flicker)

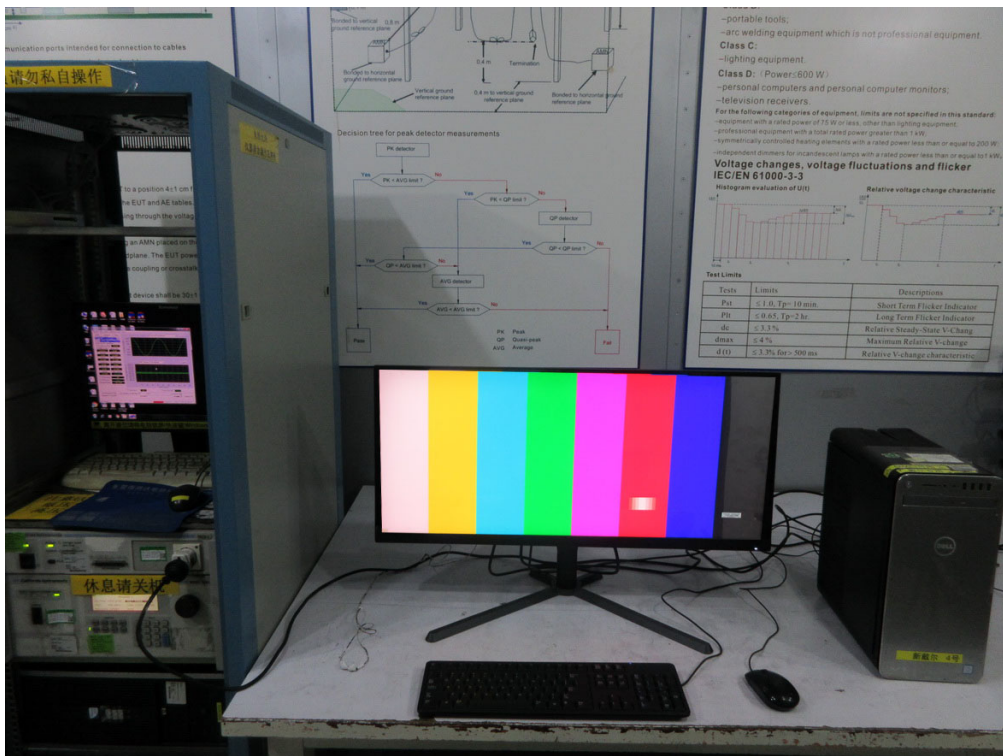

Electrostatic discharge immunity



Radiated, radio-frequency, electromagnetic field immunity – Up to 1GHz

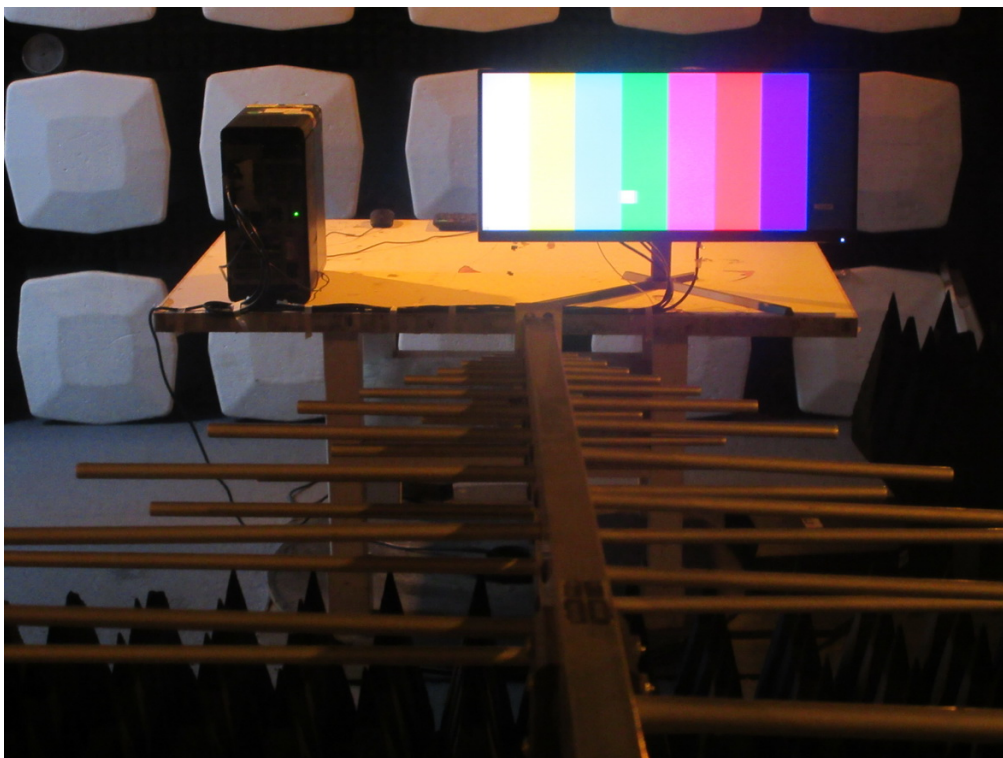

Radiated, radio-frequency, electromagnetic field immunity – Above 1GHz

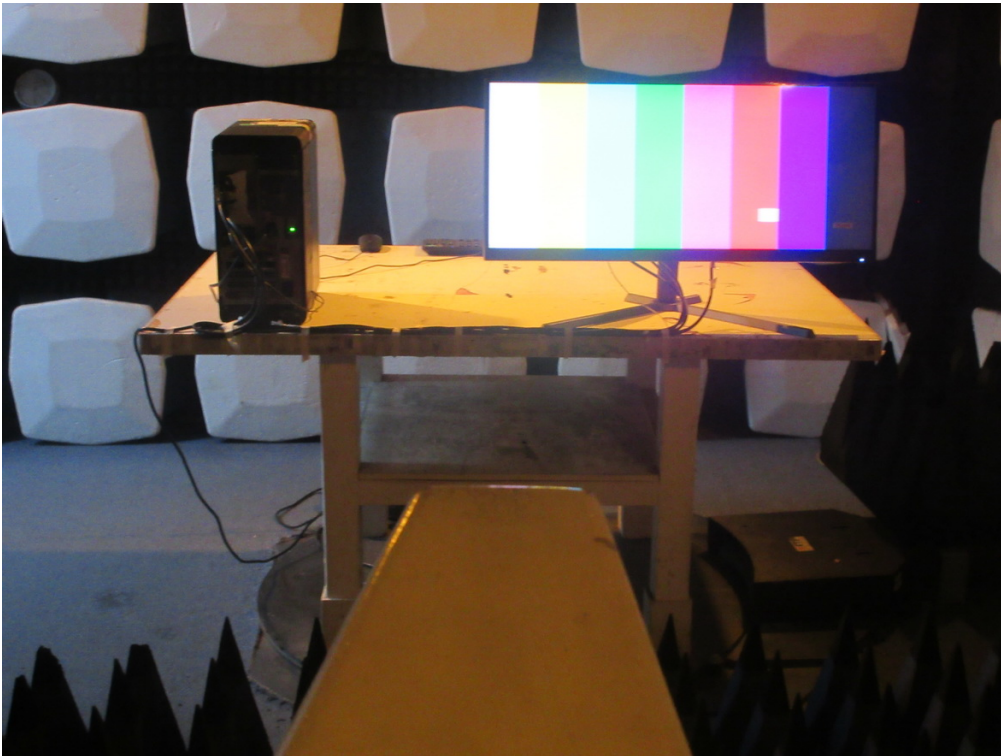

Electrical fast transient/burst immunity

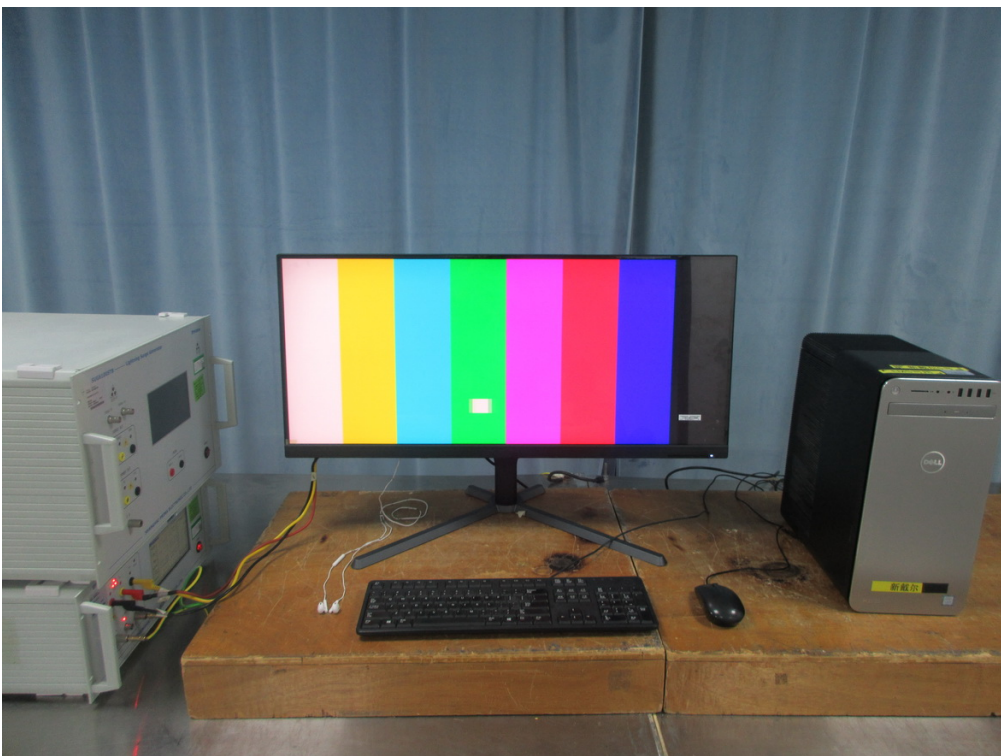

Surge immunity



Immunity to conducted disturbances, induced by radio-frequency fields



Power frequency magnetic field immunity



Voltage dips, short interruptions and voltage variations immunity



End of Test Report

ATTACHMENT

PHOTOGRAPHS OF EUT



Base Type B

