

ATTESTATION OF CONFORMITY



Directive(s):	2014/30/EU
Attestation No.:	SECE1803231
Applicant / Holder:	TPV Electronics (Fujian) Co., Ltd.
Address:	Rongqiao Economic and Technological Development Zone, Fuqing City, Fujian Province, P.R. China
Product / Test Item:	LCD Monitor
Model / Type Reference:	27V2;**27V2***** (The "*" could be any alphanumeric character including blank for marketing differentiation.)

The submitted sample(s) have been tested with the following standard(s) and found to be in compliance with the essential requirements of the Directive(s):

Standard(s)	
EN 55032: 2015+AC 2016 (Class B)	EN 55024 : 2010+A1 : 2015
EN 61000-3-2: 2014	IEC 61000-4-2 : 2008
EN 61000-3-3: 2013	IEC 61000-4-3 : 2006+A1:2007+A2:2010
CISPR 32: 2015+COR1:2016	IEC 61000-4-4 : 2012
AS/NZS CISPR 32: 2015	IEC 61000-4-5 : 2014
EN 55032: 2012+AC 2013	IEC 61000-4-6 : 2013
EN 55032: 2015	IEC 61000-4-8 : 2009
CISPR 32: 2015	IEC 61000-4-11 : 2004+AMD1:2017 CSV

The referred test report(s) show that the product fulfills the essential requirements set out in the Directive(s). On this basis, together with the manufacturer's own documented production control, the manufacturer or his European authorized representative can in his EC Declaration of Conformity verify compliance with the Directive(s). The CE marking could be affixed only when all the relevant and effective EC Directives are complied with.



Miro Chueh / Manager
2018-04-24

Cerpess Technology Corporation

- Cerpess Technology Corporation
No.10, Ln. 2, Lianfu St., Luzhu Dist., Taoyuan City 33848, Taiwan
- Cerpess Technology (Suzhou) Co.,Ltd
No.66, Tangzhuang Rd., Suzhou Industrial Park, Jiangsu 215006, China



EMC TEST REPORT

Authorized under Declaration of Conformity

According to

EN 55032: 2015+AC 2016 (Class B)	EN 55024 : 2010+A1 : 2015
EN 61000-3-2: 2014	IEC 61000-4-2 : 2008
EN 61000-3-3: 2013	IEC 61000-4-3 : 2006+A1:2007+A2:2010
CISPR 32: 2015+COR1:2016	IEC 61000-4-4 : 2012
AS/NZS CISPR 32: 2015	IEC 61000-4-5 : 2014
EN 55032: 2012+AC 2013	IEC 61000-4-6 : 2013
EN 55032: 2015	IEC 61000-4-8 : 2009
CISPR 32: 2015	IEC 61000-4-11 : 2004+AMD1:2017 CSV

Applicant : TPV Electronics (Fujian) Co., Ltd.
Address : Rongqiao Economic and Technological
Development Zone, Fuqing City, Fujian Province,
P.R. China
Equipment : LCD Monitor
Model No. : 27V2;**27V2*****
(The "*" could be any alphanumeric character including blank for marketing differentiation.)

I HEREBY CERTIFY THAT :

The sample was received on Apr. 02, 2018 and the testing was carried out on Apr.09, 2018 at CerpPASS Technology Corp. The test result refers exclusively to the test presented test model / sample. Without written approval of CerpPASS Technology Corp., the test report shall not be reproduced except in full.



EMC TEST REPORT

Issued by:

CerpPASS Technology (Suzhou) Co.,Ltd

No.66,Tangzhuang Road, Suzhou Industrial Park, Jiangsu 215006, China

Tel:86-512-6917-5888

Fax:86-512-6917-5666

The test record, data evaluation & Equipment Under Test configurations represented herein are true and accurate accounts of the measurements of the samples EMC characteristics under the conditions specified in this report.

The above equipment was tested by CerpPASS Technology Corp. for compliance with the requirements of technical standards specified above under the EMC Directive. The results of testing in this report apply only to the product/system, which was tested. Other similar equipment will not necessarily produce the same results due to production tolerance and measurement uncertainties

Approved by:

Miro Chueh
EMC/RF B.U. Manager

Laboratory Accreditation:

CerpPASS Technology Corporation

TAF LAB Code:	1439
----------------------	-------------

CerpPASS Technology(SuZhou) Co., Ltd.

CNAS LAB Code:	L5515
-----------------------	--------------



Contents

1. Summary of Test Procedure and Test Results	6
2. Immunity Testing Performance Criteria Definition	7
3. Test Configuration of Equipment under Test	8
3.1. Feature of Equipment under Test.....	8
3.2. Test Mode and Test Manner.....	9
3.3. Description of Support Unit	13
3.4. General Information of Test.....	14
3.5. Measurement Uncertainty	15
4. Test of Conducted Emission	17
4.1. Test Limit	17
4.2. Test Procedures	20
4.3. Typical Test Setup	20
4.4. Measurement Equipment.....	21
4.5. Test Data and Result.....	22
4.6. Test Photographs	39
5. Test of Radiated Emission	43
5.1. Test Limit	43
5.2. Test Procedures	46
5.3. Typical Test Setup	46
5.4. Measurement Equipment.....	47
5.5. Test Result and Data (30MHz ~ 1000MHz)	48
5.6. Test Result and Data (1000MHz ~ 6000MHz)	64
5.7. Test Photographs (30MHz ~ 1000MHz).....	80
5.8. Test Photographs (1000MHz ~ 6000MHz).....	84
6. Harmonics Test	88
6.1. Limits of Harmonics Current Measurement	88
6.2. Measurement equipment	89
6.3. Test Result and Data	90
6.4. Test Photographs	94
7. Voltage Fluctuations Test	95
7.1. Test Procedure	95
7.2. Measurement equipment	95
7.3. Test Result and Data	96
7.4. Test Photographs	100
8. Electrostatic Discharge Immunity Test	101
8.1. Test Procedure	101
8.2. Test Setup for Tests Performed in Laboratory.....	102
8.3. Test Severity Levels	103
8.4. Measurement equipment	103
8.5. Test Result and Data	104
8.6. Test Photographs	106
9. Radio Frequency electromagnetic field immunity test	107



9.1. Test Procedure 107

9.2. Test Severity Levels 107

9.3. TEST SETUP 108

9.4. Measurement equipment 109

9.5. Test Result and Data 110

9.6. Test Photographs 112

10. Electrical Fast Transient/ Burst Immunity Test 113

10.1. Test Procedure 113

10.2. Test Severity Levels 113

10.3. TEST SETUP 114

10.4. Measurement equipment 114

10.5. Test Result and Data 115

10.6. Test Photographs 117

11. Surge Immunity Test 118

11.1. Test Procedure 118

11.2. Test Severity Level 118

11.3. TEST SETUP 119

11.4. Measurement equipment 119

11.5. Test Result and Data 120

11.6. Test Photographs 122

12. Conduction Disturbances induced by Radio-Frequency Fields 123

12.1. Test Procedure 123

12.2. Test Severity Levels 123

12.3. TEST SETUP 124

12.4. Measurement equipment 124

12.5. Test Result and Data 125

12.6. Test Photographs 127

13. Power Frequency Magnetic Field Immunity Tests 128

13.1. Test Setup 128

13.2. Test Severity Levels 128

13.3. Measurement equipment 128

13.4. Test Result and Data 129

13.5. Test Photographs 131

14. Voltage Dips and Voltage Interruptions Immunity Test Setup 132

14.1. Test Conditions 132

14.2. TEST SETUP 132

14.3. Measurement equipment 132

14.4. Test Result and Data 133

14.5. Test Photographs 135



History of this test report

ORIGINAL.

Additional attachment as following record:

Report No	Version	Date	Description
SECE1803231	Rev 01	Apr 19, 2018	Initial Issue

**1. Summary of Test Procedure and Test Results**

EMISSION [EN55032: 2015+AC 2016/ EN 55032: 2012+AC 2013/ EN55032: 2015]			
Standard	Item	Result	Remarks
EN55032: 2015+AC 2016 CISPR 32: 2015+COR1: 2016 AS/NZS CISPR 32: 2015 EN 55032: 2012+AC 2013 EN 55032: 2015 CISPR 32: 2015	Conducted (Power Port)	PASS	Meet Class B Limit Minimum passing margin(QP) is -8.92 dB at 0.1539 MHz
	Conducted (Telecom port)	N/A	N/A
	Radiated	PASS	Meets Class B Limit Minimum passing margin(QP) is -4.06 dB at 296.0000MHz
EN 61000-3-2: 2014	Harmonic current emissions	PASS	Meet Class D Limit
EN61000-3-3: 2013	Voltage fluctuations & flicker	PASS	Meets the requirements

IMMUNITY [EN 55024 : 2010+A1 : 2015]			
Standard	Item	Result	Remarks
IEC 61000-4-2: 2008	ESD	PASS	Meets the requirements of Performance Criterion A
IEC 61000-4-3: 2006+A1:2007+A2:2010	RS	PASS	Meets the requirements of Performance Criterion A
IEC 61000-4-4: 2012	EFT	PASS	Meets the requirements of Performance Criterion A
IEC 61000-4-5: 2014	Surge	PASS	Meets the requirements of Performance Criterion A
IEC 61000-4-6: 2013	CS	PASS	Meets the requirements of Performance Criterion A
IEC 61000-4-8: 2009	PFMF	PASS	Meets the requirements of Performance Criterion A
IEC 61000-4-11: 2004+AMD1:2017 CSV	Voltage dips & voltage variations	PASS	Meets the requirements of Voltage Dips: 1) >95% reduction Performance Criterion B 2) 30% reduction Performance Criterion B Voltage Interruptions: 1) >95% reduction Performance Criterion C



2. Immunity Testing Performance Criteria Definition

Criteria A:	The apparatus shell continues to operate as intended without operator intervention. No degradation of performance or loss of function is allowed below a performance level specified by the manufacturer, when the apparatus is used as intended. The performance level may be replaced by a permissible loss of performance. If the manufacturer does not specify the minimum performance level or the permissible performance loss, then either of these may be derived from the product description and documentation, and by what the user may reasonably expect from the equipment if used as intended.
Criteria B:	<p>After test, the apparatus shell continues to operate as intended without operator intervention. No degradation of performance or loss of function is allowed, after the application of the phenomenon below a performance level specified by the manufacturer, when the apparatus is used as intended. The performance level may be replaced by a permissible loss of performance.</p> <p>During the test, degradation of performance is however allowed. However, no change of operating state if stored data is allowed to persist after the test. If the manufacturer does not specify the minimum performance level or the permissible performance loss, then either of these may be derived from the product description and documentation, and by what the user may reasonably expect from the equipment if used as intended.</p>
Criteria C:	<p>Temporary loss of function is allowed, provided the functions is self-recoverable or can be restored by the operation of controls by the user in accordance with the manufacturer instructions.</p> <p>Functions, and/or information stored in non-volatile memory, or protected by a battery backup, shall not be lost.</p>



3. Test Configuration of Equipment under Test

3.1. Feature of Equipment under Test

Product Name:	LCD Monitor	
Model Name:	27V2;**27V2***** (The “*” could be any alphanumeric character including blank for marketing differentiation.)	
Housing material:	Plastic case	
EUT Highest Frequency:	180MHz	
EUT Power Rating:	Input:100-240V, 50/60Hz 2Pin Power Port	
Adapter	Model No.:	STK030-19158T
	Input:	AC 100-240V~ 50/60Hz Max. 0.8A
	Output:	DC 19V,1.58A
AC Power Cord Type:	Non-shielded, 1.2m&1.5m&1.8m	

I/O PORT(27V2Q):

I/O PORT TYPE	Quantity
1). HDMI Port	1
2). Display Port	1
3). Audio Port	1
4). DC Port	1

I/O PORT(27V2H):

I/O PORT TYPE	Quantity
1). HDMI Port	1
2). VGA Port	1
3). Audio Port	1
4). DC Port	1



3.2. Test Mode and Test Manner

27V2Q

Conducted Emission/ Radiated Emission

Test Manner

- a During testing, the interface cables and equipment positions were varied according to Europe Standard.
- c The personal computer driven the Windows media player to play the Colour bars with moving picture element with comply with requirement of ITU-RBT 471-1, and display under HDMI, Display (For EN 55032 : 2015+AC 2016, CISPR 32: 2015+COR1:2016)
The personal computer driven the Windows media player to play the Colour bars with moving picture element with comply with requirement of ITU-RBT 1729, and display under HDMI, Display (For EN 55032 : 2012+AC 2013, EN 55032 : 2015, CISPR 32: 2015, AS/NZS CISPR 32: 2015)
- d During the test, connect the Computer, USB Keyboard, USB Mouse, Earphone and EUT, make the EUT at the test mode.
- e Adjust the EUT, then test.

The pre-test for CE/ RE modes

Remark: Assess high, middle and low resolution of each video port (HDMI, Display) under 230V/ 50Hz, 110V/60Hz test voltage with ITU-RBT 1729 Colour bars.

Test Mode 1:Full system (Display mode 1920*1080@60Hz) Signal from PC for ITU-RBT 1729 Colour bars (230V/50Hz)

Test Mode 2:Full system (Display mode 1280*1024@75Hz) Signal from PC for ITU-RBT 1729 Colour bars (230V/50Hz)

Test Mode 3:Full system (Display mode 640*480@60Hz) Signal from PC for ITU-RBT 1729 Colour bars (230V/50Hz)

Test Mode 4:Full system (HDMI mode 1920*1080@60Hz) Signal from PC for ITU-RBT 1729 Colour bars (230V/50Hz)

Test Mode 5:Full system (HDMI mode 1280*1024@75Hz) Signal from PC for ITU-RBT 1729 Colour bars (230V/50Hz)

Test Mode 6:Full system (HDMI mode 640*480@60Hz) Signal from PC for ITU-RBT 1729 Colour bars (230V/50Hz)

Test Mode 7:Full system (HDMI mode 1080P) Signal from DVD for ITU-RBT 1729 Colour bars (230V/50Hz)

Test Mode 8:Full system (Display mode 1920*1080@60Hz) Signal from PC for ITU-RBT 1729 Colour bars (110V/60Hz)

Test Mode 9:Full system (HDMI mode 1920*1080@60Hz) Signal from PC for ITU-RBT 1729 Colour bars (110V/60Hz)



Remark: In the above test modes, 1920*1080@60Hz resolution and Display video port test data is worse, so the following two modes are assessed with the ITU-RBT 471-1 Color bars.

Test Mode 10: Full system (Display mode 1920*1080@60Hz) Signal from PC for ITU-RBT 471-1 Colour bars (230V/50Hz)

Test Mode 11: Full system (Display mode 1920*1080@60Hz) Signal from PC for ITU-RBT 471-1 Colour bars (110V/60Hz)

Remark: In the all of above test modes, 1920*1080@60Hz resolution and Display video port test data is the worst, so the following test modes are reported as the basis.

“Test mode 1,8,10,11” were reported as final data.

Harmonics/ Voltage Fluctuations/EMS

Test Manner

- a During testing, the interface cables and equipment positions were varied according to Europe Standard.
- b Running "H" pattern.
- d During the test, connect the Computer, USB Keyboard, USB Mouse, Earphone and EUT, make the EUT at the test mode.
- e Make the EUT at the test mode and it is normal operation, and then test.

The pre-test for Harmonic/Flicker/EMS modes

Test Mode 1 Full system (Display mode 1920*1080@60Hz) Signal from PC

Test Mode 2 Full system (HDMI mode 1920*1080@60Hz) Signal from PC

“Test mode 1,2” were reported as final data.

- f. The maximum operating frequency is above 108MHz, the test frequency range is from 1GHz to 6GHz.

**27V2H****Conducted Emission/ Radiated Emission****Test Manner**

- a During testing, the interface cables and equipment positions were varied according to Europe Standard.
- c The personal computer driven the Windows media player to play the Colour bars with moving picture element with comply with requirement of ITU-RBT 471-1, and display under HDMI, VGA (For EN 55032 : 2015+AC 2016, CISPR 32: 2015+COR1:2016)
The personal computer driven the Windows media player to play the Colour bars with moving picture element with comply with requirement of ITU-RBT 1729, and display under HDMI, VGA (For EN 55032 : 2012+AC 2013, EN 55032 : 2015, CISPR 32: 2015, AS/NZS CISPR 32: 2015)
- d During the test, connect the Computer, USB Keyboard, USB Mouse, Earphone and EUT, make the EUT at the test mode.
- e Adjust the EUT, then test.

The pre-test for CE/ RE modes

Remark: Assess high, middle and low resolution of each video port (HDMI, VGA) under 230V/ 50Hz, 110V/60Hz test voltage with ITU-RBT 1729 Colour bars.

Test Mode 1:Full system (VGA mode 1920*1080@60Hz) Signal from PC for ITU-RBT 1729 Colour bars (230V/50Hz)

Test Mode 2:Full system (VGA mode 1280*1024@75Hz) Signal from PC for ITU-RBT 1729 Colour bars (230V/50Hz)

Test Mode 3:Full system (VGA mode 640*480@60Hz) Signal from PC for ITU-RBT 1729 Colour bars (230V/50Hz)

Test Mode 4:Full system (HDMI mode 1920*1080@60Hz) Signal from PC for ITU-RBT 1729 Colour bars (230V/50Hz)

Test Mode 5:Full system (HDMI mode 1280*1024@75Hz) Signal from PC for ITU-RBT 1729 Colour bars (230V/50Hz)

Test Mode 6:Full system (HDMI mode 640*480@60Hz) Signal from PC for ITU-RBT 1729 Colour bars (230V/50Hz)

Test Mode 7:Full system (HDMI mode 1080P) Signal from DVD for ITU-RBT 1729 Colour bars (230V/50Hz)

Test Mode 8:Full system (VGA mode 1920*1080@60Hz) Signal from PC for ITU-RBT 1729 Colour bars (110V/60Hz)

Test Mode 9:Full system (HDMI mode 1920*1080@60Hz) Signal from PC for ITU-RBT 1729 Colour bars (110V/60Hz)

Remark: In the above test modes, 1920*1080@60Hz resolution and Display video port test data



is worse, so the following two modes are assessed with the ITU-RBT 471-1 Color bars.

Test Mode 10: Full system (VGA mode 1920*1080@60Hz) Signal from PC for ITU-RBT 471-1 Colour bars (230V/50Hz)

Test Mode 11: Full system (VGA mode 1920*1080@60Hz) Signal from PC for ITU-RBT 471-1 Colour bars (110V/60Hz)

Remark: In the all of above test modes, 1920*1080@60Hz resolution and VGA video port test data is the worst, so the following test modes are reported as the basis.

“Test mode 1,8,10,11” were reported as final data.

Harmonics/ Voltage Fluctuations/EMS

Test Manner

- a During testing, the interface cables and equipment positions were varied according to Europe Standard.
- b Running "H" pattern.
- d During the test, connect the Computer, USB Keyboard, USB Mouse, Earphone and EUT, make the EUT at the test mode.
- e Make the EUT at the test mode and it is normal operation, and then test.

The pre-test for Harmonic/Flicker/EMS modes

Test Mode 1 Full system (VGA mode 1920*1080@60Hz) Signal from PC

Test Mode 2 Full system (HDMI mode 1920*1080@60Hz) Signal from PC

“Test mode 1,2” were reported as final data.

- g. The maximum operating frequency is above 108MHz, the test frequency range is from 1GHz to 6GHz.



3.3. Description of Support Unit

27V2Q

No.	Device	Manufacturer	Model No.	Description
1	Computer	HP	HP Compaq Elite 8200 MTPC	Non-Shielded ,1.8m
2	USB Keyboard	DELL	SK-8115	N/A
3	USB Mouse	DELL	G0K02XYK	N/A
4	Earphone	Edifier	N/A	N/A

Use cable:

No	Cable	Quantity	Description
A	HDMI Cable	1	Shielded, 1.2m&1.5m&1.8m
B	Display Cable	1	Shielded, 1.2m&1.5m&1.8m
C	AC Power Cable	1	Non-Shielded, 1.5m
D	Audio out Cable	1	Non-Shielded, 1.8m
E	USB Cable	1	Shielded, 1.8m, with one ferrites core bonded
F	USB Cable	1	Shielded, 1.2m

27V2H

No.	Device	Manufacturer	Model No.	Description
1	Computer	HP	HP Compaq Elite 8200 MTPC	Non-Shielded ,1.8m
2	USB Keyboard	DELL	SK-8115	N/A
3	USB Mouse	DELL	G0K02XYK	N/A
4	Earphone	Edifier	N/A	N/A

Use cable:

No	Cable	Quantity	Description
A	VGA Cable	1	Shielded, 1.2m&1.5m&1.8m, with two ferrites core bonded
B	Display Cable	1	Shielded, 1.2m&1.5m&1.8m
C	AC Power Cable	1	Non-Shielded, 1.5m
D	Audio out Cable	1	Non-Shielded, 1.8m
E	USB Cable	1	Shielded, 1.8m, with one ferrites core bonded
F	USB Cable	1	Shielded, 1.2m

**3.4. General Information of Test**

<input type="checkbox"/>	Test Site	CerpPASS Technology Corporation Address: No.10, Ln. 2, Lianfu St., Luzhu Dist., Taoyuan City 33848, Taiwan (R.O.C.) Tel:+886-3-3226-888 Fax:+886-3-3226-881 Address: No.68-1, Shihbachongsi, Shihding Township, New Taipei City 223, Taiwan, R.O.C. Tel: +886-2-2663-8582
	FCC	TW1079, TW1061, TW1439
	IC	4934E-1, 4934E-2
	VCCI	T-2205 for Telecommunication Test C-4663 for Conducted emission test R-4218 for Radiated emission test G-10812 for radiated disturbance above 1GHz
<input checked="" type="checkbox"/>	Test Site	CerpPASS Technology (Suzhou) Co.,Ltd Address: No.66,Tangzhuang Road, Suzhou Industrial Park, Jiangsu 215006, China Tel: +86-512-6917-5888 Fax: +86-512-6917-5666
	VCCI	T-1945 for Telecommunication Test C-2919 for Conducted emission test R-2670 for Radiated emission test G-227 for radiated disturbance above 1GHz
Frequency Range Investigated:		Conducted: from 150kHz to 30 MHz Radiation: from 30 MHz to 6000MHz
Test Distance :		The test distance of radiated emission below 1GHz from antenna to EUT is 10 M. The test distance of radiated emission above 1GHz from antenna to EUT is 3 M.



3.5. Measurement Uncertainty

Where relevant, the following measurement uncertainty levels have been estimated for tests performed on the EUT as specified in CISPR 16-4-2:

Measurement	Frequency	Uncertainty
Conducted emissions(LINE)	9KHz-30MHz	+/- 0.7738 dB
Conducted emissions(NEUTRAL)	9KHz-30MHz	+/- 0.7886 dB

Measurement	Polarity	Frequency	Uncertainty
Radiated emissions (below 1GHz)	H	30MHz ~ 200MHz	+/- 3.8909dB
		200MHz ~1000MHz	+/- 3.6555dB
	V	30MHz ~ 200MHz	+/- 3.8948dB
		200MHz ~1000MHz	+/- 3.6538dB
Radiated emissions (above 1GHz)	H	1000MHz ~18000MHz	+/- 3.8948 dB
		18000MHz ~40000MHz	+/-3.8844dB
	V	1000MHz ~18000MHz	+/- 3.8906dB
		18000MHz ~40000MHz	+/- 3.8744dB

Measurement	Uncertainty
ESD—Rise time tr	10%
ESD—Peak current Ip	6%
ESD—Current at 30 ns	6%
ESD—Current at 60 ns	6%
ESD- Charging voltage	1%
RS above 1GHz	±2.37dB
RS under 1GHz	±3.83dB
EFT—Rise time tr	4%
EFT—Peak current Ip	4%
EFT—Current	4%
Surge—Rise time tr	4%



Surge—Peak current Ip	4%
Surge—Current	4%
CS-CND	±0.80dB
CS-Clamp	±1.06dB

This uncertainty represents an expanded uncertainty expressed at approximately the 95% confidence level using a coverage factor of k=2.

Consistent with industry standard (e.g. CISPR 32: 2015, clause 11, Measurement Uncertainty) determining compliance with the limits shall be base on the results of the compliance measurement. Consequently the measure emissions being less than the maximum allowed emission result in this be a compliant test or passing test.



4. Test of Conducted Emission

4.1. Test Limit

Conducted Emissions were measured from 150 kHz to 30 MHz with a bandwidth of 9 kHz and return leads of the EUT according to the methods defined in European Standard EN 55032.

Table A.8 – Requirements for conducted emissions from the AC mains power ports of Class A equipment

Applicable to				
1. AC mains power ports (3.1.1)				
Table clause	Frequency range MHz	Coupling device (see Table A.7)	Detector type / bandwidth	Class A limits dB(μ V)
A8.1	0,15 – 0,5	AMN	Quasi Peak / 9 kHz	79
	0,5 – 30			73
A8.2	0,15 – 0,5	AMN	Average / 9 kHz	66
	0,5 – 30			60

NOTE Apply A8.1 and A8.2 across the entire frequency range.

Table A.9 – Requirements for conducted emissions from the AC mains power ports of Class B equipment

Applicable to				
1. AC mains power ports (3.1.1)				
Table clause	Frequency range MHz	Coupling device (see Table A.7)	Detector type / bandwidth	Class B limits dB(μ V)
A9.1	0,15 – 0,5	AMN	Quasi Peak / 9 kHz	66 – 56
	0,5 – 5			56
	5 – 30			60
A9.2	0,15 – 0,5	AMN	Average / 9 kHz	56 – 46
	0,5 – 5			46
	5 – 30			50

NOTE Apply A9.1 and A9.2 across the entire frequency range.

**Table A.10 – Requirements for asymmetric mode conducted emissions from Class A equipment**

Applicable to					
1. wired network ports (3.1.30)					
2. optical fibre ports (3.1.24) with metallic shield or tension members					
3. antenna ports (3.1.3)					
Table clause	Frequency range MHz	Coupling device (see Table A.7)	Detector type / bandwidth	Class A voltage limits dB(μV)	Class A current limits dB(μA)
A10.1	0,15 – 0,5	AAN	Quasi Peak / 9 kHz	97 – 87	n/a
	0,5 – 30			87	
	0,15 – 0,5	AAN	Average / 9 kHz	84 – 74	
	0,5 – 30			74	
A10.2	0,15 – 0,5	CVP and current probe	Quasi Peak / 9 kHz	97 – 87	53 – 43
	0,5 – 30			87	43
	0,15 – 0,5	CVP and current probe	Average / 9 kHz	84 – 74	40 – 30
	0,5 – 30			74	30
A10.3	0,15 – 0,5	Current Probe	Quasi Peak / 9 kHz	n/a	53 – 43
	0,5 – 30				43
	0,15 – 0,5	Current Probe	Average / 9 kHz		40 – 30
	0,5 – 30				30
NOTE 1 The choice of coupling device and measurement procedure is defined in Annex C.					
NOTE 2 AC mains power ports shall meet the limits given in Table A.8.					
NOTE 3 The test shall cover the entire frequency range.					
NOTE 4 The application of the voltage and/or current limits is dependent on the measurement procedure used. Refer to Table C.1 for applicability.					
NOTE 5 Testing is required at only one EUT supply voltage and frequency.					
NOTE 6 Applicable to ports listed above and intended to connect to cables longer than 3 m.					

**Table A.11 – Requirements for asymmetric mode conducted emissions from Class B equipment**

Applicable to					
1. wired network ports (3.1.30)					
2. optical fibre ports (3.1.24) with metallic shield or tension members					
3. broadcast receiver tuner ports (3.1.8)					
4. antenna ports (3.1.3)					
Table clause	Frequency range MHz	Coupling device (see Table A.7)	Detector type / bandwidth	Class B voltage limits dB(μV)	Class B current limits dB(μA)
A11.1	0,15 – 0,5	AAN	Quasi Peak / 9 kHz	84 – 74	n/a
	0,5 – 30			74	
	0,15 – 0,5	AAN	Average / 9 kHz	74 – 64	
	0,5 – 30			64	
A11.2	0,15 – 0,5	CVP and current probe	Quasi Peak / 9 kHz	84 – 74	40 – 30
	0,5 – 30			74	30
	0,15 – 0,5	CVP and current probe	Average / 9 kHz	74 – 64	30 – 20
	0,5 – 30			64	20
A11.3	0,15 – 0,5	Current Probe	Quasi Peak / 9 kHz	n/a	40 – 30
	0,5 – 30				30
	0,15 – 0,5	Current Probe	Average / 9 kHz		30 – 20
	0,5 – 30				20
NOTE 1 The choice of coupling device and measurement procedure is defined in Annex C.					
NOTE 2 Screened ports including TV broadcast receiver tuner ports are tested with a common-mode impedance of 150 Ω . This is typically accomplished with the screen terminated by 150 Ω to earth.					
NOTE 3 AC mains power ports shall meet the limits given in Table A.9.					
NOTE 4 The test shall cover the entire frequency range.					
NOTE 5 The application of the voltage and/or current limits is dependent on the measurement procedure used. Refer to Table C.1 for applicability.					
NOTE 6 Testing is required at only one EUT supply voltage and frequency.					
NOTE 7 Applicable to ports listed above and intended to connect to cables longer than 3 m.					

4.2. Test Procedures

- a. The EUT was placed on a desk 0.8 meters height from the metal ground plane and 0.4 meter from the conducting wall of the shielding room and it was kept at least 0.8 meters from any other grounded conducting surface.
- b. Connect EUT to the power mains through a Artificial Mains Network (AMN).
- c. All the support units are connecting to the other AMN.
- d. The AMN provides 50 ohm coupling impedance for the measuring instrument.
- e. The CISPR states that a 50 ohm, 50 micro-Henry AMN should be used.
- f. Both sides of AC line were checked for maximum conducted interference.
- g. The frequency range from 150 kHz to 30 MHz was searched
- h. Set the test-receiver system to Peak Detect Function and Specified Bandwidth with Maximum Hold Mode.

4.3. Typical Test Setup

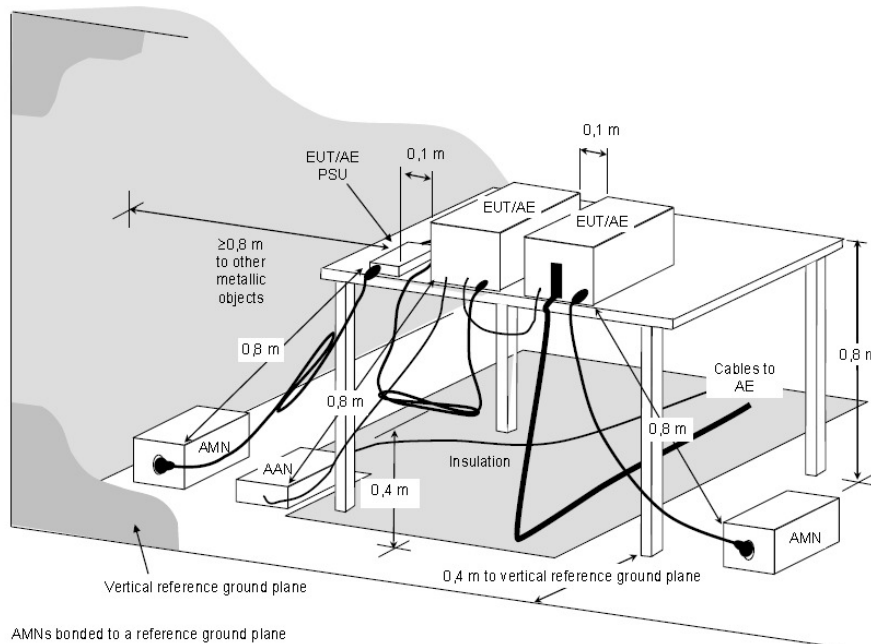

NOTE The 0,8 m distance specified between EUT/AE/PSU and AMN/AAN, is applicable only to the EUT being measured. If the device is AE then it shall be $\geq 0,8$ m.

**Figure D.2 – Example measurement arrangement for table-top EUT
(Conducted emission measurement – alternative 1)**



4.4. Measurement Equipment

Instrument/Ancillary	Manufacturer	Model No.	Serial No.	Calibration Date	Valid Date.
Test Receiver	R&S	ESCI	100565	2017.07.19	2018.07.18
AMN	R&S	ESH2-Z5	100182	2017.08.26	2018.08.25
ISN	FCC	FCC-TLISN-T2-02	20379	2018.03.21	2019.03.20
ISN	FCC	FCC-TLISN-T4-02	20380	2017.06.21	2018.06.20
ISN	FCC	FCC-TLISN-T8-02	20381	2017.11.29	2018.11.28
ISN	TESEQ	ISN ST08	30175	2017.08.26	2018.08.25
ISN	TESEQ	ISN S751	31531	2017.10.17	2018.10.16
LISN	FCC	FCC-LISN-50-200-2-02	112087	2017.08.26	2018.08.25
LISN	SCHWARZBECK	NSLK 8127	8127-920	2017.11.08	2018.11.07
Current Probe	R&S	EZ-17	100303	2018.03.21	2019.03.20
Passive Voltage Probe	R&S	ESH2-Z3	100026	2018.03.21	2019.03.20
Pulse Limiter	R&S	ESH3-Z2	100529	2018.03.21	2019.03.20
Temperature/ Humidity Meter	Zhicheng	ZC1-11	CEP-TH-004	2018.03.23	2019.03.22
EZ-EMC	Fala	Ver CT3A1	N/A	N/A	N/A



4.5. Test Data and Result

4.5.1 Conducted Emission for Power Port Test Data

27V2Q:

Test Mode :	Mode 1: Full system (Display mode 1920*1080@60Hz) Signal from PC for ITU-RBT 1729 Colour bars (230V/50Hz)		
AC Power :	AC 230V/50Hz	Phase :	LINE
Equipment :	LCD Monitor	Model No :	27V2Q
Temperature :	24°C	Humidity :	53%
Pressure(mbar) :	1001	Date:	2018/04/07

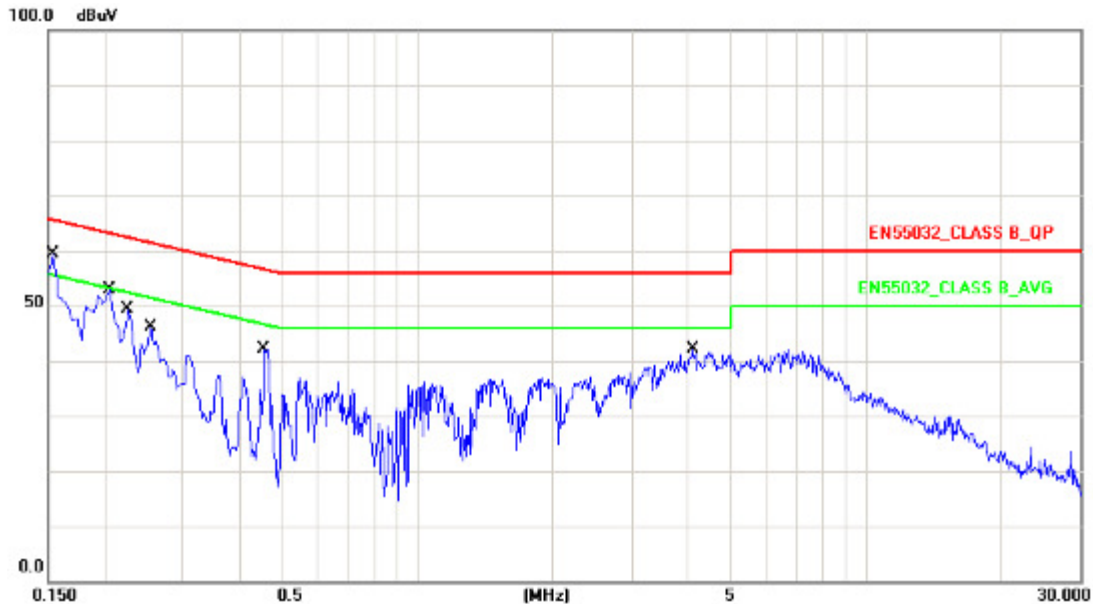

No.	Frequency (MHz)	Factor (dB)	Reading (dBuV)	Level (dBuV)	Limit (dBuV)	Margin (dB)	Detector
1	0.1539	10.15	45.74	55.89	65.78	-9.89	QP
2	0.1539	10.15	29.40	39.55	55.78	-16.23	AVG
3	0.2060	10.13	39.98	50.11	63.36	-13.25	QP
4	0.2060	10.13	26.21	36.34	53.36	-17.02	AVG
5	0.2260	10.13	28.97	39.10	62.59	-23.49	QP
6	0.2260	10.13	15.17	25.30	52.59	-27.29	AVG
7	0.2540	10.14	33.17	43.31	61.62	-18.31	QP
8	0.2540	10.14	21.59	31.73	51.62	-19.89	AVG
9	0.4540	10.16	29.76	39.92	56.80	-16.88	QP
10	0.4540	10.16	23.22	33.38	46.80	-13.42	AVG
11	4.1100	10.24	27.83	38.07	56.00	-17.93	QP
12	4.1100	10.24	16.62	26.86	46.00	-19.14	AVG

Note: Measurement Level = Reading Level + Correct Factor



Test Mode :	Mode 1: Full system (Display mode 1920*1080@60Hz) Signal from PC for ITU-RBT 1729 Colour bars (230V/50Hz)		
AC Power :	AC 230V/50Hz	Phase :	NEUTRAL
Equipment :	LCD Monitor	Model No :	27V2Q
Temperature :	24°C	Humidity :	53%
Pressure(mbar) :	1001	Date:	2018/04/07

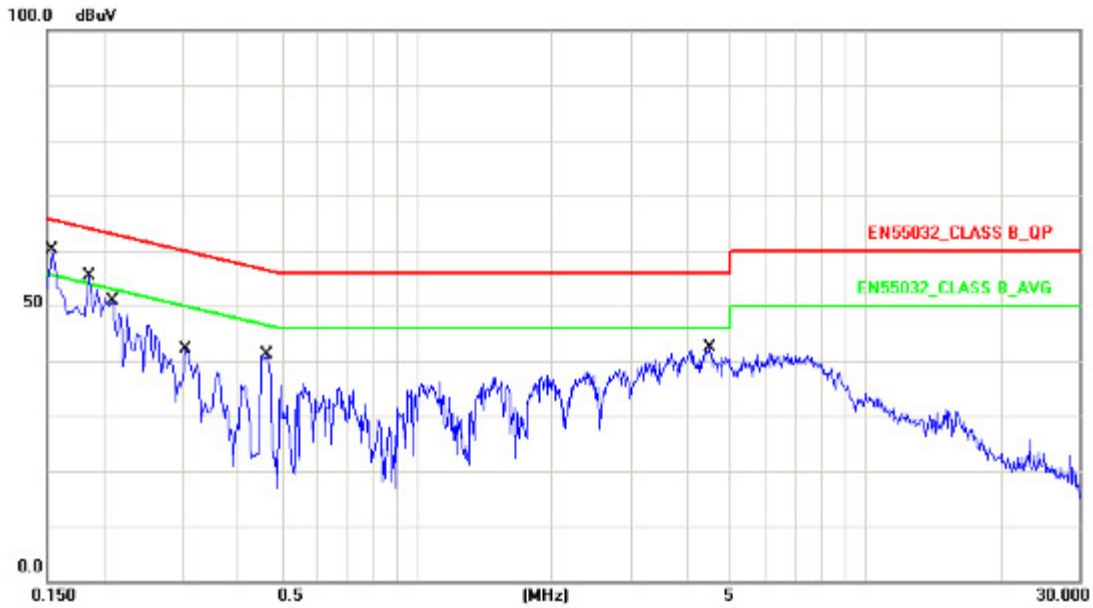

No.	Frequency (MHz)	Factor (dB)	Reading (dBuV)	Level (dBuV)	Limit (dBuV)	Margin (dB)	Detector
1	0.1539	10.15	46.71	56.86	65.78	-8.92	QP
2	0.1539	10.15	29.91	40.06	55.78	-15.72	AVG
3	0.1860	10.14	38.73	48.87	64.21	-15.34	QP
4	0.1860	10.14	21.73	31.87	54.21	-22.34	AVG
5	0.2100	10.14	37.56	47.70	63.20	-15.50	QP
6	0.2100	10.14	25.31	35.45	53.20	-17.75	AVG
7	0.3060	10.14	29.34	39.48	60.08	-20.60	QP
8	0.3060	10.14	21.50	31.64	50.08	-18.44	AVG
9	0.4620	10.15	29.32	39.47	56.66	-17.19	QP
10	0.4620	10.15	24.66	34.81	46.66	-11.85	AVG
11	4.5180	10.26	27.24	37.50	56.00	-18.50	QP
12	4.5180	10.26	16.39	26.65	46.00	-19.35	AVG

Note: Measurement Level = Reading Level + Correct Factor



Test Mode :	Mode 8: Full system (Display mode 1920*1080@60Hz) Signal from PC for ITU-RBT 1729 Colour bars (110V/60Hz)		
AC Power :	AC 110V/60Hz	Phase :	LINE
Equipment :	LCD Monitor	Model No :	27V2Q
Temperature :	24°C	Humidity :	53%
Pressure(mbar) :	1001	Date:	2018/04/07

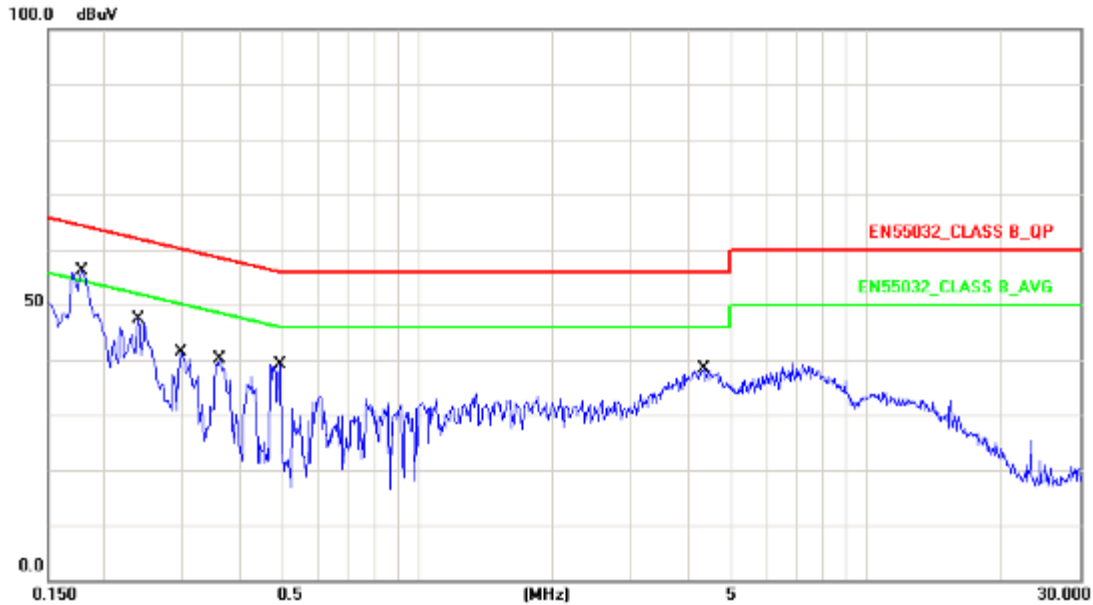

No.	Frequency (MHz)	Factor (dB)	Reading (dBuV)	Level (dBuV)	Limit (dBuV)	Margin (dB)	Detector
1	0.1780	10.13	43.32	53.45	64.57	-11.12	QP
2	0.1780	10.13	28.76	38.89	54.57	-15.68	AVG
3	0.2380	10.13	33.53	43.66	62.16	-18.50	QP
4	0.2380	10.13	19.41	29.54	52.16	-22.62	AVG
5	0.2980	10.14	28.03	38.17	60.30	-22.13	QP
6	0.2980	10.14	15.30	25.44	50.30	-24.86	AVG
7	0.3620	10.15	28.32	38.47	58.68	-20.21	QP
8	0.3620	10.15	24.09	34.24	48.68	-14.44	AVG
9	0.4940	10.16	24.75	34.91	56.10	-21.19	QP
10	0.4940	10.16	10.25	20.41	46.10	-25.69	AVG
11	4.3420	10.24	23.50	33.74	56.00	-22.26	QP
12	4.3420	10.24	12.61	22.85	46.00	-23.15	AVG

Note: Measurement Level = Reading Level + Correct Factor



Test Mode :	Mode 8: Full system (Display mode 1920*1080@60Hz) Signal from PC for ITU-RBT 1729 Colour bars (110V/60Hz)		
AC Power :	AC 110V/60Hz	Phase :	NEUTRAL
Equipment :	LCD Monitor	Model No :	27V2Q
Temperature :	24°C	Humidity :	53%
Pressure(mbar) :	1001	Date:	2018/04/07

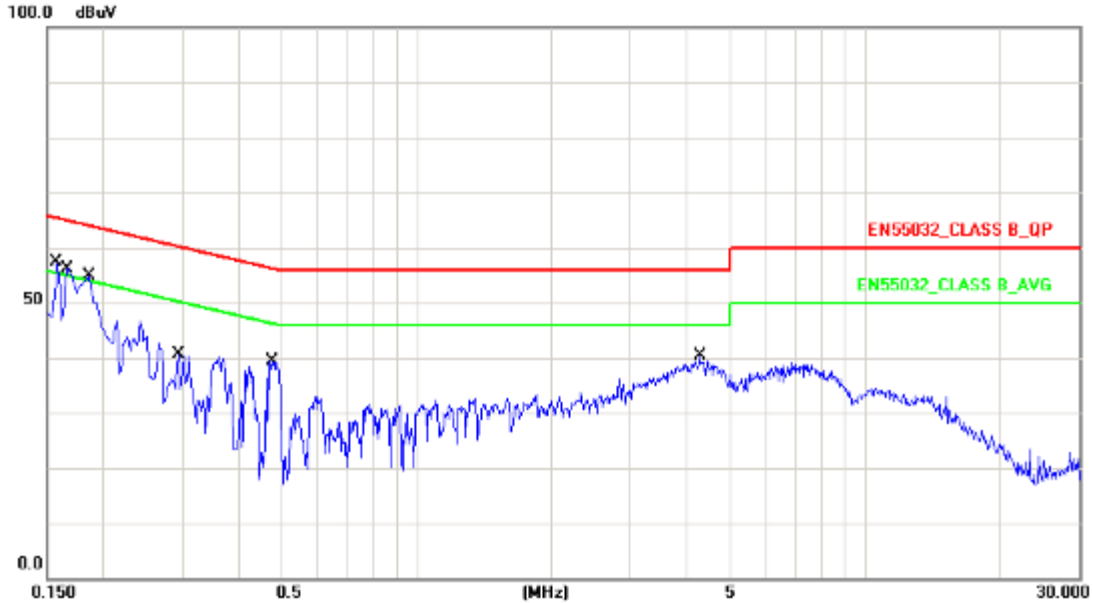

No.	Frequency (MHz)	Factor (dB)	Reading (dBuV)	Level (dBuV)	Limit (dBuV)	Margin (dB)	Detector
1	0.1580	10.15	35.43	45.58	65.56	-19.98	QP
2	0.1580	10.15	16.38	26.53	55.56	-29.03	AVG
3	0.1660	10.15	41.77	51.92	65.15	-13.23	QP
4	0.1660	10.15	21.58	31.73	55.15	-23.42	AVG
5	0.1860	10.14	42.13	52.27	64.21	-11.94	QP
6	0.1860	10.14	26.93	37.07	54.21	-17.14	AVG
7	0.2940	10.14	24.30	34.44	60.41	-25.97	QP
8	0.2940	10.14	10.93	21.07	50.41	-29.34	AVG
9	0.4780	10.15	26.89	37.04	56.37	-19.33	QP
10	0.4780	10.15	20.55	30.70	46.37	-15.67	AVG
11	4.2819	10.26	24.75	35.01	56.00	-20.99	QP
12	4.2819	10.26	14.31	24.57	46.00	-21.43	AVG

Note: Measurement Level = Reading Level + Correct Factor



Test Mode :	Mode 10: Full system (Display mode 1920*1080@60Hz) Signal from PC for ITU-RBT 471-1 Colour bars (230V/50Hz)		
AC Power :	AC 230V/50Hz	Phase :	LINE
Equipment :	LCD Monitor	Model No :	27V2Q
Temperature :	24°C	Humidity :	53%
Pressure(mbar) :	1001	Date:	2018/04/07

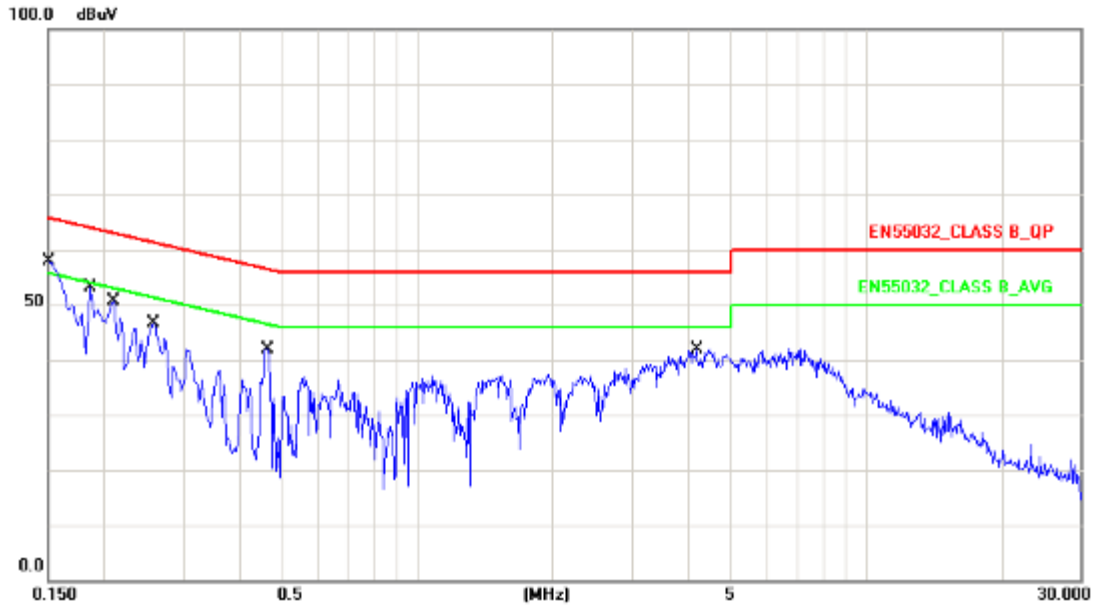

No.	Frequency (MHz)	Factor (dB)	Reading (dBuV)	Level (dBuV)	Limit (dBuV)	Margin (dB)	Detector
1	0.1500	10.15	43.96	54.11	65.99	-11.88	QP
2	0.1500	10.15	28.85	39.00	55.99	-16.99	AVG
3	0.1860	10.13	37.93	48.06	64.21	-16.15	QP
4	0.1860	10.13	21.75	31.88	54.21	-22.33	AVG
5	0.2100	10.13	36.41	46.54	63.20	-16.66	QP
6	0.2100	10.13	24.88	35.01	53.20	-18.19	AVG
7	0.2580	10.14	33.64	43.78	61.49	-17.71	QP
8	0.2580	10.14	22.06	32.20	51.49	-19.29	AVG
9	0.4620	10.16	29.97	40.13	56.66	-16.53	QP
10	0.4620	10.16	24.98	35.14	46.66	-11.52	AVG
11	4.1940	10.24	25.77	36.01	56.00	-19.99	QP
12	4.1940	10.24	15.53	25.77	46.00	-20.23	AVG

Note: Measurement Level = Reading Level + Correct Factor



Test Mode :	Mode 10: Full system (Display mode 1920*1080@60Hz) Signal from PC for ITU-RBT 471-1 Colour bars (230V/50Hz)		
AC Power :	AC 230V/50Hz	Phase :	NEUTRAL
Equipment :	LCD Monitor	Model No :	27V2Q
Temperature :	24°C	Humidity :	53%
Pressure(mbar) :	1001	Date:	2018/04/07

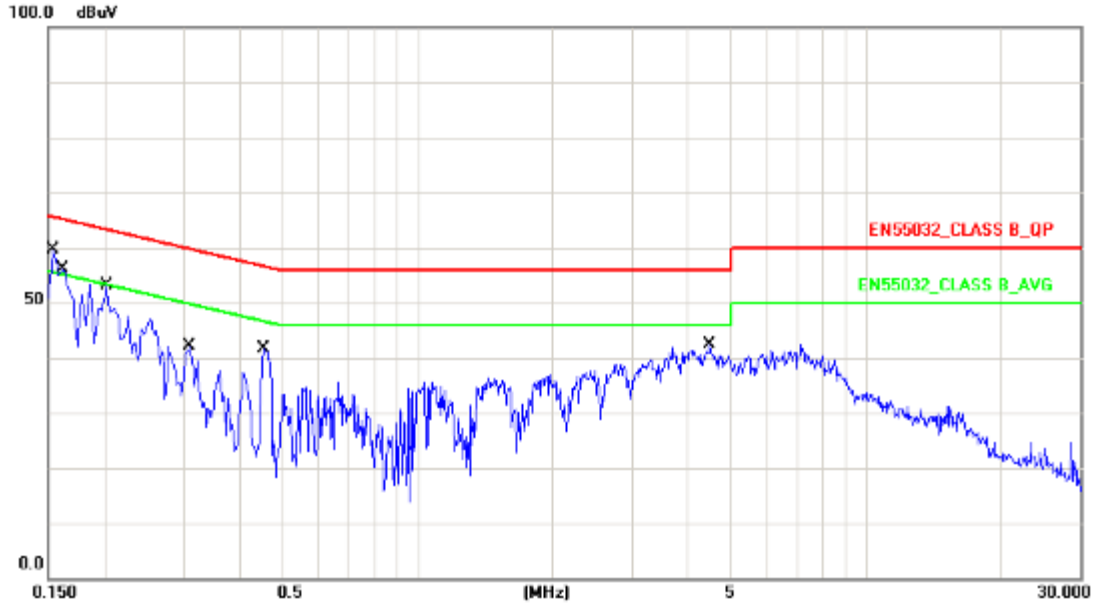

No.	Frequency (MHz)	Factor (dB)	Reading (dBuV)	Level (dBuV)	Limit (dBuV)	Margin (dB)	Detector
1	0.1539	10.15	46.43	56.58	65.78	-9.20	QP
2	0.1539	10.15	29.80	39.95	55.78	-15.83	AVG
3	0.1624	10.15	41.27	51.42	65.34	-13.92	QP
4	0.1624	10.15	24.58	34.73	55.34	-20.61	AVG
5	0.2020	10.14	38.33	48.47	63.52	-15.05	QP
6	0.2020	10.14	25.83	35.97	53.52	-17.55	AVG
7	0.3100	10.14	29.73	39.87	59.97	-20.10	QP
8	0.3100	10.14	23.22	33.36	49.97	-16.61	AVG
9	0.4540	10.15	29.35	39.50	56.80	-17.30	QP
10	0.4540	10.15	22.64	32.79	46.80	-14.01	AVG
11	4.4860	10.26	27.67	37.93	56.00	-18.07	QP
12	4.4860	10.26	16.29	26.55	46.00	-19.45	AVG

Note: Measurement Level = Reading Level + Correct Factor



Test Mode :	Mode 11: Full system (Display mode 1920*1080@60Hz) Signal from PC for ITU-RBT 471-1 Colour bars (110V/60Hz)		
AC Power :	AC 110V/60Hz	Phase :	LINE
Equipment :	LCD Monitor	Model No :	27V2Q
Temperature :	24°C	Humidity :	53%
Pressure(mbar) :	1001	Date:	2018/04/07

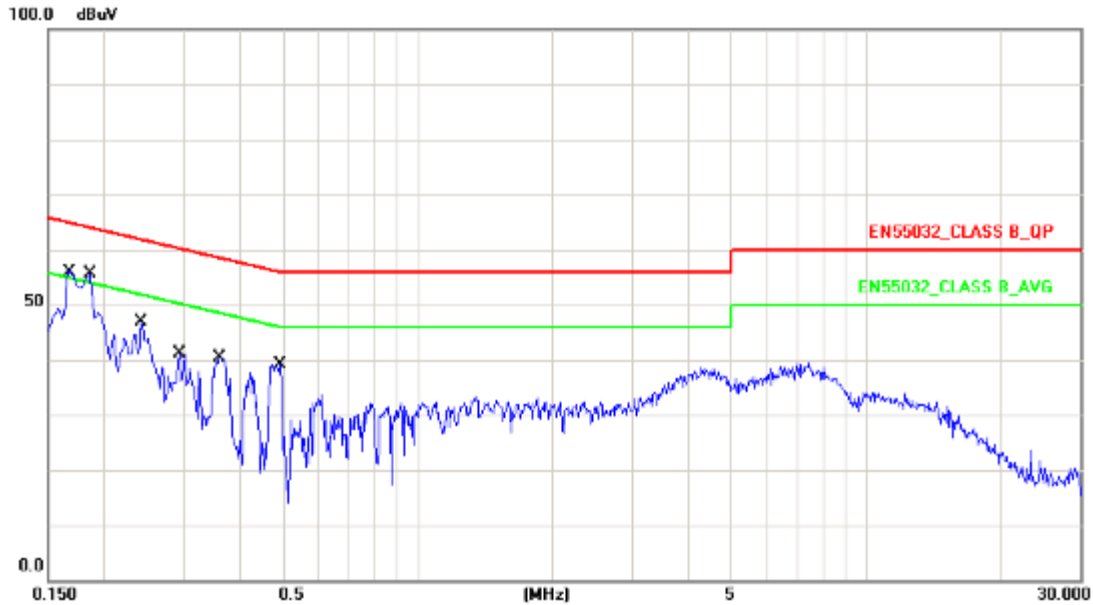

No.	Frequency (MHz)	Factor (dB)	Reading (dBuV)	Level (dBuV)	Limit (dBuV)	Margin (dB)	Detector
1	0.1700	10.15	41.78	51.93	64.96	-13.03	QP
2	0.1700	10.15	23.75	33.90	54.96	-21.06	AVG
3	0.1860	10.13	42.40	52.53	64.21	-11.68	QP
4	0.1860	10.13	26.89	37.02	54.21	-17.19	AVG
5	0.2420	10.13	33.26	43.39	62.02	-18.63	QP
6	0.2420	10.13	21.02	31.15	52.02	-20.87	AVG
7	0.2940	10.14	26.16	36.30	60.41	-24.11	QP
8	0.2940	10.14	10.94	21.08	50.41	-29.33	AVG
9	0.3620	10.15	28.39	38.54	58.68	-20.14	QP
10	0.3620	10.15	24.13	34.28	48.68	-14.40	AVG
11	0.4940	10.16	24.88	35.04	56.10	-21.06	QP
12	0.4940	10.16	10.07	20.23	46.10	-25.87	AVG

Note: Measurement Level = Reading Level + Correct Factor



Test Mode :	Mode 11: Full system (Display mode 1920*1080@60Hz) Signal from PC for ITU-RBT 471-1 Colour bars (110V/60Hz)		
AC Power :	AC 110V/60Hz	Phase :	NEUTRAL
Equipment :	LCD Monitor	Model No :	27V2Q
Temperature :	24°C	Humidity :	53%
Pressure(mbar) :	1001	Date:	2018/04/07

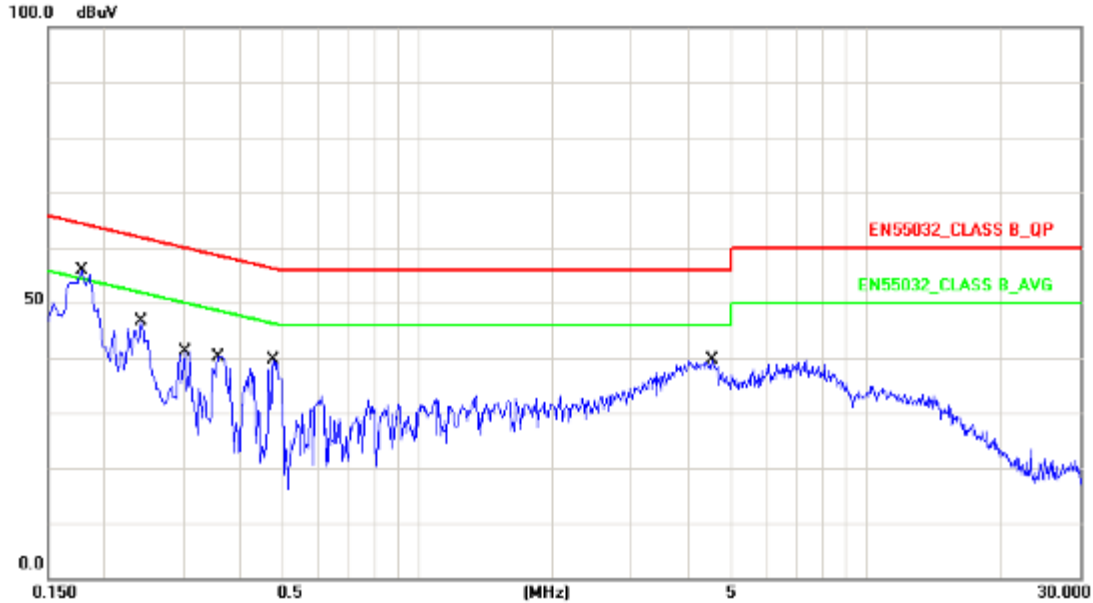

No.	Frequency (MHz)	Factor (dB)	Reading (dBuV)	Level (dBuV)	Limit (dBuV)	Margin (dB)	Detector
1	0.1780	10.14	42.70	52.84	64.57	-11.73	QP
2	0.1780	10.14	28.49	38.63	54.57	-15.94	AVG
3	0.2420	10.14	33.38	43.52	62.02	-18.50	QP
4	0.2420	10.14	21.34	31.48	52.02	-20.54	AVG
5	0.3020	10.14	27.64	37.78	60.19	-22.41	QP
6	0.3020	10.14	17.51	27.65	50.19	-22.54	AVG
7	0.3580	10.15	27.87	38.02	58.77	-20.75	QP
8	0.3580	10.15	22.61	32.76	48.77	-16.01	AVG
9	0.4780	10.15	26.91	37.06	56.37	-19.31	QP
10	0.4780	10.15	20.53	30.68	46.37	-15.69	AVG
11	4.5300	10.26	24.41	34.67	56.00	-21.33	QP
12	4.5300	10.26	13.10	23.36	46.00	-22.64	AVG

Note: Measurement Level = Reading Level + Correct Factor



27V2H:

Test Mode :	Mode 1: Full system (VGA mode 1920*1080@60Hz) Signal from PC for ITU-RBT 1729 Colour bars (230V/50Hz)		
AC Power :	AC 230V/50Hz	Phase :	LINE
Equipment :	LCD Monitor	Model No :	27V2H
Temperature :	24°C	Humidity :	53%
Pressure(mbar) :	1001	Date:	2018/04/07

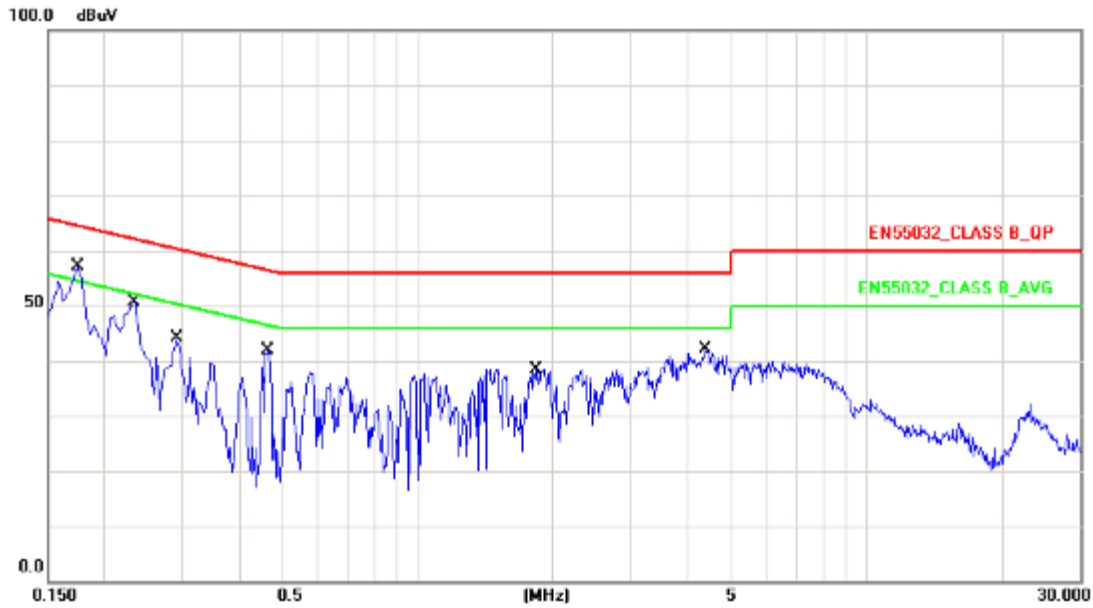

No.	Frequency (MHz)	Factor (dB)	Reading (dBuV)	Level (dBuV)	Limit (dBuV)	Margin (dB)	Detector
1	0.1740	10.15	44.62	54.77	64.76	-9.99	QP
2	0.1740	10.15	31.18	41.33	54.76	-13.43	AVG
3	0.2340	10.13	37.38	47.51	62.30	-14.79	QP
4	0.2340	10.13	26.65	36.78	52.30	-15.52	AVG
5	0.2900	10.14	31.91	42.05	60.52	-18.47	QP
6	0.2900	10.14	24.62	34.76	50.52	-15.76	AVG
7	0.4660	10.16	29.60	39.76	56.58	-16.82	QP
8	0.4660	10.16	24.21	34.37	46.58	-12.21	AVG
9	1.8460	10.18	25.95	36.13	56.00	-19.87	QP
10	1.8460	10.18	16.62	26.80	46.00	-19.20	AVG
11	4.3859	10.24	28.46	38.70	56.00	-17.30	QP
12	4.3859	10.24	17.37	27.61	46.00	-18.39	AVG

Note: Measurement Level = Reading Level + Correct Factor



Test Mode :	Mode 1: Full system (VGA mode 1920*1080@60Hz) Signal from PC for ITU-RBT 1729 Colour bars (230V/50Hz)		
AC Power :	AC 230V/50Hz	Phase :	NEUTRAL
Equipment :	LCD Monitor	Model No :	27V2H
Temperature :	24°C	Humidity :	53%
Pressure(mbar) :	1001	Date:	2018/04/07

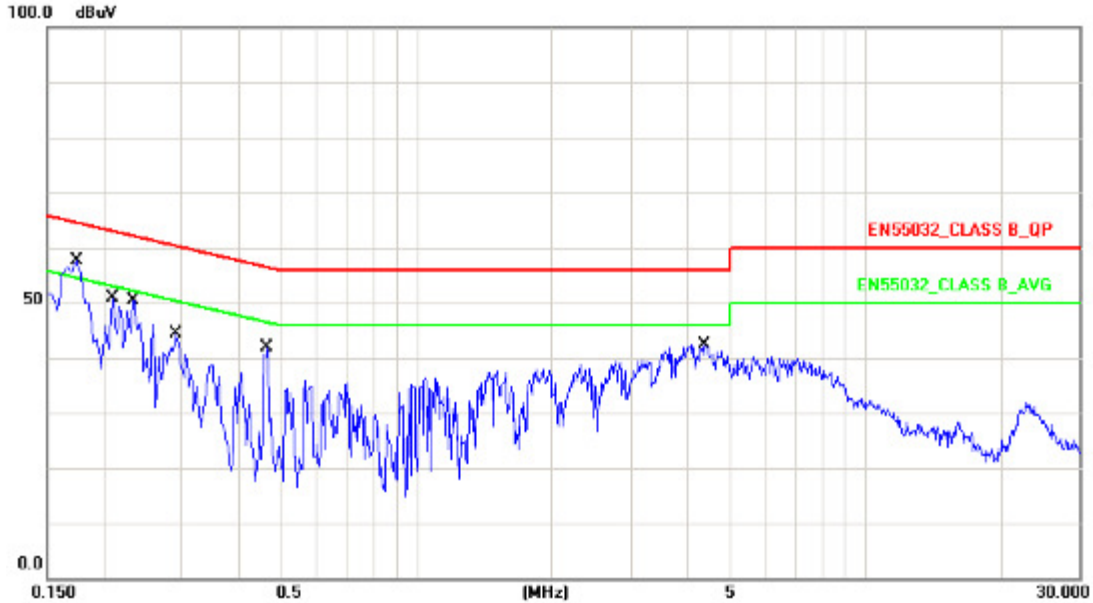

No.	Frequency (MHz)	Factor (dB)	Reading (dBuV)	Level (dBuV)	Limit (dBuV)	Margin (dB)	Detector
1	0.1740	10.15	45.09	55.24	64.76	-9.52	QP
2	0.1740	10.15	31.22	41.37	54.76	-13.39	AVG
3	0.2100	10.14	32.68	42.82	63.20	-20.38	QP
4	0.2100	10.14	16.46	26.60	53.20	-26.60	AVG
5	0.2340	10.14	37.80	47.94	62.30	-14.36	QP
6	0.2340	10.14	26.45	36.59	52.30	-15.71	AVG
7	0.2900	10.14	32.11	42.25	60.52	-18.27	QP
8	0.2900	10.14	23.92	34.06	50.52	-16.46	AVG
9	0.4660	10.15	29.20	39.35	56.58	-17.23	QP
10	0.4660	10.15	24.13	34.28	46.58	-12.30	AVG
11	4.3980	10.26	29.39	39.65	56.00	-16.35	QP
12	4.3980	10.26	19.30	29.56	46.00	-16.44	AVG

Note: Measurement Level = Reading Level + Correct Factor



Test Mode :	Mode 8: Full system (VGA mode 1920*1080@60Hz) Signal from PC for ITU-RBT 1729 Colour bars (110V/60Hz)		
AC Power :	AC 110V/60Hz	Phase :	LINE
Equipment :	LCD Monitor	Model No :	27V2H
Temperature :	24°C	Humidity :	53%
Pressure(mbar) :	1001	Date:	2018/04/07

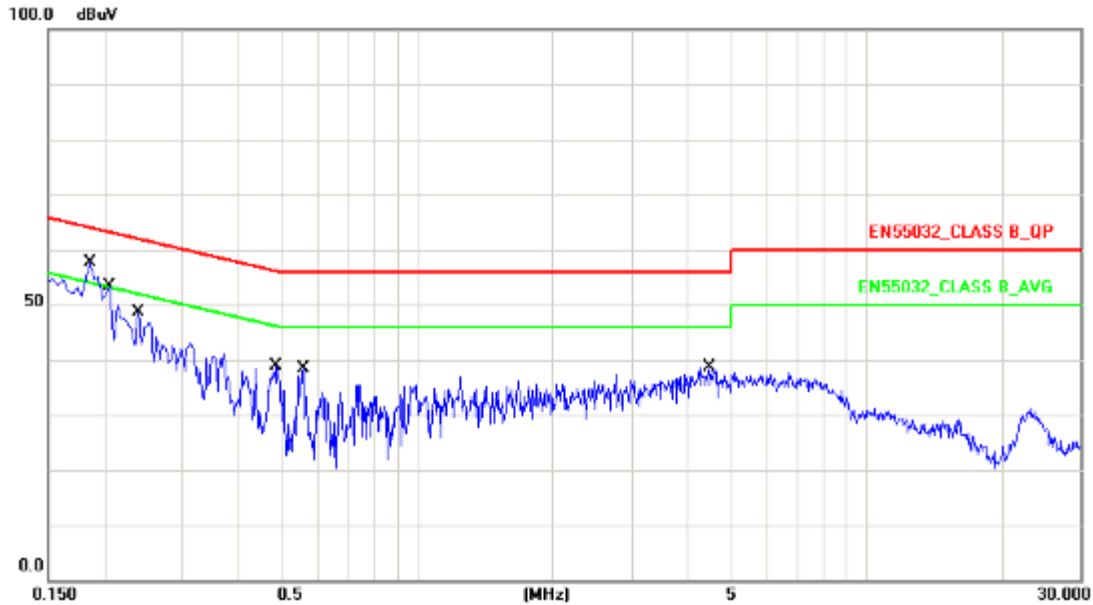

No.	Frequency (MHz)	Factor (dB)	Reading (dBuV)	Level (dBuV)	Limit (dBuV)	Margin (dB)	Detector
1	0.1860	10.13	44.75	54.88	64.21	-9.33	QP
2	0.1860	10.13	28.27	38.40	54.21	-15.81	AVG
3	0.2060	10.13	39.79	49.92	63.36	-13.44	QP
4	0.2060	10.13	19.67	29.80	53.36	-23.56	AVG
5	0.2380	10.13	32.73	42.86	62.16	-19.30	QP
6	0.2380	10.13	14.26	24.39	52.16	-27.77	AVG
7	0.4860	10.16	26.55	36.71	56.24	-19.53	QP
8	0.4860	10.16	19.58	29.74	46.24	-16.50	AVG
9	0.5580	10.16	25.54	35.70	56.00	-20.30	QP
10	0.5580	10.16	12.87	23.03	46.00	-22.97	AVG
11	4.4580	10.24	21.62	31.86	56.00	-24.14	QP
12	4.4580	10.24	11.26	21.50	46.00	-24.50	AVG

Note: Measurement Level = Reading Level + Correct Factor



Test Mode :	Mode 8: Full system (VGA mode 1920*1080@60Hz) Signal from PC for ITU-RBT 1729 Colour bars (110V/60Hz)		
AC Power :	AC 110V/60Hz	Phase :	NEUTRAL
Equipment :	LCD Monitor	Model No :	27V2H
Temperature :	24°C	Humidity :	53%
Pressure(mbar) :	1001	Date:	2018/04/07

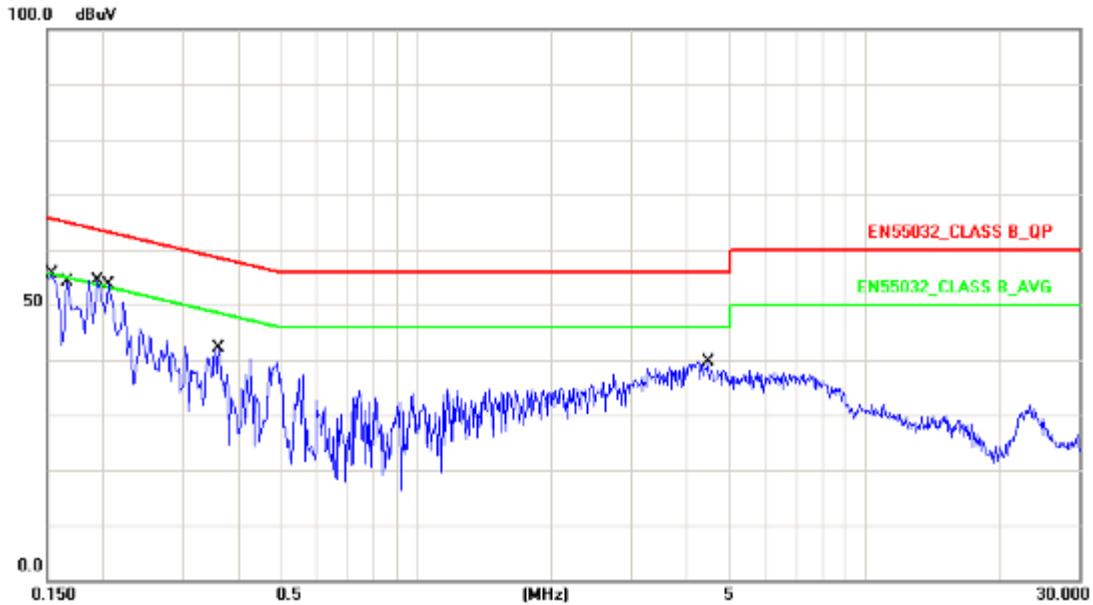

No.	Frequency (MHz)	Factor (dB)	Reading (dBuV)	Level (dBuV)	Limit (dBuV)	Margin (dB)	Detector
1	0.1539	10.15	40.92	51.07	65.78	-14.71	QP
2	0.1539	10.15	22.62	32.77	55.78	-23.01	AVG
3	0.1660	10.15	37.35	47.50	65.15	-17.65	QP
4	0.1660	10.15	18.40	28.55	55.15	-26.60	AVG
5	0.1940	10.14	40.87	51.01	63.86	-12.85	QP
6	0.1940	10.14	24.19	34.33	53.86	-19.53	AVG
7	0.2060	10.14	38.50	48.64	63.36	-14.72	QP
8	0.2060	10.14	18.59	28.73	53.36	-24.63	AVG
9	0.3620	10.15	25.90	36.05	58.68	-22.63	QP
10	0.3620	10.15	13.35	23.50	48.68	-25.18	AVG
11	4.4580	10.26	23.54	33.80	56.00	-22.20	QP
12	4.4580	10.26	13.60	23.86	46.00	-22.14	AVG

Note: Measurement Level = Reading Level + Correct Factor



Test Mode :	Mode 10: Full system (VGA mode 1920*1080@60Hz) Signal from PC for ITU-RBT 471-1 Colour bars (230V/50Hz)		
AC Power :	AC 230V/50Hz	Phase :	LINE
Equipment :	LCD Monitor	Model No :	27V2H
Temperature :	24°C	Humidity :	53%
Pressure(mbar) :	1001	Date:	2018/04/07

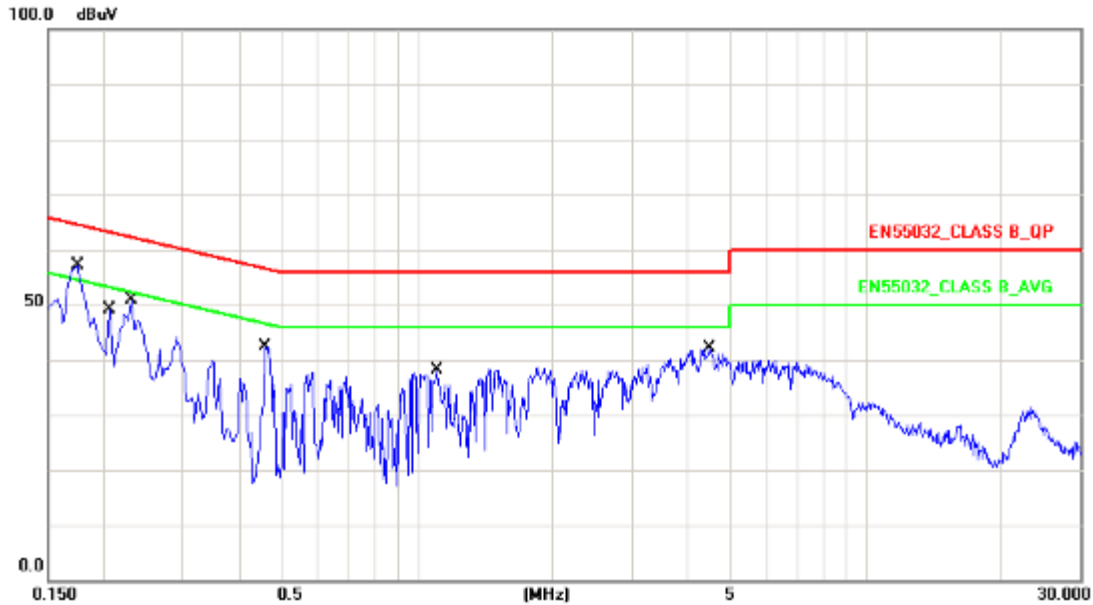

No.	Frequency (MHz)	Factor (dB)	Reading (dBuV)	Level (dBuV)	Limit (dBuV)	Margin (dB)	Detector
1	0.1740	10.15	44.81	54.96	64.76	-9.80	QP
2	0.1740	10.15	31.10	41.25	54.76	-13.51	AVG
3	0.2060	10.13	31.91	42.04	63.36	-21.32	QP
4	0.2060	10.13	14.85	24.98	53.36	-28.38	AVG
5	0.2300	10.13	37.77	47.90	62.45	-14.55	QP
6	0.2300	10.13	26.88	37.01	52.45	-15.44	AVG
7	0.4580	10.16	29.90	40.06	56.73	-16.67	QP
8	0.4580	10.16	25.46	35.62	46.73	-11.11	AVG
9	1.1019	10.17	25.81	35.98	56.00	-20.02	QP
10	1.1019	10.17	18.95	29.12	46.00	-16.88	AVG
11	4.4860	10.24	26.72	36.96	56.00	-19.04	QP
12	4.4860	10.24	14.80	25.04	46.00	-20.96	AVG

Note: Measurement Level = Reading Level + Correct Factor



Test Mode :	Mode 10: Full system (VGA mode 1920*1080@60Hz) Signal from PC for ITU-RBT 471-1 Colour bars (230V/50Hz)		
AC Power :	AC 230V/50Hz	Phase :	NEUTRAL
Equipment :	LCD Monitor	Model No :	27V2H
Temperature :	24°C	Humidity :	53%
Pressure(mbar) :	1001	Date:	2018/04/07

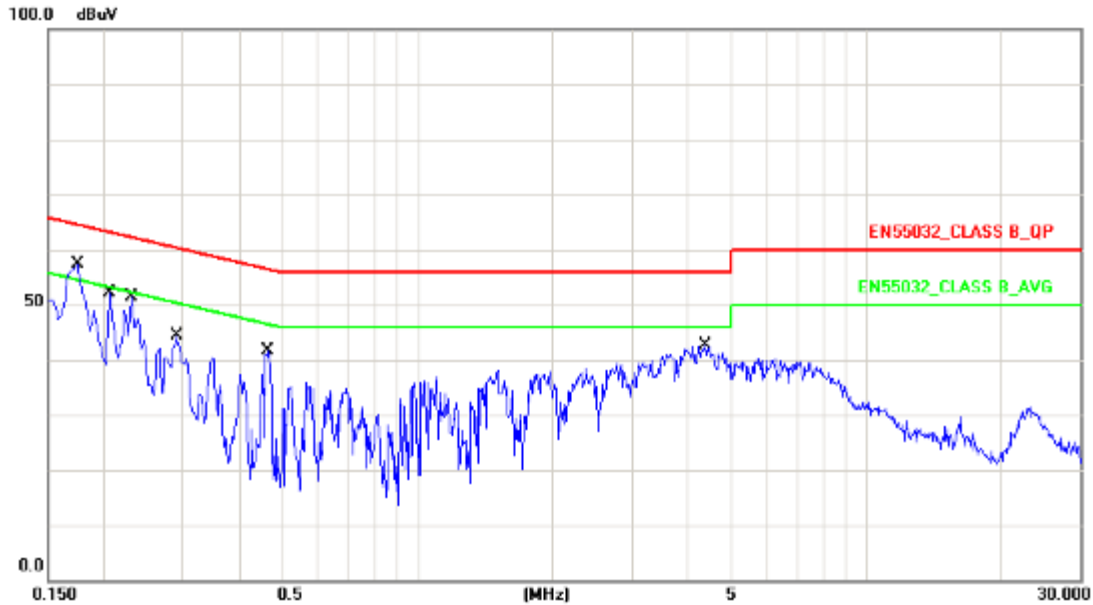

No.	Frequency (MHz)	Factor (dB)	Reading (dBuV)	Level (dBuV)	Limit (dBuV)	Margin (dB)	Detector
1	0.1740	10.15	44.99	55.14	64.76	-9.62	QP
2	0.1740	10.15	31.10	41.25	54.76	-13.51	AVG
3	0.2060	10.14	33.12	43.26	63.36	-20.10	QP
4	0.2060	10.14	15.16	25.30	53.36	-28.06	AVG
5	0.2300	10.14	37.92	48.06	62.45	-14.39	QP
6	0.2300	10.14	26.80	36.94	52.45	-15.51	AVG
7	0.2900	10.14	32.09	42.23	60.52	-18.29	QP
8	0.2900	10.14	24.02	34.16	50.52	-16.36	AVG
9	0.4660	10.15	29.28	39.43	56.58	-17.15	QP
10	0.4660	10.15	24.03	34.18	46.58	-12.40	AVG
11	4.4060	10.26	28.73	38.99	56.00	-17.01	QP
12	4.4060	10.26	18.68	28.94	46.00	-17.06	AVG

Note: Measurement Level = Reading Level + Correct Factor



Test Mode :	Mode 11: Full system (VGA mode 1920*1080@60Hz) Signal from PC for ITU-RBT 471-1 Colour bars (110V/60Hz)		
AC Power :	AC 110V/60Hz	Phase :	LINE
Equipment :	LCD Monitor	Model No :	27V2H
Temperature :	24°C	Humidity :	53%
Pressure(mbar) :	1001	Date:	2018/04/07

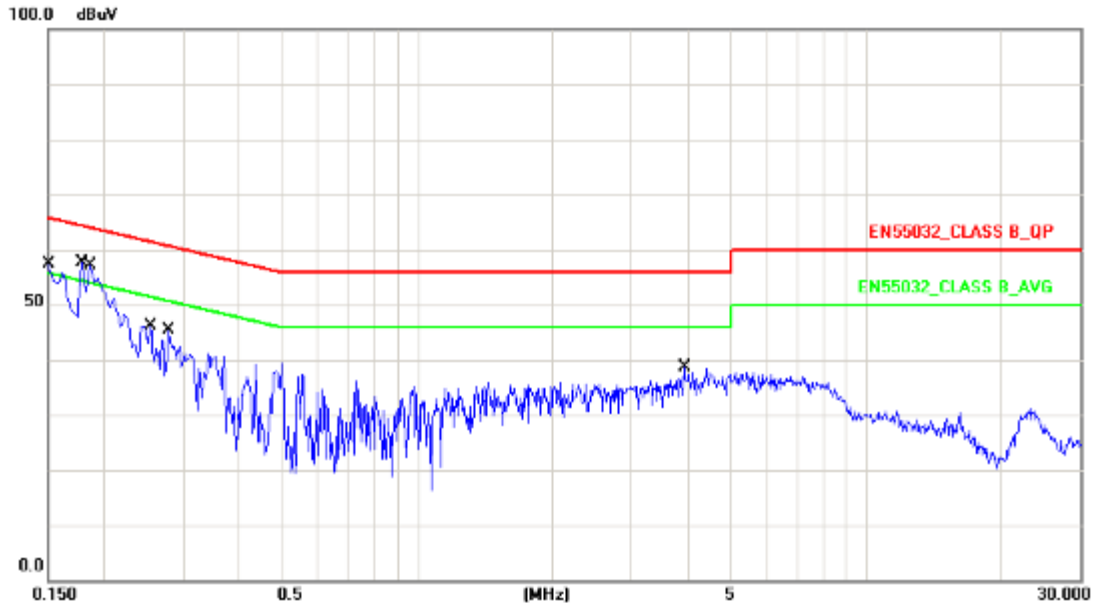

No.	Frequency (MHz)	Factor (dB)	Reading (dBuV)	Level (dBuV)	Limit (dBuV)	Margin (dB)	Detector
1	0.1500	10.15	41.92	52.07	65.99	-13.92	QP
2	0.1500	10.15	23.16	33.31	55.99	-22.68	AVG
3	0.1780	10.13	42.37	52.50	64.57	-12.07	QP
4	0.1780	10.13	23.11	33.24	54.57	-21.33	AVG
5	0.1860	10.13	44.35	54.48	64.21	-9.73	QP
6	0.1860	10.13	27.83	37.96	54.21	-16.25	AVG
7	0.2540	10.14	31.33	41.47	61.62	-20.15	QP
8	0.2540	10.14	15.61	25.75	51.62	-25.87	AVG
9	0.2779	10.14	28.89	39.03	60.88	-21.85	QP
10	0.2779	10.14	13.09	23.23	50.88	-27.65	AVG
11	3.9260	10.23	21.56	31.79	56.00	-24.21	QP
12	3.9260	10.23	10.61	20.84	46.00	-25.16	AVG

Note: Measurement Level = Reading Level + Correct Factor



Test Mode :	Mode 11: Full system (VGA mode 1920*1080@60Hz) Signal from PC for ITU-RBT 471-1 Colour bars (110V/60Hz)		
AC Power :	AC 110V/60Hz	Phase :	NEUTRAL
Equipment :	LCD Monitor	Model No :	27V2H
Temperature :	24°C	Humidity :	53%
Pressure(mbar) :	1001	Date:	2018/04/07

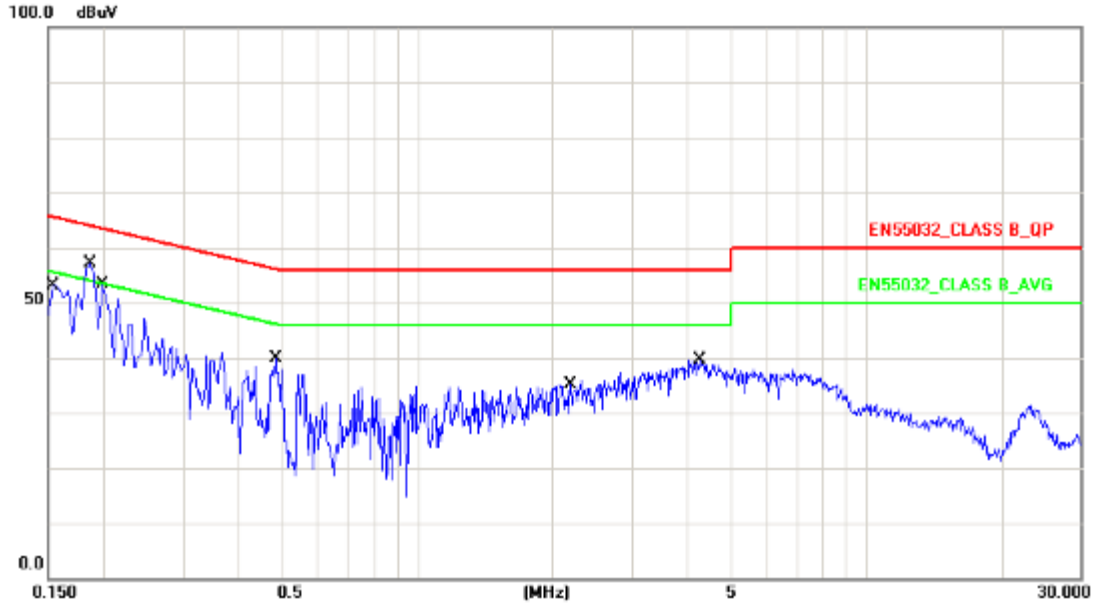

No.	Frequency (MHz)	Factor (dB)	Reading (dBuV)	Level (dBuV)	Limit (dBuV)	Margin (dB)	Detector
1	0.1539	10.15	41.39	51.54	65.78	-14.24	QP
2	0.1539	10.15	22.77	32.92	55.78	-22.86	AVG
3	0.1860	10.14	43.70	53.84	64.21	-10.37	QP
4	0.1860	10.14	27.23	37.37	54.21	-16.84	AVG
5	0.1980	10.14	39.70	49.84	63.69	-13.85	QP
6	0.1980	10.14	22.39	32.53	53.69	-21.16	AVG
7	0.4820	10.15	26.32	36.47	56.30	-19.83	QP
8	0.4820	10.15	20.10	30.25	46.30	-16.05	AVG
9	2.1940	10.19	19.27	29.46	56.00	-26.54	QP
10	2.1940	10.19	7.49	17.68	46.00	-28.32	AVG
11	4.2619	10.26	24.01	34.27	56.00	-21.73	QP
12	4.2619	10.26	13.69	23.95	46.00	-22.05	AVG

Note: Measurement Level = Reading Level + Correct Factor

Test engineer: Sun. Zhang



4.5.2 Conducted Emission for Telecommunication Port Test Data

Note: The EUT doesn't have the telecommunication port.



4.6. Test Photographs
27V2Q

For ITU-RBT 1729 Colour bars

Front View



Rear View

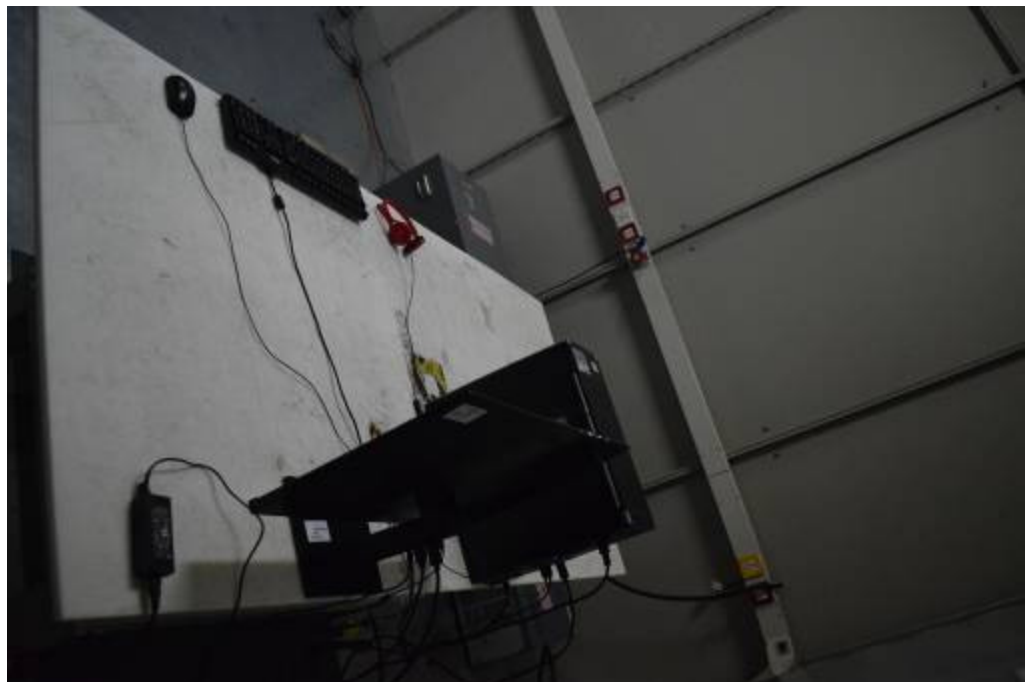



For ITU-RBT 471-1 Colour bars

Front View

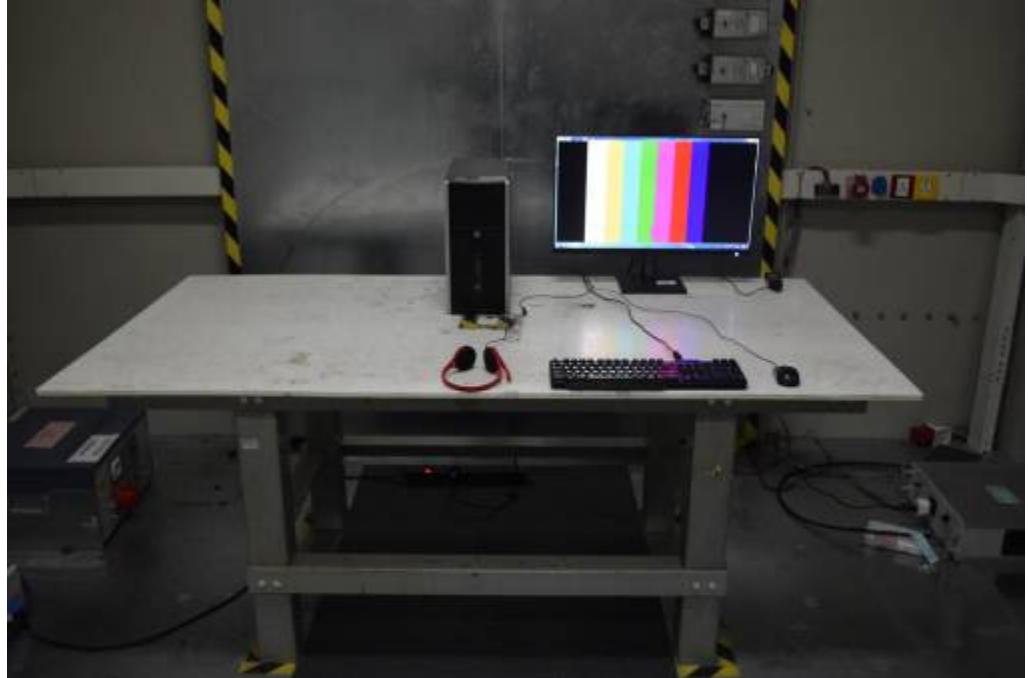

Rear View





27V2H

For ITU-RBT 1729 Colour bars

Front View



Rear View

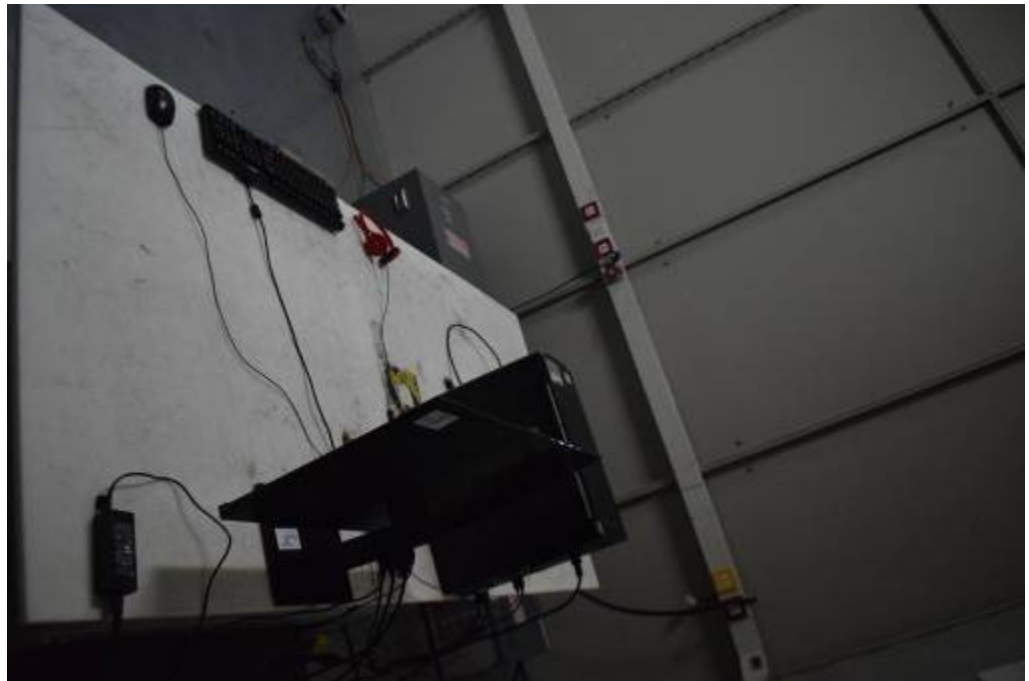



For ITU-RBT 471-1 Colour bars

Front View

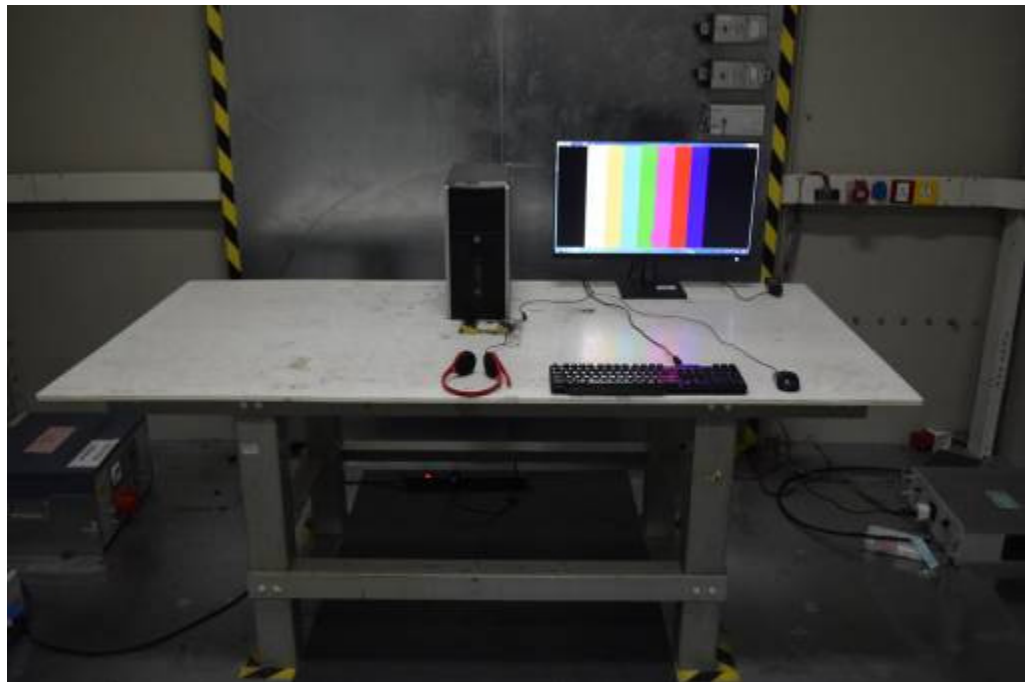

Rear View

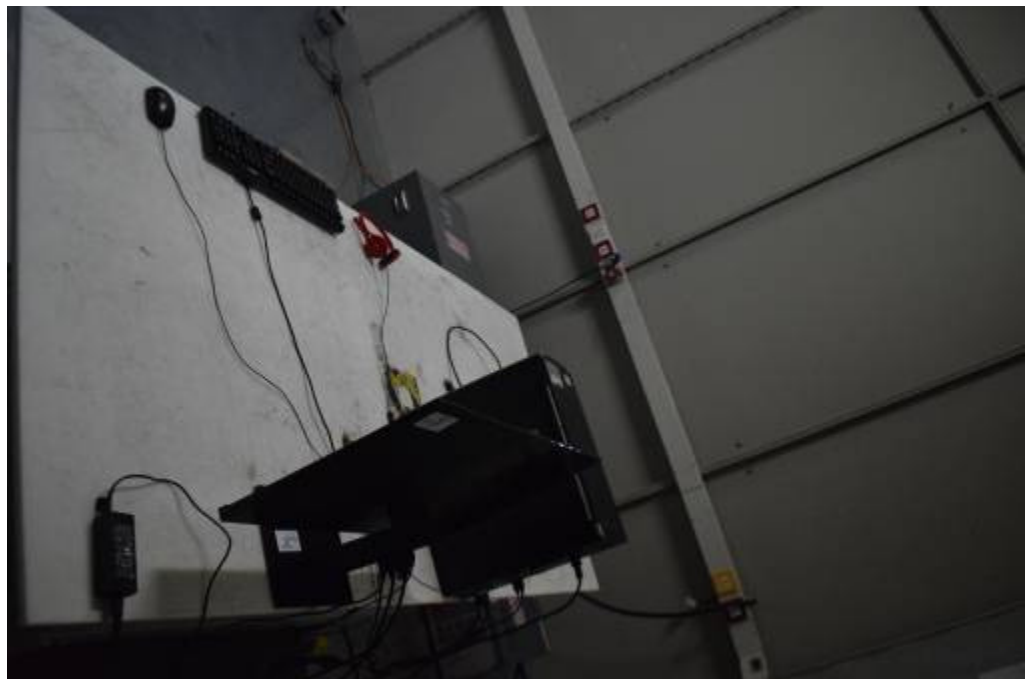



5. Test of Radiated Emission

5.1. Test Limit

The EUT shall meet the limits of below Table when measured at the measuring distance R in accordance with the methods described in European Standard EN 55032. If the reading on the measuring receiver shows fluctuations close to the limit, the reading shall be observed for at least 15 s at each measurement frequency; the highest reading shall be recorded, with the exception of any brief isolated high reading, which shall be ignored.

Table 1 – Required highest frequency for radiated measurement

Highest internal frequency (F_x)	Highest measured frequency
$F_x \leq 108$ MHz	1 GHz
$108 \text{ MHz} < F_x \leq 500$ MHz	2 GHz
$500 \text{ MHz} < F_x \leq 1$ GHz	5 GHz
$F_x > 1$ GHz	$5 \times F_x$ up to a maximum of 6 GHz

NOTE 1 For FM and TV broadcast receivers, F_x is determined from the highest frequency generated or used excluding the local oscillator and tuned frequencies.

NOTE 2 F_x is defined in 3.1.19.

Where the F_x is unknown, the radiated emission measurements shall be performed up to 6 GHz.

Table A.2 – Requirements for radiated emissions at frequencies up to 1 GHz for Class A equipment

Table clause	Frequency range MHz	Measurement		Class A limits dB(μ V/m)
		Distance m	Detector type/ bandwidth	OATS/SAC (see Table A.1)
A2.1	30 – 230	10	Quasi Peak / 120 kHz	40
	230 – 1 000			47
A2.2	30 – 230	3		50
	230 – 1 000			57

NOTE Apply only A2.1 or A2.2 across the entire frequency range.

Table A.3 – Requirements for radiated emissions at frequencies above 1 GHz for Class A equipment

Table clause	Frequency range MHz	Measurement		Class A limits dB(μ V/m)
		Distance m	Detector type/ bandwidth	FSOATS (see Table A.1)
A3.1	1 000 – 3 000	3	Average / 1 MHz	56
	3 000 – 6 000			60
A3.2	1 000 – 3 000		Peak / 1 MHz	76
	3 000 – 6 000			80

NOTE Apply A3.1 and A3.2 across the frequency range from 1 000 MHz to the highest required frequency of measurement derived from Table 1.

**Table A.4 – Requirements for radiated emissions at frequencies up to 1 GHz for Class B equipment**

Table clause	Frequency range MHz	Measurement		Class B limits dB(μ V/m)
		Distance m	Detector type/ bandwidth	OATS/SAC (see Table A.1)
A4.1	30 – 230	10	Quasi Peak / 120 kHz	30
	230 – 1 000			37
A4.2	30 – 230	3		40
	230 – 1 000			47

NOTE Apply only table clause A4.1 or A4.2 across the entire frequency range.

Table A.5 – Requirements for radiated emissions at frequencies above 1 GHz for Class B equipment

Table clause	Frequency range MHz	Measurement		Class B limits dB(μ V/m)
		Distance m	Detector type/ bandwidth	FSOATS (see Table A.1)
A5.1	1 000 – 3 000	3	Average/ 1 MHz	50
	3 000 – 6 000			54
A5.2	1 000 – 3 000		Peak/ 1 MHz	70
	3 000 – 6 000			74

NOTE Apply A5.1 and A5.2 across the frequency range from 1 000 MHz to the highest required frequency of measurement derived from Table 1.

Table A.6 – Requirements for radiated emissions from FM receivers

Table clause	Frequency range MHz	Measurement		Class B limit dB(μ V/m)		
		Distance m	Detector type/ bandwidth	Fundamental	Harmonics	
				OATS/SAC (see Table A.1)	OATS/SAC (see Table A.1)	
A6.1	30 – 230	10	Quasi peak/ 120 kHz	50	42	
	230 – 300				42	
	300 – 1 000				46	
A6.2	30 – 230	3		Quasi peak/ 120 kHz	60	52
	230 – 300					52
	300 – 1 000					56

NOTE 1 Apply only A.6.1 or A.6.2 across the entire frequency range.

NOTE 2 These relaxed limits apply only to emissions at the fundamental and harmonic frequencies of the local oscillator. Signals at all other frequencies shall be compliant with the limits given in Table A.4.

**Table A.12 – Requirements for conducted differential voltage emissions from Class B equipment**

Applicable to						
1. TV broadcast receiver tuner ports (3.1.8) with an accessible connector						
2. RF modulator output ports (3.1.27)						
3. FM broadcast receiver tuner ports (3.1.8) with an accessible connector						
Table clause	Frequency range MHz	Detector type/ bandwidth	Class B limits dB(μ V) 75 Ω			Applicability
			Other	Local Oscillator Fundamental	Local Oscillator Harmonics	
A12.1	30 – 950	For frequencies \leq 1 GHz	46	46	46	See NOTE 1
	950 – 2 150		46	54	54	
A12.2	950 – 2 150	Quasi Peak/ 120 kHz	46	54	54	See NOTE 2
A12.3	30 – 300		For frequencies \geq 1 GHz	46	54	50
	300 – 1 000	52				
A12.4	30 – 300	Peak/ 1 MHz	46	66	59	See NOTE 4
	300 – 1 000				52	
A12.5	30 – 950		46	76	46	See NOTE 5
	950 – 2 150			n/a	54	

NOTE 1 Television receivers (analogue or digital), video recorders and PC TV broadcast receiver tuner cards working in channels between 30 MHz and 1 GHz, and digital audio receivers.

NOTE 2 Tuner units (not the LNB) for satellite signal reception.

NOTE 3 Frequency modulation audio receivers and PC tuner cards.

NOTE 4 Frequency modulation car radios.

NOTE 5 Applicable to EUTs with RF modulator output ports (for example DVD equipment, video recorders, camcorders and decoders etc.) designed to connect to TV broadcast receiver tuner ports.

NOTE 6 Testing is required at only one EUT supply voltage and frequency.

NOTE 7 The term 'other' refers to all emissions other than the fundamental and the harmonics of the local oscillator.

NOTE 8 The test shall be performed with the device operating at each reception channel.

NOTE 9 The test shall cover the entire frequency range.

5.2. Test Procedures

- a. The EUT was placed on a rotatable table top 0.8 meter above ground.
- b. The EUT was set 3/10 meters from the interference receiving antenna which was mounted on the top of a variable height antenna tower.
- c. The table was rotated 360 degrees to determine the position of the highest radiation.
- d. The antenna is a half wave dipole and its height is varied between one meter and four meters above ground to find the maximum value of the field strength both horizontal polarization and vertical polarization of the antenna are set to make the measurement. For each suspected emission the EUT was arranged to its worst case and then tune the antenna tower (from 1 M to 4 M) and turn table (from 0 degree to 360 degrees) to find the maximum reading.
- e. Set the test-receiver system to Peak Detect Function and specified bandwidth with Maximum Hold Mode.
- f. If the emission level of the EUT in peak mode was 3 dB lower than the limit specified, then testing will be stopped and peak values of EUT will be reported, otherwise, the emissions which do not have 3 dB margin will be repeated one by one using the quasi-peak method and reported.

5.3. Typical Test Setup

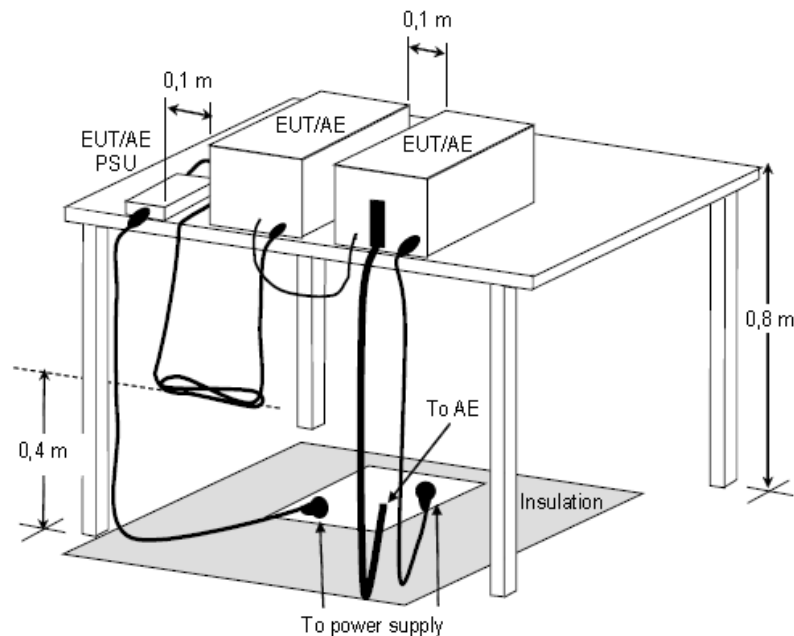

Figure D.8 – Example measurement arrangement for table-top EUT (Radiated emission measurement)



5.4. Measurement Equipment

Instrument/Ancillary	Manufacturer	Model No.	Serial No.	Calibration Date	Valid Date.
EMI Test Receiver	R&S	ESCI7	100968	2017.10.16	2018.10.15
Preamplifier	EMCI	EMCI030-00-3230	SN016723	2018.03.21	2019.03.20
Preamplifier	Agilent	8449B	3008A02342	2018.03.21	2019.03.20
Bilog Antenna	Sunol Science	JB1	A072414-2	2017.07.20	2018.07.19
Broad-Band Horn Antenna	Schwarzbeck	BBHA9120D	9120D-618	2017.04.22	2018.04.21
Spectrum Analyzer	R&S	FSP40	100324	2017.08.06	2018.08.05
Temperature/ Humidity Meter	Zhicheng	ZC1-11	CEP-TH-001	2018.03.23	2019.03.22
EZ-EMC	Fala	Ver CT3A1	N/A	N/A	N/A



5.5. Test Result and Data (30MHz ~ 1000MHz)

27V2Q:

Test Mode :	Mode 1: Full system (Display mode 1920*1080@60Hz) Signal from PC for ITU-RBT 1729 Colour bars (230V/50Hz)		
AC Power :	AC 230V/50Hz	Ant. Polarization:	Horizontal
Equipment :	LCD Monitor	Model No :	27V2Q
Temperature :	24°C	Humidity :	53%
Pressure(mbar) :	1001	Date:	2018/04/07

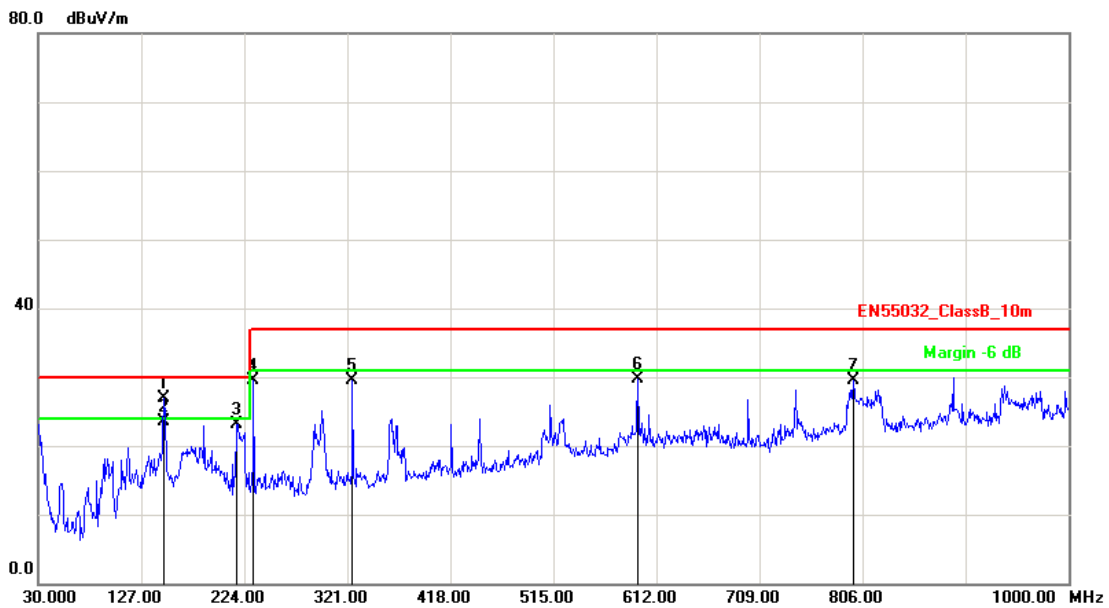

No.	Frequency (MHz)	Factor (dB/m)	Reading (dBuV)	Level (dBuV/m)	Limit (dBuV/m)	Margin (dB)	Det.	Height (cm)	Azimuth (deg)
1	148.1000	-18.60	45.42	26.82	30.00	-3.18	peak	400	111
2	148.3400	-18.60	42.16	23.56	30.00	-6.44	QP	400	187
3	217.2100	-19.65	42.77	23.12	30.00	-6.88	peak	100	165
4	232.7299	-18.92	48.51	29.59	37.00	-7.41	peak	400	22
5	325.8500	-15.96	45.50	29.54	37.00	-7.46	peak	400	301
6	594.5399	-9.01	38.76	29.75	37.00	-7.25	peak	100	222
7	797.2698	-5.97	35.51	29.54	37.00	-7.46	peak	400	198

Note: Measurement Level = Reading Level + Correct Factor



Test Mode :	Mode 1: Full system (Display mode 1920*1080@60Hz) Signal from PC for ITU-RBT 1729 Colour bars (230V/50Hz)		
AC Power :	AC 230V/50Hz	Ant. Polarization:	Vertical
Equipment :	LCD Monitor	Model No :	27V2Q
Temperature :	24°C	Humidity :	53%
Pressure(mbar) :	1001	Date:	2018/04/07

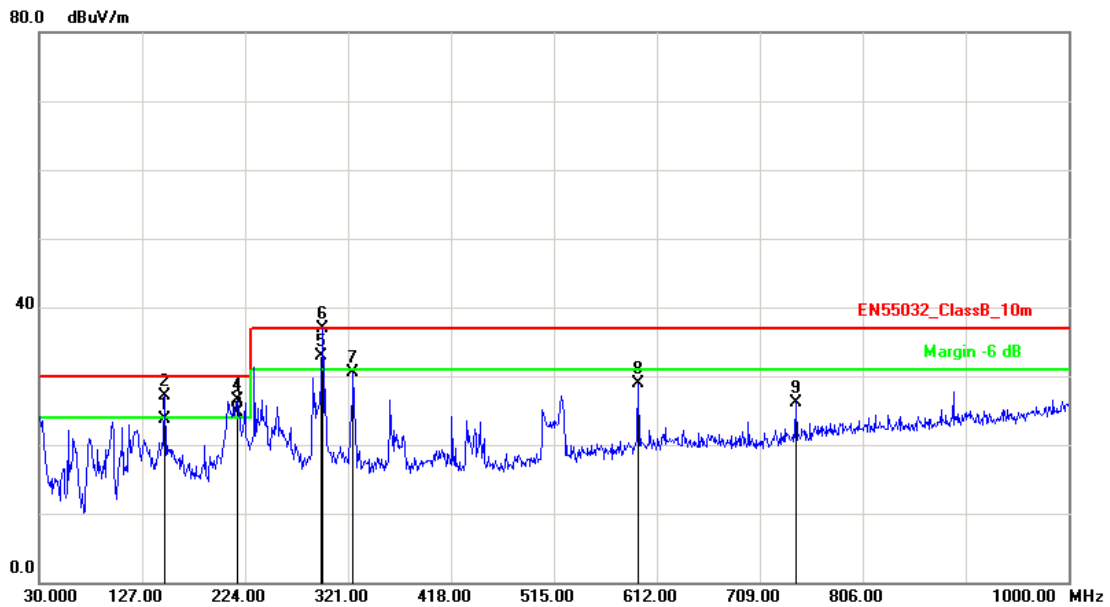

No.	Frequency (MHz)	Factor (dB/m)	Reading (dBuV)	Level (dBuV/m)	Limit (dBuV/m)	Margin (dB)	Det.	Height (cm)	Azimuth (deg)
1	148.1000	-18.60	42.26	23.66	30.00	-6.34	QP	100	156
2	148.3400	-18.60	45.77	27.17	30.00	-2.83	peak	100	154
3	217.0000	-19.63	44.39	24.76	30.00	-5.24	QP	100	90
4	217.2100	-19.65	46.11	26.46	30.00	-3.54	peak	100	55
5	296.0000	-17.07	50.01	32.94	37.00	-4.06	QP	100	166
6	296.7500	-17.03	53.97	36.94	37.00	-0.06	peak	100	165
7	325.8500	-15.96	46.46	30.50	37.00	-6.50	peak	400	360
8	594.5399	-9.01	37.83	28.82	37.00	-8.18	peak	100	22
9	742.9500	-7.17	33.19	26.02	37.00	-10.98	peak	100	187

Note: Measurement Level = Reading Level + Correct Factor



Test Mode :	Mode 8: Full system (Display mode 1920*1080@60Hz) Signal from PC for ITU-RBT 1729 Colour bars (110V/60Hz)		
AC Power :	AC 110V/60Hz	Ant. Polarization:	Horizontal
Equipment :	LCD Monitor	Model No :	27V2Q
Temperature :	24°C	Humidity :	53%
Pressure(mbar) :	1001	Date:	2018/04/07

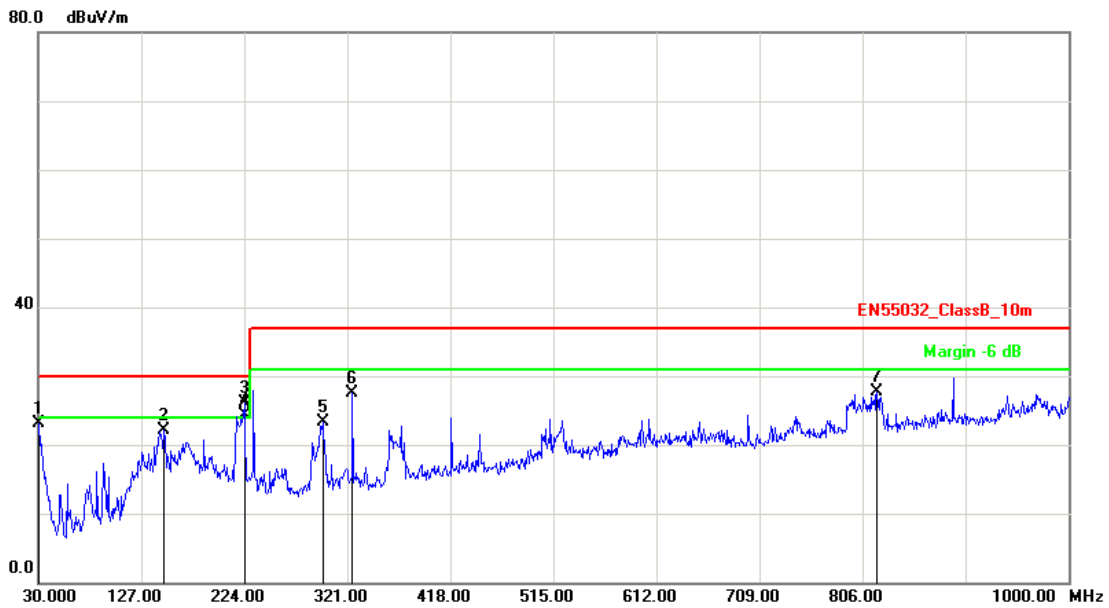

No.	Frequency (MHz)	Factor (dB/m)	Reading (dBuV)	Level (dBuV/m)	Limit (dBuV/m)	Margin (dB)	Det.	Height (cm)	Azimuth (deg)
1	30.0000	-6.26	29.39	23.13	30.00	-6.87	peak	100	22
2	148.3400	-18.60	40.66	22.06	30.00	-7.94	peak	400	154
3	224.0000	-19.61	45.78	26.17	30.00	-3.83	peak	400	236
4	224.1000	-19.61	43.98	24.37	30.00	-5.63	QP	400	266
5	297.7200	-16.97	40.20	23.23	37.00	-13.77	peak	100	112
6	325.8500	-15.96	43.47	27.51	37.00	-9.49	peak	100	302
7	819.5800	-5.68	33.31	27.63	37.00	-9.37	peak	100	154

Note: Measurement Level = Reading Level + Correct Factor



Test Mode :	Mode 8: Full system (Display mode 1920*1080@60Hz) Signal from PC for ITU-RBT 1729 Colour bars (110V/60Hz)		
AC Power :	AC 110V/60Hz	Ant. Polarization:	Vertical
Equipment :	LCD Monitor	Model No :	27V2Q
Temperature :	24°C	Humidity :	53%
Pressure(mbar) :	1001	Date:	2018/04/07

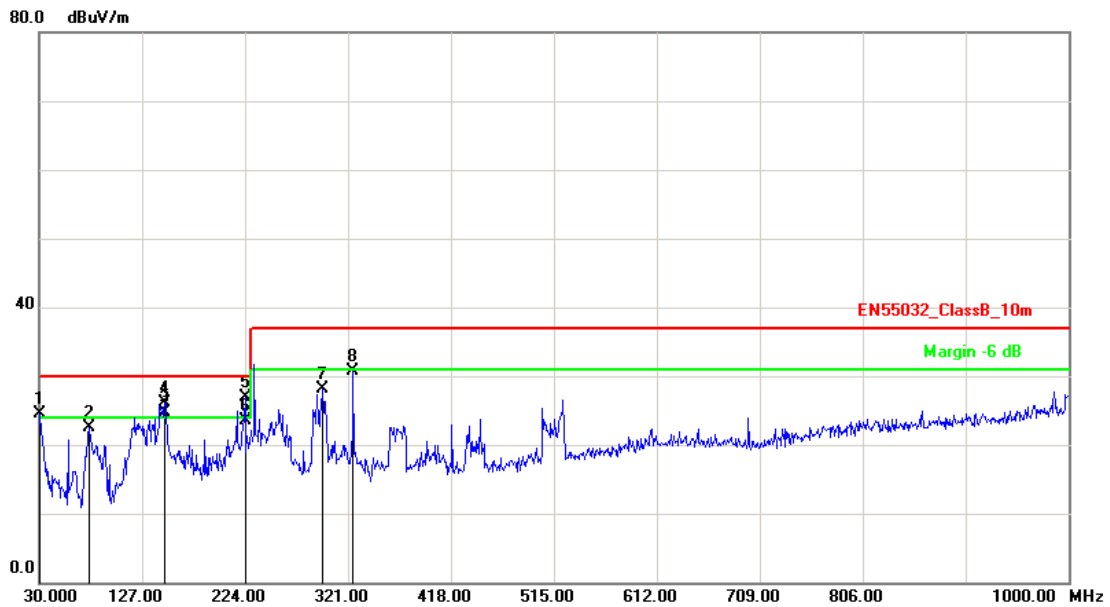

No.	Frequency (MHz)	Factor (dB/m)	Reading (dBuV)	Level (dBuV/m)	Limit (dBuV/m)	Margin (dB)	Det.	Height (cm)	Azimuth (deg)
1	30.9699	-7.45	31.97	24.52	30.00	-5.48	peak	100	114
2	76.5600	-24.06	46.48	22.42	30.00	-7.58	peak	400	154
3	148.2000	-18.60	43.26	24.66	30.00	-5.34	QP	100	120
4	148.3400	-18.60	44.71	26.11	30.00	-3.89	peak	100	125
5	224.0000	-19.61	46.47	26.86	30.00	-3.14	peak	100	22
6	224.2000	-19.60	43.15	23.55	30.00	-6.45	QP	100	36
7	296.7500	-17.03	45.10	28.07	37.00	-8.93	peak	100	22
8	325.8500	-15.96	46.67	30.71	37.00	-6.29	peak	400	360

Note: Measurement Level = Reading Level + Correct Factor



Test Mode :	Mode 10: Full system (Display mode 1920*1080@60Hz) Signal from PC for ITU-RBT 471-1 Colour bars (230V/50Hz)		
AC Power :	AC 230V/50Hz	Ant. Polarization:	Horizontal
Equipment :	LCD Monitor	Model No :	27V2Q
Temperature :	24°C	Humidity :	53%
Pressure(mbar) :	1001	Date:	2018/04/07

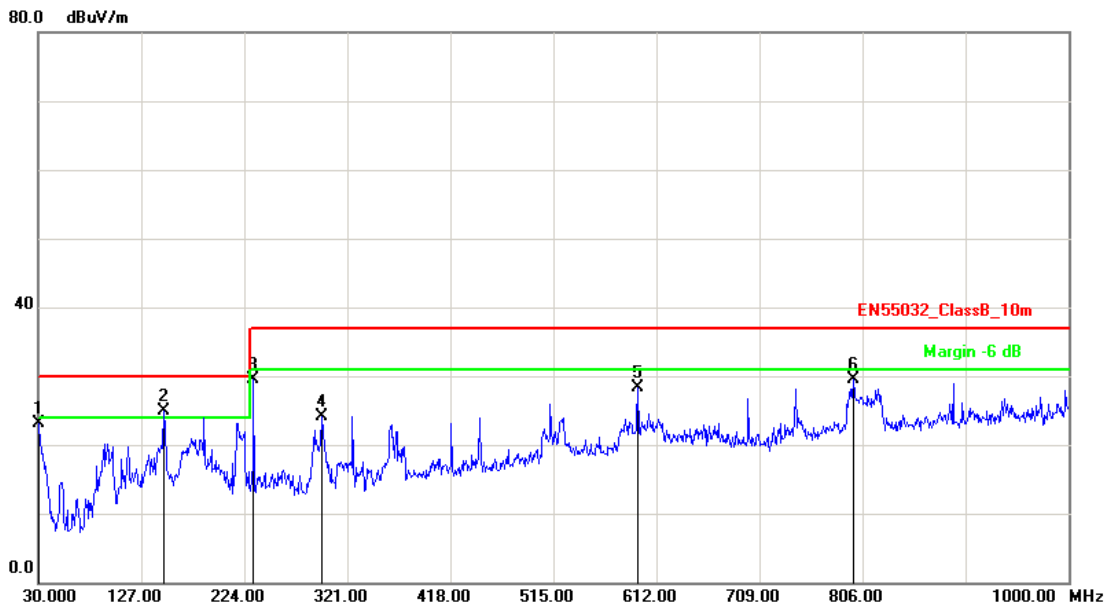

No.	Frequency (MHz)	Factor (dB/m)	Reading (dBuV)	Level (dBuV/m)	Limit (dBuV/m)	Margin (dB)	Det.	Height (cm)	Azimuth (deg)
1	30.9699	-7.45	30.48	23.03	30.00	-6.97	peak	400	222
2	148.3400	-18.60	43.42	24.82	30.00	-5.18	peak	400	8
3	232.7299	-18.92	48.51	29.59	37.00	-7.41	peak	400	187
4	296.7500	-17.03	41.11	24.08	37.00	-12.92	peak	400	11
5	594.5398	-9.01	37.26	28.25	37.00	-8.75	peak	400	230
6	797.2698	-5.97	35.51	29.54	37.00	-7.46	peak	100	130

Note: Measurement Level = Reading Level + Correct Factor



Test Mode :	Mode 10: Full system (Display mode 1920*1080@60Hz) Signal from PC for ITU-RBT 471-1 Colour bars (230V/50Hz)		
AC Power :	AC 230V/50Hz	Ant. Polarization:	Vertical
Equipment :	LCD Monitor	Model No :	27V2Q
Temperature :	24°C	Humidity :	53%
Pressure(mbar) :	1001	Date:	2018/04/07

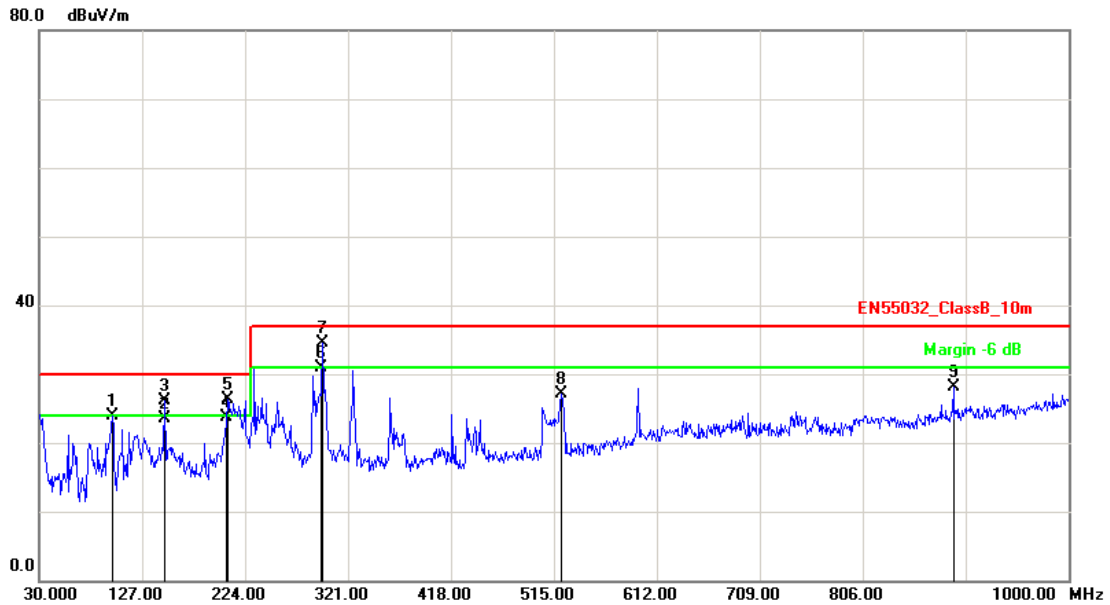

No.	Frequency (MHz)	Factor (dB/m)	Reading (dBuV)	Level (dBuV/m)	Limit (dBuV/m)	Margin (dB)	Det.	Height (cm)	Azimuth (deg)
1	98.8700	-22.08	45.90	23.82	30.00	-6.18	peak	400	111
2	148.0000	-18.60	42.19	23.59	30.00	-6.41	QP	100	222
3	148.3400	-18.60	44.77	26.17	30.00	-3.83	peak	100	215
4	207.0000	-18.62	42.34	23.72	30.00	-6.28	QP	100	356
5	207.5099	-18.67	45.06	26.39	30.00	-3.61	peak	100	360
6	296.2000	-17.06	48.05	30.99	37.00	-6.01	QP	100	199
7	296.7500	-17.03	51.47	34.44	37.00	-2.56	peak	100	187
8	521.7898	-10.58	37.72	27.14	37.00	-9.86	peak	100	14
9	891.3600	-4.68	32.79	28.11	37.00	-8.89	peak	400	256

Note: Measurement Level = Reading Level + Correct Factor



Test Mode :	Mode 11: Full system (Display mode 1920*1080@60Hz) Signal from PC for ITU-RBT 471-1 Colour bars (110V/60Hz)		
AC Power :	AC 110V/60Hz	Ant. Polarization:	Horizontal
Equipment :	LCD Monitor	Model No :	27V2Q
Temperature :	24°C	Humidity :	53%
Pressure(mbar) :	1001	Date:	2018/04/07

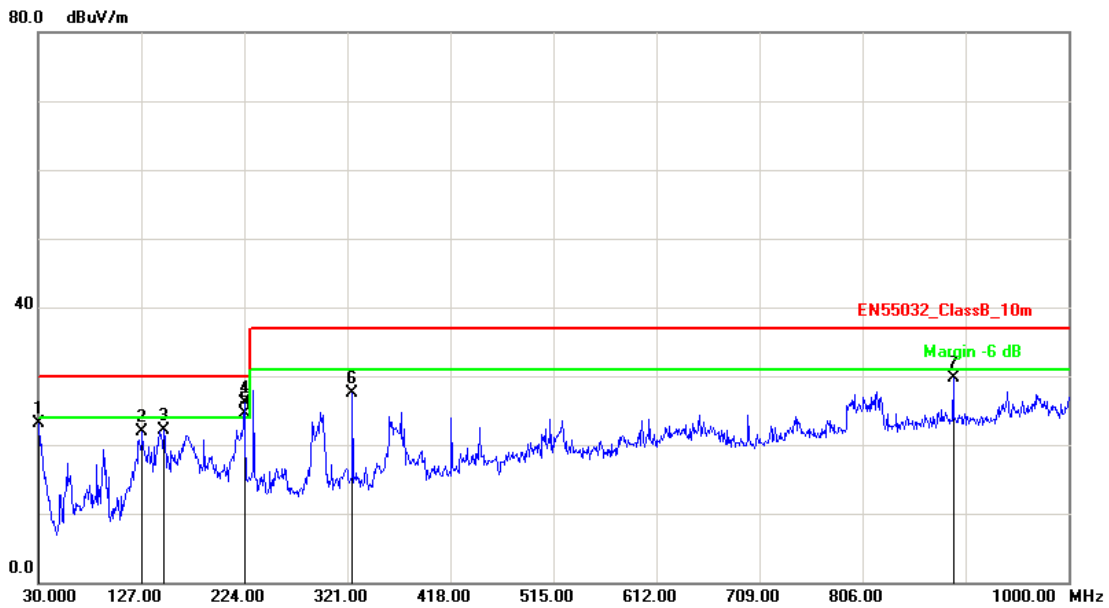

No.	Frequency (MHz)	Factor (dB/m)	Reading (dBuV)	Level (dBuV/m)	Limit (dBuV/m)	Margin (dB)	Det.	Height (cm)	Azimuth (deg)
1	30.0000	-6.26	29.39	23.13	30.00	-6.87	peak	400	22
2	127.9699	-17.90	39.80	21.90	30.00	-8.10	peak	100	360
3	148.3400	-18.60	40.66	22.06	30.00	-7.94	peak	400	55
4	224.0000	-19.61	45.78	26.17	30.00	-3.83	peak	400	187
5	224.1000	-19.61	44.16	24.55	30.00	-5.45	QP	400	188
6	325.8500	-15.96	43.47	27.51	37.00	-9.49	peak	400	189
7	891.3600	-4.68	34.35	29.67	37.00	-7.33	peak	100	5

Note: Measurement Level = Reading Level + Correct Factor



Test Mode :	Mode 11: Full system (Display mode 1920*1080@60Hz) Signal from PC for ITU-RBT 471-1 Colour bars (110V/60Hz)		
AC Power :	AC 110V/60Hz	Ant. Polarization:	Vertical
Equipment :	LCD Monitor	Model No :	27V2Q
Temperature :	24°C	Humidity :	53%
Pressure(mbar) :	1001	Date:	2018/04/07

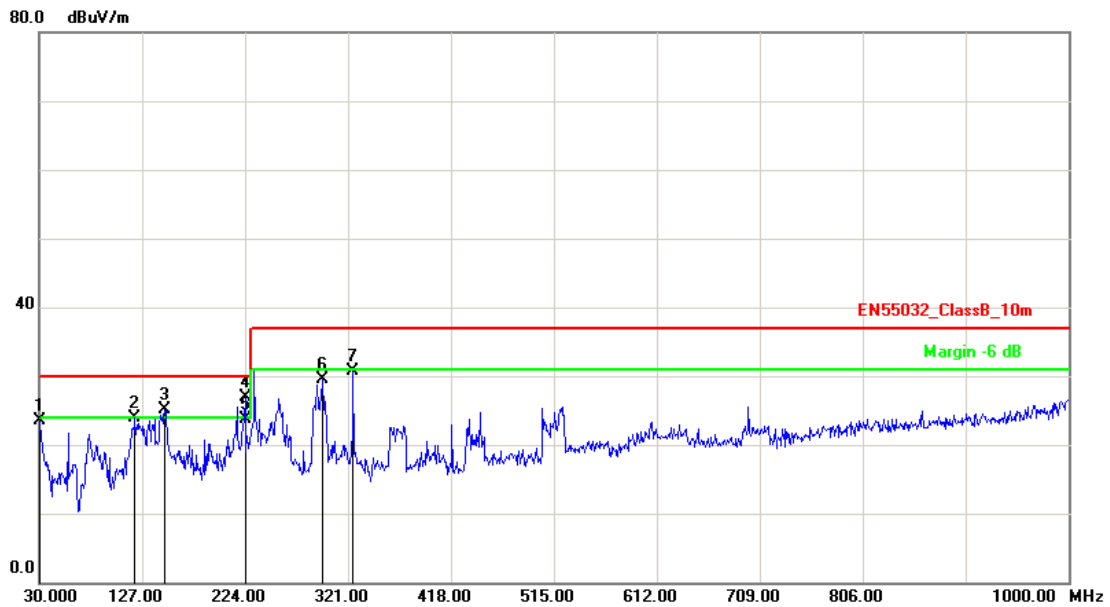

No.	Frequency (MHz)	Factor (dB/m)	Reading (dBuV)	Level (dBuV/m)	Limit (dBuV/m)	Margin (dB)	Det.	Height (cm)	Azimuth (deg)
1	30.9699	-7.45	30.97	23.52	30.00	-6.48	peak	100	166
2	120.2099	-17.56	41.44	23.88	30.00	-6.12	peak	100	99
3	148.3400	-18.60	43.71	25.11	30.00	-4.89	peak	100	111
4	224.0000	-19.61	46.47	26.86	30.00	-3.14	peak	400	198
5	224.0000	-19.61	43.26	23.65	30.00	-6.35	QP	400	200
6	296.7500	-17.03	46.60	29.57	37.00	-7.43	peak	100	77
7	325.8500	-15.96	46.67	30.71	37.00	-6.29	peak	100	187

Note: Measurement Level = Reading Level + Correct Factor



27V2H:

Test Mode :	Mode 1: Full system (VGA mode 1920*1080@60Hz) Signal from PC for ITU-RBT 1729 Colour bars (230V/50Hz)		
AC Power :	AC 230V/50Hz	Ant. Polarization:	Horizontal
Equipment :	LCD Monitor	Model No :	27V2H
Temperature :	24°C	Humidity :	53%
Pressure(mbar) :	1001	Date:	2018/04/07

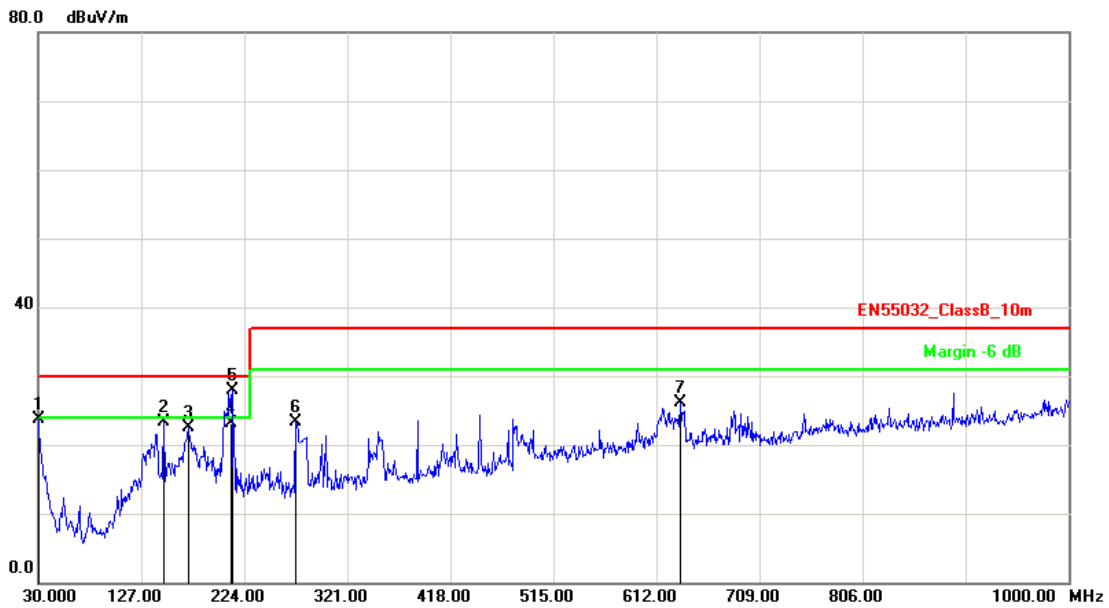

No.	Frequency (MHz)	Factor (dB/m)	Reading (dBuV)	Level (dBuV/m)	Limit (dBuV/m)	Margin (dB)	Det.	Height (cm)	Azimuth (deg)
1	30.0000	-6.26	29.89	23.63	30.00	-6.37	peak	400	125
2	148.3400	-18.60	41.89	23.29	30.00	-6.71	peak	100	333
3	171.6200	-19.22	41.78	22.56	30.00	-7.44	peak	100	301
4	212.3000	-19.16	42.36	23.20	30.00	-6.80	QP	400	23
5	212.3600	-19.16	47.08	27.92	30.00	-2.08	peak	400	22
6	272.5000	-18.34	41.63	23.29	37.00	-13.71	peak	400	2
7	634.3099	-8.11	34.16	26.05	37.00	-10.95	peak	400	98

Note: Measurement Level = Reading Level + Correct Factor



Test Mode :	Mode 1: Full system (VGA mode 1920*1080@60Hz) Signal from PC for ITU-RBT 1729 Colour bars (230V/50Hz)		
AC Power :	AC 230V/50Hz	Ant. Polarization:	Vertical
Equipment :	LCD Monitor	Model No :	27V2H
Temperature :	24°C	Humidity :	53%
Pressure(mbar) :	1001	Date:	2018/04/07

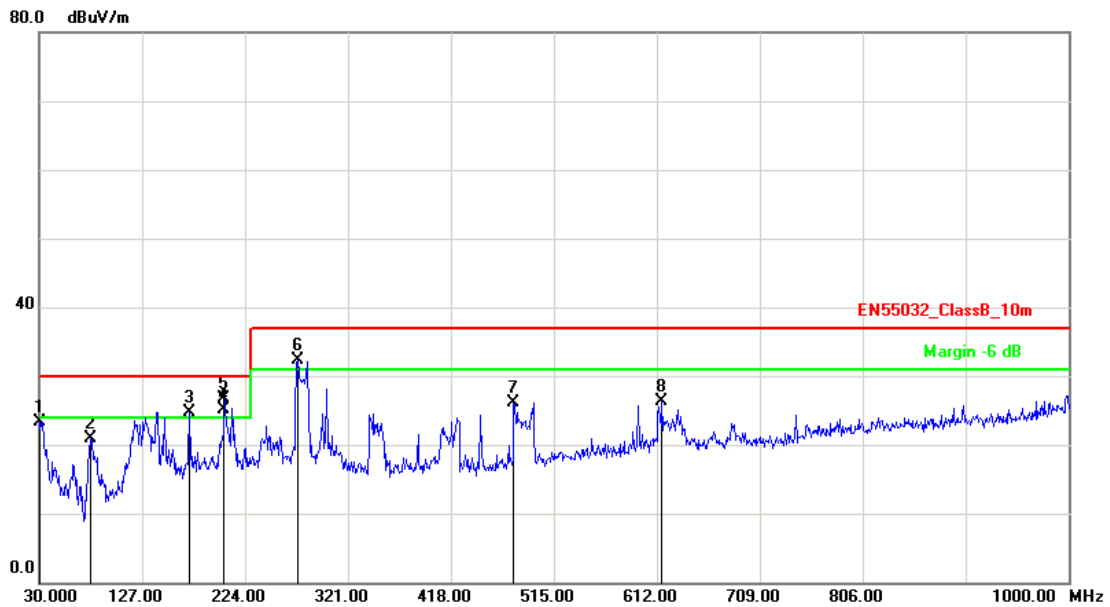

No.	Frequency (MHz)	Factor (dB/m)	Reading (dBuV)	Level (dBuV/m)	Limit (dBuV/m)	Margin (dB)	Det.	Height (cm)	Azimuth (deg)
1	30.0000	-6.26	29.58	23.32	30.00	-6.68	peak	100	144
2	78.5000	-24.16	45.12	20.96	30.00	-9.04	peak	100	145
3	171.6200	-19.22	43.96	24.74	30.00	-5.26	peak	100	201
4	204.3000	-18.35	43.54	25.19	30.00	-4.81	QP	100	100
5	204.5999	-18.38	45.05	26.67	30.00	-3.33	peak	100	112
6	273.4700	-18.30	50.62	32.32	37.00	-4.68	peak	400	301
7	477.1700	-11.76	37.96	26.20	37.00	-10.80	peak	100	360
8	616.8500	-8.22	34.61	26.39	37.00	-10.61	peak	100	112

Note: Measurement Level = Reading Level + Correct Factor



Test Mode :	Mode 8: Full system (VGA mode 1920*1080@60Hz) Signal from PC for ITU-RBT 1729 Colour bars (110V/60Hz)		
AC Power :	AC 110V/60Hz	Ant. Polarization:	Horizontal
Equipment :	LCD Monitor	Model No :	27V2H
Temperature :	24°C	Humidity :	53%
Pressure(mbar) :	1001	Date:	2018/04/07

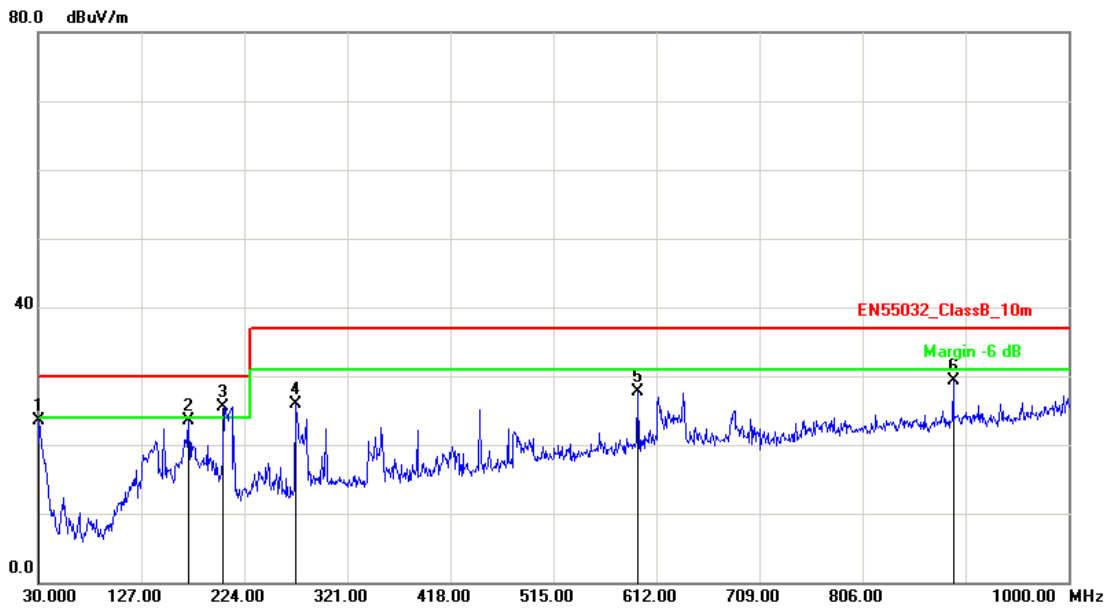

No.	Frequency (MHz)	Factor (dB/m)	Reading (dBuV)	Level (dBuV/m)	Limit (dBuV/m)	Margin (dB)	Det.	Height (cm)	Azimuth (deg)
1	30.9699	-7.45	30.88	23.43	30.00	-6.57	peak	400	187
2	171.6200	-19.22	42.65	23.43	30.00	-6.57	peak	100	16
3	204.5999	-18.38	43.94	25.56	30.00	-4.44	peak	400	125
4	272.5000	-18.34	44.25	25.91	37.00	-11.09	peak	400	55
5	594.5399	-9.01	36.79	27.78	37.00	-9.22	peak	100	333
6	891.3600	-4.68	33.93	29.25	37.00	-7.75	peak	400	306

Note: Measurement Level = Reading Level + Correct Factor



Test Mode :	Mode 8: Full system (VGA mode 1920*1080@60Hz) Signal from PC for ITU-RBT 1729 Colour bars (110V/60Hz)		
AC Power :	AC 110V/60Hz	Ant. Polarization:	Vertical
Equipment :	LCD Monitor	Model No :	27V2H
Temperature :	24°C	Humidity :	53%
Pressure(mbar) :	1001	Date:	2018/04/07

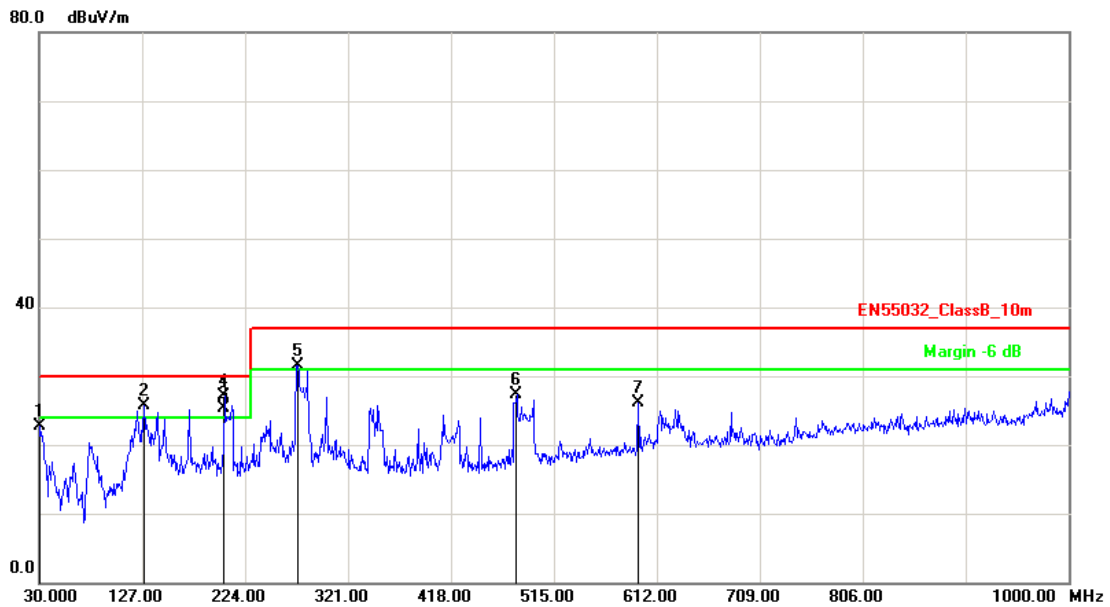

No.	Frequency (MHz)	Factor (dB/m)	Reading (dBuV)	Level (dBuV/m)	Limit (dBuV/m)	Margin (dB)	Det.	Height (cm)	Azimuth (deg)
1	30.9699	-7.45	30.07	22.62	30.00	-7.38	peak	400	333
2	128.9399	-17.94	43.63	25.69	30.00	-4.31	peak	100	125
3	204.3000	-18.35	43.69	25.34	30.00	-4.66	QP	100	306
4	204.5999	-18.38	45.47	27.09	30.00	-2.91	peak	100	122
5	273.4700	-18.30	49.81	31.51	37.00	-5.49	peak	100	301
6	480.0799	-11.66	39.05	27.39	37.00	-9.61	peak	100	198
7	594.5399	-9.01	35.11	26.10	37.00	-10.90	peak	400	145

Note: Measurement Level = Reading Level + Correct Factor



Test Mode :	Mode 10: Full system (VGA mode 1920*1080@60Hz) Signal from PC for ITU-RBT 471-1 Colour bars (230V/50Hz)		
AC Power :	AC 230V/50Hz	Ant. Polarization:	Horizontal
Equipment :	LCD Monitor	Model No :	27V2H
Temperature :	24°C	Humidity :	53%
Pressure(mbar) :	1001	Date:	2018/04/07

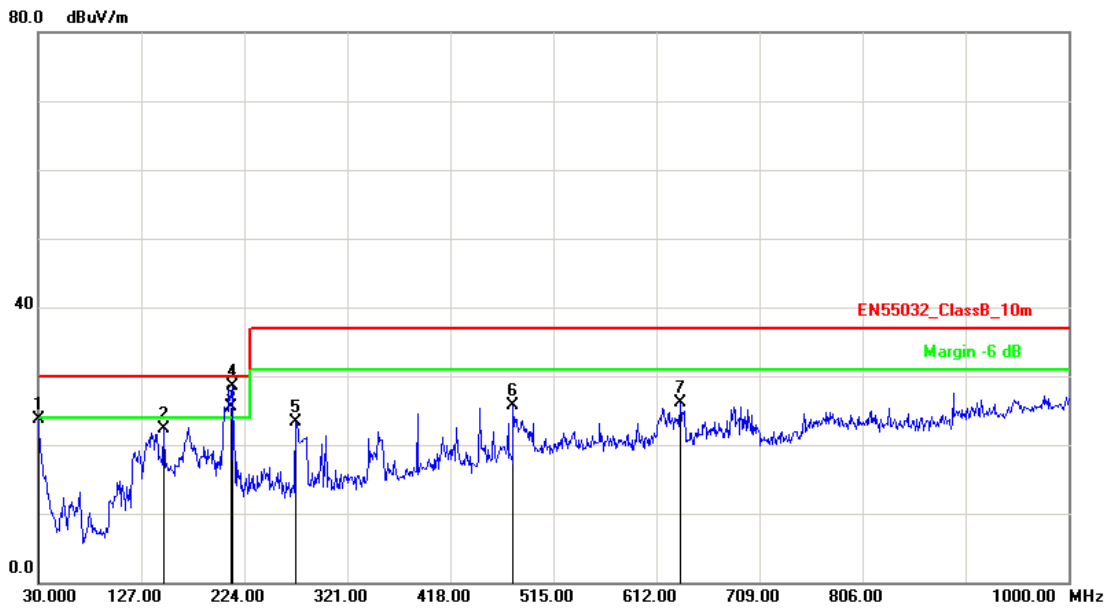

No.	Frequency (MHz)	Factor (dB/m)	Reading (dBuV)	Level (dBuV/m)	Limit (dBuV/m)	Margin (dB)	Det.	Height (cm)	Azimuth (deg)
1	30.0000	-6.26	29.89	23.63	30.00	-6.37	peak	100	301
2	148.3400	-18.60	40.89	22.29	30.00	-7.71	peak	100	22
3	212.3000	-19.16	44.65	25.49	30.00	-4.51	QP	400	120
4	212.3600	-19.16	47.58	28.42	30.00	-1.58	peak	400	125
5	272.5000	-18.34	41.63	23.29	37.00	-13.71	peak	400	171
6	477.1700	-11.76	37.37	25.61	37.00	-11.39	peak	400	298
7	634.3099	-8.11	34.16	26.05	37.00	-10.95	peak	400	222

Note: Measurement Level = Reading Level + Correct Factor



Test Mode :	Mode 10: Full system (VGA mode 1920*1080@60Hz) Signal from PC for ITU-RBT 471-1 Colour bars (230V/50Hz)		
AC Power :	AC 230V/50Hz	Ant. Polarization:	Vertical
Equipment :	LCD Monitor	Model No :	27V2H
Temperature :	24°C	Humidity :	53%
Pressure(mbar) :	1001	Date:	2018/04/07

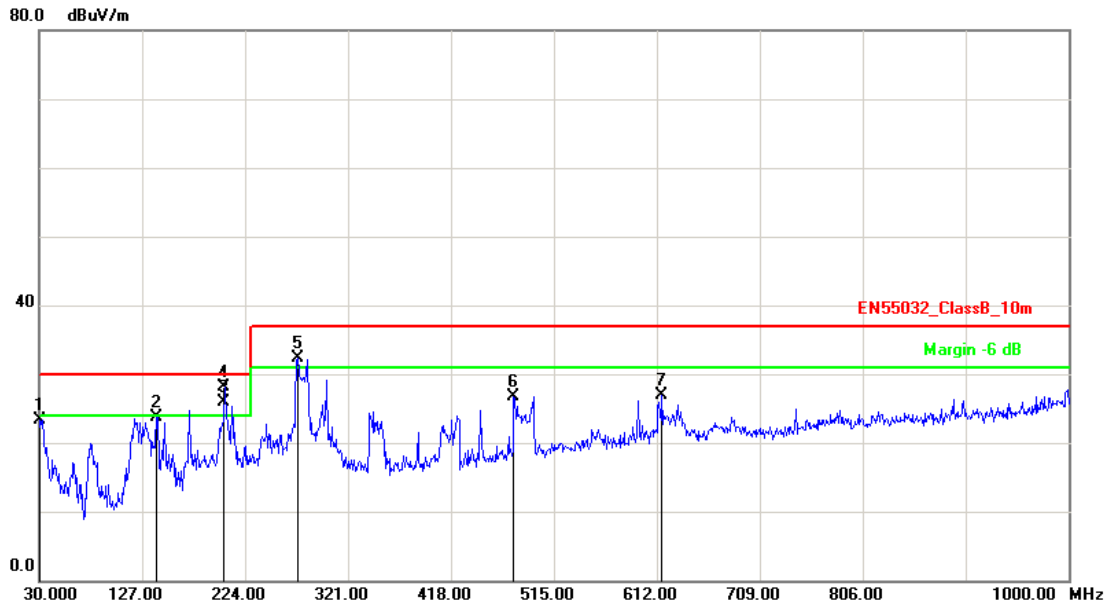

No.	Frequency (MHz)	Factor (dB/m)	Reading (dBuV)	Level (dBuV/m)	Limit (dBuV/m)	Margin (dB)	Det.	Height (cm)	Azimuth (deg)
1	30.0000	-6.26	29.58	23.32	30.00	-6.68	peak	100	66
2	140.5800	-18.43	42.14	23.71	30.00	-6.29	peak	100	165
3	204.3600	-18.36	44.26	25.90	30.00	-4.10	QP	100	190
4	204.5999	-18.38	46.55	28.17	30.00	-1.83	peak	100	185
5	273.4700	-18.30	50.62	32.32	37.00	-4.68	peak	400	22
6	477.1700	-11.76	38.46	26.70	37.00	-10.30	peak	100	11
7	616.8500	-8.22	35.11	26.89	37.00	-10.11	peak	100	169

Note: Measurement Level = Reading Level + Correct Factor



Test Mode :	Mode 11: Full system (VGA mode 1920*1080@60Hz) Signal from PC for ITU-RBT 471-1 Colour bars (110V/60Hz)		
AC Power :	AC 110V/60Hz	Ant. Polarization:	Horizontal
Equipment :	LCD Monitor	Model No :	27V2H
Temperature :	24°C	Humidity :	53%
Pressure(mbar) :	1001	Date:	2018/04/07

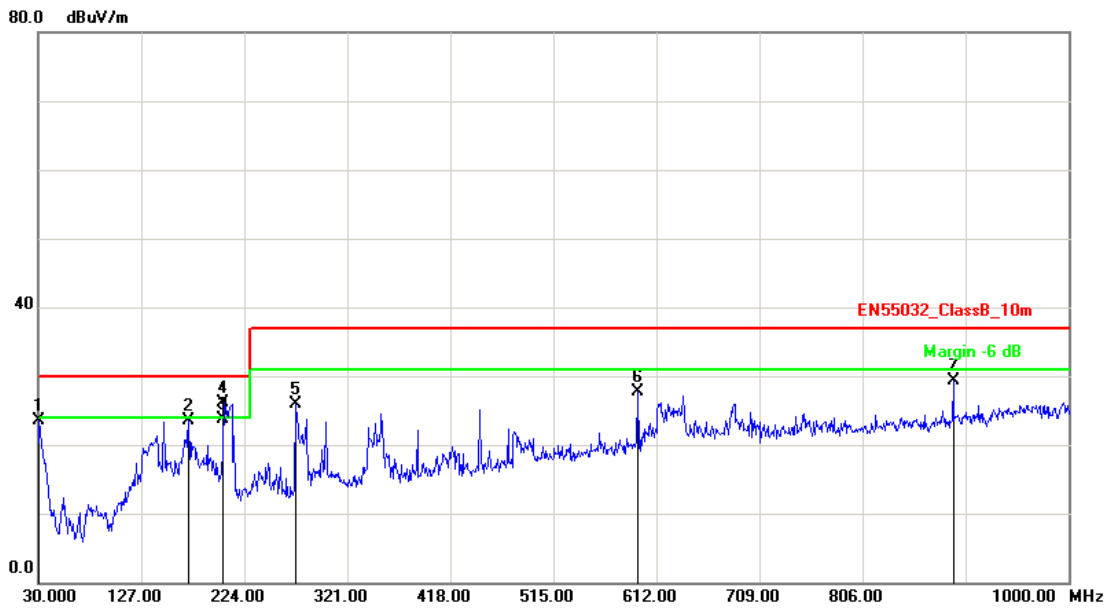

No.	Frequency (MHz)	Factor (dB/m)	Reading (dBuV)	Level (dBuV/m)	Limit (dBuV/m)	Margin (dB)	Det.	Height (cm)	Azimuth (deg)
1	30.9699	-7.45	30.88	23.43	30.00	-6.57	peak	400	360
2	171.6200	-19.22	42.65	23.43	30.00	-6.57	peak	100	26
3	204.3000	-18.35	42.10	23.75	30.00	-6.25	QP	400	122
4	204.5999	-18.38	44.44	26.06	30.00	-3.94	peak	400	125
5	272.5000	-18.34	44.25	25.91	37.00	-11.09	peak	400	198
6	594.5399	-9.01	36.79	27.78	37.00	-9.22	peak	400	22
7	891.3600	-4.68	33.93	29.25	37.00	-7.75	peak	400	177

Note: Measurement Level = Reading Level + Correct Factor



Test Mode :	Mode 11: Full system (VGA mode 1920*1080@60Hz) Signal from PC for ITU-RBT 471-1 Colour bars (110V/60Hz)		
AC Power :	AC 110V/60Hz	Ant. Polarization:	Vertical
Equipment :	LCD Monitor	Model No :	27V2H
Temperature :	24°C	Humidity :	53%
Pressure(mbar) :	1001	Date:	2018/04/07

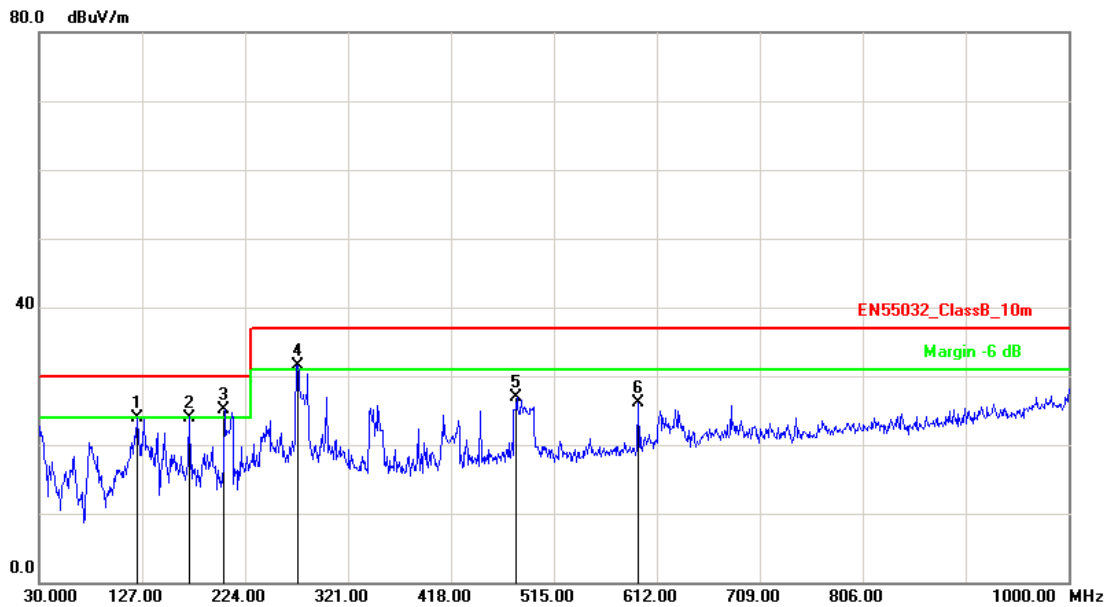

No.	Frequency (MHz)	Factor (dB/m)	Reading (dBuV)	Level (dBuV/m)	Limit (dBuV/m)	Margin (dB)	Det.	Height (cm)	Azimuth (deg)
1	122.1500	-17.64	41.45	23.81	30.00	-6.19	peak	100	360
2	171.6200	-19.22	43.22	24.00	30.00	-6.00	peak	100	333
3	204.5999	-18.38	43.47	25.09	30.00	-4.91	peak	100	22
4	273.4700	-18.30	49.81	31.51	37.00	-5.49	peak	100	360
5	480.0799	-11.66	38.55	26.89	37.00	-10.11	peak	400	189
6	594.5399	-9.01	35.11	26.10	37.00	-10.90	peak	100	99

Note: Measurement Level = Reading Level + Correct Factor



5.6. Test Result and Data (1000MHz ~ 6000MHz)

27V2Q:

Test Mode :	Mode 1: Full system (Display mode 1920*1080@60Hz) Signal from PC for ITU-RBT 1729 Colour bars (230V/50Hz)		
AC Power :	AC 230V/50Hz	Ant. Polarization:	Horizontal
Equipment :	LCD Monitor	Model No :	27V2Q
Temperature :	24°C	Humidity :	53%
Pressure(mbar) :	1001	Date:	2018/04/07

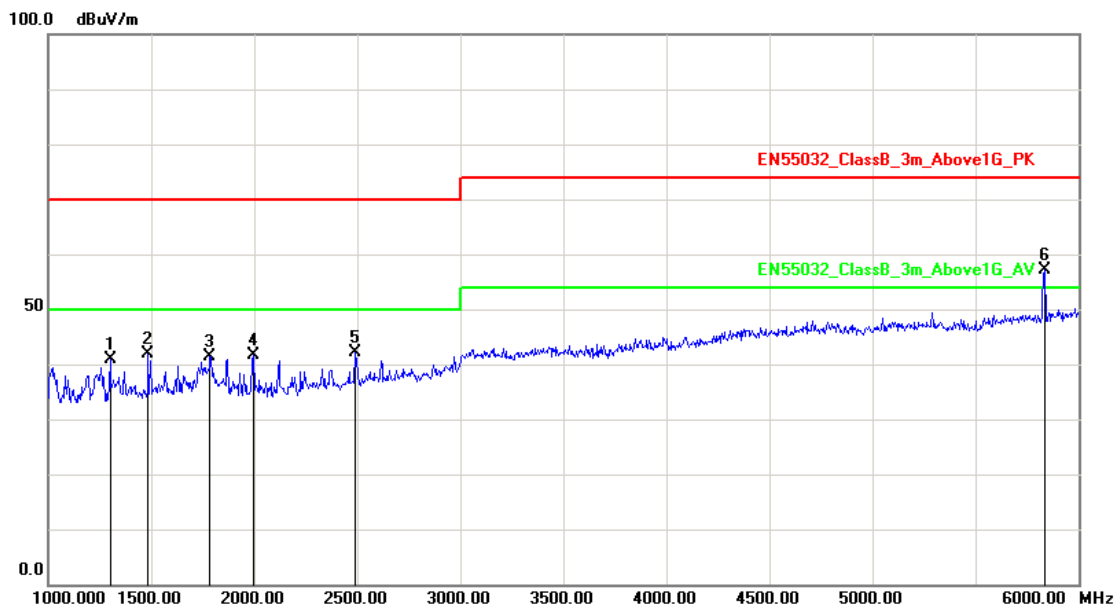

No.	Frequency (MHz)	Factor (dB/m)	Reading (dBuV)	Level (dBuV/m)	Limit (dBuV/m)	Margin (dB)	Det.	Height (cm)	Azimuth (deg)
1	1300.000	-3.97	44.97	41.00	70.00	-29.00	peak	100	351
2	1485.000	-2.90	44.84	41.94	70.00	-28.06	peak	200	50
3	1785.000	-1.82	43.25	41.43	70.00	-28.57	peak	100	306
4	1995.000	-1.21	42.95	41.74	70.00	-28.26	peak	100	321
5	2490.000	1.30	40.90	42.20	70.00	-27.80	peak	100	334
6	5835.000	13.55	43.49	57.04	74.00	-16.96	peak	189	360

Note: Measurement Level = Reading Level + Correct Factor



Test Mode :	Mode 1: Full system (Display mode 1920*1080@60Hz) Signal from PC for ITU-RBT 1729 Colour bars (230V/50Hz)		
AC Power :	AC 230V/50Hz	Ant. Polarization:	Vertical
Equipment :	LCD Monitor	Model No :	27V2Q
Temperature :	24°C	Humidity :	53%
Pressure(mbar) :	1001	Date:	2018/04/07

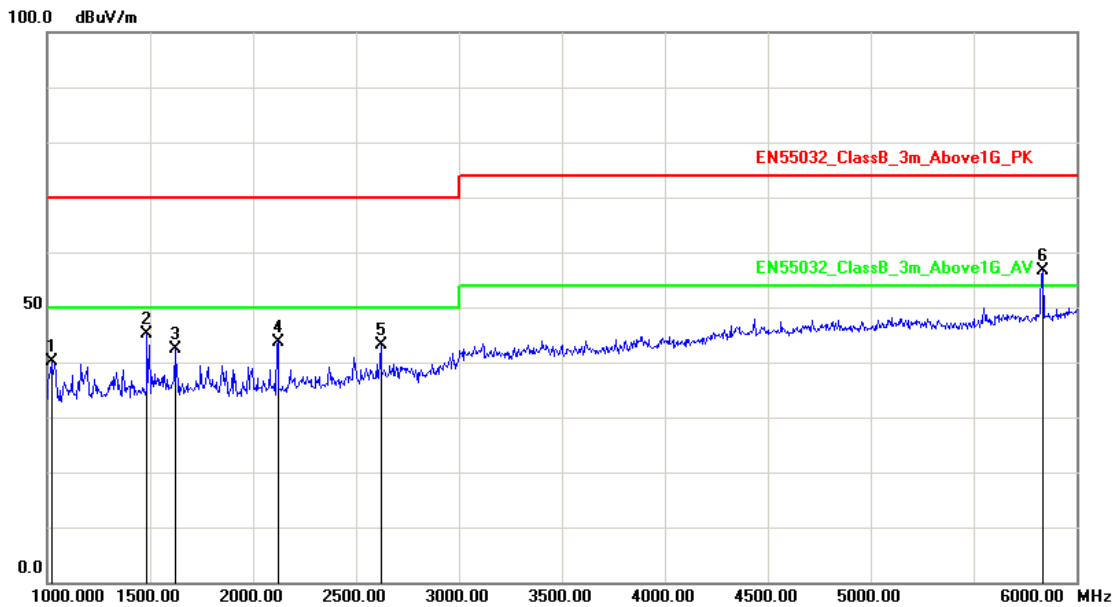

No.	Frequency (MHz)	Factor (dB/m)	Reading (dBuV)	Level (dBuV/m)	Limit (dBuV/m)	Margin (dB)	Det.	Height (cm)	Azimuth (deg)
1	1020.000	-5.85	46.09	40.24	70.00	-29.76	peak	100	320
2	1485.000	-2.90	47.91	45.01	70.00	-24.99	peak	100	4
3	1620.000	-2.29	44.73	42.44	70.00	-27.56	peak	100	215
4	2120.000	-0.59	44.14	43.55	70.00	-26.45	peak	100	1
5	2620.000	2.01	41.01	43.02	70.00	-26.98	peak	100	36
6	5835.000	13.55	43.19	56.74	74.00	-17.26	peak	200	168

Note: Measurement Level = Reading Level + Correct Factor



Test Mode :	Mode 8: Full system (Display mode 1920*1080@60Hz) Signal from PC for ITU-RBT 1729 Colour bars (110V/60Hz)		
AC Power :	AC 110V/60Hz	Ant. Polarization:	Horizontal
Equipment :	LCD Monitor	Model No :	27V2Q
Temperature :	24°C	Humidity :	53%
Pressure(mbar) :	1001	Date:	2018/04/07

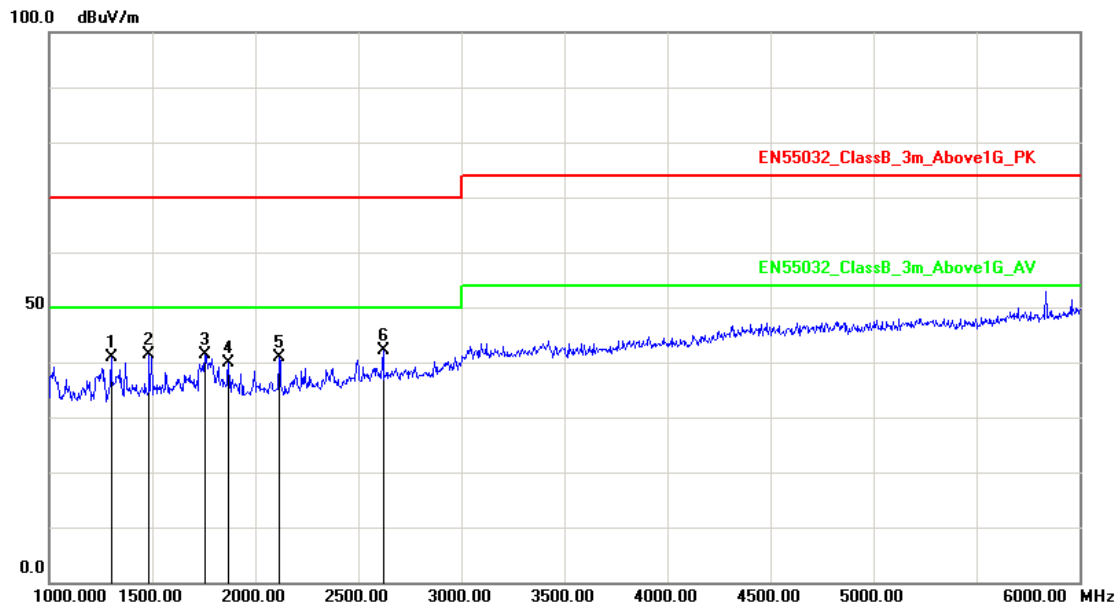

No.	Frequency (MHz)	Factor (dB/m)	Reading (dBuV)	Level (dBuV/m)	Limit (dBuV/m)	Margin (dB)	Det.	Height (cm)	Azimuth (deg)
1	1300.000	-3.97	44.88	40.91	70.00	-29.09	peak	100	353
2	1485.000	-2.90	44.32	41.42	70.00	-28.58	peak	200	320
3	1755.000	-1.91	43.25	41.34	70.00	-28.66	peak	100	305
4	1870.000	-1.58	41.56	39.98	70.00	-30.02	peak	100	265
5	2115.000	-0.61	41.55	40.94	70.00	-29.06	peak	177	360
6	2620.000	2.01	40.07	42.08	70.00	-27.92	peak	100	183

Note: Measurement Level = Reading Level + Correct Factor



Test Mode :	Mode 8: Full system (Display mode 1920*1080@60Hz) Signal from PC for ITU-RBT 1729 Colour bars (110V/60Hz)		
AC Power :	AC 110V/60Hz	Ant. Polarization:	Vertical
Equipment :	LCD Monitor	Model No :	27V2Q
Temperature :	24°C	Humidity :	53%
Pressure(mbar) :	1001	Date:	2018/04/07

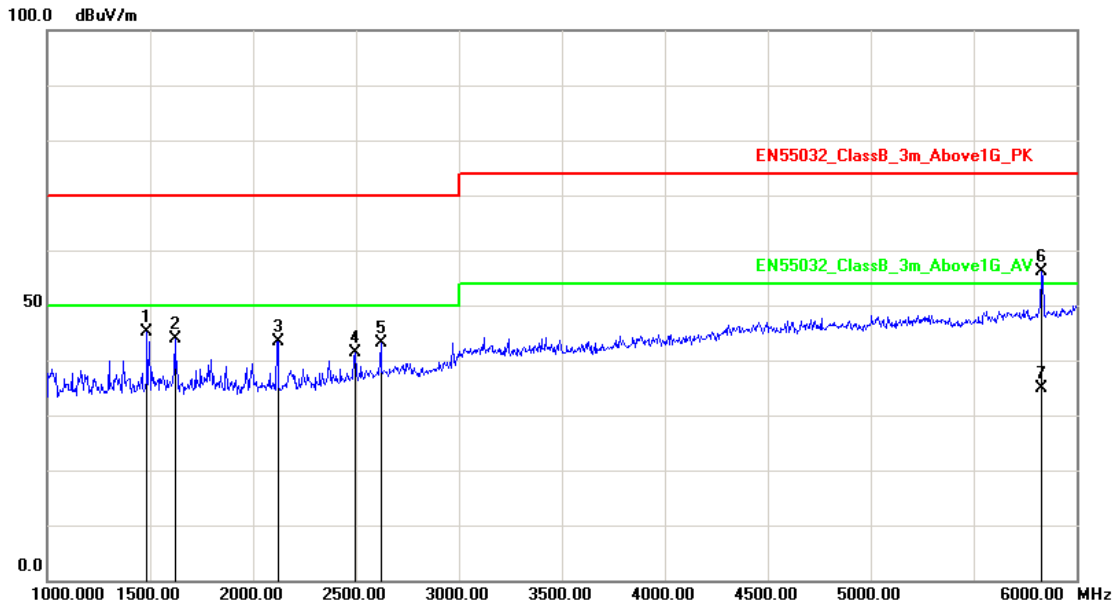

No.	Frequency (MHz)	Factor (dB/m)	Reading (dBuV)	Level (dBuV/m)	Limit (dBuV/m)	Margin (dB)	Det.	Height (cm)	Azimuth (deg)
1	1485.000	-2.90	48.11	45.21	70.00	-24.79	peak	136	360
2	1620.000	-2.29	46.23	43.94	70.00	-26.06	peak	106	360
3	2120.000	-0.59	43.98	43.39	70.00	-26.61	peak	100	58
4	2495.000	1.32	40.06	41.38	70.00	-28.62	peak	200	360
5	2620.000	2.01	41.02	43.03	70.00	-26.97	peak	100	58
6	5830.000	13.53	42.58	56.11	74.00	-17.89	peak	100	360
7	5832.000	13.53	21.39	34.92	54.00	-19.08	AVG	100	355

Note: Measurement Level = Reading Level + Correct Factor



Test Mode :	Mode 10: Full system (Display mode 1920*1080@60Hz) Signal from PC for ITU-RBT 471-1 Colour bars (230V/50Hz)		
AC Power :	AC 230V/50Hz	Ant. Polarization:	Horizontal
Equipment :	LCD Monitor	Model No :	27V2Q
Temperature :	24°C	Humidity :	53%
Pressure(mbar) :	1001	Date:	2018/04/07

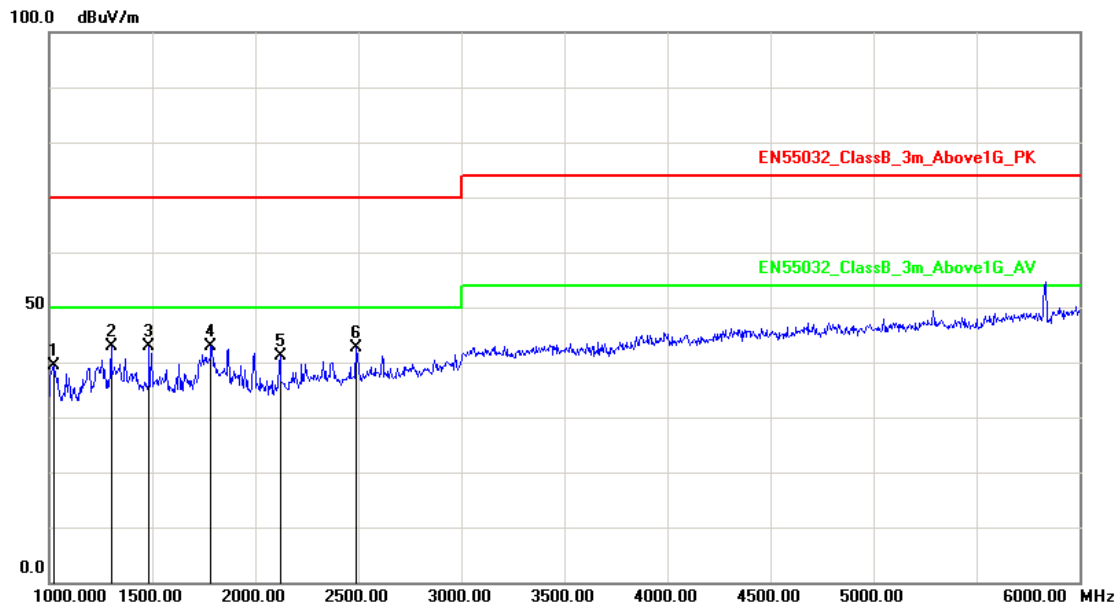

No.	Frequency (MHz)	Factor (dB/m)	Reading (dBuV)	Level (dBuV/m)	Limit (dBuV/m)	Margin (dB)	Det.	Height (cm)	Azimuth (deg)
1	1020.000	-5.85	45.17	39.32	70.00	-30.68	peak	200	360
2	1300.000	-3.97	46.97	43.00	70.00	-27.00	peak	100	22
3	1485.000	-2.90	45.84	42.94	70.00	-27.06	peak	200	115
4	1785.000	-1.82	44.75	42.93	70.00	-27.07	peak	200	198
5	2120.000	-0.59	41.81	41.22	70.00	-28.78	peak	100	55
6	2490.000	1.30	41.40	42.70	70.00	-27.30	peak	200	300

Note: Measurement Level = Reading Level + Correct Factor



Test Mode :	Mode 10: Full system (Display mode 1920*1080@60Hz) Signal from PC for ITU-RBT 471-1 Colour bars (230V/50Hz)		
AC Power :	AC 230V/50Hz	Ant. Polarization:	Vertical
Equipment :	LCD Monitor	Model No :	27V2Q
Temperature :	24°C	Humidity :	53%
Pressure(mbar) :	1001	Date:	2018/04/07

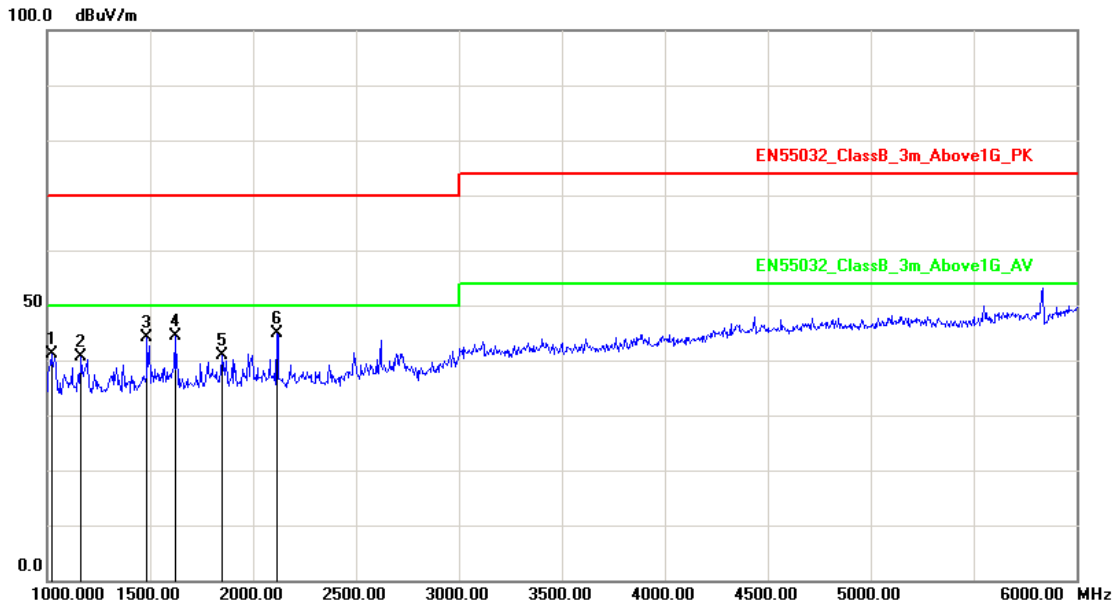

No.	Frequency (MHz)	Factor (dB/m)	Reading (dBuV)	Level (dBuV/m)	Limit (dBuV/m)	Margin (dB)	Det.	Height (cm)	Azimuth (deg)
1	1020.000	-5.85	47.09	41.24	70.00	-28.76	peak	100	77
2	1165.000	-4.87	45.38	40.51	70.00	-29.49	peak	100	45
3	1485.000	-2.90	46.91	44.01	70.00	-25.99	peak	200	265
4	1620.000	-2.29	46.73	44.44	70.00	-25.56	peak	100	360
5	1850.000	-1.63	42.49	40.86	70.00	-29.14	peak	200	221
6	2115.000	-0.61	45.37	44.76	70.00	-25.24	peak	100	206

Note: Measurement Level = Reading Level + Correct Factor



Test Mode :	Mode 11: Full system (Display mode 1920*1080@60Hz) Signal from PC for ITU-RBT 471-1 Colour bars (110V/60Hz)		
AC Power :	AC 110V/60Hz	Ant. Polarization:	Horizontal
Equipment :	LCD Monitor	Model No :	27V2Q
Temperature :	24°C	Humidity :	53%
Pressure(mbar) :	1001	Date:	2018/04/07

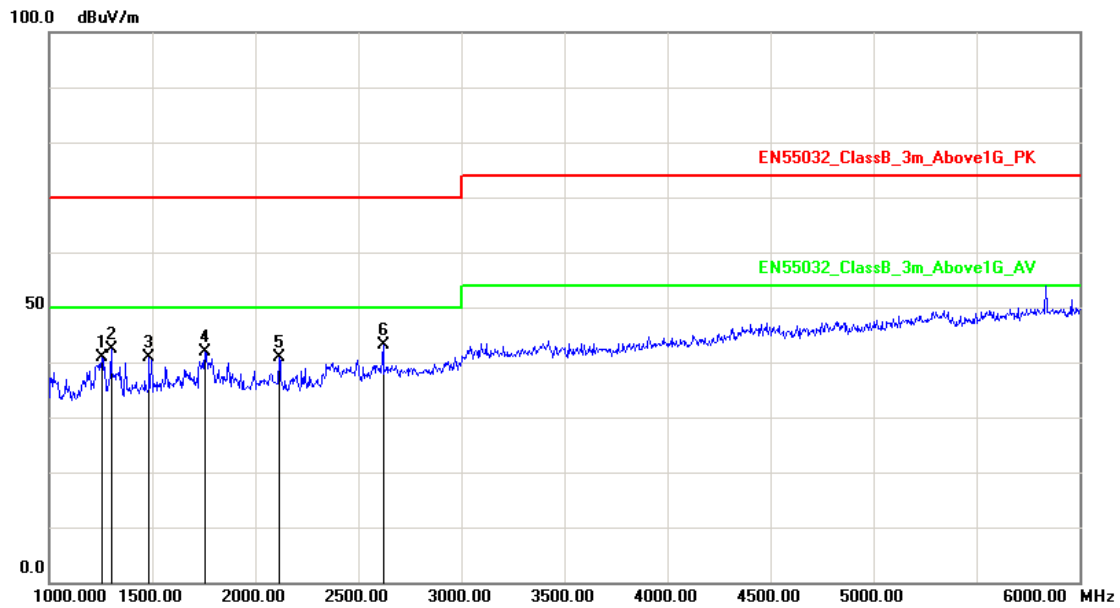

No.	Frequency (MHz)	Factor (dB/m)	Reading (dBuV)	Level (dBuV/m)	Limit (dBuV/m)	Margin (dB)	Det.	Height (cm)	Azimuth (deg)
1	1255.000	-4.27	45.10	40.83	70.00	-29.17	peak	100	298
2	1300.000	-3.97	46.38	42.41	70.00	-27.59	peak	100	5
3	1485.000	-2.90	43.82	40.92	70.00	-29.08	peak	200	63
4	1755.000	-1.91	43.75	41.84	70.00	-28.16	peak	100	360
5	2115.000	-0.61	41.55	40.94	70.00	-29.06	peak	200	21
6	2620.000	2.01	41.07	43.08	70.00	-26.92	peak	100	155

Note: Measurement Level = Reading Level + Correct Factor



Test Mode :	Mode 11: Full system (Display mode 1920*1080@60Hz) Signal from PC for ITU-RBT 471-1 Colour bars (110V/60Hz)		
AC Power :	AC 110V/60Hz	Ant. Polarization:	Vertical
Equipment :	LCD Monitor	Model No :	27V2Q
Temperature :	24°C	Humidity :	53%
Pressure(mbar) :	1001	Date:	2018/04/07

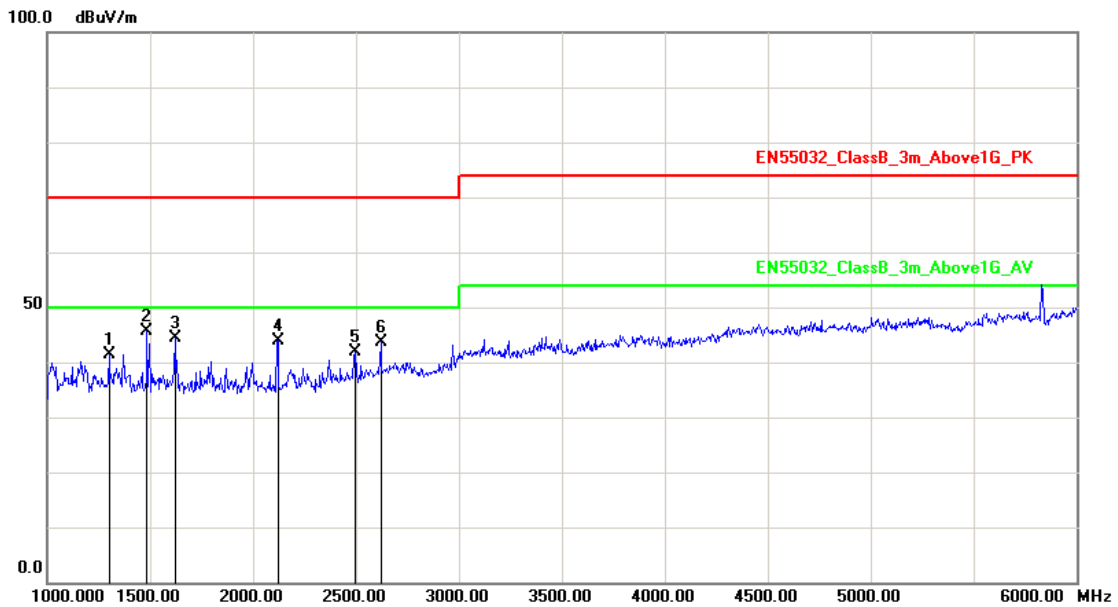

No.	Frequency (MHz)	Factor (dB/m)	Reading (dBuV)	Level (dBuV/m)	Limit (dBuV/m)	Margin (dB)	Det.	Height (cm)	Azimuth (deg)
1	1300.000	-3.97	45.31	41.34	70.00	-28.66	peak	200	141
2	1485.000	-2.90	48.61	45.71	70.00	-24.29	peak	100	165
3	1620.000	-2.29	46.73	44.44	70.00	-25.56	peak	200	22
4	2120.000	-0.59	44.48	43.89	70.00	-26.11	peak	100	301
5	2495.000	1.32	40.56	41.88	70.00	-28.12	peak	200	222
6	2620.000	2.01	41.52	43.53	70.00	-26.47	peak	200	298

Note: Measurement Level = Reading Level + Correct Factor



27V2H:

Test Mode :	Mode 1: Full system (VGA mode 1920*1080@60Hz) Signal from PC for ITU-RBT 1729 Colour bars (230V/50Hz)		
AC Power :	AC 230V/50Hz	Ant. Polarization:	Horizontal
Equipment :	LCD Monitor	Model No :	27V2H
Temperature :	24°C	Humidity :	53%
Pressure(mbar) :	1001	Date:	2018/04/07

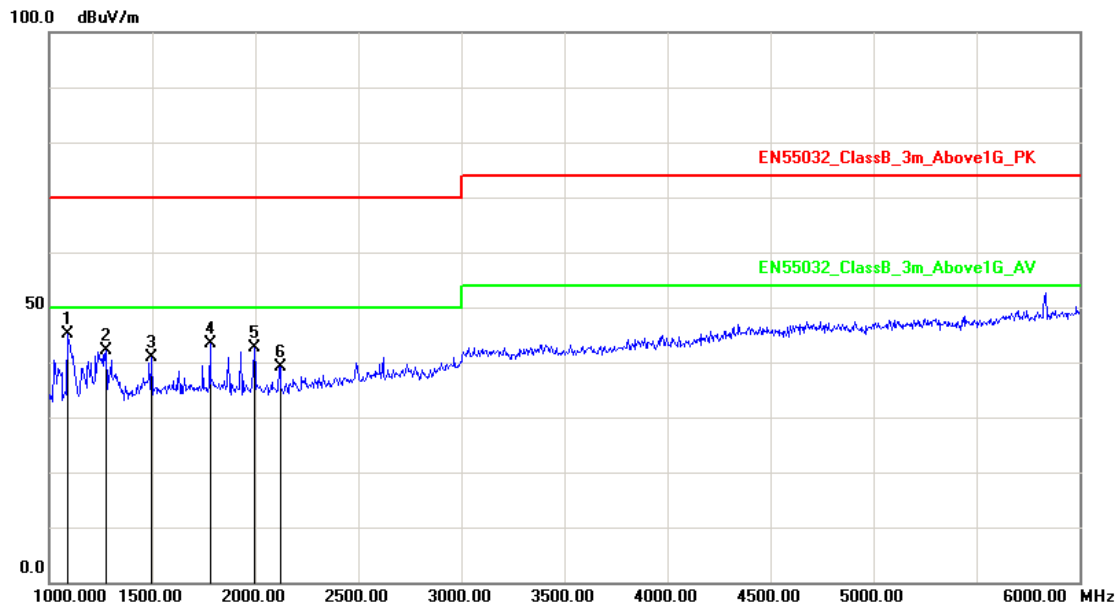

No.	Frequency (MHz)	Factor (dB/m)	Reading (dBuV)	Level (dBuV/m)	Limit (dBuV/m)	Margin (dB)	Det.	Height (cm)	Azimuth (deg)
1	1090.000	-5.38	50.56	45.18	70.00	-24.82	peak	138	360
2	1275.000	-4.14	46.15	42.01	70.00	-27.99	peak	100	338
3	1495.000	-2.85	43.77	40.92	70.00	-29.08	peak	200	305
4	1780.000	-1.84	45.13	43.29	70.00	-26.71	peak	100	323
5	1995.000	-1.21	43.83	42.62	70.00	-27.38	peak	100	320
6	2120.000	-0.59	39.81	39.22	70.00	-30.78	peak	100	50

Note: Measurement Level = Reading Level + Correct Factor



Test Mode :	Mode 1: Full system (VGA mode 1920*1080@60Hz) Signal from PC for ITU-RBT 1729 Colour bars (230V/50Hz)		
AC Power :	AC 230V/50Hz	Ant. Polarization:	Vertical
Equipment :	LCD Monitor	Model No :	27V2H
Temperature :	24°C	Humidity :	53%
Pressure(mbar) :	1001	Date:	2018/04/07

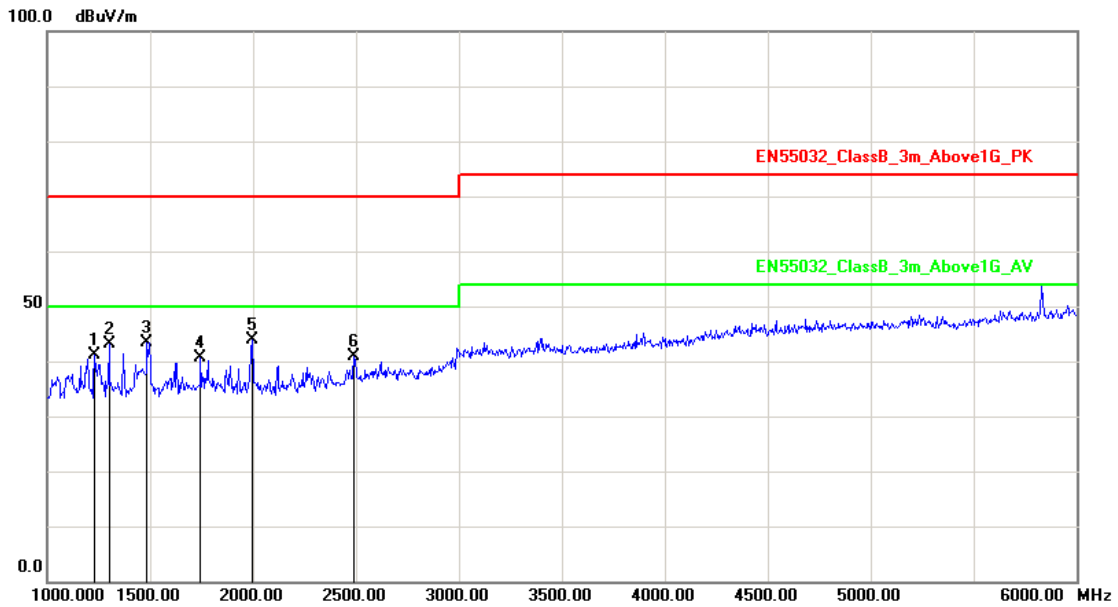

No.	Frequency (MHz)	Factor (dB/m)	Reading (dBuV)	Level (dBuV/m)	Limit (dBuV/m)	Margin (dB)	Det.	Height (cm)	Azimuth (deg)
1	1230.000	-4.44	45.56	41.12	70.00	-28.88	peak	99	133
2	1300.000	-3.97	47.04	43.07	70.00	-26.93	peak	200	187
3	1485.000	-2.90	46.31	43.41	70.00	-26.59	peak	99	329
4	1745.000	-1.94	42.67	40.73	70.00	-29.27	peak	99	285
5	1995.000	-1.21	45.17	43.96	70.00	-26.04	peak	99	163
6	2490.000	1.30	39.56	40.86	70.00	-29.14	peak	99	15

Note: Measurement Level = Reading Level + Correct Factor



Test Mode :	Mode 8: Full system (VGA mode 1920*1080@60Hz) Signal from PC for ITU-RBT 1729 Colour bars (110V/60Hz)		
AC Power :	AC 110V/60Hz	Ant. Polarization:	Horizontal
Equipment :	LCD Monitor	Model No :	27V2H
Temperature :	24°C	Humidity :	53%
Pressure(mbar) :	1001	Date:	2018/04/07

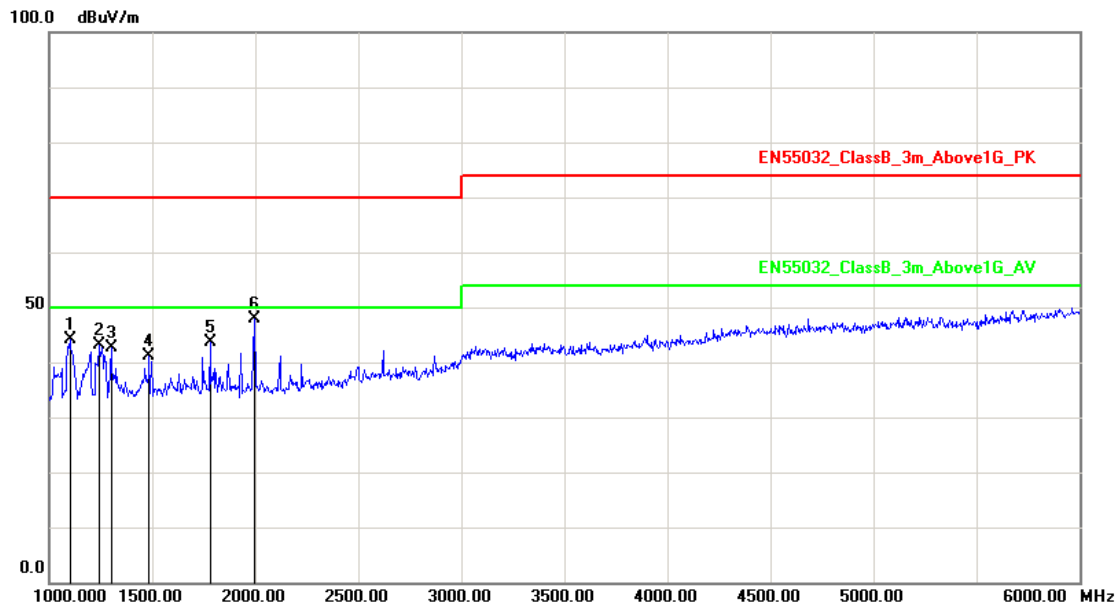

No.	Frequency (MHz)	Factor (dB/m)	Reading (dBuV)	Level (dBuV/m)	Limit (dBuV/m)	Margin (dB)	Det.	Height (cm)	Azimuth (deg)
1	1100.000	-5.31	49.37	44.06	70.00	-25.94	peak	200	1
2	1240.000	-4.37	47.45	43.08	70.00	-26.92	peak	100	331
3	1300.000	-3.97	46.71	42.74	70.00	-27.26	peak	100	301
4	1485.000	-2.90	44.14	41.24	70.00	-28.76	peak	100	316
5	1780.000	-1.84	45.56	43.72	70.00	-26.28	peak	100	329
6	1995.000	-1.21	49.19	47.98	70.00	-22.02	peak	100	194

Note: Measurement Level = Reading Level + Correct Factor



Test Mode :	Mode 8: Full system (VGA mode 1920*1080@60Hz) Signal from PC for ITU-RBT 1729 Colour bars (110V/60Hz)		
AC Power :	AC 110V/60Hz	Ant. Polarization:	Vertical
Equipment :	LCD Monitor	Model No :	27V2H
Temperature :	24°C	Humidity :	53%
Pressure(mbar) :	1001	Date:	2018/04/07

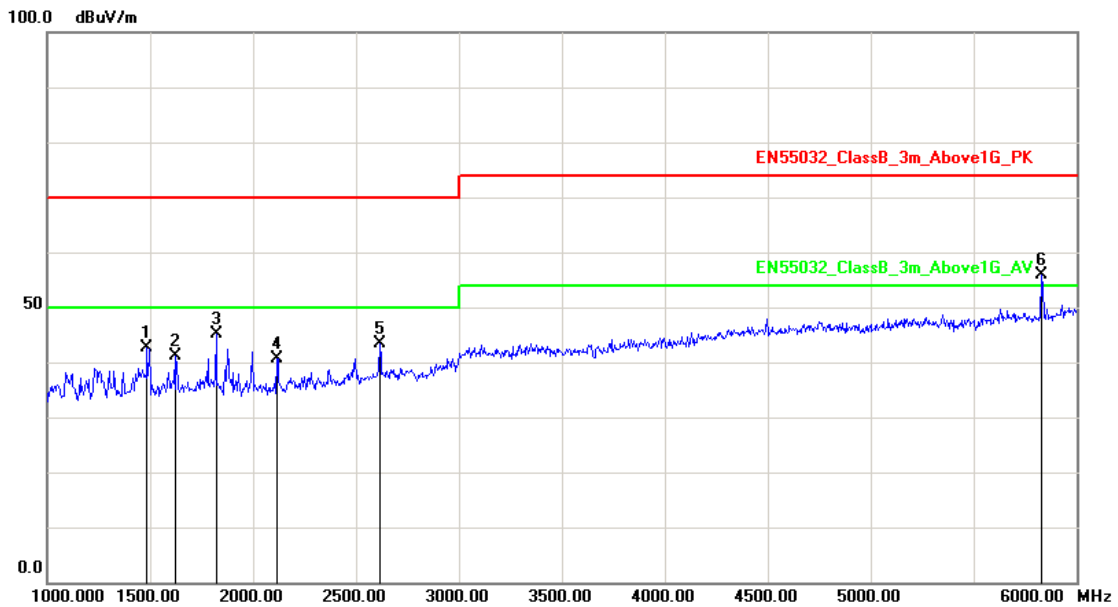

No.	Frequency (MHz)	Factor (dB/m)	Reading (dBuV)	Level (dBuV/m)	Limit (dBuV/m)	Margin (dB)	Det.	Height (cm)	Azimuth (deg)
1	1485.000	-2.90	45.41	42.51	70.00	-27.49	peak	100	348
2	1620.000	-2.29	43.49	41.20	70.00	-28.80	peak	100	0
3	1820.000	-1.72	46.79	45.07	70.00	-24.93	peak	100	182
4	2115.000	-0.61	41.33	40.72	70.00	-29.28	peak	100	198
5	2615.000	1.99	41.30	43.29	70.00	-26.71	peak	100	200
6	5830.000	13.53	42.31	55.84	74.00	-18.16	peak	100	224

Note: Measurement Level = Reading Level + Correct Factor



Test Mode :	Mode 10: Full system (VGA mode 1920*1080@60Hz) Signal from PC for ITU-RBT 471-1 Colour bars (230V/50Hz)		
AC Power :	AC 230V/50Hz	Ant. Polarization:	Horizontal
Equipment :	LCD Monitor	Model No :	27V2H
Temperature :	24°C	Humidity :	53%
Pressure(mbar) :	1001	Date:	2018/04/07

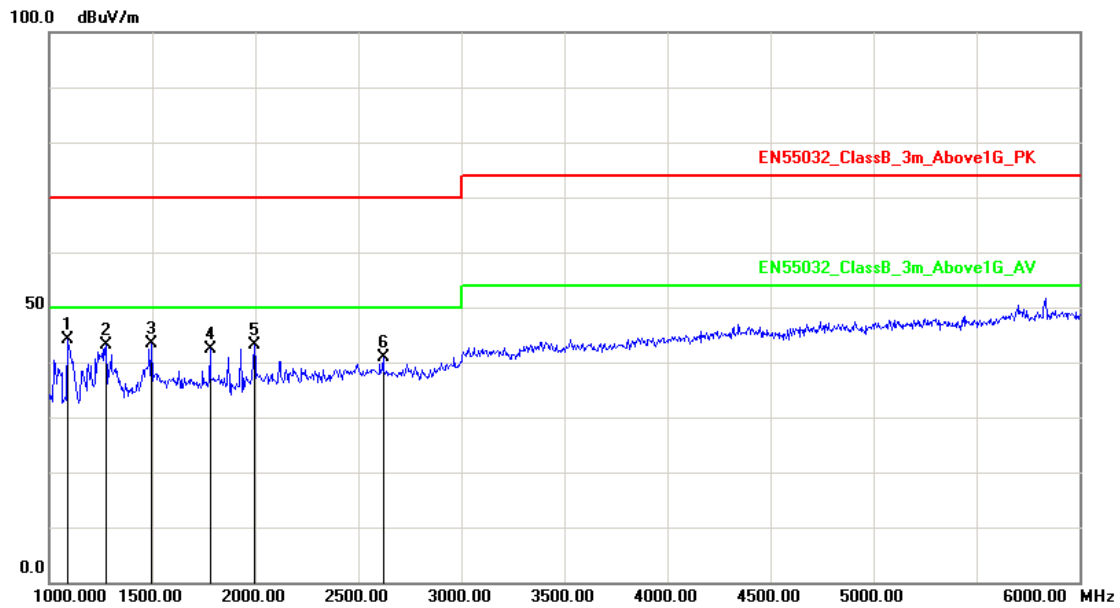

No.	Frequency (MHz)	Factor (dB/m)	Reading (dBuV)	Level (dBuV/m)	Limit (dBuV/m)	Margin (dB)	Det.	Height (cm)	Azimuth (deg)
1	1090.000	-5.38	49.56	44.18	70.00	-25.82	peak	100	66
2	1275.000	-4.14	47.15	43.01	70.00	-26.99	peak	200	306
3	1495.000	-2.85	46.27	43.42	70.00	-26.58	peak	100	185
4	1780.000	-1.84	44.13	42.29	70.00	-27.71	peak	200	98
5	1995.000	-1.21	44.33	43.12	70.00	-26.88	peak	100	22
6	2620.000	2.01	38.93	40.94	70.00	-29.06	peak	100	154

Note: Measurement Level = Reading Level + Correct Factor



Test Mode :	Mode 10: Full system (VGA mode 1920*1080@60Hz) Signal from PC for ITU-RBT 471-1 Colour bars (230V/50Hz)		
AC Power :	AC 230V/50Hz	Ant. Polarization:	Vertical
Equipment :	LCD Monitor	Model No :	27V2H
Temperature :	24°C	Humidity :	53%
Pressure(mbar) :	1001	Date:	2018/04/07

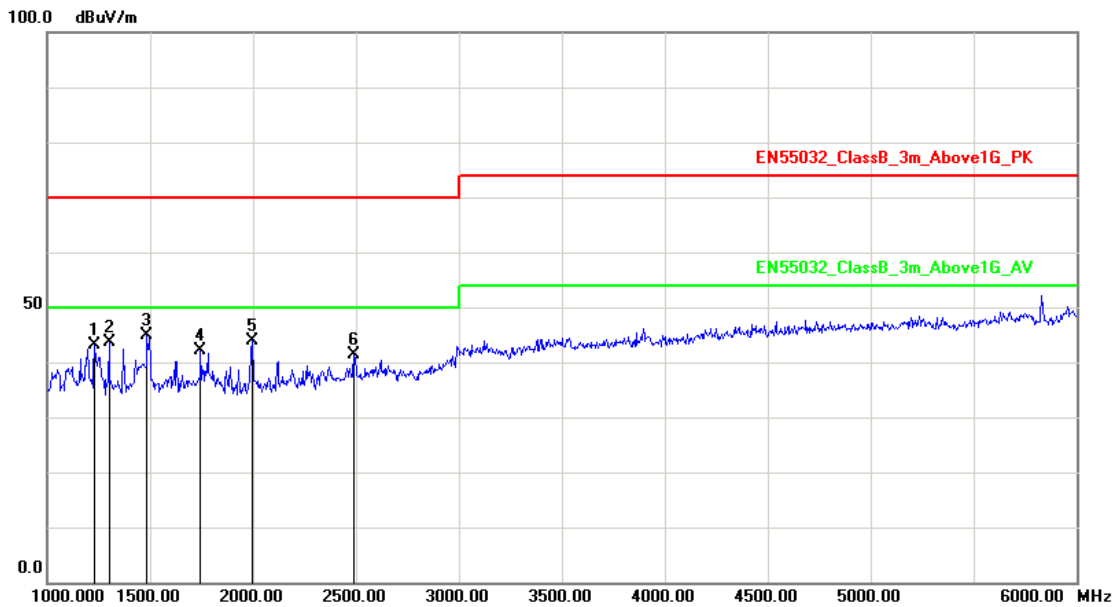

No.	Frequency (MHz)	Factor (dB/m)	Reading (dBuV)	Level (dBuV/m)	Limit (dBuV/m)	Margin (dB)	Det.	Height (cm)	Azimuth (deg)
1	1230.000	-4.44	47.56	43.12	70.00	-26.88	peak	200	198
2	1300.000	-3.97	47.54	43.57	70.00	-26.43	peak	100	11
3	1485.000	-2.90	47.81	44.91	70.00	-25.09	peak	200	2
4	1745.000	-1.94	44.17	42.23	70.00	-27.77	peak	100	55
5	1995.000	-1.21	45.17	43.96	70.00	-26.04	peak	200	187
6	2490.000	1.30	40.06	41.36	70.00	-28.64	peak	200	59

Note: Measurement Level = Reading Level + Correct Factor



Test Mode :	Mode 11: Full system (VGA mode 1920*1080@60Hz) Signal from PC for ITU-RBT 471-1 Colour bars (110V/60Hz)		
AC Power :	AC 110V/60Hz	Ant. Polarization:	Horizontal
Equipment :	LCD Monitor	Model No :	27V2H
Temperature :	24°C	Humidity :	53%
Pressure(mbar) :	1001	Date:	2018/04/07

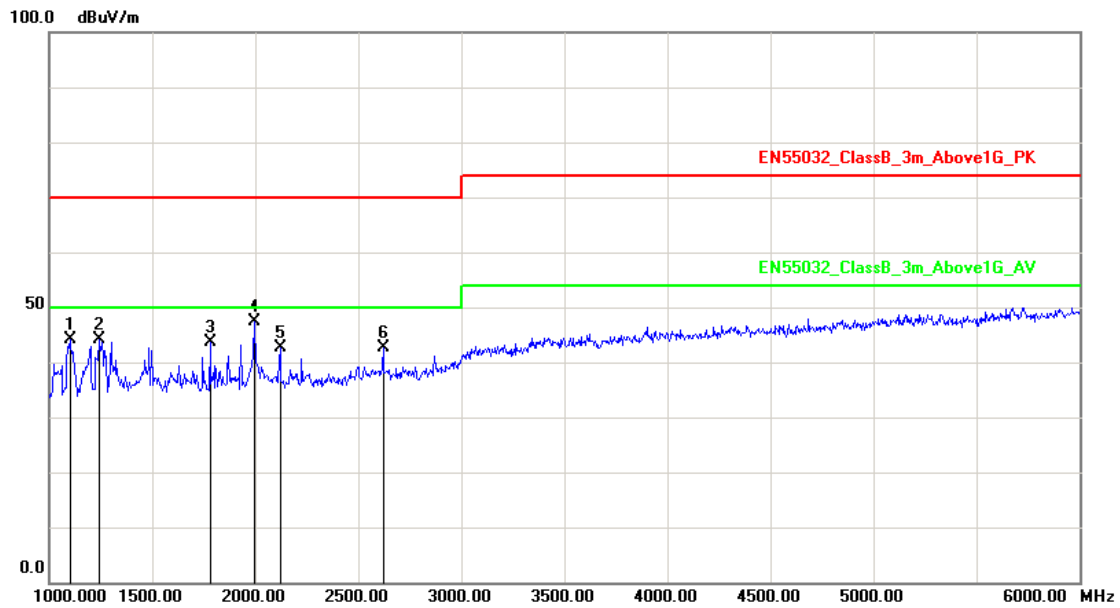

No.	Frequency (MHz)	Factor (dB/m)	Reading (dBuV)	Level (dBuV/m)	Limit (dBuV/m)	Margin (dB)	Det.	Height (cm)	Azimuth (deg)
1	1100.000	-5.31	49.37	44.06	70.00	-25.94	peak	100	55
2	1240.000	-4.37	48.45	44.08	70.00	-25.92	peak	100	198
3	1780.000	-1.84	45.56	43.72	70.00	-26.28	peak	100	111
4	1995.000	-1.21	48.69	47.48	70.00	-22.52	peak	200	301
5	2120.000	-0.59	43.25	42.66	70.00	-27.34	peak	100	22
6	2620.000	2.01	40.52	42.53	70.00	-27.47	peak	200	7

Note: Measurement Level = Reading Level + Correct Factor



Test Mode :	Mode 11: Full system (VGA mode 1920*1080@60Hz) Signal from PC for ITU-RBT 471-1 Colour bars (110V/60Hz)		
AC Power :	AC 110V/60Hz	Ant. Polarization:	Vertical
Equipment :	LCD Monitor	Model No :	27V2H
Temperature :	24°C	Humidity :	53%
Pressure(mbar) :	1001	Date:	2018/04/07

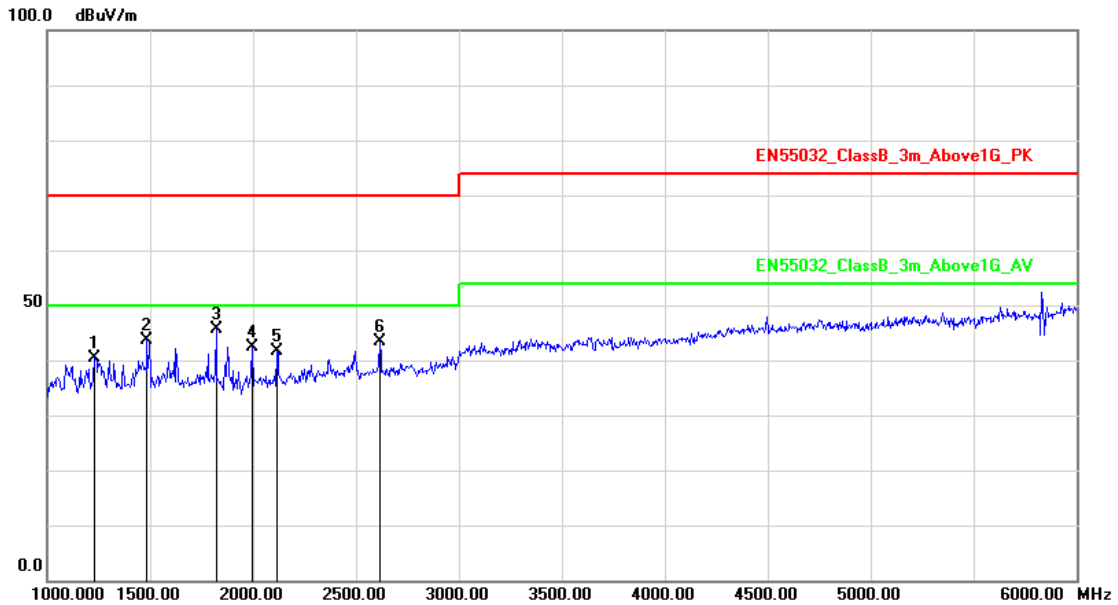

No.	Frequency (MHz)	Factor (dB/m)	Reading (dBuV)	Level (dBuV/m)	Limit (dBuV/m)	Margin (dB)	Det.	Height (cm)	Azimuth (deg)
1	1230.000	-4.44	44.87	40.43	70.00	-29.57	peak	200	1
2	1485.000	-2.90	46.41	43.51	70.00	-26.49	peak	200	144
3	1820.000	-1.72	47.29	45.57	70.00	-24.43	peak	100	122
4	1995.000	-1.21	43.60	42.39	70.00	-27.61	peak	200	301
5	2115.000	-0.61	42.33	41.72	70.00	-28.28	peak	100	98
6	2615.000	1.99	41.30	43.29	70.00	-26.71	peak	100	22

Note: Measurement Level = Reading Level + Correct Factor

Test engineer: Sun Zhang



5.7. Test Photographs (30MHz ~ 1000MHz)

27V2Q

For ITU-RBT 1729 Colour bars

Front View



Rear View

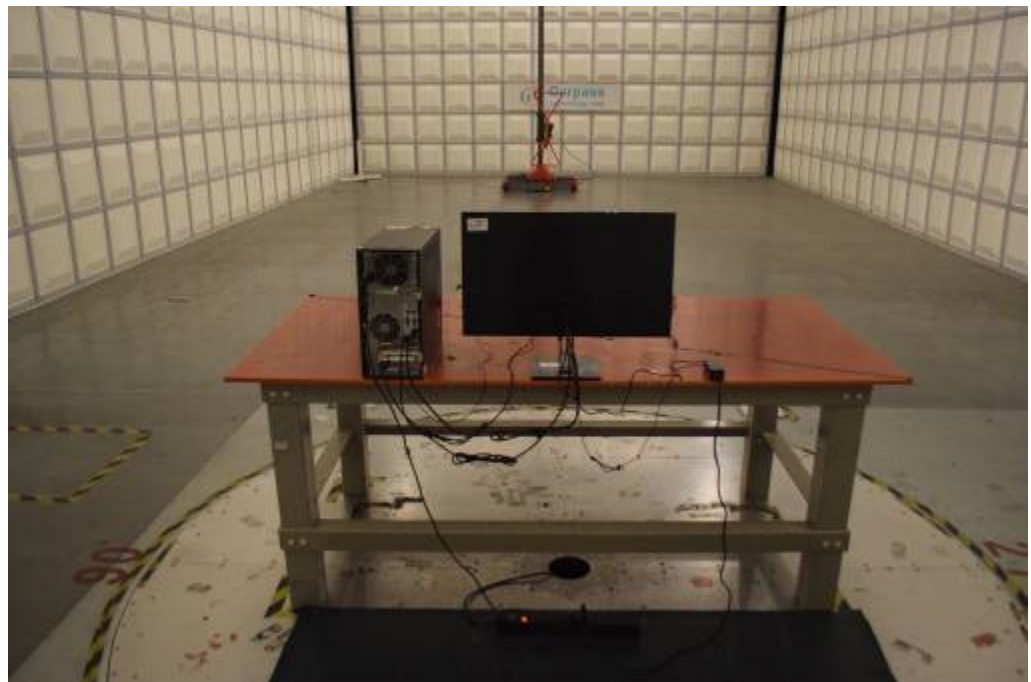



For ITU-RBT 471-1 Colour bars

Front View

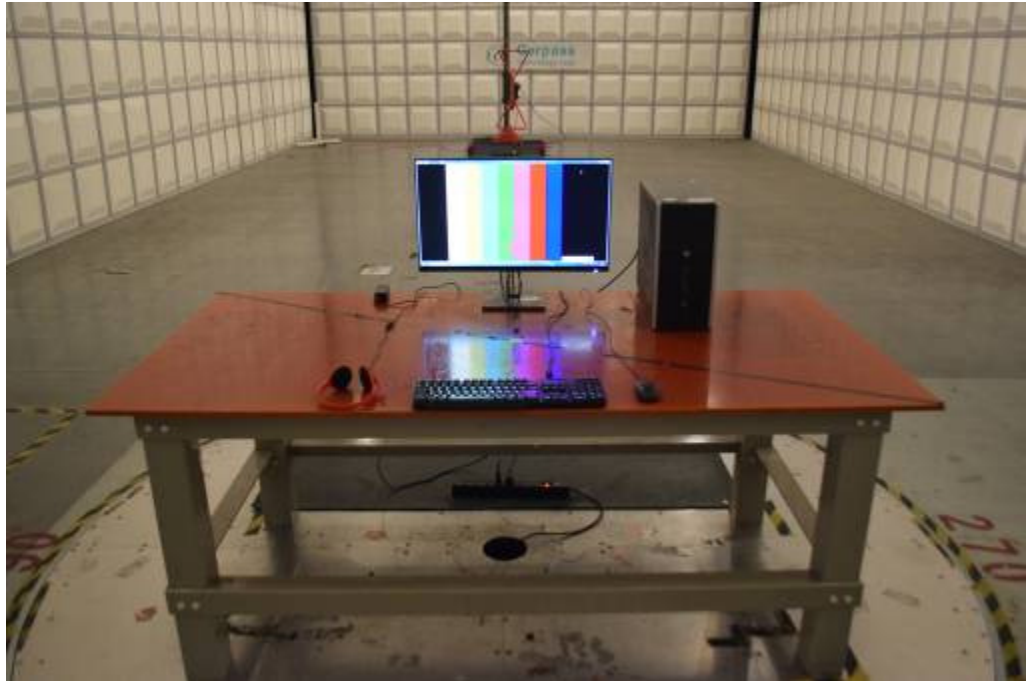

Rear View





27V2H

For ITU-RBT 1729 Colour bars

Front View



Rear View





For ITU-RBT 471-1 Colour bars

Front View

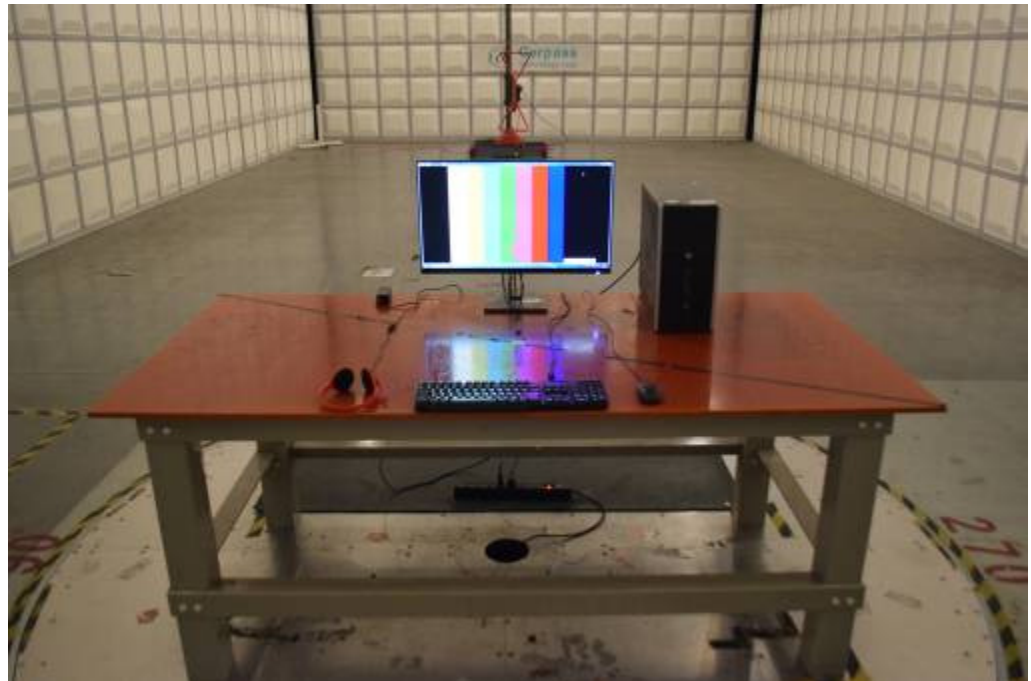

Rear View





5.8. Test Photographs (1000MHz ~ 6000MHz)

27V2Q

For ITU-RBT 1729 Colour bars

Front View

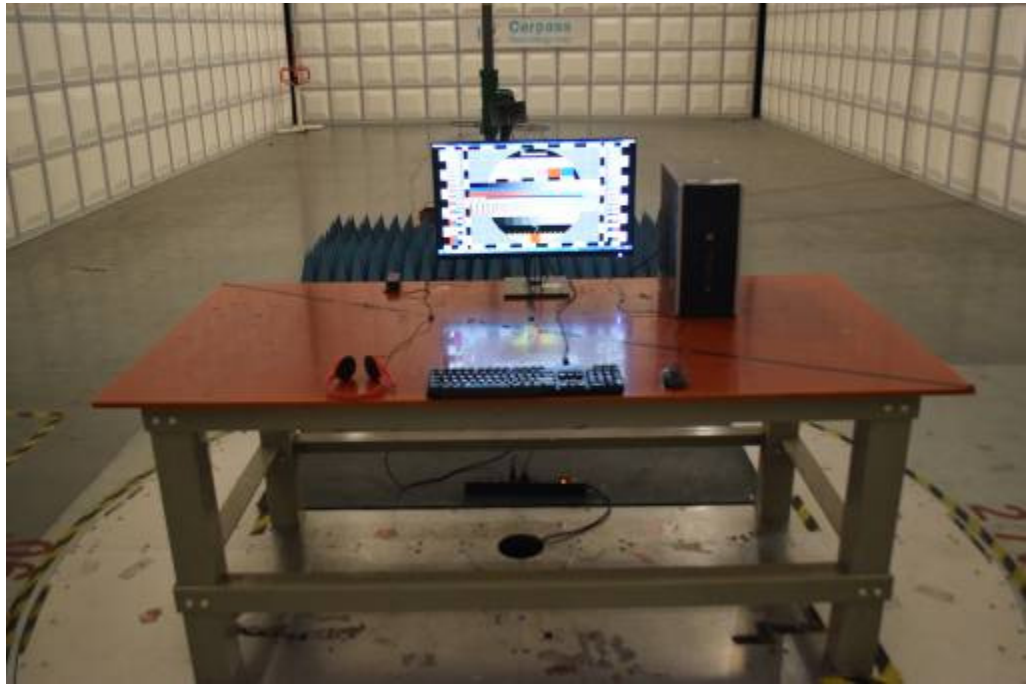

Rear View

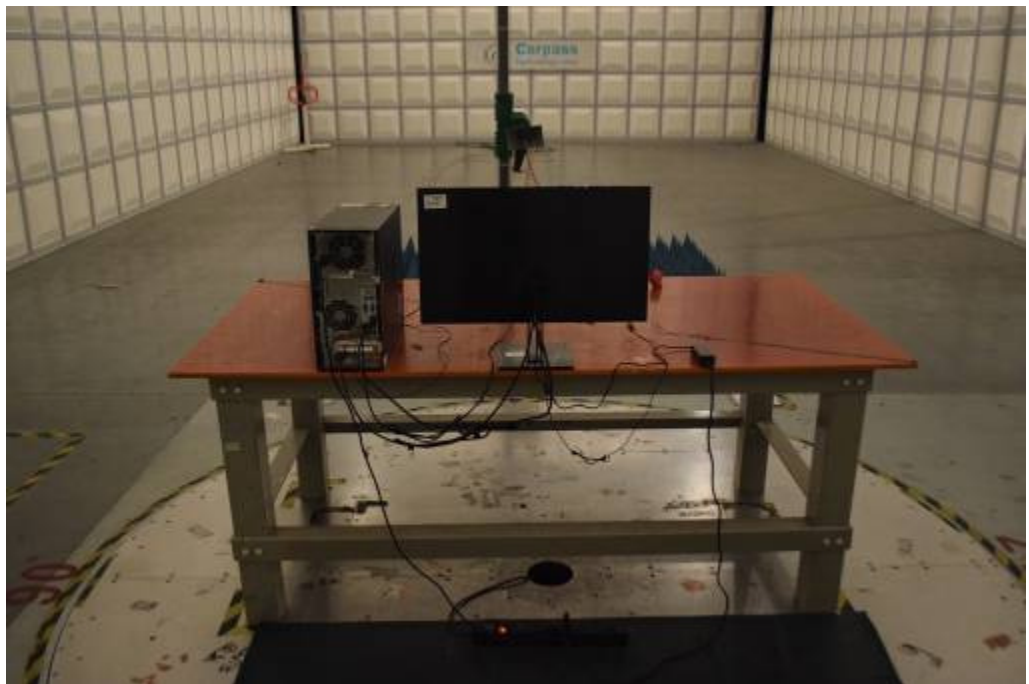



For ITU-RBT 471-1 Colour bars

Front View

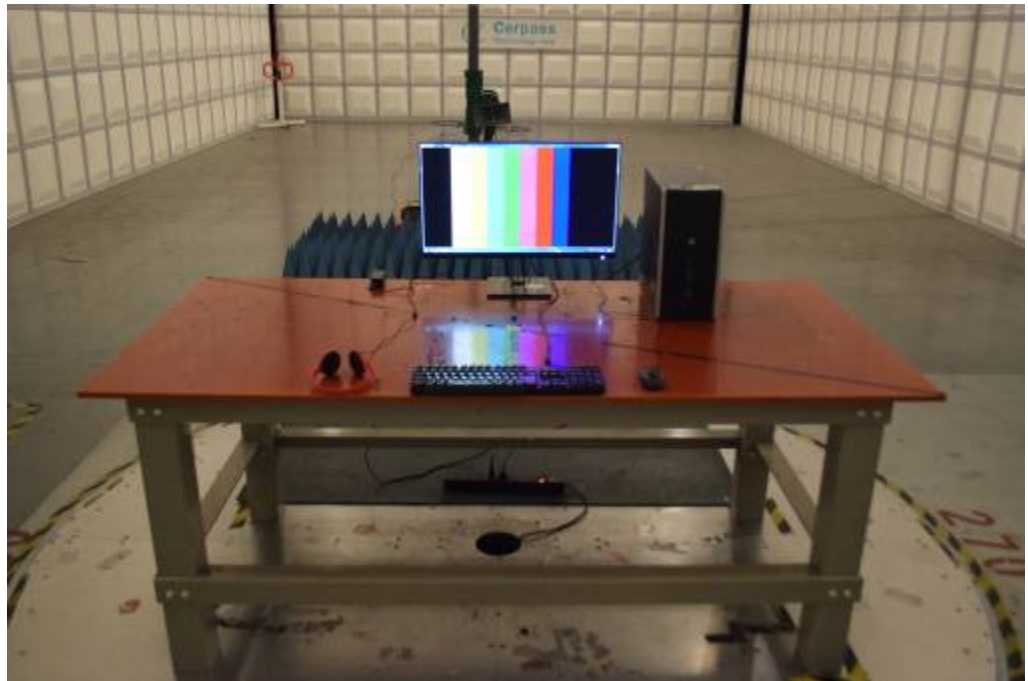

Rear View

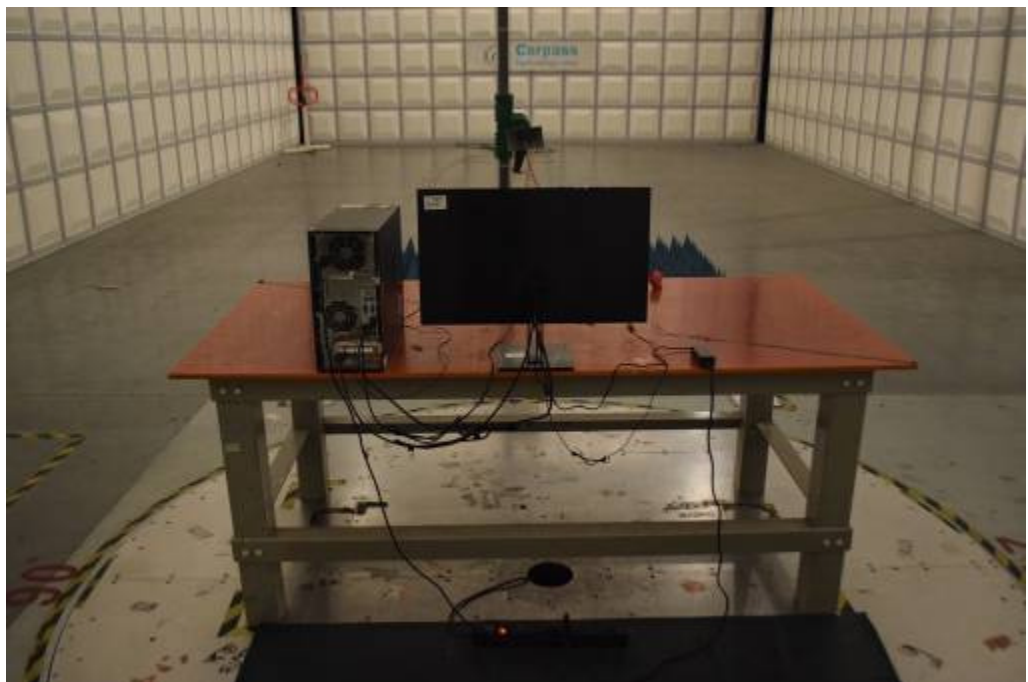



27V2H

For ITU-RBT 1729 Colour bars

Front View



Rear View

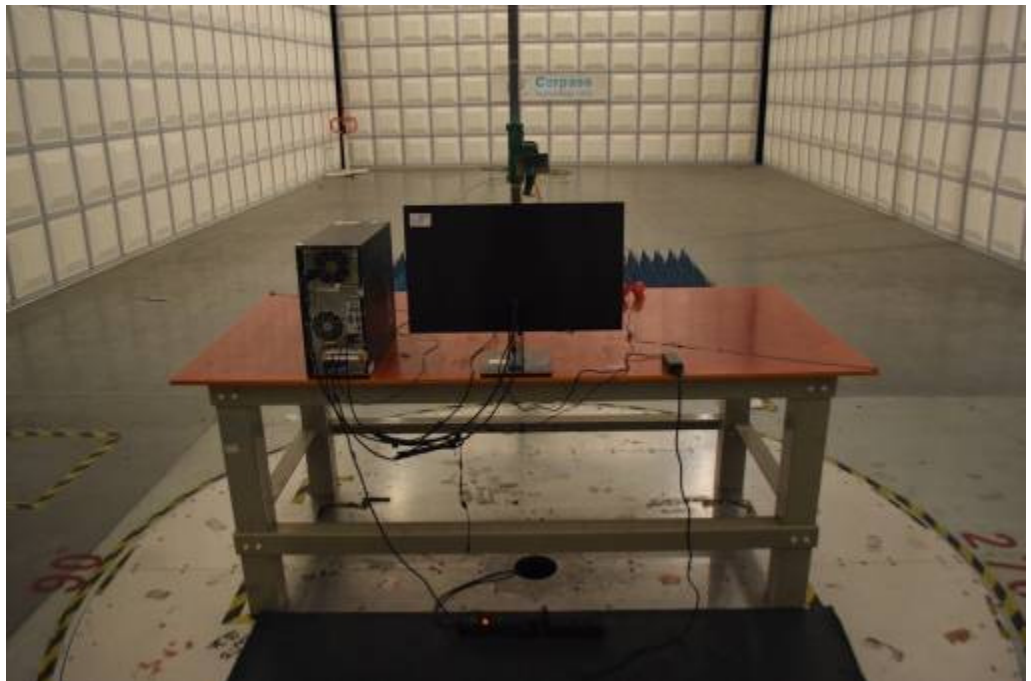



For ITU-RBT 471-1 Colour bars

Front View

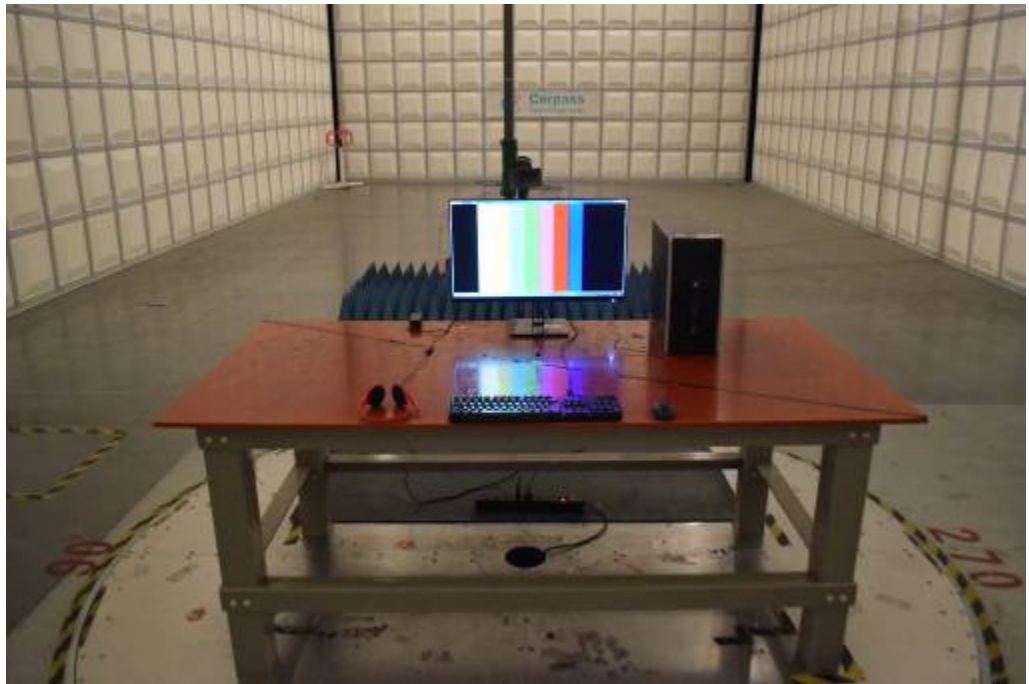

Rear View

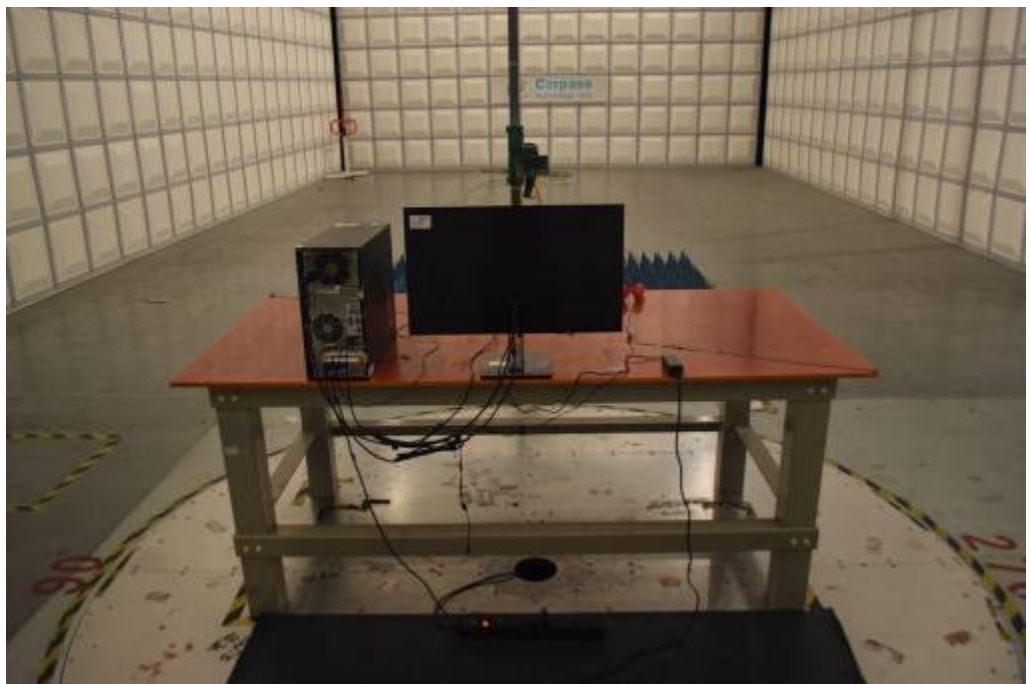



6. Harmonics Test

6.1. Limits of Harmonics Current Measurement

Limits for Class A equipment

Harmonics Order n	Max. permissible harmonics current A	Harmonics Order n	Max. permissible harmonics current A
Odd harmonics		Even harmonics	
3	2.30	2	1.08
5	1.14	4	0.43
7	0.77	6	0.30
9	0.40	8<=n<=40	0.23x8/n
11	0.33		
13	0.21		
15<=n<=39	0.15x15/n		

(b) Limits for Class B equipment

For Class B equipment, the harmonics of the input current shall not exceed the values given in Table that is the limit of Class A multiplied by a factor of 1,5.

(c) Limits for Class C equipment

Harmonics Order n	Maximum permissible harmonic current expressed as a percentage of the input current at the fundamental frequency %
2	2
3	$30 \cdot \lambda^*$
5	10
7	7
9	5
11<n<39 (odd harmonics only)	3

* λ is the circuit power factor

(d) Limits for Class D equipment

Harmonics Order n	Maximum permissible harmonic current per watt mA/W	Maximum permissible harmonic current A
3	3.4	2.30
5	1.9	1.14
7	1.0	0.77
9	0.5	0.40
11	0.35	0.33
11 < n < 39 (odd harmonics only)	3.85/n	See limit of Class A

NOTE: According to section 7 of EN 61000-3-2, the above limits for all equipment except for lighting equipment having an active input power > 75 W and no limits apply for equipment with an active input power up to and including 75 W.



6.2. Measurement equipment

Instrument/Ancillary	Manufacturer	Model No.	Serial No.	Calibration Date	Valid Date.
EMC Emission Tester	EMCPARTNER	Harmonics-1000	159	2017.07.12	2018.07.11
Temperature/ Humidity Meter	Zhicheng	ZC1-11	CEP-TH-004	2018.03.23	2019.03.22
HARCS	EMC Partner AG	Ver 4.18	N/A	N/A	N/A



6.3. Test Result and Data

27V2Q

Basic Standard	:	EN 61000-3-2
Final Test Result	:	PASS
Test Mode	:	Mode 1,2
Model No.	:	27V2Q
Temperature	:	23°C
Humidity	:	51 %
Atmospheric Pressure	:	100 kPa
Test Date	:	Apr 08, 2018

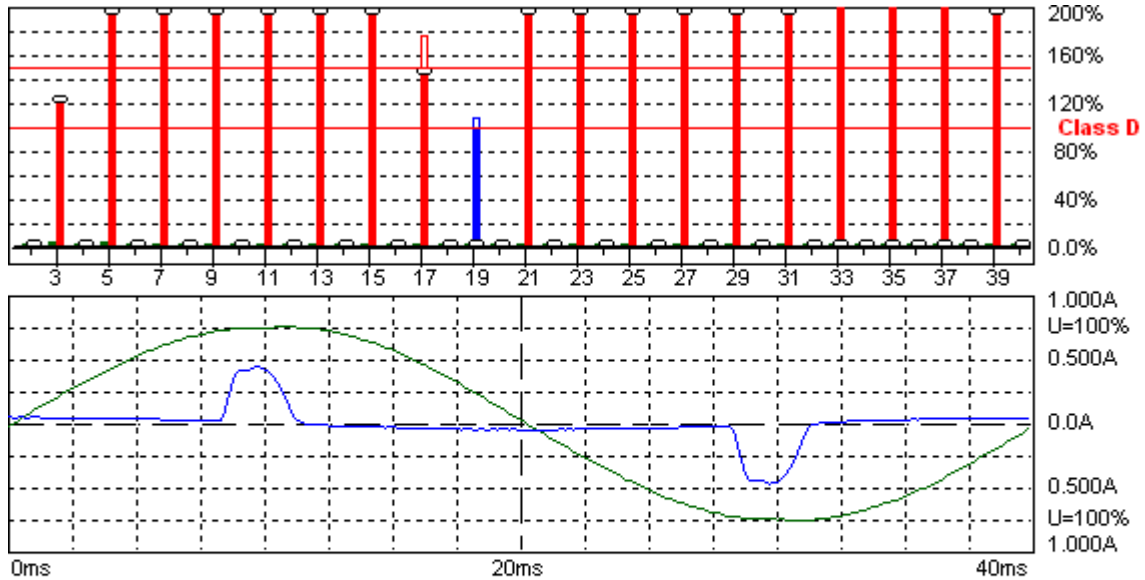

Harmonic Emission - IEC 61000-3-2 , EN 61000-3-2 , (EN60555-2)

2018-4-08 18:01:26 harmonic.hsu

Urms = 236.2 V	P = 15.71 W	THC = 0.119 A	Range: 1 A
Irms = 0.140 A	pf = 0.476	Pmax = 15.83 W	V-nom: 230 V
			TestTime: 15 min (100%)

HAR-1000 EMC-Parier

Full Bar : Actual Values

Empty Bar : Maximum Values

Blue : Current , Green : Voltage , Red : Failed

Urms = 236.2V Freq = 50.000 Range: 1 A

Irms = 0.140A Ipk = 0.484A cf = 3.469

P = 15.71W S = 32.98VA pf = 0.476

THDi = 153 % THDu = 1.20 % Class D

Test - Time : 15min (100 %)

Limit Reference: Pmax = 15.832W

Test completed



Order	Freq. [Hz]	Iavg [A]	Irms [A]	Imax [A]	Limit [A]	Status
1	50	0.0777	0.0778	0.0781		
2	100	0.0000	0.0032	0.0032		
3	150	0.0644	0.0645	0.0646	0.00	N/L
4	200	0.0000	0.0027	0.0029		
5	250	0.0583	0.0583	0.0585	0.00	N/L
6	300	0.0000	0.0023	0.0026		
7	350	0.0513	0.0513	0.0518	0.00	N/L
8	400	0.0000	0.0016	0.0019		
9	450	0.0425	0.0424	0.0431	0.00	N/L
10	500	0.0000	0.0012	0.0013		
11	550	0.0317	0.0316	0.0325	0.00	N/L
12	600	0.0000	0.0005	0.0007		
13	650	0.0220	0.0220	0.0229	0.00	N/L
14	700	0.0000	0.0003	0.0004		
15	750	0.0130	0.0129	0.0139	0.00	N/L
16	800	0.0000	0.0005	0.0005		
17	850	0.0052	0.0053	0.0063	0.00	N/L
18	900	0.0000	0.0007	0.0008		
19	950	0.0000	0.0031	0.0034	0.00	N/L
20	1000	0.0000	0.0009	0.0009		
21	1050	0.0065	0.0065	0.0069	0.00	N/L
22	1100	0.0000	0.0009	0.0010		
23	1150	0.0088	0.0088	0.0090	0.00	N/L
24	1200	0.0000	0.0007	0.0009		
25	1250	0.0095	0.0095	0.0096	0.00	N/L
26	1300	0.0000	0.0007	0.0008		
27	1350	0.0088	0.0087	0.0091	0.00	N/L
28	1400	0.0000	0.0007	0.0007		
29	1450	0.0073	0.0072	0.0076	0.00	N/L
30	1500	0.0000	0.0006	0.0007		
31	1550	0.0053	0.0052	0.0057	0.00	N/L
32	1600	0.0000	0.0007	0.0008		
33	1650	0.0000	0.0039	0.0042	0.00	N/L
34	1700	0.0000	0.0007	0.0009		
35	1750	0.0000	0.0039	0.0040	0.00	N/L
36	1800	0.0000	0.0009	0.0009		
37	1850	0.0000	0.0048	0.0049	0.00	N/L
38	1900	0.0000	0.0008	0.0009		
39	1950	0.0054	0.0054	0.0055	0.00	N/L
40	2000	0.0000	0.0007	0.0008		

The power of EUT is less than 75W after the testing. According the standard, the equipment with a rated power of 75W or less, other than lighting equipment, limits are not specified in this standard. So the test data needn't list.



27V2H

Basic Standard	:	EN 61000-3-2
Final Test Result	:	PASS
Test Mode	:	Mode 1,2
Model No.	:	27V2H
Temperature	:	23°C
Humidity	:	51 %
Atmospheric Pressure	:	100 kPa
Test Date	:	Apr 08, 2018

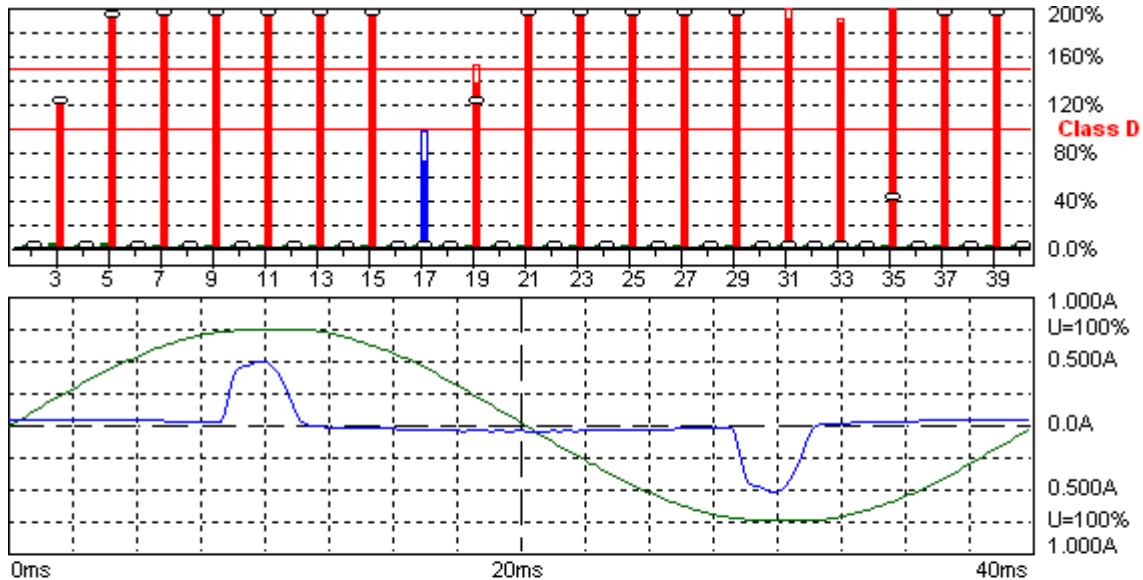

Harmonic Emission - IEC 61000-3-2 , EN 61000-3-2 , (EN60555-2)

2018-4-08 10:32:15 harmonic.hsu

Urms = 235.2 V	P = 18.33 W	THC = 0.135 A	Range: 1 A
Irms = 0.159 A	pf = 0.491	Pmax = 18.39 W	V-nom: 230 V
			TestTime: 15 min (100%)

HAR-1000 EMC-Parber

Full Bar : Actual Values

Empty Bar : Maximum Values

Blue : Current , Green : Voltage , Red : Failed

Urms = 235.2V Freq = 49.987 Range: 1 A
 Irms = 0.159A Ipk = 0.535A cf = 3.372
 P = 18.33W S = 37.33VA pf = 0.491
 THDi = 152 % THDu = 1.20 % Class D
 Test - Time : 15min (100 %)
 Limit Reference: Pmax = 18.395W
 Test completed



Order	Freq. [Hz]	Iavg [A]	Irms [A]	I _{max} [A]	Limit [A]	Status
1	50	0.0885	0.0886	0.0888		
2	100	0.0000	0.0028	0.0034		
3	150	0.0752	0.0752	0.0754	0.00	N/L
4	200	0.0000	0.0027	0.0033		
5	250	0.0673	0.0673	0.0676	0.00	N/L
6	300	0.0000	0.0024	0.0029		
7	350	0.0582	0.0582	0.0587	0.00	N/L
8	400	0.0000	0.0017	0.0020		
9	450	0.0470	0.0471	0.0479	0.00	N/L
10	500	0.0000	0.0011	0.0013		
11	550	0.0337	0.0338	0.0349	0.00	N/L
12	600	0.0000	0.0005	0.0007		
13	650	0.0219	0.0220	0.0231	0.00	N/L
14	700	0.0000	0.0004	0.0004		
15	750	0.0112	0.0112	0.0125	0.00	N/L
16	800	0.0000	0.0005	0.0007		
17	850	0.0000	0.0029	0.0040	0.00	N/L
18	900	0.0000	0.0007	0.0009		
19	950	0.0045	0.0051	0.0056	0.00	N/L
20	1000	0.0000	0.0009	0.0010		
21	1050	0.0089	0.0090	0.0093	0.00	N/L
22	1100	0.0000	0.0009	0.0010		
23	1150	0.0105	0.0106	0.0107	0.00	N/L
24	1200	0.0000	0.0007	0.0008		
25	1250	0.0103	0.0104	0.0105	0.00	N/L
26	1300	0.0000	0.0007	0.0008		
27	1350	0.0086	0.0087	0.0090	0.00	N/L
28	1400	0.0000	0.0006	0.0007		
29	1450	0.0062	0.0063	0.0068	0.00	N/L
30	1500	0.0000	0.0007	0.0008		
31	1550	0.0000	0.0043	0.0046	0.00	N/L
32	1600	0.0000	0.0007	0.0009		
33	1650	0.0000	0.0040	0.0040	0.00	N/L
34	1700	0.0000	0.0007	0.0009		
35	1750	0.0008	0.0050	0.0052	0.00	N/L
36	1800	0.0000	0.0008	0.0009		
37	1850	0.0058	0.0059	0.0060	0.00	N/L
38	1900	0.0000	0.0007	0.0009		
39	1950	0.0061	0.0062	0.0063	0.00	N/L
40	2000	0.0000	0.0007	0.0009		

The power of EUT is less than 75W after the testing. According the standard, the equipment with a rated power of 75W or less, other than lighting equipment, limits are not specified in this standard. So the test data needn't list.

Test engineer: Sun. Zhang



6.4. Test Photographs

27V2Q



27V2H





7. Voltage Fluctuations Test

7.1. Test Procedure

The equipment shall be tested under the conditions of **Clause 5**.

The total impedance of the test circuit, excluding the appliance under test, but including the internal impedance of the supply source, shall be equal to the reference impedance.

The stability and tolerance of the reference impedance shall be adequate to ensure that the overall accuracy of $\pm 8\%$ is achieved during the whole assessment procedure.

7.2. Measurement equipment

Instrument/Ancillary	Manufacturer	Model No.	Serial No.	Calibration Date	Valid Date.
EMC Emission Tester	EMCPARTNER	Harmonics-1000	159	2017.07.12	2018.07.11
Temperature/ Humidity Meter	Zhicheng	ZC1-11	CEP-TH-004	2018.03.23	2019.03.22
HARCS	EMC Partner AG	Ver 4.18	N/A	N/A	N/A



7.3. Test Result and Data

27V2Q

Basic Standard	:	EN 61000-3-3
Final Test Result	:	PASS
Test Mode	:	Mode 1,2
Model No.	:	27V2Q
Temperature	:	23°C
Humidity	:	51 %
Atmospheric Pressure	:	100 kPa
Test Data	:	Apr 08, 2018

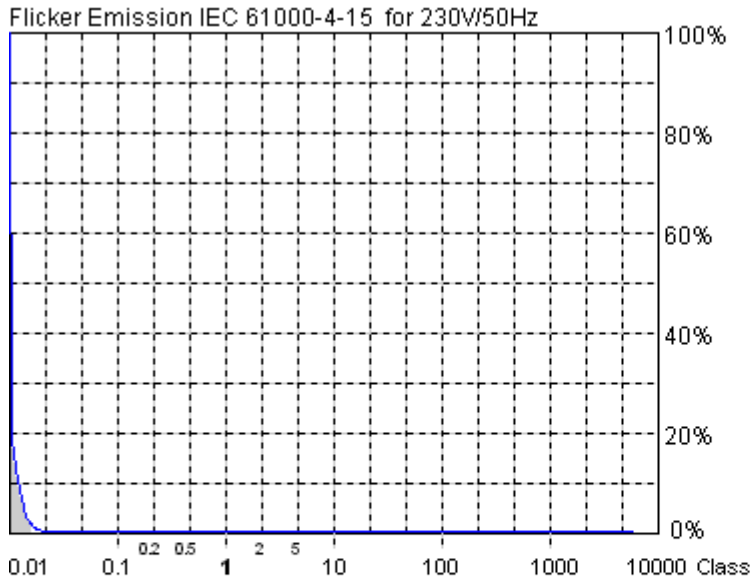

Actual Flicker (Fli):	0.01
Short-term Flicker (Pst):	0.08
Limit (Pst):	1.00
Long-term Flicker (Plt):	0.08
Limit (Plt):	0.65
Maximum Relative Volt. Change (dmax):	0.00%
Limit (dmax):	4.00%
Relative Steady-state Voltage Change (dc):	0.13%
Limit (dc):	3.00%
Tmax 3.00% (dt):	0.00ms
Limit (dt>Lim):	500ms

Flicker Emission - IEC 61000-3-3 , EN 61000-3-3

Urms = 236.4 V P = 15.71 W
 Irms = 0.140 A pf = 0.476

2018-4-08 18:25:21 harmonic.hsu

Range: 1 A
 V-nom: 230 V
 TestTime: 10 min (100%)

Test completed, Result: PASSED

HAR-1000 EMC-Parber

- Full Bar : Actual Values
- Empty Bar : Maximum Values
- Circles : Average Values
- Blue : Current , Green : Voltage , Red : Failed



Urms = 236.4V Freq = 50.000 Range: 1 A
Irms = 0.140A Ipk = 0.486A cf = 3.479
P = 15.71W S = 33.01VA pf = 0.476

Test - Time : 1 x 10min = 10min (100 %)

LIN (Line Impedance Network) : No LIN

Limits : Plt : 0.65 Pst : 1.00
dmax : 4.00 % dc : 3.00 %
dtLim: 3.00 % dt>Lim: 500ms

Test completed, Result: PASSED



27V2H

Basic Standard	:	EN 61000-3-3
Final Test Result	:	PASS
Test Mode	:	Mode 1,2
Model No.	:	27V2H
Temperature	:	23°C
Humidity	:	51 %
Atmospheric Pressure	:	100 kPa
Test Data	:	Apr 08, 2018

Flicker Emission IEC 61000-4-15 for 230V/50Hz

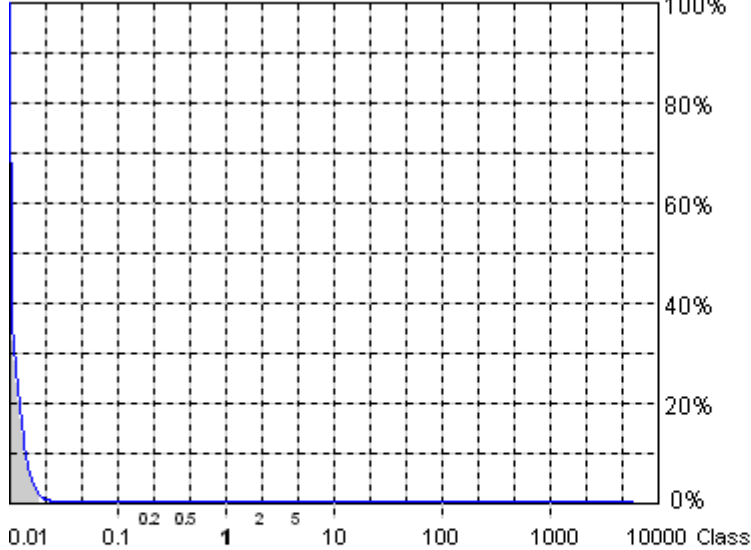

Actual Flicker (Fli): 0.01
Short-term Flicker (Pst): 0.09
 Limit (Pst): 1.00
Long-term Flicker (Plt): 0.09
 Limit (Plt): 0.65
Maximum Relative Volt. Change (dmax): 0.00%
 Limit (dmax): 4.00%
Relative Steady-state Voltage Change (dc): 0.14%
 Limit (dc): 3.00%
Tmax 3.00% (dt): 0.00ms
 Limit (dt>Lim): 500ms

Flicker Emission - IEC 61000-3-3 , EN 61000-3-3

Urms = 235.2 V P = 18.28 W
 Irms = 0.158 A pf = 0.491

2018-4-08 10:51:33 harmonic.hsu

Range: 1 A
 V-nom: 230 V
 TestTime: 10 min (100%)

Test completed, Result: PASSED

HAR-1000 EMC-Partner

- Full Bar : Actual Values
- Empty Bar : Maximum Values
- Circles : Average Values
- Blue : Current , Green : Voltage , Red : Failed



Urms = 235.2V Freq = 50.013 Range: 1 A
Irms = 0.158A Ipk = 0.535A cf = 3.383
P = 18.28W S = 37.21VA pf = 0.491

Test - Time : 1 x 10min = 10min (100 %)

LIN (Line Impedance Network) : No LIN

Limits : Plt : 0.65 Pst : 1.00
dmax : 4.00 % dc : 3.00 %
dtLim: 3.00 % dt>Lim: 500ms

Test completed, Result: PASSED

Test engineer: Sun. Zhang



7.4. Test Photographs

27V2Q



27V2H





8. Electrostatic Discharge Immunity Test

8.1. Test Procedure

- a. In the case of air discharge testing the climatic conditions shall be within the following ranges:
 - ambient temperature: 15°C to 35°C;
 - relative humidity : 30% to 60%;
 - atmospheric pressure : 86 KPa (860 mbar) to 106 KPa (1060 mbar).
- b. Test programs and software shall be chosen so as to exercise all normal modes of operation of the EUT. The use of special exercising software is encouraged, but permitted only where it can be shown that the EUT is being comprehensively exercised.
- c. The test voltage shall be increased from the minimum to the selected test severity level, in order to determine any threshold of failure. The final severity level should not exceed the product specification value in order to avoid damage to the equipment.
- d. The test shall be performed with both air discharge and contact discharge. On reselected points at least 10 single discharges (in the most sensitive polarity) shall be applied on air discharge. On reselected points at least 25 single discharges (in the most sensitive polarity) shall be applied on contact discharge.
- e. For the time interval between successive single discharges an initial value of one second is recommended. Longer intervals may be necessary to determine whether a system failure has occurred.
- f. In the case of contact discharges, the tip of the discharge electrode shall touch the EUT before the discharge switch is operated.
- g. In the case of painted surface covering a conducting substrate, the following procedure shall be adopted :
 - If the coating is not declared to be an insulating coating by the equipment manufacturer, then the pointed tip of the generator shall penetrate the coating so as to make contact with the conducting substrate.
 - Coating declared as insulating by the manufacturer shall only be submitted to the air discharge.
 - The contact discharge test shall not be applied to such surfaces.
- h. In the case of air discharges, the round discharge tip of the discharge electrode shall be approached as fast as possible (without causing mechanical damage) to touch the EUT . After each discharge, the ESD generator (discharge electrode) shall be removed from the EUT. The generator is then retriggered for a new single discharge. This procedure shall be repeated until the discharges are completed. In the case of an air discharge test, the discharge switch, which is used for contact discharge, shall be closed.

8.2. Test Setup for Tests Performed in Laboratory

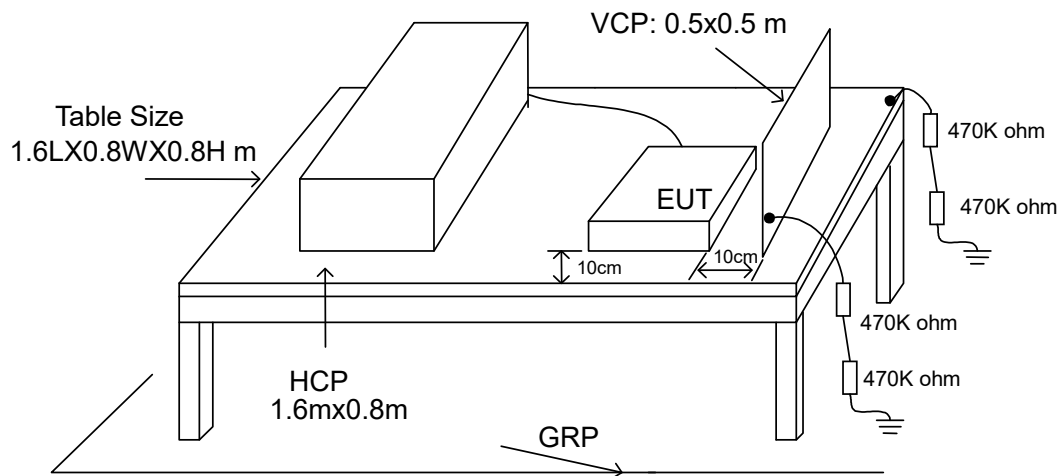

The test setup consists of the test generator, EUT and auxiliary instrumentation necessary to perform DIRECT and INDIRECT application of discharges to the EUT as applicable, in the following manner :

- a. Contact Discharge to the conductive surfaces and to coupling plane;
- b. Air Discharge at insulating surfaces.

The preferred test method is that of type tests performed in laboratories and the only accepted method of demonstrating conformance with this standard. The EUT was arranged as closely as possible to arrangement in final installed conditions.

A ground reference plane was provided on the floor of the test site. It was a metallic sheet (copper or aluminum) of 0.25 mm, minimum thickness; other metallic may be used but they shall have at least 0.65 mm thickness. In the CerpPASS Technology Corp., we provided 1 mm thickness stainless steel ground reference plane. The minimum size of the ground reference plane is 2.5 m x 2.5 m, the exact size depending on the dimensions of the EUT. It was connected to the protective grounding system.

The EUT was arranged and connected according to its functional requirements. A distance of 1m minimum was provided between the EUT and the wall of the lab. and any other metallic structure. In cases where this length exceeds the length necessary to apply the discharges to the selected points, the excess length shall, where possible, be placed non-inductively off the ground reference plane and shall not come closer than 0.2m to other conductive parts in the test setup.

Where the EUT is installed on a metal table, the table was connected to the reference plane via a cable with a 470k ohm resistor located at each end, to prevent a build-up of charge. The test setup was consist a wooden table, 0.8m high, standing on the ground reference plane. A HCP, 1.6 m x 0.8 m, was placed on the table. The EUT and cables was isolated from the HCP by an insulating support 0.5 mm thick. The VCP size, 0.5 m x 0.5 m.



8.3. Test Severity Levels

Contact Discharge		Air Discharge	
Level	Test Voltage (KV) of Contact discharge	Level	Test Voltage (KV) of Air Discharge
1	±2	1	±2
2	±4	2	±4
3	±6	3	±8
4	±8	4	±15
X	Specified	X	Specified

Remark: "X" is an open level.

8.4. Measurement equipment

Instrument/Ancillary	Manufacturer	Model No.	Serial No.	Calibration Date	Valid Date.
ESD Simulator	EM Test	Dito	P1645186902	2017.09.20	2018.09.19
Tonometer	shanghaihengyun	DYM3	3251	2018.01.17	2019.01.16
Dehumidifier	ZEDO	ZD-220LB	CEP-TH-01	N/A	N/A
Humidifier	YADU	YZ-DS251C	CEP-TH-02	N/A	N/A
Temperature/ Humidity Meter	feiyang	N/A	102	2018.03.23	2019.03.22
ESD Simulator	NoiseKen	ESS-B3011A	AEC00315-00 C-0A	2017.12.07	2018.12.06



8.5. Test Result and Data

27V2Q

Basic Standard : IEC 61000-4-2
 Final Test Result : PASS
 Model No. : 27V2Q
 Pass performance criteria : B
 Test Voltage : ±2 / ±4 / ±8 kV for air discharge,
 : ±2 / ±4 kV for contact discharge
 Temperature : 24 °C
 Relative Humidity : 48%
 Atmospheric Pressure : 100 kPa
 Test Date : Apr 09, 2018

Test Mode : Mode 1,2

	Contact Discharge								Air Discharge							
	25 times / each								10 times / each							
Voltage	2 kV		4 kV		6 kV		8 kV		2 kV		4 kV		8 kV		10 kV	
Point\Polarity	+	-	+	-	+	-	+	-	+	-	+	-	+	-	+	-
HCP	A	A	A	A	---	---	---	---	---	---	---	---	---	---	---	---
VCP	A	A	A	A	---	---	---	---	---	---	---	---	---	---	---	---
Screw	A	A	A	A	---	---	---	---	---	---	---	---	---	---	---	---
Case	---	---	---	---	---	---	---	---	A	A	A	A	A	A	---	---
Panel	---	---	---	---	---	---	---	---	A	A	A	A	A	A	---	---
HDMI Port	A	A	A	A	---	---	---	---	---	---	---	---	---	---	---	---
DP Port	A	A	A	A	---	---	---	---	---	---	---	---	---	---	---	---
Audio Port	---	---	---	---	---	---	---	---	A	A	A	A	A	A	---	---
Power Port	---	---	---	---	---	---	---	---	A	A	A	A	A	A	---	---
Button	---	---	---	---	---	---	---	---	A	A	A	A	A	A	---	---
LED Light	---	---	---	---	---	---	---	---	A	A	A	A	A	A	---	---



27V2H

Basic Standard : IEC 61000-4-2
 Final Test Result : PASS
 Model No. : 27V2H
 Pass performance criteria : B
 Test Voltage : ±2 / ±4 / ±8 kV for air discharge,
 : ±2 / ±4 kV for contact discharge
 Temperature : 24 °C
 Relative Humidity : 48%
 Atmospheric Pressure : 100 kPa
 Test Date : Apr 09, 2018

Test Mode : Mode 1,2

	Contact Discharge								Air Discharge							
	25 times / each								10 times / each							
Voltage	2 kV		4 kV		6 kV		8 kV		2 kV		4 kV		8 kV		10 kV	
Point/Polarity	+	-	+	-	+	-	+	-	+	-	+	-	+	-	+	-
HCP	A	A	A	A	---	---	---	---	---	---	---	---	---	---	---	---
VCP	A	A	A	A	---	---	---	---	---	---	---	---	---	---	---	---
Screw	A	A	A	A	---	---	---	---	---	---	---	---	---	---	---	---
Case	---	---	---	---	---	---	---	---	A	A	A	A	A	A	---	---
Panel	---	---	---	---	---	---	---	---	A	A	A	A	A	A	---	---
HDMI Port	A	A	A	A	---	---	---	---	---	---	---	---	---	---	---	---
VGA Port	A	A	A	A	---	---	---	---	---	---	---	---	---	---	---	---
Audio Port	---	---	---	---	---	---	---	---	A	A	A	A	A	A	---	---
Power Port	---	---	---	---	---	---	---	---	A	A	A	A	A	A	---	---
Button	---	---	---	---	---	---	---	---	A	A	A	A	A	A	---	---
LED Light	---	---	---	---	---	---	---	---	A	A	A	A	A	A	---	---

Test engineer: Sun. Zhang



8.6. Test Photographs

27V2Q



27V2H

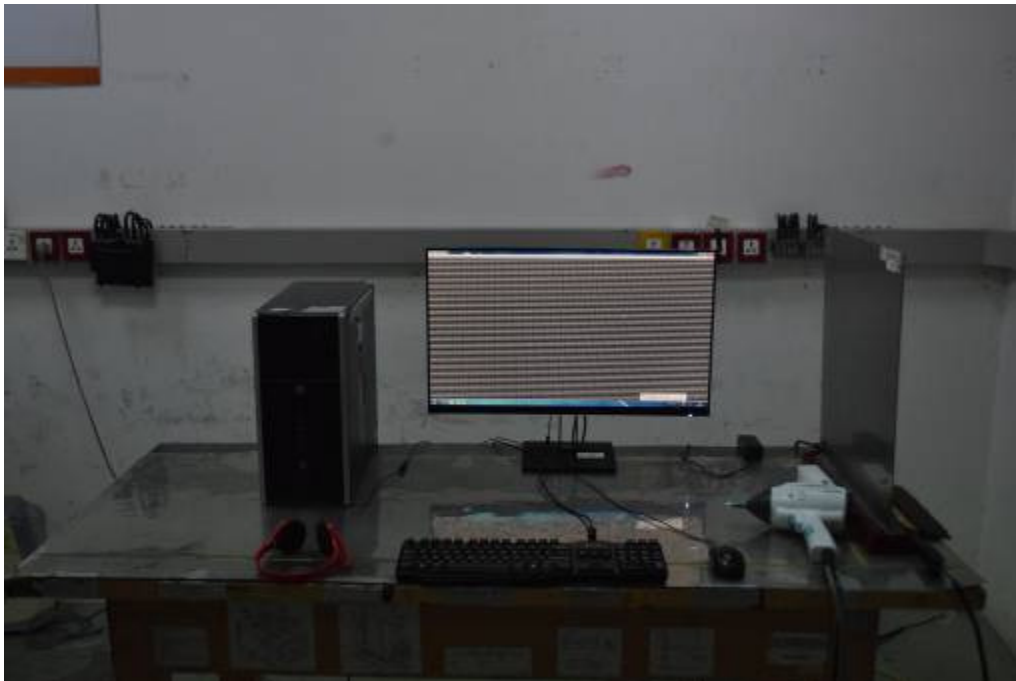



9. Radio Frequency electromagnetic field immunity test

9.1. Test Procedure

- a. The equipment to be tested is placed in the center of the enclosure on a wooden table. The equipment is then connected to power and signal leads according to pertinent installation instructions.
- b. The antenna which is enabling the complete frequency range of 80-1000 MHz is placed 3m away from the equipment. The required field strength is determined by placing the field strength meter(s) on top of or directly alongside the equipment under test and monitoring the field strength meter via a remote field strength indicator outside the enclosure while adjusting the continuous-wave to the applicable antennae.
- c. The test is normally performed with the antenna facing the most sensitive side of the EUT. The polarization of the field generated by the bucolical antenna necessitates testing each position twice, once with the antenna positioned vertically and again with the antenna positioned horizontally. The circular polarization of the field from the log-spiral antenna makes a change of position of the antenna unnecessary.
- d. At each of the above conditions, the frequency range is swept 80-1000 MHz, pausing to adjust the R.F. signal level or to switch oscillators and antenna. The rate of sweep is in the order of $1.5 \cdot 10^{-3}$ decades/s. The sensitive frequencies or frequencies of dominant interest may be discretely analyzed.

9.2. Test Severity Levels

Frequency Band : 80-1000 MHz	
Level	Test field strength (V/m)
1	1
2	3
3	10
X	Specified
Remark: "X" is an open class.	

9.3. TEST SETUP

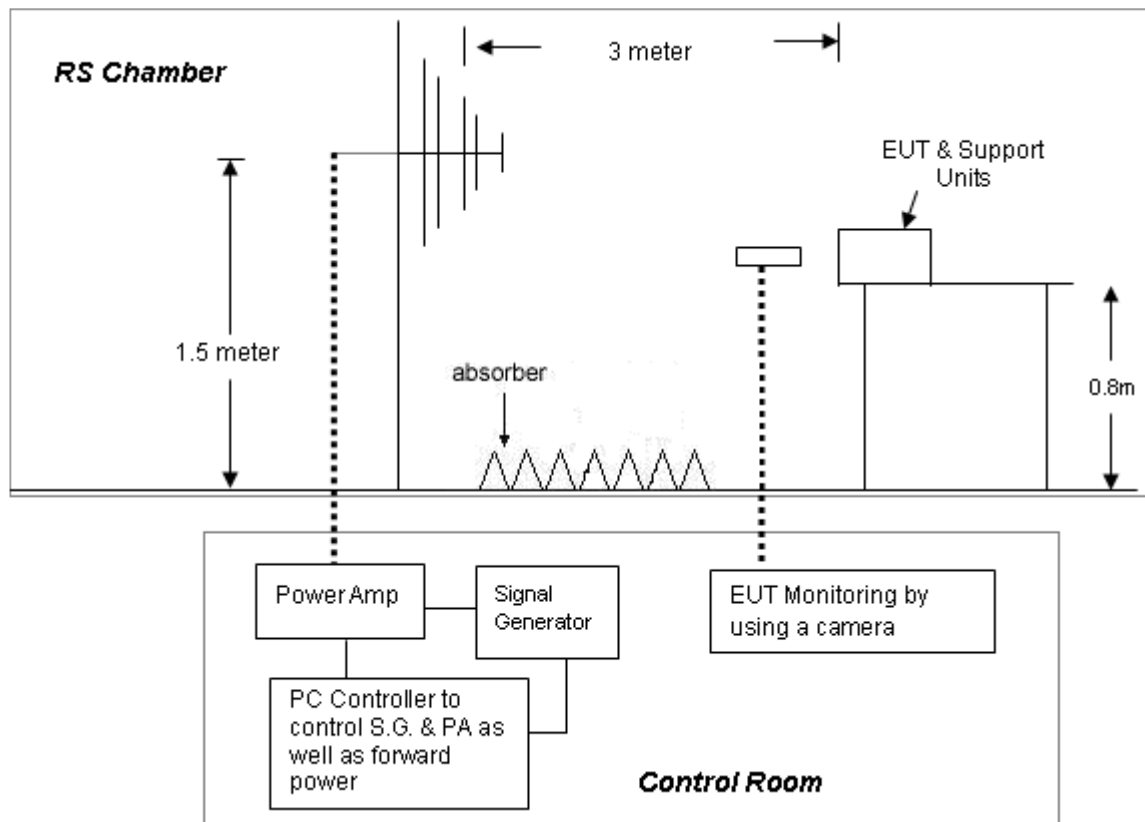

- For the actual test configuration, please refer to the related item – Photographs of the Test Configuration.

NOTE:

TABLETOP EQUIPMENT

The EUT installed in a representative system as described in section 7 of IEC 61000-4-3 was placed on a non-conductive table 0.8 meters in height. The system under test was connected to the power and signal wire according to relevant installation instructions.

FLOOR STANDING EQUIPMENT

The EUT installed in a representative system as described in section 7 of IEC 61000-4-3 was placed on a non-conductive wood support 0.1 meters in height. The system under test was connected to the power and signal wire according to relevant installation instructions.



9.4. Measurement equipment

Instrument/Ancillary	Manufacturer	Model No.	Serial No.	Calibration Date	Valid Date.
Signal Generator	R&S	SML03	103287	2018.03.21	2019.03.20
Power Sensor	R&S	NR P-Z91	100383	2018.03.21	2019.03.20
Power Meter	R&S	NRP	101206	2018.03.21	2019.03.20
Power Amplifier	BONN	BLWA0830-16 0/100/40D	076659	2018.03.21	2019.03.20
Istropic Electric Field Probe	EST.LINDGRE N	HI-6105	137445	2018.01.17	2019.01.16
EMS Antenna	R&S	HL046E	100028	N/A	N/A
Temperature/ Humidity Meter	feiyang	N/A	101	2018.03.23	2019.03.22
EMC-32	Rohde&Schwa rz	Ver 6.10.0	N/A	N/A	N/A



9.5. Test Result and Data

27V2Q

Basic Standard	: IEC 61000-4-3
Final Test Result	: PASS
Model No.	: 27V2Q
Pass performance criteria	: A
Frequency Range	: 80~1000 MHz
Temperature	: 22°C
Relative Humidity	: 53%
Atmospheric Pressure	: 100 kPa
Test Date	: Apr 09, 2018

Test Mode : Mode 1,2

Modulation : AM 80% , 1KHz sine wave , Dwell time: 3.0 S				
Frequency Step Size : 1 % of preceding frequency value				
Frequency (MHz)	Antenna Polarization	face	Field strength (V/m)	Result
80~1000	Vertical	Front	3 V/m	A
80~1000	Vertical	Rear	3 V/m	A
80~1000	Vertical	Left	3 V/m	A
80~1000	Vertical	Right	3 V/m	A
80~1000	Horizontal	Front	3 V/m	A
80~1000	Horizontal	Rear	3 V/m	A
80~1000	Horizontal	Left	3 V/m	A
80~1000	Horizontal	Right	3 V/m	A



27V2H

Basic Standard : IEC 61000-4-3
 Final Test Result : PASS
 Model No. : 27V2H
 Pass performance criteria : A
 Frequency Range : 80~1000 MHz
 Temperature : 22°C
 Relative Humidity : 53%
 Atmospheric Pressure : 100 kPa
 Test Date : Apr 09, 2018

Test Mode : Mode 1,2

Modulation : AM 80% , 1KHz sine wave , Dwell time: 3.0 S				
Frequency Step Size : 1 % of preceding frequency value				
Frequency (MHz)	Antenna Polarization	face	Field strength (V/m)	Result
80~1000	Vertical	Front	3 V/m	A
80~1000	Vertical	Rear	3 V/m	A
80~1000	Vertical	Left	3 V/m	A
80~1000	Vertical	Right	3 V/m	A
80~1000	Horizontal	Front	3 V/m	A
80~1000	Horizontal	Rear	3 V/m	A
80~1000	Horizontal	Left	3 V/m	A
80~1000	Horizontal	Right	3 V/m	A

Test engineer: Sun. Zhang



9.6. Test Photographs

27V2Q



27V2H





10. Electrical Fast Transient/ Burst Immunity Test

10.1. Test Procedure

- a. In order to minimize the effect of environmental parameters on test results, the climatic conditions when test is carrying out shall comply with the following requirements:
 - ✧ ambient temperature: 15°C to 35°C;
 - ✧ relative humidity : 45% to 75%;
 - ✧ Atmospheric pressure: 86 Kpa (860 mbar) to 106 Kpa (1060 mbar).
- b. In order to minimize the effect of environmental parameters on test results, the electromagnetic environment of the laboratory shall not influence the test results.
- c. The variety and diversity of equipment and systems to be tested make it difficult to establish general criteria for the evaluation of the effects of fast transients/bursts on equipment and systems.
- d. Test on Power Line:
 - ✧ The EFT/B-generator was located on the GRP.
 - For floor standing equipment 1,0 m
 - For table top equipment 0,5 m
 - ✧ The EFT/B-generator provides the ability to apply the test voltage in a non-symmetrical condition to the power supply input terminals of the EUT.
- e. Test on Communication Lines
 - ✧ The coupling clamp is composed of a clamp unit for housing the cable (length more than 3 m), and was placed on the GRP.
 - ✧ The coupling clamp provides the ability of coupling the fast transient/bursts to the cable under test.
- f. The test results may be classified on the basic of the operating conditions and the functional specification of the equipment under test, according to the following performance criteria :
 - ✧ Normal performance within the specification limits.
 - ✧ Temporary degradation or loss of function or performance which is self-recoverable.
 - ✧ Temporary degradation or loss of function or performance which requires operator intervention or system reset.
 - ✧ Degradation or loss of function which is not recoverable due to damage of equipment (components).

10.2. Test Severity Levels

The following test severity levels are recommended for the fast transient/burst test :

Open circuit output test voltage $\pm 10\%$		
Level	On Power Supply	On I/O signal, data and control line
1	0.5 KV	0.25 KV
2	1.0 KV	0.50 KV
3	2.0 KV	1.00 KV
4	4.0 KV	2.00 KV
X	Specified	Specified

Remark : “ X ” is an open level. The level is subject to negotiation between the user and manufacturer or is specified by the manufacturer.

10.3. TEST SETUP

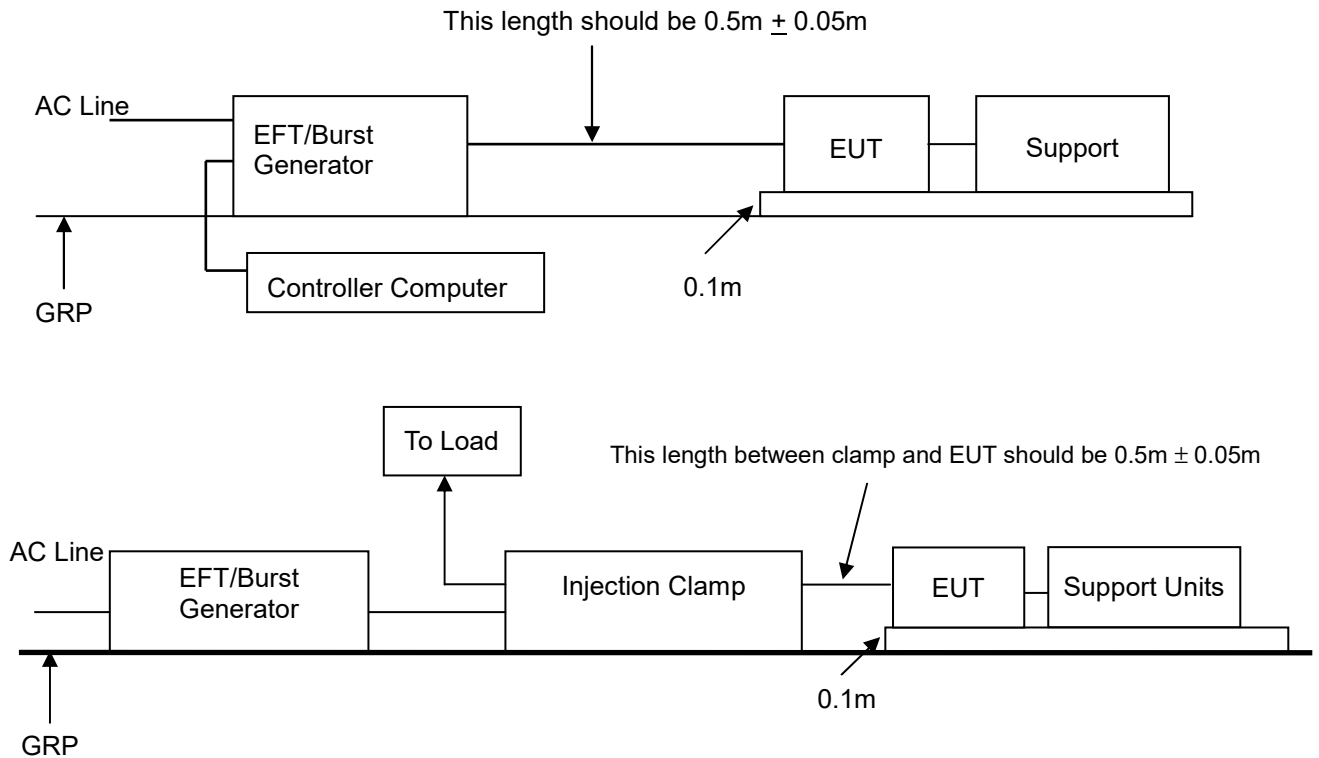

- For the actual test configuration, please refer to the related item – Photographs of the Test Configuration.

NOTE:

TABLETOP EQUIPMENT

The configuration consisted of a wooden table (0.1m high) standing on the Ground Reference Plane. The GRP consisted of a sheet of aluminum (at least 0.25mm thick and 2.5m square) connected to the protective grounding system. A minimum distance of 0.5m was provided between the EUT and the walls of the laboratory or any other metallic structure.

FLOOR STANDING EQUIPMENT

The EUT installed in a representative system as described in section 7 of IEC 61000-4-4 and its cables, were isolated from the Ground Reference Plane by an insulating support that is 0.1-meter thick. The GRP consisted of a sheet of aluminum (at least 0.25mm thick and 2.5m square) connected to the protective grounding system.

10.4. Measurement equipment

Instrument/Ancillary	Manufacturer	Model No.	Serial No.	Calibration Date	Valid Date.
TRANSIENT	EMCPARTNER	TRA2000IN6	901	2017.06.21	2018.06.20
CDN	EMCPARTNER	CDN2000-06-32	121	2018.03.21	2019.03.20
Coupling clamp	EMCPARTNER	CN-EFT1000	547	2018.03.21	2019.03.20
Temperature/ Humidity Meter	Zhicheng	ZC1-11	CEP-TH-005	2018.03.23	2019.03.22



10.5. Test Result and Data

27V2Q

- Basic Standard : IEC 61000-4-4
- Final Test Result : PASS
- Model No. : 27V2Q
- Pass performance criteria : B
- Test Voltage : On Power Supply -- ± 1.0 kV
On I/O signal, data and control line -- ± 0.5 kV
- Temperature : 22°C
- Relative Humidity : 55 %
- Atmospheric Pressure : 100 kPa
- Test Date : Apr 09, 2018

Test Mode : Mode 1,2

Pulse : 5/50 ns		Repetition Rate: <u>5 kHz</u>			
Burst : 15m/300ms					
Test time : 1 min/each condition					
Voltage/ Mode/ Polarity/ Result/ Phase		<u>0.5 kV</u>		<u>1.0 kV</u>	
		+	-	+	-
Power Line	L	---	---	A	A
	N	---	---	A	A
	L-N	---	---	A	A

**27V2H**

Basic Standard : IEC 61000-4-4
Final Test Result : PASS
Model No. : 27V2H
Pass performance criteria : B
Test Voltage : On Power Supply -- ± 1.0 kV
On I/O signal, data and control line -- ± 0.5 kV
Temperature : 22°C
Relative Humidity : 55 %
Atmospheric Pressure : 100 kPa
Test Date : Apr 09, 2018

Test Mode : Mode 1,2

Pulse : 5/50 ns		Repetition Rate: <u>5 kHz</u>			
Burst : 15m/300ms					
Test time : 1 min/each condition					
Voltage/ Mode/ Polarity/ Result/ Phase		<u>0.5 kV</u>		<u>1.0 kV</u>	
		+	-	+	-
Power Line	L	---	---	A	A
	N	---	---	A	A
	L-N	---	---	A	A

Test engineer: _____



10.6. Test Photographs

27V2Q



27V2H





11. Surge Immunity Test

11.1. Test Procedure

- a. Climatic conditions
The climatic conditions shall comply with the following requirements :
 - ✧ ambient temperature : 15 °C to 35 °C
 - ✧ relative humidity : 10 % to 75 %
 - ✧ atmospheric pressure : 86 kPa to 106 kPa (860 mbar to 1060 mbar)
- b. Electromagnetic conditions
the electromagnetic environment of the laboratory shall not influence the test results.
- c. The test shall be performed according the test plan that shall specify the test set-up with
 - ✧ generator and other equipment utilized;
 - ✧ test level (voltage/current);
 - ✧ generator source impedance;
 - ✧ internal or external generator trigger;
 - ✧ number of tests : at least five positive and five negative at the selected points;
 - ✧ repetition rate : maximum 1/min.
 - ✧ inputs and outputs to be tested;
 - ✧ representative operating conditions of the EUT;
 - ✧ sequence of application of the surge to the circuit;
 - ✧ phase angle in the case of AC. power supply;
 - ✧ actual installation conditions, for example :
 - AC : neutral earthed,
 - DC : (+) or (-) earthed to simulated the actual earthing conditions.
- d. If not otherwise specified the surges have to be applied synchronized to the voltage phase at the zero-crossing and the peak value of the AC. voltage wave (positive and negative).
- e. The surges have to be applied line to line and line(s) and earth. When testing line to earth, the test voltage has to be applied successively between each of the lines and earth, if there is no other specification.
- f. The test procedure shall also consider the non-linear current-voltage characteristics of the equipment under test. Therefore the test voltage has to be increased by steps up to the test level specified in the product standard or test plan.
- g. All lower levels including the selected test level shall be satisfied. For testing the secondary protection, the output voltage of the generator shall be increased up to the worst-case voltage breakdown level (let-through level) of the primary protection.
- h. If the actual operating signal sources are not available, that may be simulated. Under no circumstances may the test level exceed the product specification. The test shall be carried out according to a test plan.
- i. To find all critical points of the duty cycle of the equipment, a sufficient number of positive and negative test pulses shall be applied. For acceptance test previously unstressed equipment shall be used to the protection devices shall be replaced.

11.2. Test Severity Level

Level	Open-circuit test voltage, $\pm 10\%$, KV
1	0.5
2	1.0
3	2.0
4	4.0
X	Specified

NOTE: "X" is an open class. This level can be specified in the product specification.



11.3. TEST SETUP

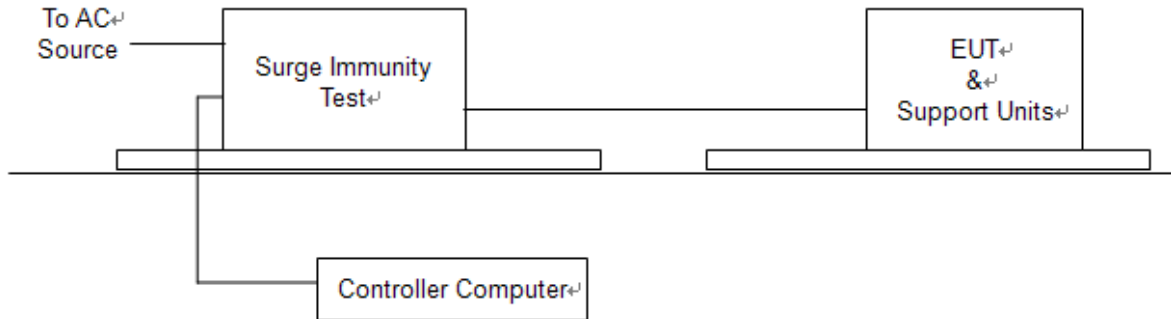

For the actual test configuration, please refer to the related item – Photographs of the Test Configuration.

11.4. Measurement equipment

Instrument/Ancillary	Manufacturer	Model No.	Serial No.	Calibration Date	Valid Date.
TRANSIENT	TESEQ	NSG 3060	1830	2018.02.07	2019.02.06
CDN	TESEQ	CDN 3061	1575	2018.02.07	2019.02.06
CDN	TESEQ	CNV508T5	P 1546167499	2018.02.07	2019.02.06
CDN	TESEQ	CDN HSS-2	41020	2018.02.07	2019.02.06
Temperature/ Humidity Meter	Zhicheng	ZC1-11	CEP-TH-005	2018.03.23	2019.03.22



11.6. Test Photographs

27V2Q



27V2H





12. Conduction Disturbances induced by Radio-Frequency Fields

12.1. Test Procedure

- a. The EUT shall be operated within its intended climatic conditions. The temperature and relative humidity should be recorded.
- b. This test method test can be performed without using a sell shielded enclosure. This is because the disturbance levels applied and the geometry of the setups are not likely to radiated a high amount of energy, especially at the lower frequencies. If under certain circumstances the radiated energy is too high, a shielded enclosure has to be used.
- c. The test shall be performed with the test generator connected to each of the coupling and decoupling devices in turn while the other non-excited RF-input ports of the coupling devices are terminated by a 50 ohm load resistor.
- d. The frequency range is swept from 150 KHz to 80 MHz, using the signal levels established during the setting process, and with the disturbance signal 80% amplitude modulated with a 1KHz sign wave, pausing to adjust the RF-signal level or to switch coupling devices as necessary. The rate of sweep shall no exceed 1.5×10^{-3} decades/s. Where the frequency is swept incrementally, the step size shall no exceed 1% of the start and thereafter 1% of the preceding frequency value.
- e. The dwell time at each frequency shall not be less than the time necessary for the EUT to be exercised, and able to respond. Sensitive frequencies e.g. clock frequency (ies) and harmonics or frequencies of dominant interest shall be analyzed separately.
- f. An alternative test procedure may be adopted, wherein the frequency range is swept incrementally, with a step size not exceeding 4% of the start ad thereafter 4% of the preceding frequency value. The test level should be at least twice the value of the specified test level.
- g. In cases of dispute, the test procedure using a step size not exceeding 1% of the start and thereafter 1% of preceding frequency value shall take precedence.
- h. Attempts should be made to fully exercise the EUT during testing, and to fully interrogate all exercise modes selected for susceptibility.
- i. The use of special exercising programs is recommended.
- j. Testing shall be performed according to a Test Plan, which shall be included in the test report.
 - a. It may be necessary to carry out some investigatory testing in order to establish some aspects of the test plan.

12.2. Test Severity Levels

Level	Voltage Level (e.m.f.)
1	1 V
2	3 V
3	10 V
x	Specified
NOTE - x is an open class. This level can be specified in the product specification.	

12.3. TEST SETUP

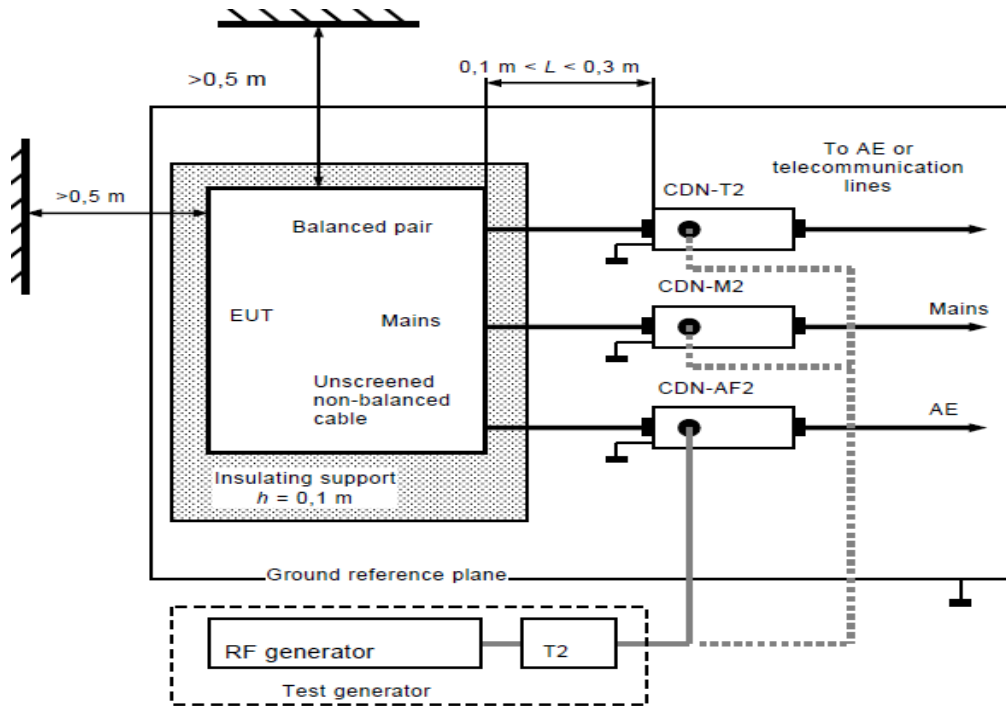

- Note:**
1. The EUT is setup 0.1m above Ground Reference Plane
 2. The CDNs and / or EM clamp used for real test depends on ports and cables configuration of EUT.
 3. For the actual test configuration, please refer to the related item – Photographs of the Test Configuration.

12.4. Measurement equipment

Instrument/Ancillary	Manufacturer	Model No.	Serial No.	Calibration Date	Valid Date.
Conducted immunity test system	FRANKONIA	CIT-10/75	102D1294	2018.03.21	2019.03.20
EM Injection clamp	FCC	F-203I-23MM	536	2018.03.21	2019.03.20
CDN	FRANKONIA	CDN-M2+M3	A3011102	2018.03.21	2019.03.20
CDN	FCC	CDN-M5/32	A3013024	2018.03.21	2019.03.20
CDN	TESEQ	CDN T8-10	43767	2017.08.26	2018.08.25
CDN	TESEQ	CDN T2-10	43762	2017.08.26	2018.08.25
CDN	TESEQ	CDN T4-10	43754	2017.08.26	2018.08.25
CDN	TESEQ	CDN M016	44025	2017.08.26	2018.08.25
6 dB Attenuator	FRANKONIA	N/A	N/A	2018.03.21	2019.03.20
Temperature/ Humidity Meter	Zhicheng	ZC1-11	CEP-TH-005	2018.03.23	2019.03.22
EN61000-4-6	Hubert GmbH	Ver 2.21	N/A	N/A	N/A



27V2H

Basic Standard : IEC 61000-4-6
 Final Test Result : PASS
 Model No. : 27V2H
 Pass performance criteria : A
 Coupling mode : CDN-(M2+M3) for AC power ports
 : CDN-T4 for signal ports
 : EM-Clamp for signal ports
 Temperature : 22°C
 Relative Humidity : 55 %
 Atmospheric Pressure : 100 kPa
 Test Date : Apr 09, 2018

Test Mode : Mode 1,2

Frequency : 0.15~80MHz, Modulation : AM 80%,1KHz sine wave, Dwell time:3.0s			
Frequency Step Size : 1 % of preceding frequency value			
Frequency	Test mode	Voltage(V)	Result
0.15 ~ 80MHz	Power(M2)	3	A

Test engineer: Sun. Zhang



12.6. Test Photographs

27V2Q



27V2H



13. Power Frequency Magnetic Field Immunity Tests

13.1. Test Setup

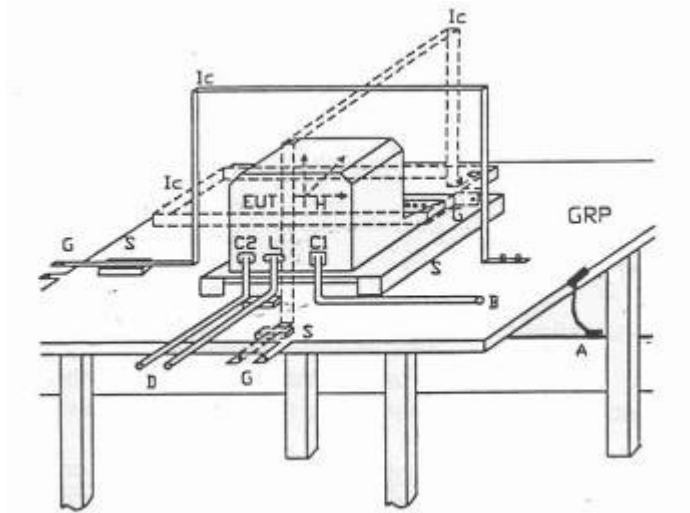

- | | | | |
|-----|------------------------|----|-------------------------------|
| GPR | : Ground plane | C1 | : Power supply circuit |
| A | : Safety earth | C2 | : Signal circuit |
| S | : Insulating support | L | : Communication line |
| EUT | : Equipment under test | B | : To power supply source |
| Lc | : Induction coil | D | : To signal source, simulator |
| E | : Earth terminal | G | : To the test generator |

13.2. Test Severity Levels

Level	Magnetic field strength (A/m)
1	1
2	3
3	10
4	30
5	100
X ¹⁾	special

NOTE 1 "X" is an open level. This level can be given in the product specification.

13.3. Measurement equipment

Instrument/Ancillary	Manufacturer	Model No.	Serial No.	Calibration Date	Valid Date.
TRANSIENT	EMCPARTNER	TRA2000IN6	901	2017.06.21	2018.06.20
H-Filed-Loop	EMCPARTNER	MF1000-1	144	2018.03.21	2019.03.20
Temperature/ Humidity Meter	Zhicheng	ZC1-11	CEP-TH-005	2018.03.23	2019.03.22



13.4. Test Result and Data

27V2Q

Basic Standard : IEC 61000-4-8
Final Test Result : PASS
Model No. : 27V2Q
Pass performance criteria : A
Temperature : 22°C
Relative Humidity : 55 %
Atmospheric Pressure : 100 kPa
Test Date : Apr 09, 2018

Test Mode : Mode 1,2

Power Frequency Magnetic Field : <u>50</u> Hz, <u>1</u> A/m		
Coil Orientation	Testing duration	Results
X-axis	1.0 Min	A
Y-axis	1.0 Min	A
Z-axis	1.0 Min	A
Power Frequency Magnetic Field : <u>60</u> Hz, <u>1</u> A/m		
Coil Orientation	Testing duration	Results
X-axis	1.0 Min	A
Y-axis	1.0 Min	A
Z-axis	1.0 Min	A



27V2H

Basic Standard : IEC 61000-4-8
Final Test Result : PASS
Model No. : 27V2H
Pass performance criteria : A
Temperature : 22°C
Relative Humidity : 55 %
Atmospheric Pressure : 100 kPa
Test Date : Apr 09, 2018

Test Mode : Mode 1,2

Power Frequency Magnetic Field : <u>50</u> Hz, <u>1</u> A/m		
Coil Orientation	Testing duration	Results
X-axis	1.0 Min	A
Y-axis	1.0 Min	A
Z-axis	1.0 Min	A
Power Frequency Magnetic Field : <u>60</u> Hz, <u>1</u> A/m		
Coil Orientation	Testing duration	Results
X-axis	1.0 Min	A
Y-axis	1.0 Min	A
Z-axis	1.0 Min	A

Test engineer: Sun. Zhang



13.5. Test Photographs

27V2Q

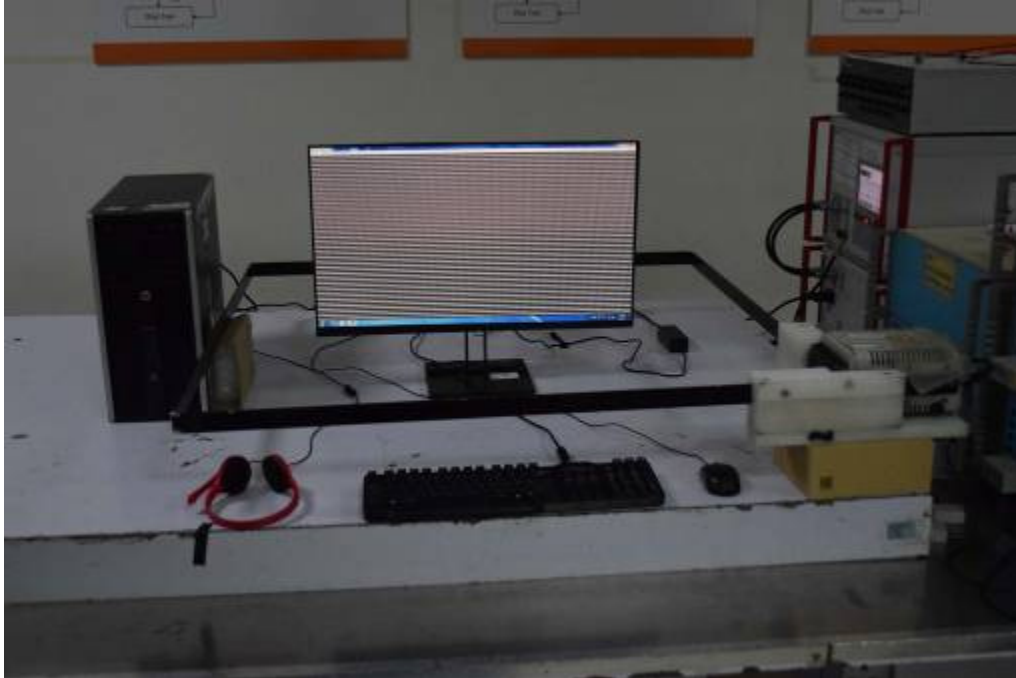

27V2H

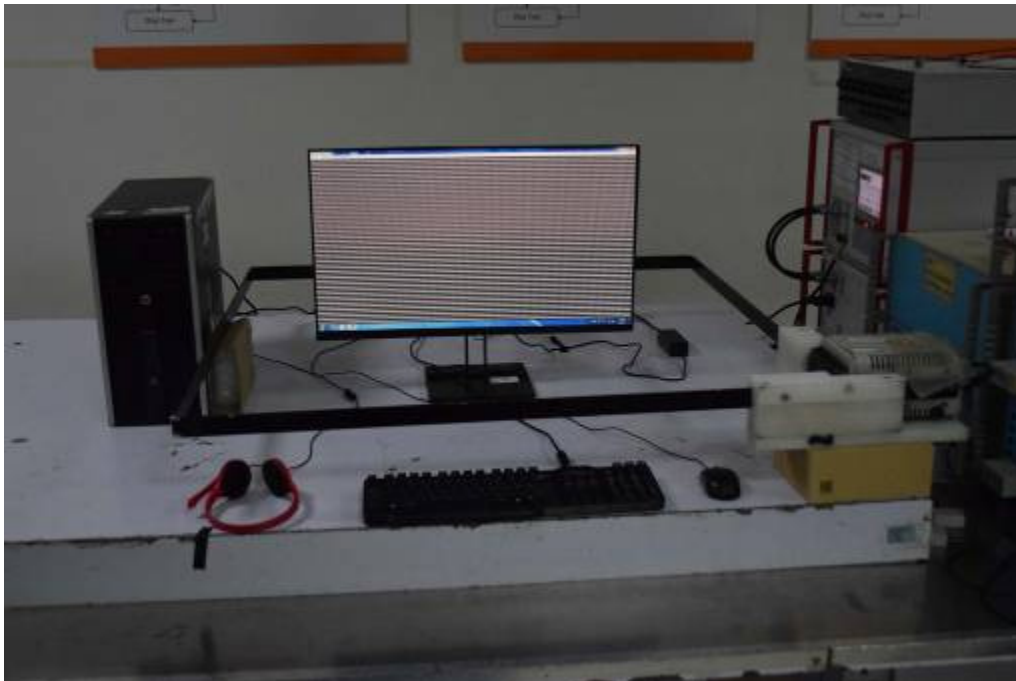



14. Voltage Dips and Voltage Interruptions Immunity Test Setup

14.1. Test Conditions

1. Source voltage and frequency : AC 100/230/240V / 50Hz, Single phase.
2. Test of interval : 10 sec.
3. Level and duration : Sequence of 3 dips/interrupts.
4. Voltage rise (and fall) time : 1 ~ 5 μ s.
5. Test severity :

Voltage dips and Interrupt reduction (%)	Test Duration (period)
>95%	250
30%	25
>95%	0.5

14.2. TEST SETUP

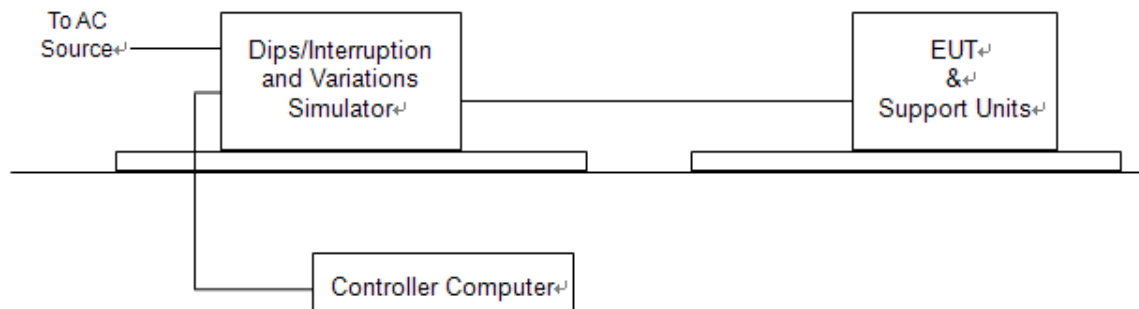

For the actual test configuration, please refer to the related item – Photographs of the Test Configuration.

14.3. Measurement equipment

Instrument/Ancillary	Manufacturer	Model No.	Serial No.	Calibration Date	Valid Date.
TRANSIENT	EMCPARTNER	TRA2000IN6	901	2017.06.21	2018.06.20
Temperature/ Humidity Meter	Zhicheng	ZC1-11	CEP-TH-005	2018.03.23	2019.03.22



14.4. Test Result and Data

27V2Q

Basic Standard : IEC 61000-4-11
 Final Test Result : PASS
 Model No. : 27V2Q
 Pass performance Criteria : C for voltage interruption, B for voltage dips
 Temperature : 22°C
 Relative Humidity : 55 %
 Atmospheric Pressure : 100 kPa
 Test Date : Apr 09, 2018

Test Mode : Mode 1,2										
Voltage(UT): AC 230 V/240V 50 Hz Interval(s) : 10s Times : 3										
Test mod	Test level UT %	Durations (period / ms)	Phase / Result							
			0	45	90	135	180	225	270	315
Voltage interruptions	>95%	250	C	C	C	C	C	C	C	C
Voltage dips	30%	25	B	B	B	B	B	B	B	B
	>95%	0.5	B	B	B	B	B	B	B	B

Test Mode : Mode 1,2										
Voltage(UT): AC 100 V 50 Hz Interval(s) : 10s Times : 3										
Test mod	Test level UT %	Durations (period / ms)	Phase / Result							
			0	45	90	135	180	225	270	315
Voltage interruptions	>95%	250	C	C	C	C	C	C	C	C
Voltage dips	30%	25	B	B	B	B	B	B	B	B
	>95%	0.5	B	B	B	B	B	B	B	B



27V2H

Basic Standard : IEC 61000-4-11
 Final Test Result : PASS
 Model No. : 27V2H
 Pass performance Criteria : C for voltage interruption, B for voltage dips
 Temperature : 22°C
 Relative Humidity : 55 %
 Atmospheric Pressure : 100 kPa
 Test Date : Apr 09, 2018

Test Mode : Mode 1,2										
Voltage(UT): AC 230 V/240V 50 Hz Interval(s) : 10s Times : 3										
Test mod	Test level UT %	Durations (period / ms)	Phase / Result							
			0	45	90	135	180	225	270	315
Voltage interruptions	>95%	250	C	C	C	C	C	C	C	C
Voltage dips	30%	25	B	B	B	B	B	B	B	B
	>95%	0.5	B	B	B	B	B	B	B	B

Test Mode : Mode 1,2										
Voltage(UT): AC 100 V 50 Hz Interval(s) : 10s Times : 3										
Test mod	Test level UT %	Durations (period / ms)	Phase / Result							
			0	45	90	135	180	225	270	315
Voltage interruptions	>95%	250	C	C	C	C	C	C	C	C
Voltage dips	30%	25	B	B	B	B	B	B	B	B
	>95%	0.5	B	B	B	B	B	B	B	B

Test engineer: Sun. Zhang



14.5. Test Photographs

27V2Q



27V2H

