



# EMC TEST REPORT

Authorized under Declaration of Conformity

According to

- |                        |                                      |
|------------------------|--------------------------------------|
| EN 55032: 2012+AC 2013 | EN 55024 : 2010                      |
| EN 61000-3-2 : 2014    | IEC 61000-4-2 : 2008                 |
| EN 61000-3-3 : 2013    | IEC 61000-4-3 : 2006+A1:2007+A2:2010 |
| CISPR 32 : 2015        | IEC 61000-4-4 : 2012                 |
| AS/NZS CISPR 32 : 2013 | IEC 61000-4-5 : 2014                 |
|                        | IEC 61000-4-6 : 2013                 |
|                        | IEC 61000-4-8 : 2009                 |
|                        | IEC 61000-4-11 : 2004                |

Applicant : TPV Electronics (Fujian) Co., Ltd.  
Address : Rongqiao Economic and Technological  
Development Zone, Fuqing City, Fujian Province,  
P.R. China  
Equipment : LCD Monitor  
350LM00005; \*\*352U\*\*\*\*  
Model No. : The "\*" could be any alphanumeric character  
including blank for marketing differentiation.

## I HEREBY CERTIFY THAT :

The sample was received on Jun 26, 2017 and the testing was carried out on Jun 29, 2017 at CerpPASS Technology Corp. The test result refers exclusively to the test presented test model / sample. Without written approval of CerpPASS Technology Corp., the test report shall not be reproduced except in full.



# EMC TEST REPORT

Issued by:

**CerpPASS Technology (Suzhou) Co.,Ltd**

**No.66,Tangzhuang Road, Suzhou Industrial Park, Jiangsu 215006, China**

**Tel:86-512-6917-5888**

**Fax:86-512-6917-5666**

The test record, data evaluation & Equipment Under Test configurations represented herein are true and accurate accounts of the measurements of the samples EMC characteristics under the conditions specified in this report.

The above equipment was tested by CerpPASS Technology Corp. for compliance with the requirements of technical standards specified above under the EMC Directive. The results of testing in this report apply only to the product/system, which was tested. Other similar equipment will not necessarily produce the same results due to production tolerance and measurement uncertainties

Approved by:

Miro Chueh  
EMC/RF B.U. Manager

### Laboratory Accreditation:

CerpPASS Technology Corporation Test Laboratory

<b>TAF LAB Code:</b>	<b>1439</b>
----------------------	-------------

CerpPASS Technology(SuZhou) Co., Ltd.

<b>NVLAP LAB Code:</b>	<b>200814-0</b>
<b>CNAS LAB Code:</b>	<b>L5515</b>



## Contents

<b>1. Summary of Test Procedure and Test Results</b>	<b>6</b>
<b>2. Immunity Testing Performance Criteria Definition</b>	<b>8</b>
<b>3. Test Configuration of Equipment under Test</b>	<b>9</b>
3.1. Feature of Equipment under Test	9
3.2. Test Manner	11
3.3. Description of Support Unit	14
3.4. General Information of Test	15
3.5. Measurement Uncertainty	16
<b>4. Test of Conducted Emission</b>	<b>18</b>
4.1. Test Limit	18
4.2. Test Procedures	21
4.3. Typical Test Setup	21
4.4. Measurement Equipment	22
4.5. Test Result and Data	23
4.6. Test Photographs of Power Port	40
<b>5. Test of Radiated Emission</b>	<b>42</b>
5.1. Test Limit	42
5.2. Test Procedures	45
5.3. Typical Test Setup	45
5.4. Measurement Equipment	46
5.5. Test Result and Data (30MHz ~ 1GHz)	47
5.6. Test Result and Data (1GHz ~ 6GHz)	63
5.7. Test Photographs (30MHz~1GHz)	79
5.8. Test Photographs (1GHz~6GHz)	81
<b>6. Harmonics Test</b>	<b>83</b>
6.1. Limits of Harmonics Current Measurement	83
6.2. Measurement Equipment	84
6.3. Test Result and Data	85
6.4. Test Photographs	89
<b>7. Voltage Fluctuations Test</b>	<b>90</b>
7.1. Test Procedure	90
7.2. Measurement Equipment	90
7.3. Test Result and Data	91
7.4. Test Photographs	95
<b>8. Electrostatic Discharge Immunity Test</b>	<b>96</b>
8.1. Test Procedure	96
8.2. Test Setup for Tests Performed in Laboratory	97
8.3. Test Severity Levels	98
8.4. Measurement Equipment	98
8.5. Test Result and Data	99
8.6. Test Photographs	101
<b>9. Radio Frequency electromagnetic field immunity test</b>	<b>102</b>



- 9.1. Test Procedure ..... 102
- 9.2. Test Severity Levels ..... 102
- 9.3. TEST SETUP ..... 103
- 9.4. Measurement Equipment..... 104
- 9.5. Test Result and Data..... 105
- 9.6. Test Photographs ..... 107
- 10. Electrical Fast Transient/ Burst Immunity Test ..... 108**
  - 10.1. Test Procedure ..... 108
  - 10.2. Test Severity Levels ..... 108
  - 10.3. TEST SETUP ..... 109
  - 10.4. Measurement Equipment..... 109
  - 10.5. Test Result and Data..... 110
  - 10.6. Test Photographs ..... 111
- 11. Surge Immunity Test..... 112**
  - 11.1. Test Procedure ..... 112
  - 11.2. Test Severity Level ..... 112
  - 11.3. TEST SETUP ..... 113
  - 11.4. Measurement Equipment..... 113
  - 11.5. Test Result and Data..... 114
  - 11.6. Test Photographs ..... 116
- 12. Conduction Disturbances induced by Radio-Frequency Fields ..... 117**
  - 12.1. Test Procedure ..... 117
  - 12.2. Test Severity Levels ..... 117
  - 12.3. TEST SETUP ..... 118
  - 12.4. Measurement Equipment..... 118
  - 12.5. Test Result and Data..... 119
  - 12.6. Test Photographs ..... 121
- 13. Power Frequency Magnetic Field Immunity Test..... 122**
  - 13.1. Test Setup ..... 122
  - 13.2. Test Severity Levels ..... 122
  - 13.3. Measurement Equipment..... 122
  - 13.4. Test Result and Data..... 123
  - 13.5. Test Photographs ..... 125
- 14. Voltage Dips and Voltage Interruptions Immunity Test Setup ..... 126**
  - 14.1. Test Conditions..... 126
  - 14.2. TEST SETUP ..... 126
  - 14.3. Measurement Equipment..... 126
  - 14.4. Test Result and Data..... 127
  - 14.5. Test Photographs ..... 129
- 15. Photographs of EUT ..... 130**



### History of this test report

ORIGINAL.

Additional attachment as following record:

Report No	Version	Date	Description
SECE1611248	Rev 01	Dec 16, 2016	Initial Issue
SECE1611248-D	Rev 02	Jul 01, 2017	Second edition(1.Add a adapter:ADPC2090)



## 1. Summary of Test Procedure and Test Results

Second edition:

EMISSION [ EN55032 ]			
Standard	Item	Result	Remarks
EN55032: 2012+AC 2013 AS/NZS CISPR 32 : 2013 CISPR 32 : 2015	Conducted (Power Port)	PASS	Meet Class B Limit Minimum passing margin(QP) is -5.12 dB at 0.6020MHz
	Conducted (Telecom port)	N/A	N/A
	Radiated	PASS	Meets Class B Limit Minimum passing margin(Peak) is -4.31dB at 718.7000MHz
EN 61000-3-2: 2014	Harmonic current emissions	PASS	Meet Class D Limit
EN61000-3-3:2013	Voltage fluctuations & flicker	PASS	Meets the requirements

IMMUNITY [EN 55024:2010]			
Standard	Item	Result	Remarks
IEC 61000-4-2: 2008	ESD	PASS	Meets the requirements of Performance Criterion A
IEC 61000-4-3: 2006+A1:2007+A2:2010	RS	PASS	Meets the requirements of Performance Criterion A
IEC 61000-4-4: 2012	EFT	PASS	Meets the requirements of Performance Criterion A
IEC 61000-4-5:2014	Surge	PASS	Meets the requirements of Performance Criterion A
IEC 61000-4-6:2013	CS	PASS	Meets the requirements of Performance Criterion A
IEC 61000-4-8:2009	PFMF	PASS	Meets the requirements of Performance Criterion A
IEC 61000-4-11:2004	Voltage dips & voltage variations	PASS	Meets the requirements of Voltage Dips: 1) >95% reduction Performance Criterion B 2) 30% reduction Performance Criterion B Voltage Interruptions: 1) >95% reduction Performance Criterion C



Original:

EMISSION [ EN55032 ]			
Standard	Item	Result	Remarks
EN55032: 2012+AC 2013 AS/NZS CISPR 32 : 2013 CISPR 32 : 2012	Conducted (Power Port)	PASS	Meet Class B Limit Minimum passing margin(AVG) is-8.29 dB at 0.4500MHz
	Conducted (Telecom port)	N/A	N/A
	Radiated	PASS	Meets Class B Limit Minimum passing margin(QP) is -4.08dB at 595.8100MHz
EN 61000-3-2: 2014	Harmonic current emissions	PASS	Meet Class D Limit
EN61000-3-3:2013	Voltage fluctuations & flicker	PASS	Meets the requirements

IMMUNITY [EN 55024:2010]			
Standard	Item	Result	Remarks
IEC 61000-4-2: 2008	ESD	PASS	Meets the requirements of Performance Criterion A
IEC 61000-4-3: 2006+A1:2007+A2:2010	RS	PASS	Meets the requirements of Performance Criterion A
IEC 61000-4-4: 2012	EFT	PASS	Meets the requirements of Performance Criterion A
IEC 61000-4-5:2014	Surge	PASS	Meets the requirements of Performance Criterion A
IEC 61000-4-6:2013	CS	PASS	Meets the requirements of Performance Criterion A
IEC 61000-4-8:2009	PFMF	PASS	Meets the requirements of Performance Criterion A
IEC 61000-4-11:2004	Voltage dips & voltage variations	PASS	Meets the requirements of Voltage Dips: 1) >95% reduction Performance Criterion B 2) 30% reduction Performance Criterion B Voltage Interruptions: 1) >95% reduction Performance Criterion C



## 2. Immunity Testing Performance Criteria Definition

<b>Criteria A:</b>	The apparatus shall continue to operate as intended without operator intervention. No degradation of performance or loss of function is allowed below a performance level specified by the manufacturer, when the apparatus is used as intended. The performance level may be replaced by a permissible loss of performance. If the manufacturer does not specify the minimum performance level or the permissible performance loss, then either of these may be derived from the product description and documentation, and by what the user may reasonably expect from the equipment if used as intended.
<b>Criteria B:</b>	After test, the apparatus shall continue to operate as intended without operator intervention. No degradation of performance or loss of function is allowed, after the application of the phenomenon below a performance level specified by the manufacturer, when the apparatus is used as intended. The performance level may be replaced by a permissible loss of performance.  During the test, degradation of performance is however allowed. However, no change of operating state if stored data is allowed to persist after the test. If the manufacturer does not specify the minimum performance level or the permissible performance loss, then either of these may be derived from the product description and documentation, and by what the user may reasonably expect from the equipment if used as intended.
<b>Criteria C:</b>	Temporary loss of function is allowed, provided the functions is self-recoverable or can be restored by the operation of controls by the user in accordance with the manufacturer instructions.  Functions, and/or information stored in non-volatile memory, or protected by a battery backup, shall not be lost.





### 3. Test Configuration of Equipment under Test

#### 3.1. Feature of Equipment under Test

Second edition:

<b>Product Name:</b>	LCD Monitor	
<b>Model Name:</b>	350LM00005; **352U**** The “*” could be any alphanumeric character including blank for marketing differentiation.	
<b>Housing material:</b>	Plastic case	
<b>EUT Highest Frequency:</b>	DP: 531.52MHz HDMI: 265.25MHz	
<b>AC Power Cord Type:</b>	Non-shielded, 1.2m&1.5m&1.8m	
<b>Adapter</b>	Model:	ADPC20120
	Input:	100-240V, 1.5A, 50-60Hz
	Output:	20V, 6.0A
<b>*Adapter</b>	Model:	ADPC2090
	Input:	100-240V, 1.3A, 50-60Hz
	Output:	20V, 4.5A

Note: 1) Please refer to user manual.

2) “\*” for the add Adapter

#### I/O PORT:

I/O PORT TYPE	Quantity
1). HDMI Port	1
2). Display Port	1
3). Audio Port	2
4). USB Port	3
5). AC Power Port	1



Original:

<b>Product Name:</b>	LCD Monitor	
<b>Model Name:</b>	350LM00005; **352U**** The “*” could be any alphanumeric character including blank for marketing differentiation.	
<b>Housing material:</b>	Plastic case	
<b>EUT Highest Frequency:</b>	DP: 531.52MHz HDMI: 265.25MHz	
<b>AC Power Cord Type:</b>	Non-shielded, 1.2m&1.5m&1.8m	
<b>Adapter</b>	Model:	ADPC20120
	Input:	100-240V, 1.5A, 50-60Hz
	Output:	20V, 6.0A

Note: Please refer to user manual.

**I/O PORT:**

I/O PORT TYPE	Quantity
6). HDMI Port	1
7). Display Port	1
8). Audio Port	2
9). USB Port	3
10). AC Power Port	1



### 3.2. Test Manner

Second edition:

- a. During testing, the interface cables and equipment positions were varied according to Europe Standard .
- b. An executive program, “MyHwin” under Win 7, which generates a complete line of continuously repeating “H” pattern was used as the test software.  
The program was executed as follows:
  - 1. Turn on the power of all equipment.
  - 2. The EUT reads the test program from the hard disk drive and runs it.
  - 3. PC sends “H” messages to the EUT, and the monitor displays “H” patterns on the screen.
  - 4. Repeat the steps from 2 to 3.
- c. The complete test system included PC, USB Keyboard, USB Mouse, Earphone, HDD and EUT for EMI&EMS test.
- d. The test modes for CE/RE as follow
  - Test Mode 1 Full system (HDMI mode 3440\*1440@50Hz) Signal from PC (230V/50Hz)
  - Test Mode 2 Full system (HDMI mode 1280\*1024@75Hz) Signal from PC (230V/50Hz)
  - Test Mode 3 Full system (HDMI mode 640\*480@60Hz) Signal from PC (230V/50Hz)
  - Test Mode 4 Full system (Display mode 3440\*1440@100Hz) Signal from PC (230V/50Hz)
  - Test Mode 5 Full system (Display mode 1280\*1024@75Hz) Signal from PC (230V/50Hz)
  - Test Mode 6 Full system (Display mode 640\*480@60Hz) Signal from PC (230V/50Hz)
  - Test Mode 7 Full system (1080P from DVD mode) Signal from PC (230V/50Hz)
  - Test Mode 8 Full system (HDMI mode 3440\*1440@50Hz) Signal from PC (110V/60Hz)
  - Test Mode 9 Full system (Display mode 3440\*1440@100Hz) Signal from PC (110V/60Hz)“Test mode 1,4,8,9” were reported as final data.
- e. The test modes for H&F/EMS as follow
  - Test Mode 1 Full system (HDMI mode 3440\*1440@50Hz) Signal from PC
  - Test Mode 2 Full system (HDMI mode 1280\*1024@75Hz) Signal from PC
  - Test Mode 3 Full system (HDMI mode 640\*480@60Hz) Signal from PC
  - Test Mode 4 Full system (Display mode 3440\*1440@100Hz) Signal from PC
  - Test Mode 5 Full system (Display mode 1280\*1024@75Hz) Signal from PC
  - Test Mode 6 Full system (Display mode 640\*480@60Hz) Signal from PC
  - Test Mode 7 Full system (1080P from DVD mode) Signal from PC“Test mode 1,4” were reported as final data.
- f. The maximum operating frequency is above 108MHz, the test frequency range is from 1GHz to 6GHz.



Original:

- g. During testing, the interface cables and equipment positions were varied according to Europe Standard .
- h. An executive program, “MyHwin” under Win 7, which generates a complete line of continuously repeating “H” pattern was used as the test software.

The program was executed as follows:

1. Turn on the power of all equipment.
2. The EUT reads the test program from the hard disk drive and runs it.
3. PC sends “H” messages to the EUT, and the monitor displays “H” patterns on the screen.
4. Repeat the steps from 2 to 3.

- i. The complete test system included PC, USB Keyboard, USB Mouse, Earphone, HDD and EUT for EMI&EMS test.

- j. The test modes for CE/RE as follow

- |              |   |
|--------------|---|
| Test Mode 1  | Full system (HDMI mode 3440*1440@50Hz)(110V/60Hz)     |
| Test Mode 2  | Full system (HDMI mode 1280*1024@75Hz)(110V/60Hz)     |
| Test Mode 3  | Full system (HDMI mode 640*480@60Hz)(110V/60Hz)       |
| Test Mode 4  | Full system (Display mode 3440*1440@100Hz)(110V/60Hz) |
| Test Mode 5  | Full system (Display mode 1280*1024@75Hz)(110V/60Hz)  |
| Test Mode 6  | Full system (Display mode 640*480@60Hz)(110V/60Hz)    |
| Test Mode 7  | Full system (1080P from DVD mode)(110V/60Hz)          |
| Test Mode 8  | Full system (HDMI mode 3440*1440@50Hz)(230V/50Hz)     |
| Test Mode 9  | Full system (HDMI mode 1280*1024@75Hz)(230V/50Hz)     |
| Test Mode 10 | Full system (HDMI mode 640*480@60Hz)(230V/50Hz)       |
| Test Mode 11 | Full system (Display mode 3440*1440@100Hz)(230V/50Hz) |
| Test Mode 12 | Full system (Display mode 1280*1024@75Hz)(230V/50Hz)  |
| Test Mode 13 | Full system (Display mode 640*480@60Hz)(230V/50Hz)    |
| Test Mode 14 | Full system (1080P from DVD mode) (230V/50Hz)         |

“Test mode 1,4,8,11” were reported as final data.



k. The test modes for H&F/EMS as follow

- Test Mode 1 Full system (HDMI mode 3440\*1440@50Hz)
- Test Mode 2 Full system (HDMI mode 1280\*1024@75Hz)
- Test Mode 3 Full system (HDMI mode 640\*480@60Hz)
- Test Mode 4 Full system (Display mode 3440\*1440@100Hz)
- Test Mode 5 Full system (Display mode 1280\*1024@75Hz)
- Test Mode 6 Full system (Display mode 640\*480@60Hz)
- Test Mode 7 Full system (1080P from DVD mode)

“Test mode 1,4” were reported as final data.

l. The maximum operating frequency is above 108MHz, the test frequency range is from 1GHz to 6GHz.



### 3.3. Description of Support Unit

No.	Device	Manufacturer	Model No.	Description
1	PC	HP	HP Compaq Elite 8200 MTPC	Non-Shielded ,1.8m(R33001)
2	USB Keyboard	DELL	SK-8115	T3A002
3	USB Mouse	DELL	G0K02XYK	R41108
4	Earphone	EDIFIER	N/A	N/A
5	HDD	WD	WDBPCK5000ABK-01	N/A
6	HDD	WD	WDBPCK5000ABK-02	N/A

No.	Cable	Quantity	Description
A	HDMI Cable	1	Shielded, 1.5m&1.8m, with two ferrite core bonded
B	Display Cable	1	Shielded, 1.5m&1.8m
C	Audio Cable	1	No-Shielded, 1.8m
D	USB Cable	1	Shielded, 1.5m
E	USB Cable	1	Shielded, 0.6m
F	USB Cable	1	Shielded, 0.6m
G	Audio Cable	1	No-Shielded, 1.8m
H	USB Cable	1	Shielded, 1.5m
I	USB Cable	1	Shielded, 1.8m ,with one ferrite core bonded



**3.4. General Information of Test**

<input type="checkbox"/>	Test Site	<p><b>CerpPASS Technology Corporation Test Laboratory</b>                  Address: No.10, Ln. 2, Lianfu St., Luzhu Dist., Taoyuan City 33848, Taiwan (R.O.C.)                  Tel:+886-3-3226-888                  Fax:+886-3-3226-881                  Address: No.68-1, Shihbachongsi, Shihding Township, New Taipei City 223, Taiwan, R.O.C.                  Tel: +886-2-2663-8582</p>
	FCC	TW1079, TW1061,390316, 228391, 641184
	IC	4934B-1, 4934E-1, 4934E-2
	VCCI	T-2205 for Telecommunication Test C-4663 for Conducted emission test R-3428, R-4218 for Radiated emission test G-812, G-813 for radiated disturbance above 1GHz
<input checked="" type="checkbox"/>	Test Site	<p><b>CerpPASS Technology (Suzhou) Co.,Ltd</b>                  Address: No.66,Tangzhuang Road, Suzhou Industrial Park, Jiangsu 215006, China                  Tel: +86-512-6917-5888                  Fax: +86-512-6917-5666</p>
	FCC	331395
	IC	7290A-1, 7290A-2
	VCCI	T-1945 for Telecommunication Test C-2919 for Conducted emission test R-2670 for Radiated emission test G-227 for radiated disturbance above 1GHz
Frequency Range Investigated:		Conducted: from 150kHz to 30 MHz Radiation: from 30 MHz to 6000MHz
Test Distance :		The test distance of radiated emission below 1GHz from antenna to EUT is 10 M. The test distance of radiated emission above 1GHz from antenna to EUT is 3 M.



### 3.5. Measurement Uncertainty

Where relevant, the following measurement uncertainty levels have been estimated for tests performed on the EUT as specified in CISPR 16-4-2:

Measurement	Frequency	Uncertainty
Conducted emissions(LINE)	9KHz-30MHz	+/- 0.7738 dB
Conducted emissions(NEUTRAL)	9KHz-30MHz	+/- 0.7886 dB

Measurement	Polarity	Frequency	Uncertainty
Radiated emissions (below 1GHz)	H	30MHz ~ 200MHz	+/- 3.8909dB
		200MHz ~1000MHz	+/- 3.6555dB
	V	30MHz ~ 200MHz	+/- 3.8948dB
		200MHz ~1000MHz	+/- 3.6538dB
Radiated emissions (above 1GHz)	H	1000MHz ~18000MHz	+/- 3.8948 dB
		18000MHz ~40000MHz	+/-3.8844dB
	V	1000MHz ~18000MHz	+/- 3.8906dB
		18000MHz ~40000MHz	+/- 3.8744dB

Measurement	Uncertainty
ESD—Rise time tr	10%
ESD—Peak current Ip	6%
ESD—Current at 30 ns	6%
ESD—Current at 60 ns	6%
ESD- Charging voltage	1%
RS above 1GHz	±2.37dB
RS under 1GHz	±3.83dB
EFT—Rise time tr	4%
EFT—Peak current Ip	4%
EFT—Current	4%
Surge—Rise time tr	4%
Surge—Peak current Ip	4%





Surge—Current	4%
CS-CND	±0.80dB
CS-Clamp	±1.06dB

This uncertainty represents an expanded uncertainty expressed at approximately the 95% confidence level using a coverage factor of k=2.

Consistent with industry standard (e.g. CISPR 22: 2008, clause 11, Measurement Uncertainty) determining compliance with the limits shall be base on the results of the compliance measurement. Consequently the measure emissions being less than the maximum allowed emission result in this be a compliant test or passing test.



## 4. Test of Conducted Emission

### 4.1. Test Limit

Conducted Emissions were measured from 150 kHz to 30 MHz with a bandwidth of 9 kHz and return leads of the EUT according to the methods defined in European Standard EN 55032.

**Table A.8 – Requirements for conducted emissions from the AC mains power ports of Class A equipment**

Applicable to				
1. AC mains power ports (3.1.1)				
Table clause	Frequency range MHz	Coupling device (see Table A.7)	Detector type / bandwidth	Class A limits dB( $\mu$ V)
A8.1	0,15 – 0,5	AMN	Quasi Peak / 9 kHz	79
	0,5 – 30			73
A8.2	0,15 – 0,5	AMN	Average / 9 kHz	66
	0,5 – 30			60

NOTE Apply A8.1 and A8.2 across the entire frequency range.

**Table A.9 – Requirements for conducted emissions from the AC mains power ports of Class B equipment**

Applicable to				
1. AC mains power ports (3.1.1)				
Table clause	Frequency range MHz	Coupling device (see Table A.7)	Detector type / bandwidth	Class B limits dB( $\mu$ V)
A9.1	0,15 – 0,5	AMN	Quasi Peak / 9 kHz	66 – 56
	0,5 – 5			56
	5 – 30			60
A9.2	0,15 – 0,5	AMN	Average / 9 kHz	56 – 46
	0,5 – 5			46
	5 – 30			50

NOTE Apply A9.1 and A9.2 across the entire frequency range.



**Table A.10 – Requirements for asymmetric mode conducted emissions from Class A equipment**

<b>Applicable to</b>					
1. wired network ports (3.1.30) 2. optical fibre ports (3.1.24) with metallic shield or tension members 3. antenna ports (3.1.3)					
<b>Table clause</b>	<b>Frequency range MHz</b>	<b>Coupling device (see Table A.7)</b>	<b>Detector type / bandwidth</b>	<b>Class A voltage limits dB(μV)</b>	<b>Class A current limits dB(μA)</b>
A10.1	0,15 – 0,5	AAN	Quasi Peak / 9 kHz	97 – 87	n/a
	0,5 – 30			87	
	0,15 – 0,5	AAN	Average / 9 kHz	84 – 74	
	0,5 – 30			74	
A10.2	0,15 – 0,5	CVP and current probe	Quasi Peak / 9 kHz	97 – 87	53 – 43
	0,5 – 30			87	43
	0,15 – 0,5	CVP and current probe	Average / 9 kHz	84 – 74	40 – 30
	0,5 – 30			74	30
A10.3	0,15 – 0,5	Current Probe	Quasi Peak / 9 kHz	n/a	53 – 43
	0,5 – 30				43
	0,15 – 0,5	Current Probe	Average / 9 kHz		40 – 30
	0,5 – 30				30
NOTE 1 The choice of coupling device and measurement procedure is defined in Annex C.					
NOTE 2 AC mains power ports shall meet the limits given in Table A.8.					
NOTE 3 The test shall cover the entire frequency range.					
NOTE 4 The application of the voltage and/or current limits is dependent on the measurement procedure used. Refer to Table C.1 for applicability.					
NOTE 5 Testing is required at only one EUT supply voltage and frequency.					
NOTE 6 Applicable to ports listed above and intended to connect to cables longer than 3 m.					



**Table A.11 – Requirements for asymmetric mode conducted emissions from Class B equipment**

<b>Applicable to</b>					
1. wired network ports (3.1.30) 2. optical fibre ports (3.1.24) with metallic shield or tension members 3. broadcast receiver tuner ports (3.1.8) 4. antenna ports (3.1.3)					
<b>Table clause</b>	<b>Frequency range MHz</b>	<b>Coupling device (see Table A.7)</b>	<b>Detector type / bandwidth</b>	<b>Class B voltage limits dB(μV)</b>	<b>Class B current limits dB(μA)</b>
A11.1	0,15 – 0,5	AAN	Quasi Peak / 9 kHz	84 – 74	n/a
	0,5 – 30			74	
	0,15 – 0,5	AAN	Average / 9 kHz	74 – 64	
	0,5 – 30			64	
A11.2	0,15 – 0,5	CVP and current probe	Quasi Peak / 9 kHz	84 – 74	40 – 30
	0,5 – 30			74	30
	0,15 – 0,5	CVP and current probe	Average / 9 kHz	74 – 64	30 – 20
	0,5 – 30			64	20
A11.3	0,15 – 0,5	Current Probe	Quasi Peak / 9 kHz	n/a	40 – 30
	0,5 – 30				30
	0,15 – 0,5	Current Probe	Average / 9 kHz		30 – 20
	0,5 – 30				20
NOTE 1 The choice of coupling device and measurement procedure is defined in Annex C. NOTE 2 Screened ports including TV broadcast receiver tuner ports are tested with a common-mode impedance of 150 Ω. This is typically accomplished with the screen terminated by 150 Ω to earth. NOTE 3 AC mains power ports shall meet the limits given in Table A.9. NOTE 4 The test shall cover the entire frequency range. NOTE 5 The application of the voltage and/or current limits is dependent on the measurement procedure used. Refer to Table C.1 for applicability. NOTE 6 Testing is required at only one EUT supply voltage and frequency. NOTE 7 Applicable to ports listed above and intended to connect to cables longer than 3 m.					



### 4.2. Test Procedures

- a. The EUT was placed on a desk 0.8 meters height from the metal ground plane and 0.4 meter from the conducting wall of the shielding room and it was kept at least 0.8 meters from any other grounded conducting surface.
- b. Connect EUT to the power mains through a line impedance stabilization network (LISN).
- c. All the support units are connecting to the other LISN.
- d. The LISN provides 50 ohm coupling impedance for the measuring instrument.
- e. The CISPR states that a 50 ohm, 50 micro-Henry LISN should be used.
- f. Both sides of AC line were checked for maximum conducted interference.
- g. The frequency range from 150 kHz to 30 MHz was searched
- h. Set the test-receiver system to Peak Detect Function and Specified Bandwidth with Maximum Hold Mode.

### 4.3. Typical Test Setup

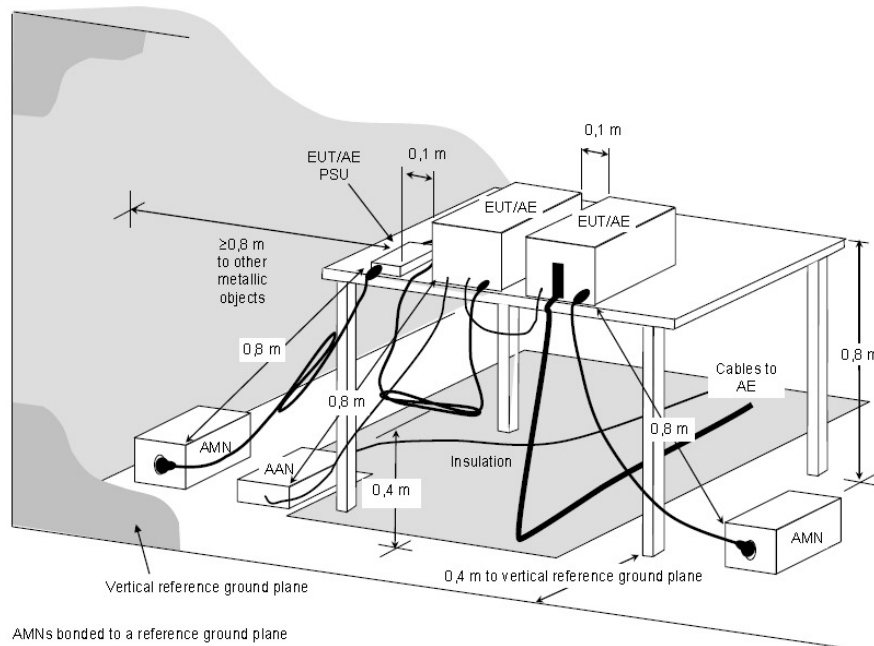

NOTE The 0,8 m distance specified between EUT/AE/PSU and AMN/AAN, is applicable only to the EUT being measured. If the device is AE then it shall be  $\geq 0,8$  m.

**Figure D.2 – Example measurement arrangement for table-top EUT  
(Conducted emission measurement – alternative 1)**



#### 4.4. Measurement Equipment

Instrument/Ancillary	Manufacturer	Model No.	Serial No.	Calibration Date	Valid Date.
Test Receiver	R&S	ESCI	100565	2016.07.07	2017.07.06
AMN	R&S	ESH2-Z5	100182	2016.08.31	2017.08.30
Two-Line V-Network	R&S	ENV216	100325	/	/
ISN	FCC	FCC-TLISN-T2-02	20379	2017.03.22	2018.03.21
ISN	FCC	FCC-TLISN-T4-02	20380	2017.06.21	2018.06.20
ISN	FCC	FCC-TLISN-T8-02	20381	2016.11.29	2017.11.28
ISN	TESEQ	ISN ST08	30175	2016.08.31	2017.08.30
LISN	FCC	FCC-LISN-50-200-2-02	112087	2016.08.31	2017.08.30
Current Probe	R&S	EZ-17	100303	2017.03.22	2018.03.21
Passive Voltage Probe	R&S	ESH2-Z3	100026	2017.03.22	2018.03.21
Pulse Limiter	R&S	ESH3-Z2	100529	2017.03.22	2018.03.21
Temperature/ Humidity Meter	Zhicheng	ZC1-11	CEP-TH-004	2017.03.28	2018.03.27
EZ-EMC	Fala	Ver CT3A1	N/A	N/A	N/A



### 4.5. Test Result and Data

#### 4.5.1 Conducted Emission for Power Port Test Data

Second edition:

Test Mode :	Mode 1: Full system (HDMI mode 3440*1440@50Hz) Signal from PC (230V/50Hz)		
AC Power :	AC 230V/50Hz	Phase :	LINE
Equipment :	LCD Monitor	Model No :	350LM00005
Temperature :	25°C	Humidity :	52%
Pressure(mbar) :	1001	Date:	2017/06/28



No.	Frequency (MHz)	Factor (dB)	Reading (dBuV)	Level (dBuV)	Limit (dBuV)	Margin (dB)	Detector
1	0.2260	10.12	35.97	46.09	62.59	-16.50	QP
2	0.2260	10.12	18.55	28.67	52.59	-23.92	AVG
3	0.4740	10.16	35.99	46.15	56.44	-10.29	QP
4	0.4740	10.16	26.19	36.35	46.44	-10.09	AVG
5	0.6020	10.15	40.66	50.81	56.00	-5.19	QP
6	0.6020	10.15	29.37	39.52	46.00	-6.48	AVG
7	0.6860	10.15	30.92	41.07	56.00	-14.93	QP
8	0.6860	10.15	22.95	33.10	46.00	-12.90	AVG
9	1.0940	10.16	33.61	43.77	56.00	-12.23	QP
10	1.0940	10.16	21.63	31.79	46.00	-14.21	AVG
11	1.4060	10.16	32.31	42.47	56.00	-13.53	QP
12	1.4060	10.16	20.55	30.71	46.00	-15.29	AVG

Note: Measurement Level = Reading Level + Correct Factor



Test Mode :	Mode 1: Full system (HDMI mode 3440*1440@50Hz) Signal from PC (230V/50Hz)		
AC Power :	AC 230V/50Hz	Phase :	NEUTRAL
Equipment :	LCD Monitor	Model No :	350LM00005
Temperature :	25°C	Humidity :	52%
Pressure(mbar) :	1001	Date:	2017/06/28

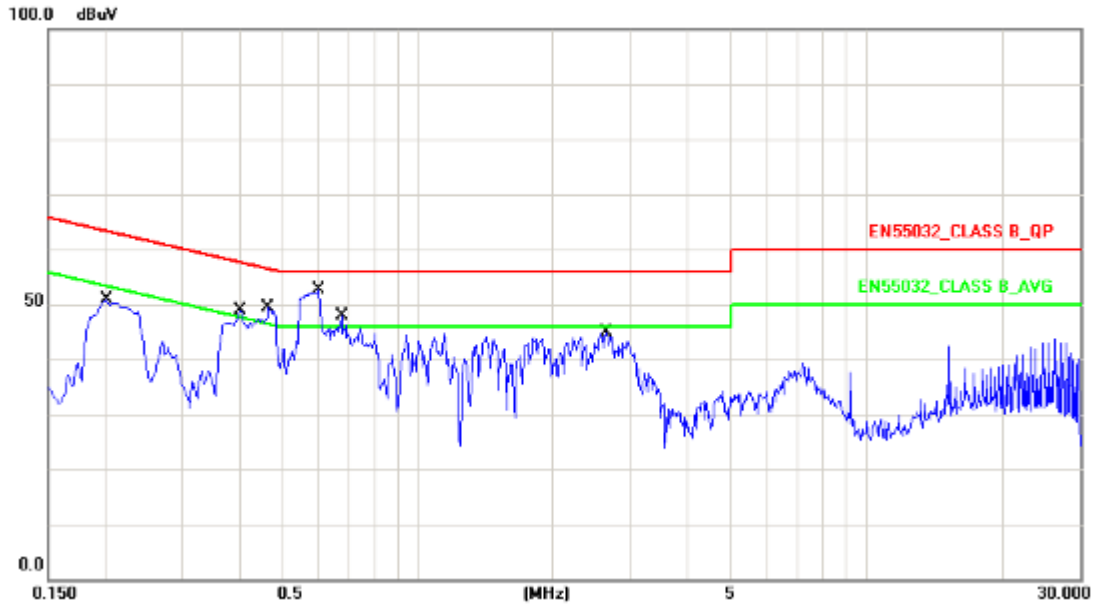

No.	Frequency (MHz)	Factor (dB)	Reading (dBuV)	Level (dBuV)	Limit (dBuV)	Margin (dB)	Detector
1	0.2020	10.13	36.40	46.53	63.52	-16.99	QP
2	0.2020	10.13	27.77	37.90	53.52	-15.62	AVG
3	0.4020	10.15	33.98	44.13	57.81	-13.68	QP
4	0.4020	10.15	25.99	36.14	47.81	-11.67	AVG
5	0.4660	10.15	33.81	43.96	56.58	-12.62	QP
6	0.4660	10.15	23.93	34.08	46.58	-12.50	AVG
7	0.6020	10.16	40.72	50.88	56.00	-5.12	QP
8	0.6020	10.16	28.42	38.58	46.00	-7.42	AVG
9	0.6780	10.16	32.03	42.19	56.00	-13.81	QP
10	0.6780	10.16	27.04	37.20	46.00	-8.80	AVG
11	2.6420	10.19	32.00	42.19	56.00	-13.81	QP
12	2.6420	10.19	24.33	34.52	46.00	-11.48	AVG

Note: Measurement Level = Reading Level + Correct Factor





Test Mode :	Mode 4: Full system (Display mode 3440*1440@100Hz) Signal from PC (230V/50Hz)		
AC Power :	AC 230V/50Hz	Phase :	LINE
Equipment :	LCD Monitor	Model No :	350LM00005
Temperature :	25°C	Humidity :	52%
Pressure(mbar) :	1001	Date:	2017/06/28

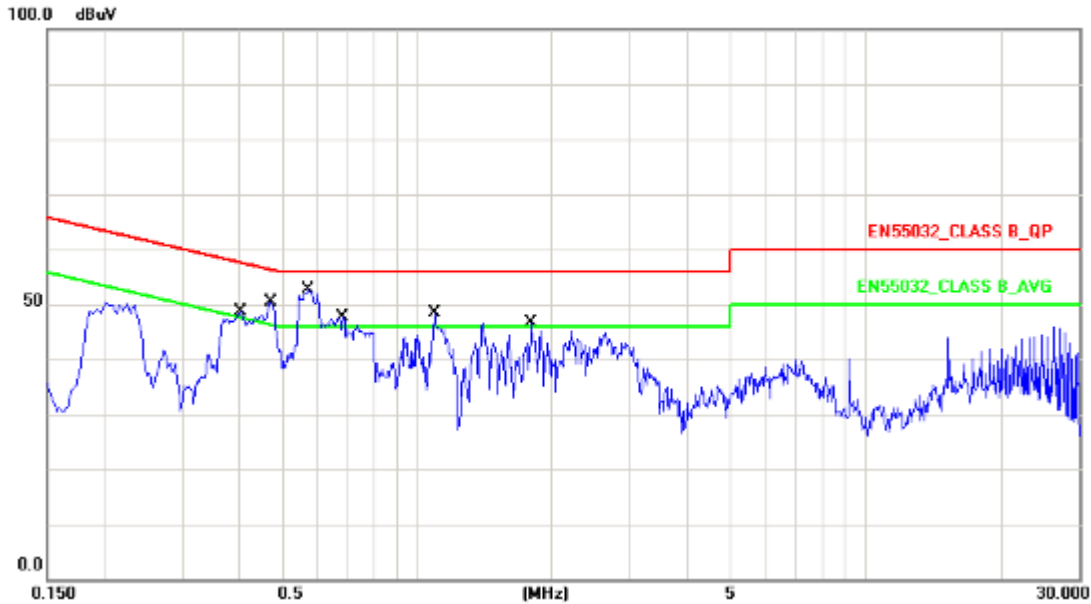

No.	Frequency (MHz)	Factor (dB)	Reading (dBuV)	Level (dBuV)	Limit (dBuV)	Margin (dB)	Detector
1	0.4060	10.15	34.63	44.78	57.73	-12.95	QP
2	0.4060	10.15	27.40	37.55	47.73	-10.18	AVG
3	0.4740	10.16	35.94	46.10	56.44	-10.34	QP
4	0.4740	10.16	26.19	36.35	46.44	-10.09	AVG
5	0.5740	10.16	40.51	50.67	56.00	-5.33	QP
6	0.5740	10.16	24.01	34.17	46.00	-11.83	AVG
7	0.6860	10.15	30.93	41.08	56.00	-14.92	QP
8	0.6860	10.15	22.96	33.11	46.00	-12.89	AVG
9	1.0940	10.16	30.72	40.88	56.00	-15.12	QP
10	1.0940	10.16	21.07	31.23	46.00	-14.77	AVG
11	1.8060	10.17	33.54	43.71	56.00	-12.29	QP
12	1.8060	10.17	20.30	30.47	46.00	-15.53	AVG

Note: Measurement Level = Reading Level + Correct Factor



Test Mode :	Mode 4: Full system (Display mode 3440*1440@100Hz) Signal from PC (230V/50Hz)		
AC Power :	AC 230V/50Hz	Phase :	NEUTRAL
Equipment :	LCD Monitor	Model No :	350LM00005
Temperature :	25°C	Humidity :	52%
Pressure(mbar) :	1001	Date:	2017/06/28

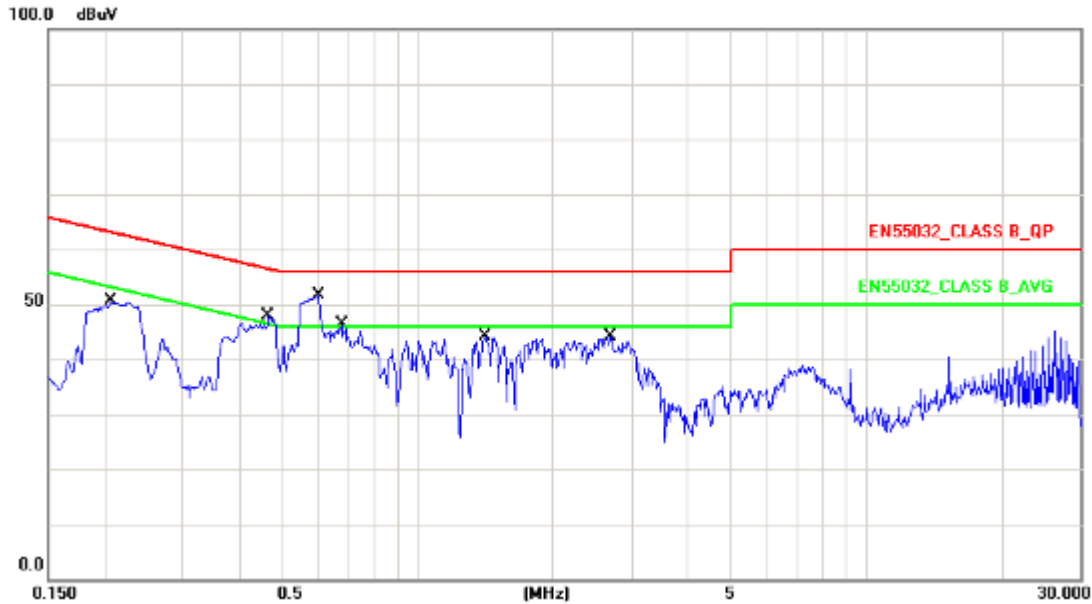

No.	Frequency (MHz)	Factor (dB)	Reading (dBuV)	Level (dBuV)	Limit (dBuV)	Margin (dB)	Detector
1	0.2072	10.13	35.93	46.06	63.31	-17.25	QP
2	0.2072	10.13	24.45	34.58	53.31	-18.73	AVG
3	0.4660	10.15	33.82	43.97	56.58	-12.61	QP
4	0.4660	10.15	24.08	34.23	46.58	-12.35	AVG
5	0.6020	10.16	40.69	50.85	56.00	-5.15	QP
6	0.6020	10.16	28.28	38.44	46.00	-7.56	AVG
7	0.6780	10.16	32.12	42.28	56.00	-13.72	QP
8	0.6780	10.16	27.08	37.24	46.00	-8.76	AVG
9	1.4180	10.18	31.98	42.16	56.00	-13.84	QP
10	1.4180	10.18	25.25	35.43	46.00	-10.57	AVG
11	2.6980	10.19	31.28	41.47	56.00	-14.53	QP
12	2.6980	10.19	21.07	31.26	46.00	-14.74	AVG

Note: Measurement Level = Reading Level + Correct Factor



Test Mode :	Mode 8: Full system (HDMI mode 3440*1440@50Hz) Signal from PC (110V/60Hz)		
AC Power :	AC 110V/60Hz	Phase :	LINE
Equipment :	LCD Monitor	Model No :	350LM00005
Temperature :	25°C	Humidity :	52%
Pressure(mbar) :	1001	Date:	2017/06/28

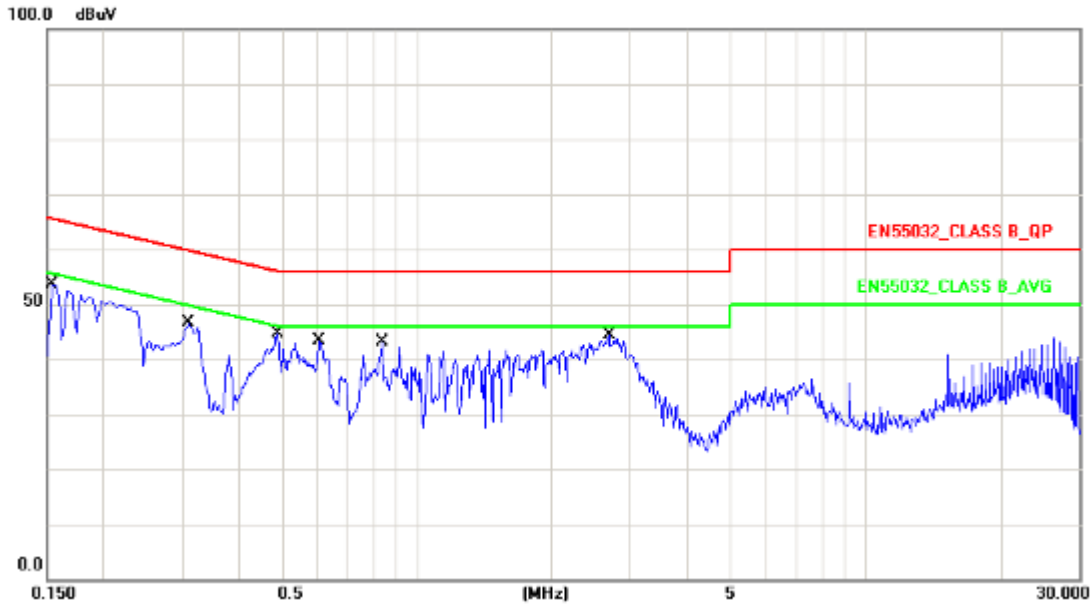

No.	Frequency (MHz)	Factor (dB)	Reading (dBuV)	Level (dBuV)	Limit (dBuV)	Margin (dB)	Detector
1	0.1539	10.13	39.78	49.91	65.78	-15.87	QP
2	0.1539	10.13	24.63	34.76	55.78	-21.02	AVG
3	0.3100	10.14	31.44	41.58	59.97	-18.39	QP
4	0.3100	10.14	22.30	32.44	49.97	-17.53	AVG
5	0.4900	10.16	32.62	42.78	56.17	-13.39	QP
6	0.4900	10.16	14.56	24.72	46.17	-21.45	AVG
7	0.6060	10.15	27.84	37.99	56.00	-18.01	QP
8	0.6060	10.15	22.70	32.85	46.00	-13.15	AVG
9	0.8380	10.15	27.69	37.84	56.00	-18.16	QP
10	0.8380	10.15	23.81	33.96	46.00	-12.04	AVG
11	2.6820	10.18	30.17	40.35	56.00	-15.65	QP
12	2.6820	10.18	21.58	31.76	46.00	-14.24	AVG

Note: Measurement Level = Reading Level + Correct Factor



Test Mode :	Mode 8: Full system (HDMI mode 3440*1440@50Hz) Signal from PC (110V/60Hz)		
AC Power :	AC 110V/60Hz	Phase :	NEUTRAL
Equipment :	LCD Monitor	Model No :	350LM00005
Temperature :	25°C	Humidity :	52%
Pressure(mbar) :	1001	Date:	2017/06/28

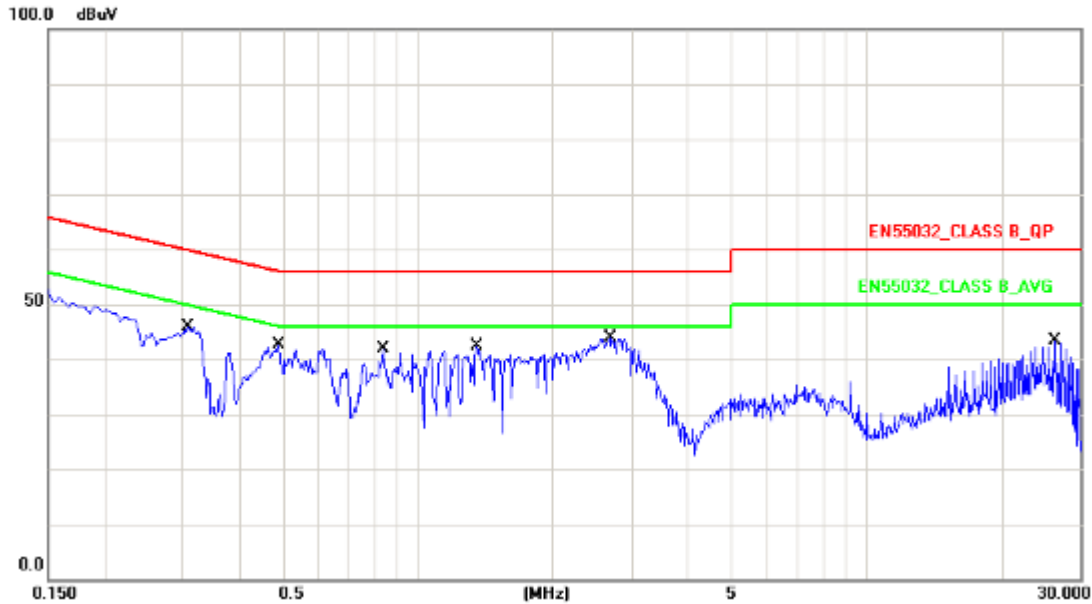

No.	Frequency (MHz)	Factor (dB)	Reading (dBuV)	Level (dBuV)	Limit (dBuV)	Margin (dB)	Detector
1	0.3067	10.14	29.92	40.06	60.06	-20.00	QP
2	0.3067	10.14	24.35	34.49	50.06	-15.57	AVG
3	0.4900	10.15	31.06	41.21	56.17	-14.96	QP
4	0.4900	10.15	13.75	23.90	46.17	-22.27	AVG
5	0.8380	10.16	28.86	39.02	56.00	-16.98	QP
6	0.8380	10.16	25.53	35.69	46.00	-10.31	AVG
7	1.3540	10.18	28.42	38.60	56.00	-17.40	QP
8	1.3540	10.18	16.27	26.45	46.00	-19.55	AVG
9	2.6820	10.19	30.59	40.78	56.00	-15.22	QP
10	2.6820	10.19	21.63	31.82	46.00	-14.18	AVG
11	26.3220	10.33	31.75	42.08	60.00	-17.92	QP
12	26.3220	10.33	31.64	41.97	50.00	-8.03	AVG

Note: Measurement Level = Reading Level + Correct Factor



Test Mode :	Mode 9: Full system (Display mode 3440*1440@100Hz) Signal from PC (110V/60Hz)		
AC Power :	AC 110V/60Hz	Phase :	LINE
Equipment :	LCD Monitor	Model No :	350LM00005
Temperature :	25°C	Humidity :	52%
Pressure(mbar) :	1001	Date:	2017/06/28

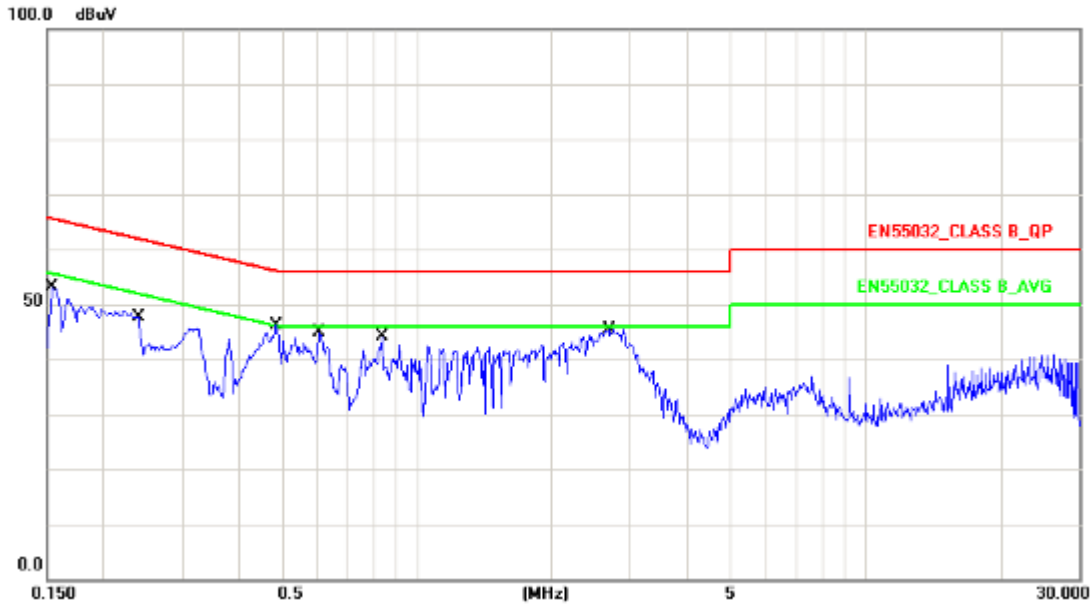

No.	Frequency (MHz)	Factor (dB)	Reading (dBuV)	Level (dBuV)	Limit (dBuV)	Margin (dB)	Detector
1	0.1539	10.13	40.08	50.21	65.78	-15.57	QP
2	0.1539	10.13	25.03	35.16	55.78	-20.62	AVG
3	0.2391	10.12	31.88	42.00	62.12	-20.12	QP
4	0.2391	10.12	9.54	19.66	52.12	-32.46	AVG
5	0.4863	10.16	31.67	41.83	56.23	-14.40	QP
6	0.4863	10.16	15.05	25.21	46.23	-21.02	AVG
7	0.6060	10.15	27.47	37.62	56.00	-18.38	QP
8	0.6060	10.15	22.37	32.52	46.00	-13.48	AVG
9	0.8380	10.15	27.65	37.80	56.00	-18.20	QP
10	0.8380	10.15	23.58	33.73	46.00	-12.27	AVG
11	2.6820	10.18	30.52	40.70	56.00	-15.30	QP
12	2.6820	10.18	21.60	31.78	46.00	-14.22	AVG

Note: Measurement Level = Reading Level + Correct Factor



Test Mode :	Mode 9: Full system (Display mode 3440*1440@100Hz) Signal from PC (110V/60Hz)		
AC Power :	AC 110V/60Hz	Phase :	NEUTRAL
Equipment :	LCD Monitor	Model No :	350LM00005
Temperature :	25°C	Humidity :	52%
Pressure(mbar) :	1001	Date:	2017/06/28

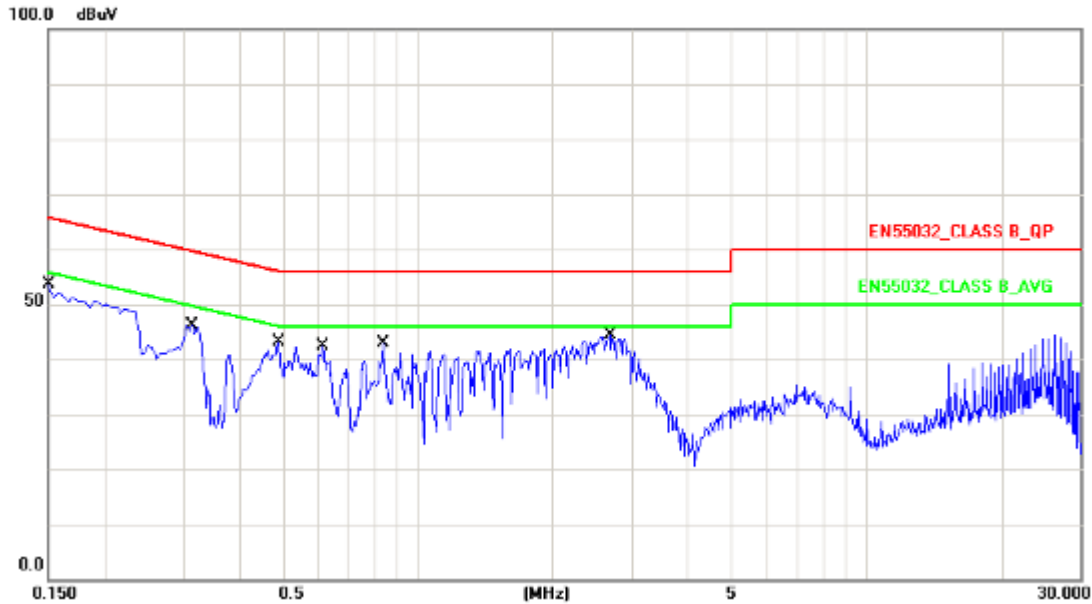

No.	Frequency (MHz)	Factor (dB)	Reading (dBuV)	Level (dBuV)	Limit (dBuV)	Margin (dB)	Detector
1	0.1500	10.13	3.17	13.30	65.99	-52.69	QP
2	0.1500	10.13	-0.81	9.32	55.99	-46.67	AVG
3	0.3140	10.14	30.61	40.75	59.86	-19.11	QP
4	0.3140	10.14	19.67	29.81	49.86	-20.05	AVG
5	0.4900	10.15	30.84	40.99	56.17	-15.18	QP
6	0.4900	10.15	13.54	23.69	46.17	-22.48	AVG
7	0.6140	10.16	27.86	38.02	56.00	-17.98	QP
8	0.6140	10.16	22.66	32.82	46.00	-13.18	AVG
9	0.8380	10.16	28.43	38.59	56.00	-17.41	QP
10	0.8380	10.16	23.81	33.97	46.00	-12.03	AVG
11	2.6820	10.19	30.65	40.84	56.00	-15.16	QP
12	2.6820	10.19	20.70	30.89	46.00	-15.11	AVG

Note: Measurement Level = Reading Level + Correct Factor



Original:

Test Mode :	Mode 1: Full system (HDMI mode 3440*1440@50Hz)(110V/60Hz)		
AC Power :	AC 110V/60Hz	Phase :	LINE
Equipment :	LCD Monitor	Model No :	350LM00005
Temperature :	25°C	Humidity :	54%
Pressure(mbar) :	1001	Date:	2016/12/08

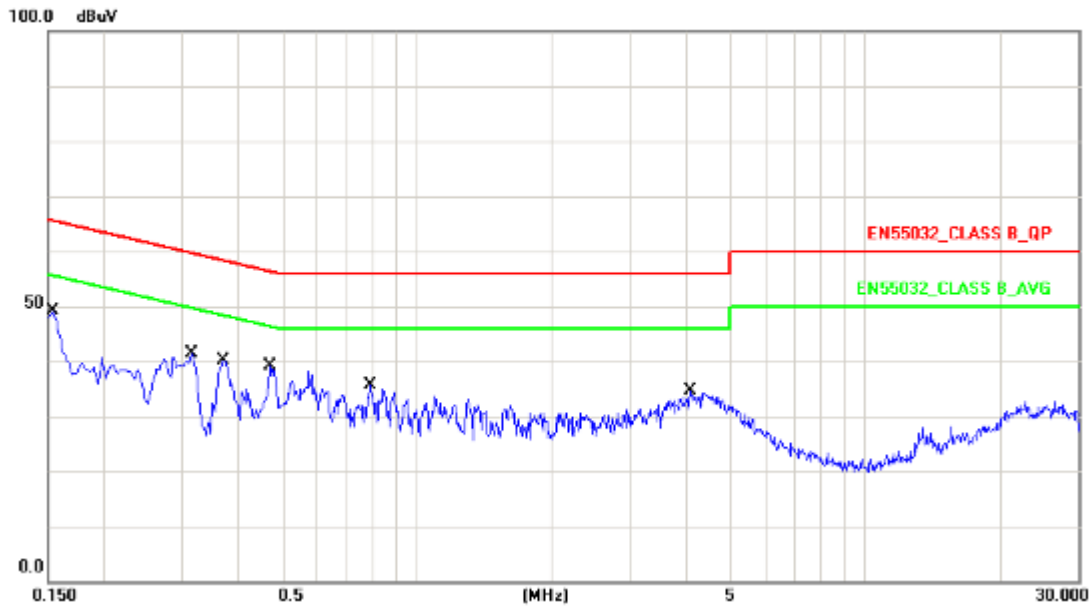

No.	Frequency (MHz)	Factor (dB)	Reading (dBuV)	Level (dBuV)	Limit (dBuV)	Margin (dB)	Detector
1	0.1539	10.13	34.91	45.04	65.78	-20.74	QP
2	0.1539	10.13	30.46	40.59	55.78	-15.19	AVG
3	0.3140	10.14	25.73	35.87	59.86	-23.99	QP
4	0.3140	10.14	17.03	27.17	49.86	-22.69	AVG
5	0.3700	10.15	28.11	38.26	58.50	-20.24	QP
6	0.3700	10.15	25.11	35.26	48.50	-13.24	AVG
7	0.4700	10.16	24.95	35.11	56.51	-21.40	QP
8	0.4700	10.16	22.06	32.22	46.51	-14.29	AVG
9	0.7900	10.15	20.98	31.13	56.00	-24.87	QP
10	0.7900	10.15	16.24	26.39	46.00	-19.61	AVG
11	4.0820	10.20	17.37	27.57	56.00	-28.43	QP
12	4.0820	10.20	10.48	20.68	46.00	-25.32	AVG

Note: Measurement Level = Reading Level + Correct Factor



Test Mode :	Mode 1: Full system (HDMI mode 3440*1440@50Hz)(110V/60Hz)		
AC Power :	AC 110V/60Hz	Phase :	NEUTRAL
Equipment :	LCD Monitor	Model No :	350LM00005
Temperature :	25°C	Humidity :	54%
Pressure(mbar) :	1001	Date:	2016/12/08

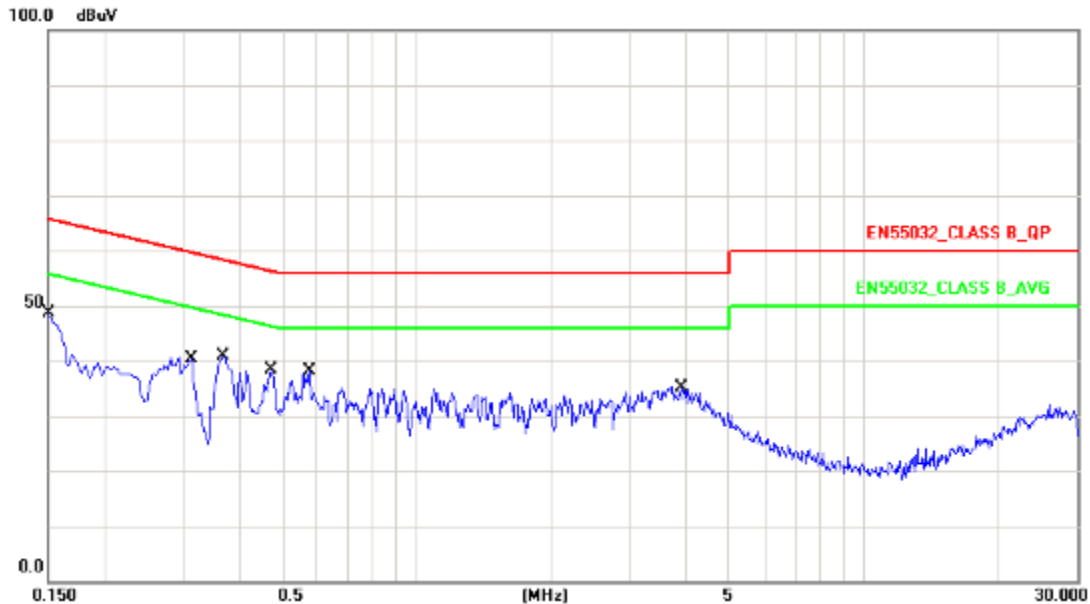

No.	Frequency (MHz)	Factor (dB)	Reading (dBuV)	Level (dBuV)	Limit (dBuV)	Margin (dB)	Detector
1	0.1500	10.13	33.50	43.63	65.99	-22.36	QP
2	0.1500	10.13	28.89	39.02	55.99	-16.97	AVG
3	0.3140	10.14	25.48	35.62	59.86	-24.24	QP
4	0.3140	10.14	18.64	28.78	49.86	-21.08	AVG
5	0.3700	10.15	29.10	39.25	58.50	-19.25	QP
6	0.3700	10.15	25.83	35.98	48.50	-12.52	AVG
7	0.4740	10.15	25.67	35.82	56.44	-20.62	QP
8	0.4740	10.15	21.47	31.62	46.44	-14.82	AVG
9	0.5780	10.15	23.22	33.37	56.00	-22.63	QP
10	0.5780	10.15	18.46	28.61	46.00	-17.39	AVG
11	3.9060	10.22	19.76	29.98	56.00	-26.02	QP
12	3.9060	10.22	11.62	21.84	46.00	-24.16	AVG

Note: Measurement Level = Reading Level + Correct Factor





Test Mode :	Mode 4: Full system (Display mode 3440*1440@100Hz)(110V/60Hz)		
AC Power :	AC 110V/60Hz	Phase :	LINE
Equipment :	LCD Monitor	Model No :	350LM00005
Temperature :	25°C	Humidity :	54%
Pressure(mbar) :	1001	Date:	2016/12/08

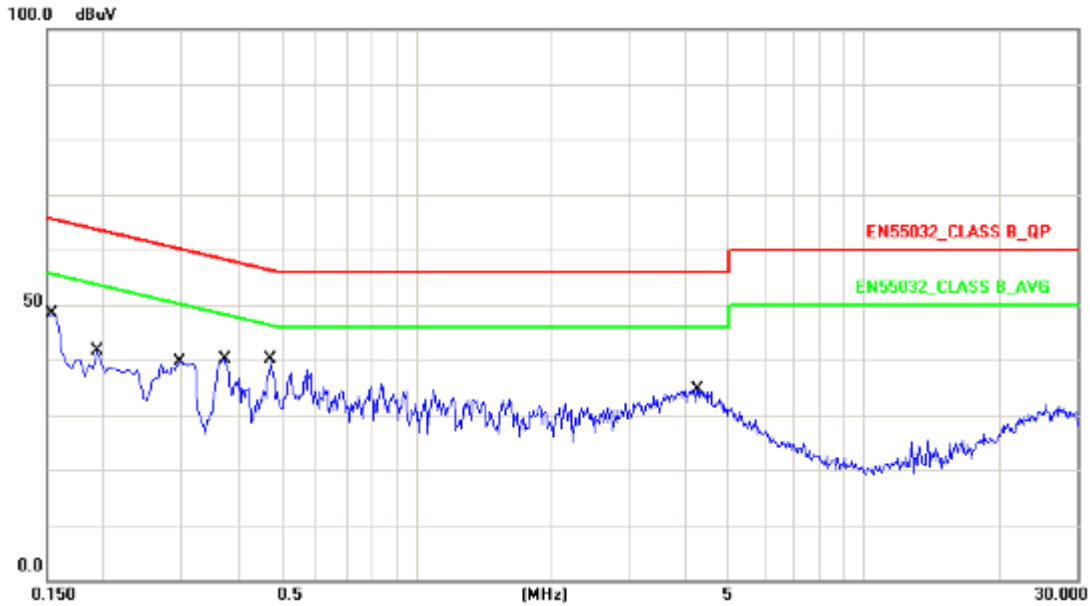

No.	Frequency (MHz)	Factor (dB)	Reading (dBuV)	Level (dBuV)	Limit (dBuV)	Margin (dB)	Detector
1	0.1539	10.13	33.68	43.81	65.78	-21.97	QP
2	0.1539	10.13	29.53	39.66	55.78	-16.12	AVG
3	0.1940	10.12	24.36	34.48	63.86	-29.38	QP
4	0.1940	10.12	12.55	22.67	53.86	-31.19	AVG
5	0.2980	10.14	25.02	35.16	60.30	-25.14	QP
6	0.2980	10.14	9.44	19.58	50.30	-30.72	AVG
7	0.3740	10.15	28.02	38.17	58.41	-20.24	QP
8	0.3740	10.15	22.89	33.04	48.41	-15.37	AVG
9	0.4740	10.16	25.39	35.55	56.44	-20.89	QP
10	0.4740	10.16	21.93	32.09	46.44	-14.35	AVG
11	4.2500	10.21	19.32	29.53	56.00	-26.47	QP
12	4.2500	10.21	12.78	22.99	46.00	-23.01	AVG

Note: Measurement Level = Reading Level + Correct Factor



Test Mode :	Mode 4: Full system (Display mode 3440*1440@100Hz)(110V/60Hz)		
AC Power :	AC 110V/60Hz	Phase :	NEUTRAL
Equipment :	LCD Monitor	Model No :	350LM00005
Temperature :	25°C	Humidity :	54%
Pressure(mbar) :	1001	Date:	2016/12/08

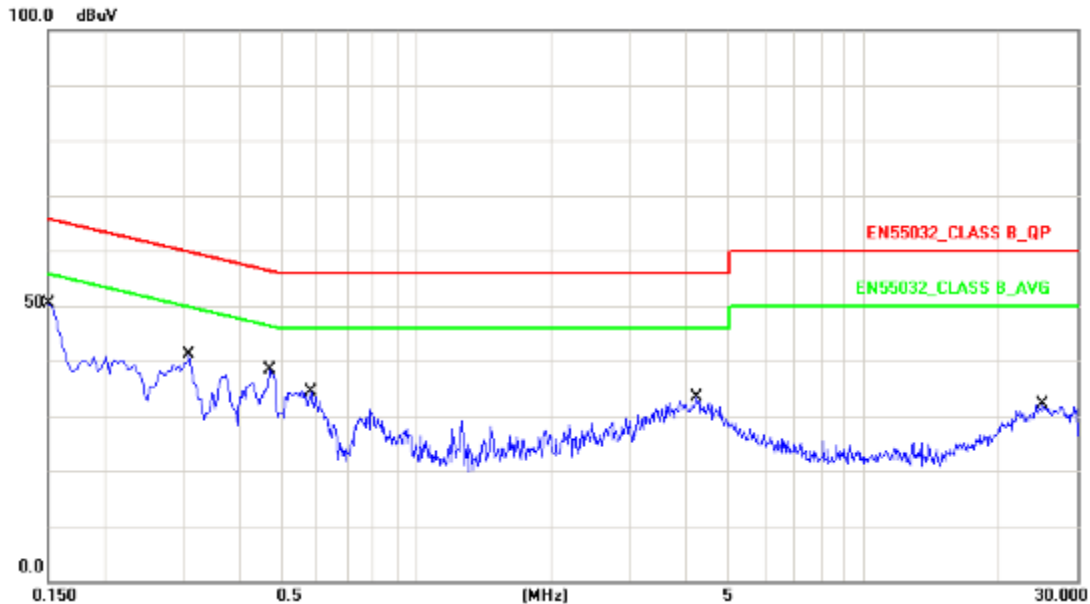

No.	Frequency (MHz)	Factor (dB)	Reading (dBuV)	Level (dBuV)	Limit (dBuV)	Margin (dB)	Detector
1	0.1500	10.13	36.47	46.60	65.99	-19.39	QP
2	0.1500	10.13	33.63	43.76	55.99	-12.23	AVG
3	0.3100	10.14	25.40	35.54	59.97	-24.43	QP
4	0.3100	10.14	17.28	27.42	49.97	-22.55	AVG
5	0.4700	10.15	23.99	34.14	56.51	-22.37	QP
6	0.4700	10.15	18.96	29.11	46.51	-17.40	AVG
7	0.5820	10.15	18.36	28.51	56.00	-27.49	QP
8	0.5820	10.15	6.63	16.78	46.00	-29.22	AVG
9	4.2420	10.22	17.58	27.80	56.00	-28.20	QP
10	4.2420	10.22	10.63	20.85	46.00	-25.15	AVG
11	25.1340	10.35	15.28	25.63	60.00	-34.37	QP
12	25.1340	10.35	7.77	18.12	50.00	-31.88	AVG

Note: Measurement Level = Reading Level + Correct Factor



Test Mode :	Mode 8: Full system (HDMI mode 3440*1440@50Hz)(230V/50Hz)		
AC Power :	AC 230V/50Hz	Phase :	LINE
Equipment :	LCD Monitor	Model No :	350LM00005
Temperature :	25°C	Humidity :	54%
Pressure(mbar) :	1001	Date:	2016/12/08

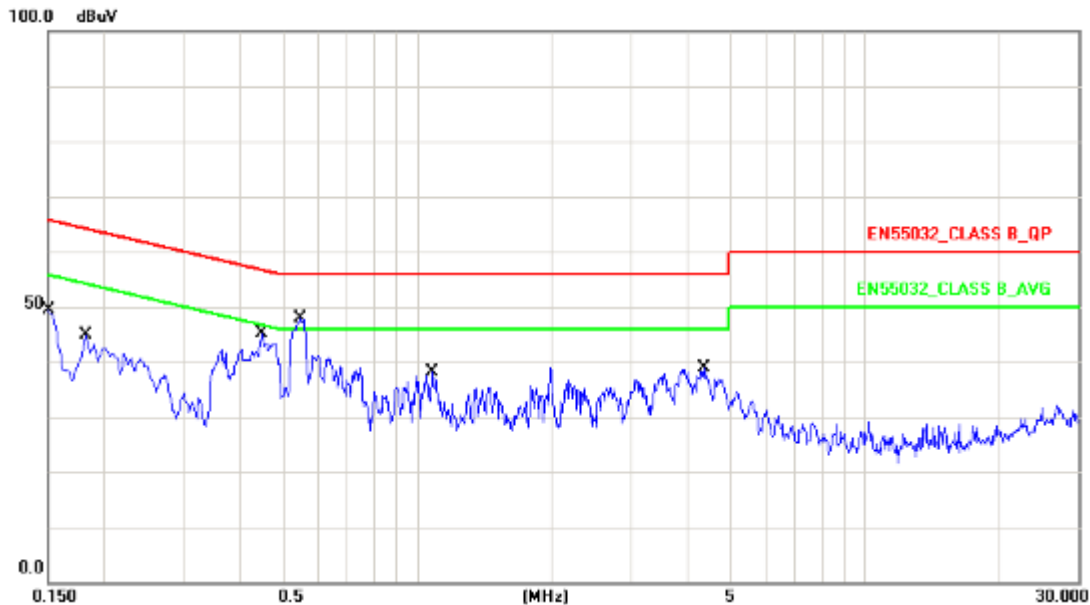

No.	Frequency (MHz)	Factor (dB)	Reading (dBuV)	Level (dBuV)	Limit (dBuV)	Margin (dB)	Detector
1	0.1500	10.13	36.47	46.60	65.99	-19.39	QP
2	0.1500	10.13	30.92	41.05	55.99	-14.94	AVG
3	0.1819	10.13	31.22	41.35	64.39	-23.04	QP
4	0.1819	10.13	25.73	35.86	54.39	-18.53	AVG
5	0.4500	10.15	30.48	40.63	56.87	-16.24	QP
6	0.4500	10.15	27.55	37.70	46.87	-9.17	AVG
7	0.5500	10.15	34.44	44.59	56.00	-11.41	QP
8	0.5500	10.15	23.55	33.70	46.00	-12.30	AVG
9	1.0820	10.18	23.40	33.58	56.00	-22.42	QP
10	1.0820	10.18	17.53	27.71	46.00	-18.29	AVG
11	4.3700	10.24	25.15	35.39	56.00	-20.61	QP
12	4.3700	10.24	20.30	30.54	46.00	-15.46	AVG

Note: Measurement Level = Reading Level + Correct Factor



Test Mode :	Mode 8: Full system (HDMI mode 3440*1440@50Hz)(230V/50Hz)		
AC Power :	AC 230V/50Hz	Phase :	NEUTRAL
Equipment :	LCD Monitor	Model No :	350LM00005
Temperature :	25°C	Humidity :	54%
Pressure(mbar) :	1001	Date:	2016/12/08

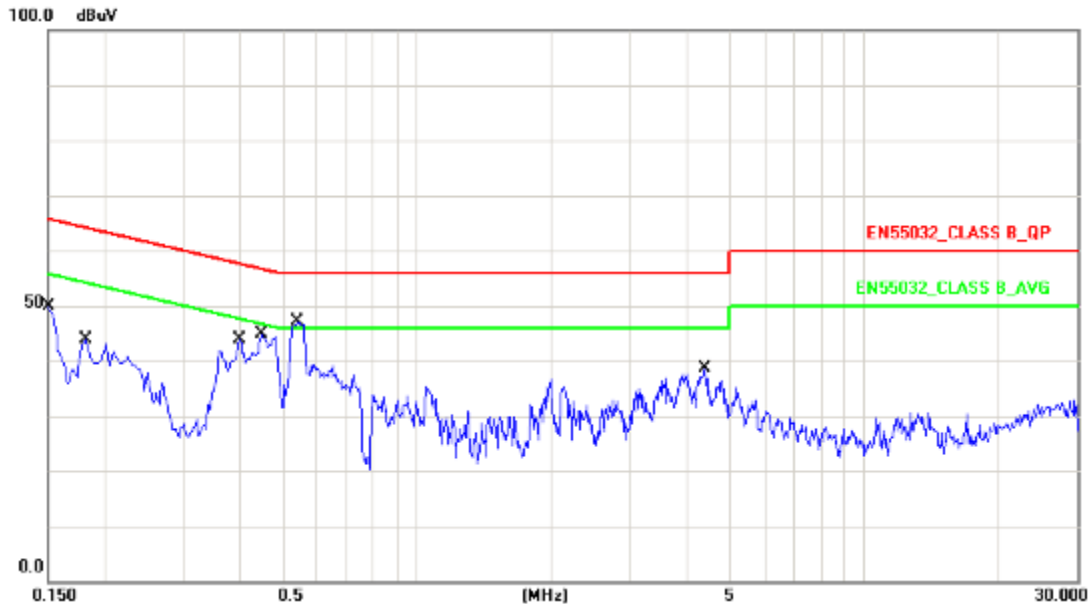

No.	Frequency (MHz)	Factor (dB)	Reading (dBuV)	Level (dBuV)	Limit (dBuV)	Margin (dB)	Detector
1	0.1500	10.13	37.41	47.54	65.99	-18.45	QP
2	0.1500	10.13	33.36	43.49	55.99	-12.50	AVG
3	0.1819	10.12	30.22	40.34	64.39	-24.05	QP
4	0.1819	10.12	22.83	32.95	54.39	-21.44	AVG
5	0.4020	10.15	31.16	41.31	57.81	-16.50	QP
6	0.4020	10.15	26.09	36.24	47.81	-11.57	AVG
7	0.4500	10.16	29.57	39.73	56.87	-17.14	QP
8	0.4500	10.16	24.81	34.97	46.87	-11.90	AVG
9	0.5420	10.16	34.23	44.39	56.00	-11.61	QP
10	0.5420	10.16	20.25	30.41	46.00	-15.59	AVG
11	4.4100	10.22	24.61	34.83	56.00	-21.17	QP
12	4.4100	10.22	20.23	30.45	46.00	-15.55	AVG

Note: Measurement Level = Reading Level + Correct Factor



Test Mode :	Mode 11: Full system (Display mode 3440*1440@100Hz)(230V/50Hz)		
AC Power :	AC 230V/50Hz	Phase :	LINE
Equipment :	LCD Monitor	Model No :	350LM00005
Temperature :	25°C	Humidity :	54%
Pressure(mbar) :	1001	Date:	2016/12/08

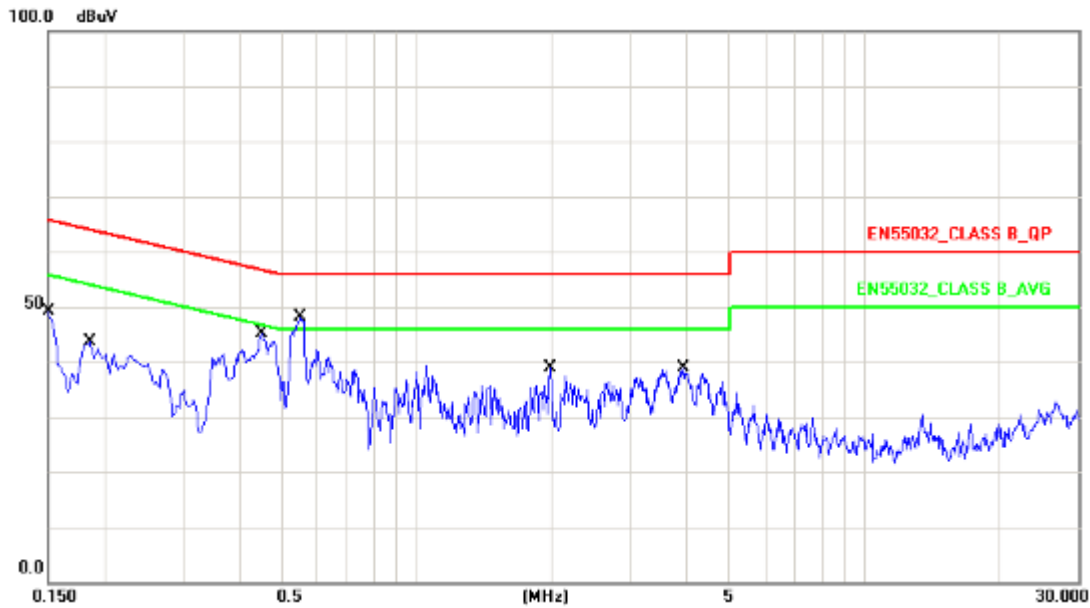

No.	Frequency (MHz)	Factor (dB)	Reading (dBuV)	Level (dBuV)	Limit (dBuV)	Margin (dB)	Detector
1	0.1500	10.13	36.74	46.87	65.99	-19.12	QP
2	0.1500	10.13	30.93	41.06	55.99	-14.93	AVG
3	0.1860	10.12	30.26	40.38	64.21	-23.83	QP
4	0.1860	10.12	23.12	33.24	54.21	-20.97	AVG
5	0.4500	10.16	30.94	41.10	56.87	-15.77	QP
6	0.4500	10.16	28.42	38.58	46.87	-8.29	AVG
7	0.5500	10.16	35.17	45.33	56.00	-10.67	QP
8	0.5500	10.16	24.40	34.56	46.00	-11.44	AVG
9	1.9900	10.17	18.61	28.78	56.00	-27.22	QP
10	1.9900	10.17	9.53	19.70	46.00	-26.30	AVG
11	3.9580	10.20	26.36	36.56	56.00	-19.44	QP
12	3.9580	10.20	21.48	31.68	46.00	-14.32	AVG

Note: Measurement Level = Reading Level + Correct Factor



Test Mode :	Mode 11: Full system (Display mode 3440*1440@100Hz)(230V/50Hz)		
AC Power :	AC 230V/50Hz	Phase :	NEUTRAL
Equipment :	LCD Monitor	Model No :	350LM00005
Temperature :	25°C	Humidity :	54%
Pressure(mbar) :	1001	Date:	2016/12/08

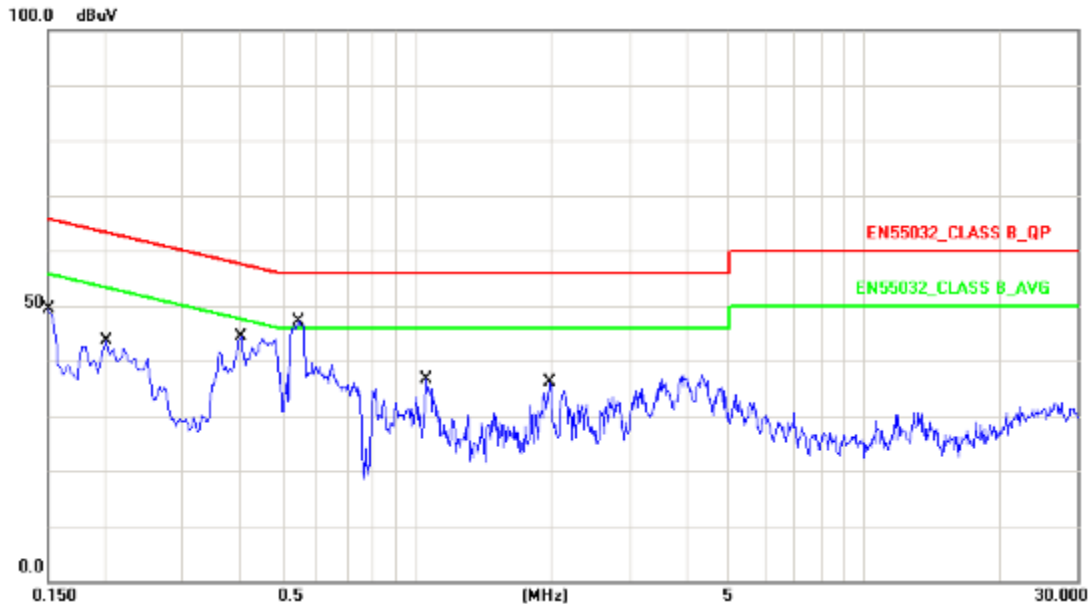

No.	Frequency (MHz)	Factor (dB)	Reading (dBuV)	Level (dBuV)	Limit (dBuV)	Margin (dB)	Detector
1	0.1500	10.13	37.37	47.50	65.99	-18.49	QP
2	0.1500	10.13	33.24	43.37	55.99	-12.62	AVG
3	0.2020	10.12	29.22	39.34	63.52	-24.18	QP
4	0.2020	10.12	20.91	31.03	53.52	-22.49	AVG
5	0.4060	10.15	29.45	39.60	57.73	-18.13	QP
6	0.4060	10.15	24.51	34.66	47.73	-13.07	AVG
7	0.5460	10.16	34.64	44.80	56.00	-11.20	QP
8	0.5460	10.16	21.68	31.84	46.00	-14.16	AVG
9	1.0540	10.16	21.58	31.74	56.00	-24.26	QP
10	1.0540	10.16	10.05	20.21	46.00	-25.79	AVG
11	1.9860	10.17	20.41	30.58	56.00	-25.42	QP
12	1.9860	10.17	9.16	19.33	46.00	-26.67	AVG

Note: Measurement Level = Reading Level + Correct Factor

Test engineer: Sun. Zhang



#### **4.5.2 Conducted Emission for Telecommunication Port Test Data**

Note: The EUT doesn't have the telecommunication port.



### 4.6. Test Photographs of Power Port

Second edition:

Front View



Rear View







Original:

Front View



Rear View





## 5. Test of Radiated Emission

### 5.1. Test Limit

The EUT shall meet the limits of below Table when measured at the measuring distance R in accordance with the methods described in European Standard EN 55032. If the reading on the measuring receiver shows fluctuations close to the limit, the reading shall be observed for at least 15 s at each measurement frequency; the highest reading shall be recorded, with the exception of any brief isolated high reading, which shall be ignored.

**Table 1 – Required highest frequency for radiated measurement**

Highest internal frequency ( $F_x$ )	Highest measured frequency
$F_x \leq 108$ MHz	1 GHz
$108$ MHz $< F_x \leq 500$ MHz	2 GHz
$500$ MHz $< F_x \leq 1$ GHz	5 GHz
$F_x > 1$ GHz	$5 \times F_x$ up to a maximum of 6 GHz

NOTE 1 For FM and TV broadcast receivers,  $F_x$  is determined from the highest frequency generated or used excluding the local oscillator and tuned frequencies.

NOTE 2  $F_x$  is defined in 3.1.19.

Where the  $F_x$  is unknown, the radiated emission measurements shall be performed up to 6 GHz.

**Table A.2 – Requirements for radiated emissions at frequencies up to 1 GHz for Class A equipment**

Table clause	Frequency range MHz	Measurement		Class A limits dB( $\mu$ V/m)
		Distance m	Detector type/ bandwidth	OATS/SAC (see Table A.1)
A2.1	30 – 230	10	Quasi Peak / 120 kHz	40
	230 – 1 000			47
A2.2	30 – 230	3		50
	230 – 1 000			57

NOTE Apply only A2.1 or A2.2 across the entire frequency range.

**Table A.3 – Requirements for radiated emissions at frequencies above 1 GHz for Class A equipment**

Table clause	Frequency range MHz	Measurement		Class A limits dB( $\mu$ V/m)
		Distance m	Detector type/ bandwidth	FSOATS (see Table A.1)
A3.1	1 000 – 3 000	3	Average / 1 MHz	56
	3 000 – 6 000			60
A3.2	1 000 – 3 000		Peak / 1 MHz	76
	3 000 – 6 000			80

NOTE Apply A3.1 and A3.2 across the frequency range from 1 000 MHz to the highest required frequency of measurement derived from Table 1.



**Table A.4 – Requirements for radiated emissions at frequencies up to 1 GHz for Class B equipment**

Table clause	Frequency range MHz	Measurement		Class B limits dB(μV/m)	
		Distance m	Detector type/ bandwidth	OATS/SAC (see Table A.1)	
A4.1	30 – 230	10	Quasi Peak / 120 kHz	30	
	230 – 1 000			37	
A4.2	30 – 230	3		40	
	230 – 1 000			47	

NOTE Apply only table clause A4.1 or A4.2 across the entire frequency range.

**Table A.5 – Requirements for radiated emissions at frequencies above 1 GHz for Class B equipment**

Table clause	Frequency range MHz	Measurement		Class B limits dB(μV/m)	
		Distance m	Detector type/ bandwidth	FSOATS (see Table A.1)	
A5.1	1 000 – 3 000	3	Average/ 1 MHz	50	
	3 000 – 6 000			54	
A5.2	1 000 – 3 000		Peak/ 1 MHz	70	
	3 000 – 6 000			74	

NOTE Apply A5.1 and A5.2 across the frequency range from 1 000 MHz to the highest required frequency of measurement derived from Table 1.

**Table A.6 – Requirements for radiated emissions from FM receivers**

Table clause	Frequency range MHz	Measurement		Class B limit dB(μV/m)		
		Distance m	Detector type/ bandwidth	Fundamental	Harmonics	
				OATS/SAC (see Table A.1)	OATS/SAC (see Table A.1)	
A6.1	30 – 230	10	Quasi peak/ 120 kHz	50	42	
	230 – 300				42	
	300 – 1 000				46	
A6.2	30 – 230	3		Quasi peak/ 120 kHz	60	52
	230 – 300					52
	300 – 1 000					56

NOTE 1 Apply only A.6.1 or A.6.2 across the entire frequency range.

NOTE 2 These relaxed limits apply only to emissions at the fundamental and harmonic frequencies of the local oscillator. Signals at all other frequencies shall be compliant with the limits given in Table A.4.



**Table A.12 – Requirements for conducted differential voltage emissions from Class B equipment**

<b>Applicable to</b>						
1. TV broadcast receiver tuner ports (3.1.8) with an accessible connector						
2. RF modulator output ports (3.1.27)						
3. FM broadcast receiver tuner ports (3.1.8) with an accessible connector						
Table clause	Frequency range MHz	Detector type/ bandwidth	Class B limits dB(μV) 75 Ω			Applicability
			Other	Local Oscillator Fundamental	Local Oscillator Harmonics	
A12.1	30 – 950	For frequencies ≤1 GHz	46	46	46	See NOTE 1
	950 – 2 150		46	54	54	
A12.2	950 – 2 150		46	54	54	See NOTE 2
A12.3	30 – 300		Quasi Peak/ 120 kHz	46	54	50
	300 – 1 000	52				
A12.4	30 – 300	For frequencies ≥1 GHz	46	66	59	See NOTE 4
	300 – 1 000				52	
A12.5	30 – 950	Peak/ 1 MHz	46	76	46	See NOTE 5
	950 – 2 150			n/a	54	

NOTE 1 Television receivers (analogue or digital), video recorders and PC TV broadcast receiver tuner cards working in channels between 30 MHz and 1 GHz, and digital audio receivers.

NOTE 2 Tuner units (not the LNB) for satellite signal reception.

NOTE 3 Frequency modulation audio receivers and PC tuner cards.

NOTE 4 Frequency modulation car radios.

NOTE 5 Applicable to EUTs with RF modulator output ports (for example DVD equipment, video recorders, camcorders and decoders etc.) designed to connect to TV broadcast receiver tuner ports.

NOTE 6 Testing is required at only one EUT supply voltage and frequency.

NOTE 7 The term 'other' refers to all emissions other than the fundamental and the harmonics of the local oscillator.

NOTE 8 The test shall be performed with the device operating at each reception channel.

NOTE 9 The test shall cover the entire frequency range.

## 5.2. Test Procedures

- a. The EUT was placed on a rotatable table top 0.8 meter above ground.
- b. The EUT was set 3/10 meters from the interference receiving antenna which was mounted on the top of a variable height antenna tower.
- c. The table was rotated 360 degrees to determine the position of the highest radiation.
- d. The antenna is a half wave dipole and its height is varied between one meter and four meters above ground to find the maximum value of the field strength both horizontal polarization and vertical polarization of the antenna are set to make the measurement.
- e. For each suspected emission the EUT was arranged to its worst case and then tune the antenna tower (from 1 M to 4 M) and turn table (from 0 degree to 360 degrees) to find the maximum reading.
- f. Set the test-receiver system to Peak Detect Function and specified bandwidth with Maximum Hold Mode.
- g. If the emission level of the EUT in peak mode was 3 dB lower than the limit specified, then testing will be stopped and peak values of EUT will be reported, otherwise, the emissions which do not have 3 dB margin will be repeated one by one using the quasi-peak method and reported.

## 5.3. Typical Test Setup

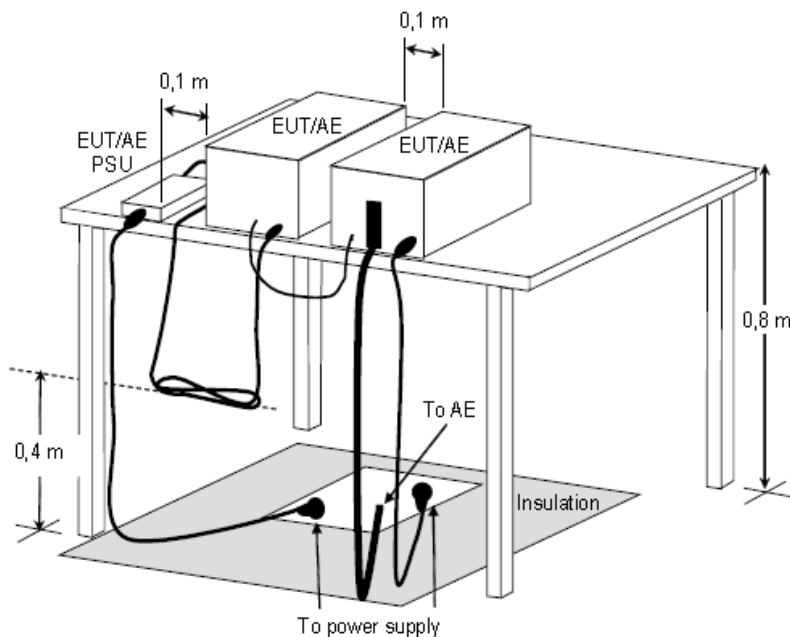

Figure D.8 – Example measurement arrangement for table-top EUT  
(Radiated emission measurement)



#### 5.4. Measurement Equipment

Instrument/Ancillary	Manufacturer	Model No.	Serial No.	Calibration Date	Valid Date.
EMI Test Receiver	R&S	ESCI7	100968	2016.07.21	2017.07.20
Preamplifier	Agilent	87405B	My39500554	2017.03.22	2018.03.21
Preamplifier	Agilent	8449B	3008A02342	2017.03.22	2018.03.21
Bilog Antenna	Sunol Science	JB1	A072414-1	2017.04.16	2018.04.15
Broad-Band Horn Antenna	Schwarzbeck	BBHA9120D	9120D-618	2017.04.22	2018.04.22
Spectrum Analyzer	R&S	FSP40	100324	2016.08.02	2017.08.01
Temperature/ Humidity Meter	Zhicheng	ZC1-11	CEP-TH-001	2017.03.28	2018.03.27
EZ-EMC	Fala	Ver CT3A1	N/A	N/A	N/A



### 5.5. Test Result and Data (30MHz ~ 1GHz)

Second edition:

Test Mode :	Mode 1: Full system (HDMI mode 3440*1440@50Hz) Signal from PC (230V/50Hz)		
AC Power :	AC 230V/50Hz	Ant. Polarization:	Horizontal
Equipment :	LCD Monitor	Model No :	350LM00005
Temperature :	25°C	Humidity :	52%
Pressure(mbar) :	1001	Date:	2017/06/28

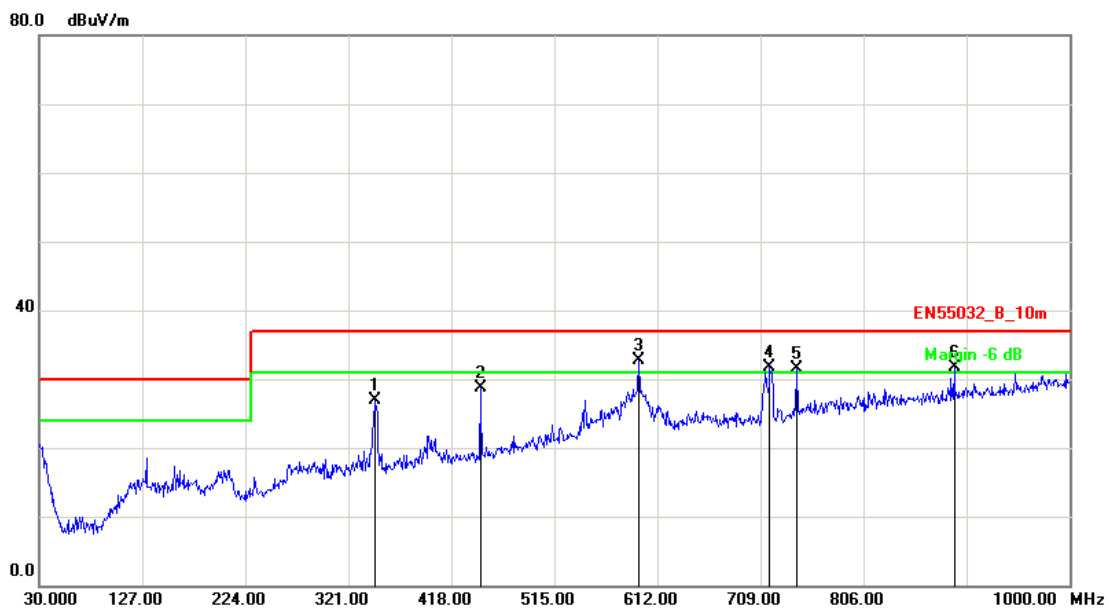

No.	Frequency (MHz)	Factor (dB/m)	Reading (dBuV)	Level (dBuV/m)	Limit (dBuV/m)	Margin (dB)	Det.	Height (cm)	Azimuth (deg)
1	346.2200	-7.50	34.44	26.94	37.00	-10.06	peak	100	201
2	445.1600	-4.67	33.34	28.67	37.00	-8.33	peak	100	42
3	594.5399	-1.32	34.00	32.68	37.00	-4.32	peak	100	287
4	717.7300	0.28	31.33	31.61	37.00	-5.39	peak	100	136
5	742.9500	0.92	30.51	31.43	37.00	-5.57	peak	100	300
6	891.3600	3.32	28.42	31.74	37.00	-5.26	peak	400	210

Note: Measurement Level = Reading Level + Correct Factor



Test Mode :	Mode 1: Full system (HDMI mode 3440*1440@50Hz) Signal from PC (230V/50Hz)		
AC Power :	AC 230V/50Hz	Ant. Polarization:	Vertical
Equipment :	LCD Monitor	Model No :	350LM00005
Temperature :	25°C	Humidity :	52%
Pressure(mbar) :	1001	Date:	2017/06/28

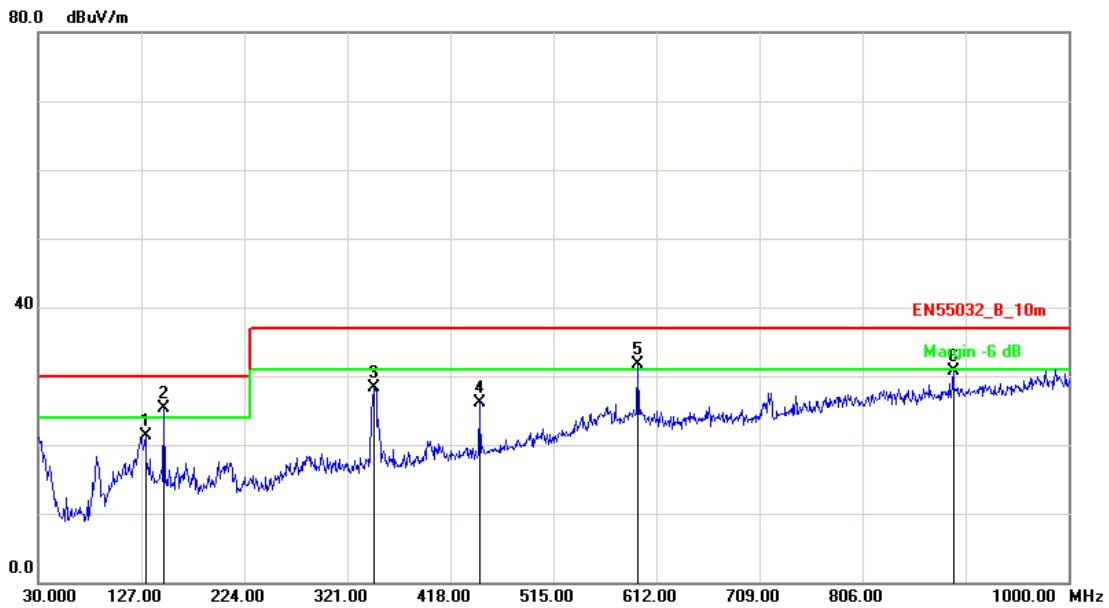

No.	Frequency (MHz)	Factor (dB/m)	Reading (dBuV)	Level (dBuV/m)	Limit (dBuV/m)	Margin (dB)	Det.	Height (cm)	Azimuth (deg)
1	130.8800	-10.02	31.35	21.33	30.00	-8.67	peak	100	312
2	148.3400	-10.60	35.83	25.23	30.00	-4.77	peak	100	277
3	346.2200	-7.50	35.79	28.29	37.00	-8.71	peak	400	190
4	445.1600	-4.67	30.80	26.13	37.00	-10.87	peak	100	213
5	594.5400	-1.32	33.10	31.78	37.00	-5.22	peak	100	134
6	891.3600	3.32	27.34	30.66	37.00	-6.34	peak	100	248

Note: Measurement Level = Reading Level + Correct Factor





Test Mode :	Mode 4: Full system (Display mode 3440*1440@100Hz) Signal from PC (230V/50Hz)		
AC Power :	AC 230V/50Hz	Ant. Polarization:	Horizontal
Equipment :	LCD Monitor	Model No :	350LM00005
Temperature :	25°C	Humidity :	52%
Pressure(mbar) :	1001	Date:	2017/06/28

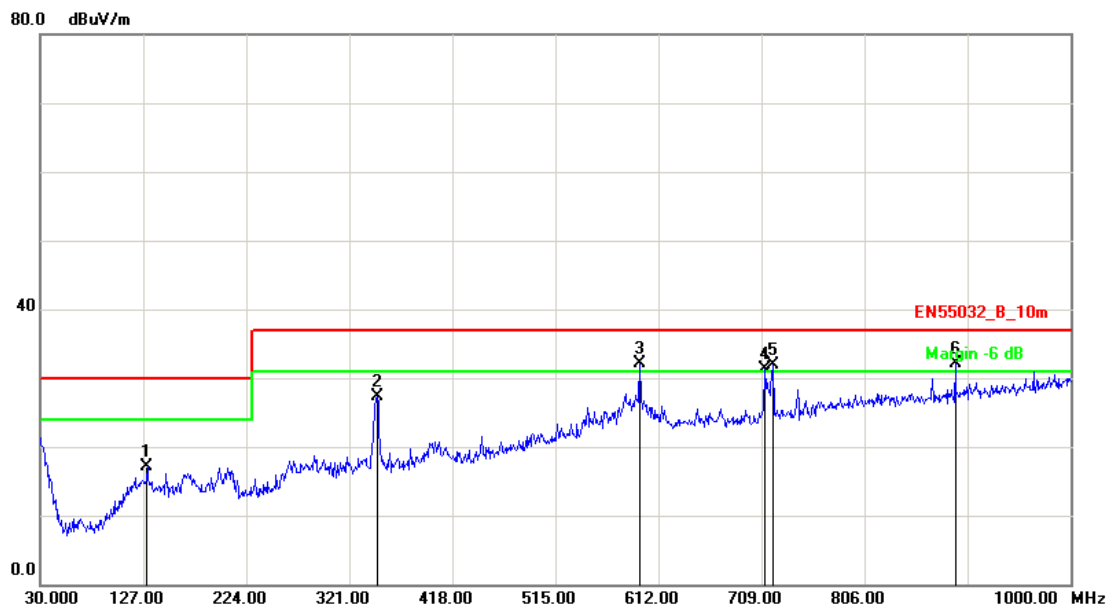

No.	Frequency (MHz)	Factor (dB/m)	Reading (dBuV)	Level (dBuV/m)	Limit (dBuV/m)	Margin (dB)	Det.	Height (cm)	Azimuth (deg)
1	130.8799	-10.02	27.22	17.20	30.00	-12.80	peak	400	90
2	347.1899	-7.45	34.73	27.28	37.00	-9.72	peak	100	209
3	594.5399	-1.32	33.48	32.16	37.00	-4.84	peak	100	19
4	711.9099	0.13	31.09	31.22	37.00	-5.78	peak	100	127
5	719.6699	0.33	31.57	31.90	37.00	-5.10	peak	100	127
6	891.3600	3.32	28.87	32.19	37.00	-4.81	peak	400	317

Note: Measurement Level = Reading Level + Correct Factor



Test Mode :	Mode 4: Full system (Display mode 3440*1440@100Hz) Signal from PC (230V/50Hz)		
AC Power :	AC 230V/50Hz	Ant. Polarization:	Vertical
Equipment :	LCD Monitor	Model No :	350LM00005
Temperature :	25°C	Humidity :	52%
Pressure(mbar) :	1001	Date:	2017/06/28

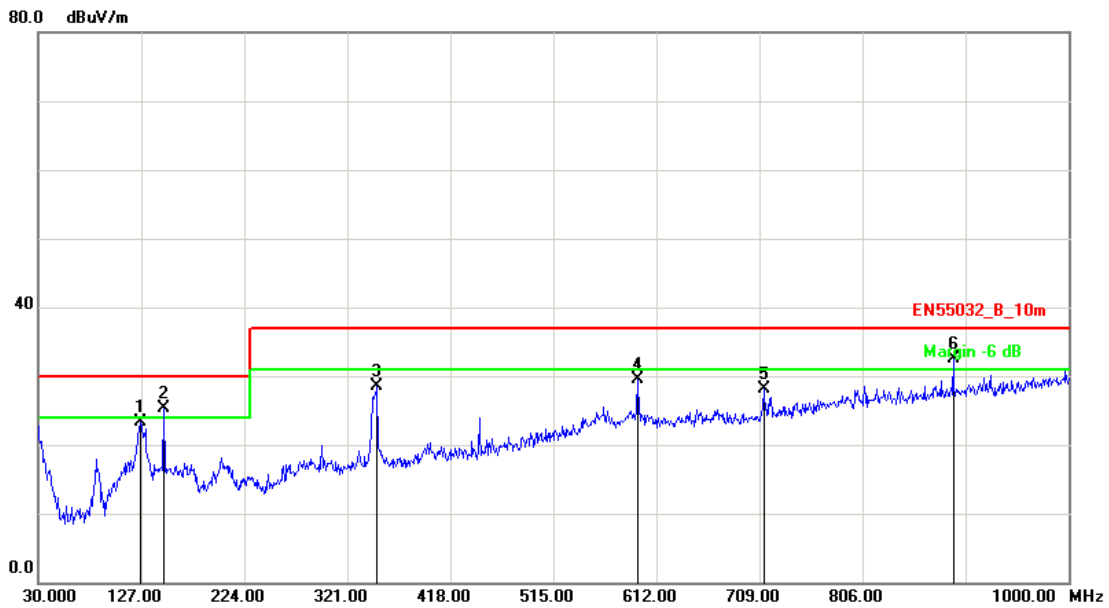

No.	Frequency (MHz)	Factor (dB/m)	Reading (dBuV)	Level (dBuV/m)	Limit (dBuV/m)	Margin (dB)	Det.	Height (cm)	Azimuth (deg)
1	126.0300	-9.81	33.04	23.23	30.00	-6.77	peak	100	317
2	148.3400	-10.60	35.87	25.27	30.00	-4.73	peak	100	320
3	349.1300	-7.36	35.83	28.47	37.00	-8.53	peak	100	198
4	594.5400	-1.32	30.80	29.48	37.00	-7.52	peak	400	0
5	712.8800	0.15	27.92	28.07	37.00	-8.93	peak	400	30
6	891.3600	3.32	29.26	32.58	37.00	-4.42	peak	100	231

Note: Measurement Level = Reading Level + Correct Factor



Test Mode :	Mode 8: Full system (HDMI mode 3440*1440@50Hz) Signal from PC (110V/60Hz)		
AC Power :	AC 110V/60Hz	Ant. Polarization:	Horizontal
Equipment :	LCD Monitor	Model No :	350LM00005
Temperature :	25°C	Humidity :	52%
Pressure(mbar) :	1001	Date:	2017/06/28

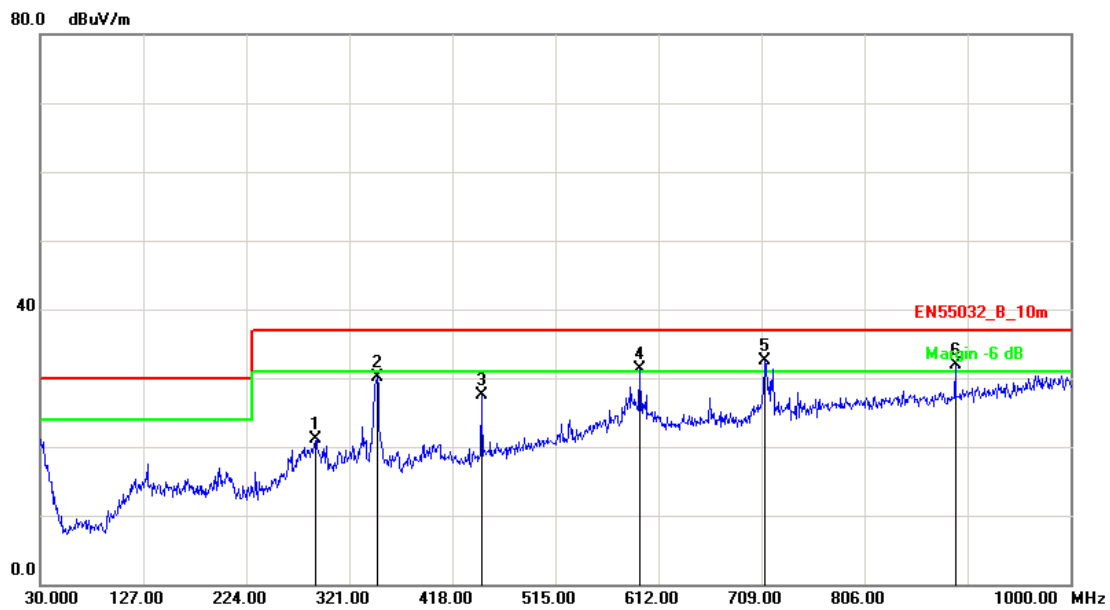

No.	Frequency (MHz)	Factor (dB/m)	Reading (dBuV)	Level (dBuV/m)	Limit (dBuV/m)	Margin (dB)	Det.	Height (cm)	Azimuth (deg)
1	289.9599	-8.80	29.95	21.15	37.00	-15.85	peak	400	142
2	347.1899	-7.45	37.50	30.05	37.00	-6.95	peak	400	227
3	445.1600	-4.67	32.08	27.41	37.00	-9.59	peak	200	227
4	594.5399	-1.32	32.63	31.31	37.00	-5.69	peak	100	227
5	711.9099	0.13	32.40	32.53	37.00	-4.47	peak	400	135
6	891.3600	3.32	28.66	31.98	37.00	-5.02	peak	100	248

Note: Measurement Level = Reading Level + Correct Factor



Test Mode :	Mode 8: Full system (HDMI mode 3440*1440@50Hz) Signal from PC (110V/60Hz)		
AC Power :	AC 110V/60Hz	Ant. Polarization:	Vertical
Equipment :	LCD Monitor	Model No :	350LM00005
Temperature :	25°C	Humidity :	52%
Pressure(mbar) :	1001	Date:	2017/06/28

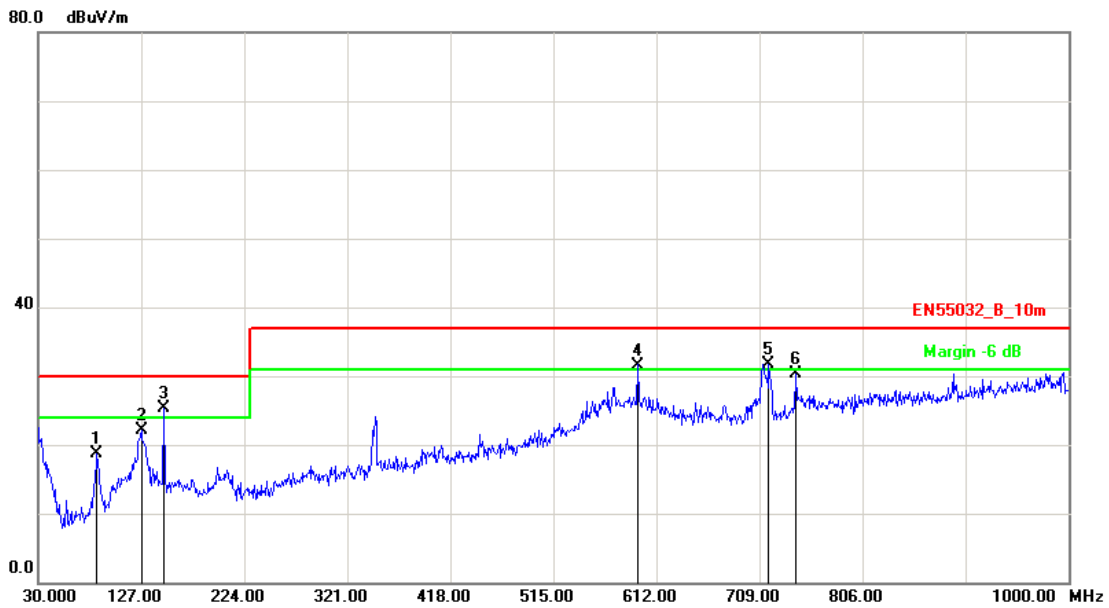

No.	Frequency (MHz)	Factor (dB/m)	Reading (dBuV)	Level (dBuV/m)	Limit (dBuV/m)	Margin (dB)	Det.	Height (cm)	Azimuth (deg)
1	85.2900	-16.28	35.06	18.78	30.00	-11.22	peak	400	91
2	127.0000	-9.85	32.00	22.15	30.00	-7.85	peak	400	287
3	148.3400	-10.60	35.82	25.22	30.00	-4.78	peak	100	314
4	594.5400	-1.32	32.92	31.60	37.00	-5.40	peak	400	25
5	717.7300	0.28	31.50	31.78	37.00	-5.22	peak	100	11
6	742.9500	0.92	29.46	30.38	37.00	-6.62	peak	400	0

Note: Measurement Level = Reading Level + Correct Factor



Test Mode :	Mode 9: Full system (Display mode 3440*1440@100Hz) Signal from PC (110V/60Hz)		
AC Power :	AC 110V/60Hz	Ant. Polarization:	Horizontal
Equipment :	LCD Monitor	Model No :	350LM00005
Temperature :	25°C	Humidity :	52%
Pressure(mbar) :	1001	Date:	2017/06/28

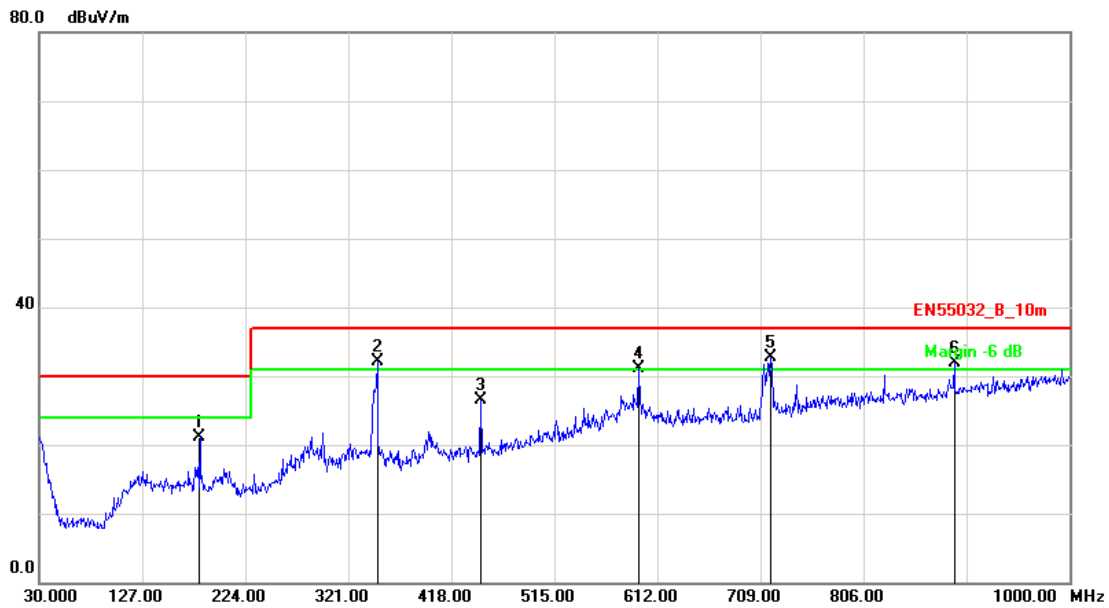

No.	Frequency (MHz)	Factor (dB/m)	Reading (dBuV)	Level (dBuV/m)	Limit (dBuV/m)	Margin (dB)	Det.	Height (cm)	Azimuth (deg)
1	181.3199	-11.38	32.40	21.02	30.00	-8.98	peak	400	0
2	348.1600	-7.40	39.51	32.11	37.00	-4.89	peak	400	195
3	445.1600	-4.67	31.12	26.45	37.00	-10.55	peak	400	245
4	594.5399	-1.32	32.45	31.13	37.00	-5.87	peak	100	297
5	718.7000	0.30	32.39	32.69	37.00	-4.31	peak	200	135
6	891.3600	3.32	28.56	31.88	37.00	-5.12	peak	100	155

Note: Measurement Level = Reading Level + Correct Factor



Test Mode :	Mode 9: Full system (Display mode 3440*1440@100Hz) Signal from PC (110V/60Hz)		
AC Power :	AC 110V/60Hz	Ant. Polarization:	Vertical
Equipment :	LCD Monitor	Model No :	350LM00005
Temperature :	25°C	Humidity :	52%
Pressure(mbar) :	1001	Date:	2017/06/28

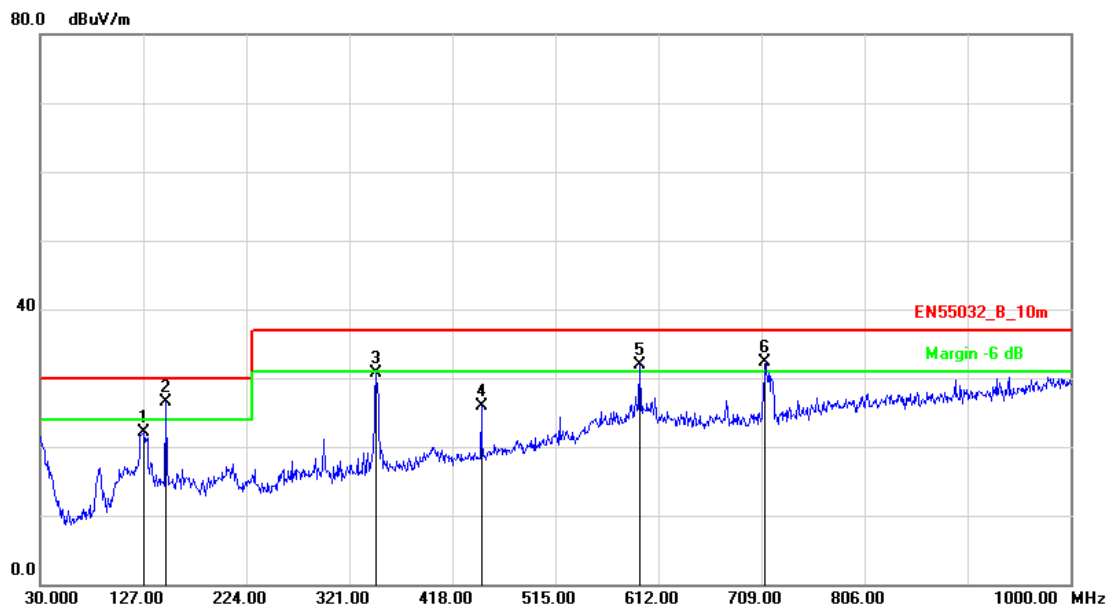

No.	Frequency (MHz)	Factor (dB/m)	Reading (dBuV)	Level (dBuV/m)	Limit (dBuV/m)	Margin (dB)	Det.	Height (cm)	Azimuth (deg)
1	127.9699	-9.90	32.04	22.14	30.00	-7.86	peak	100	290
2	148.3400	-10.60	37.09	26.49	30.00	-3.51	peak	100	327
3	346.2200	-7.50	38.12	30.62	37.00	-6.38	peak	400	203
4	445.1600	-4.67	30.50	25.83	37.00	-11.17	peak	100	234
5	594.5399	-1.32	33.25	31.93	37.00	-5.07	peak	100	330
6	712.8799	0.15	32.23	32.38	37.00	-4.62	peak	100	330

Note: Measurement Level = Reading Level + Correct Factor



Original:

Test Mode :	Mode 1: Full system (HDMI mode 3440*1440@50Hz)(110V/60Hz)		
AC Power :	AC 110V/60Hz	Ant. Polarization:	Horizontal
Equipment :	LCD Monitor	Model No :	350LM00005
Temperature :	23°C	Humidity :	56%
Pressure(mbar) :	1001	Date:	2016/12/14

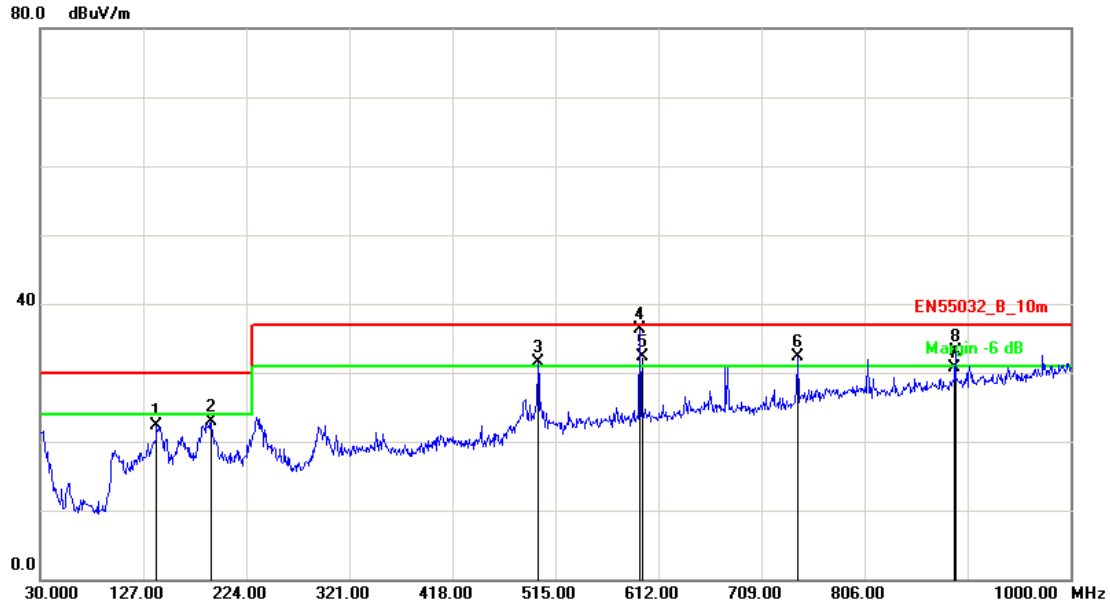

No.	Frequency (MHz)	Factor (dB/m)	Reading (dBuV)	Level (dBuV/m)	Limit (dBuV/m)	Margin (dB)	Det.	Height (cm)	Azimuth (deg)
1	139.6100	-10.40	32.78	22.38	30.00	-7.62	peak	400	210
2	191.0200	-10.62	33.55	22.93	30.00	-7.07	peak	400	231
3	498.5099	-3.06	34.51	31.45	37.00	-5.55	peak	400	190
4	594.5398	-1.32	37.56	36.24	37.00	-0.76	peak	400	190
5	596.7100	-1.29	33.67	32.38	37.00	-4.62	QP	100	228
6	742.9500	0.92	31.40	32.32	37.00	-4.68	peak	100	154
7	890.8700	3.31	27.43	30.74	37.00	-6.26	QP	300	48
8	891.3600	3.32	29.69	33.01	37.00	-3.99	peak	300	217

Note: Measurement Level = Reading Level + Correct Factor



Test Mode :	Mode 1: Full system (HDMI mode 3440*1440@50Hz)(110V/60Hz)		
AC Power :	AC 110V/60Hz	Ant. Polarization:	Vertical
Equipment :	LCD Monitor	Model No :	350LM00005
Temperature :	23°C	Humidity :	56%
Pressure(mbar) :	1001	Date:	2016/12/14

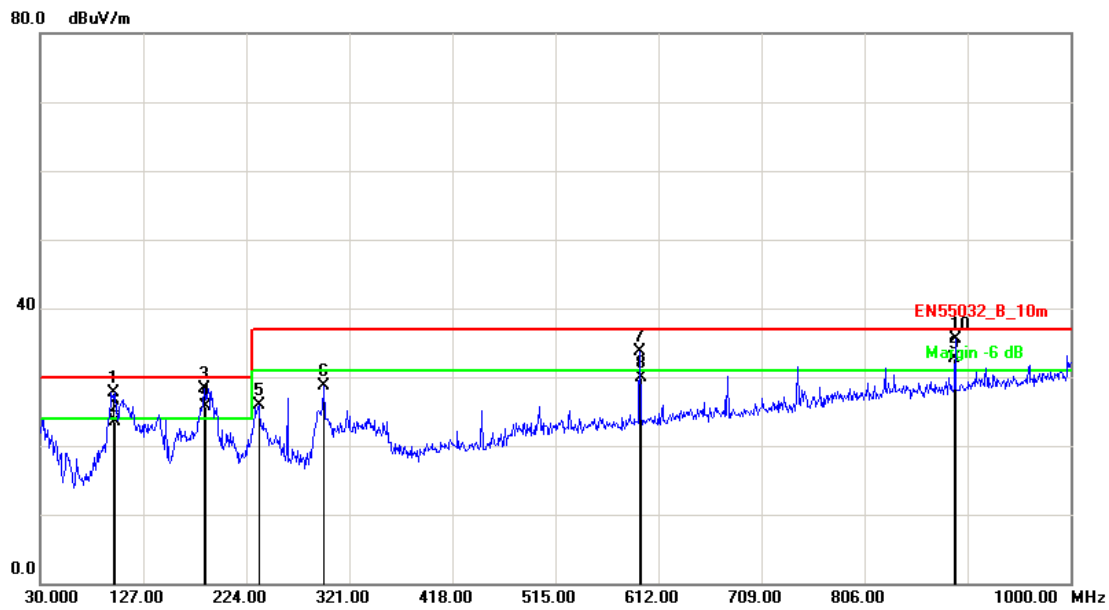

No.	Frequency (MHz)	Factor (dB/m)	Reading (dBuV)	Level (dBuV/m)	Limit (dBuV/m)	Margin (dB)	Det.	Height (cm)	Azimuth (deg)
1	99.8399	-13.84	41.57	27.73	30.00	-2.27	peak	100	114
2	100.3800	-13.72	37.20	23.48	30.00	-6.52	QP	100	114
3	184.2298	-11.15	39.53	28.38	30.00	-1.62	peak	100	320
4	185.3600	-11.06	36.80	25.74	30.00	-4.26	QP	100	320
5	235.6400	-11.09	36.99	25.90	37.00	-11.10	peak	100	299
6	296.7500	-8.77	37.55	28.78	37.00	-8.22	peak	100	212
7	594.5399	-1.32	35.00	33.68	37.00	-3.32	peak	100	15
8	595.2400	-1.31	31.28	29.97	37.00	-7.03	QP	100	123
9	890.8700	3.31	29.41	32.72	37.00	-4.28	QP	100	297
10	891.3600	3.32	32.23	35.55	37.00	-1.45	peak	100	154

Note: Measurement Level = Reading Level + Correct Factor





Test Mode :	Mode 4: Full system (Display mode 3440*1440@100Hz)(110V/60Hz)		
AC Power :	AC 110V/60Hz	Ant. Polarization:	Horizontal
Equipment :	LCD Monitor	Model No :	350LM00005
Temperature :	23°C	Humidity :	56%
Pressure(mbar) :	1001	Date:	2016/12/14

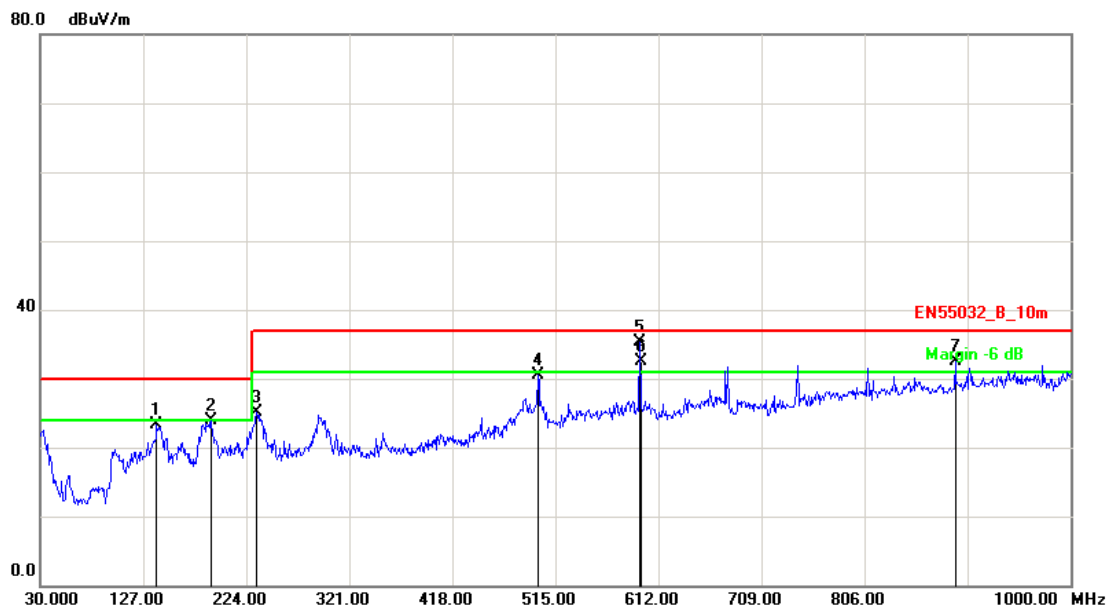

No.	Frequency (MHz)	Factor (dB/m)	Reading (dBuV)	Level (dBuV/m)	Limit (dBuV/m)	Margin (dB)	Det.	Height (cm)	Azimuth (deg)
1	139.6100	-10.40	33.78	23.38	30.00	-6.62	peak	400	277
2	191.0200	-10.62	34.55	23.93	30.00	-6.07	peak	400	360
3	233.6999	-11.19	36.20	25.01	37.00	-11.99	peak	100	360
4	498.5099	-3.06	33.51	30.45	37.00	-6.55	peak	100	198
5	594.5398	-1.32	36.56	35.24	37.00	-1.76	peak	400	114
6	595.3800	-1.31	33.74	32.43	37.00	-4.57	QP	400	52
7	891.3600	3.32	29.19	32.51	37.00	-4.49	peak	400	6

Note: Measurement Level = Reading Level + Correct Factor



Test Mode :	Mode 4: Full system (Display mode 3440*1440@100Hz)(110V/60Hz)		
AC Power :	AC 110V/60Hz	Ant. Polarization:	Vertical
Equipment :	LCD Monitor	Model No :	350LM00005
Temperature :	23°C	Humidity :	56%
Pressure(mbar) :	1001	Date:	2016/12/14

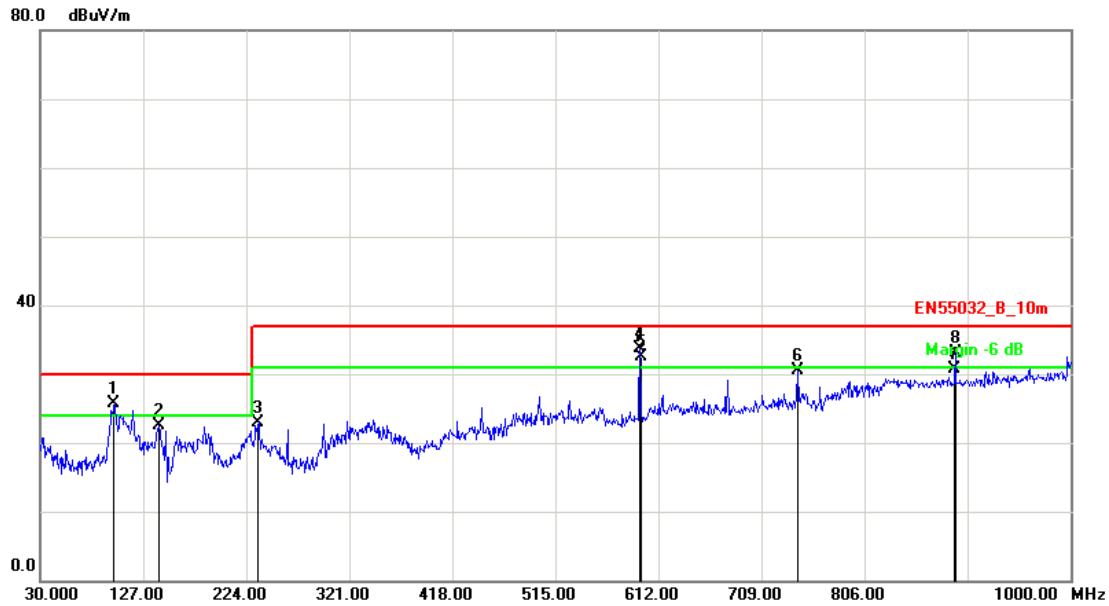

No.	Frequency (MHz)	Factor (dB/m)	Reading (dBuV)	Level (dBuV/m)	Limit (dBuV/m)	Margin (dB)	Det.	Height (cm)	Azimuth (deg)
1	99.8399	-13.84	39.57	25.73	30.00	-4.27	peak	100	344
2	141.5500	-10.45	32.98	22.53	30.00	-7.47	peak	400	186
3	235.6399	-11.09	33.99	22.90	37.00	-14.10	peak	400	241
4	594.5398	-1.32	35.00	33.68	37.00	-3.32	peak	100	0
5	595.8200	-1.30	33.79	32.49	37.00	-4.51	QP	100	289
6	742.9500	0.92	29.51	30.43	37.00	-6.57	peak	100	67
7	891.0700	3.31	27.46	30.77	37.00	-6.23	QP	100	32
8	891.3600	3.32	29.73	33.05	37.00	-3.95	peak	100	115

Note: Measurement Level = Reading Level + Correct Factor



Test Mode :	Mode 8: Full system (HDMI mode 3440*1440@50Hz)(230V/50Hz)		
AC Power :	AC 230V/50Hz	Ant. Polarization:	Horizontal
Equipment :	LCD Monitor	Model No :	350LM00005
Temperature :	23°C	Humidity :	56%
Pressure(mbar) :	1001	Date:	2016/12/14

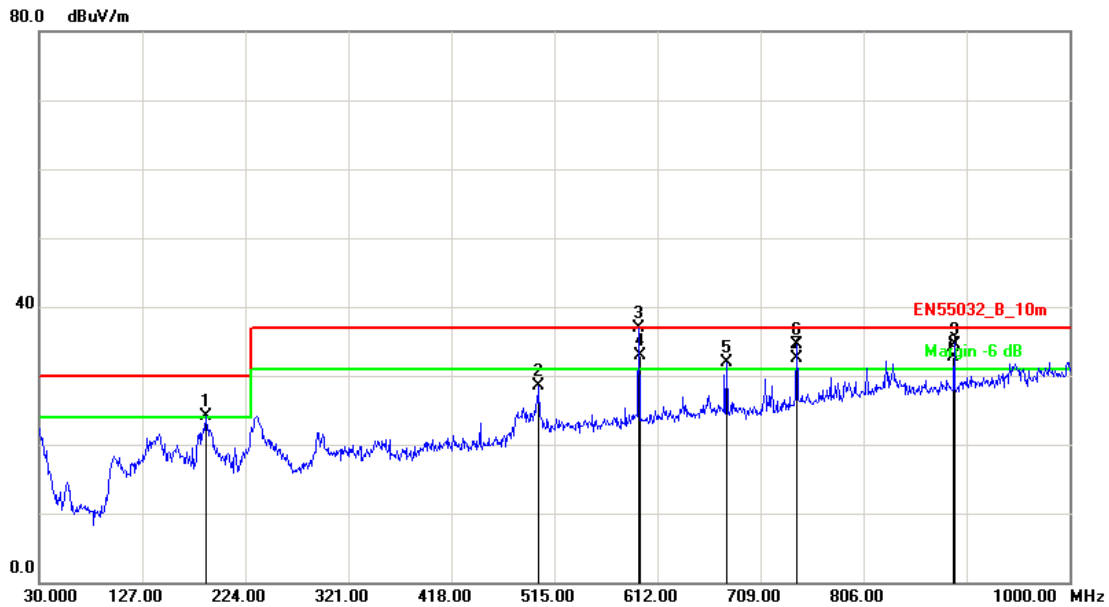

No.	Frequency (MHz)	Factor (dB/m)	Reading (dBuV)	Level (dBuV/m)	Limit (dBuV/m)	Margin (dB)	Det.	Height (cm)	Azimuth (deg)
1	187.1399	-10.92	35.07	24.15	30.00	-5.85	peak	400	227
2	500.4499	-3.00	31.42	28.42	37.00	-8.58	peak	100	5
3	594.5398	-1.32	38.16	36.84	37.00	-0.16	peak	100	227
4	595.8100	-1.30	34.22	32.92	37.00	-4.08	QP	100	326
5	676.9900	-0.13	31.97	31.84	37.00	-5.16	peak	400	0
6	742.9500	0.92	33.56	34.48	37.00	-2.52	peak	400	274
7	743.6800	0.94	31.60	32.54	37.00	-4.46	QP	400	118
8	890.6500	3.30	29.34	32.64	37.00	-4.36	QP	100	0
9	891.3600	3.32	31.28	34.60	37.00	-2.40	peak	100	97

Note: Measurement Level = Reading Level + Correct Factor



Test Mode :	Mode 8: Full system (HDMI mode 3440*1440@50Hz)(230V/50Hz)		
AC Power :	AC 230V/50Hz	Ant. Polarization:	Vertical
Equipment :	LCD Monitor	Model No :	350LM00005
Temperature :	23°C	Humidity :	56%
Pressure(mbar) :	1001	Date:	2016/12/14

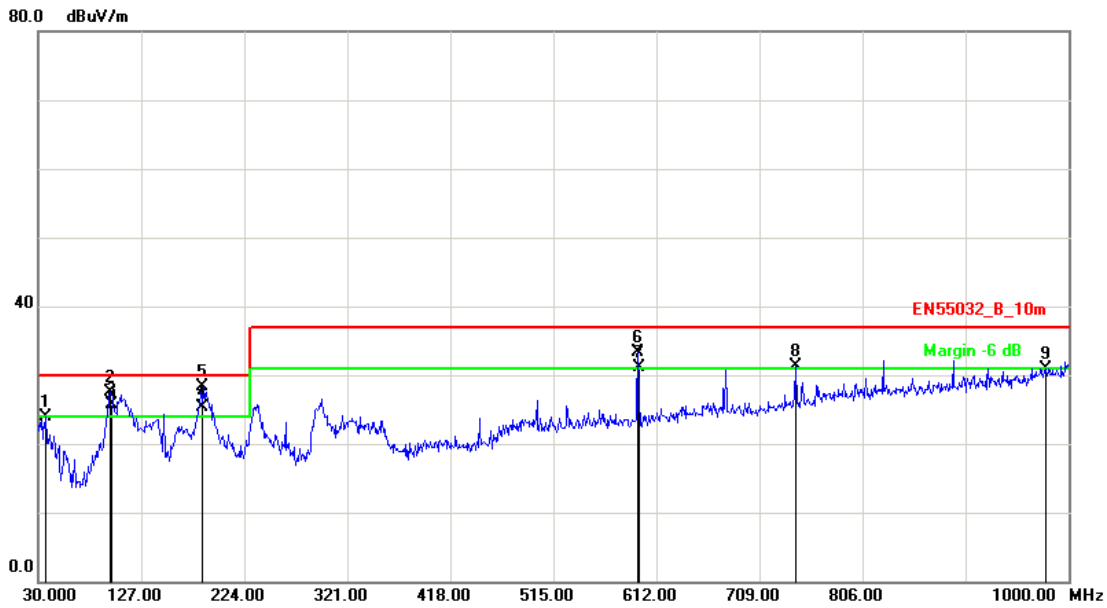

No.	Frequency (MHz)	Factor (dB/m)	Reading (dBuV)	Level (dBuV/m)	Limit (dBuV/m)	Margin (dB)	Det.	Height (cm)	Azimuth (deg)
1	36.7899	-8.16	31.99	23.83	30.00	-6.17	peak	100	269
2	97.9000	-14.33	41.89	27.56	30.00	-2.44	peak	100	132
3	98.7400	-14.12	39.78	25.66	30.00	-4.34	QP	100	57
4	184.3500	-11.14	36.49	25.35	30.00	-4.65	QP	100	27
5	185.1999	-11.07	39.47	28.40	30.00	-1.60	peak	100	329
6	594.5398	-1.32	34.53	33.21	37.00	-3.79	peak	100	256
7	595.3400	-1.31	32.50	31.19	37.00	-5.81	QP	100	360
8	742.9500	0.92	30.48	31.40	37.00	-5.60	peak	400	187
9	978.6598	4.77	26.12	30.89	37.00	-6.11	peak	400	360

Note: Measurement Level = Reading Level + Correct Factor



Test Mode :	Mode 11: Full system (Display mode 3440*1440@100Hz)(230V/50Hz)		
AC Power :	AC 230V/50Hz	Ant. Polarization:	Horizontal
Equipment :	LCD Monitor	Model No :	350LM00005
Temperature :	23°C	Humidity :	56%
Pressure(mbar) :	1001	Date:	2016/12/14

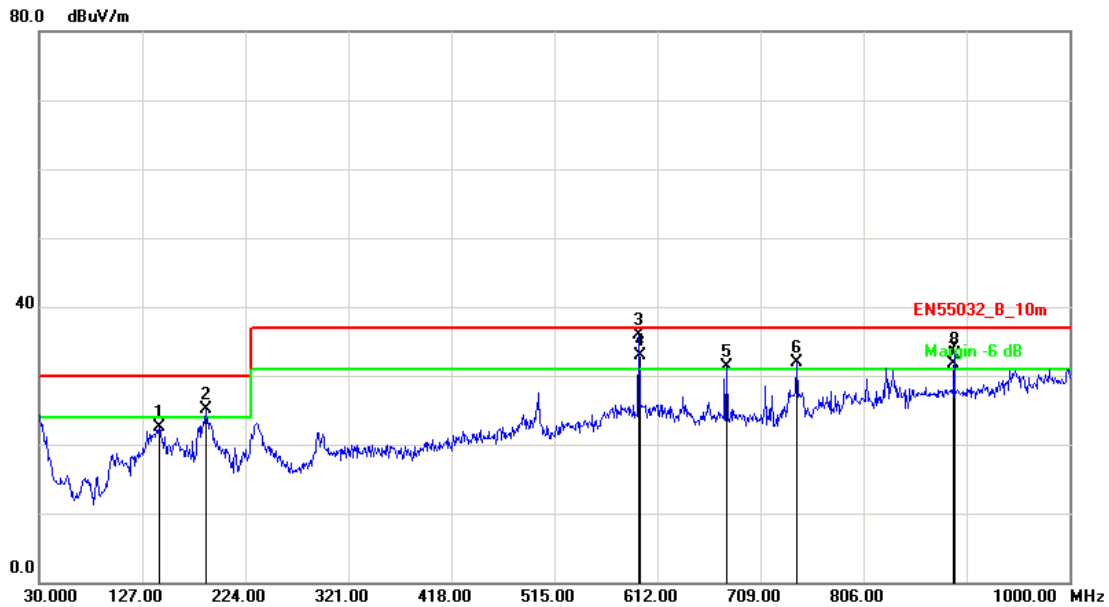

No.	Frequency (MHz)	Factor (dB/m)	Reading (dBuV)	Level (dBuV/m)	Limit (dBuV/m)	Margin (dB)	Det.	Height (cm)	Azimuth (deg)
1	143.4900	-10.50	33.07	22.57	30.00	-7.43	peak	100	3
2	187.1399	-10.92	36.07	25.15	30.00	-4.85	peak	100	84
3	594.5398	-1.32	37.16	35.84	37.00	-1.16	peak	400	152
4	595.2199	-1.31	34.18	32.87	37.00	-4.13	QP	400	26
5	676.9900	-0.13	31.47	31.34	37.00	-5.66	peak	400	210
6	742.9500	0.92	31.06	31.98	37.00	-5.02	peak	100	217
7	890.3700	3.30	28.37	31.67	37.00	-5.33	QP	400	0
8	891.3600	3.32	29.81	33.13	37.00	-3.87	peak	400	94

Note: Measurement Level = Reading Level + Correct Factor



Test Mode :	Mode 11: Full system (Display mode 3440*1440@100Hz)(230V/50Hz)		
AC Power :	AC 230V/50Hz	Ant. Polarization:	Vertical
Equipment :	LCD Monitor	Model No :	350LM00005
Temperature :	23°C	Humidity :	56%
Pressure(mbar) :	1001	Date:	2016/12/14

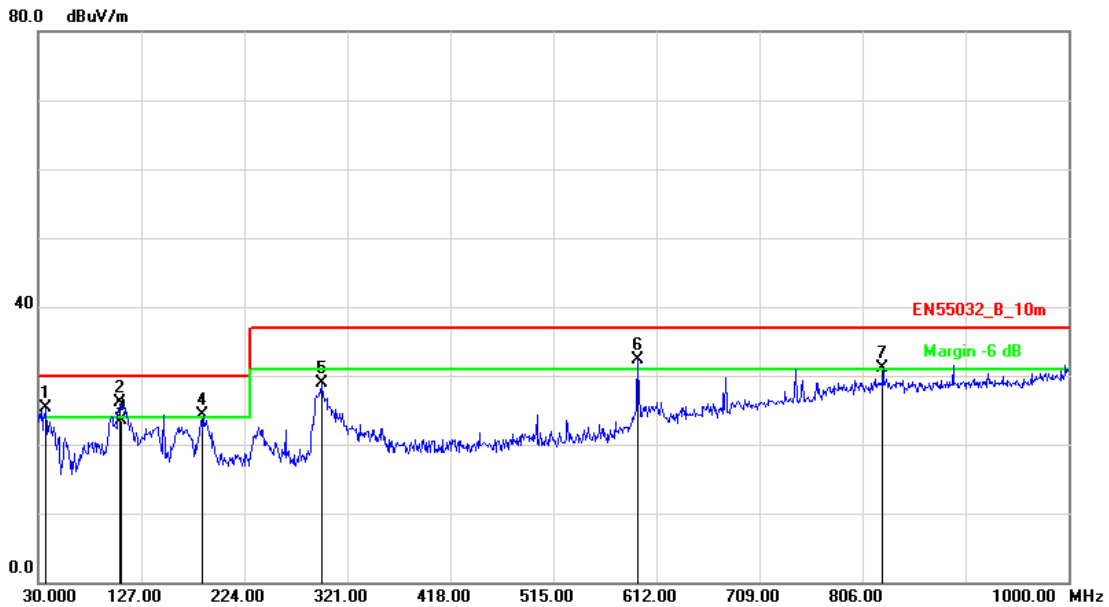

No.	Frequency (MHz)	Factor (dB/m)	Reading (dBuV)	Level (dBuV/m)	Limit (dBuV/m)	Margin (dB)	Det.	Height (cm)	Azimuth (deg)
1	36.7899	-8.16	33.49	25.33	30.00	-4.67	peak	100	297
2	107.5999	-12.19	38.24	26.05	30.00	-3.95	peak	100	350
3	108.3000	-12.04	35.64	23.60	30.00	-6.40	QP	100	112
4	185.1999	-11.07	35.47	24.40	30.00	-5.60	peak	100	62
5	296.7500	-8.77	37.72	28.95	37.00	-8.05	peak	400	44
6	594.5398	-1.32	33.53	32.21	37.00	-4.79	peak	100	187
7	825.3999	2.37	28.66	31.03	37.00	-5.97	peak	400	23

Note: Measurement Level = Reading Level + Correct Factor



### 5.6. Test Result and Data (1GHz ~ 6GHz)

Second edition:

Test Mode :	Mode 1: Full system (HDMI mode 3440*1440@50Hz) Signal from PC (230V/50Hz)		
AC Power :	AC 230V/50Hz	Ant. Polarization:	Horizontal
Equipment :	LCD Monitor	Model No :	350LM00005
Temperature :	25°C	Humidity :	52%
Pressure(mbar) :	1001	Date:	2017/06/28

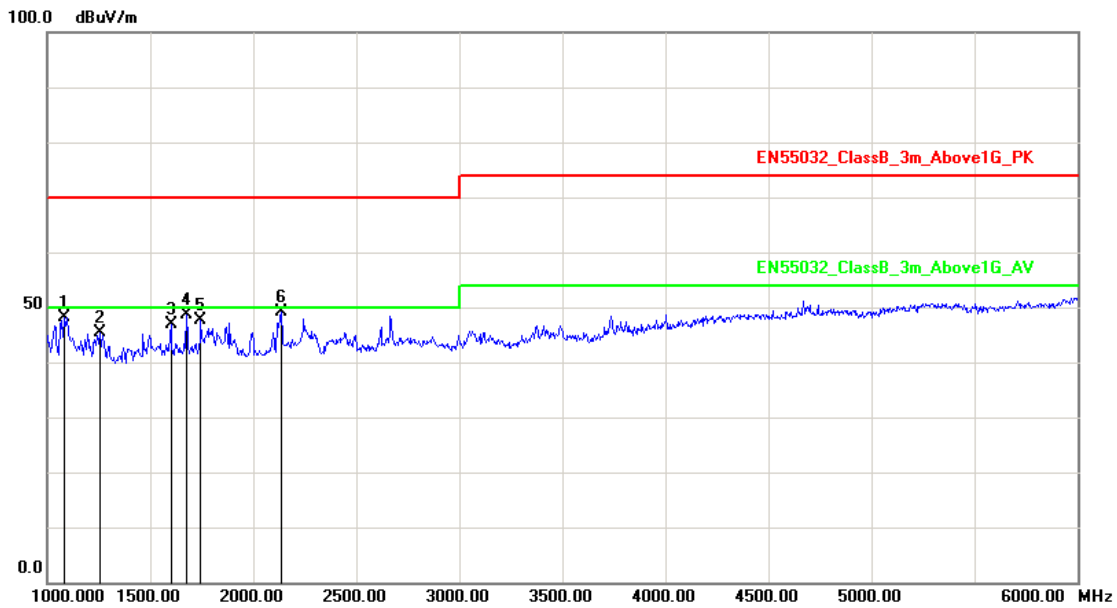

No.	Frequency (MHz)	Factor (dB/m)	Reading (dBuV)	Level (dBuV/m)	Limit (dBuV/m)	Margin (dB)	Det.	Height (cm)	Azimuth (deg)
1	1080.000	-5.45	53.68	48.23	70.00	-21.77	peak	200	114
2	1255.000	-4.28	49.60	45.32	70.00	-24.68	peak	100	78
3	1600.000	-2.35	49.32	46.97	70.00	-23.03	peak	200	114
4	1675.000	-2.14	50.68	48.54	70.00	-21.46	peak	200	62
5	1745.000	-1.93	49.57	47.64	70.00	-22.36	peak	100	0
6	2135.000	-0.51	49.59	49.08	70.00	-20.92	peak	200	359

Note: Measurement Level = Reading Level + Correct Factor



Test Mode :	Mode 1: Full system (HDMI mode 3440*1440@50Hz) Signal from PC (230V/50Hz)		
AC Power :	AC 230V/50Hz	Ant. Polarization:	Vertical
Equipment :	LCD Monitor	Model No :	350LM00005
Temperature :	25°C	Humidity :	52%
Pressure(mbar) :	1001	Date:	2017/06/28

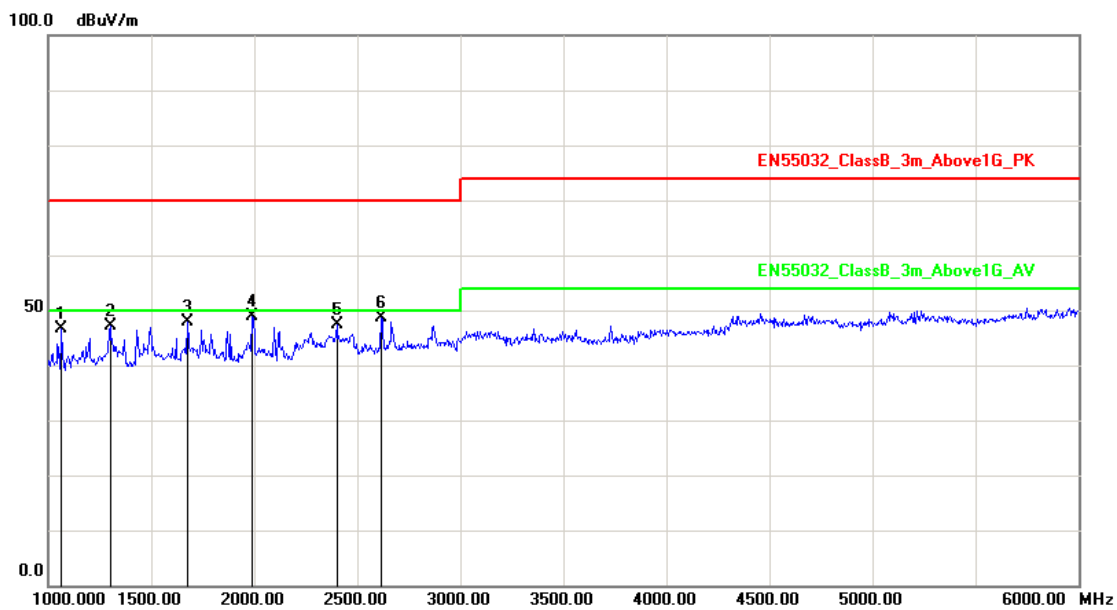

No.	Frequency (MHz)	Factor (dB/m)	Reading (dBuV)	Level (dBuV/m)	Limit (dBuV/m)	Margin (dB)	Det.	Height (cm)	Azimuth (deg)
1	1065.000	-5.55	52.09	46.54	70.00	-23.46	peak	100	336
2	1300.000	-3.98	51.18	47.20	70.00	-22.80	peak	100	59
3	1675.000	-2.14	49.94	47.80	70.00	-22.20	peak	200	278
4	1990.000	-1.23	50.17	48.94	70.00	-21.06	peak	100	41
5	2400.000	0.84	46.48	47.32	70.00	-22.68	peak	100	152
6	2615.000	1.99	46.67	48.66	70.00	-21.34	peak	200	0

Note: Measurement Level = Reading Level + Correct Factor





Test Mode :	Mode 4: Full system (Display mode 3440*1440@100Hz) Signal from PC (230V/50Hz)		
AC Power :	AC 230V/50Hz	Ant. Polarization:	Horizontal
Equipment :	LCD Monitor	Model No :	350LM00005
Temperature :	25°C	Humidity :	52%
Pressure(mbar) :	1001	Date:	2017/06/28

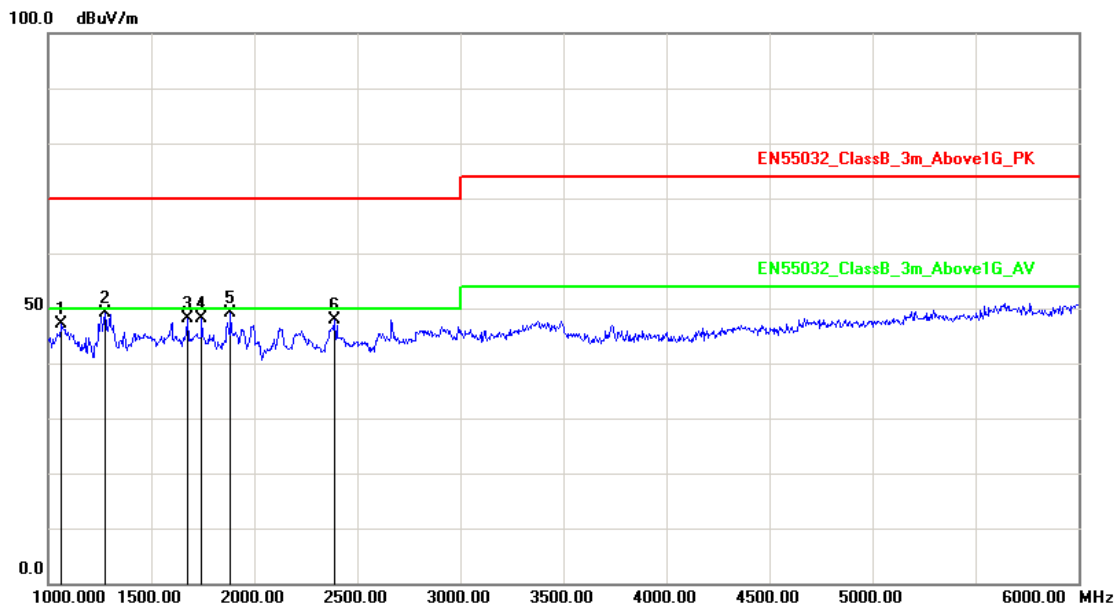

No.	Frequency (MHz)	Factor (dB/m)	Reading (dBuV)	Level (dBuV/m)	Limit (dBuV/m)	Margin (dB)	Det.	Height (cm)	Azimuth (deg)
1	1065.000	-5.55	52.80	47.25	70.00	-22.75	peak	200	277
2	1275.000	-4.14	53.17	49.03	70.00	-20.97	peak	100	0
3	1675.000	-2.14	50.18	48.04	70.00	-21.96	peak	100	81
4	1745.000	-1.93	50.07	48.14	70.00	-21.86	peak	100	62
5	1885.000	-1.53	50.62	49.09	70.00	-20.91	peak	200	359
6	2390.000	0.79	46.98	47.77	70.00	-22.23	peak	200	351

Note: Measurement Level = Reading Level + Correct Factor



Test Mode :	Mode 4: Full system (Display mode 3440*1440@100Hz) Signal from PC (230V/50Hz)		
AC Power :	AC 230V/50Hz	Ant. Polarization:	Vertical
Equipment :	LCD Monitor	Model No :	350LM00005
Temperature :	25°C	Humidity :	52%
Pressure(mbar) :	1001	Date:	2017/06/28

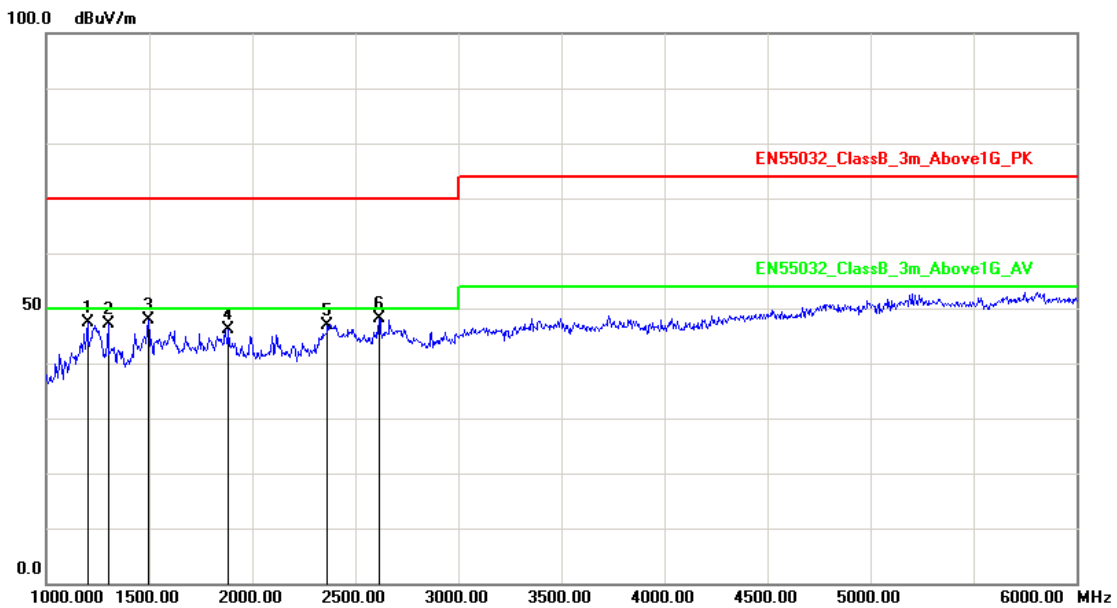

No.	Frequency (MHz)	Factor (dB/m)	Reading (dBuV)	Level (dBuV/m)	Limit (dBuV/m)	Margin (dB)	Det.	Height (cm)	Azimuth (deg)
1	1200.000	-4.64	52.07	47.43	70.00	-22.57	peak	200	229
2	1300.000	-3.98	51.18	47.20	70.00	-22.80	peak	100	357
3	1495.000	-2.67	50.46	47.79	70.00	-22.21	peak	100	360
4	1885.000	-1.53	47.76	46.23	70.00	-23.77	peak	100	246
5	2365.000	0.66	46.16	46.82	70.00	-23.18	peak	100	81
6	2615.000	1.99	46.17	48.16	70.00	-21.84	peak	200	0

Note: Measurement Level = Reading Level + Correct Factor



Test Mode :	Mode 8: Full system (HDMI mode 3440*1440@50Hz) Signal from PC (110V/60Hz)		
AC Power :	AC 110V/60Hz	Ant. Polarization:	Horizontal
Equipment :	LCD Monitor	Model No :	350LM00005
Temperature :	25°C	Humidity :	52%
Pressure(mbar) :	1001	Date:	2017/06/28

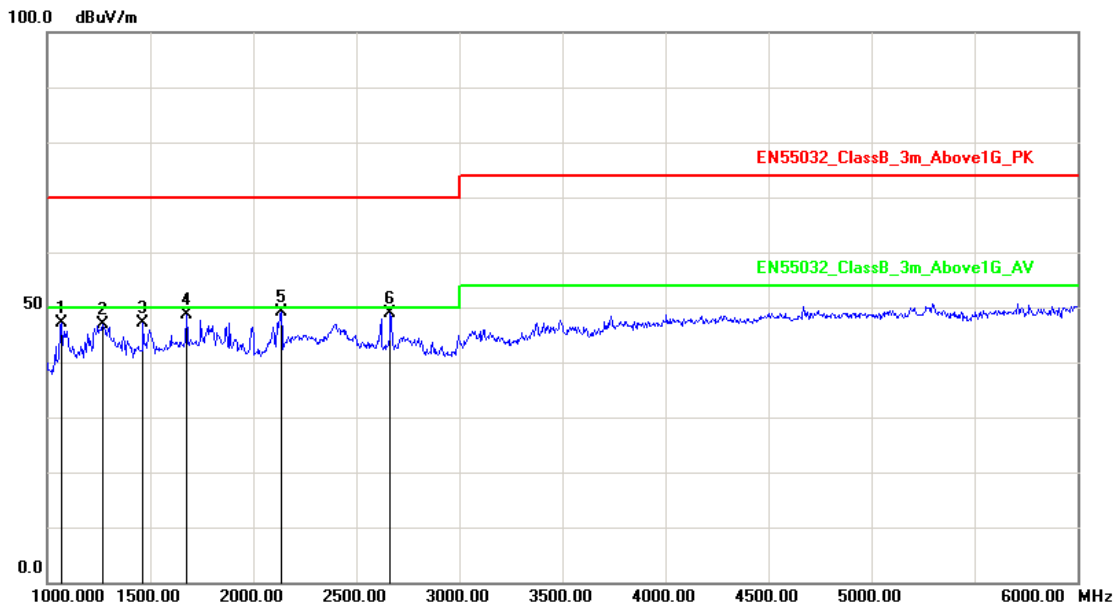

No.	Frequency (MHz)	Factor (dB/m)	Reading (dBuV)	Level (dBuV/m)	Limit (dBuV/m)	Margin (dB)	Det.	Height (cm)	Azimuth (deg)
1	1070.000	-5.51	52.66	47.15	70.00	-22.85	peak	200	215
2	1270.000	-4.18	51.00	46.82	70.00	-23.18	peak	100	0
3	1465.000	-2.87	50.09	47.22	70.00	-22.78	peak	200	74
4	1675.000	-2.14	50.68	48.54	70.00	-21.46	peak	100	119
5	2135.000	-0.51	49.59	49.08	70.00	-20.92	peak	200	332
6	2665.000	2.26	46.63	48.89	70.00	-21.11	peak	200	0

Note: Measurement Level = Reading Level + Correct Factor



Test Mode :	Mode 8: Full system (HDMI mode 3440*1440@50Hz) Signal from PC (110V/60Hz)		
AC Power :	AC 110V/60Hz	Ant. Polarization:	Vertical
Equipment :	LCD Monitor	Model No :	350LM00005
Temperature :	25°C	Humidity :	52%
Pressure(mbar) :	1001	Date:	2017/06/28

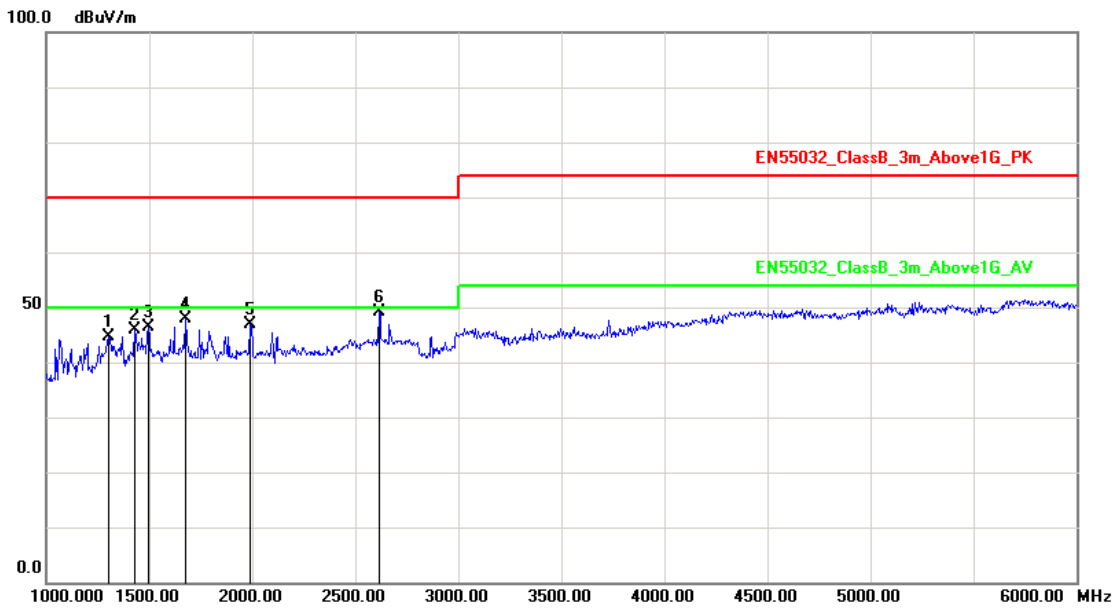

No.	Frequency (MHz)	Factor (dB/m)	Reading (dBuV)	Level (dBuV/m)	Limit (dBuV/m)	Margin (dB)	Det.	Height (cm)	Azimuth (deg)
1	1300.000	-3.98	48.68	44.70	70.00	-25.30	peak	200	115
2	1430.000	-3.11	49.06	45.95	70.00	-24.05	peak	135	62
3	1495.000	-2.67	48.96	46.29	70.00	-23.71	peak	100	0
4	1675.000	-2.14	49.94	47.80	70.00	-22.20	peak	100	118
5	1990.000	-1.23	48.17	46.94	70.00	-23.06	peak	100	74
6	2615.000	1.99	47.17	49.16	70.00	-20.84	peak	200	0

Note: Measurement Level = Reading Level + Correct Factor



Test Mode :	Mode 9: Full system (Display mode 3440*1440@100Hz) Signal from PC (110V/60Hz)		
AC Power :	AC 110V/60Hz	Ant. Polarization:	Horizontal
Equipment :	LCD Monitor	Model No :	350LM00005
Temperature :	25°C	Humidity :	52%
Pressure(mbar) :	1001	Date:	2017/06/28

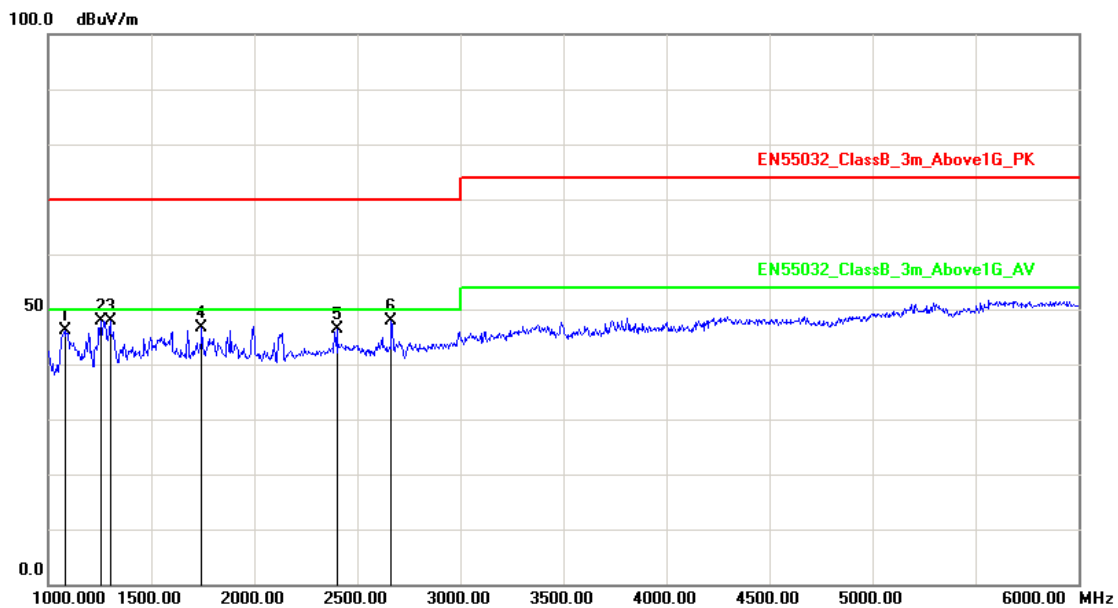

No.	Frequency (MHz)	Factor (dB/m)	Reading (dBuV)	Level (dBuV/m)	Limit (dBuV/m)	Margin (dB)	Det.	Height (cm)	Azimuth (deg)
1	1080.000	-5.45	51.68	46.23	70.00	-23.77	peak	100	51
2	1255.000	-4.28	52.10	47.82	70.00	-22.18	peak	200	163
3	1300.000	-3.98	51.92	47.94	70.00	-22.06	peak	200	244
4	1745.000	-1.93	48.57	46.64	70.00	-23.36	peak	200	67
5	2400.000	0.84	45.46	46.30	70.00	-23.70	peak	100	359
6	2665.000	2.26	45.63	47.89	70.00	-22.11	peak	200	359

Note: Measurement Level = Reading Level + Correct Factor



Test Mode :	Mode 9: Full system (Display mode 3440*1440@100Hz) Signal from PC (110V/60Hz)		
AC Power :	AC 110V/60Hz	Ant. Polarization:	Vertical
Equipment :	LCD Monitor	Model No :	350LM00005
Temperature :	25°C	Humidity :	52%
Pressure(mbar) :	1001	Date:	2017/06/28

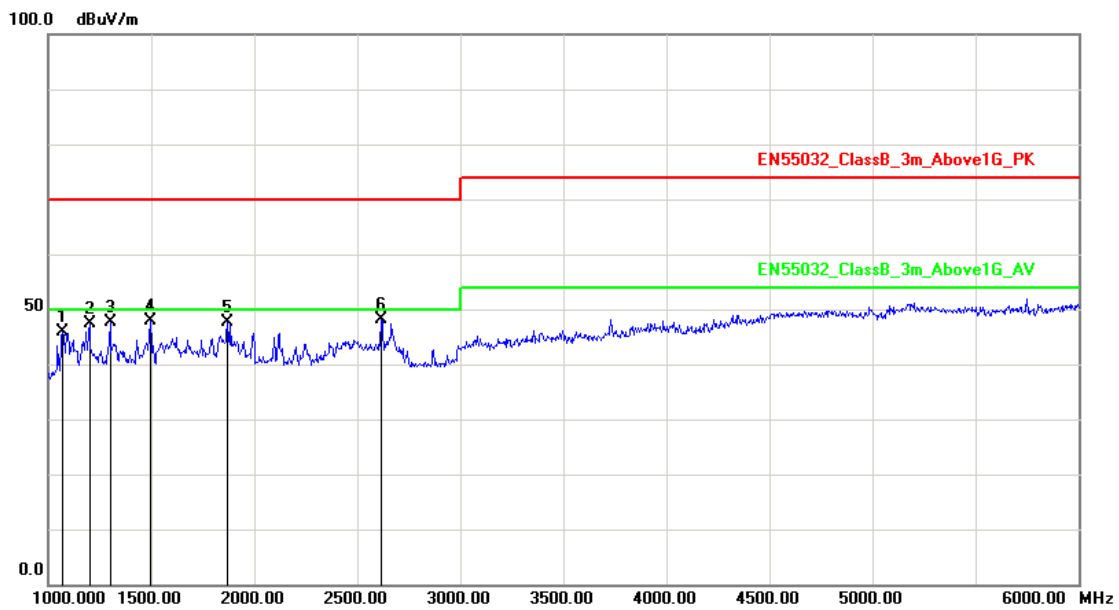

No.	Frequency (MHz)	Factor (dB/m)	Reading (dBuV)	Level (dBuV/m)	Limit (dBuV/m)	Margin (dB)	Det.	Height (cm)	Azimuth (deg)
1	1070.000	-5.51	51.38	45.87	70.00	-24.13	peak	100	116
2	1200.000	-4.64	52.07	47.43	70.00	-22.57	peak	200	0
3	1300.000	-3.98	51.68	47.70	70.00	-22.30	peak	100	226
4	1495.000	-2.67	50.46	47.79	70.00	-22.21	peak	100	345
5	1870.000	-1.57	49.09	47.52	70.00	-22.48	peak	200	217
6	2615.000	1.99	46.17	48.16	70.00	-21.84	peak	100	84

Note: Measurement Level = Reading Level + Correct Factor



Original:

Test Mode :	Mode 1: Full system (HDMI mode 3440*1440@50Hz)(110V/60Hz)		
AC Power :	AC 110V/60Hz	Ant. Polarization:	Horizontal
Equipment :	LCD Monitor	Model No :	350LM00005
Temperature :	23°C	Humidity :	56%
Pressure(mbar) :	1001	Date:	2016/12/14

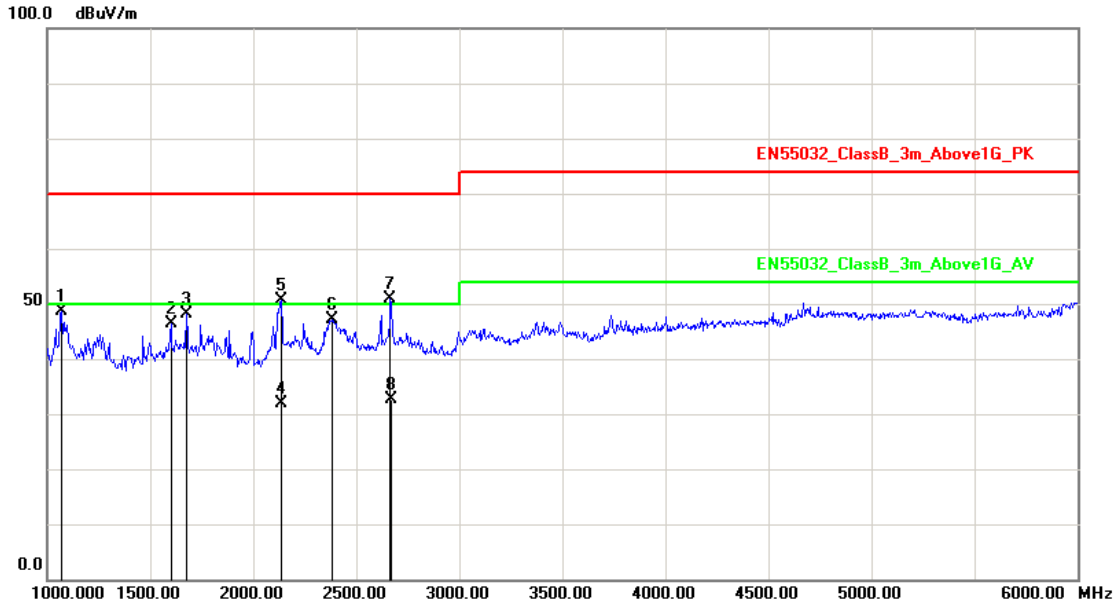

No.	Frequency (MHz)	Factor (dB/m)	Reading (dBuV)	Level (dBuV/m)	Limit (dBuV/m)	Margin (dB)	Det.	Height (cm)	Azimuth (deg)
1	1070.000	-5.51	54.16	48.65	70.00	-21.35	peak	200	157
2	1600.000	-2.35	48.82	46.47	70.00	-23.53	peak	200	23
3	1675.000	-2.14	50.18	48.04	70.00	-21.96	peak	100	0
4	2134.000	-0.52	32.46	31.94	50.00	-18.06	AVG	200	2
5	2135.000	-0.51	51.09	50.58	70.00	-19.42	peak	200	136
6	2385.000	0.76	46.37	47.13	70.00	-22.87	peak	100	341
7	2665.000	2.26	48.63	50.89	70.00	-19.11	peak	200	196
8	2667.000	2.28	30.47	32.75	50.00	-17.25	AVG	200	274

Note: Measurement Level = Reading Level + Correct Factor



Test Mode :	Mode 1: Full system (HDMI mode 3440*1440@50Hz)(110V/60Hz)		
AC Power :	AC 110V/60Hz	Ant. Polarization:	Vertical
Equipment :	LCD Monitor	Model No :	350LM00005
Temperature :	23°C	Humidity :	56%
Pressure(mbar) :	1001	Date:	2016/12/14

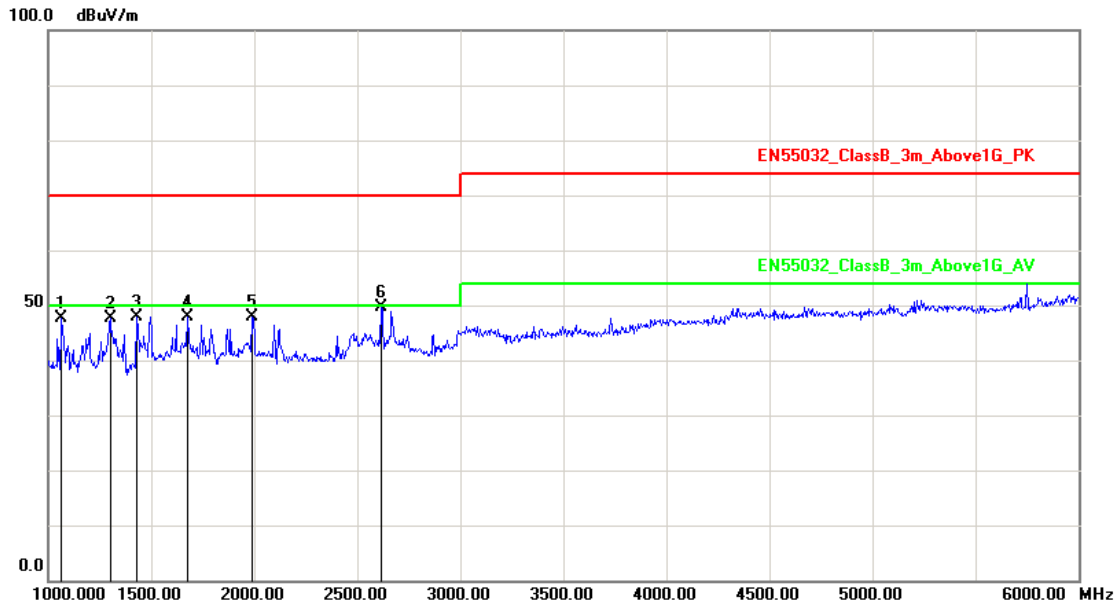

No.	Frequency (MHz)	Factor (dB/m)	Reading (dBuV)	Level (dBuV/m)	Limit (dBuV/m)	Margin (dB)	Det.	Height (cm)	Azimuth (deg)
1	1065.000	-5.55	53.09	47.54	70.00	-22.46	peak	200	291
2	1300.000	-3.98	51.68	47.70	70.00	-22.30	peak	100	42
3	1430.000	-3.11	51.06	47.95	70.00	-22.05	peak	200	0
4	1675.000	-2.14	49.94	47.80	70.00	-22.20	peak	100	118
5	1990.000	-1.23	49.17	47.94	70.00	-22.06	peak	100	187
6	2615.000	1.99	47.67	49.66	70.00	-20.34	peak	100	30

Note: Measurement Level = Reading Level + Correct Factor





Test Mode :	Mode 4: Full system (Display mode 3440*1440@100Hz)(110V/60Hz)		
AC Power :	AC 110V/60Hz	Ant. Polarization:	Horizontal
Equipment :	LCD Monitor	Model No :	350LM00005
Temperature :	23°C	Humidity :	56%
Pressure(mbar) :	1001	Date:	2016/12/14

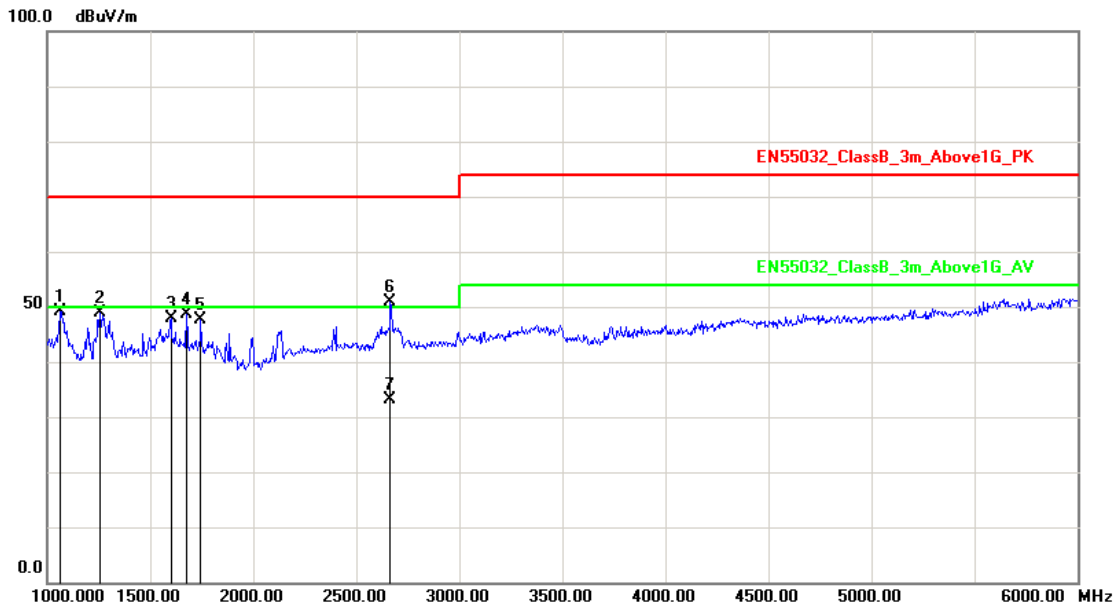

No.	Frequency (MHz)	Factor (dB/m)	Reading (dBuV)	Level (dBuV/m)	Limit (dBuV/m)	Margin (dB)	Det.	Height (cm)	Azimuth (deg)
1	1065.000	-5.55	54.80	49.25	70.00	-20.75	peak	200	0
2	1255.000	-4.28	53.10	48.82	70.00	-21.18	peak	100	41
3	1600.000	-2.35	50.32	47.97	70.00	-22.03	peak	200	216
4	1675.000	-2.14	50.68	48.54	70.00	-21.46	peak	100	0
5	1745.000	-1.93	49.57	47.64	70.00	-22.36	peak	100	37
6	2665.000	2.26	48.63	50.89	70.00	-19.11	peak	200	163
7	2666.000	2.27	30.81	33.08	50.00	-16.92	AVG	200	298

Note: Measurement Level = Reading Level + Correct Factor



Test Mode :	Mode 4: Full system (Display mode 3440*1440@100Hz)(110V/60Hz)		
AC Power :	AC 110V/60Hz	Ant. Polarization:	Vertical
Equipment :	LCD Monitor	Model No :	350LM00005
Temperature :	23°C	Humidity :	56%
Pressure(mbar) :	1001	Date:	2016/12/14

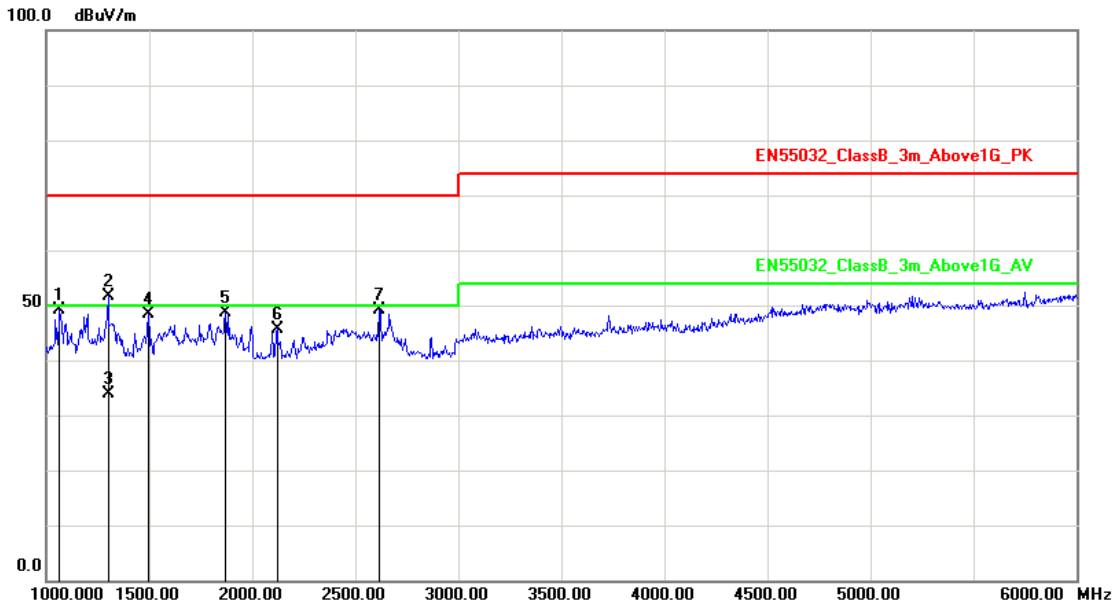

No.	Frequency (MHz)	Factor (dB/m)	Reading (dBuV)	Level (dBuV/m)	Limit (dBuV/m)	Margin (dB)	Det.	Height (cm)	Azimuth (deg)
1	1065.000	-5.55	54.59	49.04	70.00	-20.96	peak	200	16
2	1300.000	-3.98	55.68	51.70	70.00	-18.30	peak	100	339
3	1301.000	-3.97	37.84	33.87	50.00	-16.13	AVG	100	215
4	1495.000	-2.67	50.96	48.29	70.00	-21.71	peak	200	18
5	1870.000	-1.57	50.09	48.52	70.00	-21.48	peak	100	217
6	2120.000	-0.59	46.17	45.58	70.00	-24.42	peak	100	198
7	2615.000	1.99	47.17	49.16	70.00	-20.84	peak	100	21

Note: Measurement Level = Reading Level + Correct Factor



Test Mode :	Mode 8: Full system (HDMI mode 3440*1440@50Hz)(230V/50Hz)		
AC Power :	AC 230V/50Hz	Ant. Polarization:	Horizontal
Equipment :	LCD Monitor	Model No :	350LM00005
Temperature :	23°C	Humidity :	56%
Pressure(mbar) :	1001	Date:	2016/12/14

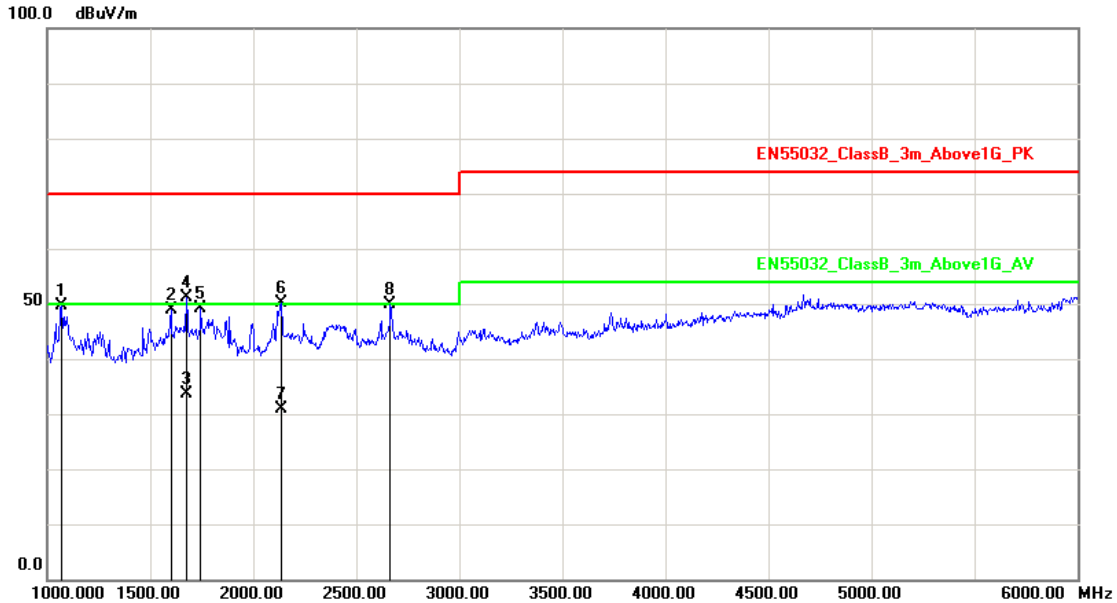

No.	Frequency (MHz)	Factor (dB/m)	Reading (dBuV)	Level (dBuV/m)	Limit (dBuV/m)	Margin (dB)	Det.	Height (cm)	Azimuth (deg)
1	1070.000	-5.51	55.16	49.65	70.00	-20.35	peak	200	157
2	1600.000	-2.35	51.32	48.97	70.00	-21.03	peak	200	63
3	1674.000	-2.14	35.70	33.56	50.00	-16.44	AVG	200	119
4	1675.000	-2.14	53.18	51.04	70.00	-18.96	peak	200	3
5	1745.000	-1.93	51.07	49.14	70.00	-20.86	peak	100	254
6	2135.000	-0.51	50.59	50.08	70.00	-19.92	peak	200	187
7	2136.000	-0.51	31.29	30.78	70.00	-39.22	peak	200	326
8	2665.000	2.26	47.63	49.89	70.00	-20.11	peak	200	41

Note: Measurement Level = Reading Level + Correct Factor



Test Mode :	Mode 8: Full system (HDMI mode 3440*1440@50Hz)(230V/50Hz)		
AC Power :	AC 230V/50Hz	Ant. Polarization:	Vertical
Equipment :	LCD Monitor	Model No :	350LM00005
Temperature :	23°C	Humidity :	56%
Pressure(mbar) :	1001	Date:	2016/12/14

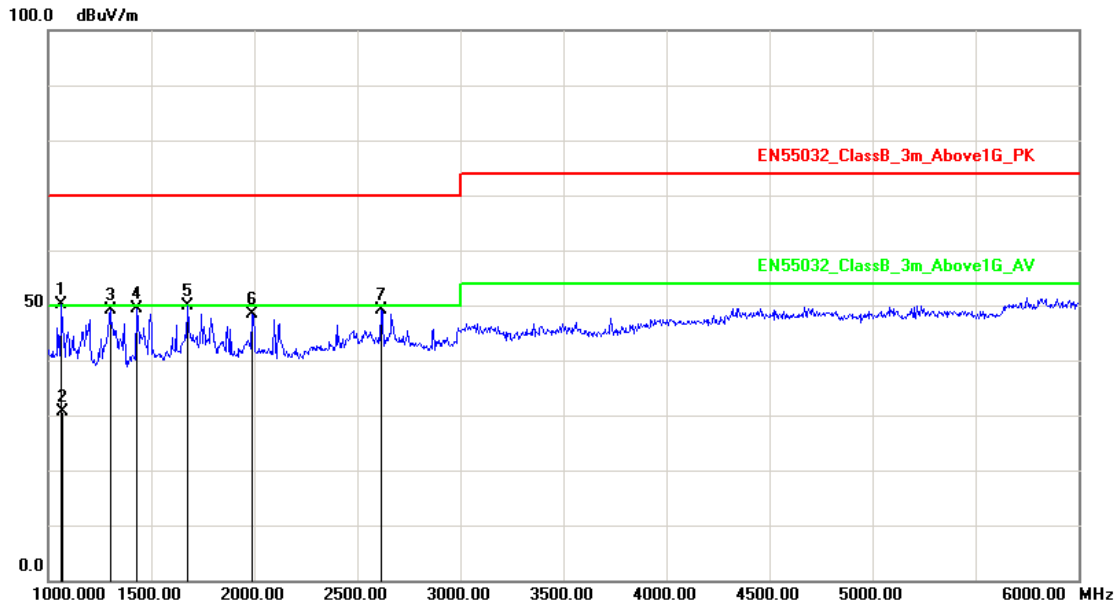

No.	Frequency (MHz)	Factor (dB/m)	Reading (dBuV)	Level (dBuV/m)	Limit (dBuV/m)	Margin (dB)	Det.	Height (cm)	Azimuth (deg)
1	1065.000	-5.55	55.59	50.04	70.00	-19.96	peak	100	157
2	1067.000	-5.53	36.22	30.69	50.00	-19.31	AVG	100	46
3	1300.000	-3.98	53.18	49.20	70.00	-20.80	peak	200	0
4	1430.000	-3.11	52.56	49.45	70.00	-20.55	peak	100	0
5	1675.000	-2.14	51.94	49.80	70.00	-20.20	peak	100	298
6	1990.000	-1.23	49.67	48.44	70.00	-21.56	peak	100	114
7	2615.000	1.99	47.17	49.16	70.00	-20.84	peak	200	32

Note: Measurement Level = Reading Level + Correct Factor



Test Mode :	Mode 11: Full system (Display mode 3440*1440@100Hz)(230V/50Hz)		
AC Power :	AC 230V/50Hz	Ant. Polarization:	Horizontal
Equipment :	LCD Monitor	Model No :	350LM00005
Temperature :	23°C	Humidity :	56%
Pressure(mbar) :	1001	Date:	2016/12/14

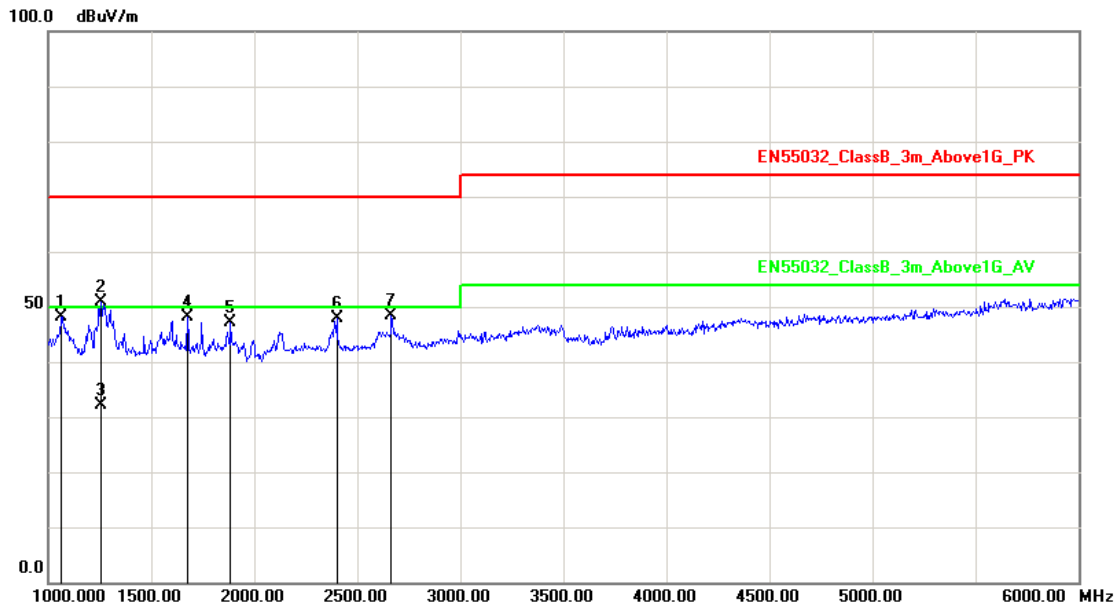

No.	Frequency (MHz)	Factor (dB/m)	Reading (dBuV)	Level (dBuV/m)	Limit (dBuV/m)	Margin (dB)	Det.	Height (cm)	Azimuth (deg)
1	1065.000	-5.55	53.80	48.25	70.00	-21.75	peak	100	274
2	1255.000	-4.28	55.10	50.82	70.00	-19.18	peak	200	336
3	1256.000	-4.27	36.37	32.10	50.00	-17.90	AVG	200	291
4	1675.000	-2.14	50.18	48.04	70.00	-21.96	peak	200	183
5	1885.000	-1.53	48.62	47.09	70.00	-22.91	peak	100	41
6	2400.000	0.84	46.96	47.80	70.00	-22.20	peak	200	0
7	2665.000	2.26	46.13	48.39	70.00	-21.61	peak	200	116

Note: Measurement Level = Reading Level + Correct Factor



Test Mode :	Mode 11: Full system (Display mode 3440*1440@100Hz)(230V/50Hz)		
AC Power :	AC 230V/50Hz	Ant. Polarization:	Vertical
Equipment :	LCD Monitor	Model No :	350LM00005
Temperature :	23°C	Humidity :	56%
Pressure(mbar) :	1001	Date:	2016/12/14

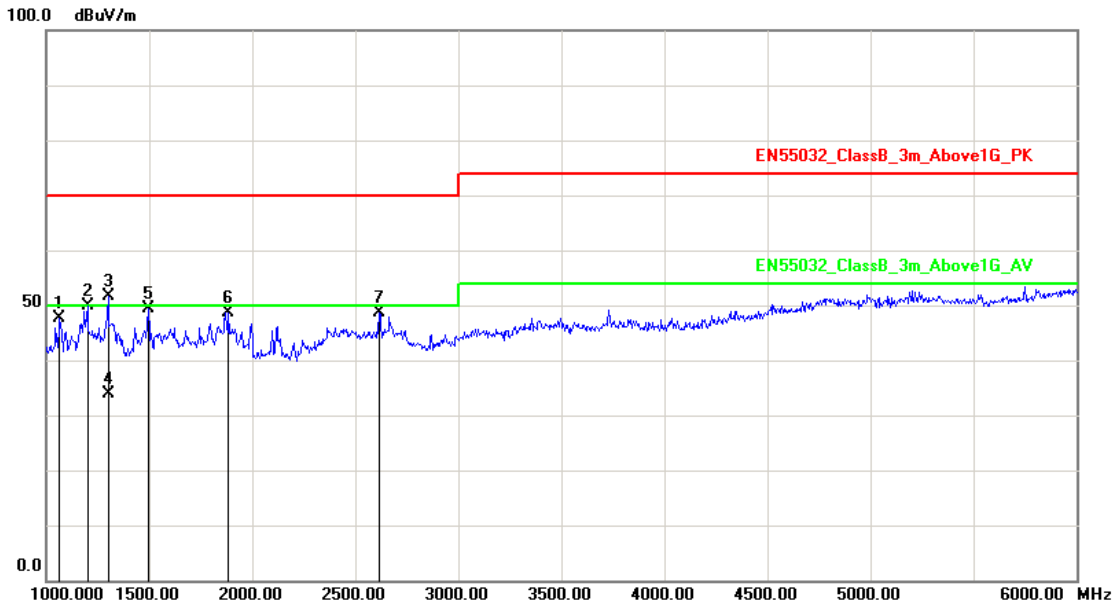

No.	Frequency (MHz)	Factor (dB/m)	Reading (dBuV)	Level (dBuV/m)	Limit (dBuV/m)	Margin (dB)	Det.	Height (cm)	Azimuth (deg)
1	1065.000	-5.55	53.09	47.54	70.00	-22.46	peak	100	113
2	1200.000	-4.64	54.57	49.93	70.00	-20.07	peak	100	298
3	1300.000	-3.98	55.68	51.70	70.00	-18.30	peak	100	62
4	1301.000	-3.97	37.81	33.84	50.00	-16.16	AVG	100	0
5	1495.000	-2.67	51.96	49.29	70.00	-20.71	peak	200	214
6	1885.000	-1.53	50.26	48.73	70.00	-21.27	peak	200	187
7	2615.000	1.99	46.67	48.66	70.00	-21.34	peak	100	48

Note: Measurement Level = Reading Level + Correct Factor

Test engineer: *Sun. Zhang*



### 5.7. Test Photographs (30MHz~1GHz)

Second edition:

Front View



Rear View

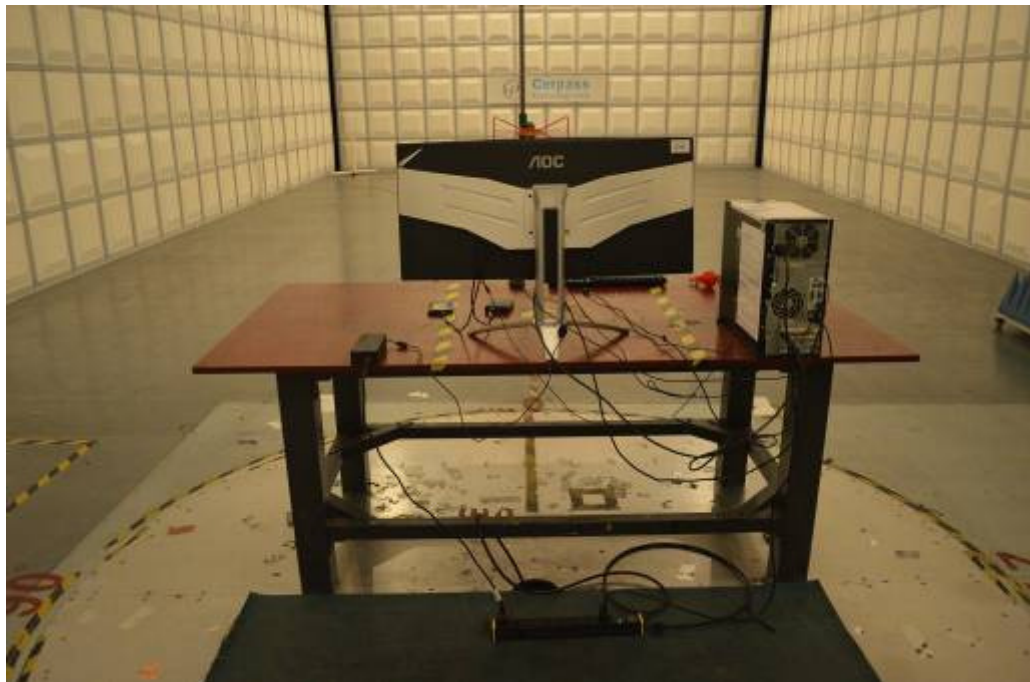



Original:

Front View



Rear View

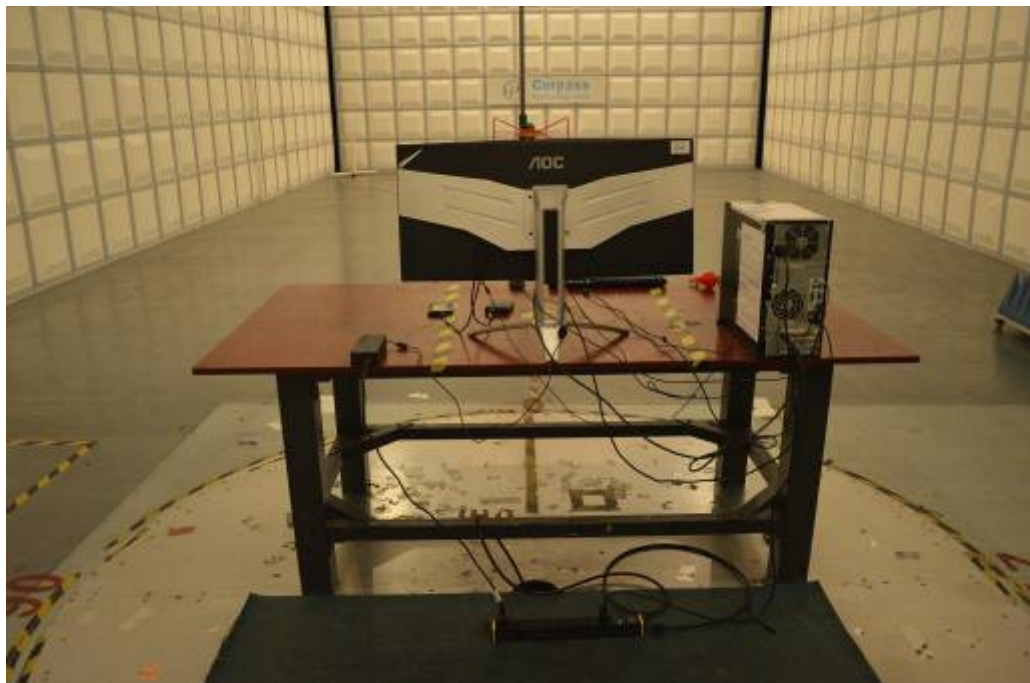





### 5.8. Test Photographs (1GHz~6GHz)

Second edition:

Front View



Rear View

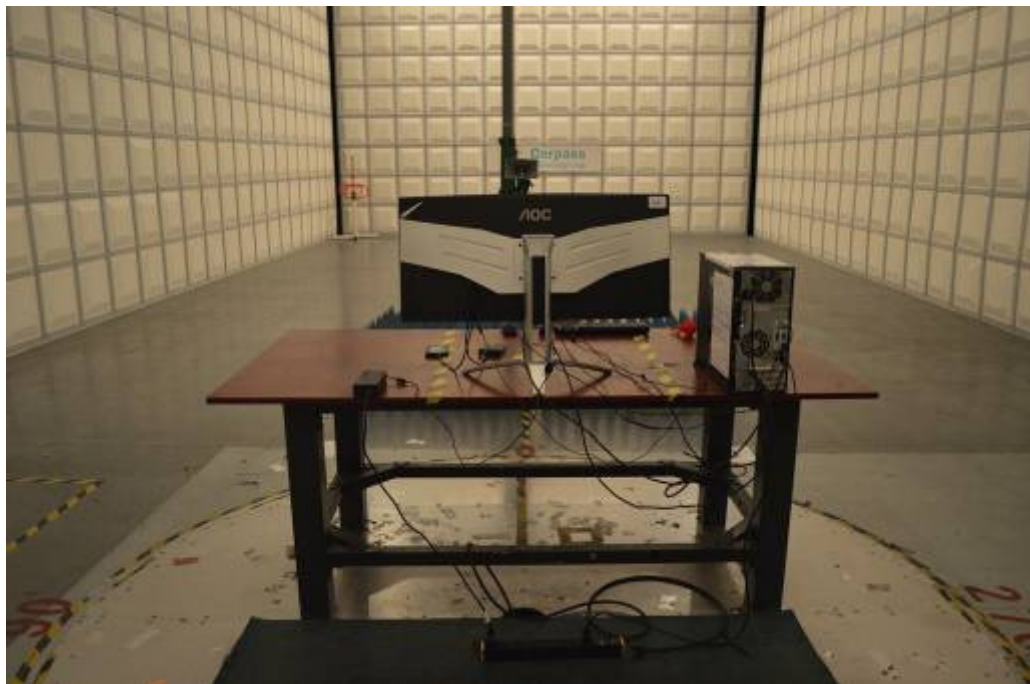



Original:

Front View



Rear View

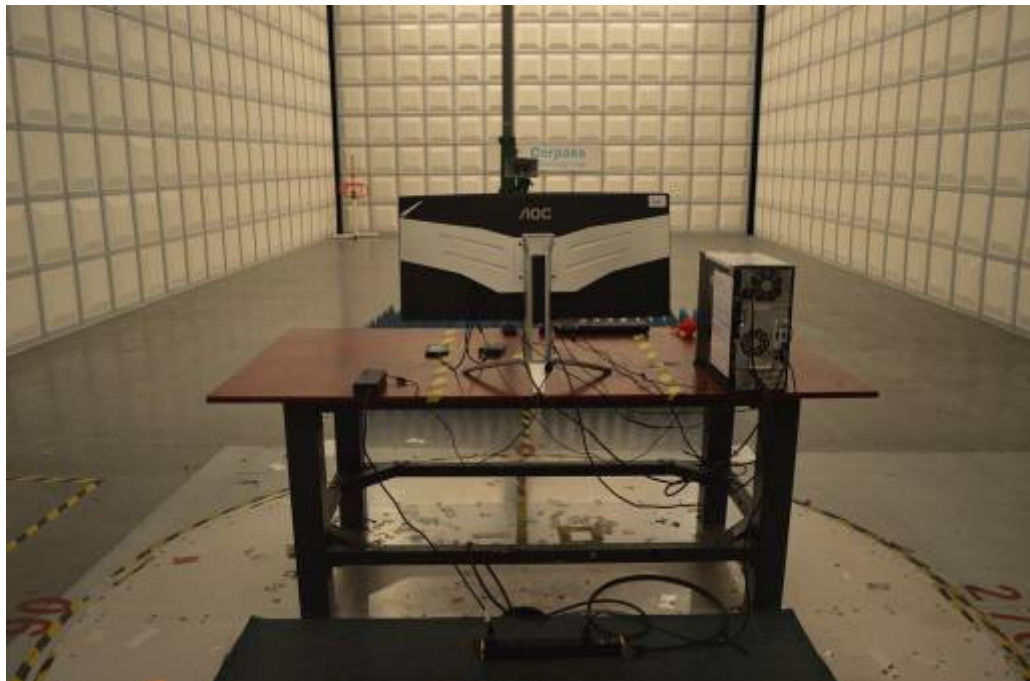



## 6. Harmonics Test

### 6.1. Limits of Harmonics Current Measurement

#### Limits for Class A equipment

Harmonics Order n	Max. permissible harmonics current A	Harmonics Order n	Max. permissible harmonics current A
Odd harmonics		Even harmonics	
3	2.30	2	1.08
5	1.14	4	0.43
7	0.77	6	0.30
9	0.40	8 ≤ n ≤ 40	0.23x8/n
11	0.33		
13	0.21		
15 ≤ n ≤ 39	0.15x15/n		

#### (b) Limits for Class B equipment

For Class B equipment, the harmonics of the input current shall not exceed the values given in Table that is the limit of Class A multiplied by a factor of 1,5.

#### (c) Limits for Class C equipment

Harmonics Order n	Maximum permissible harmonic current expressed as a percentage of the input current at the fundamental frequency %
2	2
3	$30 \cdot \lambda^*$
5	10
7	7
9	5
11 < n < 39 (odd harmonics only)	3

\*  $\lambda$  is the circuit power factor

#### (d) Limits for Class D equipment

Harmonics Order n	Maximum permissible harmonic current per watt mA/W	Maximum permissible harmonic current A
3	3.4	2.30
5	1.9	1.14
7	1.0	0.77
9	0.5	0.40
11	0.35	0.33
11 < n < 39 (odd harmonics only)	3.85/n	See limit of Class A

**NOTE:** According to section 7 of EN 61000-3-2, the above limits for all equipment except for lighting equipment having an active input power > 75 W and no limits apply for equipment with an active input power up to and including 75 W.



## 6.2. Measurement Equipment

Instrument/Ancillary	Manufacturer	Model No.	Serial No.	Calibration Date	Valid Date.
EMC Emission Tester	EMCPARTNER	Harmonics-1000	159	2017.03.28	2018.03.27
Temperature/ Humidity Meter	Zhicheng	ZC1-11	CEP-TH-004	2017.03.28	2018.03.27
HARCS	EMC Partner AG	Ver 4.18	N/A	N/A	N/A



### 6.3. Test Result and Data

Second edition:

Basic Standard	:	EN 61000-3-2
Final Test Result	:	PASS
Test Mode	:	Mode 1,4
Model No.	:	350LM00005
Temperature	:	22°C
Humidity	:	52%
Atmospheric Pressure	:	100 kPa
Test Date	:	Jun 28, 2017

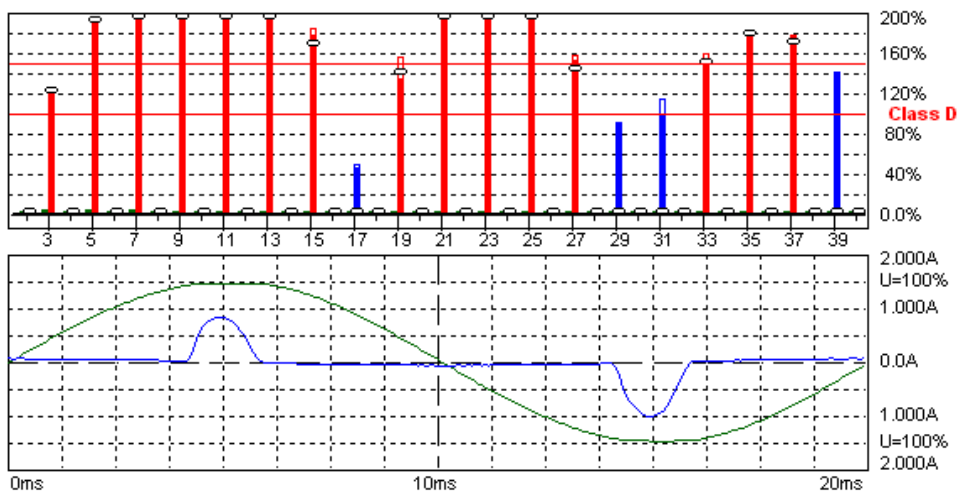

Harmonic Emission - IEC 61000-3-2 , EN 61000-3-2 , (EN60555-2)

2017-6-28 10:56:38 harmonic.hsu

Urms = 230.3 V    P = 33.92 W    THC = 0.244 A    Range: 2 A  
 Irms = 0.286 A    pf = 0.515    Pmax = 34.28 W    V-nom: 230 V  
 TestTime: 15 min (100%)

HAR-1000 EMC-Parber

Full Bar : Actual Values

Empty Bar : Maximum Values

Blue : Current , Green : Voltage , Red : Failed

Urms = 230.3V    Freq = 50.000    Range: 2 A  
 Irms = 0.286A    Ipk = 1.063A    cf = 3.713  
 P = 33.92W    S = 65.90VA    pf = 0.515  
 THDi = 84.1 %    THDu = 1.20 %    Class D

Test - Time : 15min ( 100 %)

Limit Reference: Pmax = 34.283W

Test completed, Result: PASSED



Order	Freq. [Hz]	I <sub>rms</sub> [A]	I <sub>rms</sub> %L [%]	I <sub>max</sub> [A]	I <sub>max</sub> %L [%]	Limit [A]	
1	50	0.1571		0.1587			
2	100	0.0190		0.0197			
3	150	0.1405	120.54	0.1416	121.48	0.1166	N/A
4	200	0.0171		0.0177			
5	250	0.1248	191.53	0.1255	192.65	0.0651	N/A
6	300	0.0143		0.0148			
7	350	0.1051	306.57	0.1055	307.64	0.0343	N/A
8	400	0.0105		0.0109			
9	450	0.0817	476.42	0.0820	478.56	0.0171	N/A
10	500	0.0065		0.0067			
11	550	0.0573	477.13	0.0577	481.20	0.0120	N/A
12	600	0.0028		0.0031			
13	650	0.0349	343.86	0.0355	349.87	0.0102	N/A
14	700	0.0009		0.0011			
15	750	0.0155	176.18	0.0160	181.73	0.0088	N/A
16	800	0.0026		0.0027			
17	850	0.0034	44.023	0.0037	47.167	0.0078	N/A
18	900	0.0037		0.0038			
19	950	0.0092	131.79	0.0107	154.64	0.0069	N/A
20	1000	0.0039		0.0042			
21	1050	0.0135	215.58	0.0142	225.29	0.0063	N/A
22	1100	0.0038		0.0040			
23	1150	0.0138	240.37	0.0139	242.50	0.0057	N/A
24	1200	0.0033		0.0034			
25	1250	0.0114	215.03	0.0115	217.34	0.0053	N/A
26	1300	0.0029		0.0031			
27	1350	0.0073	149.83	0.0076	154.82	0.0049	N/A
28	1400	0.0029		0.0032			
29	1450	0.0040	88.508	0.0040	88.508	0.0046	N/A
30	1500	0.0028		0.0031			
31	1550	0.0042	97.479	0.0048	111.81	0.0043	N/A
32	1600	0.0031		0.0032			
33	1650	0.0059	146.50	0.0063	158.70	0.0040	N/A
34	1700	0.0032		0.0032			
35	1750	0.0067	178.03	0.0067	178.03	0.0038	N/A
36	1800	0.0028		0.0031			
37	1850	0.0062	174.52	0.0062	174.52	0.0036	N/A
38	1900	0.0028		0.0031			
39	1950	0.0048	140.67	0.0048	140.67	0.0034	N/A
40	2000	0.0028		0.0031			

EUT is PASSED if:

- all Average values of the Individual Harmonic Currents (I<sub>avg</sub>) are below 100% of the Individual Limits.
- all Maximum values of the Individual Harmonic Currents (I<sub>max</sub>) are below 150% of the Individual Limits.

Test engineer: Sun. Zhang



Original:

Basic Standard	:	EN 61000-3-2
Final Test Result	:	PASS
Test Mode	:	Mode 1,4
Model No.	:	350LM00005
Temperature	:	22°C
Humidity	:	52%
Atmospheric Pressure	:	100 kPa
Test Date	:	Dec 14, 2016

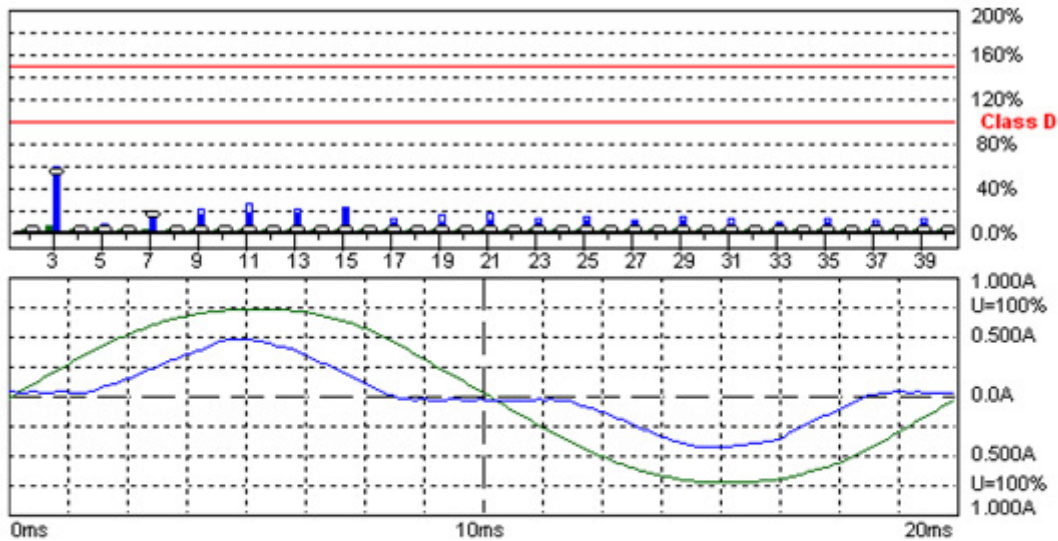

Harmonic Emission - IEC 61000-3-2 , EN 61000-3-2 , (EN60555-2)

2016-12-14 9:16:32 harmonic.hsu

Urms = 230.3 V    P = 50.34 W    THC = 0.097 A    Range: 1 A  
 Irms = 0.242 A    pf = 0.904    Pmax = 52.46 W    V-nom: 230 V  
 TestTime: 15 min (100%)

AG352UCG

Test completed, Result: PASSED

HAR-1000 EMC-Parber

Full Bar : Actual Values

Empty Bar : Maximum Values

Blue : Current , Green : Voltage , Red : Failed

Urms = 230.3V    Freq = 50.000    Range: 1 A  
 Irms = 0.242A    Ipk = 0.480A    cf = 1.986  
 P = 50.34W    S = 55.66VA    pf = 0.904  
 THDi = 43.9 %    THDu = 1.90 %    Class D  
 Test - Time : 15min ( 100 % )  
 Limit Reference: Pmax = 52.464W  
 Test completed, Result: PASSED



Order	Freq. [Hz]	I <sub>rms</sub> [A]	I <sub>rms</sub> %L [%]	I <sub>max</sub> [A]	I <sub>max</sub> %L [%]	Limit [A]
1	50	0.2219		0.2316		
2	100	0.0038		0.0051		
3	150	0.0967	54.234	0.1008	56.492	0.1784
4	200	0.0028		0.0039		
5	250	0.0032	3.1840	0.0045	4.5310	0.0997
6	300	0.0018		0.0026		
7	350	0.0069	13.146	0.0073	13.960	0.0525
8	400	0.0012		0.0018		
9	450	0.0034	13.030	0.0048	18.149	0.0262
10	500	0.0009		0.0016		
11	550	0.0027	14.625	0.0044	23.932	0.0184
12	600	0.0007		0.0013		
13	650	0.0024	15.320	0.0030	19.248	0.0155
14	700	0.0006		0.0008		
15	750	0.0026	19.037	0.0027	19.943	0.0135
16	800	0.0005		0.0005		
17	850	0.0009	7.1917	0.0012	9.7602	0.0119
18	900	0.0004		0.0005		
19	950	0.0007	6.8896	0.0013	12.631	0.0106
20	1000	0.0004		0.0006		
21	1050	0.0008	8.2494	0.0014	14.595	0.0096
22	1100	0.0003		0.0004		
23	1150	0.0006	6.9500	0.0009	9.7300	0.0088
24	1200	0.0003		0.0004		
25	1250	0.0006	7.5544	0.0009	11.332	0.0081
26	1300	0.0003		0.0004		
27	1350	0.0005	7.3428	0.0006	8.1587	0.0075
28	1400	0.0002		0.0004		
29	1450	0.0005	7.8867	0.0008	11.392	0.0070
30	1500	0.0002		0.0003		
31	1550	0.0004	5.6204	0.0006	9.3674	0.0065
32	1600	0.0002		0.0003		
33	1650	0.0003	4.9859	0.0004	5.9830	0.0061
34	1700	0.0003		0.0003		
35	1750	0.0004	7.4033	0.0006	10.576	0.0058
36	1800	0.0002		0.0003		
37	1850	0.0003	5.5902	0.0004	7.8263	0.0055
38	1900	0.0002		0.0003		
39	1950	0.0003	5.8924	0.0005	10.606	0.0052
40	2000	0.0003		0.0003		

EUT is PASSED if:

- all Average values of the Individual Harmonic Currents (I<sub>avg</sub>) are below 100% of the Individual Limits.
- all Maximum values of the Individual Harmonic Currents (I<sub>max</sub>) are below 150% of the Individual Limits.

Test engineer: Sun. Zhang





### 6.4. Test Photographs

Second edition:



Original:





## 7. Voltage Fluctuations Test

### 7.1. Test Procedure

The equipment shall be tested under the conditions of **Clause 5**.

The total impedance of the test circuit, excluding the appliance under test, but including the internal impedance of the supply source, shall be equal to the reference impedance.

The stability and tolerance of the reference impedance shall be adequate to ensure that the overall accuracy of  $\pm 8\%$  is achieved during the whole assessment procedure.

### 7.2. Measurement Equipment

Instrument/Ancillary	Manufacturer	Model No.	Serial No.	Calibration Date	Valid Date.
EMC Emission Tester	EMCPARTNER	Harmonics-1000	159	2017.03.28	2018.03.27
Temperature/ Humidity Meter	Zhicheng	ZC1-11	CEP-TH-004	2017.03.28	2018.03.27
HARCS	EMC Partner AG	Ver 4.18	N/A	N/A	N/A



### 7.3. Test Result and Data

Second edition:

Basic Standard	:	EN 61000-3-3
Final Test Result	:	PASS
Test Mode	:	Mode 1,4
Model No.	:	350LM00005
Temperature	:	22°C
Humidity	:	52%
Atmospheric Pressure	:	100 kPa
Test Date	:	Jun 28, 2017

Flickermeter 1000-4-15 for 230V/50Hz

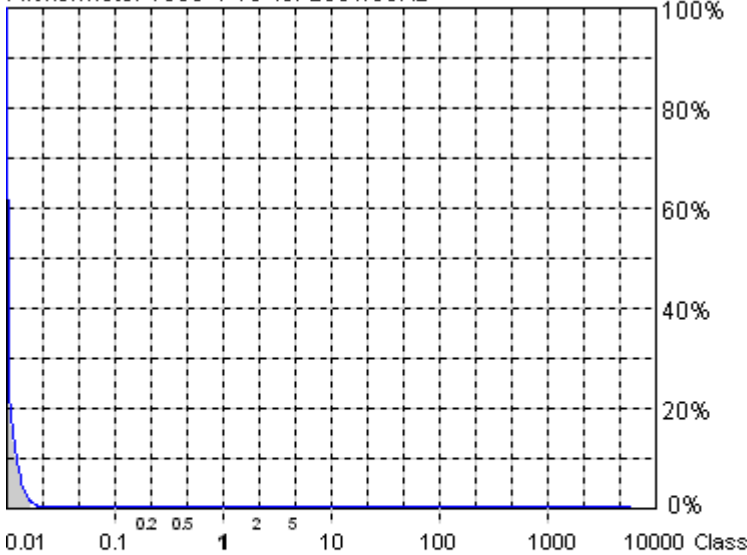

**Actual Flicker (Fli): 0.01**  
**Short-term Flicker (Pst): 0.08**  
 Limit (Pst): 1.00  
**Long-term Flicker (Plt): 0.08**  
 Limit (Plt): 0.65  
**Maximum Relative Volt. Change (dmax): 0.00%**  
 Limit (dmax): 4.00%  
**Relative Steady-state Voltage Change (dc): 0.10%**  
 Limit (dc): 3.30%  
**Maximum Interval exceeding 3.30% (dt): 0.00ms**  
 Limit (dt>Lim): 500ms

**Flicker Emission - IEC 61000-3-3 , EN 61000-3-3 , (EN60555-3)**

2017-6-28 11:08:07 harmonic.hsu

Urms = 230.3 V P = 33.77 W  
 Irms = 0.286 A pf = 0.512

Range: 2 A  
 V-nom: 230 V  
 TestTime: 10 min (100%)

**Test completed, Result: PASSED**

HAR-1000 EMC-Parber

- Full Bar : Actual Values
- Empty Bar : Maximum Values
- Circles : Average Values
- Blue : Current , Green : Voltage , Red : Failed



Urms = 230.3V Freq = 49.987 Range: 2 A  
Irms = 0.286A lpk = 1.065A cf = 3.724  
P = 33.77W S = 65.90VA pf = 0.512

Test - Time : 1 x 10min = 10min ( 100 %)

LIN (Line Impedance Network) : No LIN

Limits : Plt : 0.65 Pst : 1.00  
dmax : 4.00 % dc : 3.30 %  
dtLim: 3.30 % dt>Lim: 500ms

Test completed, Result: PASSED

Test engineer: Sun. Zhang



Original:

Basic Standard	:	EN 61000-3-3
Final Test Result	:	PASS
Test Mode	:	Mode 1,4
Model No.	:	350LM00005
Temperature	:	22°C
Humidity	:	52%
Atmospheric Pressure	:	100 kPa
Test Date	:	Dec 14, 2016

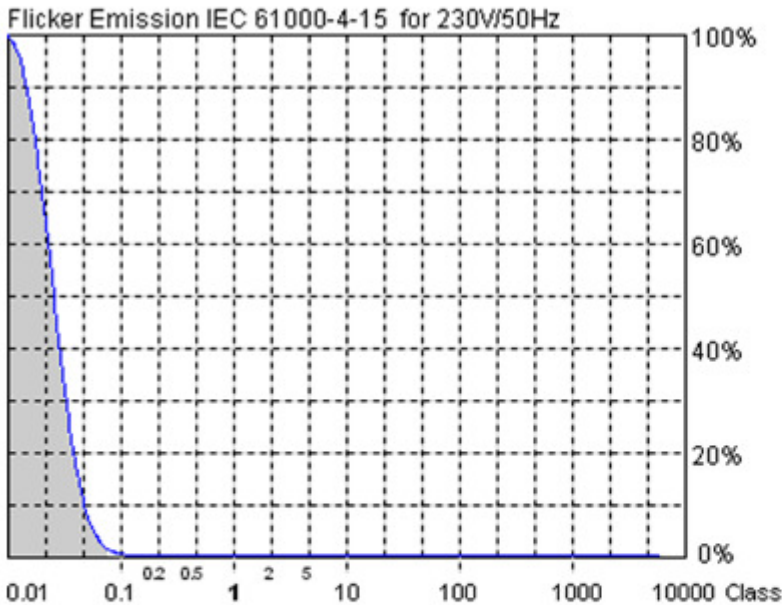

**Actual Flicker (Fli): 0.03**  
**Short-term Flicker (Pst): 0.16**  
 Limit (Pst): 1.00  
**Long-term Flicker (Ptt): 0.16**  
 Limit (Ptt): 0.65  
**Maximum Relative Volt. Change (dmax): 0.01%**  
 Limit (dmax): 4.00%  
**Relative Steady-state Voltage Change (dc): 0.18%**  
 Limit (dc): 3.30%  
**Tmax 3.30% (dt): 0.00ms**  
 Limit (dt>Lim): 500ms

**Flicker Emission - IEC 61000-3-3 , EN 61000-3-3**

Urms = 230.3 V    P = 42.95 W  
 Irms = 0.207 A    pf = 0.901

AG352UCG

**Test completed, Result: PASSED**

2016-12-14 9:32:30 harmonic.hsu

Range: 1 A  
 V-nom: 230 V  
 TestTime: 10 min (100%)

HAR-1000 EMC-Parber

- Full Bar : Actual Values
- Empty Bar : Maximum Values
- Circles : Average Values
- Blue : Current , Green : Voltage , Red : Failed



Urms = 230.3V Freq = 50.000 Range: 1 A  
Irms = 0.207A lpk = 0.436A cf = 2.106  
P = 42.95W S = 47.68VA pf = 0.901

Test - Time : 1 x 10min = 10min ( 100 %)

LIN (Line Impedance Network) : No LIN

Limits : Plt : 0.65 Pst : 1.00  
dmax : 4.00 % dc : 3.30 %  
dtLim: 3.30 % dt>Lim: 500ms

Test completed, Result: PASSED

Test engineer: Sun. Zhang



### 7.4. Test Photographs

Second edition:



Original:





## 8. Electrostatic Discharge Immunity Test

### 8.1. Test Procedure

- a. In the case of air discharge testing the climatic conditions shall be within the following ranges:
  - ambient temperature: 15°C to 35°C;
  - relative humidity : 30% to 60%;
  - atmospheric pressure : 86 KPa (860 mbar) to 106 KPa (1060 mbar).
- b. Test programs and software shall be chosen so as to exercise all normal modes of operation of the EUT. The use of special exercising software is encouraged, but permitted only where it can be shown that the EUT is being comprehensively exercised.
- c. The test voltage shall be increased from the minimum to the selected test severity level, in order to determine any threshold of failure. The final severity level should not exceed the product specification value in order to avoid damage to the equipment.
- d. The test shall be performed with both air discharge and contact discharge. On reselected points at least 10 single discharges (in the most sensitive polarity) shall be applied on air discharge. On reselected points at least 25 single discharges (in the most sensitive polarity) shall be applied on contact discharge.
- e. For the time interval between successive single discharges an initial value of one second is recommended. Longer intervals may be necessary to determine whether a system failure has occurred.
- f. In the case of contact discharges, the tip of the discharge electrode shall touch the EUT before the discharge switch is operated.
- g. In the case of painted surface covering a conducting substrate, the following procedure shall be adopted :
  - If the coating is not declared to be an insulating coating by the equipment manufacturer, then the pointed tip of the generator shall penetrate the coating so as to make contact with the conducting substrate.
  - Coating declared as insulating by the manufacturer shall only be submitted to the air discharge.
  - The contact discharge test shall not be applied to such surfaces.
- h. In the case of air discharges, the round discharge tip of the discharge electrode shall be approached as fast as possible (without causing mechanical damage) to touch the EUT . After each discharge, the ESD generator (discharge electrode) shall be removed from the EUT. The generator is then retriggered for a new single discharge. This procedure shall be repeated until the discharges are completed. In the case of an air discharge test, the discharge switch, which is used for contact discharge, shall be closed.



## 8.2. Test Setup for Tests Performed in Laboratory

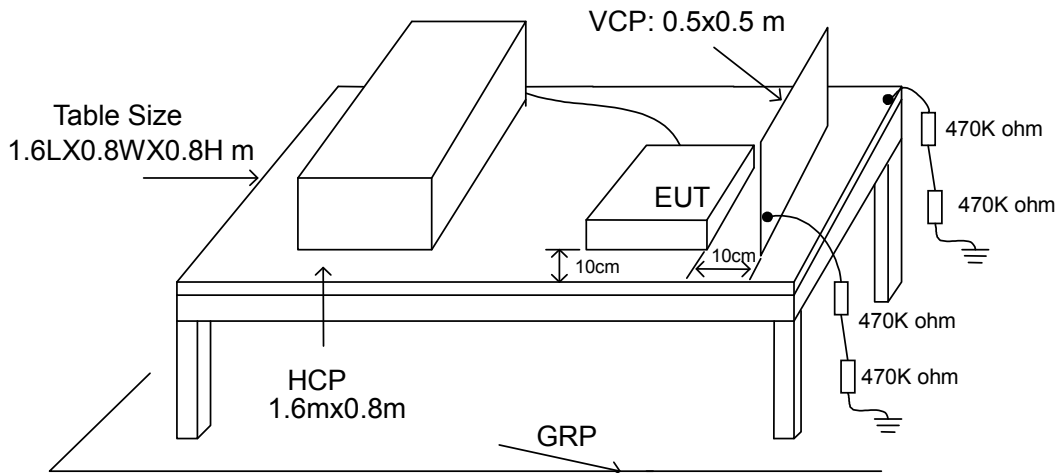

The test setup consists of the test generator, EUT and auxiliary instrumentation necessary to perform DIRECT and INDIRECT application of discharges to the EUT as applicable, in the following manner :

- a. Contact Discharge to the conductive surfaces and to coupling plane;
- b. Air Discharge at insulating surfaces.

The preferred test method is that of type tests performed in laboratories and the only accepted method of demonstrating conformance with this standard. The EUT was arranged as closely as possible to arrangement in final installed conditions.

A ground reference plane was provided on the floor of the test site. It was a metallic sheet (copper or aluminum) of 0.25 mm, minimum thickness; other metallic may be used but they shall have at least 0.65 mm thickness. In the CerpPASS Technology Corp., we provided 1 mm thickness stainless steel ground reference plane. The minimum size of the ground reference plane is 2.5 m x 2.5 m, the exact size depending on the dimensions of the EUT. It was connected to the protective grounding system.

The EUT was arranged and connected according to its functional requirements. A distance of 1m minimum was provided between the EUT and the wall of the lab. and any other metallic structure. In cases where this length exceeds the length necessary to apply the discharges to the selected points, the excess length shall, where possible, be placed non-inductively off the ground reference plane and shall not come closer than 0.2m to other conductive parts in the test setup.

Where the EUT is installed on a metal table, the table was connected to the reference plane via a cable with a 470k ohm resistor located at each end, to prevent a build-up of charge. The test setup was consist a wooden table, 0.8m high, standing on the ground reference plane. A HCP, 1.6 m x 0.8 m, was placed on the table. The EUT and cables was isolated from the HCP by an insulating support 0.5 mm thick. The VCP size, 0.5 m x 0.5 m.



### 8.3. Test Severity Levels

Contact Discharge		Air Discharge	
Level	Test Voltage (KV) of Contact discharge	Level	Test Voltage (KV) of Air Discharge
1	±2	1	±2
2	±4	2	±4
3	±6	3	±8
4	±8	4	±15
X	Specified	X	Specified

Remark: "X" is an open level.

### 8.4. Measurement Equipment

Instrument/Ancillary	Manufacturer	Model No.	Serial No.	Calibration Date	Valid Date.
ESD Simulator	EM Test	Dito	P1645186902	2017.02.16	2018.02.15
Tonometer	shanghaifengyun	DYM3	3251	2016.12.21	2017.12.20
Dehumidifier	ZEDO	ZD-220LB	CEP-TH-01	N/A	N/A
Humidifier	YADU	YZ-DS251C	CEP-TH-02	N/A	N/A
Temperature/ Humidity Meter	feiyang	N/A	102	2017.03.28	2018.03.27
ESD Simulator	NoiseKen	ESS-B3011A	AEC00315-00 C-0A	2016.12.12	2017.12.11



8.5. Test Result and Data

Second edition:

Final Test Result : **PASS**  
 Pass performance criteria : B  
 Basic Standard : IEC 61000-4-2  
 Model No. : 350LM00005  
 Test Voltage : ±2 / ±4 / ±8 KV for air discharge,  
 ±2 / ±4 KV for contact discharge  
 Temperature : 22°C  
 Relative Humidity : 49 %  
 Atmospheric Pressure : 100 kPa  
 Test Date : Jun 28, 2017

Test Mode : Mode 1,4

	Contact Discharge								Air Discharge							
	25 times / each								10 times / each							
Voltage	2 kV		4 kV		6 kV		8 kV		2 kV		4 kV		8 kV		10 kV	
Point\Polarity	+	-	+	-	+	-	+	-	+	-	+	-	+	-	+	-
HCP	A	A	A	A	---	---	---	---	---	---	---	---	---	---	---	---
VCP	A	A	A	A	---	---	---	---	---	---	---	---	---	---	---	---
Screw	A	A	A	A	---	---	---	---	---	---	---	---	---	---	---	---
Case	---	---	---	---	---	---	---	---	A	A	A	A	A	A	---	---
Panel	---	---	---	---	---	---	---	---	A	A	A	A	A	A	---	---
HDMI Port	A	A	A	A	---	---	---	---	---	---	---	---	---	---	---	---
DP Port	A	A	A	A	---	---	---	---	---	---	---	---	---	---	---	---
USB Port	A	A	A	A	---	---	---	---	---	---	---	---	---	---	---	---
Audio Port	---	---	---	---	---	---	---	---	A	A	A	A	A	A	---	---
Power Port	---	---	---	---	---	---	---	---	A	A	A	A	A	A	---	---
Button	---	---	---	---	---	---	---	---	A	A	A	A	A	A	---	---
LED Light	---	---	---	---	---	---	---	---	A	A	A	A	A	A	---	---

Test engineer: Sun. Zhang



Original:

Final Test Result : **PASS**  
 Pass performance criteria : B  
 Basic Standard : IEC 61000-4-2  
 Model No. : 350LM00005  
 Test Voltage : ±2 / ±4 / ±8 KV for air discharge,  
 ±2 / ±4 KV for contact discharge  
 Temperature : 22°C  
 Relative Humidity : 49 %  
 Atmospheric Pressure : 100 kPa  
 Test Date : Dec 14, 2016

Test Mode : Mode 1,4

	Contact Discharge								Air Discharge							
	25 times / each								10 times / each							
Voltage	2 kV		4 kV		6 kV		8 kV		2 kV		4 kV		8 kV		10 kV	
Point\Polarity	+	-	+	-	+	-	+	-	+	-	+	-	+	-	+	-
HCP	A	A	A	A	---	---	---	---	---	---	---	---	---	---	---	---
VCP	A	A	A	A	---	---	---	---	---	---	---	---	---	---	---	---
Screw	A	A	A	A	---	---	---	---	---	---	---	---	---	---	---	---
Case	---	---	---	---	---	---	---	---	A	A	A	A	A	A	---	---
Panel	---	---	---	---	---	---	---	---	A	A	A	A	A	A	---	---
HDMI Port	A	A	A	A	---	---	---	---	---	---	---	---	---	---	---	---
DP Port	A	A	A	A	---	---	---	---	---	---	---	---	---	---	---	---
USB Port	A	A	A	A	---	---	---	---	---	---	---	---	---	---	---	---
Audio Port	---	---	---	---	---	---	---	---	A	A	A	A	A	A	---	---
Power Port	---	---	---	---	---	---	---	---	A	A	A	A	A	A	---	---
Button	---	---	---	---	---	---	---	---	A	A	A	A	A	A	---	---
LED Light	---	---	---	---	---	---	---	---	A	A	A	A	A	A	---	---

Test engineer: Sun. Zhang



### 8.6. Test Photographs

Second edition:



Original:





## 9. Radio Frequency electromagnetic field immunity test

### 9.1. Test Procedure

- a. The equipment to be tested is placed in the center of the enclosure on a wooden table. The equipment is then connected to power and signal leads according to pertinent installation instructions.
- b. The antenna which is enabling the complete frequency range of 80-1000 MHz is placed 3m away from the equipment. The required field strength is determined by placing the field strength meter(s) on top of or directly alongside the equipment under test and monitoring the field strength meter via a remote field strength indicator outside the enclosure while adjusting the continuous-wave to the applicable antennae.
- c. The test is normally performed with the antenna facing the most sensitive side of the EUT. The polarization of the field generated by the bucolical antenna necessitates testing each position twice, once with the antenna positioned vertically and again with the antenna positioned horizontally. The circular polarization of the field from the log-spiral antenna makes a change of position of the antenna unnecessary.
- d. At each of the above conditions, the frequency range is swept 80-1000 MHz, pausing to adjust the R.F. signal level or to switch oscillators and antenna. The rate of sweep is in the order of  $1.5 \cdot 10^{-3}$  decades/s. The sensitive frequencies or frequencies of dominant interest may be discretely analyzed.

### 9.2. Test Severity Levels

Frequency Band : 80-1000 MHz	
Level	Test field strength (V/m)
1	1
2	3
3	10
X	Specified
Remark: "X" is an open class.	

### 9.3. TEST SETUP

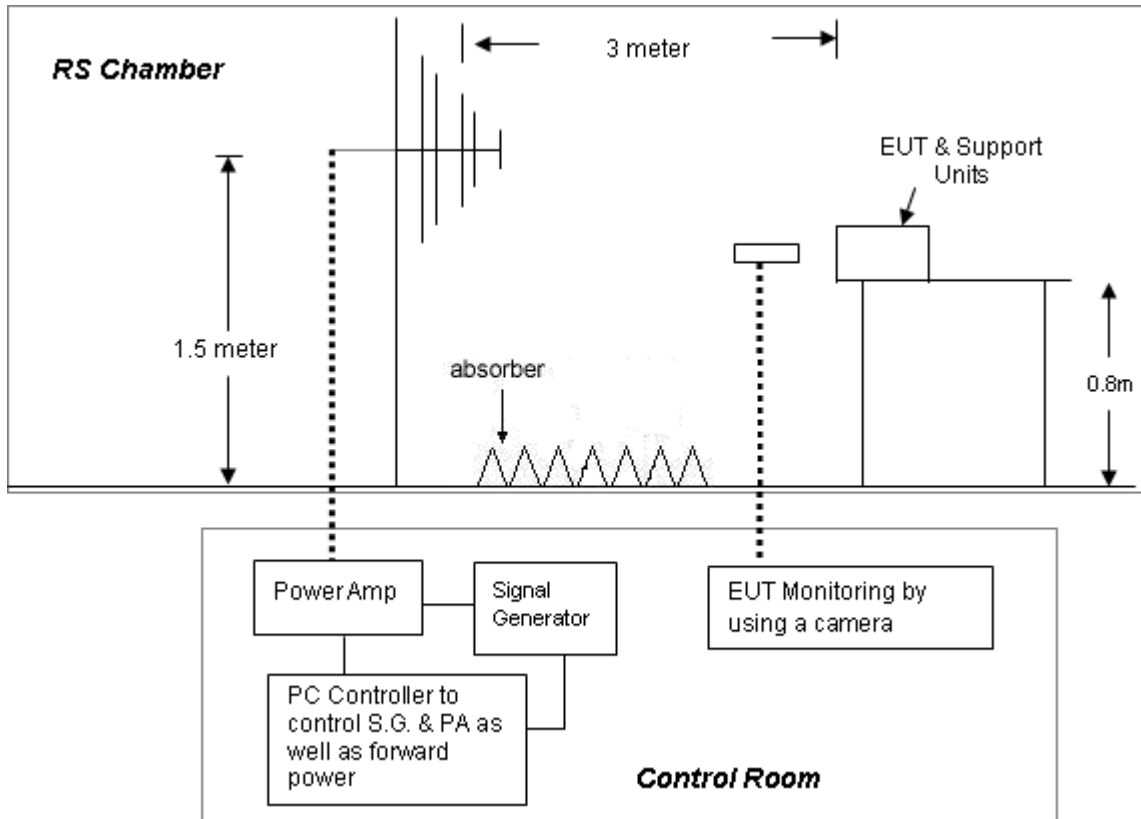

- For the actual test configuration, please refer to the related item – Photographs of the Test Configuration.

#### **NOTE:**

##### TABLETOP EQUIPMENT

The EUT installed in a representative system as described in section 7 of IEC 61000-4-3 was placed on a non-conductive table 0.8 meters in height. The system under test was connected to the power and signal wire according to relevant installation instructions.

##### FLOOR STANDING EQUIPMENT

The EUT installed in a representative system as described in section 7 of IEC 61000-4-3 was placed on a non-conductive wood support 0.1 meters in height. The system under test was connected to the power and signal wire according to relevant installation instructions.



#### 9.4. Measurement Equipment

Instrument/Ancillary	Manufacturer	Model No.	Serial No.	Calibration Date	Valid Date.
Signal Generator	R&S	SML03	103287	2017.03.22	2018.03.21
Power Sensor	R&S	NR P-Z91	100383	2017.03.22	2018.03.21
Power Meter	R&S	NRP	101206	2017.03.22	2018.03.21
Power Amplifier	BONN	BLWA0830-16 0/100/40D	076659	2017.03.22	2018.03.21
Istropic Electric Field Probe	EST.LINDGRE N	HI-6105	137445	2016.11.20	2017.11.19
EMS Antenna	R&S	HL046E	100028	N/A	N/A
Temperature/ Humidity Meter	feiyang	N/A	101	2017.03.28	2018.03.27
EMC-32	Rohde&Schwa rz	Ver 6.10.0	N/A	N/A	N/A





### 9.5. Test Result and Data

Second edition:

Final Test Result : **PASS**  
 Pass performance criteria : A  
 Basic Standard : IEC 61000-4-3  
 Model No. : 350LM00005  
 Frequency Range : 80~1000 MHz  
 Temperature : 22°C  
 Relative Humidity : 53%  
 Atmospheric Pressure : 100 kPa  
 Test Date : Jun 29, 2017

Test Mode: Mode 1,4

Modulation : AM 80% , 1KHz sine wave , Dwell time: 3.0 S				
Frequency Step Size : 1 % of preceding frequency value				
Frequency (MHz)	Antenna Polarization	face	Field strength (V/m)	Result
80~1000	Vertical	Front	3 V/m	A
80~1000	Vertical	Rear	3 V/m	A
80~1000	Vertical	Left	3 V/m	A
80~1000	Vertical	Right	3 V/m	A
80~1000	Horizontal	Front	3 V/m	A
80~1000	Horizontal	Rear	3 V/m	A
80~1000	Horizontal	Left	3 V/m	A
80~1000	Horizontal	Right	3 V/m	A

Test engineer: Sun. Zhang



Original:

Final Test Result : **PASS**  
 Pass performance criteria : A  
 Basic Standard : IEC 61000-4-3  
 Model No. : 350LM00005  
 Frequency Range : 80~1000 MHz  
 Temperature : 22 °C  
 Relative Humidity : 53%  
 Atmospheric Pressure : 100 kPa  
 Test Date : Dec 14, 2016

Test Mode: Mode 1,4

Modulation : AM 80% , 1KHz sine wave , Dwell time: 3.0 S				
Frequency Step Size : 1 % of preceding frequency value				
Frequency (MHz)	Antenna Polarization	face	Field strength (V/m)	Result
80~1000	Vertical	Front	3 V/m	A
80~1000	Vertical	Rear	3 V/m	A
80~1000	Vertical	Left	3 V/m	A
80~1000	Vertical	Right	3 V/m	A
80~1000	Horizontal	Front	3 V/m	A
80~1000	Horizontal	Rear	3 V/m	A
80~1000	Horizontal	Left	3 V/m	A
80~1000	Horizontal	Right	3 V/m	A

Test engineer: Sun. Zhang



### 9.6. Test Photographs

Second edition:



Original:

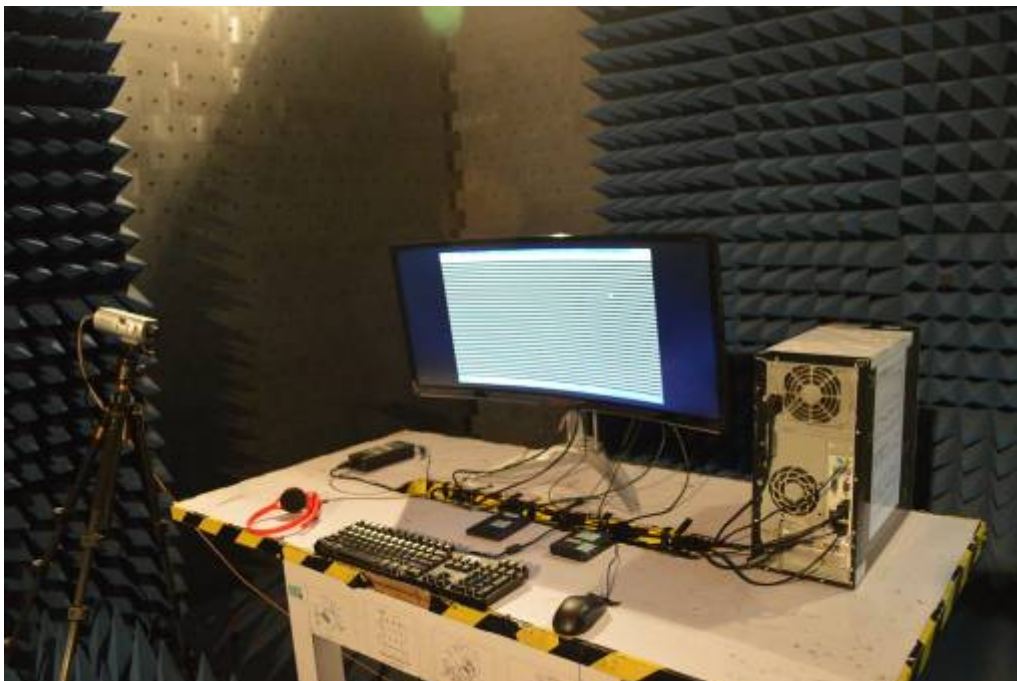



## 10. Electrical Fast Transient/ Burst Immunity Test

### 10.1. Test Procedure

- a. In order to minimize the effect of environmental parameters on test results, the climatic conditions when test is carrying out shall comply with the following requirements:
  - ambient temperature: 15°C to 35°C;
  - relative humidity : 45% to 75%;
  - Atmospheric pressure: 86 Kpa (860 mbar) to 106 Kpa (1060 mbar).
- b. In order to minimize the effect of environmental parameters on test results, the electromagnetic environment of the laboratory shall not influence the test results.
- c. The variety and diversity of equipment and systems to be tested make it difficult to establish general criteria for the evaluation of the effects of fast transients/bursts on equipment and systems.
- d. Test on Power Line:
  - The EFT/B-generator was located on the GRP.  
For floor standing equipment 1,0 m  
For table top equipment 0,5 m
  - The EFT/B-generator provides the ability to apply the test voltage in a non-symmetrical condition to the power supply input terminals of the EUT.
- e. Test on Communication Lines
  - The coupling clamp is composed of a clamp unit for housing the cable (length more than 3 m), and was placed on the GRP.
  - The coupling clamp provides the ability of coupling the fast transient/bursts to the cable under test.
- f. The test results may be classified on the basic of the operating conditions and the functional specification of the equipment under test, according to the following performance criteria :
  - Normal performance within the specification limits.
  - Temporary degradation or loss of function or performance which is self-recoverable.
  - Temporary degradation or loss of function or performance which requires operator intervention or system reset.
  - Degradation or loss of function which is not recoverable due to damage of equipment (components).

### 10.2. Test Severity Levels

The following test severity levels are recommended for the fast transient/burst test :

Open circuit output test voltage $\pm 10\%$		
Level	On Power Supply	On I/O signal, data and control line
1	0.5 KV	0.25 KV
2	1.0 KV	0.50 KV
3	2.0 KV	1.00 KV
4	4.0 KV	2.00 KV
X	Specified	Specified

Remark : “ X ” is an open level. The level is subject to negotiation between the user and manufacturer or is specified by the manufacturer.

### 10.3. TEST SETUP

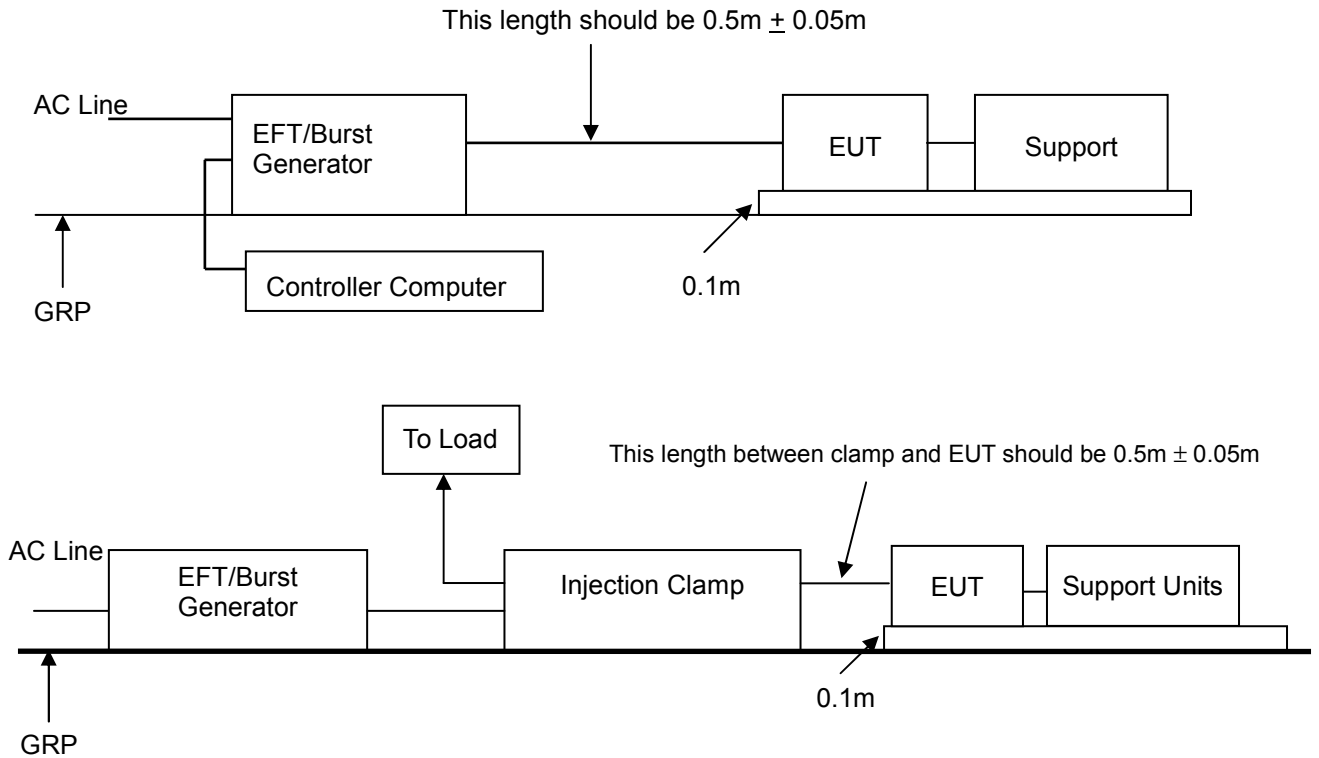

- For the actual test configuration, please refer to the related item – Photographs of the Test Configuration.

**NOTE:**

TABLETOP EQUIPMENT

The configuration consisted of a wooden table (0.1m high) standing on the Ground Reference Plane. The GRP consisted of a sheet of aluminum (at least 0.25mm thick and 2.5m square) connected to the protective grounding system. A minimum distance of 0.5m was provided between the EUT and the walls of the laboratory or any other metallic structure.

FLOOR STANDING EQUIPMENT

The EUT installed in a representative system as described in section 7 of IEC 61000-4-4 and its cables, were isolated from the Ground Reference Plane by an insulating support that is 0.1-meter thick. The GRP consisted of a sheet of aluminum (at least 0.25mm thick and 2.5m square) connected to the protective grounding system.

### 10.4. Measurement Equipment

Instrument/Ancillary	Manufacturer	Model No.	Serial No.	Calibration Date	Valid Date.
TRANSIENT	EMCPARTNER	TRA2000IN6	901	2016.06.26	2017.06.25
CDN	EMCPARTNER	CDN2000-06-32	121	2017.03.22	2018.03.21
Coupling clamp	EMCPARTNER	CN-EFT1000	547	2017.03.22	2018.03.21
Temperature/ Humidity Meter	Zhicheng	ZC1-11	CEP-TH-005	2017.03.28	2018.03.27



**10.5. Test Result and Data**

Final Test Result : **PASS**  
 Pass performance criteria : B  
 Basic Standard : IEC 61000-4-4  
 Model No. : 350LM00005  
 Test Voltage : On Power Supply -- ±1.0 kV  
 : On I/O signal, data and control line -- ±0.5 kV  
 Temperature : 22°C  
 Relative Humidity : 54 %  
 Atmospheric Pressure : 100 kPa  
 Test Date : Jun 29, 2017

Test Mode: Mode1,4

Pulse : 5/50 ns		Repetition Rate: <u>5 kHz</u>			
Burst : 15m/300ms					
Test time : 1 min/each condition					
Voltage/ Mode/ Polarity/ Result/ Phase		<u>0.5 kV</u>		<u>1.0 kV</u>	
		+	-	+	-
Power Line	L	---	---	A	A
	N	---	---	A	A
	L-N	---	---	A	A
	PE	---	---	A	A
	L-PE	---	---	A	A
	N-PE	---	---	A	A
	L-N-PE	---	---	A	A

Test engineer: Sun. Zhang



### 10.6. Test Photographs

Second edition:

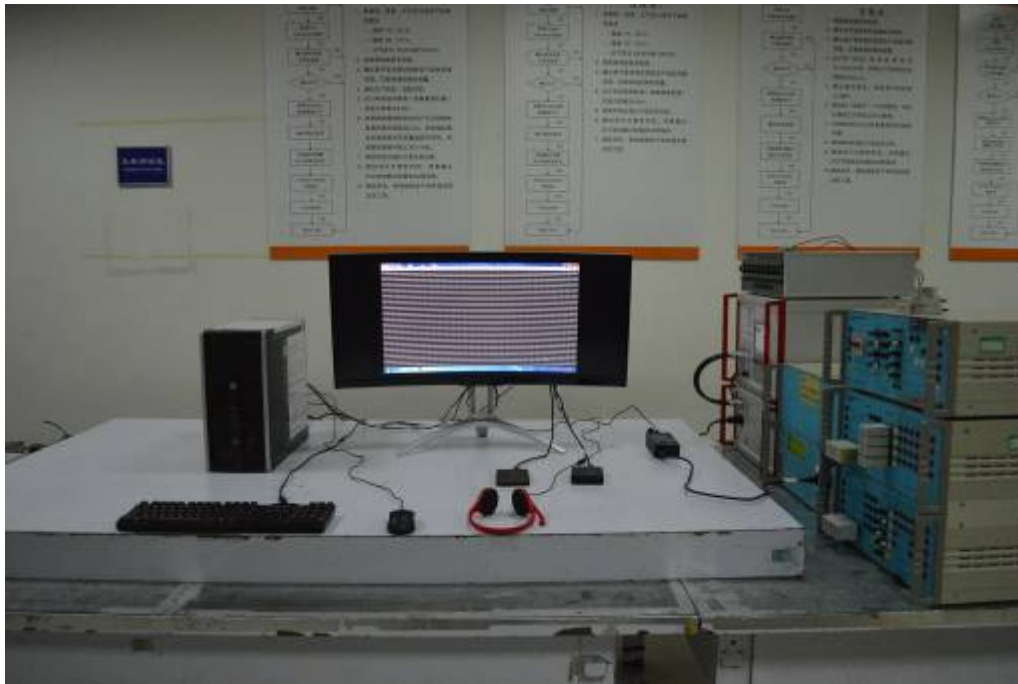

Original:

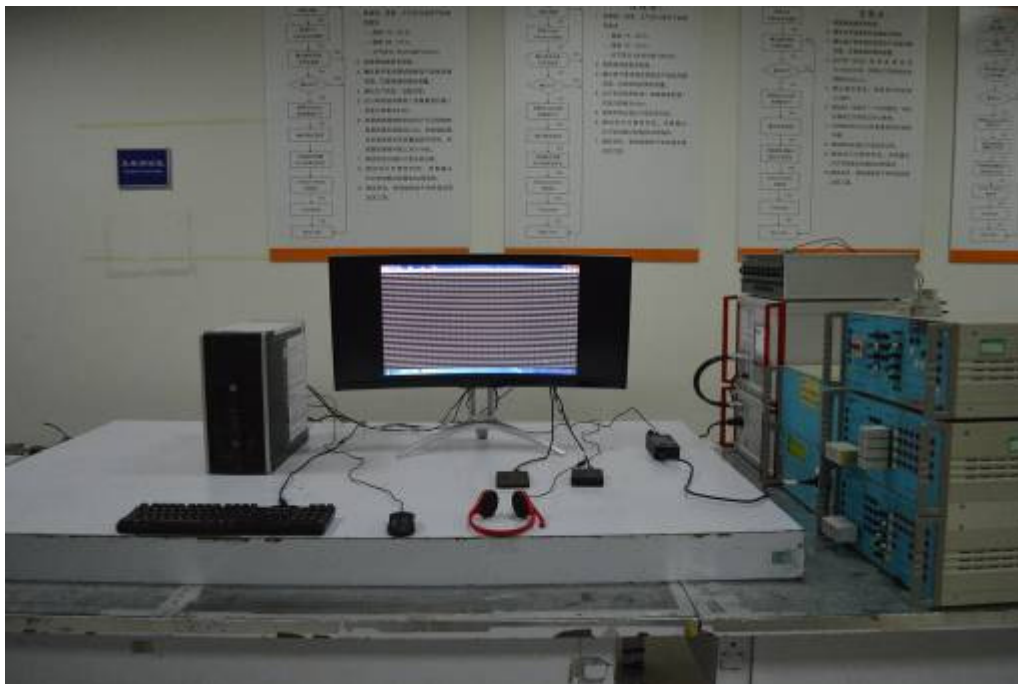



## 11. Surge Immunity Test

### 11.1. Test Procedure

- a. Climatic conditions  
The climatic conditions shall comply with the following requirements :
  - ambient temperature : 15 °C to 35 °C
  - relative humidity : 10 % to 75 %
  - atmospheric pressure : 86 kPa to 106 kPa ( 860 mbar to 1060 mbar )
- b. Electromagnetic conditions  
the electromagnetic environment of the laboratory shall not influence the test results.
- c. The test shall be performed according the test plan that shall specify the test set-up with
  - generator and other equipment utilized;
  - test level ( voltage/current );
  - generator source impedance;
  - internal or external generator trigger;
  - number of tests : at least five positive and five negative at the selected points;
  - repetition rate : maximum 1/min.
  - inputs and outputs to be tested;
  - representative operating conditions of the EUT;
  - sequence of application of the surge to the circuit;
  - phase angle in the case of AC. power supply;
  - actual installation conditions, for example :
    - AC : neutral earthed,
    - DC : ( + ) or ( - ) earthed to simulated the actual earthing conditions.
- d. If not otherwise specified the surges have to be applied synchronized to the voltage phase at the zero-crossing and the peak value of the AC. voltage wave ( positive and negative ).
- e. The surges have to be applied line to line and line(s) and earth. When testing line to earth, the test voltage has to be applied successively between each of the lines and earth, if there is no other specification.
- f. The test procedure shall also consider the non-linear current-voltage characteristics of the equipment under test. Therefore the test voltage has to be increased by steps up to the test level specified in the product standard or test plan.
- g. All lower levels including the selected test level shall be satisfied. For testing the secondary protection, the output voltage of the generator shall be increased up to the worst-case voltage breakdown level ( let-through level ) of the primary protection.
- h. If the actual operating signal sources are not available, that may be simulated. Under no circumstances may the test level exceed the product specification. The test shall be carried out according to a test plan.
- i. To find all critical points of the duty cycle of the equipment, a sufficient number of positive and negative test pulses shall be applied. For acceptance test previously unstressed equipment shall be used to the protection devices shall be replaced.

### 11.2. Test Severity Level

Level	Open-circuit test voltage, $\pm 10\%$ , KV
1	0.5
2	1.0
3	2.0
4	4.0
X	Specified
NOTE: "X" is an open class. This level can be specified in the product specification.	





### 11.3. TEST SETUP

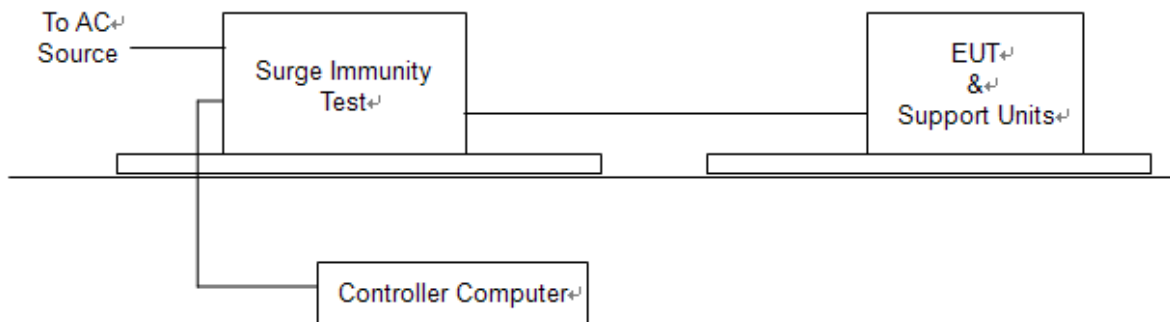

For the actual test configuration, please refer to the related item – Photographs of the Test Configuration.

### 11.4. Measurement Equipment

Instrument/Ancillary	Manufacturer	Model No.	Serial No.	Calibration Date	Valid Date.
TRANSIENT	TESEQ	NSG 3060	1830	2017.02.22	2018.02.21
CDN	TESEQ	CDN 3061	1575	2017.02.22	2018.02.21
CDN	TESEQ	CNV508T5	P 1546167499	2017.02.22	2018.02.21
CDN	TESEQ	CDN HSS-2	41020	2017.02.22	2018.02.21
Temperature/ Humidity Meter	Zhicheng	ZC1-11	CEP-TH-005	2017.03.28	2018.03.27



11.5. Test Result and Data

Second edition:

Final Test Result : **PASS**  
 Pass performance criteria : B  
 Basic Standard : IEC 61000-4-5  
 Model No. : 350LM00005  
 Test Voltage : Input AC Power Port --  $\pm 0.5/1.0$  kV for Line to Line  
 $\pm 0.5/1.0/2.0$  kV for Line to Ground  
 Temperature : 22 °C  
 Relative Humidity : 54 %  
 Atmospheric Pressure : 100 kPa  
 Test Date : Dec 14, 2016

Test Mode: Mode 1,4

Waveform : 1.2/50 $\mu$ s(8/20 $\mu$ s)    Repetition rate : 60 sec    Time : 20 time/each condition						
/Phase Voltage / Mode / Polarity / Result			0°	90°	180°	270°
<u>0.5/1.0</u> kV	L-N	+	A	A	A	A
		-	A	A	A	A
<u>0.5/1.0/2.0</u> kV	L-PE	+	A	A	A	A
		-	A	A	A	A
	N-PE	+	A	A	A	A
		-	A	A	A	A

Test engineer Sun. Zhang



Original:

Final Test Result : **PASS**  
 Pass performance criteria : B  
 Basic Standard : IEC 61000-4-5  
 Model No. : 350LM00005

Test Voltage : Input AC Power Port -- ±0.5/1.0 kV for Line to Line  
 ±0.5/1.0/2.0 kV for Line to Ground

Temperature : 22 °C  
 Relative Humidity : 54 %  
 Atmospheric Pressure : 100 kPa  
 Test Date : Dec 14, 2016

Test Mode: Mode 1,4

Waveform : 1.2/50µs(8/20µs)     Repetition rate : 60 sec     Time : 20 time/each condition						
/Phase Voltage / Mode / Polarity / Result			0°	90°	180°	270°
0.5/1.0 kV	L-N	+	A	A	A	A
		-	A	A	A	A
0.5/1.0/2.0kV	L-PE	+	A	A	A	A
		-	A	A	A	A
	N-PE	+	A	A	A	A
		-	A	A	A	A

Test engineer Sun. Zhang



### 11.6. Test Photographs

Second edition:



Original:





## 12. Conduction Disturbances induced by Radio-Frequency Fields

### 12.1. Test Procedure

- a. The EUT shall be operated within its intended climatic conditions. The temperature and relative humidity should be recorded.
- b. This test method test can be performed without using a sell shielded enclosure. This is because the disturbance levels applied and the geometry of the setups are not likely to radiated a high amount of energy, especially at the lower frequencies. If under certain circumstances the radiated energy is too high, a shielded enclosure has to be used.
- c. The test shall be performed with the test generator connected to each of the coupling and decoupling devices in turn while the other non-excited RF-input ports of the coupling devices are terminated by a 50 ohm load resistor.
- d. The frequency range is swept from 150 KHz to 80 MHz, using the signal levels established during the setting process, and with the disturbance signal 80% amplitude modulated with a 1KHz sign wave, pausing to adjust the RF-signal level or to switch coupling devices as necessary. The rate of sweep shall no exceed  $1.5 \times 10^{-3}$  decades/s. Where the frequency is swept incrementally, the step size shall no exceed 1% of the start and thereafter 1% of the preceding frequency value.
- e. The dwell time at each frequency shall not be less than the time necessary for the EUT to be exercised, and able to respond. Sensitive frequencies e.g. clock frequency (ies) and harmonics or frequencies of dominant interest shall be analyzed separately.
- f. An alternative test procedure may be adopted, wherein the frequency range is swept incrementally, with a step size not exceeding 4% of the start ad thereafter 4% of the preceding frequency value. The test level should be at least twice the value of the specified test level.
- g. In cases of dispute, the test procedure using a step size not exceeding 1% of the start and thereafter 1% of preceding frequency value shall take precedence.
- h. Attempts should be made to fully exercise the EUT during testing, and to fully interrogate all exercise modes selected for susceptibility.
- i. The use of special exercising programs is recommended.
- j. Testing shall be performed according to a Test Plan, which shall be included in the test report.
- k. It may be necessary to carry out some investigatory testing in order to establish some aspects of the test plan.

### 12.2. Test Severity Levels

Level	Voltage Level ( e.m.f. )
1	1 V
2	3 V
3	10 V
x	Specified
NOTE - x is an open class. This level can be specified in the product specification.	

**12.3.TEST SETUP**

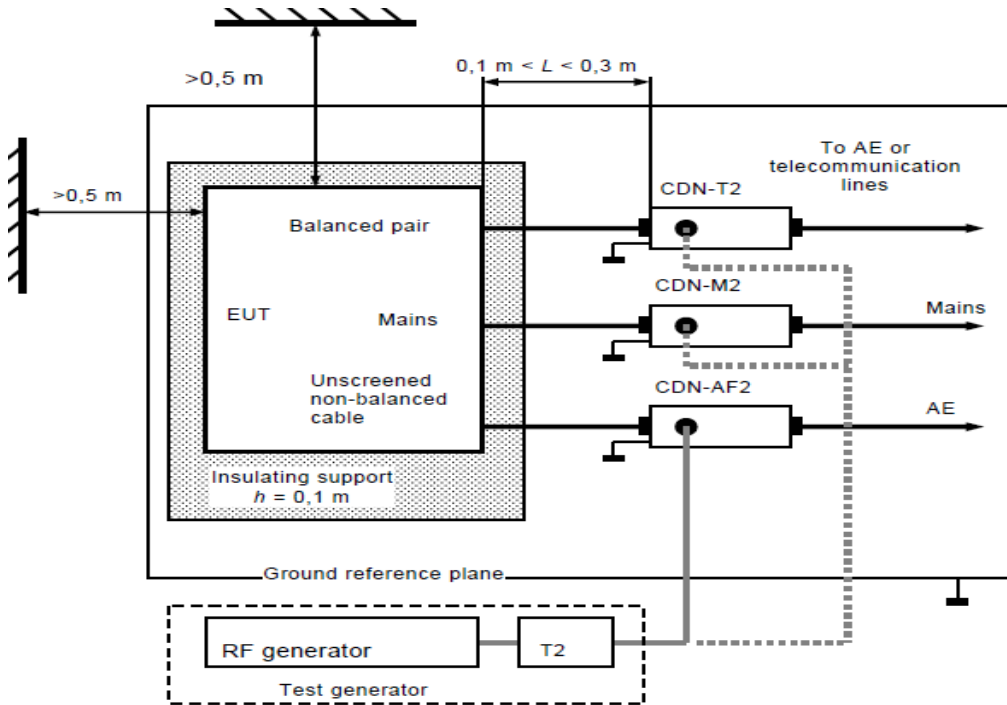

- Note:**
1. The EUT is setup 0.1m above Ground Reference Plane
  2. The CDNs and / or EM clamp used for real test depends on ports and cables configuration of EUT.
  3. For the actual test configuration, please refer to the related item – Photographs of the Test Configuration.

**12.4.Measurement Equipment**

Instrument/Ancillary	Manufacturer	Model No.	Serial No.	Calibration Date	Valid Date.
Conducted immunity test system	FRANKONIA	CIT-10/75	102D1294	2017.03.22	2018.03.21
EM Injection clamp	FCC	F-203I-23MM	536	2017.03.22	2018.03.21
CDN	FRANKONIA	CDN-M2+M3	A3011102	2017.03.22	2018.03.21
CDN	FCC	CDN-M5/32	A3013024	2017.03.22	2018.03.21
CDN	TESEQ	CDN T8-10	43767	2016.09.08	2017.09.07
CDN	TESEQ	CDN T2-10	43762	2016.08.30	2017.08.29
CDN	TESEQ	CDN T4-10	43754	2016.09.08	2017.09.07
CDN	TESEQ	CDN M016	44025	2016.09.12	2017.09.11
6 dB Attenuator	FRANKONIA	N/A	N/A	2017.03.22	2018.03.21
Temperature/ Humidity Meter	Zhicheng	ZC1-11	CEP-TH-005	2017.03.28	2018.03.27
EN61000-4-6	Hubert GmbH	Ver 2.21	N/A	N/A	N/A



**12.5. Test Result and Data**

Second edition:

Final Test Result : **PASS**

Pass performance criteria : A

Basic Standard : IEC 61000-4-6

Model No. : 350LM00005  
CDN-(M2+M3) for AC power ports

Coupling mode : CDN-T4 for signal ports  
EM-Clamp for signal ports

Temperature : 22 °C

Relative Humidity : 54 %

Atmospheric Pressure : 100 kPa

Test Date : Jun 29, 2017

Test Mode : Mode 1,4

Frequency : 0.15~80MHz, Modulation : AM 80%,1KHz sine wave, Dwell time:3.0s			
Frequency Step Size : 1 % of preceding frequency value			
Frequency	Test mode	Voltage(V)	Result
0.15 ~ 80MHz	Power(M3)	3	A

Test engineer: Sun. Zhang



Original:

Final Test Result : **PASS**  
 Pass performance criteria : A  
 Basic Standard : IEC 61000-4-6  
 Model No. : 350LM00005  
 Coupling mode : CDN-(M2+M3) for AC power ports  
 : CDN-T4 for signal ports  
 : EM-Clamp for signal ports  
 Temperature : 22°C  
 Relative Humidity : 54 %  
 Atmospheric Pressure : 100 kPa  
 Test Date : Dec 14, 2016

Test Mode : Mode 1,4

Frequency : 0.15~80MHz, Modulation : AM 80%,1KHz sine wave, Dwell time:3.0s			
Frequency Step Size : 1 % of preceding frequency value			
Frequency	Test mode	Voltage(V)	Result
0.15 ~ 80MHz	Power(M3)	3	A

Test engineer: Sun. Zhang





## 12.6. Test Photographs

Second edition:



Original:

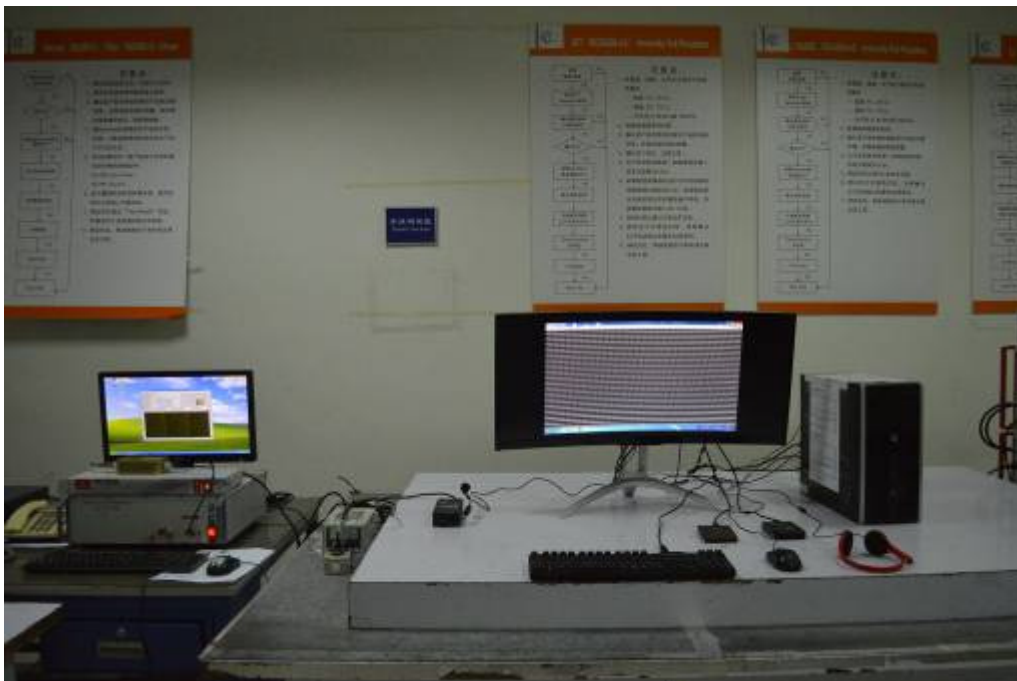

### 13. Power Frequency Magnetic Field Immunity Test

#### 13.1. Test Setup

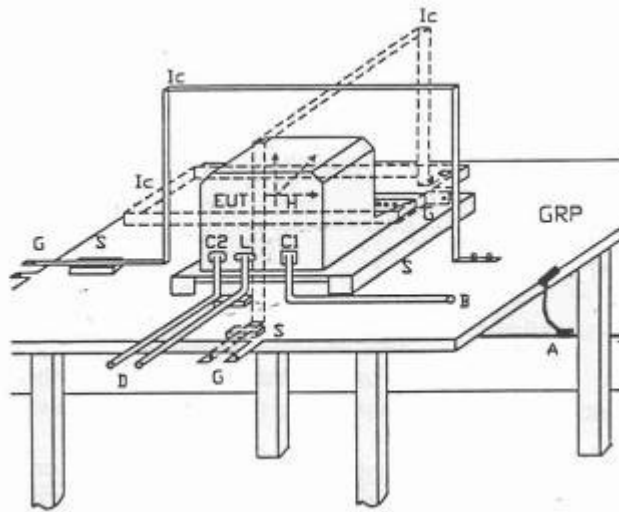

- GPR : Ground plane
- A : Safety earth
- S : Insulating support
- EUT : Equipment under test
- Lc : Induction coil
- E : Earth terminal
- C1 : Power supply circuit
- C2 : Signal circuit
- L : Communication line
- B : To power supply source
- D : To signal source, simulator
- G : To the test generator

#### 13.2. Test Severity Levels

Level	Magnetic field strength (A/m)
1	1
2	3
3	10
4	30
5	100
X <sup>1)</sup>	special

NOTE 1 "X" is an open level. This level can be given in the product specification.

#### 13.3. Measurement Equipment

Instrument/Ancillary	Manufacturer	Model No.	Serial No.	Calibration Date	Valid Date.
TRANSIENT	EMCPARTNER	TRA2000IN6	901	2016.06.26	2017.06.25
H-Filed-Loop	EMCPARTNER	MF1000-1	144	2017.03.22	2018.03.21
Temperature/ Humidity Meter	Zhicheng	ZC1-11	CEP-TH-005	2017.03.28	2018.03.27



13.4. Test Result and Data

Second edition:

Final Test Result : **PASS**  
 Pass performance criteria : A  
 Basic Standard : IEC 61000-4-8  
 Model No. : 350LM00005  
 Temperature : 22°C  
 Relative Humidity : 54 %  
 Atmospheric Pressure : 100 kPa  
 Test Date : Jun 29, 2017

Test Mode: Mode 1,4

Power Frequency Magnetic Field : <u>50</u> Hz, <u>1</u> A/m		
Coil Orientation	Testing duration	Results
X-axis	1.0 Min	A
Y-axis	1.0 Min	A
Z-axis	1.0 Min	A
Power Frequency Magnetic Field : <u>60</u> Hz, <u>1</u> A/m		
Coil Orientation	Testing duration	Results
X-axis	1.0 Min	A
Y-axis	1.0 Min	A
Z-axis	1.0 Min	A

Test engineer: Sun. Zhang



Original:

Final Test Result : **PASS**  
 Pass performance criteria : A  
 Basic Standard : IEC 61000-4-8  
 Model No. : 350LM00005  
 Temperature : 22°C  
 Relative Humidity : 54 %  
 Atmospheric Pressure : 100 kPa  
 Test Date : Dec 14, 2016

Test Mode: Mode 1,4

Power Frequency Magnetic Field : <u>50</u> Hz, <u>1</u> A/m		
Coil Orientation	Testing duration	Results
X-axis	1.0 Min	A
Y-axis	1.0 Min	A
Z-axis	1.0 Min	A
Power Frequency Magnetic Field : <u>60</u> Hz, <u>1</u> A/m		
Coil Orientation	Testing duration	Results
X-axis	1.0 Min	A
Y-axis	1.0 Min	A
Z-axis	1.0 Min	A

Test engineer: Sun. Zhang



### 13.5. Test Photographs

Second edition:



Original:



## 14. Voltage Dips and Voltage Interruptions Immunity Test Setup

### 14.1. Test Conditions

1. Source voltage and frequency : AC 100/230/240V / 50Hz, Single phase.
2. Test of interval : 10 sec.
3. Level and duration : Sequence of 3 dips/interrupts.
4. Voltage rise (and fall) time : 1 ~ 5  $\mu$ s.
5. Test severity :

Voltage dips and Interrupt reduction (%)	Test Duration (period)
>95%	250
30%	25
>95%	0.5

### 14.2. TEST SETUP

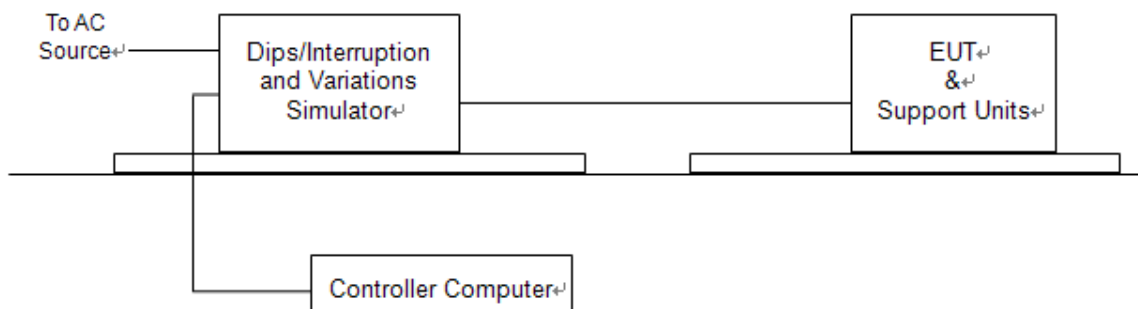

For the actual test configuration, please refer to the related item – Photographs of the Test Configuration.

### 14.3. Measurement Equipment

Instrument/Ancillary	Manufacturer	Model No.	Serial No.	Calibration Date	Valid Date.
TRANSIENT	EMCPARTNER	TRA2000IN6	901	2016.06.26	2017.06.25
Temperature/ Humidity Meter	Zhicheng	ZC1-11	CEP-TH-005	2017.03.28	2018.03.27



### 14.4. Test Result and Data

Second edition:

Final Test Result : **PASS**  
 Pass performance Criteria : C for voltage interruption, B for voltage dips  
 Basic Standard : IEC 61000-4-11  
 Model No. : 350LM00005  
 Temperature : 22°C  
 Relative Humidity : 54 %  
 Atmospheric Pressure : 100 kPa  
 Test Date : Jun 29, 2017

Test Mode: Mode 1,4

Voltage(UT): AC 230 V/240V 50 Hz Interval(s) : 10s Times : 3										
Test mod	Test level UT %	Durations (period / ms )	Phase / Result							
			0	45	90	135	180	225	270	315
Voltage interruptions	>95%	250	C	C	C	C	C	C	C	C
Voltage dips	30%	25	A	A	A	A	A	A	A	A
	>95%	0.5	A	A	A	A	A	A	A	A

Test Mode: Mode 1,4,

Voltage(UT): AC 100 V 50 Hz Interval(s) : 10s Times : 3										
Test mod	Test level UT %	Durations (period / ms )	Phase / Result							
			0	45	90	135	180	225	270	315
Voltage interruptions	>95%	250	C	C	C	C	C	C	C	C
Voltage dips	30%	25	B	B	B	B	B	B	B	B
	>95%	0.5	B	B	B	B	B	B	B	B

Test engineer: Sun. Zhang



Original:

Final Test Result : **PASS**  
 Pass performance Criteria : C for voltage interruption, B for voltage dips  
 Basic Standard : IEC 61000-4-11  
 Model No. : 350LM00005  
 Temperature : 22°C  
 Relative Humidity : 54 %  
 Atmospheric Pressure : 100 kPa  
 Test Date : Dec 14, 2016

Test Mode: Mode 1,4

Voltage(UT): AC 230 V/240V 50 Hz Interval(s) : 10s Times : 3										
Test mod	Test level UT %	Durations (period / ms )	Phase / Result							
			0	45	90	135	180	225	270	315
Voltage interruptions	>95%	250	C	C	C	C	C	C	C	C
Voltage dips	30%	25	A	A	A	A	A	A	A	A
	>95%	0.5	A	A	A	A	A	A	A	A

Test Mode: Mode 1,4,

Voltage(UT): AC 100 V 50 Hz Interval(s) : 10s Times : 3										
Test mod	Test level UT %	Durations (period / ms )	Phase / Result							
			0	45	90	135	180	225	270	315
Voltage interruptions	>95%	250	C	C	C	C	C	C	C	C
Voltage dips	30%	25	B	B	B	B	B	B	B	B
	>95%	0.5	B	B	B	B	B	B	B	B

Test engineer: Sun. Zhang





### 14.5. Test Photographs

Second edition:

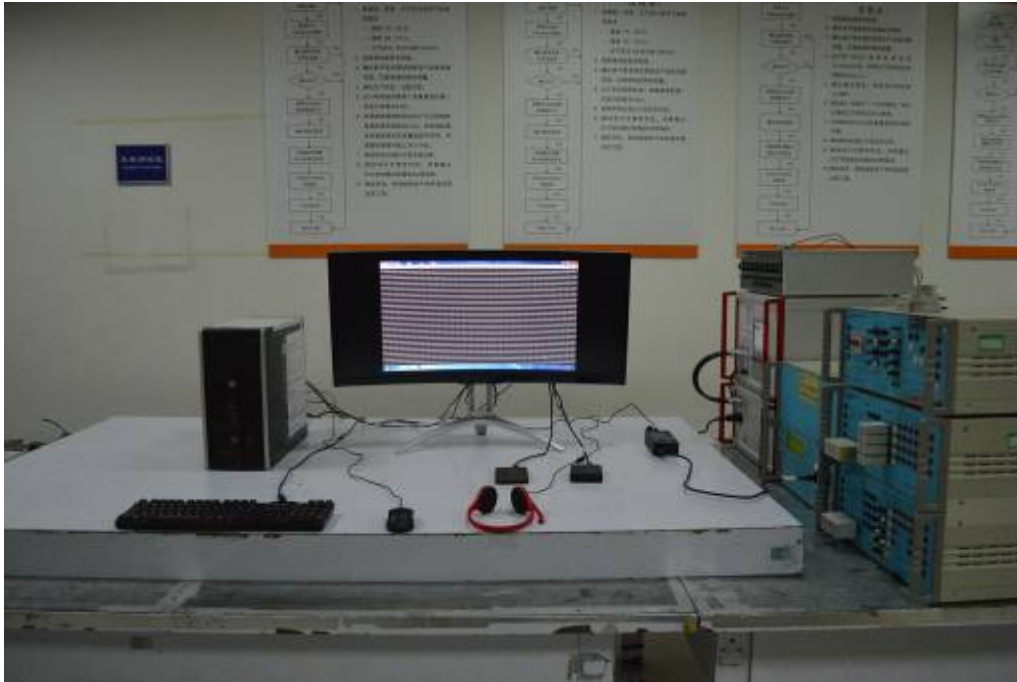

Original:





## 15. Photographs of EUT

### 1) EUT Photo

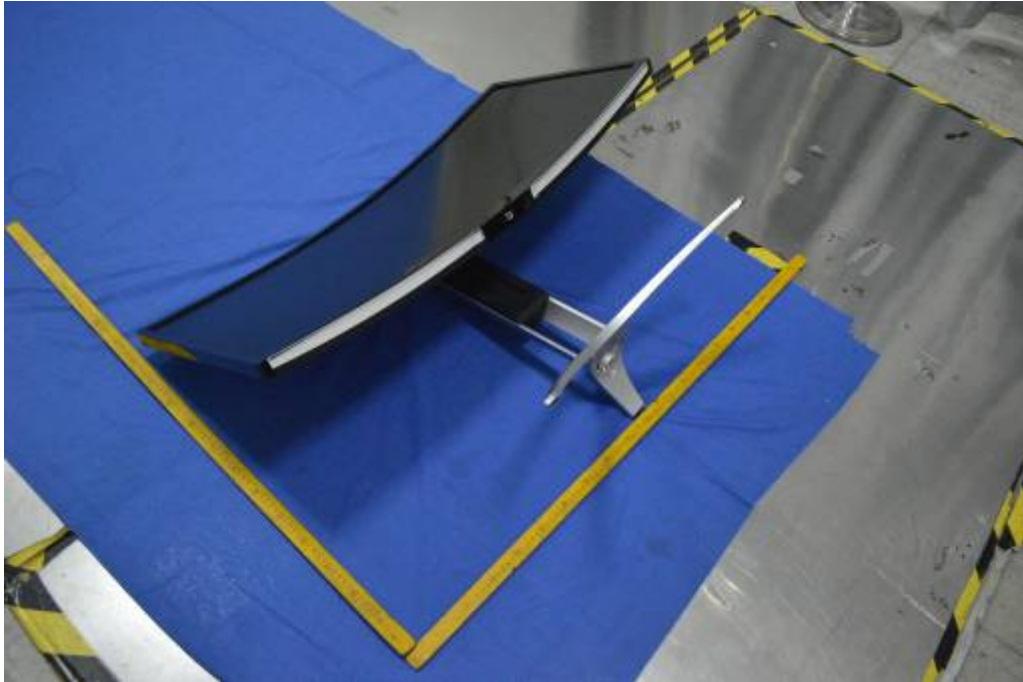

### 2) EUT Photo

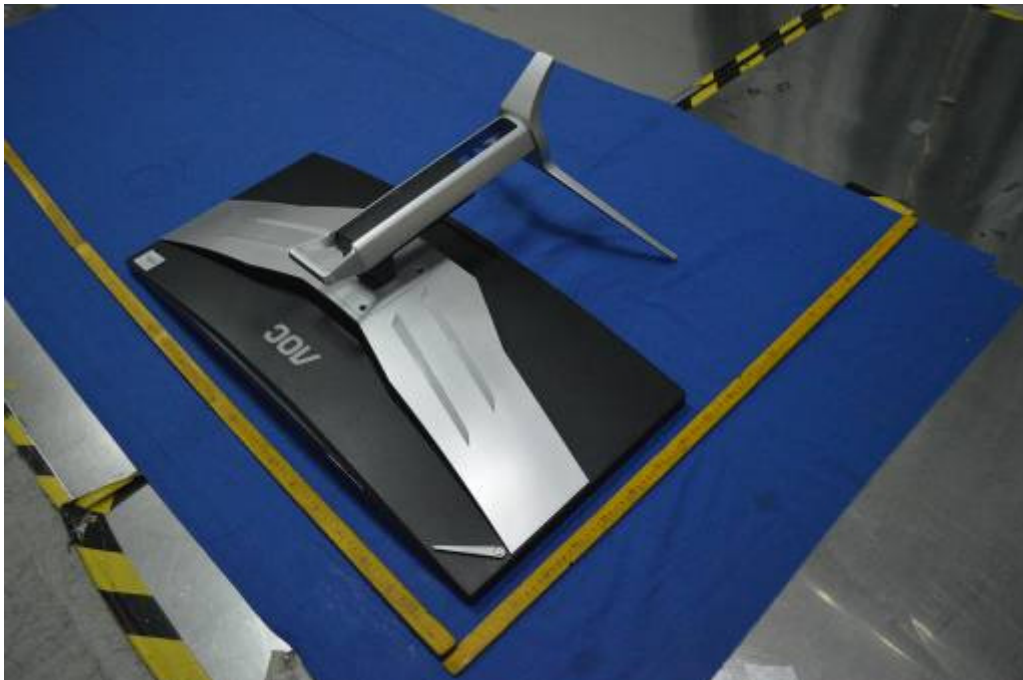



3) EUT Photo



4) EUT Photo

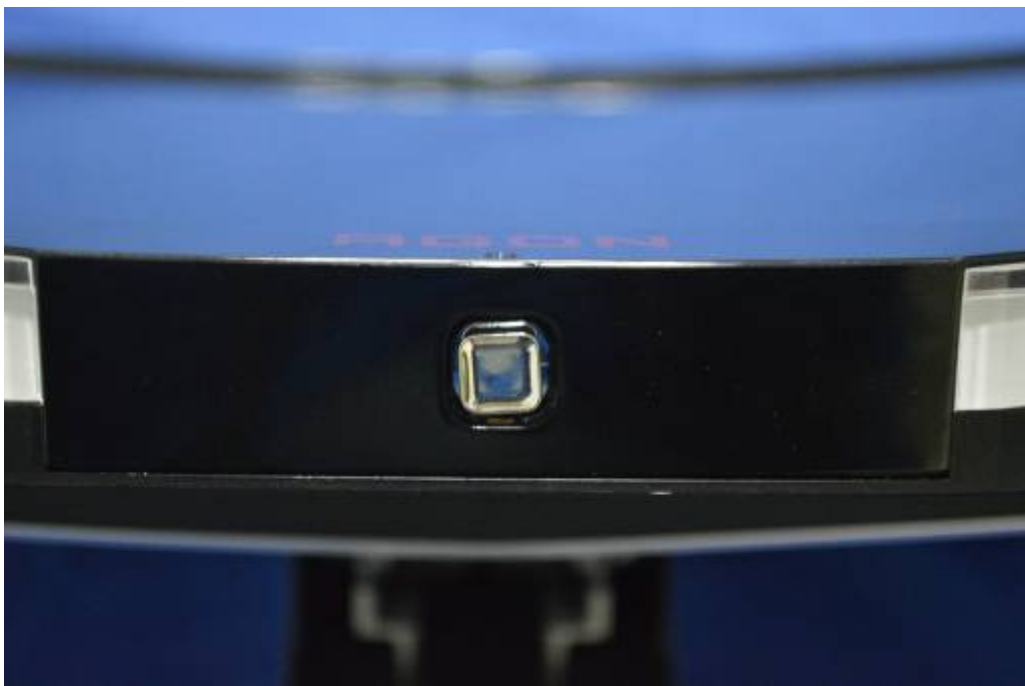



5) EUT Photo



6) EUT Photo(adapter)



7) EUT Photo(adapter)



8) EUT Photo(adapter)





9) EUT Photo(adapter)



10) EUT Photo(adapter)





11) EUT Photo(adapter)



12) EUT Photo(Add adapter:ADPC2090)





13) EUT Photo(adapter)



14) EUT Photo(adapter)





15) EUT Photo(adapter)



16) EUT Photo(adapter)





17) EUT Photo(adapter)

