



® TM

Ref. Certif. No.

JPTUV-112066

IEC SYSTEM FOR MUTUAL RECOGNITION OF TEST CERTIFICATES FOR ELECTRICAL EQUIPMENT (IECEE) CB SCHEME

CB TEST CERTIFICATE

Product

LCD MONITOR (LED backlight)

Name and address of the applicant

TPV Electronics (Fujian) Co., Ltd.
Rongqiao Economic and Technological Development Zone, Fuqing City, Fujian, P.R. China

Name and address of the manufacturer

TPV Electronics (Fujian) Co., Ltd.
Rongqiao Economic and Technological Development Zone, Fuqing City, Fujian, P.R. China

Name and address of the factory

See additional page(s)

Ratings and principal characteristics

I/P: 100-240VAC; 50/60Hz; 1.5A; Class I

Trademark (if any)

AOC

Customer's Testing Facility (CTF) Stage used

N/A

Model / Type Ref.

24G1*****, C24G1*****, C*24G1*****, Q24G1*****, U24G1*****, 24G2*****, C24G2*****, C*24G2*****, Q24G2*****, U24G2*****, 27G1*****, C27G1*****, C*27G1*****, Q27G1*****, U27G1*****, 27G2*****, C27G2*****, C*27G2*****, Q27G2*****, U27G2***** (* can be 0-9, A-Z, a-z, +, -, /, \ or blank)
For model differences, refer to the test report.

Additional information (if necessary may also be reported on page 2)

A sample of the product was tested and found to be in conformity with

IEC 62368-1:2014
See Test Report for National Differences

As shown in the Test Report Ref. No. which forms part of this Certificate

60394462 001

This CB Test Certificate is issued by the National Certification Body



TÜVRheinland®

TÜV Rheinland Japan Ltd.
Global Technology Assessment Center
4-25-2 Kita-Yamata, Tsuzuki-ku
Yokohama 224-0021, Japan
Phone + 81 45 914-3888
Fax + 81 45 914-3354
Mail: info@jpn.tuv.com
Web : www.tuv.com

Date: 2020-07-31

Signature:

Aegean Li

1. TPV Display Technology (Wuhan) Co., Ltd.
Unique No. 11, Zhuankou Development District of Economic Technological Development Zone, 430056 Wuhan City, P.R. China
2. TPV Electronics (Fujian) Co., Ltd.
Shangzheng, Yuan Hong Road
Fuqing City
Fujian
P.R. China
3. L&T Display Technology (Fujian) Ltd.
Optoelectronic Park, Rongqiao Economic and Technological Development Zone
Fuqing, 350301 Fujian, P.R. China
4. TPV Electronics (Fujian) Co., Ltd.
Rongqiao Economic and Technological Development Zone
Fuqing City
Fujian, P.R. China
5. TPV Display Technology (Beihai) Co., Ltd.
China Electronic Beihai Industry Park, Northeast of the Crossing Between Taiwan Road and Jilin Road, Beihai City, Guangxi, P.R. China
6. TPV Display Technology (China) Co., Ltd.
No. 106 Jinghai 3 Rd.,
BDA
100176 Beijing
P.R. China
7. Trend Smart CE Mexico S de RL de CV
Avenida Sor Juana Ines de la Cruz de 19602 Nueva Tijuana,
22435 Tijuana Baja California
MEXICO

Additional information (if necessary)

Report Ref. No. : 60394462 001

Date: 2020-07-31

Signature:



Aegean Li

8. TPV Technology (Qingdao)
Co., Ltd.
No.99 Huoju Road, High-tech
Industrial Development Zone
Qingdao City, Shandong, P.R. China
9. Envision Indústria de Produtos
Eletrônicos Ltda.
Av. Torquato Tapajós, 2236,
Flores - CEP 69058-830 - Manaus/AM
Brazil
10. Pro Concept Manufacturer Co., Ltd
88/1 Moo 12, Soi
Phetkasem 120, Phetkasem
Road, Omnoi, Krathumbaen,
Samutsakhon 74130, Thailand
11. TPV Technology (Thailand) Co., Ltd.
No.267 Mu7,
Tha Tum Sub- District, Si Maha Pho District,
Prachin Buri Province
Thailand
12. TPV Electronics (Fujian) Co., Ltd.
Optoelectronic Park,
Rongqiao Economic and
Technological Development Zone,
Fuqing City, 350301 Fujian, P.R. China
13. GeneTouch Corp.
No. 9 Neixi Rd.,
Luzhu Dist., Taoyuan City 33852
Taiwan

Additional information (if necessary)

Report Ref. No. : 60394462 001

Date: 2020-07-31

Signature:



Aegean Li



Test Report issued under the responsibility of:



TEST REPORT

IEC 62368-1

**Audio/video, information and communication technology equipment
Part 1: Safety requirements**

Report Number	60394462 001
Date of issue	Jul.29, 2020
Total number of pages	75 pages
Applicant's name	TPV Electronics (Fujian) Co., Ltd.
Address	Rongqiao Economic and Technological Development Zone Fuqing City, Fujian, P.R.China

Test specification:	
Standard.....	IEC 62368-1:2014 (Second Edition)
Test procedure	CB Scheme
Non-standard test method	N/A

Test Report Form No.	IEC62368_1B
Test Report Form(s) Originator.....	UL(US)
Master TRF	2014-03

Copyright © 2014 Worldwide System for Conformity Testing and Certification of Electrotechnical Equipment and Components (IECEE), Geneva, Switzerland. All rights reserved.



This publication may be reproduced in whole or in part for non-commercial purposes as long as the IECEE is acknowledged as copyright owner and source of the material. IECEE takes no responsibility for and will not assume liability for damages resulting from the reader's interpretation of the reproduced material due to its placement and context.

If this Test Report Form is used by non-IECEE members, the IECEE/IEC logo and the reference to the CB Scheme procedure shall be removed.

This report is not valid as a CB Test Report unless signed by an approved CB Testing Laboratory and appended to a CB Test Certificate issued by an NCB in accordance with IECEE 02.

General disclaimer:

The test results presented in this report relate only to the object tested.
 This report shall not be reproduced, except in full, without the written approval of the Issuing CB Testing Laboratory. The authenticity of this Test Report and its contents can be verified by contacting the NCB, responsible for this Test Report.

Test Item description	LCD MONITOR (LED backlight)	
Trade Mark	AOC	
Manufacturer	Same as applicant	
Model/Type reference	24G1*****, C24G1*****, C*24G1*****, Q24G1*****, U24G1*****, 24G2*****, C24G2*****, C*24G2*****, Q24G2*****, U24G2*****, 27G1*****, C27G1*****, C*27G1*****, Q27G1*****, U27G1*****, 27G2*****, C27G2*****, C*27G2*****, Q27G2*****, U27G2*****, (* can be 0-9, A-Z, a-z, "+", "-", "/", "\" or blank, Represent different enclosure color and sales region for marketing purpose. No technology differences)	
Ratings	I/P: 100-240V~, 50/60Hz, 1.5A	
Testing procedure and testing location:		
<input checked="" type="checkbox"/> CB Testing Laboratory:	TÜV Rheinland (Shenzhen) Co., Ltd.	
Testing location/ address	1F East & 2-4F, Cybio Technology Building No. 1, No. 16 Kejibei 2nd Road, High-Tech Industrial Park North, Nanshan District 518057, Shenzhen, China	
<input type="checkbox"/> Associated CB Testing Laboratory:		
Testing location/ address		
Tested by (name + signature)	Jason Zheng Project Handler	
Approved by (name + signature)	Anderson Wang Technical Certifier	
Testing procedure: TMP/CTF Stage 1		
Testing location/ address		
Tested by (name + signature)		
Approved by (name + signature)		
Testing procedure: WMT/CTF Stage 2		
Testing location/ address		
Tested by (name + signature)		
Witnessed by (name + signature)		
Approved by (name + signature)		
Testing procedure: SMT/CTF Stage 3 or 4		
Testing location/ address		
Tested by (name + signature)		
Approved by (name + signature)		
Supervised by (name + signature)		

List of Attachments (including a total number of pages in each attachment):																																																	
<ul style="list-style-type: none"> - Measurement Section (4 Pages) - National Differences (35 Pages) - Photo documentation (17 Pages) 																																																	
Summary of testing:																																																	
Tests performed (name of test and test clause):	Testing location:																																																
<table border="1"> <thead> <tr> <th>name of test</th> <th>test clause number</th> </tr> </thead> <tbody> <tr> <td>Classification of electrical energy sources</td> <td>5.2</td> </tr> <tr> <td>Accessibility to electrical energy sources and safeguards (Accessibility test)</td> <td>5.3.2</td> </tr> <tr> <td>Maximum operating temperature test (Heating test)</td> <td>5.4.1.4, 6.3.2, 9.0, B.2.6</td> </tr> <tr> <td>Determination of working voltage</td> <td>5.4.1.8</td> </tr> <tr> <td>Humidity test</td> <td>5.4.8</td> </tr> <tr> <td>Electric strength test</td> <td>5.4.9</td> </tr> <tr> <td>Safeguards against capacitance discharge test</td> <td>5.5.2.2</td> </tr> <tr> <td>Resistance of the protective bonding system (Ground continuity test)</td> <td>5.6.6.2</td> </tr> <tr> <td>Earthed accessible conductive part test</td> <td>5.7.2.2, 5.7.4</td> </tr> <tr> <td>Electrical Power Source (PS) measurements for classification</td> <td>6.2.2</td> </tr> <tr> <td>Stability</td> <td>8.6</td> </tr> <tr> <td>Wall or ceiling mount loading test</td> <td>8.7</td> </tr> <tr> <td>Input test</td> <td>Annex B.2.5</td> </tr> <tr> <td>Simulated abnormal operating and single fault conditions</td> <td>B.3, B.4</td> </tr> <tr> <td>Test for permanence of markings</td> <td>Annex F.3.10</td> </tr> <tr> <td>Transformer insulation</td> <td>G.5.3.2</td> </tr> <tr> <td>Transformer overload</td> <td>G.5.3.3</td> </tr> <tr> <td>Safeguards against entry of foreign object</td> <td>Annex P2.2</td> </tr> <tr> <td>Limited power source test (LPS)</td> <td>Annex Q.1</td> </tr> <tr> <td>Limited short circuit test</td> <td>Annex R</td> </tr> <tr> <td>Steady force test, 10N, 30N, 250N</td> <td>Annex T.2, T.3, T.5</td> </tr> <tr> <td>Enclosure impact test</td> <td>Annex T.6</td> </tr> <tr> <td>Stress relief test</td> <td>Annex T.8</td> </tr> </tbody> </table>	name of test	test clause number	Classification of electrical energy sources	5.2	Accessibility to electrical energy sources and safeguards (Accessibility test)	5.3.2	Maximum operating temperature test (Heating test)	5.4.1.4, 6.3.2, 9.0, B.2.6	Determination of working voltage	5.4.1.8	Humidity test	5.4.8	Electric strength test	5.4.9	Safeguards against capacitance discharge test	5.5.2.2	Resistance of the protective bonding system (Ground continuity test)	5.6.6.2	Earthed accessible conductive part test	5.7.2.2, 5.7.4	Electrical Power Source (PS) measurements for classification	6.2.2	Stability	8.6	Wall or ceiling mount loading test	8.7	Input test	Annex B.2.5	Simulated abnormal operating and single fault conditions	B.3, B.4	Test for permanence of markings	Annex F.3.10	Transformer insulation	G.5.3.2	Transformer overload	G.5.3.3	Safeguards against entry of foreign object	Annex P2.2	Limited power source test (LPS)	Annex Q.1	Limited short circuit test	Annex R	Steady force test, 10N, 30N, 250N	Annex T.2, T.3, T.5	Enclosure impact test	Annex T.6	Stress relief test	Annex T.8	<p>All tests as described in Test Case and Measurement Sections were performed at the laboratory described on page 2.</p>
name of test	test clause number																																																
Classification of electrical energy sources	5.2																																																
Accessibility to electrical energy sources and safeguards (Accessibility test)	5.3.2																																																
Maximum operating temperature test (Heating test)	5.4.1.4, 6.3.2, 9.0, B.2.6																																																
Determination of working voltage	5.4.1.8																																																
Humidity test	5.4.8																																																
Electric strength test	5.4.9																																																
Safeguards against capacitance discharge test	5.5.2.2																																																
Resistance of the protective bonding system (Ground continuity test)	5.6.6.2																																																
Earthed accessible conductive part test	5.7.2.2, 5.7.4																																																
Electrical Power Source (PS) measurements for classification	6.2.2																																																
Stability	8.6																																																
Wall or ceiling mount loading test	8.7																																																
Input test	Annex B.2.5																																																
Simulated abnormal operating and single fault conditions	B.3, B.4																																																
Test for permanence of markings	Annex F.3.10																																																
Transformer insulation	G.5.3.2																																																
Transformer overload	G.5.3.3																																																
Safeguards against entry of foreign object	Annex P2.2																																																
Limited power source test (LPS)	Annex Q.1																																																
Limited short circuit test	Annex R																																																
Steady force test, 10N, 30N, 250N	Annex T.2, T.3, T.5																																																
Enclosure impact test	Annex T.6																																																
Stress relief test	Annex T.8																																																
The EUT passed the test.																																																	

Summary of compliance with National Differences:

List of countries addressed

EU Group Differences, EU Special National Conditions, AU, CA, DK, FI, IT, JP, NZ, SE, US

Explanation of used codes: AU=Australia, CA=Canada, DK=Denmark, FI=Finland, IT=Italy, JP=Japan, NZ=New Zealand, SE=Sweden, US=United States of America

The product fulfils the requirements of EN 62368-1:2014+ A11:2017.

Copy of marking plate:

The artwork below may be only a draft. The use of certification marks on a product must be authorized by the respective NCBs that own these marks.



Note:

All models' rating labels are in the same design except for type designation. Above labels are representing the other models.

TEST ITEM PARTICULARS:	
Classification of use by	<input checked="" type="checkbox"/> Ordinary person <input type="checkbox"/> Instructed person <input type="checkbox"/> Skilled person <input checked="" type="checkbox"/> Children likely to be present
Supply Connection	<input checked="" type="checkbox"/> AC Mains <input type="checkbox"/> DC Mains <input type="checkbox"/> External Circuit - not Mains connected - <input type="checkbox"/> ES1 <input type="checkbox"/> ES2 <input type="checkbox"/> ES3
Supply % Tolerance	<input checked="" type="checkbox"/> +10%/-10% <input type="checkbox"/> +20%/-15% <input type="checkbox"/> + ____ % / - ____ % <input type="checkbox"/> None
Supply Connection – Type	<input checked="" type="checkbox"/> pluggable equipment type A - <input type="checkbox"/> non-detachable supply cord <input checked="" type="checkbox"/> appliance coupler <input type="checkbox"/> direct plug-in <input type="checkbox"/> mating connector <input type="checkbox"/> pluggable equipment type B - <input type="checkbox"/> non-detachable supply cord <input type="checkbox"/> appliance coupler <input type="checkbox"/> permanent connection <input type="checkbox"/> mating connector <input type="checkbox"/> other: _____
Considered current rating of protective device as part of building or equipment installation	<u>16</u> A (20A for North America); Installation location: <input checked="" type="checkbox"/> building; <input type="checkbox"/> equipment
Equipment mobility	<input checked="" type="checkbox"/> movable <input type="checkbox"/> hand-held <input type="checkbox"/> transportable <input type="checkbox"/> stationary <input type="checkbox"/> for building-in <input type="checkbox"/> direct plug-in <input type="checkbox"/> rack-mounting <input checked="" type="checkbox"/> wall-mounted
Over voltage category (OVC)	<input type="checkbox"/> OVC I <input checked="" type="checkbox"/> OVC II <input type="checkbox"/> OVC III <input type="checkbox"/> OVC IV <input type="checkbox"/> other: _____
Class of equipment	<input checked="" type="checkbox"/> Class I <input type="checkbox"/> Class II <input type="checkbox"/> Class III
Access location	<input type="checkbox"/> restricted access location <input checked="" type="checkbox"/> N/A
Pollution degree (PD)	<input type="checkbox"/> PD 1 <input checked="" type="checkbox"/> PD 2 <input type="checkbox"/> PD 3
Manufacturer's specified maximum operating ambient:	40°C
IP protection class	<input checked="" type="checkbox"/> IPX0 <input type="checkbox"/> IP ____
Power Systems	<input checked="" type="checkbox"/> TN <input type="checkbox"/> TT <input type="checkbox"/> IT - ____ V _{L-L}
Altitude during operation (m)	<input type="checkbox"/> 2000 m or less <input checked="" type="checkbox"/> <u>5000</u> m
Altitude of test laboratory (m)	<input checked="" type="checkbox"/> 2000 m or less <input type="checkbox"/> ____ m
Mass of equipment (kg)	For 23.6 inch model: 4.47kg (with base stand type A); For 23.8 inch model: 4.47kg (with base stand type A); For 27.0 inch model: 6.15kg (with base stand type A); For base stand type A: approx. 1.51kg; For base stand type B: approx. 1.35kg;

POSSIBLE TEST CASE VERDICTS:	
- test case does not apply to the test object..... :	N/A
- test object does meet the requirement :	P (Pass)
- test object does not meet the requirement :	F (Fail)
TESTING:	
Date of receipt of test item..... :	Jul.10, 2020
Date (s) of performance of tests..... :	Jul.10, 2020 - Jul.25, 2020
GENERAL REMARKS:	
<p>"(See Enclosure #)" refers to additional information appended to the report. "(See appended table)" refers to a table appended to the report.</p> <p>Throughout this report a <input type="checkbox"/> comma / <input checked="" type="checkbox"/> point is used as the decimal separator.</p>	
Manufacturer's Declaration per sub-clause 4.2.5 of IEC62368-1:	
The application for obtaining a CB Test Certificate includes more than one factory location and a declaration from the Manufacturer stating that the sample(s) submitted for evaluation is (are) representative of the products from each factory has been provided	<input checked="" type="checkbox"/> Yes <input type="checkbox"/> Not applicable
When differences exist; they shall be identified in the General product information section.	

Name and address of factory (ies) :	
	1 TPV Display Technology (Wuhan) Co., Ltd Unique No.11 Zhuankou Development District of Economic Technological Development Zone , 430056 Wuhan City, P. R. China
	2 TPV Electronics (Fujian) Co., Ltd. Shangzheng, Yuan Hong Road Fuqing City, Fujian, P.R.China
	3 L&T Display Technology (Fujian) Ltd Optoelectronic Park, Rongqiao Economic and Technological Development Zone Fuqing, 350301 Fujian, P.R. China
	4 TPV Electronics (Fujian) Co., Ltd. Rongqiao Economic and Technological Development Zone Fuqing City, Fujian, P.R.China
	5 TPV Display Technology (Beihai) Co.,Ltd. China Electronic Beihai Industry Park, Northeast of the Crossing between Taiwan Road and Jilin Road, Beihai City, Guangxi, P.R.China
	6 TPV Display Technology (China) Co., Ltd No.106 Jinghai 3 Rd., BDA, 100176 Beijing, P. R. China
	7 Trend Smart CE Mexico S de RL de CV Avenida Sor Juana Ines de la Cruz de 19602 Nueva Tijuana, 22435 Tijuana Baja California, MEXICO
	8 TPV Technology(Qingdao) Co.,Ltd. NO.99 Huoju Road, High-tech Industrial Development Zone, Qingdao City, Shandong, P. R. China
	9 Envision Indústria de Produtos Eletrônicos Ltda. Av. Torquato Tapajós, 2236, Flores - CEP 69058-830 - Manaus/AM Brasil
	10 Pro Concept Manufacturer Co., Ltd. 88/1 Moo 12, Soi Phetkasem 120, Phetkasem Road, Omnoi, Krathumbaen, Samutsakhon 74130, Thailand
	11 TPV Technology (Thailand) Co., Ltd. No.267 Mu7, Tha Tum Sub- District, Si Maha Pho District,Prachin Buri Province, Thailand
	12 TPV Electronics (Fujian) Co., Ltd. Optoelectronic Park, Rongqiao Economic and Technological Development Zone, Fuqing City, 350301, Fujian, P. R. China
	13 GeneTouch Corp. No. 9 Neixi Rd., Luzhu Dist., Taoyuan City, 33852 Taiwan

GENERAL PRODUCT INFORMATION:**Product Description –**

The models are LCD monitor for using within the scope of this standard and have following features:

1. LCD panel: 23.6 inch, 23.8 inch, 27.0 inch TFT LCD with LED backlight;
2. Building-in type switching power supply board 715G9611;
3. Building-in main board 715G9584, 715GB201, 715GA740 supplied by power board secondary output for 23.6 inch and 23.8 inch models;
4. Building-in main board 715G9584, 715G9500, 715GA531 supplied by power board secondary output for 27.0 inch models;
5. Output USB port and AUDIO port on main board are optional;
6. The internal metal chassis is considered as fire enclosure and mechanical enclosure, and the external plastic enclosure is regarded as electrical enclosure and mechanical enclosure, made of min. HB material;
7. Base stand (optional use), made of metal and min. HB plastic material;
8. Maximum declared ambient: 40°C;
9. Unless specification, model 27G1 with USB board and AUDIO port was chosen to performance all tests;

Model Differences –

All models are identical except for type designation and panel size.

See below table for differences among the models:

Model name	Power board	Main board	USB board (optional)	Metal enclosure	Base stand	Panel
24G1*****, C24G1*****, C*24G1*****, Q24G1*****, U24G1*****, 24G2*****, C24G2*****, C*24G2*****, Q24G2*****, U24G2*****	715G9611	715G9584 715GB201	715GA629	Type A	Type A	Curved
27G1*****, C27G1*****, C*27G1*****, Q27G1*****, U27G1*****, 27G2*****, C27G2*****, C*27G2*****, Q27G2*****, U27G2*****		715G9584 715GA740		Type B	Type A, Type B	Flat
		715G9584, 715G9500 715GA531		Type A	Type A	Curved
		715G9584, 715GA531		Type B	Type A, Type B	Flat

Definition of variable(s):

Variable:	Range of variable:	Content:
*	0-9, A-Z, a-z, -, \, /, + or blank	represent different enclosure colour for marketing purpose

Additional application considerations – (Considerations used to test a component or sub-assembly) –

N/A

ENERGY SOURCE IDENTIFICATION AND CLASSIFICATION TABLE:	
(Note 1: Identify the following six (6) energy source forms based on the origin of the energy.) (Note 2: The identified classification e.g., ES2, TS1, should be with respect to its ability to cause pain or injury on the body or its ability to ignite a combustible material. Any energy source can be declared Class 3 as a worse case classification e.g. PS3, ES3.)	
Electrically-caused injury (Clause 5): (Note: Identify type of source, list sub-assembly or circuit designation and corresponding energy source classification) Example: +5 V dc input	
	ES1
Source of electrical energy	Corresponding classification (ES)
All Primary circuits	ES3
All secondary output of SPS	ES1
Plastic/Metal Enclosure	ES1
Electrically-caused fire (Clause 6): (Note: List sub-assembly or circuit designation and corresponding energy source classification) Example: Battery pack (maximum 85 watts):	
	PS2
Source of power or PIS	Corresponding classification (PS)
Building-in power board circuit	PS3
+19Vout output of power board	PS2
Injury caused by hazardous substances (Clause 7) (Note: Specify hazardous chemicals, whether produces ozone or other chemical construction not addressed as part of the component evaluation.) Example: Liquid in filled component	
	Glycol
Source of hazardous substances	Corresponding chemical
N/A	N/A
Mechanically-caused injury (Clause 8) (Note: List moving part(s), fan, special installations, etc. & corresponding MS classification based on Table 35.) Example: Wall mount unit	
	MS2
Source of kinetic/mechanical energy	Corresponding classification (MS)
Sharp edges and corners	MS1
Equipment mass	MS1
Wall mount	MS3
Thermal burn injury (Clause 9) (Note: Identify the surface or support, and corresponding energy source classification based on type of part, location, operating temperature and contact time in Table 38.) Example: Hand-held scanner – thermoplastic enclosure	
	TS1
Source of thermal energy	Corresponding classification (TS)
Accessible parts	TS1
Radiation (Clause 10) (Note: List the types of radiation present in the product and the corresponding energy source classification.) Example: DVD – Class 1 Laser Product	
	RS1
Type of radiation	Corresponding classification (RS)
Indicating lights	RS1
LED backlight of LCD panel	RS1

ENERGY SOURCE DIAGRAM

Indicate which energy sources are included in the energy source diagram. Insert diagram below

See "Source of electrical energy" and "Source of power or PIS" on previous page for details

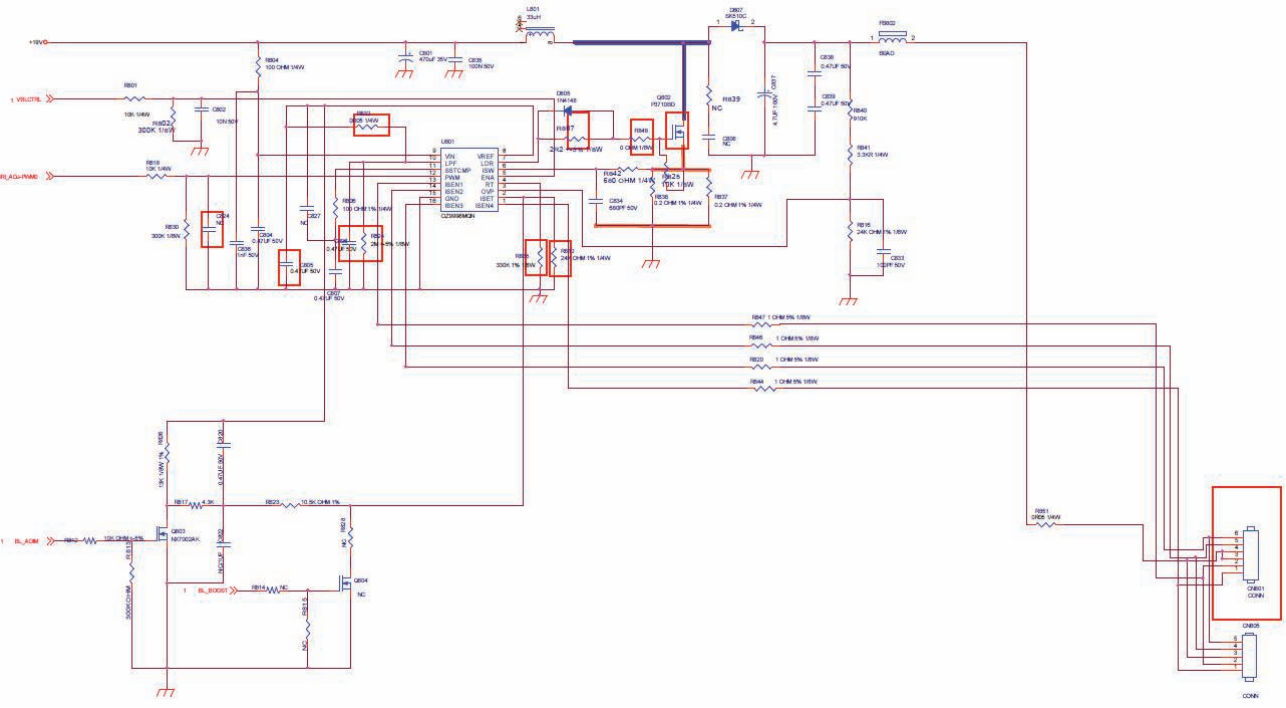
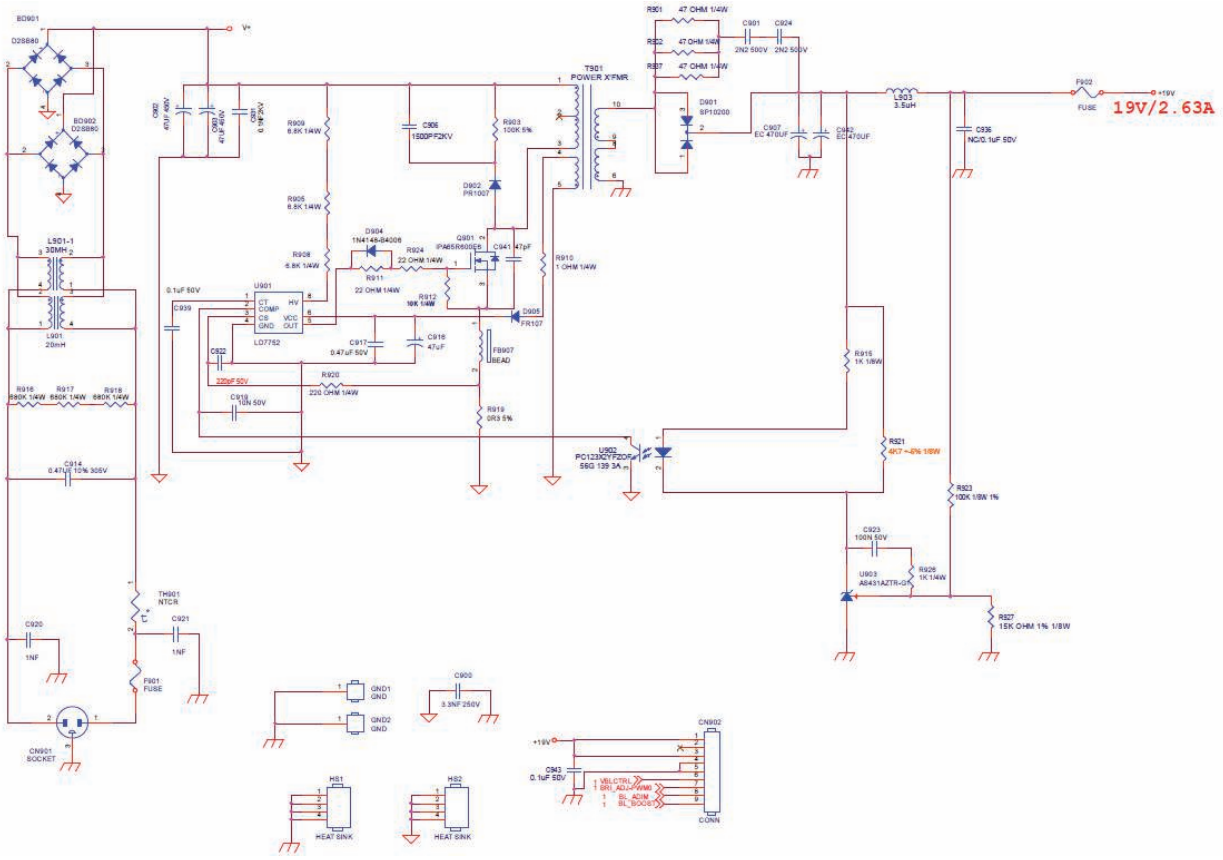

☒ ES ☒ PS □ MS □ TS □ RS

OVERVIEW OF EMPLOYED SAFEGUARDS				
Clause	Possible Hazard			
5.1	Electrically-caused injury			
Body Part (e.g. Ordinary)	Energy Source (ES3: Primary Filter circuit)	Safeguards		
		Basic	Supplementa ry	Reinforced (Enclosure)
Ordinary	ES3: L/N pin of appliance inlet (after disconnection of mains)	N/A	N/A	Bleeder Resistors
Ordinary	ES3: Primary circuit	N/A	N/A	Transformer, Opto coupler, Y-capacitor Enclosure
Ordinary	ES1: +19Vout outputs of power board	N/A	N/A	N/A
Ordinary	ES1: Plastic/Metal enclosure	N/A	N/A	N/A
6.1	Electrically-caused fire			
Material part (e.g. mouse enclosure)	Energy Source (PS2: 100 Watt circuit)	Safeguards		
		Basic	Supplementa ry	Reinforced
Combustible materials within equipment fire enclosure	PS3: > 100 Watt circuit (Primary circuits)	No ignition occurs	see sub-clause 6.4.5, 6.4.6 for detail	N/A
	PS2: < 100 Watt circuit (Secondary circuits)		see sub-clause 6.4.5 for detail	N/A
Internal wiring material	PS2: < 100 Watt circuit (Secondary circuits)	No ignition occurs	see sub-clause 6.5. for detail	N/A
7.1	Injury caused by hazardous substances			
Body Part (e.g., skilled)	Energy Source (hazardous material)	Safeguards		
		Basic	Supplementa ry	Reinforced
N/A	N/A	N/A	N/A	N/A
8.1	Mechanically-caused injury			
Body Part (e.g. Ordinary)	Energy Source (MS3:High Pressure Lamp)	Safeguards		
		Basic	Supplementa ry	Reinforced (Enclosure)
Ordinary	MS1: Edges and corners	N/A	N/A	N/A
Ordinary	MS1: Equipment mass	N/A	N/A	N/A
Ordinary	MS3: Wall mount	N/A	N/A	Compliance with test 8.7.2
9.1	Thermal Burn			
Body Part (e.g., Ordinary)	Energy Source (TS2)	Safeguards		
		Basic	Supplementa	Reinforced

			ry	
Ordinary	TS1: Accessible parts	N/A	N/A	N/A
10.1	Radiation			
Body Part (e.g., Ordinary)	Energy Source (Output from audio port)	Safeguards		
		Basic	Supplementa ry	Reinforced
Ordinary	RS1: Indicating lights	N/A	N/A	N/A
Ordinary	RS1: LED backlight of LCD panel	N/A	N/A	N/A
Supplementary Information: (1) See attached energy source diagram for additional details. (2) "N" – Normal Condition; "A" – Abnormal Condition; "S" Single Fault				

IEC 62368-1			
Clause	Requirement + Test	Result - Remark	Verdict
4	GENERAL REQUIREMENTS		P
4.1.1	Acceptance of materials, components and subassemblies	See appended table 4.1.2.	P
4.1.2	Use of components	Components which are certified to IEC and/or national standards are used correctly within their ratings. Components not covered by IEC standards are tested under the conditions present in the equipment.	P
4.1.3	Equipment design and construction	No accessible part which could cause injury.	P
4.1.15	Markings and instructions.....:	(See Annex F)	P
4.4.4	Safeguard robustness	For adhesives securing parts serving as safeguards, see Annex P.4. Others see below.	P
4.4.4.2	Steady force tests.....:	(See Annex T.4, T.5)	P
4.4.4.3	Drop tests.....:	(See Annex T.7)	N/A
4.4.4.4	Impact tests.....:	(See Annex T.6)	P
4.4.4.5	Internal accessible safeguard enclosure and barrier tests.....:	(See Annex T.3)	P
4.4.4.6	Glass Impact tests.....:	Laminated glass used.	N/A
4.4.4.7	Thermoplastic material tests.....:	Phenolic material used and described in subclauses 5.4.1.10 to 5.4.1.10.3. 70°C, 7 hours, no deformation on all sources of plastic enclosure.	P
4.4.4.8	Air comprising a safeguard.....:	(See Annex T)	P
4.4.4.9	Accessibility and safeguard effectiveness	No damage. The class 3 and class 2 energy sources could not become accessible to an ordinary person, and all other safeguards remain effective during and after above tests.	P
4.5	Explosion	No explosion occurs during normal/abnormal operation and single fault conditions.	P
4.6	Fixing of conductors	See below.	P
4.6.1	Fix conductors not to defeat a safeguard		P
4.6.2	10 N force test applied to.....:	See appended table 5.4.2.2, 5.4.2.4 and 5.4.3	P
4.7	Equipment for direct insertion into mains socket - outlets		N/A
4.7.2	Mains plug part complies with the relevant standard.....:		N/A

IEC 62368-1			
Clause	Requirement + Test	Result - Remark	Verdict
4.7.3	Torque (Nm)		N/A
4.8	Products containing coin/button cell batteries	No lithium coin/button batteries used.	N/A
4.8.2	Instructional safeguard		N/A
4.8.3	Battery Compartment Construction		N/A
	Means to reduce the possibility of children removing the battery		—
4.8.4	Battery Compartment Mechanical Tests		N/A
4.8.5	Battery Accessibility		N/A
4.9	Likelihood of fire or shock due to entry of conductive object	(See Annex P)	P

5	ELECTRICALLY-CAUSED INJURY		P
5.2.1	Electrical energy source classifications	See ENERGY SOURCE IDENTIFICATION AND CLASSIFICATION TABLE.	P
5.2.2	ES1, ES2 and ES3 limits	See below.	P
5.2.2.2	Steady-state voltage and current	(See appended table 5.2)	P
5.2.2.3	Capacitance limits	(See appended table 5.2)	P
5.2.2.4	Single pulse limits	(See appended table 5.2)	N/A
5.2.2.5	Limits for repetitive pulses	(See appended table 5.2)	N/A
5.2.2.6	Ringling signals	(See Annex H)	N/A
5.2.2.7	Audio signals	(See Clause E.1)	N/A
5.3	Protection against electrical energy sources	See below.	P
5.3.1	General Requirements for accessible parts to ordinary, instructed and skilled persons	See "OVERVIEW OF EMPLOYED SAFEGUARDS" table.	P
5.3.2.1	Accessibility to electrical energy sources and safeguards	ES2 or ES3 source cannot access by ordinary persons and ES3 source cannot accessed by instructed persons. Double or reinforced safeguard is provided between ES2 or ES3 and ordinary persons or instructed persons.	P
5.3.2.2	Contact requirements	See above.	P
	a) Test with test probe from Annex V	Test probe V.1, V.2 applied.	P
	b) Electric strength test potential (V)		N/A
	c) Air gap (mm)	Complied with the minimum distance requirement. (See appended table 5.4.2.2, 5.4.2.4 and 5.4.3.)	P
5.3.2.4	Terminals for connecting stripped wire	No such terminals.	N/A
5.4	Insulation materials and requirements		P

IEC 62368-1			
Clause	Requirement + Test	Result - Remark	Verdict
5.4.1.2	Properties of insulating material	Hygroscopic materials are not used for insulating material.	P
5.4.1.3	Humidity conditioning	(See sub-clause 5.4.8)	P
5.4.1.4	Maximum operating temperature for insulating materials	(See appended table 5.4.1.4)	P
5.4.1.5	Pollution degree	Pollution degree 2.	—
5.4.1.5.2	Test for pollution degree 1 environment and for an insulating compound		N/A
5.4.1.5.3	Thermal cycling		N/A
5.4.1.6	Insulation in transformers with varying dimensions		N/A
5.4.1.7	Insulation in circuits generating starting pulses		N/A
5.4.1.8	Determination of working voltage	Max. V _{peak} of T901 = 610V Max. V _{rms} of T901 = 337V	P
5.4.1.9	Insulating surfaces	Considered.	P
5.4.1.10	Thermoplastic parts on which conductive metallic parts are directly mounted	Bobbin materials of transformer T901 and chokes are Phenolic that is accepted without further tests. Others see appended table 5.4.1.10.3.	P
5.4.1.10.2	Vicat softening temperature	(See appended table 5.4.1.10.2)	N/A
5.4.1.10.3	Ball pressure	(See appended table 5.4.1.10.3)	P
5.4.2	Clearances	See below.	P
5.4.2.2	Determining clearance using peak working voltage	(See appended table 5.4.2.2, 5.4.2.4 and 5.4.3)	P
5.4.2.3	Determining clearance using required withstand voltage	(See appended table 5.4.2.3)	P
	a) a.c. mains transient voltage	2500V	—
	b) d.c. mains transient voltage	--	—
	c) external circuit transient voltage	--	—
	d) transient voltage determined by measurement ... :	--	—
5.4.2.4	Determining the adequacy of a clearance using an electric strength test		N/A
5.4.2.5	Multiplication factors for clearances and test voltages	Multiplication factor is 1.48 for altitude up to 5000m.	P
5.4.3	Creepage distances	(See appended table 5.4.2.2, 5.4.2.4 and 5.4.3)	P
5.4.3.1	General	See below.	P
5.4.3.3	Material Group	Material group IIIb assumed.	—
5.4.4	Solid insulation	See below.	P
5.4.4.2	Minimum distance through insulation	(See appended table 5.4.4.2)	P
5.4.4.3	Insulation compound forming solid insulation		N/A

IEC 62368-1			
Clause	Requirement + Test	Result - Remark	Verdict
5.4.4.4	Solid insulation in semiconductor devices	Complies with Clause G.12.	P
5.4.4.5	Cemented joints		N/A
5.4.4.6	Thin sheet material	See below.	P
5.4.4.6.1	General requirements	See below.	P
5.4.4.6.2	Separable thin sheet material	(See appended Table 5.4.9)	P
	Number of layers (pcs)	2	P
5.4.4.6.3	Non-separable thin sheet material		N/A
5.4.4.6.4	Standard test procedure for non-separable thin sheet material		N/A
5.4.4.6.5	Mandrel test		N/A
5.4.4.7	Solid insulation in wound components		N/A
5.4.4.9	Solid insulation at frequencies >30 kHz	(See appended Table 5.4.9) or (See appended Table 5.4.9)	P
5.4.5	Antenna terminal insulation		N/A
5.4.5.1	General		N/A
5.4.5.2	Voltage surge test		N/A
	Insulation resistance (MΩ).....		—
5.4.6	Insulation of internal wire as part of supplementary safeguard		N/A
5.4.7	Tests for semiconductor components and for cemented joints		N/A
5.4.8	Humidity conditioning	Complied.	P
	Relative humidity (%).....	95	—
	Temperature (°C)	40	—
	Duration (h)	120	—
5.4.9	Electric strength test	(See appended table 5.4.9)	P
5.4.9.1	Test procedure for a solid insulation type test	(See appended table 5.4.9)	P
5.4.9.2	Test procedure for routine tests		N/A
5.4.10	Protection against transient voltages between external circuit	No such external circuit subject to transients.	N/A
5.4.10.1	Parts and circuits separated from external circuits	(See appended table 5.4.9)	N/A
5.4.10.2	Test methods		N/A
5.4.10.2.1	General		N/A
5.4.10.2.2	Impulse test	(See appended table 5.4.9)	N/A
5.4.10.2.3	Steady-state test.....	(See appended table 5.4.9)	N/A
5.4.11	Insulation between external circuits and earthed circuitry	(See appended table 5.4.9)	N/A
5.4.11.1	Exceptions to separation between external circuits and earth		N/A

IEC 62368-1			
Clause	Requirement + Test	Result - Remark	Verdict
5.4.11.2	Requirements		N/A
	Rated operating voltage U_{op} (V).....:		—
	Nominal voltage U_{peak} (V).....:		—
	Max increase due to variation U_{sp}		—
	Max increase due to ageing ΔU_{sa}		—
	$U_{op} = U_{peak} + \Delta U_{sp} + \Delta U_{sa}$		—
5.5	Components as safeguards		P
5.5.1	General		P
5.5.2	Capacitors and RC units		P
5.5.2.1	General requirement	X-Cap. and Y-Cap. are IEC 60384-14 approval components and complied with Annex G.11.	P
5.5.2.2	Safeguards against capacitor discharge after disconnection of a connector.....:	(See appended table 5.5.2.2)	P
5.5.3	Transformers	(See Annex G.5.3)	P
5.5.4	Optocouplers	(See sub-clause 5.4)	P
5.5.5	Relays	(See Annex G.2)	N/A
5.5.6	Resistors	Approved bleeding resistors used. (See Annex G.10)	P
5.5.7	SPD's	(See Annex G.8)	N/A
5.5.7.1	Use of an SPD connected to reliable earthing		N/A
5.5.7.2	Use of an SPD between mains and protective earth		N/A
5.5.8	Insulation between the mains and external circuit consisting of a coaxial cable.....:		N/A
5.6	Protective conductor		P
5.6.2	Requirement for protective conductors	Protective conductor served as a supplementary safeguard to prevent accessible conductive parts from exceeding ES2 limits.	P
5.6.2.1	General requirements	No switch or overcurrent protective device in protective conductor.	P
5.6.2.2	Colour of insulation	No insulation used for protective bonding conductor	N/A
5.6.3	Requirement for protective earthing conductors	Appliance inlet used. No power cord provided.	N/A
	Protective earthing conductor size (mm ²)		—
5.6.4	Requirement for protective bonding conductors	See below.	P
5.6.4.1	Protective bonding conductors	Protective bonding traces complied with 5.6.6 and Annex R.	P
	Protective bonding conductor size (mm ²)......:	See above.	—
	Protective current rating (A)	20A	—

IEC 62368-1			
Clause	Requirement + Test	Result - Remark	Verdict
5.6.4.3	Current limiting and overcurrent protective devices	No current limiting and overcurrent protective devices in parallel with any other components.	N/A
5.6.5	Terminals for protective conductors	See below.	P
5.6.5.1	Requirement	Screws fixing earthed PCB trace to metal chassis for protective bonding. Size of screws is according with Table 32.	P
	Conductor size (mm ²), nominal thread diameter (mm).....:	3.7 mm	P
5.6.5.2	Corrosion	Complied.	P
5.6.6	Resistance of the protective system	See below.	P
5.6.6.1	Requirements	See below.	P
5.6.6.2	Test Method Resistance (Ω).....:	(See appended table 5.6.6.2)	P
5.6.7	Reliable earthing		N/A
5.7	Prospective touch voltage, touch current and protective conductor current		P
5.7.2	Measuring devices and networks	Figure 5 of IEC 60990 was used in determining of the limit of ES2.	P
5.7.2.1	Measurement of touch current.....:	(See appended table 5.7.2.2, 5.7.4)	P
5.7.2.2	Measurement of prospective touch voltage	(See appended table 5.7.2.2, 5.7.4)	P
5.7.3	Equipment set-up, supply connections and earth connections	Clause 4, 5.3 and 5.4 of IEC 60990: 1999 applied.	P
	System of interconnected equipment (separate connections/single connection).....:	Single equipment.	—
	Multiple connections to mains (one connection at a time/simultaneous connections).....:	Single connection.	—
5.7.4	Earthed conductive accessible parts.....:	(See appended Table 5.7.4)	P
5.7.5	Protective conductor current	Protective conductor current does not exceed the ES2 limits.	N/A
	Supply Voltage (V).....:		—
	Measured current (mA).....:		—
	Instructional Safeguard.....:	(See F.4 and F.5)	N/A
5.7.6	Prospective touch voltage and touch current due to external circuits		N/A
5.7.6.1	Touch current from coaxial cables		N/A
5.7.6.2	Prospective touch voltage and touch current from external circuits		N/A
5.7.7	Summation of touch currents from external circuits		N/A
	a) Equipment with earthed external circuits Measured current (mA).....:		N/A
	b) Equipment whose external circuits are not referenced to earth. Measured current (mA).....:		N/A

IEC 62368-1			
Clause	Requirement + Test	Result - Remark	Verdict
6	ELECTRICALLY- CAUSED FIRE		P
6.2	Classification of power sources (PS) and potential ignition sources (PIS)		P
6.2.2	Power source circuit classifications	See ENERGY SOURCE IDENTIFICATION AND CLASSIFICATION TABLE.	P
6.2.2.1	General		P
6.2.2.2	Power measurement for worst-case load fault ... :	(See appended table 6.2.2)	P
6.2.2.3	Power measurement for worst-case power source fault	(See appended table 6.2.2)	P
6.2.2.4	PS1	(See appended table 6.2.2)	N/A
6.2.2.5	PS2	(See appended table 6.2.2)	P
6.2.2.6	PS3	(See appended table 6.2.2)	P
6.2.3	Classification of potential ignition sources		P
6.2.3.1	Arcing PIS	(See appended table 6.2.3.1)	P
6.2.3.2	Resistive PIS	(See appended table 6.2.3.2)	P
6.3	Safeguards against fire under normal operating and abnormal operating conditions		P
6.3.1 (a)	No ignition and attainable temperature value less than 90 % defined by ISO 871 or less than 300 °C for unknown materials	(See appended table 5.4.1.5, 6.3.2, 9.0, B.2.6)	P
6.3.1 (b)	Combustible materials outside fire enclosure	(See appended table 5.4.1.5, 6.3.2, 9.0, B.2.6)	P
6.4	Safeguards against fire under single fault conditions		P
6.4.1	Safeguard Method	The method "Control fire spread" is selected.	P
6.4.2	Reduction of the likelihood of ignition under single fault conditions in PS1 circuits		N/A
6.4.3	Reduction of the likelihood of ignition under single fault conditions in PS2 and PS3 circuits		N/A
6.4.3.1	General		N/A
6.4.3.2	Supplementary Safeguards		N/A
	Special conditions if conductors on printed boards are opened or peeled		N/A
6.4.3.3	Single Fault Conditions		N/A
	Special conditions for temperature limited by fuse		N/A
6.4.4	Control of fire spread in PS1 circuits		N/A
6.4.5	Control of fire spread in PS2 circuits	See below.	P

IEC 62368-1			
Clause	Requirement + Test	Result - Remark	Verdict
6.4.5.2	Supplementary safeguards	Compliance detailed as follows: <ul style="list-style-type: none"> - <u>Printed board</u>: rated min. V-1 - <u>Wire insulation and tubing</u>: complying with Clause 6.5 - <u>All other components</u>: at least V-2 except for mounted on min. V-1 material or small parts of combustible material or components complying to relevant IEC standard. - <u>Isolating transformer</u>: complying with G.5.3. (See appended tables 4.1.2 and Annex G)	P
6.4.6	Control of fire spread in PS3 circuit	Compliance detailed as follows: <ul style="list-style-type: none"> - Parts as in 6.4.5 above - No components subject to arcing - Fire enclosure provided –see 6.4.8. Other parts within the fire enclosure are min. V-2 or better.	P
6.4.7	Separation of combustible materials from a PIS		N/A
6.4.7.1	General.....	(See tables 6.2.3.1 and 6.2.3.2)	N/A
6.4.7.2	Separation by distance		N/A
6.4.7.3	Separation by a fire barrier		N/A
6.4.8	Fire enclosures and fire barriers	Metal enclosure used as fire enclosure.	P
6.4.8.1	Fire enclosure and fire barrier material properties	As above.	P
6.4.8.2.1	Requirements for a fire barrier		N/A
6.4.8.2.2	Requirements for a fire enclosure	As above.	P
6.4.8.3	Constructional requirements for a fire enclosure and a fire barrier		P
6.4.8.3.1	Fire enclosure and fire barrier openings	See below.	P
6.4.8.3.2	Fire barrier dimensions		N/A
6.4.8.3.3	Top Openings in Fire Enclosure: dimensions (mm)	See attachment: Measurement Section for the details.	P
	Needle Flame test		N/A
6.4.8.3.4	Bottom Openings in Fire Enclosure, condition met a), b) and/or c) dimensions (mm)	See attachment: Measurement Section for the details.	P
	Flammability tests for the bottom of a fire enclosure		N/A
6.4.8.3.5	Integrity of the fire enclosure, condition met: a), b) or c)	No door or cover in fire enclosure	N/A
6.4.8.4	Separation of PIS from fire enclosure and fire barrier distance (mm) or flammability rating	Metal enclosure used as fire enclosure.	P

IEC 62368-1			
Clause	Requirement + Test	Result - Remark	Verdict
6.5	Internal and external wiring		P
6.5.1	Requirements	All wiring fulfil VW-1 requirement, which was considered compliance equivalent to IEC/TS 60695-11-21.	P
6.5.2	Cross-sectional area (mm ²)	See above.	—
6.5.3	Requirements for interconnection to building wiring	(See Annex Q.)	N/A
6.6	Safeguards against fire due to connection to additional equipment	All power delivering output connectors complied with Annex Q.1	P
	External port limited to PS2 or complies with Clause Q.1	See above.	P

7	INJURY CAUSED BY HAZARDOUS SUBSTANCES		N/A
7.2	Reduction of exposure to hazardous substances	No hazardous chemicals within the equipment.	N/A
7.3	Ozone exposure	No ozone production within the equipment.	N/A
7.4	Use of personal safeguards (PPE)		N/A
	Personal safeguards and instructions		—
7.5	Use of instructional safeguards and instructions		N/A
	Instructional safeguard (ISO 7010)		—
7.6	Batteries.....	(See Annex M)	N/A

8	MECHANICALLY-CAUSED INJURY		P
8.1	General		P
8.2	Mechanical energy source classifications	See ENERGY SOURCE IDENTIFICATION AND CLASSIFICATION TABLE.	P
8.3	Safeguards against mechanical energy sources	See "OVERVIEW OF EMPLOYED SAFEGUARDS" table.	P
8.4	Safeguards against parts with sharp edges and corners	No sharp edges and corners in accessible area.	P
8.4.1	Safeguards		N/A
8.5	Safeguards against moving parts		N/A
8.5.1	MS2 or MS3 part required to be accessible for the function of the equipment		N/A
8.5.2	Instructional Safeguard.....		—
8.5.4	Special categories of equipment comprising moving parts		N/A
8.5.4.1	Large data storage equipment		N/A

IEC 62368-1			
Clause	Requirement + Test	Result - Remark	Verdict
8.5.4.2	Equipment having electromechanical device for destruction of media		N/A
8.5.4.2.1	Safeguards and Safety Interlocks	(See Annex F.4 and Annex K)	N/A
8.5.4.2.2	Instructional safeguards against moving parts		N/A
	Instructional Safeguard		—
8.5.4.2.3	Disconnection from the supply		N/A
8.5.4.2.4	Probe type and force (N)		N/A
8.5.5	High Pressure Lamps		N/A
8.5.5.1	Energy Source Classification		N/A
8.5.5.2	High Pressure Lamp Explosion Test.....	(See appended table 8.5.5.2)	N/A
8.6	Stability	See below	P
8.6.1	Product classification	See Clause 8.2 & 8.3	P
	Instructional Safeguard		—
8.6.2	Static stability	MS1 equipment.	P
8.6.2.2	Static stability test	Test was conducted by client's request. Unit did not fall over when tilted to an angle of 10° from its normal upright position.	P
	Applied Force	See above.	—
8.6.2.3	Downward Force Test	Not floor standing equipment.	N/A
8.6.3	Relocation stability test		N/A
	Unit configuration during 10° tilt.....		—
8.6.4	Glass slide test		N/A
8.6.5	Horizontal force test (Applied Force).....		N/A
	Position of feet or movable parts	See above.	—
8.7	Equipment mounted to wall or ceiling		P
8.7.1	Mounting Means (Length of screws (mm) and mounting surface)	Not specified wall mounting bracket. Four screws M4 x 10mm used for fixing.	P
8.7.2	Direction and applied force	Test 2: 62N applied for each point (four directions plus inward and outward). Test 3: 1.2Nm applied.	P
8.8	Handles strength	No handles.	N/A
8.8.1	Classification		N/A
8.8.2	Applied Force		N/A
8.9	Wheels or casters attachment requirements		N/A
8.9.1	Classification		N/A
8.9.2	Applied force		—
8.10	Carts, stands and similar carriers		N/A

IEC 62368-1			
Clause	Requirement + Test	Result - Remark	Verdict
8.10.1	General		N/A
8.10.2	Marking and instructions		N/A
	Instructional Safeguard.....:		—
8.10.3	Cart, stand or carrier loading test and compliance		N/A
	Applied force		—
8.10.4	Cart, stand or carrier impact test		N/A
8.10.5	Mechanical stability		N/A
	Applied horizontal force (N).....:		—
8.10.6	Thermoplastic temperature stability (°C).....:		N/A
8.11	Mounting means for rack mounted equipment		N/A
8.11.1	General		N/A
8.11.2	Product Classification		N/A
8.11.3	Mechanical strength test, variable <i>N</i>		N/A
8.11.4	Mechanical strength test 250N, including end stops		N/A
8.12	Telescoping or rod antennas.....	(See Annex T)	N/A
	Button/Ball diameter (mm).....:		—

9	THERMAL BURN INJURY		P
9.2	Thermal energy source classifications	See ENERGY SOURCE IDENTIFICATION AND CLASSIFICATION TABLE.	P
9.3	Safeguard against thermal energy sources	No safeguards are required for TS1.	N/A
9.4	Requirements for safeguards		N/A
9.4.1	Equipment safeguard		N/A
9.4.2	Instructional safeguard		N/A

10	RADIATION		P
10.2	Radiation energy source classification	See below.	P
10.2.1	General classification	The following parts are considered as RS1 without tests: - Indicating lights; - LED backlight of LCD panel	P
10.3	Protection against laser radiation		N/A
	Laser radiation that exists equipment:		—
	Normal, abnormal, single-fault.....:		N/A
	Instructional safeguard		—
	Tool.....:		—
10.4	Protection against visible, infrared, and UV		N/A

IEC 62368-1			
Clause	Requirement + Test	Result - Remark	Verdict
	radiation		
10.4.1	General		N/A
10.4.1.a)	RS3 for Ordinary and instructed persons		N/A
10.4.1.b)	RS3 accessible to a skilled person.....		N/A
	Personal safeguard (PPE) instructional safeguard.....		—
10.4.1.c)	Equipment visible, IR, UV does not exceed RS1. . :		N/A
10.4.1.d)	Normal, abnormal, single-fault conditions	(See appended table B.3 & B.4)	N/A
10.4.1.e)	Enclosure material employed as safeguard is opaque.....		N/A
10.4.1.f)	UV attenuation.....		N/A
10.4.1.g)	Materials resistant to degradation UV		N/A
10.4.1.h)	Enclosure containment of optical radiation.....		N/A
10.4.1.i)	Exempt Group under normal operating conditions.....		N/A
10.4.2	Instructional safeguard		N/A
10.5	Protection against x-radiation		N/A
10.5.1	X- radiation energy source that exists equipment :	(See appended table B.3 & B.4)	N/A
	Normal, abnormal, single fault conditions		N/A
	Equipment safeguards.....		N/A
	Instructional safeguard for skilled person..... :		N/A
10.5.3	Most unfavourable supply voltage to give maximum radiation		—
	Abnormal and single-fault condition	(See appended table B.3 & B.4)	N/A
	Maximum radiation (pA/kg).....		N/A
10.6	Protection against acoustic energy sources		N/A
10.6.1	General		N/A
10.6.2	Classification		N/A
	Acoustic output, dB(A)..... :		N/A
	Output voltage, unweighted r.m.s..... :		N/A
10.6.4	Protection of persons		N/A
	Instructional safeguards		N/A
	Equipment safeguard prevent ordinary person to RS2..... :		—
	Means to actively inform user of increase sound pressure..... :		—
	Equipment safeguard prevent ordinary person to RS2..... :		—
10.6.5	Requirements for listening devices (headphones, earphones, etc.)		N/A

IEC 62368-1			
Clause	Requirement + Test	Result - Remark	Verdict
10.6.5.1	Corded passive listening devices with analog input		N/A
	Input voltage with 94 dB(A) L_{Aeq} acoustic pressure output..... :		—
10.6.5.2	Corded listening devices with digital input		N/A
	Maximum dB(A)..... :		—
10.6.5.3	Cordless listening device		N/A
	Maximum dB(A)..... :		—

B	NORMAL OPERATING CONDITION TESTS, ABNORMAL OPERATING CONDITION TESTS AND SINGLE FAULT CONDITION TESTS		P
B.2	Normal Operating Conditions	See below	P
B.2.1	General requirements..... :	(See Test Item Particulars and appended test tables)	P
	Audio Amplifiers and equipment with audio amplifiers	(See Annex E)	N/A
B.2.3	Supply voltage and tolerances	Considered	P
B.2.5	Input test..... :	(See appended table B.2.5)	P
B.3	Simulated abnormal operating conditions		P
B.3.1	General requirements..... :	(See appended table B.3)	P
B.3.2	Covering of ventilation openings	(See appended table B.3)	P
B.3.3	D.C. mains polarity test		N/A
B.3.4	Setting of voltage selector		N/A
B.3.5	Maximum load at output terminals	(See appended table B.3)	P
B.3.6	Reverse battery polarity		N/A
B.3.7	Abnormal operating conditions as specified in Clause E.2.	(See appended table B.3)	P
B.3.8	Safeguards functional during and after abnormal operating conditions	Abnormal operating condition does not lead to a single fault condition, all safeguards remain effective. After restoration of normal operating conditions, all safeguards comply with applicable requirements.	P
B.4	Simulated single fault conditions		P
B.4.2	Temperature controlling device open or short-circuited	No such devices.	N/A
B.4.3	Motor tests		N/A
B.4.3.1	Motor blocked or rotor locked increasing the internal ambient temperature		N/A

IEC 62368-1			
Clause	Requirement + Test	Result - Remark	Verdict
B.4.4	Short circuit of functional insulation	For traces before fuse, comply with the clearance/creepage for basic insulation, others are considered to perform short-circuited during the tests. See appended Table B.4	P
B.4.4.1	Short circuit of clearances for functional insulation	See above.	P
B.4.4.2	Short circuit of creepage distances for functional insulation	See above.	P
B.4.4.3	Short circuit of functional insulation on coated printed boards		N/A
B.4.5	Short circuit and interruption of electrodes in tubes and semiconductors	See appended Table B.4	P
B.4.6	Short circuit or disconnect of passive components	See appended Table B.4	P
B.4.7	Continuous operation of components		N/A
B.4.8	Class 1 and Class 2 energy sources within limits during and after single fault conditions	See appended Table B.4	P
B.4.9	Battery charging under single fault conditions ... :	(See Annex M)	N/A
C	UV RADIATION		N/A
C.1	Protection of materials in equipment from UV radiation		N/A
C.1.2	Requirements		N/A
C.1.3	Test method		N/A
C.2	UV light conditioning test		N/A
C.2.1	Test apparatus		N/A
C.2.2	Mounting of test samples		N/A
C.2.3	Carbon-arc light-exposure apparatus		N/A
C.2.4	Xenon-arc light exposure apparatus		N/A
D	TEST GENERATORS		N/A
D.1	Impulse test generators		N/A
D.2	Antenna interface test generator		N/A
D.3	Electronic pulse generator		N/A
E	TEST CONDITIONS FOR EQUIPMENT CONTAINING AUDIO AMPLIFIERS		N/A
E.1	Audio amplifier normal operating conditions	No such equipment.	N/A
	Audio signal voltage (V)		—
	Rated load impedance (Ω)		—
E.2	Audio amplifier abnormal operating conditions		N/A
F	EQUIPMENT MARKINGS, INSTRUCTIONS, AND INSTRUCTIONAL SAFEGUARDS		P
F.1	General requirements	See below.	P
	Instructions – Language	English. The instructions in other languages will be provided during the national approval.	—

IEC 62368-1			
Clause	Requirement + Test	Result - Remark	Verdict
F.2	Letter symbols and graphical symbols		P
F.2.1	Letter symbols according to IEC60027-1		P
F.2.2	Graphic symbols IEC, ISO or manufacturer specific	Graphical symbols are complied with IEC 60417, ISO 3864-2, ISO 7000 or ISO 7010.	P
F.3	Equipment markings		P
F.3.1	Equipment marking locations	The equipment marking is provided and is readily visible in operator access area.	P
F.3.2	Equipment identification markings	See below.	P
F.3.2.1	Manufacturer identification	See copy of marking plate.	—
F.3.2.2	Model identification	See copy of marking plate.	—
F.3.3	Equipment rating markings	See below.	P
F.3.3.1	Equipment with direct connection to mains	The equipment is connected to AC mains supply.	P
F.3.3.2	Equipment without direct connection to mains		N/A
F.3.3.3	Nature of supply voltage.....	See copy of marking plate.	—
F.3.3.4	Rated voltage	See copy of marking plate.	—
F.3.3.4	Rated frequency	See copy of marking plate.	—
F.3.3.6	Rated current or rated power	See copy of marking plate.	—
F.3.3.7	Equipment with multiple supply connections	Only one supply connection.	N/A
F.3.4	Voltage setting device	No such devices within the equipment.	N/A
F.3.5	Terminals and operating devices	See below.	P
F.3.5.1	Mains appliance outlet and socket-outlet markings.....		N/A
F.3.5.2	Switch position identification marking		N/A
F.3.5.3	Replacement fuse identification and rating markings.....	The fuse is located within the equipment and not replaceable by an ordinary person or an instructed person. The fuse marking is marked on PCB near fuse: F901 (on primary): T4AL/250Vac F902 (on secondary) T4AL/250Vac	P
F.3.5.4	Replacement battery identification marking		N/A
F.3.5.5	Terminal marking location		P
F.3.6	Equipment markings related to equipment classification		P

IEC 62368-1			
Clause	Requirement + Test	Result - Remark	Verdict
F.3.6.1	Class I Equipment	See below.	P
F.3.6.1.1	Protective earthing conductor terminal	Appliance inlet is provided. The symbol IEC 60417-5019 was located on appliance inlet.	P
F.3.6.1.2	Neutral conductor terminal		N/A
F.3.6.1.3	Protective bonding conductor terminals		N/A
F.3.6.2	Class II equipment (IEC60417-5172)		N/A
F.3.6.2.1	Class II equipment with or without functional earth		N/A
F.3.6.2.2	Class II equipment with functional earth terminal marking		N/A
F.3.7	Equipment IP rating marking		—
F.3.8	External power supply output marking		N/A
F.3.9	Durability, legibility and permanence of marking	See below.	P
F.3.10	Test for permanence of markings	The marking plate was subjected to the permanence of marking test. The marking plate was rubbed with cloth soaked with water for 15 s and then again for 15 s with the cloth soaked with petroleum spirit. After each test, there was no damage to the marking plate. The marking on the label did not fade. There was no curling of the marking plate and removed by hand.	P
F.4	Instructions		P
	a) Equipment for use in locations where children not likely to be present - marking		N/A
	b) Instructions given for installation or initial use	Provided in user's manual.	P
	c) Equipment intended to be fastened in place		N/A
	d) Equipment intended for use only in restricted access area		N/A
	e) Audio equipment terminals classified as ES3 and other equipment with terminals marked in accordance F.3.6.1		N/A
	f) Protective earthing employed as safeguard	The instruction is provided in the user's manual.	P
	g) Protective earthing conductor current exceeding ES2 limits	Not exceed the ES2 limits.	N/A
	h) Symbols used on equipment	Graphical symbols not used as an instructional safeguard.	N/A
	i) Permanently connected equipment not provided with all-pole mains switch		N/A
j)	j) Replaceable components or modules providing safeguard function		N/A

IEC 62368-1			
Clause	Requirement + Test	Result - Remark	Verdict
F.5	Instructional safeguards	No instructional safeguard required.	N/A
	Where "instructional safeguard" is referenced in the test report it specifies the required elements, location of marking and/or instruction		N/A
G	COMPONENTS		P
G.1	Switches		N/A
G.1.1	General requirements		N/A
G.1.2	Ratings, endurance, spacing, maximum load		N/A
G.2	Relays		N/A
G.2.1	General requirements		N/A
G.2.2	Overload test		N/A
G.2.3	Relay controlling connectors supply power		N/A
G.2.4	Mains relay, modified as stated in G.2		N/A
G.3	Protection Devices		P
G.3.1	Thermal cut-offs		N/A
G.3.1.1a) &b)	Thermal cut-outs separately approved according to IEC 60730 with conditions indicated in a) & b)		N/A
G.3.1.1c)	Thermal cut-outs tested as part of the equipment as indicated in c)		N/A
G.3.1.2	Thermal cut-off connections maintained and secure		N/A
G.3.2	Thermal links		N/A
G.3.2.1a)	Thermal links separately tested with IEC 60691		N/A
G.3.2.1b)	Thermal links tested as part of the equipment		N/A
	Aging hours (H)		—
	Single Fault Condition		—
	Test Voltage (V) and Insulation Resistance (Ω) . :		—
G.3.3	PTC Thermistors		N/A
G.3.4	Overcurrent protection devices	Current fuse complying with IEC 60127 as overcurrent protection device.	P
G.3.5	Safeguards components not mentioned in G.3.1 to G.3.5		N/A
G.3.5.1	Non-resettable devices suitably rated and marking provided		N/A
G.3.5.2	Single faults conditions.....	(See appended Table B.4)	N/A
G.4	Connectors		P
G.4.1	Spacings	The appliance inlet complied with IEC 60320-1.	P
G.4.2	Mains connector configuration	The appliance inlet complied with IEC 60320-1.	P

IEC 62368-1			
Clause	Requirement + Test	Result - Remark	Verdict
G.4.3	Plug is shaped that insertion into mains socket-outlets or appliance coupler is unlikely	No misconnection likely.	P
G.5	Wound Components		P
G.5.1	Wire insulation in wound components.....	(See Annex J)	P
G.5.1.2 a)	Two wires in contact inside wound component, angle between 45° and 90°	Physical separation provided by insulation tape or tube to relieve mechanical stress at the crossover point.	P
G.5.1.2 b)	Construction subject to routine testing		N/A
G.5.2	Endurance test on wound components		N/A
G.5.2.1	General test requirements		N/A
G.5.2.2	Heat run test		N/A
	Time (s)		—
	Temperature (°C)		—
G.5.2.3	Wound Components supplied by mains		N/A
G.5.3	Transformers		P
G.5.3.1	Requirements applied (IEC61204-7, IEC61558-1/-2, and/or IEC62368-1).....	Meet the requirements in G.5.3.2 and G.5.3.3.	P
	Position.....	T901	—
	Method of protection	Overcurrent protection.	—
G.5.3.2	Insulation	See attachment Transformer table.	P
	Protection from displacement of windings.....	Displacement of windings is unlikely.	—
G.5.3.3	Overload test	(See appended table B.3 & B.4)	P
G.5.3.3.1	Test conditions	Tested in the complete equipment.	P
G.5.3.3.2	Winding Temperatures testing in the unit	(See appended table B.3 & B.4)	P
G.5.3.3.3	Winding Temperatures - Alternative test method		N/A
G.5.4	Motors		N/A
G.5.4.1	General requirements		N/A
	Position		—
G.5.4.2	Test conditions		N/A
G.5.4.3	Running overload test		N/A
G.5.4.4	Locked-rotor overload test		N/A
	Test duration (days)		—
G.5.4.5	Running overload test for d.c. motors in secondary circuits		N/A
G.5.4.5.2	Tested in the unit		N/A
	Electric strength test (V)		—
G.5.4.5.3	Tested on the Bench - Alternative test method; test time (h)		N/A

IEC 62368-1			
Clause	Requirement + Test	Result - Remark	Verdict
	Electric strength test (V)		—
G.5.4.6	Locked-rotor overload test for d.c. motors in secondary circuits		N/A
G.5.4.6.2	Tested in the unit		N/A
	Maximum Temperature		N/A
	Electric strength test (V)		N/A
G.5.4.6.3	Tested on the bench - Alternative test method; test time (h)		N/A
	Electric strength test (V)		N/A
G.5.4.7	Motors with capacitors		N/A
G.5.4.8	Three-phase motors		N/A
G.5.4.9	Series motors		N/A
	Operating voltage		—
G.6	Wire Insulation		P
G.6.1	General		P
G.6.2	Solvent-based enamel wiring insulation		N/A
G.7	Mains supply cords		N/A
G.7.1	General requirements	No mains supply cord provided.	N/A
	Type.....		—
	Rated current (A).....		—
	Cross-sectional area (mm ²), (AWG).....		—
G.7.2	Compliance and test method		N/A
G.7.3	Cord anchorages and strain relief for non-detachable power supply cords		N/A
G.7.3.2	Cord strain relief		N/A
G.7.3.2.1	Requirements		N/A
	Strain relief test force (N)		—
G.7.3.2.2	Strain relief mechanism failure		N/A
G.7.3.2.3	Cord sheath or jacket position, distance (mm)....		—
G.7.3.2.4	Strain relief comprised of polymeric material		N/A
G.7.4	Cord Entry	(See appended table 5.4.11.1)	N/A
G.7.5	Non-detachable cord bend protection		N/A
G.7.5.1	Requirements		N/A
G.7.5.2	Mass (g)		—
	Diameter (m)		—
	Temperature (°C)		—
G.7.6	Supply wiring space		N/A
G.7.6.2	Stranded wire		N/A

IEC 62368-1			
Clause	Requirement + Test	Result - Remark	Verdict
G.7.6.2.1	Test with 8 mm strand		N/A
G.8	Varistors		N/A
G.8.1	General requirements		N/A
G.8.2	Safeguard against shock		N/A
G.8.3	Safeguard against fire		N/A
G.8.3.2	Varistor overload test	(See appended table B.3)	N/A
G.8.3.3	Temporary overvoltage	(See appended table B.3)	N/A
G.9	Integrated Circuit (IC) Current Limiters		N/A
G.9.1 a)	Manufacturer defines limit at max. 5A.		N/A
G.9.1 b)	Limiters do not have manual operator or reset		N/A
G.9.1 c)	Supply source does not exceed 250 VA		—
G.9.1 d)	IC limiter output current (max. 5A)		—
G.9.1 e)	Manufacturers' defined drift		—
G.9.2	Test Program 1		N/A
G.9.3	Test Program 2		N/A
G.9.4	Test Program 3		N/A
G.10	Resistors		P
G.10.1	General requirements	Approved bleeding resistors used. (See appended table 4.1.2)	P
G.10.2	Resistor test		N/A
G.10.3	Test for resistors serving as safeguards between the mains and an external circuit consisting of a coaxial cable		N/A
G.10.3.1	General requirements		N/A
G.10.3.2	Voltage surge test		N/A
G.10.3.3	Impulse test		N/A
G.11	Capacitor and RC units		P
G.11.1	General requirements	X-Capacitors and Y-Capacitors used as safeguard and complied with IEC/EN 60384-14. (See appended table 4.1.2)	P
G.11.2	Conditioning of capacitors and RC units	At least 21 days at $40 \pm 2^\circ\text{C}$ and $93 \pm 3\%$ RH.	P
G.11.3	Rules for selecting capacitors	The selection followed with tables G.9 and G.12.	P
G.12	Optocouplers		P
	Optocouplers comply with IEC 60747-5-5:2007 Spacing or Electric Strength Test (specify option and test results).....	The optocouplers used in the equipment are complied with the requirements of IEC 60747-5-5. (see appended table 4.1.2)	P
	Type test voltage V_{ini}	See above.	—

IEC 62368-1			
Clause	Requirement + Test	Result - Remark	Verdict
	Routine test voltage, Vini,b	See above.	—
G.13	Printed boards		P
G.13.1	General requirements	See below.	P
G.13.2	Uncoated printed boards	(see appended table 5.4.2.2, 5.4.2.4 and 5.4.3)	P
G.13.3	Coated printed boards		N/A
G.13.4	Insulation between conductors on the same inner surface		N/A
	Compliance with cemented joint requirements (Specify construction)		—
G.13.5	Insulation between conductors on different surfaces		N/A
	Distance through insulation		N/A
	Number of insulation layers (pcs)		—
G.13.6	Tests on coated printed boards		N/A
G.13.6.1	Sample preparation and preliminary inspection		N/A
G.13.6.2a)	Thermal conditioning		N/A
G.13.6.2b)	Electric strength test		N/A
G.13.6.2c)	Abrasion resistance test		N/A
G.14	Coating on components terminals		N/A
G.14.1	Requirements	(See G.13)	N/A
G.15	Liquid filled components		N/A
G.15.1	General requirements		N/A
G.15.2	Requirements		N/A
G.15.3	Compliance and test methods		N/A
G.15.3.1	Hydrostatic pressure test		N/A
G.15.3.2	Creep resistance test		N/A
G.15.3.3	Tubing and fittings compatibility test		N/A
G.15.3.4	Vibration test		N/A
G.15.3.5	Thermal cycling test		N/A
G.15.3.6	Force test		N/A
G.15.4	Compliance		N/A
G.16	IC including capacitor discharge function (ICX)		N/A
a)	Humidity treatment in accordance with sc5.4.8 – 120 hours		N/A
b)	Impulse test using circuit 2 with Uc = to transient voltage		N/A
C1)	Application of ac voltage at 110% of rated voltage for 2.5 minutes		N/A

IEC 62368-1			
Clause	Requirement + Test	Result - Remark	Verdict
C2)	Test voltage		—
D1)	10,000 cycles on and off using capacitor with smallest capacitance resistor with largest resistance specified by manufacturer		N/A
D2)	Capacitance		—
D3)	Resistance		—
H	CRITERIA FOR TELEPHONE RINGING SIGNALS		N/A
H.1	General		N/A
H.2	Method A		N/A
H.3	Method B		N/A
H.3.1	Ringling signal		N/A
H.3.1.1	Frequency (Hz)		—
H.3.1.2	Voltage (V)		—
H.3.1.3	Cadence; time (s) and voltage (V)		—
H.3.1.4	Single fault current (mA):.....		—
H.3.2	Tripping device and monitoring voltage		N/A
H.3.2.1	Conditions for use of a tripping device or a monitoring voltage complied with		N/A
H.3.2.2	Tripping device		N/A
H.3.2.3	Monitoring voltage (V)		—
J	INSULATED WINDING WIRES FOR USE WITHOUT INTERLEAVED INSULATION		P
	General requirements	Approved triple insulated wire used for main transformer.	P
K	SAFETY INTERLOCKS		N/A
K.1	General requirements		N/A
K.2	Components of safety interlock safeguard mechanism		N/A
K.3	Inadvertent change of operating mode		N/A
K.4	Interlock safeguard override		N/A
K.5	Fail-safe		N/A
	Compliance		N/A
K.6	Mechanically operated safety interlocks		N/A
K.6.1	Endurance requirement		N/A
K.6.2	Compliance and Test method		N/A
K.7	Interlock circuit isolation		N/A
K.7.1	Separation distance for contact gaps & interlock circuit elements (type and circuit location)		N/A
K.7.2	Overload test, Current (A)		N/A
K.7.3	Endurance test		N/A

IEC 62368-1			
Clause	Requirement + Test	Result - Remark	Verdict
K.7.4	Electric strength test		N/A
L	DISCONNECT DEVICES		P
L.1	General requirements	Appliance Inlet as disconnect device.	P
L.2	Permanently connected equipment		N/A
L.3	Parts that remain energized	When the power cord is disconnected from the inlet no remaining parts with hazardous voltage in the equipment.	P
L.4	Single phase equipment	The device disconnects both poles simultaneously.	P
L.5	Three-phase equipment		N/A
L.6	Switches as disconnect devices		N/A
L.7	Plugs as disconnect devices		N/A
L.8	Multiple power sources		N/A
M	EQUIPMENT CONTAINING BATTERIES AND THEIR PROTECTION CIRCUITS		N/A
M.1	General requirements		N/A
M.2	Safety of batteries and their cells		N/A
M.2.1	Requirements		N/A
M.2.2	Compliance and test method (identify method) .. :		N/A
M.3	Protection circuits		N/A
M.3.1	Requirements		N/A
M.3.2	Tests		N/A
	- Overcharging of a rechargeable battery		N/A
	- Unintentional charging of a non-rechargeable battery		N/A
	- Reverse charging of a rechargeable battery		N/A
	- Excessive discharging rate for any battery		N/A
M.3.3	Compliance		N/A
M.4	Additional safeguards for equipment containing secondary lithium battery		N/A
M.4.1	General		N/A
M.4.2	Charging safeguards		N/A
M.4.2.1	Charging operating limits		N/A
M.4.2.2a)	Charging voltage, current and temperature		—
M.4.2.2 b)	Single faults in charging circuitry		—
M.4.3	Fire Enclosure		N/A
M.4.4	Endurance of equipment containing a secondary lithium battery		N/A
M.4.4.2	Preparation		N/A

IEC 62368-1			
Clause	Requirement + Test	Result - Remark	Verdict
M.4.4.3	Drop and charge/discharge function tests		N/A
	Drop		N/A
	Charge		N/A
	Discharge		N/A
M.4.4.4	Charge-discharge cycle test		N/A
M.4.4.5	Result of charge-discharge cycle test		N/A
M.5	Risk of burn due to short circuit during carrying		N/A
M.5.1	Requirement		N/A
M.5.2	Compliance and Test Method (Test of P.2.3)		N/A
M.6	Prevention of short circuits and protection from other effects of electric current		N/A
M.6.1	Short circuits		N/A
M.6.1.1	General requirements		N/A
M.6.1.2	Test method to simulate an internal fault		N/A
M.6.1.3	Compliance (Specify M.6.1.2 or alternative method)		N/A
M.6.2	Leakage current (mA)		N/A
M.7	Risk of explosion from lead acid and NiCd batteries		N/A
M.7.1	Ventilation preventing explosive gas concentration		N/A
M.7.2	Compliance and test method		N/A
M.8	Protection against internal ignition from external spark sources of lead acid batteries		N/A
M.8.1	General requirements		N/A
M.8.2	Test method		N/A
M.8.2.1	General requirements		N/A
M.8.2.2	Estimation of hypothetical volume V_z (m ³ /s).....		—
M.8.2.3	Correction factors		—
M.8.2.4	Calculation of distance d (mm)		—
M.9	Preventing electrolyte spillage		N/A
M.9.1	Protection from electrolyte spillage		N/A
M.9.2	Tray for preventing electrolyte spillage		N/A
M.10	Instructions to prevent reasonably foreseeable misuse (Determination of compliance: inspection, data review; or abnormal testing)		N/A
N	ELECTROCHEMICAL POTENTIALS		P
	Metal(s) used	Complied.	—

IEC 62368-1			
Clause	Requirement + Test	Result - Remark	Verdict
O	MEASUREMENT OF CREEPAGE DISTANCES AND CLEARANCES		P
	Figures O.1 to O.20 of this Annex applied	Considered	—
P	SAFEGUARDS AGAINST ENTRY OF FOREIGN OBJECTS AND SPILLAGE OF INTERNAL LIQUIDS		P
P.1	General requirements	See below.	P
P.2.2	Safeguards against entry of foreign object	External plastic enclosure and internal metal enclosure used.	P
	Location and Dimensions (mm)	See attachment: Measurement Section for the details.	—
P.2.3	Safeguard against the consequences of entry of foreign object	See above.	P
P.2.3.1	Safeguards against the entry of a foreign object		P
	Openings in transportable equipment		N/A
	Transportable equipment with metalized plastic parts		N/A
P.2.3.2	Openings in transportable equipment in relation to metallized parts of a barrier or enclosure (identification of supplementary safeguard)		N/A
P.3	Safeguards against spillage of internal liquids		N/A
P.3.1	General requirements		N/A
P.3.2	Determination of spillage consequences		N/A
P.3.3	Spillage safeguards		N/A
P.3.4	Safeguards effectiveness		N/A
P.4	Metallized coatings and adhesive securing parts		N/A
P.4.2 a)	Conditioning testing		N/A
	Tc (°C).....		—
	Tr (°C)		—
	Ta (°C).....		—
P.4.2 b)	Abrasion testing		N/A
P.4.2 c)	Mechanical strength testing		N/A
Q	CIRCUITS INTENDED FOR INTERCONNECTION WITH BUILDING WIRING		P
Q.1	Limited power sources		P
Q.1.1 a)	Inherently limited output	(See appended table Annex Q.1)	P
Q.1.1 b)	Impedance limited output		N/A
	- Regulating network limited output under normal operating and simulated single fault condition	(See appended table Annex Q.1)	P
Q.1.1 c)	Overcurrent protective device limited output	(See appended table Annex Q.1)	P
Q.1.1 d)	IC current limiter complying with G.9		N/A
Q.1.2	Compliance and test method	(See appended table Annex Q.1)	P
Q.2	Test for external circuits – paired conductor cable		N/A

IEC 62368-1			
Clause	Requirement + Test	Result - Remark	Verdict
	Maximum output current (A)		—
	Current limiting method		—
R	LIMITED SHORT CIRCUIT TEST		P
R.1	General requirements	Test for protective bonding conductor between earthing pin of appliance inlet and earthing pin of C902, C903.	P
R.2	Determination of the overcurrent protective device and circuit	20A circuit breaker is used.	P
R.3	Test method Supply voltage (V) and short-circuit current (A).	240V, 1500A	P
S	TESTS FOR RESISTANCE TO HEAT AND FIRE		P
S.1	Flammability test for fire enclosures and fire barrier materials of equipment where the steady state power does not exceed 4 000 W		N/A
	Samples, material		—
	Wall thickness (mm).....		—
	Conditioning (°C).....		—
	Test flame according to IEC 60695-11-5 with conditions as set out		N/A
	- Material not consumed completely		N/A
	- Material extinguishes within 30s		N/A
	- No burning of layer or wrapping tissue		N/A
S.2	Flammability test for fire enclosure and fire barrier integrity		N/A
	Samples, material		—
	Wall thickness (mm).....		—
	Conditioning (°C).....		—
	Test flame according to IEC 60695-11-5 with conditions as set out		N/A
	Test specimen does not show any additional hole		N/A
S.3	Flammability test for the bottom of a fire enclosure		N/A
	Samples, material		—
	Wall thickness (mm).....		—
	Cheesecloth did not ignite		N/A
S.4	Flammability classification of materials	See table 4.1.2 for detail	P
S.5	Flammability test for fire enclosures and fire barrier materials of equipment where the steady state power does not exceed 4 000 W		N/A
	Samples, material		—

IEC 62368-1			
Clause	Requirement + Test	Result - Remark	Verdict
	Wall thickness (mm).....:		—
	Conditioning (test condition), (°C).....:		—
	Test flame according to IEC 60695-11-20 with conditions as set out		N/A
	After every test specimen was not consumed completely		N/A
	After fifth flame application, flame extinguished within 1 min		N/A
T	MECHANICAL STRENGTH TESTS		P
T.1	General requirements	See the following details.	P
T.2	Steady force test, 10 N	(See appended table T.2)	P
T.3	Steady force test, 30 N	(See appended table T.3)	P
T.4	Steady force test, 100 N	(See appended table T.4)	N/A
T.5	Steady force test, 250 N	(See appended table T.5)	P
T.6	Enclosure impact test	(See appended table T.6)	P
	Fall test		P
	Swing test		P
T.7	Drop test	(See appended table T.7)	N/A
T.8	Stress relief test	(See appended table T.8)	P
T.9	Impact Test (glass)		N/A
T.9.1	General requirements		N/A
T.9.2	Impact test and compliance		N/A
	Impact energy (J).....:		—
	Height (m)		—
T.10	Glass fragmentation test	(See sub-clause 4.4.4.9)	N/A
T.11	Test for telescoping or rod antennas		N/A
	Torque value (Nm)		—
U	MECHANICAL STRENGTH OF CATHODE RAY TUBES (CRT) AND PROTECTION AGAINST THE EFFECTS OF IMPLOSION		N/A
U.1	General requirements		N/A
U.2	Compliance and test method for non-intrinsically protected CRTs		N/A
U.3	Protective Screen.....:		N/A
V	DETERMINATION OF ACCESSIBLE PARTS (FINGERS, PROBES AND WEDGES)		P
V.1	Accessible parts of equipment		P
V.2	Accessible part criterion		P

IEC 62368-1			
Clause	Requirement + Test	Result - Remark	Verdict

4.1.2 TABLE: List of critical components					
Object / part No.	Manufacturer/ trademark	Type / model	Technical data	Standard	Mark(s) of conformity ¹
LCD Panel with LED backlight (for 23.6 inch model)	TPV	TPM236*** (*can be 0-9, A- Z or blank for marketing purpose).	23.6 inch TFT curve panel (power consumption: 27.1W; LED array voltage: 60V)	--	Tested in equipment
LCD Panel with LED backlight (for 23.8 inch models)	TPV	TPM238*** (*can be 0-9, A-Z or blank for marketing purpose).	23.8 inch TFT curve panel (power consumption: 16.5W; LED array voltage: 54V)	--	Tested in equipment
LCD Panel with LED backlight (for 27.0 inch model)	TPV	TPM270*** (*can be 0-9, A-Z or blank for marketing purpose).	27.0 inch TFT curve panel (power consumption: 29.49W; LED array voltage: 44.8V)	--	Tested in equipment

IEC 62368-1					
Clause	Requirement + Test		Result - Remark		Verdict
Plastic enclosure	LOTTE ADVANCED MATERIALS CO LTD (SAMSUNG SDI) (Cheil)	SD-0150(+), VH-0810(+), VE-0812(+), NH-1000T(+)(&), GC- 0700(+++)(RR2 8), GC-0700A(RR), GC- 0750(+)(RR70), GC- 1017(+)(RR30), VE-1890(+), BF-0675(+), BF-0670(+), NH-1017(p), NH-1017T, NH-1017SG(+), BF-0677(+), HS-7000(+), HG-0760(+), NE-1030(+), HR-1360(+), LX-0951(+), LX-0957(+), TH-1100(+), TN-1100(+)	HB or better, min. 1.6mm thickness	UL 94	UL E115797 and tested with appliance
(Alternative)	GRAND PACIFIC PETROCHEMIC AL CORP	D-150, D-1000, D-1000A	HB or better, min. 1.6mm thickness	UL 94	UL E88637 and tested with appliance
(Alternative)	CHI MEI CORPORATION	PA-757(+), PH-88, PA-756S	HB or better, min. 1.6mm thickness	UL 94	UL E56070 and tested with appliance
(Alternative)	ALBIS PLASTIC GMBH	GP-35, GP-22, 495F	HB or better, min. 1.6mm thickness	UL 94	UL E80168 and tested with appliance
(Alternative)	COVESTRO DEUTSCHLAND AG [PC RESINS] (Bayer)	FR3000 series, FR3005 series	HB or better, min. 1.6mm thickness	UL 94	UL E41613 and tested with appliance

IEC 62368-1					
Clause	Requirement + Test			Result - Remark	Verdict
(Alternative)	LG CHEM LTD	HF350(#), HF380(m), HF380NS, HF380(#), HF-380(#), HF-380(m), HF-380, HF-380NS, HF380X, AF312T1, AF342T1, LUPOY GN- 5001TF(#), GN-5001RFD, LUPOY GN- 5008HF(#), LUPOY GP- 5008BF(#), SE750(#), XG568(#), XG569(#), GP-1000L, GP-1000F(#), SE750(#), LUPOY GN- 5001RF(T)	HB or better, min. 1.6mm thickness	UL 94	UL E67171 and tested with appliance

IEC 62368-1					
Clause	Requirement + Test		Result - Remark		Verdict
(Alternative)	KINGFA SCI & TECH CO LTD	4418, 5197, FRABS-518, HIPS-5197, HF-606, HF-626, FRABS-518, GAR-011C, JH960 6(M), FRHIPS-960, RS-900, RS-300, RS-400, GAR-011, GAR-011(L65), GAR-011(L85), GAR-011(HG6), CK-100, CK-900, CK-55111, JH960 6(M), FRHIPS-960, HIPS-4418, HIPS-3399, HIPS-CM(ee), HIPS-HG(ee), HIPS-510 (o), HIPS-550, CK-61(M) (##), RS-(hh)0, HP-126, ABS-660, ABS-122, GAR-322, GAR-332, GAR-220, H12, G360, CK-55(M) (##), CK-58(M) (##), GAR-011C, GAR-011(ww)	HB or better, min. 1.6mm thickness	UL 94	UL E171666 and tested with appliance
(Alternative)	QINGDAO HAIER NEW MATERIAL R & D CO LTD	HRABS-RS, HRABS-HG, CR-3002	HB or better, min. 1.6mm thickness	UL 94	UL E230779 and tested with appliance
(Alternative)	DONGGUAN HINGLONG PLASTIC TECHNOLOGY CO LTD	HL-ABS-PCR85, HL-ABS-PCR65, HL-ABS-PCR35	HB or better, min. 1.6mm thickness	UL 94	UL E345434 and tested with appliance
(Alternative)	ORINKO (HEFEI) ADVANCED PLASTIC CO LTD	ABS-3070H, HIPS-2000	HB or better, min. 1.6mm thickness	UL 94	UL E328304 and tested with appliance

IEC 62368-1					
Clause	Requirement + Test		Result - Remark		Verdict
(Alternative)	WISTRON ADVANCED MATERIALS (KUNSHAN) CO LTD	GA(M)(b)(c)	HB or better, min. 1.6mm thickness	UL 94	UL E359575 and tested with appliance
(Alternative)	UNIC TECHNOLOGY CORP	UR- 3006+(RXX), UR-200+	HB or better, min. 1.6mm thickness	UL 94	UL E135175 and tested with appliance
(Alternative)	GUO HENG (DONGGUAN)	YOUHO(#####)(Y)	HB or better, min. 1.6mm thickness	UL 94	UL E471190 and tested with appliance
(Alternative)	HUIZHOU WOTE	2100	HB or better, min. 1.6mm thickness	UL 94	UL E310240 and tested with appliance
(Alternative)	TEIJIN LIMITED RESIN AND PLASTIC	TN-7500(c), TN-7500F(#), MN-3600V(#), MN-3600H(#)	HB or better, min. 1.6mm thickness	UL 94	UL E98529 and tested with appliance
(Alternative)	INEOS STYROLUTION GROUP GMBH	495F GR2, 495F KG2, 495F GR21, 495F KG21, PC2065, GP-22	HB or better, min. 1.6mm thickness	UL 94	UL E108538 and tested with appliance
(Alternative)	TRINSEO EUROPE GMBH (STYRON)	STYRON A- TECH 1200	HB or better, min. 1.6mm thickness	UL 94	UL E162447 and tested with appliance
(Alternative)	TOTAL PETROCHEMIC ALS SOUTH EAST ASIA PTE LTD	3441; 260-XX	HB or better, min. 1.6mm thickness	UL 94	UL E314268 and tested with appliance
(Alternative)	DOOSAN CORPORATION ELECTRO- MATERIALS BG	DS-1107A; DS-1202G; DS-7106	HB or better, min. 1.6mm thickness	UL 94	UL E103670 and tested with appliance
(Alternative)	SABIC JAPAN L L C	C6600(GG)(X)(VS), C6600E (VS)(X)	HB or better, min. 1.6mm thickness	UL 94	UL E207780 and tested with appliance
(Alternative)	PONTEX	AFE5000N, AFE5100N, 9004BK	HB or better, min. 1.6mm thickness	UL 94	UL E205938 and tested with appliance

IEC 62368-1					
Clause	Requirement + Test			Result - Remark	Verdict
(Alternative)	CHI LIN	GA-1(aaa), GA-1535	HB or better, min. 1.6mm thickness	UL 94	UL E177071 and tested with appliance
Mylar sheet	SUZHOU OMAI OPTICAL MATERIALS CO LTD	SE42B, SE42B-F	min. 0.4mm thickness, min. V-1, 105°C	UL 94	UL E249605
(Alternative)	SICHUAN LONGHUA FILM CO LTD	PC-770F, PC-770F-A, PC-770	min. 0.4mm thickness, min. V-1, 105°C	UL 94	UL E254551
(Alternative)	SICHUAN DONGFANG INSULATING MATERIAL CO LTD	DFR700, DFR700F, DFR700-83, DFR700-83A, DFR700-83B	min. 0.4mm thickness, min. V-1, 105°C	UL 94	UL E199019
(Alternative)	CHENGDU KANGLONGXIN PLASTICS CO LTD	KLX FRPC- 1860B, KLX FRPC- 1870B	min. 0.4mm thickness, min. V-1, 105°C	UL 94	UL E315185
(Alternative)	CHENGDU KANGLONGXIN PLASTICS CO LTD	KLX FRPC- 870B	min. 0.4mm thickness, min. V-1, 105°C	UL 94	UL E315185
(Alternative)	CHENGDU KANGLONGXIN PLASTICS CO LTD	DFPET 6023	min. 0.4mm thickness, min. V-1, 105°C	UL 94	UL E199019
(Alternative)	SICHUAN DONGFANG INSULATING MATERIAL CO LTD	DFR117ECOC, DFR117ECOB	min. 0.4mm thickness, min. V-1, 105°C	UL 94	UL E199019
(Alternative)	SICHUAN DONGFANG INSULATING MATERIAL CO LTD	DFR117ECO	min. 0.4mm thickness, min. V-1, 105°C	UL 94	UL E199019
(Alternative)	JINGMEN GORUN TECHNOLOGY CO LTD	HF70	min. 0.4mm thickness, min. V-1, 105°C	UL 94	UL E305163

IEC 62368-1					
Clause	Requirement + Test			Result - Remark	Verdict
(Alternative)	SICHUAN DONGFANG INSULATING MATERIAL CO LTD	DFR3A(d)	min. 0.4mm thickness, min. V-1, 105°C	UL 94	UL E199019
(Alternative)	CHENGDU KANGLONGXIN PLASTICS CO LTD	KLX PP BK-10	min. 0.4mm thickness, min. V-1, 105°C	UL 94	UL E315185
(Alternative)	KUNSHAN DOBESTY OPTOELECTRONIC MATERIALS CO LTD	PC9842B, PC9821B, PC9832B	min. 0.4mm thickness, min. V-1, 105°C	UL 94	UL E339070
(Alternative)	SHENZHEN TEESUN TECHNOLOGY CO LTD	FR370, FR370F, FE383	min. 0.4mm thickness, min. V-1, 105°C	UL 94	UL E329660
Base stand (optional)	Interchangeable	Interchangeable	HB or better	UL 94	UL
PCB	Interchangeable	Interchangeable	V-1 or better, min. 105°C	UL 94	UL
Metal enclosure	Interchangeable	Interchangeable	Metal thickness: min. 0.81mm	--	--
Switching mode power supply board: 715G9611 by TPV					
AC Inlet (CN901)	Solteam	ST-01, SC04	10A, 250Vac	IEC/ EN 60320-1 UL60320-1	VDE, UL
(Alternative)	Zhang Jia Gang-Hua Jie	SA-4S, SA-4S-1, SA-4D SA-4S 7 SA-4S 9	10A, 250Vac	IEC/ EN 60320-1 UL60320-1	VDE, UL
(Alternative)	Rong Feng	SS-120, SS-7B	10A, 250Vac	IEC/ EN 60320-1 UL60320-1	VDE, UL
(Alternative)	Inalways	0707-1, 0711-2, 0714	10A, 250Vac	IEC/ EN 60320-1 UL60320-1	VDE, UL
(Alternative)	DELIKANG	CDJ-3, CDJ-3-1	10A, 250Vac	IEC/ EN 60320-1 UL60320-1	VDE, UL
(Alternative)	TECX	TU-301 series	10A, 250Vac	IEC/ EN 60320-1 UL60320-1	VDE, UL
(Alternative)	Hongchang	DB-14-4, DB-14-05	10A, 250Vac	IEC/ EN 60320-1 UL60320-1	VDE, UL

IEC 62368-1					
Clause	Requirement + Test			Result - Remark	Verdict
(Alternative)	Yueqing Hongchang	DB-14, DB-14-14-R, DB-14-Series	10A, 250Vac	IEC/ EN 60320-1 UL60320-1	VDE, UL
Fuse (F901) on primary circuit	Littelfuse, Inc. Wickmann	382-series, 392	T4AL, 250Vac	IEC/ EN 60127-1 IEC/ EN 60127-3 UL 248-1	VDE, UL
(Alternative)	Littelfuse, Inc.	TE5 400	T4AL, 250Vac	IEC/ EN 60127-1 IEC/ EN 60127-3	VDE
(Alternative)	Conquer	MET, MST, PTU	T4AL, 250Vac	IEC/ EN 60127-1 IEC/ EN 60127-3 UL 248-1	VDE, UL
(Alternative)	Cooper Bussmann	SR-5, SS-5	T4AL, 250Vac	IEC/ EN 60127-1 IEC/ EN 60127-3 UL 248-1	VDE, UL
(Alternative)	Ever Island Electric Co., Ltd. & Walter Electric	2000, 2010 series	T4AL, 250Vac	IEC/ EN 60127-1 IEC/ EN 60127-3 UL 248-1	VDE, UL
(Alternative)	Littelfuse Phils. Inc.	877	T4AL, 250Vac	IEC/ EN 60127-1 IEC/ EN 60127-3 UL 248-1	VDE, UL
Fuse (F902) on secondary circuit	Littelfuse, Inc. Wickmann	382-series, 392	T4AL, 250Vac	IEC/ EN 60127-1 IEC/ EN 60127-3 UL 248-1	VDE, UL
(Alternative)	Littelfuse, Inc.	TE5 400	T4AL, 250Vac	IEC/ EN 60127-1 IEC/ EN 60127-3	VDE
(Alternative)	Conquer	MET, MST, PTU	T4AL, 250Vac	IEC/ EN 60127-1 IEC/ EN 60127-3 UL 248-1	VDE, UL
(Alternative)	Cooper Bussmann	SR-5, SS-5	T4AL, 250Vac	IEC/ EN 60127-1 IEC/ EN 60127-3 UL 248-1	VDE, UL
(Alternative)	Ever Island Electric Co., Ltd. & Walter Electric	2000, 2010 series	T4AL, 250Vac	IEC/ EN 60127-1 IEC/ EN 60127-3 UL 248-1	VDE, UL
(Alternative)	Littelfuse Phils. Inc.	877	T4AL, 250Vac	IEC/ EN 60127-1 IEC/ EN 60127-3 UL 248-1	VDE, UL
Y- Capacitor (C920, C921) Y1 or Y2 type (optional)	Walsin	AC, AH	Max. 1000pF, 250Vac, 85°C	IEC/EN 60384-14 UL 60384-14	VDE, UL
(Alternative)	TDK	CS, CD	Max. 1000pF, 250Vac, 85°C	IEC/EN 60384-14 UL 60384-14	VDE, UL

IEC 62368-1					
Clause	Requirement + Test			Result - Remark	Verdict
(Alternative)	Murata	KH, KX	Max. 1000pF, 250Vac, 85°C	IEC/EN 60384-14 UL 60384-14	VDE, UL
(Alternative)	JYA-NAY	JY, JN	Max. 1000pF, 250Vac, 85°C	IEC/EN 60384-14 UL 60384-14	VDE, UL
(Alternative)	Hongming	F	Max. 1000pF, 250Vac, 85°C	IEC/EN 60384-14 UL 60384-14	VDE, UL
(Alternative)	Wansheng	CT7	Max. 1000pF, 250Vac, 85°C	IEC/EN 60384-14 UL 60384-14	VDE, UL
(Alternative)	Haohua	CT7	Max. 1000pF, 250Vac, 85°C	IEC/EN 60384-14 UL 60384-14	VDE, UL
(Alternative)	Samwha	SD	Max. 1000pF, 250Vac, 85°C	IEC/EN 60384-14 UL 60384-14	VDE, UL
(Alternative)	Success	SB, SE	Max. 1000pF, 250Vac, 85°C	IEC/EN 60384-14 UL 60384-14	VDE, UL
(Alternative)	Yinan Don's	CT81	Max. 1000pF, 250Vac, 85°C	IEC/EN 60384-14 UL 60384-14	VDE, UL
Y- Capacitor (C900) Y1 type (optional)	Walsin	AH	Max. 3300pF, 250Vac, 85°C	IEC/EN 60384-14 UL 60384-14	VDE, UL
(Alternative)	TDK	CD	Max. 3300pF, 250Vac, 85°C	IEC/EN 60384-14 UL 60384-14	VDE, UL
(Alternative)	Murata	KX	Max. 3300pF, 250Vac, 85°C	IEC/EN 60384-14 UL 60384-14	VDE, UL
(Alternative)	JYA-NAY	JN	Max. 3300pF, 250Vac, 85°C	IEC/EN 60384-14 UL 60384-14	VDE, UL
(Alternative)	Hongming	F	Max. 3300pF, 250Vac, 85°C	IEC/EN 60384-14 UL 60384-14	VDE, UL
(Alternative)	Wansheng	CT7	Max. 3300pF, 250Vac, 85°C	IEC/EN 60384-14 UL 60384-14	VDE, UL
(Alternative)	Haohua	CT7	Max. 3300pF, 250Vac, 85°C	IEC/EN 60384-14 UL 60384-14	VDE, UL
(Alternative)	Samwha	SD	Max. 3300pF, 250Vac, 85°C	IEC/EN 60384-14 UL 60384-14	VDE, UL
(Alternative)	Success	SB, SE	Max. 3300pF, 250Vac, 85°C	IEC/EN 60384-14 UL 60384-14	VDE, UL
(Alternative)	Yinan Don's	CT81	Max. 3300pF, 250Vac, 85°C	IEC/EN 60384-14 UL 60384-14	VDE, UL
X-Capacitor (X1 or X2 type) (C914) (optional)	Ultra Tech Xiphi	HQX	Max. 0.47μF, Min. 275Vac, 85°C	IEC/EN 60384-14 UL 60384-14	VDE, UL
(Alternative)	Faratronic	MKP62	Max. 0.47μF, Min. 275Vac, 85°C	IEC/EN 60384-14 UL 60384-14	VDE, UL

IEC 62368-1					
Clause	Requirement + Test		Result - Remark		Verdict
(Alternative)	Hua Jung	MKP	Max. 0.47 μ F, Min. 275Vac, 85°C	IEC/EN 60384-14 UL 60384-14	ENEC(Semko), UL
(Alternative)	Nanjing Tengen Rongguangda	MKP	Max. 0.47 μ F, Min. 275Vac, 85°C	IEC/EN 60384-14 UL 60384-14	VDE, UL
(Alternative)	Europtronic	MPX, MPX2	Max. 0.47 μ F, Min. 275Vac, 85°C	IEC/EN 60384-14 UL 60384-14	VDE, UL
(Alternative)	Liow Gu	GS-L	Max. 0.47 μ F, Min. 275Vac, 85°C	IEC/EN 60384-14 UL 60384-14	VDE, UL
(Alternative)	Arcotronics (KEMET)	R.46	Max. 0.47 μ F, Min. 275Vac, 85°C	IEC/EN 60384-14 UL 60384-14	ENEC(IMQ), UL
(Alternative)	EPCOS	B3292#	Max. 0.47 μ F, Min. 275Vac, 85°C	IEC/EN 60384-14 UL 60384-14	VDE, UL
(Alternative)	ZhuHai Sung Ho Electronics Co., Ltd.	CMPP	Max. 0.47 μ F, Min. 275Vac, 85°C	IEC/EN 60384-14 UL 60384-14	VDE, UL
Photo Coupler (U902)	Sharp	PC123	Di=0.7mm, ext. cr \geq 8.0mm, min.3000Vac, 110°C	DIN EN 60747-5-5, UL1577	VDE, UL, Semko, Nemko, Fimko
(Alternative)	Vishay Semiconductor	TCET1103	Di=0.6mm, ext. cr=8.4mm, min.3000Vac, 100°C	DIN EN 60747-5-5, UL1577	VDE, UL, Semko, Fimko
(Alternative)	Everlight Electronics Co., Ltd.	EL817, EL817M	Di=0.5mm, ext. cr=7.7mm, min.3000Vac, 100°C	DIN EN 60747-5-5, UL1577	VDE, UL, Semko, Nemko, Fimko
(Alternative)	Everlight Electronics Co., Ltd.	EL1013	Di=0.4mm, ext. cr=8.0mm, min.3000Vac, 100°C	DIN EN 60747-5-5, UL1577	VDE, UL, Semko
(Alternative)	Lite-on	LTV-817	Di=0.4mm, ext. cr \geq 7.0mm, min.3000Vac, 100°C	DIN EN 60747-5-5, UL1577	VDE, UL
(Alternative)	Renesas	PS2561-1 PS2561L-1 PS2561L1-1 PS2561L2-1 PS2561DL1-1	Di=0.4mm, ext. cr=8.0mm, min.3000Vac, 100°C	DIN EN 60747-5-5, UL1577	VDE, UL, Nemko, Fimko
(Alternative)	TOSHIBA	TLP781F TLP781	Di=0.4mm, ext. cr=8.0mm, min.3000Vac, 100°C	DIN EN 60747-5-5, UL1577	VDE, UL, Semko, Fimko

IEC 62368-1					
Clause	Requirement + Test		Result - Remark		Verdict
(Alternative)	TOSHIBA	TLP421F	Di=0.4mm, ext. cr=8.0mm, min.3000Vac, 100°C	DIN EN 60747-5- 5, UL1577	VDE, UL, Semko, Fimko
Line Choke (L901A) (Optional)	CHANNELON	373G0174577H	105 °C	--	--
(Alternative)	LDFJ	373G0174577J	105 °C	--	--
(Alternative)	ASET	373G0174577X	105 °C	--	--
Transformer (T901)	Phoenix	380GL19P0170 P	Class B	--	Accepted by TÜV Rheinland
Alt.	LIANFENG DONGJJIN	380GL19P0170 J	Class B	--	Accepted by TÜV Rheinland
Alt.	TAICHANG	380GL19P0170 S	Class B	--	Accepted by TÜV Rheinland
Alt.	LITAI	380GL19P0170 L	Class B	--	Accepted by TÜV Rheinland
Alt.	YUVA	80GL19P-17-N	Class B	--	Accepted by TÜV Rheinland
-Bobbin	SUMITOMO BAKELITE CO LTD	PM-9820	V-0, 150°C, min. 0.45mm thick	UL94	UL
Alt.	GREAT LEOFLON INDUSTRIAL CO., LTD	TRW(B)	V-0, 150°C, min. 0.45mm thick	UL94	UL
Alt.	CHANG CHUN PLASTICS CO., LTD.	T200NA	V-0, 150°C, min. 0.45mm thick	UL94	UL
-Triple insulation wire	SUZHOU VDE YUSHENG ELECTRONIC CO LTD	TIW-B	Reinforced insulation, 130°C	IEC/EN 60950-1, UL 2353	VDE, UL
Alt.	Cosmolink Co Ltd	TIW-M	Reinforced insulation, 130°C	IEC/EN 60950-1, UL 2353	VDE, UL
-Insulation tape	JingJiang YaHua Pressure Sensitive Glue Co., Ltd	CT	PET film insulating tape, 130°C	UL510	UL

IEC 62368-1					
Clause	Requirement + Test			Result - Remark	Verdict
Alt.	SYMBIO INC	35660Y*(%)	PET film insulating tape, 130°C	UL510	UL
-Tube	GREAT HOLDING INDUSTRIAL CO., LTD.	TFL	PTFE, 200°C, VW-1	UL224	UL
Bleeder Resistor (R916, R917, R918)	Tzai Yuan Enterprise Co., Ltd.	HSMD series	Max. 680KΩ, min. 1/4W	IEC 62368-1: 2010	UL CB (Report No. OFF-12CA24616-A-1)
(Alternative)	Yageo Corporation	RV1206 series	Max. 680KΩ, min. 1/4W	IEC 62368-1: 2010	UL CB (Report No. E491387-4787887815-1 Original)
(Alternative)	Fenghua	RVS-06 series	Max. 680KΩ, min. 1/4W	IEC 62368-1: 2014	Nemko CB (Report No. 336992)
(Alternative)	Fenghua	RS-06 series	Max. 680KΩ, min. 1/4W	IEC 62368-1: 2014	Nemko CB (Report No. 337017)
Bridging Diode (BD902)	Interchangeable	Interchangeable	Min.600V, min.2A	--	--
Ripple Capacitor (C902, C903)	Interchangeable	Interchangeable	47-180μF, max. 450V, 105°C	--	--
Thermistor (TH901)	Interchangeable	Interchangeable	Min. 3Ω at 25°C, min. 2A	--	--
Supplementary information:					
1) Provided evidence ensures the agreed level of compliance. See OD-CB2039.					
2) In the technical data column of optocoupler, where "Dti" means distance through insulation, "Int. cr" means internal creepage distance, and "Ext. cr" means external creepage distance.					

IEC 62368-1			
Clause	Requirement + Test	Result - Remark	Verdict
4.8.4, 4.8.5	TABLE: Lithium coin/button cell batteries mechanical tests		N/A
(The following mechanical tests are conducted in the sequence noted.)			
4.8.4.2	TABLE: Stress Relief test		—
	Part	Material	Oven Temperature (°C)
4.8.4.3	TABLE: Battery replacement test		—
	Battery part no.:		—
	Battery Installation/withdrawal	Battery Installation/Removal Cycle	Comments
		1	
		2	
		3	
		4	
		5	
		6	
		8	
		9	
		10	
4.8.4.4	TABLE: Drop test		—
	Impact Area	Drop Distance	Drop No.
			1
			2
			3
4.8.4.5	TABLE: Impact		—
	Impacts per surface	Surface tested	Impact energy (Nm)
4.8.4.6	TABLE: Crush test		—
	Test position	Surface tested	Crushing Force (N)
			Duration force applied (s)
Supplementary information:			

IEC 62368-1			
Clause	Requirement + Test	Result - Remark	Verdict
4.8.5	TABLE: Lithium coin/button cell batteries mechanical test result		N/A
Test position	Surface tested	Force (N)	Duration force applied (s)
Supplementary information:			

5.2	Table: Classification of electrical energy sources						P
5.2.2.2 – Steady State Voltage and Current conditions							
No.	Supply Voltage	Location (e.g. circuit designation)	Test conditions	Parameters			ES Class
				U (Vrms or Vpk)	I (Apk or Arms)	Hz	
1	264V, 60Hz	+19V output of power board (“+” to “-”)	Normal	19.4Vdc	--	--	ES1
			Abnormal – (see table B.3 for details, maximum result recorded)	19.4Vdc	--	--	
			Single fault – (see table B.4 for details, maximum result recorded)	0	--	--	
2	264V, 60Hz	+19V output of power board (“+/-” to earth)	Normal	--	0.012mApk	--	ES1
			Abnormal – (blocked)	--	0.012mApk	--	
			Single fault – (VLED TO GND)	--	0.012mApk	--	
3	264V, 60Hz	Plastic enclosure to earth	Normal	--	0.01mApk	--	ES1
			Abnormal – (see table B.3 for details, maximum result recorded)	--	0.01mApk	--	
			Single fault – (see table B.4 for details, maximum result recorded)	--	0.01mApk	--	
5.2.2.3 - Capacitance Limits							
No.	Supply Voltage	Location (e.g. circuit designation)	Test conditions	Parameters		ES Class	
				Capacitance, nF	Upk (V)		
1	264V,	L&N pin of AC	Normal	0.47µF (C914)	373	ES3	

IEC 62368-1							
Clause	Requirement + Test			Result - Remark			Verdict
	60Hz	inlet	Abnormal	--	--	--	
			Single fault – SC/OC	--	--	--	
5.2.2.4 - Single Pulses							
No.	Supply Voltage	Location (e.g. circuit designation)	Test conditions	Parameters			ES Class
				Duration (ms)	Upk (V)	l _{pk} (mA)	
--	--	--	Normal	--	--	--	--
			Abnormal	--	--	--	
			Single fault – SC/OC	--	--	--	
5.2.2.5 - Repetitive Pulses							
No.	Supply Voltage	Location (e.g. circuit designation)	Test conditions	Parameters			ES Class
				Off time (ms)	Upk (V)	l _{pk} (mA)	
--	--	--	Normal	--	--	--	--
			Abnormal	--	--	--	
			Single fault – SC/OC	--	--	--	
Test Conditions:							
Normal –							
Abnormal -							
Supplementary information: SC=Short Circuit, OC=Short Circuit							

5.4.1.4, 6.3.2, 9.0, B.2.6	TABLE: Temperature measurements					P
	Supply voltage (V)	90V/ 60Hz	264V/ 60Hz	90V/ 60Hz	264V/ 60Hz	—
	Ambient T _{min} (°C)	--	--	--	--	—
	Ambient T _{max} (°C)	--	--	--	--	—
	T _{ma} (°C)	40.0	40.0	40.0	40.0	—
Maximum measured temperature T of part/at:			T (°C)			Allowed T _{max} (°C)
Tested on model 24G2 mainboard 715G9584 and USB board 715GA629			Horizontal orientation		--	
Line pin of AC Inlet CN901 (on power board)		41.0	40.9	--	--	54
PCB near TH901 (on power board)		58.0	50.7	--	--	114
C900 body (on power board)		56.8	45.7	--	--	69
L901 coil (on power board)		60.5	49.2	--	--	89
PCB near BD901 (on power board)		77.2	52.8	--	--	114

IEC 62368-1					
Clause	Requirement + Test		Result - Remark		Verdict
C921 body (on power board)	42.8	57.7	--	--	69
U902 body (on power board)	60.1	54.2	--	--	84
T901 coil (on power board)	88.9	74.2	--	--	94
T901 core (on power board)	86.5	64.4	--	--	94
C914 body (on power board)	53.3	45.1	--	--	69
C902 body (on power board)	67.8	47.3	--	--	84
PCB near D906 (on power board)	91.7	76.4	--	--	114
PCB near U401 body (main board)	51.0	52.7	--	--	114
PCB near L801 (on power board)	63.7	56.1	--	--	114
Metal enclosure	42.7	40.6	--	--	54
Plastic enclosure inside near T901	35.1	33.4	--	--	--
Plastic enclosure outside	32.4	32.6	--	--	79.0
Panel surface	34.6	29.9	--	--	79.0
Ambient	25.1	25.1	--	--	--
Tested on model 27G2 with main board 715G9584 and USB board 715GA629					
Line pin of AC Inlet CN901 (on power board)	40.1	40.1	--	--	54
PCB near TH901 (on power board)	70.5	57.3	--	--	114
C900 body (on power board)	57.8	49.4	--	--	69
L901 coil (on power board)	68.6	58.3	--	--	89
PCB near BD901 (on power board)	74.0	58.4	--	--	114
C921 body (on power board)	46.9	59.9	--	--	69
U902 body (on power board)	69.6	64.7	--	--	84
T901 coil (on power board)	82.6	74.2	--	--	94
T901 core (on power board)	78.4	80.9	--	--	94
C914 body (on power board)	48.4	54.3	--	--	69
C902 body (on power board)	68.9	75.5	--	--	84
PCB near D906 (on power board)	102.6	77.1	--	--	114
PCB near U401 body (main board)	51.1	76.4	--	--	114
PCB near L801 (on power board)	66.7	58.6	--	--	114
Metal enclosure	45.7	43.9	--	--	54
Plastic enclosure inside near T901	33.5	40.5	--	--	--
Plastic enclosure outside	26.1	37.5	--	--	79
Panel surface	31.8	34.0	--	--	79
Ambient	25.1	25.1	--	--	--

IEC 62368-1			
Clause	Requirement + Test	Result - Remark	Verdict

Supplementary information:

1. Having a specified maximum ambient temperature of 40°C.
- 2.*) Temperature limits of winding reduced by 10°C due to thermocouple measurement method.

Temperature T of winding:	t1 (°C)	R1 (Ω)	t2 (°C)	R2 (Ω)	T (°C)	Allowed Tmax (°C)	Insulation class

Supplementary information:

Note 1: T_{ma} should be considered as directed by applicable requirement

Note 2: T_{ma} is not included in assessment of Touch Temperatures (Clause 9)

1. With a specified ambient temperature of 40°C. Temperature limits are calculated as follows:

Winding components providing safety isolation:

- Class B: T_{max} = 120 - 10 - 40 + T_{amb}

Components with maximum absolute temperature of others:

- T_{max} = T_{max} of component - 40 + T_{amb}

5.4.1.10.2	TABLE: Vicat softening temperature of thermoplastics	N/A
Penetration (mm).....:		—
Object/ Part No./Material	Manufacturer/t rademark	T softening (°C)
supplementary information:		

5.4.1.10.3	TABLE: Ball pressure test of thermoplastics	P	
Allowed impression diameter (mm)	≤ 2 mm	—	
Object/Part No./Material	Manufacturer/trademark	Test temperature (°C)	Impression diameter (mm)
Plastic enclosure: HIPS-5197, 2.5mm	Kingfa	90	1.59
Plastic enclosure: GAR-011(L85), 2.5mm	Kingfa	85	1.31
Plastic enclosure: GAR-011(L65), 2.5mm	Kingfa	85	1.29
Plastic enclosure: HIPS-510(H), 2.5mm	Kingfa	80	1.29
Plastic enclosure: FRHIPS-960, 2.5mm	Kingfa	85	1.88
Plastic enclosure: GC-0750(+), 2.5mm	Cheil	80	1.61
Plastic enclosure: GC-0700(+), 2.5mm	Cheil	80	1.94
Plastic enclosure: HG-0760(+), 2.5mm	Cheil	85	1.73

IEC 62368-1			
Clause	Requirement + Test	Result - Remark	Verdict
Plastic enclosure: LX-0951(+), 2.5mm	Cheil	85	1.83
Plastic enclosure: SD-0150, 2.5mm	Cheil	85	1.48
Plastic enclosure: HR-1360, 2.5mm	Cheil	85	1.71
Plastic enclosure: BF-0670F, 2.5mm	Cheil	80	1.59
Plastic enclosure: HF380, 2.5mm	LG	85	1.48
Plastic enclosure: SE885, 2.5mm	LG	80	1.42
Plastic enclosure: LUPOY GP-1000(#), 2.5mm	LG	95	1.21
Plastic enclosure: XG568, 2.5mm	LG	80	1.81
Plastic enclosure: XG569C, 2.5mm	LG	80	1.85
Plastic enclosure: HF388H, 2.5mm	LG	85	1.39
Plastic enclosure: SE750, 2.5mm	LG	80	1.5
Plastic enclosure: TN-7500, 2.5mm	Teijin	85	1.57
Plastic enclosure: HIPS-2000, 2.5mm	ORINKO	85	1.48
Plastic enclosure: GAR-011C, 2.5mm	Kingfa	90	1.91
Supplementary information: Above mentioned plastic enclosure material was tested by client's request.			

5.4.2.2, 5.4.2.4 and 5.4.3	TABLE: Minimum Clearances/Creepage distance						P
	Clearance (cl) and creepage distance (cr) at/of/between:	Up (V)	U r.m.s. (V)	Frequency (kHz) ¹	Required cl (mm)	cl (mm)	Required ³ cr (mm)
Functional:							
Under fuse (F901) ¹	420	250	0.06	2.3	2.8	2.5	4.2
Before fuse (between L-N) ¹	420	250	0.06	2.3	5.7	2.5	8.0
Basic/supplementary:							
Line-GND ¹	420	250	0.06	2.3	3.1	2.5	3.1
Neutral-GND ¹	420	250	0.06	2.3	3.1	2.5	3.1
Under C920 ¹	420	250	0.06	2.3	7.3	2.5	9.1

IEC 62368-1							
Clause	Requirement + Test			Result - Remark			Verdict
Under C921 ¹	420	250	0.06	2.3	4.3	2.5	4.3
Primary component L901 to metal enclosure	610	337	>30	2.3	4.0	3.4	5)
Core of T901 to metal enclosure	610	337	>30	2.3	5)	3.4	5)
Reinforced:							
Primary component trace to panel	610	337	>30	4.5	5)	6.8	5)
Under C900 ¹	420	250	0.06	4.5	7.6	5.0	9.4
Under U902 ¹	420	250	0.06	4.5	7.8	5.0	9.2
Under T901 trace	610	337	>30	4.5	12.0	6.8	12.0
Secondary component C942 to core of T901	610	337	>30	4.5	6.0	6.8	6.0
Supplementary information:							
<ol style="list-style-type: none"> There is one slot measured 1mm width. Core of main transformer T901 consider as primary. Glued component: C902, C903. Considered altitude correction factor 1.48 for clearances for an altitude of 5000m. For clearance and creepage that did not describe above are far larger than limit above. One mylar sheet is fixed between power board and panel plate to fulfill the requirement for basic insulation. 							

5.4.2.3	TABLE: Minimum Clearances distances using required withstand voltage			P
	Overvoltage Category (OV):			II
	Pollution Degree:			2
Clearance distanced between:	Required withstand voltage	Required cl (mm)	Measured cl (mm)	
Basic	2500	See table 5.4.2.2, 5.4.2.4 and 5.4.3	See table 5.4.2.2, 5.4.2.4 and 5.4.3	
Reinforce	2500	See table 5.4.2.2, 5.4.2.4 and 5.4.3	See table 5.4.2.2, 5.4.2.4 and 5.4.3	
Supplementary information:				
The equipment to be operated up to 5000 m above sea level, each clearance multiplied with an altitude correction factor of 1.48.				

5.4.2.4	TABLE: Clearances based on electric strength test			N/A
Test voltage applied between:	Required cl (mm)	Test voltage (kV) peak/ r.m.s. / d.c.	Breakdown Yes / No	
--	--	--	--	
Supplementary information:				

IEC 62368-1					
Clause	Requirement + Test			Result - Remark	Verdict
5.4.4.2, 5.4.4.5 c) 5.4.4.9	TABLE: Distance through insulation measurements				P
Distance through insulation di at/of:	Peak voltage (V)	Frequency (kHz)	Material	Required DTI (mm)	DTI (mm)
Plastic enclosure	420	0.06	See table 4.1.2	0.4	See table 4.1.2
Mylar sheet located between power supply board and panel	506	0.06	See table 4.1.2	0.4	Min. 0.4
Supplementary information:					

5.4.9	TABLE: Electric strength tests			P
Test voltage applied between:	Voltage shape (AC, DC)	Test voltage (V)	Breakdown Yes / No	
Basic/supplementary:				
Unit primary to earthed metal part	AC	2500	No	
Mylar sheet fixed between power board trace side and metal enclosure ²⁾	AC	2500	No	
Reinforced:				
L/N to accessible plastic enclosure with metal foil	AC	4000	No	
Mylar sheet fixed between power board trace side and panel plate ²⁾	AC	4000	No	
Unit primary to secondary (output)	AC	4000	No	
T901 ¹⁾ : primary to secondary	AC	4000	No	
T901 ¹⁾ : secondary to core	AC	4000	No	
T901 ¹⁾ : one layer of insulation tape	AC	4000	No	
Supplementary information: 1. For all sources of T901; 2. For all sources of mylar sheet; 3. The test mentioned above were performed after humidity conditioning test.				

5.5.2.2	TABLE: Stored discharge on capacitors				P
Supply Voltage (V), Hz	Test Location	Operating Condition (N, S)	Switch position On or off	Measured Voltage (after 2 seconds)	ES Classification
90V, 60Hz	Phase to Neutral	N	On	0V	ES1

IEC 62368-1					
Clause	Requirement + Test			Result - Remark	Verdict
264V, 60Hz	Phase to Neutral	N	On	0V	ES1
Supplementary information: X-capacitors installed for testing are: C914=0.47uF. <input checked="" type="checkbox"/> bleeding resistor rating: R916=R917=R918=480KΩ (certified resistors used, see appended table 4.1.2 for details, and no need to perform single fault test). <input type="checkbox"/> ICX: Notes: A. Test Location: Phase to Neutral; Phase to Phase; Phase to Earth; and/or Neutral to Earth B. Operating condition abbreviations: N – Normal operating condition (e.g., normal operation, or open fuse); S –Single fault condition					

5.6.6.2	TABLE: Resistance of protective conductors and terminations				P
Accessible part	Test current (A)	Duration (min)	Voltage drop (V)	Resistance (Ω)	
PE terminal of AC inlet to internal metal enclosure	40	2	0.58	0.015	
PE terminal of AC inlet to C920 trace	40	2	0.32	0.009	
PE terminal of AC inlet to C921 trace	40	2	0.32	0.008	
Supplementary information:					

5.7.2.2, 5.7.4	TABLE: Earthed accessible conductive part		P
Supply voltage			—
Location	Test conditions specified in 6.1 of IEC 60990 or Fault Condition No in IEC 60990 clause 6.2.2.1 through 6.2.2.8, except for 6.2.2.7		Touch current (mA)
Line to earth, Neutral to earth, Line to secondary connector, Neutral to secondary connector, Line to metal enclosure, Neutral to metal enclosure, Line to plastic enclosure with copper foil, Neutral to plastic enclosure with copper foil	1		0.35 max. (for earthed part) 0.01 max. (for non-earthed part)
	2*		--
	3		--
	4		--
	5		--
	6		--
	8		--

IEC 62368-1			
Clause	Requirement + Test	Result - Remark	Verdict

<p>Supplementary Information:</p> <p>Notes:</p> <p>[1] Supply voltage is the anticipated maximum Touch Voltage</p> <p>[2] Earthed neutral conductor [Voltage differences less than 1% or more]</p> <p>[3] Specify method used for measurement as described in IEC 60990 sub-clause 4.3</p> <p>[4] IEC60990, sub-clause 6.2.2.7, Fault 7 not applicable.</p> <p>[5] (*) IEC60990, sub-clause 6.2.2.2 is not applicable if switch or disconnect device (e.g., appliance coupler) provided.</p>
--

6.2.2	Table: Electrical power sources (PS) measurements for classification					P
Source	Description	Measurement	Max Power after 3 s	Max Power after 5 s [*]	PS Classification	
A	+19Vout output of power board	Power (W) :	--	--	PS2 (See Table Annex Q.1)	
		V _A (V) :	--	--		
		I _A (A) :	--	--		
Supplementary Information:						
(*) Measurement taken only when limits at 3 seconds exceed PS1 limits						

6.2.3.1	Table: Determination of Potential Ignition Sources (Arcing PIS)				P
Location	Open circuit voltage After 3 s (V _p)	Measured r.m.s current (I _{rms})	Calculated value (V _p x I _{rms})	Arcing PIS? Yes / No	
2)	2)	2)	2)	Yes	
Supplementary information:					
1) An Arcing PIS requires a minimum of 50 V (peak) a.c. or d.c. An Arcing PIS is established when the product of the open circuit voltage (V _p) and normal operating condition rms current (I _{rms}) is greater than 15.					
2) All components located within the power board are considered as arcing PIS.					

6.2.3.2	Table: Determination of Potential Ignition Sources (Resistive PIS)				P
Circuit Location (x-y)	Operating Condition (Normal / Describe Single Fault)	Measured wattage or VA During first 30 s (W / VA)	Measured wattage or VA After 30 s (W / VA)	Protective Circuit, Regulator, or PTC Operated? Yes / No (Comment)	Resistive PIS? Yes/No
3)	3)	3)	3)	--	Yes
Supplementary information:					
1) A combination of voltmeter, VA and ammeter IA may be used instead of a wattmeter. If a separate voltmeter and ammeter are used, the product of (VA x IA) is used to determine Resistive PIS classification.					
2) A Resistive PIS: (a) dissipates more than 15 W, measured after 30 s of normal operation, or (b) under single fault conditions has either a power exceeding 100 W measured immediately after the introduction of the fault if electronic circuits, regulators or PTC devices are used, or has an available power exceeding 15 W measured 30 s after introduction of the fault.					
3) All components located within the EUT are considered as resistive PIS.					

IEC 62368-1			
Clause	Requirement + Test	Result - Remark	Verdict

8.5.5	TABLE: High Pressure Lamp			N/A
Description	Values		Energy Source Classification	
Lamp type			—	
Manufacturer			—	
Cat no.			—	
Pressure (cold) (MPa).....			MS_	
Pressure (operating) (MPa).....			MS_	
Operating time (minutes)			—	
Explosion method			—	
Max particle length escaping enclosure (mm) .:			MS_	
Max particle length beyond 1 m (mm).....			MS_	
Overall result				
Supplementary information:				

B.2.5	TABLE: Input test							P
U (V)	I (A)	I rated (A)	P (W)	P rated (W)	Fuse No	I fuse (A)	Condition/status	
Tested on 24G2 with mainboard 715G9584 and USB board 715GA629								
VGA mode								
90/50	0.873	--	48.8	--	F901	0.873	Maximum normal load	
90/60	0.853	--	48.6	--	F901	0.853	Maximum normal load	
100/50	0.794	1.5	48.3	--	F901	0.794	Maximum normal load	
100/60	0.778	1.5	48.2	--	F901	0.778	Maximum normal load	
240/50	0.392	1.5	47.4	--	F901	0.392	Maximum normal load	
240/60	0.387	1.5	47.3	--	F901	0.387	Maximum normal load	
264/50	0.368	--	47.6	--	F901	0.368	Maximum normal load	
264/60	0.363	--	47.2	--	F901	0.363	Maximum normal load	
HDMI mode								
90/50	0.907	--	50.6	--	F901	0.907	Maximum normal load	
90/60	0.889	--	50.7	--	F901	0.889	Maximum normal load	
100/50	0.824	1.5	50.2	--	F901	0.824	Maximum normal load	
100/60	0.808	1.5	50.4	--	F901	0.808	Maximum normal load	
240/50	0.407	1.5	49.4	--	F901	0.407	Maximum normal load	
240/60	0.400	1.5	49.4	--	F901	0.400	Maximum normal load	
264/50	0.378	--	49.4	--	F901	0.378	Maximum normal load	

IEC 62368-1							
Clause	Requirement + Test				Result - Remark		Verdict
B.2.5	TABLE: Input test						P
U (V)	I (A)	I rated (A)	P (W)	P rated (W)	Fuse No	I fuse (A)	Condition/status
264/60	0.375	--	49.0	--	F901	0.375	Maximum normal load
DP mode							
90/50	0.902	--	50.4	--	F901	0.902	Maximum normal load
90/60	0.883	--	50.3	--	F901	0.883	Maximum normal load
100/50	0.819	1.5	49.8	--	F901	0.819	Maximum normal load
100/60	0.809	1.5	49.7	--	F901	0.809	Maximum normal load
240/50	0.405	1.5	49.1	--	F901	0.405	Maximum normal load
240/60	0.400	1.5	48.7	--	F901	0.400	Maximum normal load
264/50	0.379	--	49.1	--	F901	0.379	Maximum normal load
264/60	0.372	--	48.5	--	F901	0.372	Maximum normal load
Tested on 27G2 with mainboard 715G9584 and USB board 715GA629							
HDMI mode							
90/50	1.036	--	58.2	--	F901	1.036	Maximum normal load
90/60	1.006	--	58.3	--	F901	1.006	Maximum normal load
100/50	0.936	1.5	57.5	--	F901	0.936	Maximum normal load
100/60	0.914	1.5	57.2	--	F901	0.914	Maximum normal load
240/50	0.452	1.5	55.5	--	F901	0.452	Maximum normal load
240/60	0.448	1.5	56.0	--	F901	0.448	Maximum normal load
264/50	0.422	--	55.5	--	F901	0.422	Maximum normal load
264/60	0.416	--	55.5	--	F901	0.416	Maximum normal load
VGA mode							
90/50	1.000	--	56.0	--	F901	1.000	Maximum normal load
90/60	0.974	--	55.8	--	F901	0.974	Maximum normal load
100/50	0.901	1.5	55.3	--	F901	0.901	Maximum normal load
100/60	0.875	1.5	55.1	--	F901	0.875	Maximum normal load
240/50	0.436	1.5	53.5	--	F901	0.436	Maximum normal load
240/60	0.432	1.5	53.4	--	F901	0.432	Maximum normal load
264/50	0.407	--	53.5	--	F901	0.407	Maximum normal load
264/60	0.403	--	54.0	--	F901	0.403	Maximum normal load
DP mode							
90/50	1.040	--	57.9	--	F901	1.040	Maximum normal load
90/60	1.007	--	58.0	--	F901	1.007	Maximum normal load

IEC 62368-1							
Clause	Requirement + Test				Result - Remark		Verdict
B.2.5	TABLE: Input test						P
U (V)	I (A)	I rated (A)	P (W)	P rated (W)	Fuse No	I fuse (A)	Condition/status
100/50	0.931	1.5	57.2	--	F901	0.931	Maximum normal load
100/60	0.949	1.5	57.1	--	F901	0.949	Maximum normal load
240/50	0.449	1.5	55.9	--	F901	0.449	Maximum normal load
240/60	0.446	1.5	55.9	--	F901	0.446	Maximum normal load
264/50	0.418	--	56.0	--	F901	0.418	Maximum normal load
264/60	0.415	--	56.1	--	F901	0.415	Maximum normal load
Tested on 24G2 with mainboard 715G9584							
VGA mode							
90/50	0.430	--	21.2	--	F901	0.430	Maximum normal load
90/60	0.436	--	21.2	--	F901	0.436	Maximum normal load
100/50	0.401	1.5	21.1	--	F901	0.401	Maximum normal load
100/60	0.406	1.5	21.1	--	F901	0.406	Maximum normal load
240/50	0.235	1.5	20.9	--	F901	0.235	Maximum normal load
240/60	0.232	1.5	21.2	--	F901	0.232	Maximum normal load
264/50	0.219	--	21.0	--	F901	0.219	Maximum normal load
264/60	0.217	--	21.3	--	F901	0.217	Maximum normal load
DP Mode							
90/50	0.429	--	21.0	--	F901	0.430	Maximum normal load
90/60	0.435	--	21.1	--	F901	0.436	Maximum normal load
100/50	0.399	1.5	20.9	--	F901	0.401	Maximum normal load
100/60	0.402	1.5	20.9	--	F901	0.406	Maximum normal load
240/50	0.234	1.5	21.2	--	F901	0.235	Maximum normal load
240/60	0.229	1.5	20.8	--	F901	0.232	Maximum normal load
264/50	0.219	--	21.3	--	F901	0.219	Maximum normal load
264/60	0.215	--	21.1	--	F901	0.217	Maximum normal load
HDMI Mode							
90/50	0.428	--	21.2	--	F901	0.430	Maximum normal load
90/60	0.434	--	21.0	--	F901	0.436	Maximum normal load
100/50	0.397	1.5	21.1	--	F901	0.401	Maximum normal load
100/60	0.401	1.5	21.2	--	F901	0.406	Maximum normal load
240/50	0.233	1.5	21.2	--	F901	0.235	Maximum normal load
240/60	0.228	1.5	20.9	--	F901	0.232	Maximum normal load

IEC 62368-1							
Clause	Requirement + Test				Result - Remark		Verdict
B.2.5	TABLE: Input test						P
U (V)	I (A)	I rated (A)	P (W)	P rated (W)	Fuse No	I fuse (A)	Condition/status
264/50	0.218	--	21.3	--	F901	0.219	Maximum normal load
264/60	0.215	--	21.4	--	F901	0.217	Maximum normal load
Tested on 27G2 with mainboard 715G9584							
VGA mode							
90/50	0.498	--	24.9	--	F901	0.430	Maximum normal load
90/60	0.508	--	25.0	--	F901	0.436	Maximum normal load
100/50	0.463	1.5	24.9	--	F901	0.401	Maximum normal load
100/60	0.468	1.5	24.8	--	F901	0.406	Maximum normal load
240/50	0.271	1.5	24.5	--	F901	0.235	Maximum normal load
240/60	0.266	1.5	24.8	--	F901	0.232	Maximum normal load
264/50	0.252	--	24.6	--	F901	0.219	Maximum normal load
264/60	0.249	--	25.0	--	F901	0.217	Maximum normal load
DP Mode							
90/50	0.496	--	24.9	--	F901	0.430	Maximum normal load
90/60	0.503	--	24.8	--	F901	0.436	Maximum normal load
100/50	0.464	1.5	24.8	--	F901	0.401	Maximum normal load
100/60	0.471	1.5	24.7	--	F901	0.406	Maximum normal load
240/50	0.273	1.5	24.4	--	F901	0.235	Maximum normal load
240/60	0.268	1.5	24.8	--	F901	0.232	Maximum normal load
264/50	0.253	--	24.5	--	F901	0.219	Maximum normal load
264/60	0.248	--	24.6	--	F901	0.217	Maximum normal load
HDMI Mode							
90/50	0.498	--	24.9	--	F901	0.430	Maximum normal load
90/60	0.508	--	24.9	--	F901	0.436	Maximum normal load
100/50	0.464	1.5	24.8	--	F901	0.401	Maximum normal load
100/60	0.471	1.5	24.8	--	F901	0.406	Maximum normal load
240/50	0.273	1.5	24.6	--	F901	0.235	Maximum normal load
240/60	0.268	1.5	25.0	--	F901	0.232	Maximum normal load
264/50	0.253	--	24.6	--	F901	0.219	Maximum normal load
264/60	0.249	--	25.0	--	F901	0.217	Maximum normal load
Tested on 24G2 with mainboard 715GA740							
HDMI mode							

IEC 62368-1							
Clause	Requirement + Test				Result - Remark		Verdict
B.2.5	TABLE: Input test						P
U (V)	I (A)	I rated (A)	P (W)	P rated (W)	Fuse No	I fuse (A)	Condition/status
90/50	0.372	--	18.3	--	F901	0.372	Maximum normal load
90/60	0.372	--	18.3	--	F901	0.372	Maximum normal load
100/50	0.346	1.5	18.2	--	F901	0.346	Maximum normal load
100/60	0.345	1.5	18.2	--	F901	0.345	Maximum normal load
240/50	0.212	1.5	18.4	--	F901	0.212	Maximum normal load
240/60	0.209	1.5	18.4	--	F901	0.209	Maximum normal load
264/50	0.201	--	18.6	--	F901	0.201	Maximum normal load
264/60	0.199	--	18.6	--	F901	0.199	Maximum normal load
VGA mode							
90/50	0.372	--	18.1	--	F901	0.372	Maximum normal load
90/60	0.370	--	18.1	--	F901	0.370	Maximum normal load
100/50	0.348	1.5	18.0	--	F901	0.348	Maximum normal load
100/60	0.344	1.5	18.0	--	F901	0.344	Maximum normal load
240/50	0.211	1.5	18.2	--	F901	0.211	Maximum normal load
240/60	0.209	1.5	18.2	--	F901	0.209	Maximum normal load
264/50	0.200	--	18.4	--	F901	0.200	Maximum normal load
264/60	0.199	--	18.5	--	F901	0.199	Maximum normal load
DP mode							
90/50	0.365	--	18.1	--	F901	0.365	Maximum normal load
90/60	0.366	--	18.1	--	F901	0.366	Maximum normal load
100/50	0.346	1.5	18.0	--	F901	0.346	Maximum normal load
100/60	0.345	1.5	18.0	--	F901	0.345	Maximum normal load
240/50	0.211	1.5	18.2	--	F901	0.211	Maximum normal load
240/60	0.209	1.5	18.2	--	F901	0.209	Maximum normal load
264/50	0.200	--	18.4	--	F901	0.200	Maximum normal load
264/60	0.198	--	18.4	--	F901	0.198	Maximum normal load
Tested on 27G2 with mainboard 715G9500							
HDMI mode							
90/50	0.525	--	26.9	--	F901	0.525	Maximum normal load
90/60	0.524	--	27.0	--	F901	0.524	Maximum normal load
100/50	0.490	1.5	26.9	--	F901	0.490	Maximum normal load
100/60	0.495	1.5	26.9	--	F901	0.495	Maximum normal load

IEC 62368-1							
Clause	Requirement + Test				Result - Remark		Verdict
B.2.5	TABLE: Input test						P
U (V)	I (A)	I rated (A)	P (W)	P rated (W)	Fuse No	I fuse (A)	Condition/status
240/50	0.298	1.5	26.8	--	F901	0.298	Maximum normal load
240/60	0.285	1.5	26.8	--	F901	0.285	Maximum normal load
264/50	0.274	--	26.9	--	F901	0.274	Maximum normal load
264/60	0.269	--	27.0	--	F901	0.269	Maximum normal load
DP mode							
90/50	0.522	--	26.9	--	F901	0.522	Maximum normal load
90/60	0.522	--	26.9	--	F901	0.522	Maximum normal load
100/50	0.485	1.5	26.8	--	F901	0.485	Maximum normal load
100/60	0.483	1.5	26.8	--	F901	0.483	Maximum normal load
240/50	0.284	1.5	26.8	--	F901	0.284	Maximum normal load
240/60	0.280	1.5	26.7	--	F901	0.280	Maximum normal load
264/50	0.268	--	26.9	--	F901	0.268	Maximum normal load
264/60	0.265	--	26.8	--	F901	0.265	Maximum normal load
Tested on model 24G2 with mainboard 715GB201 and USB board 715GA629							
HDMI mode							
90/50	0.952	--	53.4	--	F901	0.952	Maximum normal load
90/60	0.907	--	53.0	--	F901	0.907	Maximum normal load
100/50	0.849	1.5	52.5	--	F901	0.849	Maximum normal load
100/60	0.817	1.5	52.4	--	F901	0.817	Maximum normal load
240/50	0.406	1.5	51.4	--	F901	0.406	Maximum normal load
240/60	0.397	1.5	51.3	--	F901	0.397	Maximum normal load
264/50	0.377	--	51.4	--	F901	0.377	Maximum normal load
264/60	0.370	--	51.4	--	F901	0.370	Maximum normal load
DP mode							
90/50	0.943	--	53.0	--	F901	0.943	Maximum normal load
90/60	0.904	--	52.8	--	F901	0.904	Maximum normal load
100/50	0.847	1.5	52.5	--	F901	0.847	Maximum normal load
100/60	0.816	1.5	52.3	--	F901	0.816	Maximum normal load
240/50	0.403	1.5	51.2	--	F901	0.403	Maximum normal load
240/60	0.395	1.5	51.2	--	F901	0.395	Maximum normal load
264/50	0.375	--	51.4	--	F901	0.375	Maximum normal load
264/60	0.368	--	51.4	--	F901	0.368	Maximum normal load

IEC 62368-1							
Clause	Requirement + Test				Result - Remark		Verdict
B.2.5	TABLE: Input test						P
U (V)	I (A)	I rated (A)	P (W)	P rated (W)	Fuse No	I fuse (A)	Condition/status
VGA mode							
90/50	0.944	--	53.1	--	F901	0.944	Maximum normal load
90/60	0.902	--	52.8	--	F901	0.902	Maximum normal load
100/50	0.844	1.5	52.7	--	F901	0.844	Maximum normal load
100/60	0.815	1.5	52.7	--	F901	0.815	Maximum normal load
240/50	0.403	1.5	51.5	--	F901	0.403	Maximum normal load
240/60	0.395	1.5	51.4	--	F901	0.395	Maximum normal load
264/50	0.376	--	51.7	--	F901	0.376	Maximum normal load
264/60	0.369	--	51.8	--	F901	0.369	Maximum normal load
Tested on model 27G2 with mainboard 715GA531							
HDMI mode							
90/50	0.544	--	30.3	--	F901	0.544	Maximum normal load
90/60	0.529	--	30.2	--	F901	0.529	Maximum normal load
100/50	0.496	1.5	30.1	--	F901	0.496	Maximum normal load
100/60	0.484	1.5	30.1	--	F901	0.484	Maximum normal load
240/50	0.249	1.5	29.7	--	F901	0.249	Maximum normal load
240/60	0.245	1.5	29.7	--	F901	0.245	Maximum normal load
264/50	0.234	--	29.9	--	F901	0.234	Maximum normal load
264/60	0.231	--	30.0	--	F901	0.231	Maximum normal load
DP mode							
90/50	0.545	--	30.4	--	F901	0.545	Maximum normal load
90/60	0.532	--	30.4	--	F901	0.532	Maximum normal load
100/50	0.496	1.5	30.1	--	F901	0.496	Maximum normal load
100/60	0.484	1.5	30.1	--	F901	0.484	Maximum normal load
240/50	0.249	1.5	29.6	--	F901	0.249	Maximum normal load
240/60	0.245	1.5	29.6	--	F901	0.245	Maximum normal load
264/50	0.233	--	29.7	--	F901	0.233	Maximum normal load
264/60	0.229	--	29.6	--	F901	0.229	Maximum normal load
VGA mode							
90/50	0.529	--	29.2	--	F901	0.529	Maximum normal load
90/60	0.514	--	29.2	--	F901	0.514	Maximum normal load
100/50	0.481	1.5	28.9	--	F901	0.481	Maximum normal load

IEC 62368-1			
Clause	Requirement + Test	Result - Remark	Verdict

B.2.5	TABLE: Input test							P
U (V)	I (A)	I rated (A)	P (W)	P rated (W)	Fuse No	I fuse (A)	Condition/status	
100/60	0.468	1.5	28.9	--	F901	0.468	Maximum normal load	
240/50	0.242	1.5	28.6	--	F901	0.242	Maximum normal load	
240/60	0.238	1.5	28.6	--	F901	0.238	Maximum normal load	
264/50	0.227	--	28.7	--	F901	0.227	Maximum normal load	
264/60	0.223	--	28.7	--	F901	0.223	Maximum normal load	

Supplementary information:

- Maximum normal load: maximum brightness, maximum contrast, full white screen.
- If not specified particularly, main board 715GA584 with USB board USB board, HDMI mode was used for all other tests.

B.3	TABLE: Abnormal operating condition tests							P
Ambient temperature (°C)					See below			—
Power source for EUT: Manufacturer, model/type, output rating ...:					See table 4.1.2			—
Component No.	Abnormal Condition	Supply voltage (V)	Test time (ms)	Fuse no.	Fuse current (A)	T-couple	Temp. (°C)	Observation
Ventilation openings (for 23.6 inch models)	blocked	264	--	F901	0.22	--	Max. measured temperature: T901 coil = 53.9; T901 core = 54.7; AC inlet = 38.6; Metal enclosure = 38.4; Plastic enclosure outside near T901 = 27.9; Panel = 39.2; Button = 26.4; Ambient = 22.2;	Unit operated normally, no hazards, no damaged.
T901 pin 7,8- pin 11 after D904 (+19V) (for 23.6 inch models)	o-l	264	--	F901	0.67	--	Max. measured temperature: T901 coil = 87.9; T901 core = 86.8; AC inlet = 38.5; Metal enclosure = 40.3; Plastic enclosure outside near T901= 31.1; Panel = 37.9; Button = 25.6; Ambient = 22.2;	Before shutdown winding is loaded to 2.78A, No damage, no hazards.

IEC 62368-1								
Clause	Requirement + Test						Result - Remark	Verdict
Ventilation openings (for 27.0 inch models)	blocked	264	--	F901	0.25	--	Max. measured temperature: T901 coil = 54.9; T901 core = 56.5; AC inlet = 37.8; Metal enclosure = 38.9; Plastic enclosure outside near T901= 32.3; Panel = 40.7; Button = 24.2; Ambient = 22.2;	Unit operated normally, no hazards, no damaged.
T901 pin 7,8- pin 11 after D904 (+19V) (for 27.0 inch models)	o-l	264	--	F901	0.67	--	Max. measured temperature: T901 coil = 77.6; T901 core = 83.0; AC inlet = 40.1; Metal enclosure = 41.4; Plastic enclosure outside near T901= 32.4; Panel = 42.8; Button = 26.6; Ambient = 22.2;	Before shutdown winding is loaded to 2.91A, No damage, no hazards.
Supplementary information: Test table is provided to record abnormal and fault conditions for all applicable energy sources including Thermal burn injury. Column "Abnormal/Fault." Specify if test condition by indicating "Abnormal" then the condition for a Clause B.3 test or "Single Fault" then the condition for Clause B.4.								

B.4		TABLE: Fault condition tests							P
Ambient temperature (°C)						See below		—	
Power source for EUT: Manufacturer, model/type, output rating ..:						See table 4.1.2		—	
Component No.	Fault Condition	Supply voltage, (V)	Test time (ms)	Fuse no.	Fuse current, (A)	T-couple	Temp. (°C)	Observation	
BD901 pin1-3	s-c	264	<1 sec	F901	--	--	--	Fuse F901 open instantly, no hazard.	
C902	s-c	264	<1 sec	F901	0.02	--	--	Unit shutdown, no damaged, no hazard.	
U901 pin 3-8 4)	s-c	264	< 1 sec	F901	0.04	--	--	U901 damaged, no hazards.	
U901 pin 2-8 4)	s-c	264	< 1 sec	F901	0.04	--	--	U901 damaged, no hazards.	
U901 pin 6-8 4)	s-c	264	< 1 sec	F901	0.04	--	--	U901 damaged, no hazards.	

IEC 62368-1								
Clause	Requirement + Test				Result - Remark			Verdict
T901 pin 1 to pin 3	s-c	264	5 min	F901	0.02	--	--	Unit shutdown, no damaged, no hazard.
T901 pin 4 to pin 5	s-c	264	5 min	F901	0.02	--	--	Unit shutdown, no damaged, no hazard.
T901 pin 6 to pin 10	s-c	264	5 min	F901	0.02	--	--	Unit shutdown, no damaged, no hazard.
+19V output to earth	s-c	264	5 min	F901	0.02	--	--	Unit shutdown, no damaged, no hazard.
U902 pin 1 - 2	s-c	264	5 min	F901	0.02	--	--	Unit shutdown, no damaged, no hazard.
U902 pin 3 - 4	s-c	264	5 min	F901	0.02	--	--	Unit shutdown, no damaged, no hazard.
U902 pin 1	o-c	264	5 min	F901	0.02	--	--	Unit shutdown, no damaged, no hazard.
U903 Pin 1	o-c	240	10 min	F901	0.02	--	--	Unit shutdown, no damaged, no hazard.
U903 Pin 3	o-c	240	10 min	F901	0.02	--	--	Unit shutdown, no damaged, no hazard.
Q901 pin G-S	s-c	264	5 min	F901	0.02	--	--	Unit shutdown, no damaged, no hazard.
Q901 pin D-G	s-c	264	5 min	F901	0.04	--	--	Q901 damaged, no hazards.
Q901 pin D-S	s-c	264	5 min	F901	0.04	--	--	Q901 damaged, no hazards.
D901	s-c	264	5 min	F901	0.02	--	--	D901 damaged, no hazards.
R927	s-c	264	5 min	F901	0.02	--	--	Unit shutdown, no damaged, no hazard.
R915	s-c	264	5 min	F901	0.02	--	--	Unit shutdown, no damaged, no hazard.

IEC 62368-1								
Clause	Requirement + Test				Result - Remark			Verdict
R923	s-c	264	5 min	F901	0.02	--	--	Unit shutdown, no damaged, no hazard.
L801	s-c	264	5 min	F901	0.02	--	--	Unit shutdown, no damaged, no hazard.
Supplementary information: S-C=short circuit, O-C=open circuit. *) Fuse current is more than fuse rating times 2.1, repeated the test with each source of fuse and same result come out.								

Annex M	TABLE: Batteries								N/A
The tests of Annex M are applicable only when appropriate battery data is not available									
Is it possible to install the battery in a reverse polarity position?..... :									
	Non-rechargeable batteries			Rechargeable batteries					
	Discharging		Un-intentional charging	Charging		Discharging		Reversed charging	
	Meas. current	Manuf. Specs.		Meas. current	Manuf. Specs.	Meas. current	Manuf. Specs.	Meas. current	Manuf. Specs.
Max. current during normal condition									
Max. current during fault condition									
Test results:									
- Chemical leaks								Verdict	
- Explosion of the battery									
- Emission of flame or expulsion of molten metal									
- Electric strength tests of equipment after completion of tests									
Supplementary information:									

Annex M.4	Table: Additional safeguards for equipment containing secondary lithium batteries						N/A
Battery/Cell No.	Test conditions	Measurements			Observation		
		U	I (A)	Temp (C)			
	Normal						
	Abnormal						
	Single fault –SC/OC						
	Normal						

IEC 62368-1					
Clause	Requirement + Test			Result - Remark	Verdict
	Abnormal				
	Single fault – SC/OC				
Supplementary Information:					
Battery identification	Charging at T_{lowest} (°C)	Observation	Charging at T_{highest} (°C)	Observation	
Supplementary Information:					

Annex Q.1	TABLE: Circuits intended for interconnection with building wiring (LPS)					P
Note: Measured UOC (V) with all load circuits disconnected:						
Output Circuit	Components	U _{oc} (V)	I _{sc} (A)		S (VA)	
			Meas.	Limit	Meas.	Limit
Power board output	Normal condition	19.4	4.14	51.5	77.7	250
Tested on main board 715GB201						
HDMI (CN501) pin 18 to GND	Normal condition	5.0	0 (can't loaded)	8	0 (can't loaded)	100
HDMI (CN501) others pins to GND	Normal condition	0 (can't loaded)	0 (can't loaded)	8	0 (can't loaded)	100
HDMI (CN502) pin 18 to GND	Normal condition	5.0	0 (can't loaded)	8	0 (can't loaded)	100
HDMI (CN502) others pins to GND	Normal condition	0 (can't loaded)	0 (can't loaded)	8	0 (can't loaded)	100
VGA (CN101) pin 12,15 to GND	Normal condition	4.6	0 (can't loaded)	8	0 (can't loaded)	100
VGA (CN101) others pins to GND	Normal condition	0 (can't loaded)	0 (can't loaded)	8	0 (can't loaded)	100
DP (CN503) pin 20 to GND	Normal condition	3.3	1.4	8	4.2	100
DP (CN503) pin 20 to GND	U545 PIN 3-4 SC	3.3	1.8	8	5.3	100

IEC 62368-1						
Clause	Requirement + Test			Result - Remark		Verdict
DP (CN503) pin 20 to GND	U541 PIN 3-2 SC	5.0	1.4	8	5.9	100
DP (CN503) others pins to GND	Normal condition	0 (can't loaded)	0 (can't loaded)	8	0 (can't loaded)	100
Tested on main board 715GA531						
HDMI (CN501) pin 18 to GND	Normal condition	5.0	0 (can't loaded)	8	0 (can't loaded)	100
HDMI (CN501) others pins to GND	Normal condition	0 (can't loaded)	0 (can't loaded)	8	0 (can't loaded)	100
HDMI (CN502) pin 18 to GND	Normal condition	5.0	0 (can't loaded)	8	0 (can't loaded)	100
HDMI (CN502) others pins to GND	Normal condition	0 (can't loaded)	0 (can't loaded)	8	0 (can't loaded)	100
VGA (CN101) pin 12,15 to GND	Normal condition	4.7	0 (can't loaded)	8	0 (can't loaded)	100
VGA (CN101) others pins to GND	Normal condition	0 (can't loaded)	0 (can't loaded)	8	0 (can't loaded)	100
DP (CN503) pin 20 to GND	Normal condition	3.3	1.4	8	4.1	100
DP (CN503) pin 20 to GND	U545 PIN 3-4 SC	3.3	1.8	8	5.3	100
DP (CN503) pin 20 to GND	U541 PIN 3-2 SC	5.0	1.4	8	5.9	100
DP (CN503) others pins to GND	Normal condition	0 (can't loaded)	0 (can't loaded)	8	0 (can't loaded)	100
Supplementary information:						
1) Input Voltage is 264Vac, 60Hz. s-c=Short circuit, o-c=Open circuit.						
2) +19V output supplied to main board was protected by fuses F902 on secondary corcuit that will break the circuit within 120 s with a current equal to 210 %. The fuse was bypassed during test.						

IEC 62368-1					
Clause	Requirement + Test			Result - Remark	Verdict
T.2, T.3, T.4, T.5	TABLE: Steady force test				P
Part/Location	Material	Thickness (mm)	Force (N)	Test Duration (sec)	Observation
Internal components	--	--	10	5	The clearance and creepage distances do not be reduced below the required values.
External plastic enclosure	See table 4.1.2	See table 4.1.2	250	5	All safeguards remained effective.
Internal metal enclosure	See table 4.1.2	See table 4.1.2	30	5	All safeguards remained effective.
Supplementary information:					

T.6, T.9	TABLE: Impact tests				P
Part/Location	Material	Thickness (mm)	Vertical distance (mm)	Observation	
External plastic enclosure	See table 4.1.2	See table 4.1.2	1300	All safeguards remained effective.	
Supplementary information:					

T.7	TABLE: Drop tests				N/A
Part/Location	Material	Thickness (mm)	Drop Height (mm)	Observation	
Supplementary information:					

T.8	TABLE: Stress relief test				P
Part/Location	Material	Thickness (mm)	Oven Temperature (°C)	Duration (h)	Observation
Whole unit	See table 4.1.2	See table 4.1.2	70	7	All safeguards remained effective.
Supplementary information:					

ATTACHMENT

IEC62368_1B - ATTACHMENT			
Clause	Requirement + Test	Result - Remark	Verdict

ATTACHMENT TO TEST REPORT IEC 62368-1 EUROPEAN GROUP DIFFERENCES AND NATIONAL DIFFERENCES (Audio/video, information and communication technology equipment Part 1: Safety requirements)	
Differences according to.....:	EN 62368-1:2014+A11:2017
Attachment Form No.....:	EU_GD_IEC62368_1B_II
Attachment Originator.....:	Nemko AS
Master Attachment.....:	Date 2017-09-22
Copyright © 2017 IEC System for Conformity Testing and Certification of Electrical Equipment (IECEE), Geneva, Switzerland. All rights reserved.	

	CENELEC COMMON MODIFICATIONS (EN)					—
	Clauses, subclauses, notes, tables, figures and annexes which are additional to those in IEC 62368-1:2014 are prefixed “Z”.					—
CONTENTS	Add the following annexes: Annex ZA (normative) Normative references to international publications with their corresponding European publications Annex ZB (normative) Special national conditions Annex ZC (informative) A-deviations Annex ZD (informative) IEC and CENELEC code designations for flexible cords					P
	Delete all the “country” notes in the reference document (IEC 62368-1:2014) according to the following list:					P
	0.2.1	Note	1	Note 3	4.1.15	Note
	4.7.3	Note 1 and 2	5.2.2.2	Note	5.4.2.3.2.2 Table 13	Note c
	5.4.2.3.2.4	Note 1 and 3	5.4.2.5	Note 2	5.4.5.1	Note
	5.5.2.1	Note	5.5.6	Note	5.6.4.2.1	Note 2 and 3
	5.7.5	Note	5.7.6.1	Note 1 and 2	10.2.1 Table 39	Note 2, 3 and 4
	10.5.3	Note 2	10.6.2.1	Note 3	F.3.3.6	Note 3
	For special national conditions, see Annex ZB.					P
1	Add the following note: NOTE Z1 The use of certain substances in electrical and electronic equipment is restricted within the EU: see Directive 2011/65/EU.			Added.		P
4.Z1	Add the following new subclause after 4.9:			Added.		P

Disclaimer: This document is controlled and has been released electronically.
Only the version on the IECEE Website is the current document version

ATTACHMENT

IEC62368_1B - ATTACHMENT			
Clause	Requirement + Test	Result - Remark	Verdict
	<p>To protect against excessive current, short-circuits and earth faults in circuits connected to an a.c. mains, protective devices shall be included either as integral parts of the equipment or as parts of the building installation, subject to the following, a), b) and c):</p> <p>a) except as detailed in b) and c), protective devices necessary to comply with the requirements of B.3.1 and B.4 shall be included as parts of the equipment;</p> <p>b) for components in series with the mains input to the equipment such as the supply cord, appliance coupler, r.f.i. filter and switch, short-circuit and earth fault protection may be provided by protective devices in the building installation;</p> <p>c) it is permitted for pluggable equipment type B or permanently connected equipment, to rely on dedicated overcurrent and short-circuit protection in the building installation, provided that the means of protection, e.g. fuses or circuit breakers, is fully specified in the installation instructions.</p> <p>If reliance is placed on protection in the building installation, the installation instructions shall so state, except that for pluggable equipment type A the building installation shall be regarded as providing protection in accordance with the rating of the wall socket outlet.</p>		
5.4.2.3.2.4	<p>Add the following to the end of this subclause: The requirement for interconnection with external circuit is in addition given in EN 50491-3:2009.</p>	Added.	N/A
10.2.1	<p>Add the following to ^{c)} and ^{d)} in table 39: For additional requirements, see 10.5.1.</p>	No such radiation from the equipment.	N/A
10.5.1	<p>Add the following after the first paragraph: <i>For RS 1 compliance is checked by measurement under the following conditions:</i> <i>In addition to the normal operating conditions, all controls adjustable from the outside by hand, by any object such as a tool or a coin, and those internal adjustments or presets which are not locked in a reliable manner, are adjusted so as to give maximum radiation whilst maintaining an intelligible picture for 1 h, at the end of which the measurement is made.</i></p> <p>NOTE Z1 Soldered joints and paint lockings are examples of adequate locking.</p> <p><i>The dose-rate is determined by means of a radiation monitor with an effective area of 10 cm²,</i></p>	LED indicator used.	N/A

ATTACHMENT

IEC62368_1B - ATTACHMENT			
Clause	Requirement + Test	Result - Remark	Verdict
	<p><i>at any point 10 cm from the outer surface of the apparatus.</i></p> <p><i>Moreover, the measurement shall be made under fault conditions causing an increase of the high-voltage, provided an intelligible picture is maintained for 1 h, at the end of which the measurement is made.</i></p> <p><i>For RS1, the dose-rate shall not exceed 1 μSv/h taking account of the background level.</i></p> <p>NOTE Z2 These values appear in Directive 96/29/Euratom of 13 May 1996.</p>		
10.6.1	<p>Add the following paragraph to the end of the subclause:</p> <p>EN 71-1:2011, 4.20 and the related tests methods and measurement distances apply.</p>	No such x-radiation generated from the equipment.	N/A
10.Z1	<p>Add the following new subclause after 10.6.5.</p> <p>10.Z1 Non-ionizing radiation from radio frequencies in the range 0 to 300 GHz</p> <p>The amount of non-ionizing radiation is regulated by European Council Recommendation 1999/519/EC of 12 July 1999 on the limitation of exposure of the general public to electromagnetic fields (0 Hz to 300 GHz).</p> <p>For intentional radiators, ICNIRP guidelines should be taken into account for Limiting Exposure to Time-Varying Electric, Magnetic, and Electromagnetic Fields (up to 300 GHz). For hand-held and body-mounted devices, attention is drawn to EN 50360 and EN 50566</p>	No such consideration for the purpose of personal music players.	N/A
G.7.1	<p>Add the following note:</p> <p>NOTE Z1 The harmonized code designations corresponding to the IEC cord types are given in Annex ZD.</p>		P
Bibliography	<p>Add the following standards:</p> <p>Add the following notes for the standards indicated:</p> <p>IEC 60130-9 NOTE Harmonized as EN 60130-9. IEC 60269-2 NOTE Harmonized as HD 60269-2. IEC 60309-1 NOTE Harmonized as EN 60309-1. IEC 60364 NOTE some parts harmonized in HD 384/HD 60364 series. IEC 60601-2-4 NOTE Harmonized as EN 60601-2-4. IEC 60664-5 NOTE Harmonized as EN 60664-5. IEC 61032:1997 NOTE Harmonized as EN 61032:1998 (not modified). IEC 61508-1 NOTE Harmonized as EN 61508-1. IEC 61558-2-1 NOTE Harmonized as EN 61558-2-1. IEC 61558-2-4 NOTE Harmonized as EN 61558-2-4.</p>		P

ATTACHMENT

IEC62368_1B - ATTACHMENT			
Clause	Requirement + Test	Result - Remark	Verdict
	IEC 61558-2-6 NOTE Harmonized as EN 61558-2-6. IEC 61643-1 NOTE Harmonized as EN 61643-1. IEC 61643-21 NOTE Harmonized as EN 61643-21. IEC 61643-311 NOTE Harmonized as EN 61643-311. IEC 61643-321 NOTE Harmonized as EN 61643-321. IEC 61643-331 NOTE Harmonized as EN 61643-331.		
ZB	ANNEX ZB, SPECIAL NATIONAL CONDITIONS (EN)		P
4.1.15	Denmark, Finland, Norway and Sweden To the end of the subclause the following is added: Class I pluggable equipment type A intended for connection to other equipment or a network shall, if safety relies on connection to reliable earthing or if surge suppressors are connected between the network terminals and accessible parts, have a marking stating that the equipment shall be connected to an earthed mains socket-outlet. The marking text in the applicable countries shall be as follows: In Denmark : "Apparatets stikprop skal tilsluttes en stikkontakt med jord som giver forbindelse til stikproppens jord." In Finland : "Laite on liitettävä suojakoskettimilla varustettuun pistorasiaan" In Norway : "Apparatet må tilkoples jordet stikkontakt" In Sweden : "Apparaten skall anslutas till jordat uttag"	See copy of marking plate.	P
4.7.3	United Kingdom To the end of the subclause the following is added: The torque test is performed using a socket-outlet complying with BS 1363, and the plug part shall be assessed to the relevant clauses of BS 1363. Also see Annex G.4.2 of this annex	The equipment is not direct plug-in equipment.	N/A
5.2.2.2	Denmark After the 2nd paragraph add the following: A warning (marking safeguard) for high touch current is required if the touch current exceeds the limits of 3,5 mA a.c. or 10 mA d.c.	No high touch current.	N/A
5.4.11.1 and Annex G	Finland and Sweden To the end of the subclause the following is added: For separation of the telecommunication network from earth the following is applicable:	No TNV circuits.	N/A

ATTACHMENT

IEC62368_1B - ATTACHMENT			
Clause	Requirement + Test	Result - Remark	Verdict
	<p>If this insulation is solid, including insulation forming part of a component, it shall at least consist of either</p> <ul style="list-style-type: none"> • two layers of thin sheet material, each of which shall pass the electric strength test below, or • one layer having a distance through insulation of at least 0,4 mm, which shall pass the electric strength test below. <p>If this insulation forms part of a semiconductor component (e.g. an optocoupler), there is no distance through insulation requirement for the insulation consisting of an insulating compound completely filling the casing, so that clearances and creepage distances do not exist, if the component passes the electric strength test in accordance with the compliance clause below and in addition</p> <ul style="list-style-type: none"> • passes the tests and inspection criteria of 5.4.8 with an electric strength test of 1,5 kV multiplied by 1,6 (the electric strength test of 5.4.9 shall be performed using 1,5 kV), and • is subject to routine testing for electric strength during manufacturing, using a test voltage of 1,5kV. <p>It is permitted to bridge this insulation with a capacitor complying with EN 60384-14:2005, subclass Y2.</p> <p>A capacitor classified Y3 according to EN 60384-14:2005, may bridge this insulation under the following conditions:</p> <ul style="list-style-type: none"> • the insulation requirements are satisfied by having a capacitor classified Y3 as defined by EN 60384-14, which in addition to the Y3 testing, is tested with an impulse test of 2,5 kV defined in 5.4.11; • the additional testing shall be performed on all the test specimens as described in EN 60384-14; the impulse test of 2,5 kV is to be performed before the endurance test in EN 60384-14, in the sequence of tests as described in EN 60384-14. 		
5.5.2.1	<p>Norway</p> <p>After the 3rd paragraph the following is added: Due to the IT power system used, capacitors are required to be rated for the applicable line-to-line voltage (230 V).</p>	Considered.	P
5.5.6	<p>Finland, Norway and Sweden</p>	No such resistors.	N/A

ATTACHMENT

IEC62368_1B - ATTACHMENT			
Clause	Requirement + Test	Result - Remark	Verdict
	To the end of the subclause the following is added: Resistors used as basic safeguard or bridging basic insulation in class I pluggable equipment type A shall comply with G.10.1 and the test of G.10.2.		
5.6.1	Denmark Add to the end of the subclause Due to many existing installations where the socket-outlets can be protected with fuses with higher rating than the rating of the socket-outlets the protection for pluggable equipment type A shall be an integral part of the equipment. <i>Justification:</i> In Denmark an existing 13 A socket outlet can be protected by a 20 A fuse.	Considered.	P
5.6.4.2.1	Ireland and United Kingdom After the indent for pluggable equipment type A , the following is added: – the protective current rating is taken to be 13 A, this being the largest rating of fuse used in the mains plug.	Considered.	P
5.6.5.1	To the second paragraph the following is added: The range of conductor sizes of flexible cords to be accepted by terminals for equipment with a rated current over 10 A and up to and including 13 A is: 1,25 mm ² to 1,5 mm ² in cross-sectional area.	Rated current not exceed 10A.	N/A
5.7.5	Denmark To the end of the subclause the following is added: The installation instruction shall be affixed to the equipment if the protective conductor current exceeds the limits of 3,5 mA a.c. or 10 mA d.c.	No high protective conductor current.	N/A
5.7.6.1	Norway and Sweden To the end of the subclause the following is added: The screen of the television distribution system is normally not earthed at the entrance of the building and there is normally no equipotential bonding system within the building. Therefore the protective earthing of the building installation needs to be isolated from the screen of a cable distribution system. It is however accepted to provide the insulation external to the equipment by an adapter or an interconnection cable with galvanic isolator, which may be provided by a retailer, for example.	Not such system.	N/A

ATTACHMENT

IEC62368_1B - ATTACHMENT			
Clause	Requirement + Test	Result - Remark	Verdict
	<p>The user manual shall then have the following or similar information in Norwegian and Swedish language respectively, depending on in what country the equipment is intended to be used in:</p> <p>“Apparatus connected to the protective earthing of the building installation through the mains connection or through other apparatus with a connection to protective earthing – and to a television distribution system using coaxial cable, may in some circumstances create a fire hazard. Connection to a television distribution system therefore has to be provided through a device providing electrical isolation below a certain frequency range (galvanic isolator, see EN 60728-11)”</p> <p>NOTE In Norway, due to regulation for CATV-installations, and in Sweden, a galvanic isolator shall provide electrical insulation below 5 MHz. The insulation shall withstand a dielectric strength of 1,5 kV r.m.s., 50 Hz or 60 Hz, for 1 min.</p> <p>Translation to Norwegian (the Swedish text will also be accepted in Norway):</p> <p>“Apparater som er koplet til beskyttelsesjord via nettplugg og/eller via annet jordtilkøp utstyr – og er tilkøp et koaksialbasert kabel-TV nett, kan forårsake brannfare. For å unngå dette skal det ved tilkøp av apparater til kabel-TV nett installeres en galvanisk isolator mellom apparatet og kabel-TV nettet.”</p> <p>Translation to Swedish:</p> <p>”Apparater som är kopplad till skyddsjord via jordat vägguttag och/eller via annan utrustning och samtidigt är kopplad till kabel-TV nät kan i vissa fall medföra risk för brand. För att undvika detta skall vid anslutning av apparaten till kabel-TV nät galvanisk isolator finnas mellan apparaten och kabel-TV nätet.”.</p>		
5.7.6.2	<p>Denmark</p> <p>To the end of the subclause the following is added:</p> <p>The warning (marking safeguard) for high touch current is required if the touch current or the protective current exceed the limits of 3,5 mA .</p>	No external circuits.	N/A
B.3.1 and B.4	<p>Ireland and United Kingdom</p> <p>The following is applicable:</p> <p>To protect against excessive currents and short-circuits in the primary circuit of direct plug-in equipment, tests according to Annexes B.3.1 and B.4 shall be conducted using an external miniature</p>	The equipment is not direct plug-in equipment.	N/A

ATTACHMENT

IEC62368_1B - ATTACHMENT			
Clause	Requirement + Test	Result - Remark	Verdict
	<p>circuit breaker complying with EN 60898-1, Type B, rated 32A. If the equipment does not pass these tests, suitable protective devices shall be included as an integral part of the direct plug-in equipment, until the requirements of Annexes B.3.1 and B.4 are met</p>		
G.4.2	<p>Denmark</p> <p>To the end of the subclause the following is added:</p> <p>Supply cords of single phase appliances having a rated current not exceeding 13 A shall be provided with a plug according to DS 60884-2-D1:2011.</p> <p>CLASS I EQUIPMENT provided with socket-outlets with earth contacts or which are intended to be used in locations where protection against indirect contact is required according to the wiring rules shall be provided with a plug in accordance with standard sheet DK 2-1a or DK 2-5a.</p> <p>If a single-phase equipment having a RATED CURRENT exceeding 13 A or if a poly-phase equipment is provided with a supply cord with a plug, this plug shall be in accordance with the standard sheets DK 6-1a in DS 60884-2-D1 or EN 60309-2.</p> <p>Mains socket outlets intended for providing power to Class II apparatus with a rated current of 2,5 A shall be in accordance DS 60884-2-D1:2011 standard sheet DKA 1-4a.</p> <p>Other current rating socket outlets shall be in compliance with Standard Sheet DKA 1-3a or DKA 1-1c.</p> <p>Mains socket-outlets with earth shall be in compliance with DS 60884-2-D1:2011 Standard Sheet DK 1-3a, DK 1-1c, DK1-1d, DK 1-5a or DK 1-7a</p> <p><i>Justification:</i> Heavy Current Regulations, Section 6c</p>	No power supply cord provided.	N/A
G.4.2	<p>United Kingdom</p> <p>To the end of the subclause the following is added:</p> <p>The plug part of direct plug-in equipment shall be assessed to BS 1363: Part 1, 12.1, 12.2, 12.3, 12.9, 12.11, 12.12, 12.13, 12.16, and 12.17, except that the test of 12.17 is performed at not less than 125 °C. Where the metal earth pin is replaced by an Insulated Shutter Opening Device (ISOD), the requirements of clauses 22.2 and 23 also apply.</p>	The equipment is not direct plug-in equipment.	N/A
G.7.1	<p>United Kingdom</p> <p>To the first paragraph the following is added:</p>	No power supply cord provided.	N/A

ATTACHMENT

IEC62368_1B - ATTACHMENT			
Clause	Requirement + Test	Result - Remark	Verdict
	<p>Equipment which is fitted with a flexible cable or cord and is designed to be connected to a mains socket conforming to BS 1363 by means of that flexible cable or cord shall be fitted with a 'standard plug' in accordance with the Plugs and Sockets etc (Safety) Regulations 1994, Statutory Instrument 1994 No. 1768, unless exempted by those regulations.</p> <p>NOTE "Standard plug" is defined in SI 1768:1994 and essentially means an approved plug conforming to BS 1363 or an approved conversion plug.</p>		
G.7.1	<p>Ireland</p> <p>To the first paragraph the following is added: Apparatus which is fitted with a flexible cable or cord shall be provided with a plug in accordance with Statutory Instrument 525: 1997, "13 A Plugs and Conversion Adapters for Domestic Use Regulations: 1997. S.I. 525 provides for the recognition of a standard of another Member State which is equivalent to the relevant Irish Standard</p>	No power supply cord provided.	N/A
G.7.2	<p>Ireland and United Kingdom</p> <p>To the first paragraph the following is added: A power supply cord with a conductor of 1,25 mm² is allowed for equipment which is rated over 10 A and up to and including 13 A.</p>	No power supply cord provided.	N/A
ZC	ANNEX ZC, NATIONAL DEVIATIONS (EN)		P
10.5.2	<p>Germany</p> <p>The following requirement applies: For the operation of any cathode ray tube intended for the display of visual images operating at an acceleration voltage exceeding 40 kV, authorization is required, or application of type approval (Bauartzulassung) and marking.</p> <p><i>Justification:</i> German ministerial decree against ionizing radiation (Röntgenverordnung), in force since 2002-07-01, implementing the European Directive 96/29/EURATOM.</p> <p>NOTE Contact address: Physikalisch-Technische Bundesanstalt, Bundesallee 100, D-38116 Braunschweig, Tel.: Int +49-531-592-6320, Internet: http://www.ptb.de</p>	No CRT within the equipment.	N/A

ATTACHMENT

IEC62368_1B - ATTACHMENT			
Clause	Requirement + Test	Result - Remark	Verdict

IEC62368_1B - ATTACHMENT			
Clause	Requirement + Test	Result - Remark	Verdict

ATTACHMENT TO TEST REPORT IEC 62368-1 DENMARK NATIONAL DIFFERENCES Audio/video, information and communication technology equipment – Part 1: Safety requirements	
Differences according to.....	DS/EN 62368-1:2014
Attachment Form No.....	DK_ND_IEC62368_1B
Attachment Originator	UL (Demko)
Master Attachment	2014-10
Copyright © 2014 IEC System for Conformity Testing and Certification of Electrical Equipment (IECEE), Geneva, Switzerland. All rights reserved.	

	National Differences		—
4.1.15	<p>To the end of the subclause the following is added:</p> <p>Class I pluggable equipment type A intended for connection to other equipment or a network shall, if safety relies on connection to reliable earthing or if surge suppressors are connected between the network terminals and accessible parts, have a marking stating that the equipment shall be connected to an earthed mains socket-outlet.</p> <p>The marking text in the applicable countries shall be as follows:</p> <p>“Apparatets stikprop skal tilsluttes en stikkontakt med jord som giver forbindelse til stikproppens jord.”</p>	<p>Added.</p> <p>See copy of marking plate.</p>	P
5.2.2.2	<p>After the 2nd paragraph add the following:</p> <p>A warning (marking safeguard) for high touch current is required if the touch current exceeds the limits of 3,5 mA a.c. or 10 mA d.c.</p>	Added.	N/A
5.6.1	<p>Add to the end of the subclause:</p> <p>Due to many existing installations where the socket-outlets can be protected with fuses with higher rating than the rating of the socket-outlets the protection for pluggable equipment type A shall be an integral part of the equipment.</p> <p>Justification:</p> <p>In Denmark an existing 13 A socket outlet can be protected by a 20 A fuse.</p>	Added. No socket outlet is provided.	N/A
5.7.5	<p>To the end of the subclause the following is added:</p> <p>The installation instruction shall be affixed to the equipment if the protective conductor current exceeds the limits of 3,5 mA a.c. or 10 mA d.c.</p>	Added.	N/A

IEC62368_1B - ATTACHMENT			
Clause	Requirement + Test	Result - Remark	Verdict
5.7.6.2	<p>To the end of the subclause the following is added:</p> <p>The warning (marking safeguard) for high touch current is required if the touch current or the protective current exceed the limits of 3,5 mA.</p>	Added.	N/A
G.4.2	<p>To the end of the subclause the following is added:</p> <p>Supply cords of single phase appliances having a rated current not exceeding 13 A shall be provided with a plug according to DS 60884-2-D1:2011.</p> <p>CLASS I EQUIPMENT provided with socket-outlets with earth contacts or which are intended to be used in locations where protection against indirect contact is required according to the wiring rules shall be provided with a plug in accordance with standard sheet DK 2-1a or DK 2-5a.</p> <p>If a single-phase equipment having a RATED CURRENT exceeding 13 A or if a poly-phase equipment is provided with a supply cord with a plug, this plug shall be in accordance with the standard sheets DK 6-1a in DS 60884-2-D1 or EN 60309-2.</p> <p>Mains socket outlets intended for providing power to Class II apparatus with a rated current of 2,5 A shall be in accordance DS 60884-2-D1:2011 standard sheet DKA 1-4a.</p> <p>Other current rating socket outlets shall be in compliance with Standard Sheet DKA 1-3a or DKA 1-1c.</p> <p>Mains socket-outlets with earth shall be in compliance with DS 60884-2-D1:2011 Standard Sheet DK 1-3a, DK 1-1c, DK1-1d, DK 1-5a or DK 1-7a</p> <p>Justification: Heavy Current Regulations, Section 6c</p>	Added.	N/A

IEC62368_1B - ATTACHMENT			
Clause	Requirement + Test	Result - Remark	Verdict

ATTACHMENT TO TEST REPORT IEC 62368-1 2th Ed. U.S.A. NATIONAL DIFFERENCES Audio/video, information and communication technology equipment – Part 1: Safety requirements	
Differences according to:	CSA/UL 62368-1:2014
Attachment Form No.:	US&CA_ND_IEC623681B
Attachment Originator	UL(US)
Master Attachment	Date 2015-06
Copyright © 2015 IEC System for Conformity Testing and Certification of Electrical Equipment (IECEE), Geneva, Switzerland. All rights reserved.	

IEC 62368-1 - US and Canadian National Differences Special National Conditions based on Regulations and Other National Differences			
1.1	All equipment is to be designed to allow installation according to the National Electrical Code (NEC), ANSI/NFPA 70, the Canadian Electrical Code (CEC), Part I, CAN/CSA C22.1, and when applicable, the National Electrical Safety Code, IEEE C2. Also, for such equipment marked or otherwise identified, installation is allowed per the Standard for the Protection of Information Technology Equipment, ANSI/NFPA 75.	In accordance with the National Electrical Code (NEC) and the Canadian Electrical Code (CEC) part 1 CAN/CSA C22.1, ANSI/NFPA 70, and unless marked or otherwise identified, the Standard for Electronic Computer/Data-Processing Equipment, ANSI/NFPA 75.	P
1.4	Additional requirements apply to some forms of power distribution equipment, including sub-assemblies.	Considered.	P
4.1.17	For lengths exceeding 3.05 m, external interconnecting flexible cord and cable assemblies are required to be a suitable cable type (e.g., DP, CL2) specified in the NEC.	Not exceeding 3.05 m.	N/A
	For lengths 3.05 m or less, external interconnecting flexible cord and cable assemblies that are not types specified in the NEC generally are required to have special construction features and identification markings.	Overall acceptance shall be evaluated during the national approval.	N/A
4.8	Lithium coin / button cell batteries have modified special construction and performance requirements.	No such batteries.	N/A
5.6.3	Protective earthing conductors comply with the minimum conductor sizes in Table G.5, except as required by Table G.7ADV.1 for cord connected equipment, or Annex DVH for permanently connected equipment	An appliance inlet provided that is connected by an approved appliance coupler serves as main protective earthing terminal. No power supply cord provided.	N/A
5.7.7	Equipment intended to receive telecommunication ringing signals complies with a special touch current measurement tests.	No TNV circuits within the equipment.	N/A

IEC62368_1B - ATTACHMENT			
Clause	Requirement + Test	Result - Remark	Verdict
6.5.1	PS3 wiring outside a fire enclosure complies with single fault testing in B.4, or be current limited per one of the permitted methods.	No such parts.	N/A
Annex F (F.3.3.8)	Output terminals provided for supply of other equipment, except mains, supply are marked with a maximum rating or references to which equipment it is permitted to be connected.	No DC output connector is provided.	N/A
Annex G (G.7.1)	Permanent connection of equipment to the mains supply by a power supply cord is not permitted, except for certain equipment, such as ATMs.	The equipment is not permanent connection equipment.	N/A
Annex G (G.7.3)	Power supply cords are required to have attachment plugs rated not less than 125 percent of the rated current of the equipment.	No power supply cord provided.	N/A
	Flexible power supply cords are required to be compatible with Article 400 of the NEC, and Tables 11 and 12 of the CEC.	See above.	N/A
Annex G (G.7.5)	Minimum cord length is required to be 1.5 m, with certain constructions such as external power supplies allowed to consider both input and output cord lengths into the requirement. Power supply cords are required to be no longer than 4.5 m in length if used in ITE Rooms.	See above.	N/A
Annex H.2	Continuous ringing signals under normal operating conditions up to 16 mA only are permitted if the equipment is subjected to special installation and performance restrictions.	No TNV circuits within the equipment.	N/A
Annex H.4	For circuits with other than ringing signals and with voltages exceeding 42.4 V _{peak} or 60 V d.c., the maximum acceptable current through a 2000 ohm resistor (or greater) connected across the voltage source with other loads disconnected is 7.1 mA peak or 30 mA d.c. under normal operating conditions.	No TNV circuits within the equipment.	N/A
Annex M	Battery packs for stationary applications comply with special component requirements.	No such parts.	N/A
Annex DVA (1)	Equipment intended for use in spaces used for environmental air are subjected to special flammability requirements for heat and visible smoke release.	The equipment not intended to be used within such environments.	N/A
	For ITE room applications, automated information storage systems with combustible media greater than 0.76 m ³ (27 cu ft) have a provision for connection of either automatic sprinklers or a gaseous agent extinguishing system with an extended discharge.	Not such equipment.	N/A
	Consumer products designed or intended primarily for children 12 years of age or younger are subject to additional requirements in accordance with U.S. & Canadian Regulations.	The equipment is not for children used.	N/A

IEC62368_1B - ATTACHMENT			
Clause	Requirement + Test	Result - Remark	Verdict
	Baby monitors additionally comply with ASTM F2951, Consumer Safety Specification for Baby Monitors.	Not a baby monitors.	N/A
Annex DVA (5.6.3)	For Pluggable Equipment Type A, the protection in the installation is assumed to be 20A.	Considered.	P
Annex DVA (6.3)	The maximum quantity of flammable liquid stored in equipment complies with NFPA 30.	No flammable liquids within the equipment.	N/A
Annex DVA (6.4.8)	For ITE room applications, enclosures with combustible material measuring greater than 0.9 m ² (10 sq ft) or a single dimension greater than 1.8 m (6 ft) have a flame spread rating of 50 or less. For equipment with the same dimensions for other applications, an external surface that is not a fire enclosure requires a min. flammability classification of V-1.	No such application.	N/A
Annex DVA (10.3.1)	Equipment with lasers meets the U.S. Code of Federal Regulations 21 CFR 1040 (and the Canadian Radiation Emitting Devices Act, REDR C1370).	No such parts.	N/A
Annex DVA (10.5.1)	Equipment that produces ionizing radiation complies with the U.S. Code of Federal Regulations, 21 CFR 1020 (and the Canadian Radiation Emitting Devices Act, REDR C1370).	No such parts.	N/A
Annex DVA (F.3.3.3)	Equipment for use on a.c. mains supply systems with a neutral and more than one phase conductor (e.g. 120/240 V, 3-wire) require a special marking format for electrical ratings. Additional considerations apply for voltage ratings that exceed the attachment cap rating or are lower than the "Normal Operating Condition" in Table 2 of CAN/CSA C22.2 No. 235."	Single phase only.	N/A
Annex DVA (F.3.3.5)	Equipment identified for ITE (computer) room installation is marked with the rated current	Not such application.	N/A
Annex DVA (G.1)	Vertically-mounted disconnect switches and circuit breakers have the "on" position indicated by the handle in the up position	No such parts.	N/A
Annex DVA (G.3.4)	Suitable NEC/CEC branch circuit protection rated at the maximum circuit rating is required for all standard supply outlets and receptacles (such as supplied in power distribution units) if the supply branch circuit protection is not suitable.	No standard supply outlets, receptacles, medium-base or smaller lampholders provided.	N/A
Annex DVA (G.4.2)	Equipment with isolated ground (earthing) receptacles complies with NEC 250.146(D) and CEC 10-112 and 10-906(8).	No such parts.	N/A
Annex DVA (G.4.3)	Where a fuse is used to provide Class 2 or Class 3 current limiting, it is not operator-accessible unless it is non- interchangeable.	No such parts.	N/A

IEC62368_1B - ATTACHMENT			
Clause	Requirement + Test	Result - Remark	Verdict
Annex DVA (G.5.3)	Power distribution transformers distributing power at 100 volts or more, and rated 10 kVA or more, require special transformer overcurrent protection.	No such parts.	N/A
Annex DVA (G.5.4)	Motor control devices are required for cord-connected equipment with a mains-connected motor if the equipment is rated more than 12 A, or if the equipment has a nominal voltage rating greater than 120 V, or if the motor is rated more than 1/3 hp (locked rotor current over 43 A).	No such parts.	N/A
Annex DVA (Annex M)	For ITE room applications, equipment with battery systems capable of supplying 750 VA for five minutes have a battery disconnect means that may be connected to the ITE room remote power-off circuit.	Not such application.	N/A
Annex DVA (Q)	Wiring terminals intended to supply Class 2 outputs according to the NEC or CEC Part 1 are marked with the voltage rating and "Class 2" or equivalent; marking is located adjacent to the terminals and visible during wiring.	Not applicable for the equipment.	N/A
Annex DVB (1)	Additional requirements apply for equipment used for entertainment purposes intended for installation in general patient care areas of health care facilities.	Not such application.	N/A
Annex DVC (1)	Additional requirements apply for equipment intended for mounting under kitchen cabinets.	Not such application.	N/A
Annex DVE (4.1.1)	Some equipment, components, sub-assemblies and materials associated with the risk of fire, electric shock, or personal injury have component or material ratings in accordance with the applicable national (U.S. and Canadian) component or material requirements. Components required to comply include: appliance couplers, attachment plugs, battery back-up systems, battery packs, circuit breakers, communication circuit accessories, connectors (used for current interruption of non-LPS circuits), power supply cords, direct plug-in equipment, electrochemical capacitor modules (energy storage modules with ultra-capacitors), enclosures (outdoor), flexible cords and cables, fuses (branch circuit), ground-fault current interrupters, interconnecting cables, data storage equipment, printed wiring, protectors for communications circuits, receptacles, surge protective devices, vehicle battery adapters, wire connectors, and wire and cables.	UL approved components used. Refer to table 4.1.2 of IEC 62368-1 test report for details.	P
Annex DVH	Equipment for permanent connection to the mains supply is subjected to additional requirements.	The equipment is not permanently connected equipment.	N/A

IEC62368_1B - ATTACHMENT			
Clause	Requirement + Test	Result - Remark	Verdict
Annex DVH (DVH.1)	Wiring methods (terminals, leads, etc.) used for the connection of the equipment to the mains are in accordance with the NEC/CEC.	Pluggable equipment type A.	N/A
Annex DVH (DVH.3.2)	Terminals for permanent wiring, including protective earthing terminals, are suitable for U.S./Canadian wire gauge sizes, rated 125 percent of the equipment rating, and are specially marked when specified.	No terminals for permanent wiring.	N/A
Annex DVH (DVH.3.2)	Wire binding screws are not permitted to attach conductors larger than 10 AWG (5.3 mm ²).	No wire binding screws.	N/A
Annex DVH (DVH.4)	Permanently connected equipment is required to have a suitable wiring compartment and wire bending space.	The equipment is not permanently connected equipment.	N/A
Annex DVH (DVH 5.5)	Equipment connected to a centralized d.c. power system, and having one pole of the DC mains input terminal connected to the main protective earthing terminal in the equipment, complies with special earthing, wiring, marking and installation instruction requirements.	The equipment not connected to a centralized d.c. power system.	N/A
Annex DVI (6.7)	Equipment intended for connection to telecommunication network outside plant cable is required to be protected against overvoltage from power line crosses.	No TNV circuits within the equipment.	N/A
Annex DVJ (10.6.1)	Equipment connected to a telecommunication and cable distribution networks and supplied with an earphone intended to be held against, or in the ear is required to comply with special acoustic pressure requirements.	No TNV circuits within the equipment.	N/A

IEC 62368_1B ATTACHMENT			
Clause	Requirement + Test	Result - Remark	Verdict

ATTACHMENT TO TEST REPORT
 IEC 62368-1
 (AUSTRALIA / NEW ZEALAND) NATIONAL DIFFERENCES
 (Audio/video, information and communication technology equipment)

Differences according to	AS/NZS 62368.1:2018
Attachment Form No.	AU_NZ_ND_IEC62368_1B
Attachment Originator	JAS-ANZ
Master Attachment	2019-02-04

Copyright © 2019 IEC System for Conformity Testing and Certification of Electrical Equipment (IECEE), Geneva, Switzerland. All rights reserved.

	National Differences	—	
Appendix ZZ	Variations to IEC 62368-1:2014 (ED. 2.0) for Australia and New Zealand	P	
ZZ1 Scope	This Appendix lists the normative variations to IEC 62368-1:2014 (ED. 2.0)	P	
ZZ2 Variations	The following modifications are required for Australian/New Zealand conditions:	P	
2	<p>Add the following to the list of normative references:</p> <p>The following normative documents are referenced in Appendix ZZ:</p> <ul style="list-style-type: none"> -AS/NZS 3112, <i>Approval and test specification—Plugs and socket-outlets</i> -AS/NZS 3123, <i>Approval and test specification—Plugs, socket-outlets and couplers for general industrial application</i> -AS/NZS 3191, <i>Electric flexible cords</i> -AS/NZS 60065, <i>Audio, video and similar electronic apparatus—Safety requirements (IEC 60065:2015 (ED.8.0) MOD)</i> -AS/NZS 60320.1, <i>Appliance couplers for household and similar general purposes, Part 1: General requirements (IEC 60320-1, Ed.2.1 (2007) MOD)</i> -AS/NZS 60320.2.2, <i>Appliance couplers for household and similar general purposes Part 2.2: Interconnection couplers for household and similar equipment (IEC 60320-2-2, Ed.2.0 (1998) MOD)</i> -AS/NZS 60695.2.11, <i>Fire hazard testing, Part 2.11: Glowing/hot wire based test methods—Glow-wire flammability test method for end-products</i> -AS/NZS 60695.11.5, <i>Fire hazard testing, Part 11.5: Test flames—Needle-flame test method—Apparatus, confirmatory test arrangement and guidance</i> 	<p>Added.</p>	P

IEC 62368_1B ATTACHMENT			
Clause	Requirement + Test	Result - Remark	Verdict
	<p>-AS/NZS 60695.11.10, <i>Fire hazard testing, Part 11.10: Test flames—50 W horizontal and vertical flame test methods</i></p> <p>-AS/NZS 60884.1, <i>Plugs and socket-outlets for household and similar purposes, Part 1: General requirements</i></p> <p>-AS/NZS 60950.1:2015, <i>Information technology equipment—Safety, Part 1: General requirements (IEC 60950-1, Ed.2.2 (2013), MOD)</i></p> <p>IEC 61032:1997, <i>Protection of persons and equipment by enclosures—Probes for verification</i></p> <p>-AS/NZS 61558.1:2008 (including Amendment 2:2015), <i>Safety of Power Transformers, Power Supplies, Reactors and Similar Products, Part 1: General requirements and tests (IEC 61558-1 Ed 2.1, MOD)</i></p> <p>-AS/NZS 61558.2.16, <i>Safety of transformers, reactors, power supply units and similar products for voltages up to 1 100 V, Part 2.16: Particular requirements and tests for switch mode power supply units and transformers for switch mode power supply units.</i></p>		
4.1.1	<p>Application of requirements and acceptance of materials, components and subassemblies</p> <p>1 <i>Replace</i> the text ‘IEC 60950-1’ with ‘AS/NZS 60950.1:2015’.</p> <p>2 <i>Replace</i> the text ‘IEC 60065’ with ‘AS/NZS 60065’.</p>	Replaced.	P
4.7	Equipment for direct insertion into mains socket-outlets		N/A
4.7.2	<p>Requirements</p> <p><i>Delete</i> the text of the second paragraph and <i>replace</i> with the following:</p> <p>Equipment with a plug portion, suitable for insertion into a 10 A 3-pin flat-pin socket-outlet complying with AS/NZS 3112 shall comply with the requirements in AS/NZS 3112 for equipment with integral pins for insertion into socket-outlets.</p>	Deleted.	N/A
4.7.3	<p>Compliance Criteria</p> <p><i>Delete</i> the first paragraph and Note 1 and Note 2 and <i>replace</i> with the following:</p> <p><i>Compliance is checked by inspection and, if necessary, by the tests in AS/NZS 3112.</i></p>	Deleted.	N/A
4.8	<p><i>Delete</i> existing clause title and <i>replace</i> with the following:</p> <p>4.8 Products containing coin/button cell batteries</p>		N/A

IEC 62368_1B ATTACHMENT			
Clause	Requirement + Test	Result - Remark	Verdict
4.8.1	<p>General</p> <p>1 Second dashed point, <i>delete</i> the text and <i>replace</i> with the following: – include coin/button cell batteries with a diameter of 32 mm or less.</p> <p>2 After the second dashed point, <i>insert</i> the following Note: NOTE 1: Batteries are specified in IEC 60086-2.</p> <p>3 After the third dashed point, <i>renumber</i> the existing Note as 'NOTE 2'.</p> <p>4 Fifth dashed point, <i>delete</i> the word 'lithium'.</p>		N/A
4.8.2	<p>Instructional Safeguard</p> <p>First line, <i>delete</i> the word 'lithium'.</p>		N/A
4.8.3	<p>Construction</p> <p>First line, after the word 'Equipment' <i>insert</i> the words 'containing one or more coin/button batteries and'</p>		N/A
4.8.5	<p>Compliance criteria</p> <p><i>Delete</i> the first paragraph and <i>replace</i> with the following: <i>Compliance is checked by applying a force of 30 N +/-1 N for 10 s to the battery compartment door/cover by a rigid test finger according to test probe 11 of IEC 61032:1997 at the most unfavourable place and in the most unfavourable direction. The force shall be applied in one direction at a time.</i></p>	Deleted.	N/A
5.4.10.2	Test methods		N/A
5.4.10.2.1	<p>General</p> <p><i>Delete</i> the first paragraph and <i>replace</i> with the following: In Australia only, the separation is checked by the test of both Clause 5.4.10.2.2 and Clause 5.4.10.2.3. In New Zealand, the separation is checked by the test of either Clause 5.4.10.2.2 or Clause 5.4.10.2.3.</p>	Deleted.	N/A
Table 29	<i>Replace</i> the table with the following:		N/A

IEC 62368_1B ATTACHMENT

Clause	Requirement + Test	Result - Remark	Verdict																
Parts	<table border="1"> <thead> <tr> <th colspan="2">Impulse test</th> <th colspan="2">Steady state test</th> </tr> <tr> <th>New Zealand</th> <th>Australia</th> <th>New Zealand</th> <th>Australia</th> </tr> </thead> <tbody> <tr> <td>Parts indicated in Clause 5.4.10.1 a) ^a</td> <td>2.5 kV 10/700 μs</td> <td>7.0 kV for hand-held telephones and headsets, 2.5 kV for other equipment. 10/700 μs</td> <td>1.5 kV 3 kV</td> </tr> <tr> <td>Parts indicated in Clause 5.4.10.1 b) and c) ^b</td> <td colspan="2">1.5 kV 10/700 μs ^c</td> <td>1.0 kV 1.5 kV</td> </tr> </tbody> </table>		Impulse test		Steady state test		New Zealand	Australia	New Zealand	Australia	Parts indicated in Clause 5.4.10.1 a) ^a	2.5 kV 10/700 μs	7.0 kV for hand-held telephones and headsets, 2.5 kV for other equipment. 10/700 μs	1.5 kV 3 kV	Parts indicated in Clause 5.4.10.1 b) and c) ^b	1.5 kV 10/700 μs ^c		1.0 kV 1.5 kV	
Impulse test		Steady state test																	
New Zealand	Australia	New Zealand	Australia																
Parts indicated in Clause 5.4.10.1 a) ^a	2.5 kV 10/700 μs	7.0 kV for hand-held telephones and headsets, 2.5 kV for other equipment. 10/700 μs	1.5 kV 3 kV																
Parts indicated in Clause 5.4.10.1 b) and c) ^b	1.5 kV 10/700 μs ^c		1.0 kV 1.5 kV																
<p>^a Surge suppressors shall not be removed.</p> <p>^b Surge suppressors may be removed, provided that such devices pass the impulse test of Clause 5.4.10.2.2 when tested as components outside the equipment.</p> <p>^c During this test, it is allowed for a surge suppressor to operate and for a sparkover to occur in a GDT.</p>																			
5.4.10.2.2	After the first paragraph, <i>insert</i> new Notes 201 and 202 as follows: NOTE 201 For Australia, the 7 kV impulse simulates lightning surges on typical rural and semi-rural network lines. NOTE 202 For Australia, the value of 2.5 kV for Clause 5.4.10.1 a) was chosen to ensure the adequacy of the insulation concerned and does not necessarily simulate likely overvoltages.		N/A																
5.4.10.2.3	After the first paragraph, <i>insert</i> new Notes 201 and 202 as follows: NOTE 201 For Australia, where there are capacitors across the insulation under test, it is recommended that d.c. test voltages are used. NOTE 202 The 3 kV and 1.5 kV values for Australia have been determined considering the low frequency induced voltages from the power supply distribution system.		N/A																
6	Electrically-caused fire		P																
6.1	General After the first paragraph, <i>insert</i> the following new paragraph: Alternatively, the requirements of Clauses 6.2 to 6.5.2 are considered to be fulfilled if the equipment complies with the requirements of Clause 6.202	Added.	P																
6.6	After Clause 6.6, <i>add</i> the new Clauses 6.201 and 6.202 as follows: 6.201 External power supplies, docking stations and other similar devices and 6.202 Resistance to fire—Alternative tests (see special national conditions)		N/A																
8.5.4	Special categories of equipment comprising moving parts		N/A																

IEC 62368_1B ATTACHMENT			
Clause	Requirement + Test	Result - Remark	Verdict
8.5.4.1	Large data storage equipment In the first dashed row and the second dashed rows <i>replace</i> 'IEC 60950-1:2005' with 'AS/NZS 60950.1:2015'.		N/A
8.6	Stability of equipment		P
8.6.1 and Table 36	Requirements 1. Table 36, <i>insert</i> Footnote c at the end of the 'Glass slide' heading, and <i>add</i> a new Footnote c after the text of Footnote b in the last row of Table 36 as follows: c The glass slide test is not applicable to floor standing equipment, even though the equipment may have controls or a display. 2. Table 36, fifth row, <i>insert</i> ²⁰¹ at the end of 'No stability requirements' 3. Table 36, ninth row, <i>insert</i> ²⁰¹ at the end of 'No stability requirements' 4. Table 36, <i>add</i> the following new footnote: ²⁰¹ MS2 and MS3 television sets and display devices, designed only for fixing to a wall, ceiling or equipment rack, are not subjected to stability requirements only if the instructional safeguard of Clause 8.6.1.201 is provided. Otherwise, the glass slide requirements of Clause 8.6.4 and horizontal force requirements of Clause 8.6.5 apply. 5. Second paragraph beneath Table 36, <i>delete</i> the words 'MS2 and MS3 television sets' and <i>replace</i> with 'MS2 and MS3 television sets and display devices'	Considered.	P
8.6.1	After Clause 8.6.1 <i>add</i> the following new clauses: 8.6.1.201 Instructional safeguard for fixed-mount television sets (see special national conditions)	Added. No such equipment.	N/A
Annex F Paragraph F.3.5.1	Mains appliance outlet and socket-outlet markings <i>Replace</i> 'IEC 60320-2-2' with 'AS/NZS 60320.2.2'.	Replaced.	N/A
Annex G Paragraph G.4.2	Mains connectors 1 In the second line <i>insert</i> 'or AS/NZS 3123' after 'IEC 60906-1'. 2 In the second line <i>insert</i> 'or AS/NZS 60320 series' after 'IEC 60320 series' 3 <i>Add</i> the following new paragraph: 10 A or 15 A 250 V flat pin plugs for the connection of equipment to mains-powered socket-outlets for household or similar general use shall comply with AS/NZS 3112 or AS/NZS 60884.1.	Added.	P

IEC 62368_1B ATTACHMENT			
Clause	Requirement + Test	Result - Remark	Verdict
Paragraph G.5.3.1	<p>Transformers, General</p> <p>1 In the third dashed point <i>replace</i> 'IEC 61558-1 and the relevant parts of IEC 61558-2' with 'AS/NZS 61558-1 and the relevant parts of AS/NZS 61558.2'</p> <p>2 In the fourth dashed point <i>replace</i> 'IEC 61558-2-16' with 'AS/NZS 61558.2.16'.</p>	Considered.	P
Paragraph G.7.1	<p>Mains supply cords, General</p> <p>In the fourth dashed paragraph, <i>replace</i> 'IEC 60320-1' with 'AS/NZS 60320.1'</p>	Considered.	P
Table G.5	<p>Sizes of conductors</p> <p>1 In the second row, first column, <i>delete</i> '6' and <i>replace</i> with '7.5'</p> <p>2 In the second row, second column, <i>delete</i> '0,75' and <i>replace</i> with '0.75^b</p> <p>3 <i>Delete</i> Note 1.</p> <p>4 <i>Replace</i> 'NOTE 2' with 'NOTE:'.</p> <p>5 <i>Delete</i> the text of 'Footnote b' and <i>replace</i> with the following: ^b This nominal cross-sectional area is only allowed for Class II appliances if the length of the power supply cord, measured between the point where the cord, or cord guard, enters the appliance, and the entry to the plug does not exceed 2 m (0.5 mm² three-core supply flexible cords are not permitted; see AS/NZS 3191).</p> <p>6 In Footnote c <i>replace</i> 'IEC 60320-1' with 'AS/NZS 60320.1'</p> <p>7 In Footnote d <i>replace</i> 'IEC 60320-1' with 'AS/NZS 60320.1'</p>	Considered.	P
Annex M Paragraph M.3.2	<p>Protection circuits for batteries provided within the equipment, Test method</p> <p>After the first dashed point <i>add</i> the following Note: NOTE 201: In cases where the voltage source is provided by power from an unassociated power source, consideration should be given to the effects of possible single fault conditions in the unassociated equipment. If the power source is unknown then it should be assumed that the maximum limit of SELV may be applied to the source input under assumed single fault conditions in the source when assessing the charging circuit in the equipment under test.</p>	No such construction.	N/A
	Special national conditions (if any)		

IEC 62368_1B ATTACHMENT			
Clause	Requirement + Test	Result - Remark	Verdict
6.201	<p>External power supplies, docking stations and other similar devices</p> <p>For external power supplies, docking stations and other similar devices, during and after abnormal operating conditions and during single fault conditions the output voltage—</p> <ul style="list-style-type: none"> – at all ES1 outlets or connectors shall not increase by more than 10% of its rated output voltage under normal operating condition; and – of a USB outlet or connector shall not increase by more than 3 V or 10% of its rated output voltage under normal operating conditions, whichever is higher. <p>For equipment with multiple rated output voltages, the requirements apply with the equipment configured for each rated output voltage in turn.</p> <p>NOTE: This is intended to reduce the possibility of battery fire or explosion in attached equipment or accessories when charging secondary lithium batteries.</p> <p><i>Compliance shall be checked by measurement, taking into account the abnormal operating conditions of Annex B.3 and the simulated single-fault conditions of Annex B.4</i></p>	Complied.	P
6.202	Resistance to fire—Alternative tests		N/A
6.202.1	<p>General</p> <p>Parts of non-metallic material shall be resistant to ignition and spread of fire.</p> <p>This requirement does not apply to decorative trims, knobs and other parts unlikely to be ignited or to propagate flames from inside the equipment, or the following:</p> <p>a) Components that are contained in an enclosure having a flammability category of V-0 according to AS/NZS 60695.11.10 and having openings only for the connecting wires filling the openings completely, and for ventilation not exceeding 1 mm in width regardless of length.</p> <p>b) The following parts which would contribute negligible fuel to a fire:</p> <ul style="list-style-type: none"> – small mechanical parts, the mass of which does not exceed 4 g, such as mounting parts, gears, cams, belts and bearings; – small electrical components, such as capacitors with a volume not exceeding 1 750 mm³, integrated circuits, transistors and optocoupler packages, if these components are mounted on material of flammability category V-1, or better, 	The alternative method is not used.	N/A

IEC 62368_1B ATTACHMENT			
Clause	Requirement + Test	Result - Remark	Verdict
	<p>according to AS/NZS 60695.11.10.</p> <p>NOTE: In considering how to minimize propagation of fire and what 'small parts' are, account should be taken of the cumulative effect of small parts adjacent to each other for the possible effect of propagating the fire from one part to another.</p>		
	<p><i>Compliance shall be checked by the tests of Clauses 6.202.2, 6.202.3 and 6.202.4.</i></p> <p>For the base material of printed boards, compliance shall be checked by the test of Clause 6.202.5.</p> <p>The tests shall be carried out on parts of non-metallic material which have been removed from the equipment. When the glow-wire test is carried out, the parts shall be placed in the same orientation as they would be in normal use.</p> <p>These tests are not carried out on internal wiring.</p>		N/A
6.202.2	<p>Testing of non-metallic materials</p> <p>Parts of non-metallic material shall be subject to the glow-wire test of AS/NZS 60695.2.11 which shall be carried out at 550°C.</p> <p>Parts for which the glow-wire test cannot be carried out, such as those made of soft or foamy material, shall meet the requirements specified in ISO 9772 for category FH-3 material. The glow-wire test shall be not carried out on parts of material classified at least FH-3 according to ISO 9772 provided that the relevant part is not thinner than the sample tested.</p>		N/A
6.202.3	<p>Testing of insulating materials</p> <p>Parts of insulating material supporting Potential Ignition Sources shall be subject to the glow-wire test of AS/NZS 60695.2.11 which shall be carried out at 750°C.</p> <p>The test shall be also carried out on other parts of insulating material which are within a distance of 3 mm of the connection.</p> <p>NOTE: Contacts in components such as switch contacts are considered to be connections</p>		N/A
	<p>For parts which withstand the glow-wire test but produce a flame, other parts above the connection within the envelope of a vertical cylinder having a diameter of 20 mm and a height of 50 mm shall be subjected to the needle-flame test.</p> <p>However, parts shielded by a barrier which meets the needle-flame test need not be tested</p>		N/A
	<p>The needle-flame test shall be made in accordance with AS/NZS 60695.11.5 with the following modifications:</p>		N/A

IEC 62368_1B ATTACHMENT

Clause	Requirement + Test	Result - Remark	Verdict
--------	--------------------	-----------------	---------

	<p>Clause of AS/NZS 60695.11.5</p>	<p>Change</p>		
	<p>9 Test procedure</p>			
	<p>9.2 Application of needle-flame</p>	<p><i>Delete</i> the first and second paragraphs and <i>replace</i> with the following: The specimen shall be arranged so that the flame can be applied to a vertical or horizontal edge as shown in the examples of Figure 1. If possible the flame shall be applied at least 10 mm from a corner. The duration of application of the test flame shall be 30 s 1 s.</p>		
	<p>9.3 Number of test specimens</p>	<p><i>Replace</i> with the following: The test shall be made on one specimen. If the specimen does not withstand the test, the test may be repeated on two further specimens, both of which shall withstand the test.</p>		
	<p>11 Evaluation of test results</p>	<p><i>Replace</i> with the following: The duration of burning (tb) shall not exceed 30 s. However, for printed circuit boards, it shall not exceed 15 s.</p>		
	<p>The needle-flame test shall not be carried out on parts of material classified as V-0 or V-1 according to AS/NZS 60695.11.10, provided that the relevant part is not thinner than</p>			

IEC 62368_1B ATTACHMENT			
Clause	Requirement + Test	Result - Remark	Verdict
	the sample tested.		
6.202.4	<p>Testing in the event of non-extinguishing material</p> <p>If parts, other than enclosures, do not withstand the glow wire tests of Clause 6.202.3, by failure to extinguish within 30 s after the removal of the glowwire tip, the needle-flame test detailed in Clause 6.202.3 shall be made on all parts of non-metallic material which are within a distance of 50 mm or which are likely to be impinged upon by flame during the tests of Clause 6.202.3. Parts shielded by a separate barrier which meets the needle-flame test need not be tested.</p> <p>NOTE 1: If the enclosure does not withstand the glow-wire test the equipment is considered to have failed to meet the requirements of Clause 6.202 without the need for consequential testing.</p> <p>NOTE 2: If other parts do not withstand the glow-wire test due to ignition of the tissue paper and if this indicates that burning or glowing particles can fall onto an external surface underneath the equipment, the equipment is considered to have failed to meet the requirements of Clause 6.202 without the need for consequential testing.</p> <p>NOTE 3: Parts likely to be impinged upon by the flame are considered to be those within the envelope of a vertical cylinder having a radius of 10 mm and a height equal to the height of the flame, positioned above the point of the material supporting, in contact with, or in close proximity to, connections.</p>		N/A
6.202.5	<p>Testing of printed boards</p> <p>The base material of printed boards shall be subjected to the needle-flame test of Clause 6.202.3. The flame shall be applied to the edge of the board where the heat sink effect is lowest when the board is positioned as in normal use. The flame shall not be applied to an edge, consisting of broken perforations, unless the edge is less than 3 mm from a potential ignition source.</p> <p>The test is not carried out if—</p> <ul style="list-style-type: none"> – the printed board does not carry any potential ignition source; – the base material of printed boards, on which the available apparent power at a connection exceeds 15 VA operating at a voltage exceeding 50 V and equal or less than 400 V (peak) a.c. or d.c. under normal operating conditions, is of flammability category V-1 or better according to AS/NZS 60695.11.10, or the printed boards are protected by an enclosure meeting the flammability category V-0 according to AS/NZS 60695.11.10, or made of metal, having openings only for connecting wires which fill the openings completely; or – the base material of printed boards, on which the available equipment power at a connection 		N/A

IEC 62368_1B ATTACHMENT			
Clause	Requirement + Test	Result - Remark	Verdict
	<p>exceeds 15 VA operating at a voltage exceeding 400 V (peak) a.c. or d.c. under normal operating conditions, and base material of printed boards supporting spark gaps which provides protection against overvoltages, is of flammability category V-0 according to AS/NZS 60695.11.10 or the printed boards are contained in a metal enclosure, having openings only for connecting wires which fill the openings completely.</p> <p><i>Conformance shall be determined using the smallest thickness of the material.</i></p> <p>NOTE: Available apparent power is the maximum apparent power which can be drawn from the supplying circuit through a resistive load whose value is chosen to maximize the apparent power for more than 2 min when the circuit supplied is disconnected.</p>		
6.202.6	<p>For open circuit voltages greater than 4 kV</p> <p>Potential ignition sources with open circuit voltages exceeding 4 kV (peak) a.c. or d.c. under normal operating conditions shall be contained in a FIRE ENCLOSURE which shall comply with flammability category V-1 or better according to AS/NZS 60695.11.10.</p>		N/A
8.6.1.201	<p>8.6.1.201 Instructional safeguard for fixed-mount television sets</p> <p>MS2 and MS3 television sets and display devices designed only for fixed mounting to a wall of ceiling or equipment rack shall, where required in Table 36, footnote 201, have an instructional safeguard in accordance with Clause F.5 which may be on the equipment or included in the installation instructions or equivalent document accompanying the equipment.</p> <p>The elements of the instructional safeguard shall be as follows:</p> <ul style="list-style-type: none"> – element 1a: not available; – element 2: ‘Stability Hazard’ or equivalent wording; – element 3: ‘The television set may fall, causing serious personal injury or death’ or equivalent text; – element 4: the following or equivalent text: <p>To prevent injury, this television set must be securely attached to the floor/wall in accordance with the installation instructions</p>	Shall be evaluated when national approval.	N/A

IEC 62368_1B ATTACHMENT			
Clause	Requirement + Test	Result - Remark	Verdict
8.6.1.202	<p>Restraining device</p> <p>MS2 and MS3 television sets and display devices that are not solely fixed-mounted should be provided with a restraining device such as a fixing point to facilitate restraining the equipment from toppling forward. The restraining device shall be capable of withstanding a pull of 100 N in all directions without damage.</p> <p>Where a restraining device is provided, instructions shall be provided in the instructions for installation or instructions for use to ensure correct and safe installation.</p>	Shall be evaluated when national approval.	N/A

IEC 62368_1B ATTACHMENT			
Clause	Requirement + Test	Result - Remark	Verdict

ATTACHMENT TO TEST REPORT
IEC 62368-1
(JAPAN) NATIONAL DIFFERENCES
 (Audio/video, information and communication technology equipment – Part 1: Safety requirements)

Differences according to: J62368-1 (H30)

Attachment Form No.: JP_ND_IEC62368_1B

Attachment Originator.....: UL (JP)

Master Attachment: Date 2018-11-22

Copyright © 2018 IEC System for Conformity Testing and Certification of Electrical Equipment (IECEE), Geneva, Switzerland. All rights reserved.

	National Differences		—
4.1.2	Where the component, or a characteristic of a component, is a safeguard or a part of a safeguard, components shall comply with the requirements of this standard or, where specified in a requirements clause, with the safety aspects of the relevant JIS component standards or IEC component standards, or components shall have properties equivalent to or better than these.	Complied.	P
5.6.1	Mains socket-outlet and appliance outlet shall comply with Clause G.4.2A if they are incorporated as part of the equipment.	Not such equipment.	N/A
5.6.2.1	Mains connection of class 0I equipment: Instructional safeguard in accordance with Clause F.3.6.1A; Mains plug having a lead wire for protective earthing connection of class 0I equipment; Independent main protective earthing terminal installed by ordinary person.	Class I equipment considered.	N/A
5.6.2.2	This requirement does not apply to internal conductor of the cord set that is covered by the sheath of mains cord and is formed together with mains plug and appliance connector.		N/A
5.6.3	In case of class 0I equipment using power supply cord having two conductors (no earthing conductor), the conductor of protective earthing lead wire shall comply with either of the following: – use of annealed copper wire with 1.6 mm diameter or corrosion-inhibiting metal wire having size and strength that are equivalent to or more than the above copper wire – single core cord or single core cable with 1.25 mm ² or more cross-sectional area	Class I equipment considered.	N/A

IEC 62368_1B ATTACHMENT			
Clause	Requirement + Test	Result - Remark	Verdict
5.7.3	For class 0I equipment that is provided with mains socket-outlet in the configuration as specified in JIS C 8282 series or JIS C 8303, or otherwise being considered to comply with relevant regulations, or that is provided with mains appliance outlet as specified in JIS C 8283-2-2 for the purpose of interconnection, the measurement is conducted on the system of the interconnected equipment having a single connection to the mains.	Class I equipment considered.	N/A
5.7.4	In case of class 0I equipment, touch current shall not exceed 1.41 mA peak or for sinusoidal wave, 1.0 mA r.m.s. when measured using the network specified in Figure 4 of IEC 60990.	Class I equipment considered.	N/A
6.4.3.3	A fuse complying with JIS C 6575 series or a fuse having equivalent characteristics shall open within 1 s. For Class A fuse of JIS C 6575, replace "2.1 times" by "1.35 times" and in case of Class B fuse of JIS C 6575, replace "2.1 times" by "1.6 times". A fuse not complying with JIS C 6575 series shall be tested with the breaking capacity taken into account.		N/A
8.5.4.2.1	Only three-phase stationary equipment rated more than 200 V ac can be considered as being for use in locations where children are not likely to be present, when complying with Clause F.4.	No moving parts.	N/A
8.5.4.2.2	For equipment installed where children may be present, an instructional safeguard shall be provided by easily understandable wording in accordance with Clause F.5, except that element 3 is optional.		N/A
8.5.4.2.4	The media destruction device is tested according to Clause V.1.2 with applicable jointed test probes to the opening. And then the wedge probe per Figure V.4 shall not contact any moving part.		N/A
8.5.4.2.5	The wedge probe of Figure V.4 and applicable jointed test probes specified in Clause V.1.2 shall not contact any moving part. Instructional safeguard shall not be used instead of equipment safeguard for preventing access to hazardous moving parts.		N/A
9.2.6, Table 38	Handles, Knobs, grips, etc. and external surfaces either held, touched or worn against the body in normal use (> 1 min) ^{b,c}	No such part.	N/A

IEC 62368_1B ATTACHMENT			
Clause	Requirement + Test	Result - Remark	Verdict
F.3.5.1	Instructional safeguard of class 0I equipment in accordance with Clause F.5 when a mains socket-outlet as specified in JIS C 8282 series, JIS C 8303 or relevant regulation to which class I equipment can be connected is provided in accordance with Clause G.4.2A except for the cases where the socket-outlet is accessible only to skilled persons.		N/A
F.3.5.3	If the fuse is necessary for the safeguard function, the symbols indicating pre-arcing time-current characteristic.	No replaceable fuse.	N/A
F.3.6.1A	Marking for class 0I equipment The requirements of Clauses F.3.6.1.1 and F.3.6.1.3 shall be applied to class 0I equipment. For class 0I equipment, a marking of instructions and instructional safeguard shall be provided regarding the earthing connection.	Class I equipment considered.	N/A
F.3.6.2.1	Symbols, IEC 60417-5172 (2003-02) or IEC 60417-6092 (2011-10), shall not be used for class I equipment or class 0I equipment.		P
F.4	Instruction for audio equipment with terminals classified as ES3 in accordance with Table E.1, and for other equipment with terminals marked in accordance with F.3.6.1 and F.3.6.1A. Installation instruction for the protective earthing connection for class 0I equipment provided with independent main protective earthing terminal, where the cord for the protective earthing connection is not provided within the package for the equipment.	Not audio equipment.	N/A
G.3.2.1	The thermal link when tested as a separate component, shall comply with the requirements of JIS C 6691 or have properties equivalent to or better than that.	No such component.	N/A
G.3.4	Except for devices covered by Clause G.3.5, overcurrent protective devices used as a safeguard shall comply with the relevant part of JIS C 6575 (corresponding to IEC60127) or shall have equivalent characteristics. If there are no applicable IEC standards, overcurrent protective devices used as a safeguard shall comply with their applicable IEC standards.	Approved fuse used.	P
G.4.1	This requirement is not applicable to Clauses G.4.2 and G.4.2A.	Approved AC inlet used.	P

IEC 62368_1B ATTACHMENT			
Clause	Requirement + Test	Result - Remark	Verdict
G.4.2	<p>Mains connector shall comply with JIS C 8282 series, JIS C 8283 series, JIS C 8285, JIS C 8303 or IEC 60309 series.</p> <p>Mains plugs and socket-outlets shall comply with JIS C 8282 series, JIS C 8303, IEC 60309 series, or have equivalent or better performance.</p> <p>A power supply cord set provided with appliance connector that can fit appliance inlet complying with JIS C 8283-1 shall comply with JIS C 8286.</p> <p>Construction preventing mechanical stress not to transmit to the soldering part of inlet terminal.</p> <p>Consideration for an equipment rated not more than 125 V provided with Type C14 and C18 appliance coupler complying with JIS C 8283 series.</p>		N/A
G.4.2A	Mains socket-outlet and interconnection coupler provided with the class II, class I and class 0I equipment respectively.		N/A
G.7.1	A mains supply cord need not include the protective earthing conductor for class 0I equipment provided with independent protective earthing conductor.	No power cord set provided.	N/A
G.8.3.3	Withstand $1,71 \times 1.1 \times U_0$ for 5 s.	No varistor.	N/A

IEC 62368_1B ATTACHMENT			
Clause	Requirement + Test	Result - Remark	Verdict
Appendix	Appendix 12, J3000(H25) Special National conditions, National deviation and other information according to MITI Ordinance No. 85.		—
1	General requirement When equipment provides with appliance inlet complying with JIS C 8283-1(2008), soldered parts of appliance inlet is not applied by force during insert or removal of connector. This is not applied when inlet body is fixed itself and not fixed by solder.	Inlet is fixed by adequate mechanical construction, not rely on soldering.	P
2	Requirement for equipment		—
2.1	Heater Appliances When diode is used in parallel for adjustment of power, the equipment shall remain safe for operation under open condition of one diode.	Not electric stove.	N/A
	The current rating of one diode shall be more than main current. The diodes connected in parallel are same type.		N/A
	The heating test specified by clause 11 of JIS C 9335-2-30(2006) under open condition of one diode shall comply with the requirements.		N/A
2.2	Electric heater with glowing heating elements	Not electric stove.	N/A
	Surface treatment by paint or adhesive on protective frame or protective mesh shall not be used.		N/A
	Caution marking like below shall be on - easily visible place of the equipment or - Instruction manual 「注意 当該機器から、使用初期段階で揮発性有機化合物及びカルボニル化合物が最も放散するおそれがあるため、その際には十分換気を行うこと。」		N/A
3	Components used in equipment	No such equipment /components.	N/A
3.1	Motor capacitors used in ventilating fan, electric fan, air conditioner, electric washing machine, refrigerator or electric freezer shall be comply with - capacitors with protective elements or protective mechanism complying with JIS C 4908(2007) - P2 capacitor complying with IEC 60252-1(2001) Capacitor complying with below is acceptable		N/A
	Enclosed by metal or ceramic		N/A
	No non-metallic materials within 50 mm from capacitor surface		N/A

IEC 62368_1B ATTACHMENT			
Clause	Requirement + Test	Result - Remark	Verdict
	Non-metallic material within 50 mm from capacitor surface comply with needle frame test of JIS C 9335-1(2003), Annex E		N/A
	Non-metallic material within 50 mm from capacitor surface comply with V-1 test of JIS C 60965-11-10(2006).		N/A
3.2	<p>Plug directly inserted to outlet used refrigerator or electric freezer.</p> <p>Shall comply with</p> <ul style="list-style-type: none"> - Face contact with outlet shall have CTI with more than 400 according to JIS C 2134(2007) or - Supporting material of blades shall comply with glow wire test by temperature of 750°C according to JIS C 60695-2-11(2004) or JIS C 60695-2-12(2004). <p>Materials having glow wire frame temperature of 775 °C are acceptable.</p>		N/A

IEC 62368-1			
Clause	Requirement + Test	Result - Remark	Verdict
6.4.8.3.3, 6.4.8.3.4 & P.2.2	Table: enclosure openings		P
Location	Size (mm)	Comments	
External plastic enclosure			
Top	No opening.	--	
Rear	Numerous rectangle openings: Max.13.4mm x 1.4mm.	--	
Left	No opening.	--	
Right	No opening.	--	
Bottom	1) One rectangle opening: 35.8mm x 25.1mm. 2) One rectangle opening: 140.2mm x 18.7mm.	--	
Internal metal chassis (metal thickness min.0.6mm)			
Top	1) Numerous circle openings: Ø 4.7mm. 2) One rectangle opening above power board: 20.8mm x 13.7mm. 3) One rectangle opening above power board: 21.8mm x22.4mm. 4) One rectangle opening above main board: 29.2mm x 16.3mm. 5) One rectangle opening above main board: 21.8mm x22.4mm.	1) Openings do not exceed 5mm in any dimension. No hazards. 2)-3) Openings are covered by Mylar. No hazardous. 4)-5) Power board output complied LPS. No hazard.	
Rear	1) Four circle openings near power board and main board: Ø3.8mm. 2) One rectangle opening near power board: 29.3mm x 21.4mm. 3) One rectangle opening near main board: 50.6mm x 31.4mm.	1)-3) Openings were blocked by plastic enclosure. No hazards.	
Left	One rectangle opening above power board: 29.3mm x 13.9mm.	Openings are covered by Mylar. No hazardous.	

IEC 62368-1			
Clause	Requirement + Test	Result - Remark	Verdict
Right	One rectangle opening above main board for wire connected to panel: 50.6mm x 12.5mm.	Power board output complied LPS. No hazard.	
Bottom	Numerous circle openings: Ø 1.9mm under power board, spacing of holes centre to centre: 3.5mm, min. thickness of metal: 0.81mm.	1) Complies with table 4D.	
Note(s):			

IEC 62368-1			
Clause	Requirement + Test	Result - Remark	Verdict

G.5.3.2	TABLE: transformers							P
Loc.	Tested insulation	Working voltage peak / V (2.10.2)	Working voltage rms / V (2.10.2)	Required electric strength (5.2)	Required clearance / mm (2.10.3)	Required creepage distance / mm (2.10.4)	Required distance thr. insul. (2.10.5)	
T901	Input terminal to output winding (RI)	610	337	AC 4000V	6.9	7.0	Min. 2 layers tape	
T901	Input terminal to output terminal (RI)	610	337	AC 4000V	6.9	7.0	Min. 2 layers tape	
T901	Input winding to output winding (RI)	610	337	AC 4000V	6.9	7.0	Min. 2 layers tape	
T901	Input winding to output terminal (RI)	610	337	AC 4000V	6.9	7.0	Min. 2 layers tape	
T901	Output winding to Core (RI)	610	337	AC 4000V	6.9	7.0	Min. 2 layers tape	
T901	Output terminal to Core (RI)	610	337	AC 4000V	6.9	7.0	Min. 2 layers tape	
Loc.	Tested insulation			Test voltage / V	Measured clearance / mm	Measured creepage dist. / mm	Measured distance thr. insul. / mm; number of layers	
T901	Input terminal to output winding (RI)			AC 4000V	--	--	Triple insulated wire used	
T901	Input terminal to output terminal (RI)			AC 4000V	37.7	37.7	--	
T901	Input winding to output winding (RI)			AC 4000V	--	--	Triple insulated wire used	
T901	Input winding to output terminal (RI)			AC 4000V	9.3	9.3	--	
T901	Output winding to Core (RI)			AC 4000V	--	--	Triple insulated wire used	
T901	Output terminal to Core (RI)			AC 4000V	9.0	9.0	--	

Supplementary information: All sources of transformer were checked with same construction.

IEC 62368-1			
Clause	Requirement + Test	Result - Remark	Verdict

G.5.3.2 **TABLE: transformers** **P**

Construction:

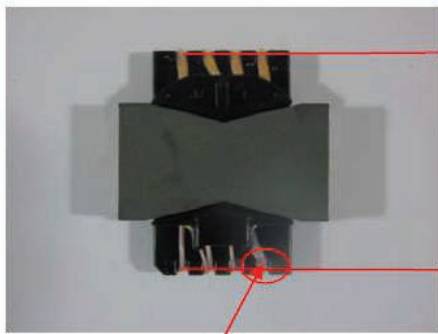
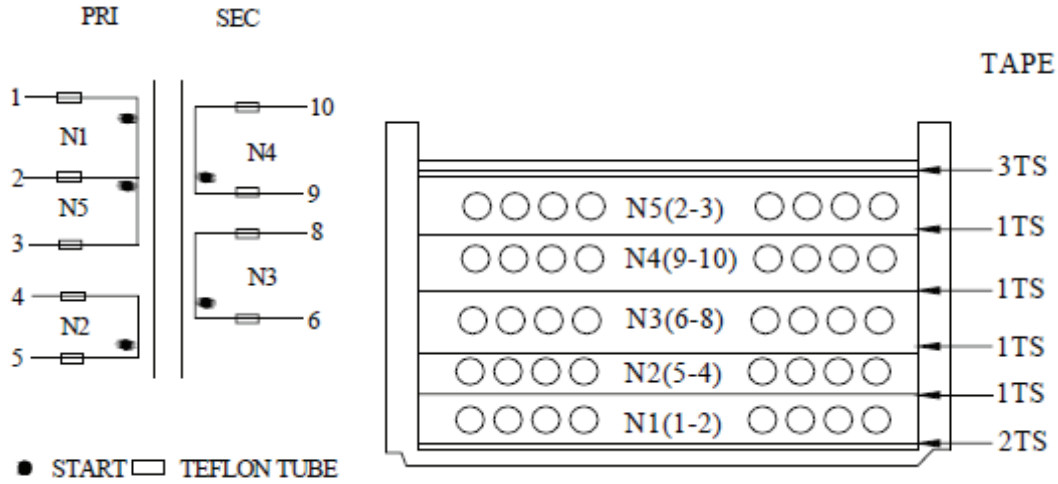

套管需超出 BOBBIN
開槽處槽長 2/3

此處套管需超出
BOBBIN 溝槽以避免
短路



No.	COIL	TERMINAL	WIRE GAUGE	WIRE TYPE	TUNS	WINDING METHOD	TAPE
1	N1	1--2	φ 0.40x1	UEW	14	CLOSED	1Ts
2	N2	5--4	φ 0.20x1	UEW	6	CLOSED	1Ts
3	N3	6--8	φ 0.55x2	TIW-M	2	CLOSED	1Ts
4	N4	9--10	φ 0.45x2	TIW-M	4	CLOSED	1Ts
5	N5	2--3	φ 0.40x1	UEW	14	CLOSED	3Ts

Concentric windings on phenolic bobbin. Two layers of insulation tape are provided around outer winding and outer winding is secondary winding. Two layers of insulation tape are provided between the primary windings and secondary windings. Triple insulated wire used for secondary winding, and the core is considered as primary part. All primary winding leads are covered by tube.

Product: LCD Monitor

Type Designation: See in main report



Figure 1. Front view of horizon position for 23.6 inch models



Figure 2. Rear view of horizon position for 23.6 inch models

Product: LCD Monitor

Type Designation: See in main report

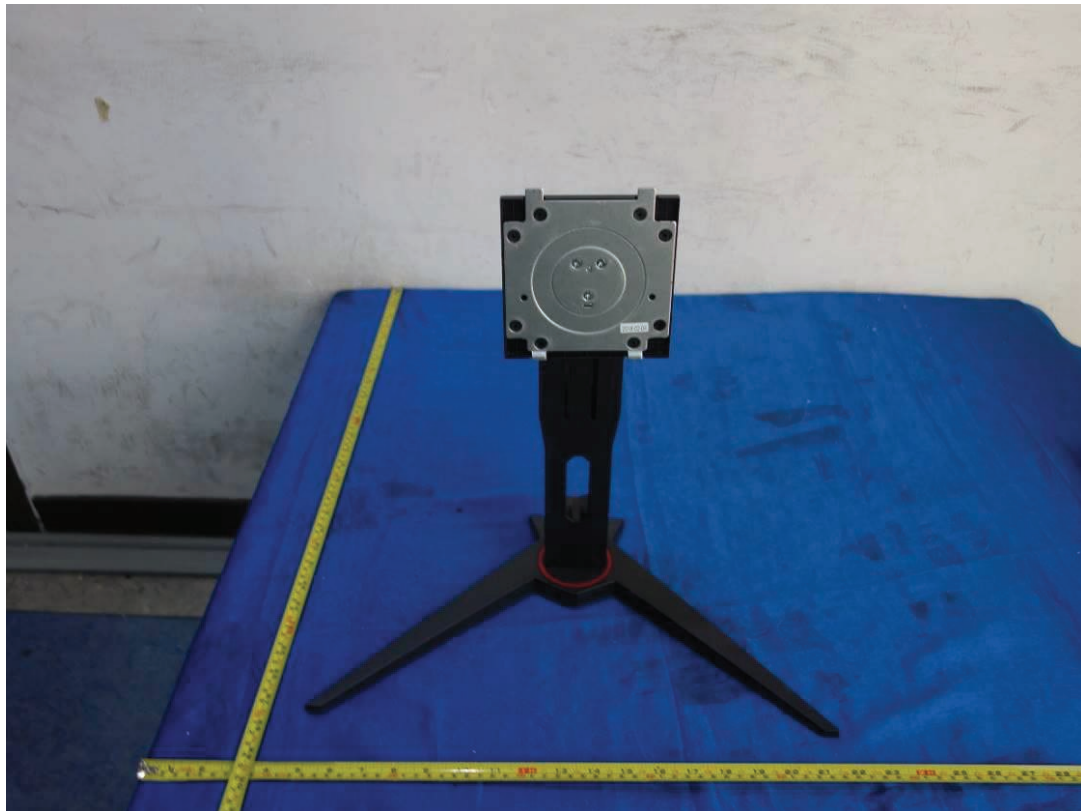

Figure 3. Stand base



Figure 4. Plastic enclosure without base stand

Product: LCD Monitor

Type Designation: See in main report



Figure 5. Internal view



Figure 6. Internal view

Product: LCD Monitor

Type Designation: See in main report



Figure 7. Internal view

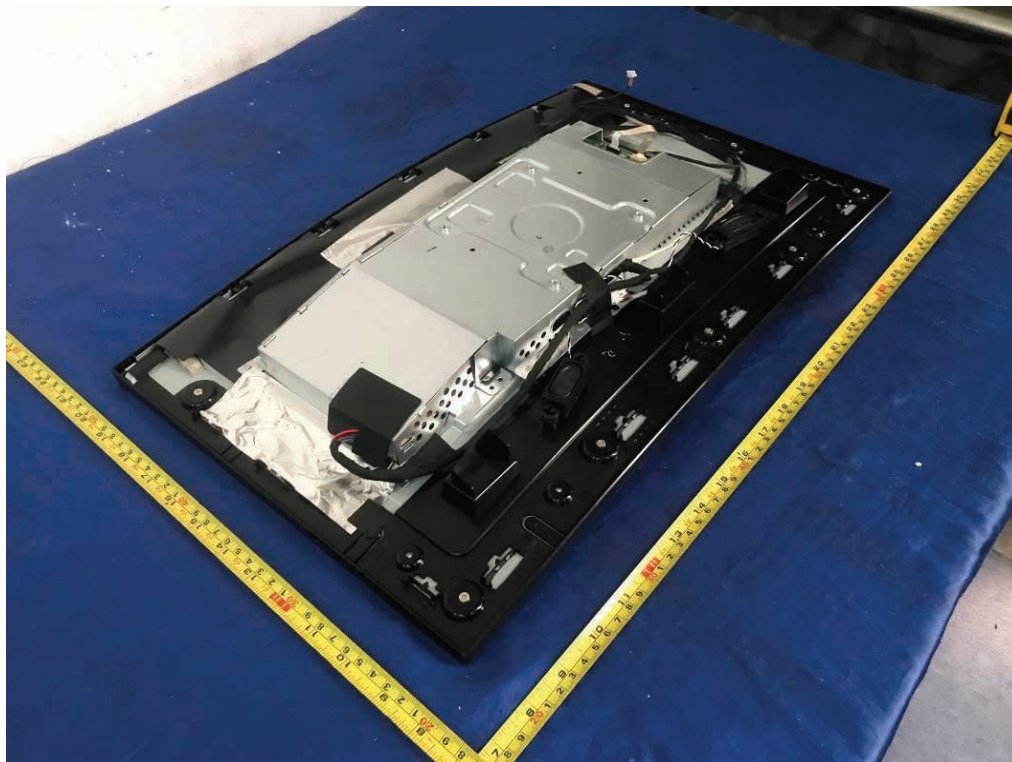

Figure 8. Internal view

Product: LCD Monitor

Type Designation: See in main report



Figure 9. AC inlet



Figure 10. Output connector

Product: LCD Monitor

Type Designation: See in main report

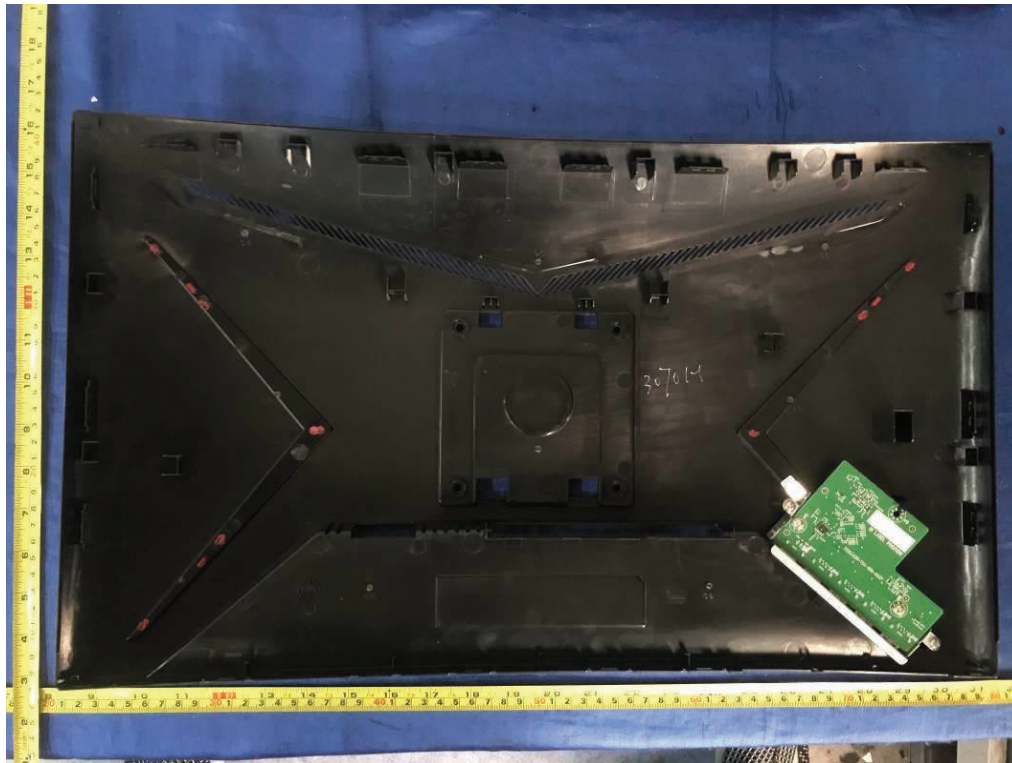

Figure 11. Internal view

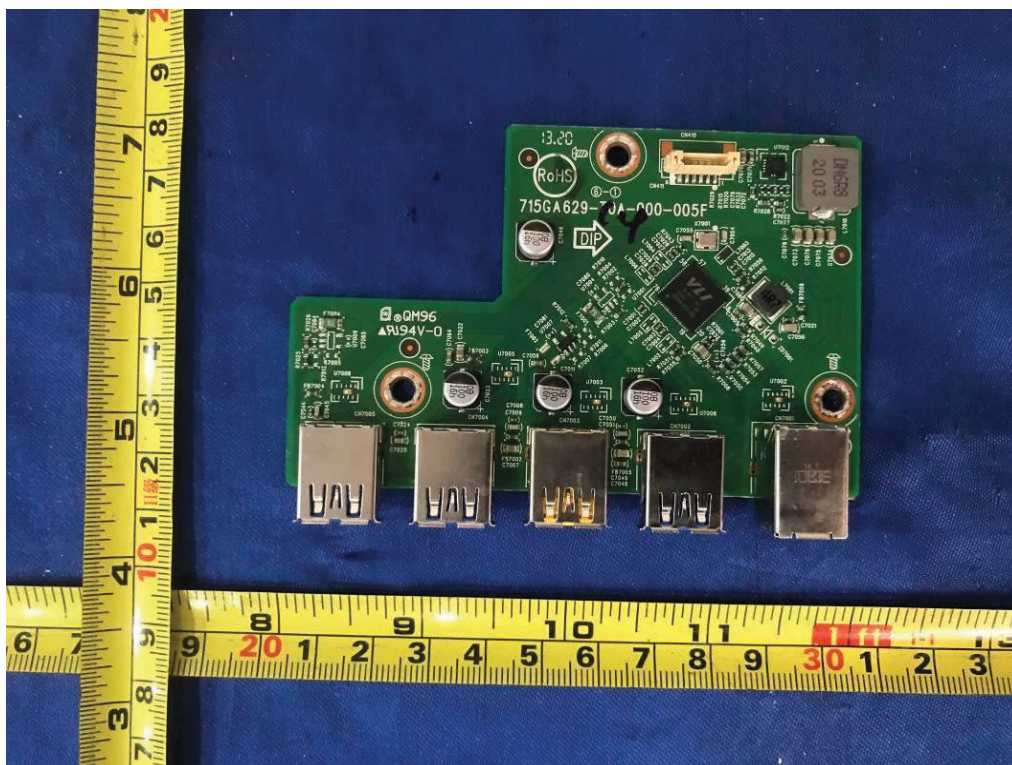

Figure 12. USB board 715GA629

Product: LCD Monitor

Type Designation: See in main report

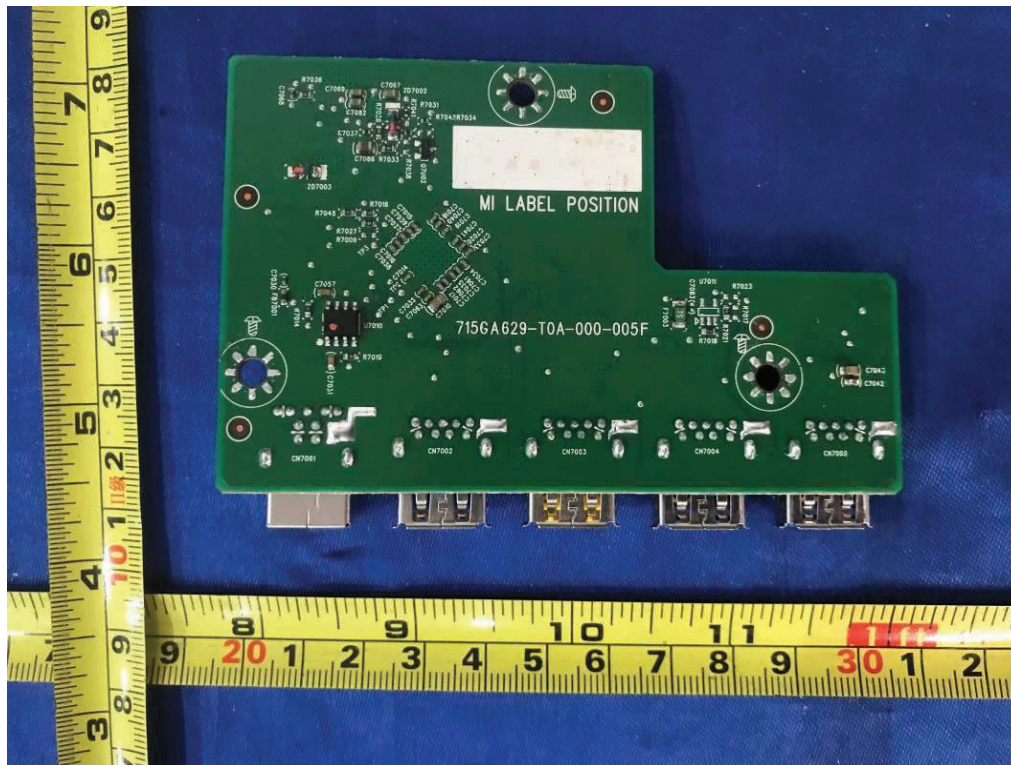

Figure 13. USB board 715GA629

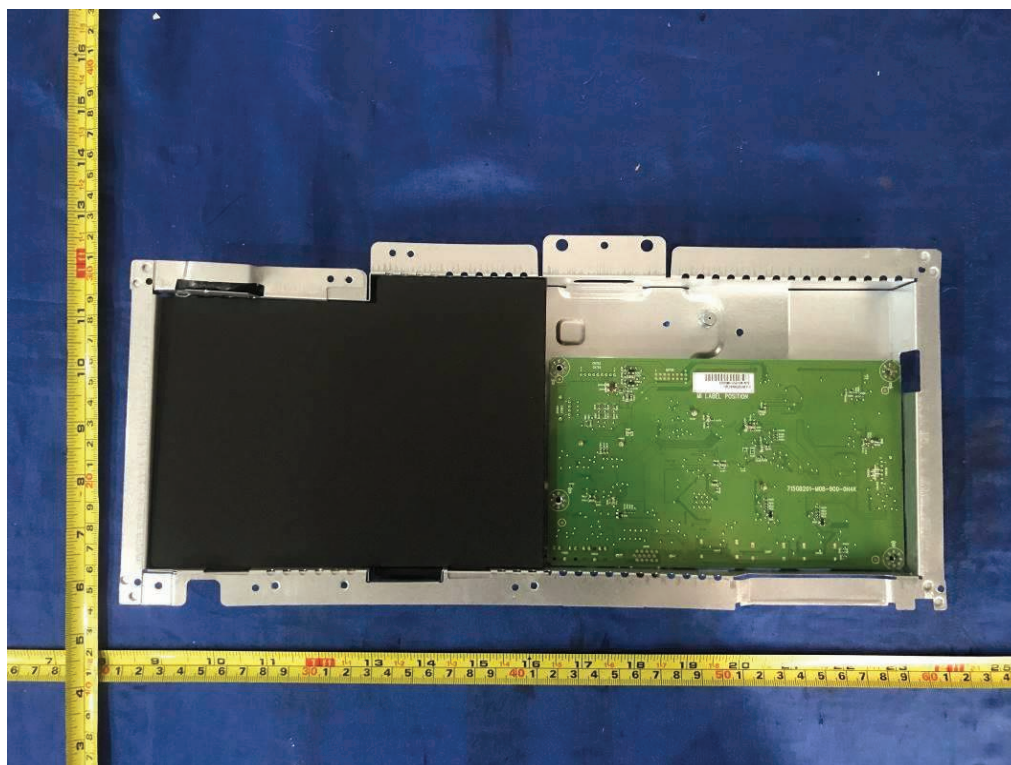

Figure 14. Internal view

Product: LCD Monitor

Type Designation: See in main report

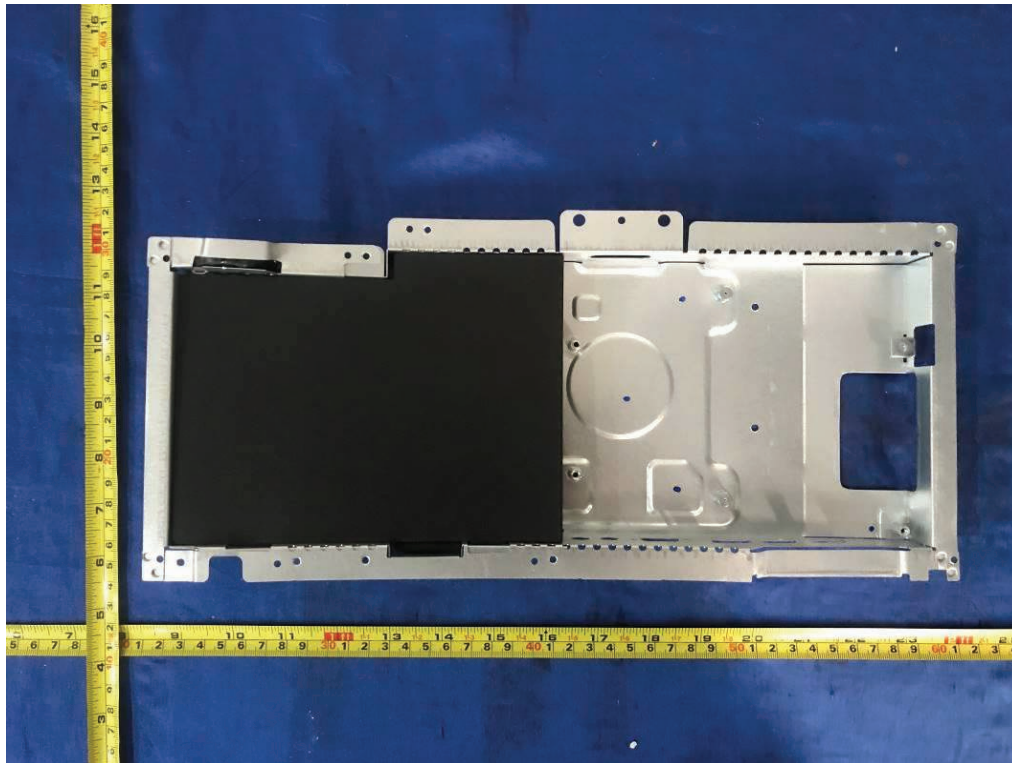

Figure 15. Internal view

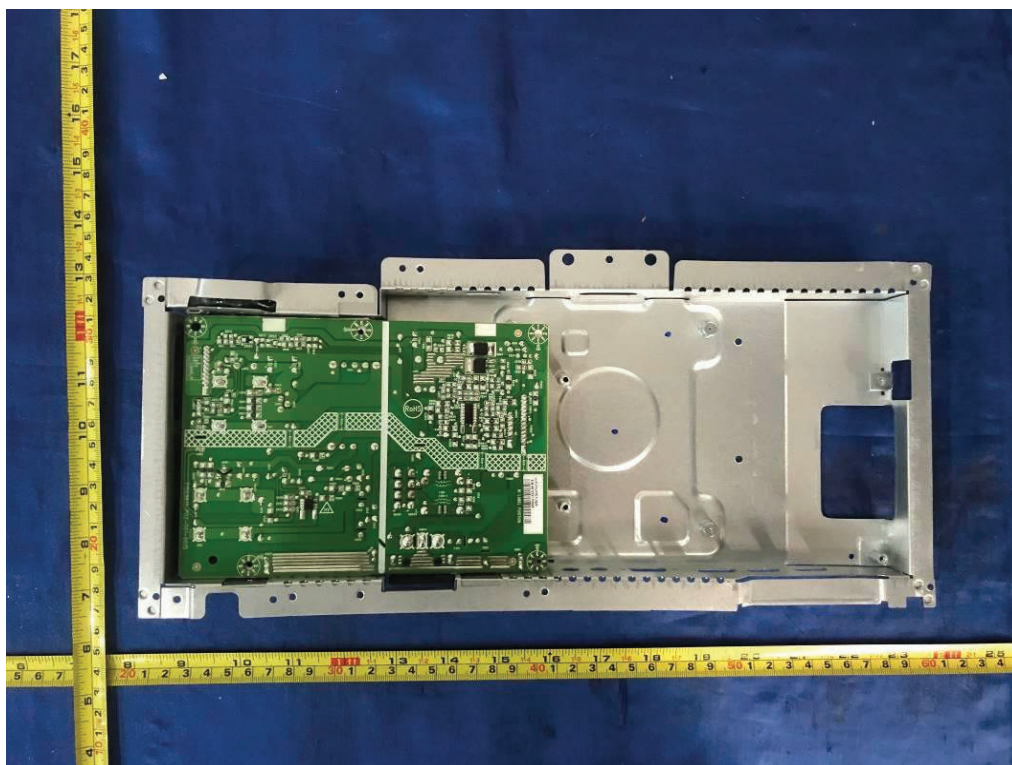

Figure 16. Internal view

Product: LCD Monitor

Type Designation: See in main report

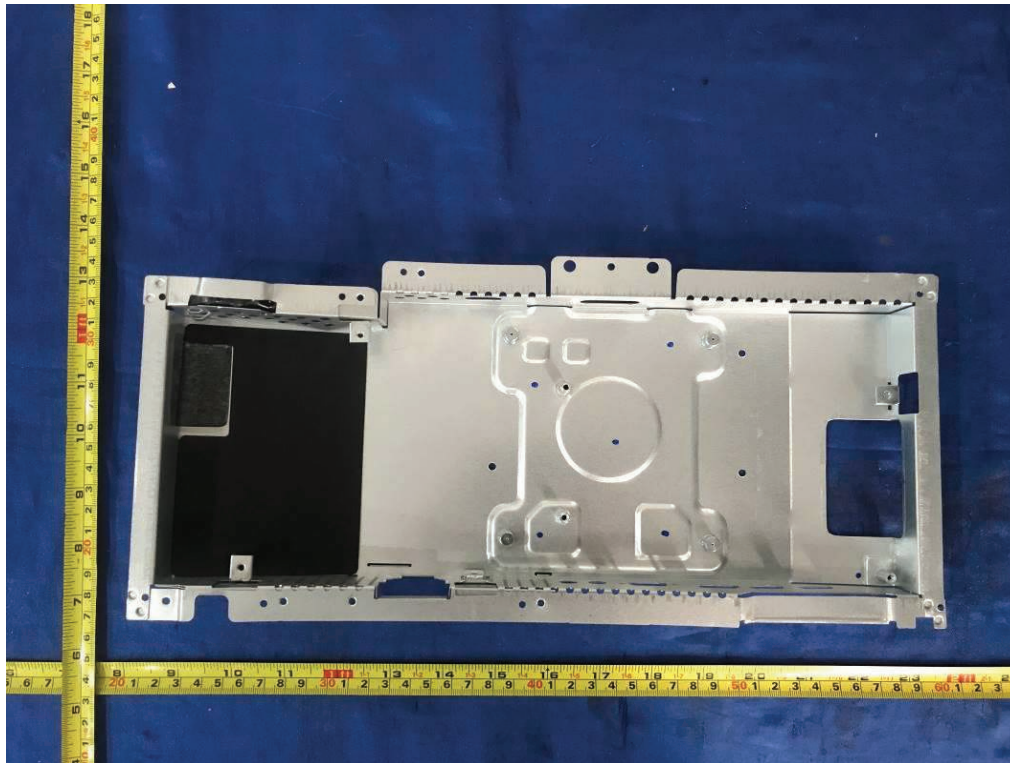

Figure 17. Internal view

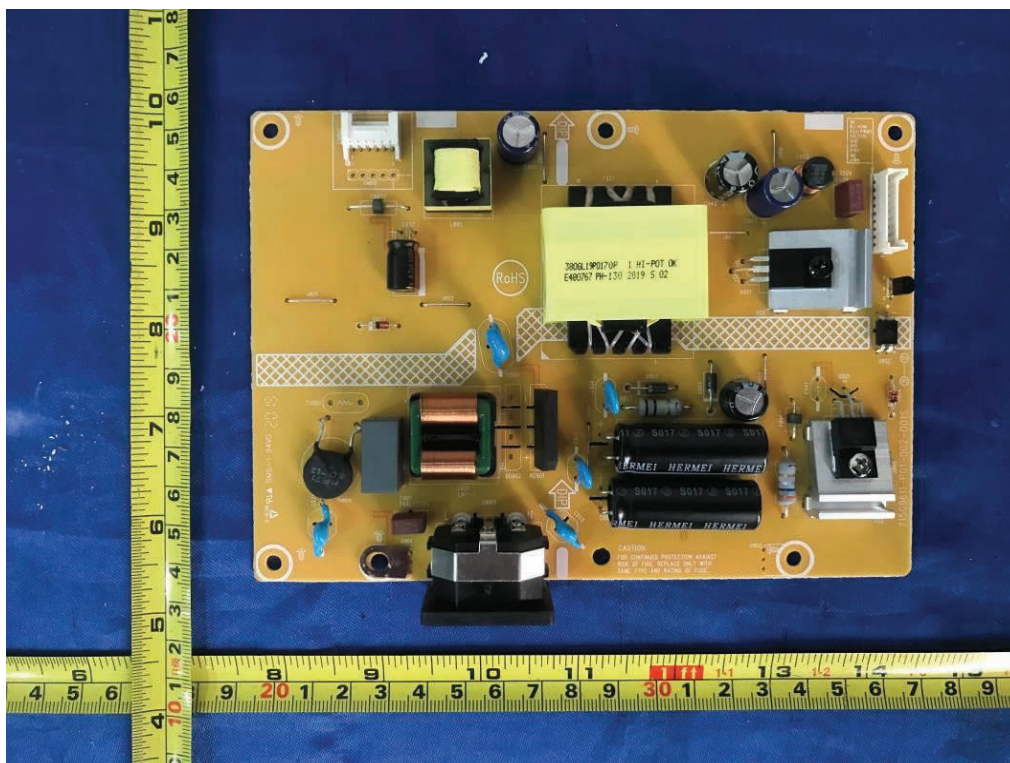

Figure 18. Power board 715G9611

Product: LCD Monitor

Type Designation: See in main report

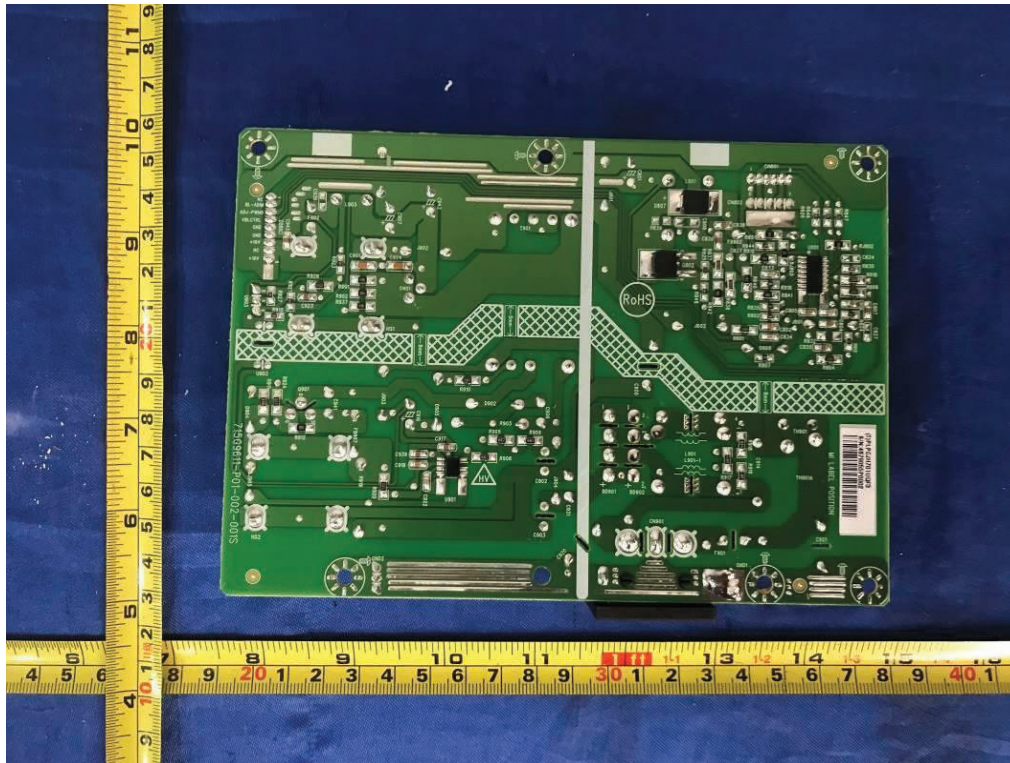

Figure 19. Power board 715G9611

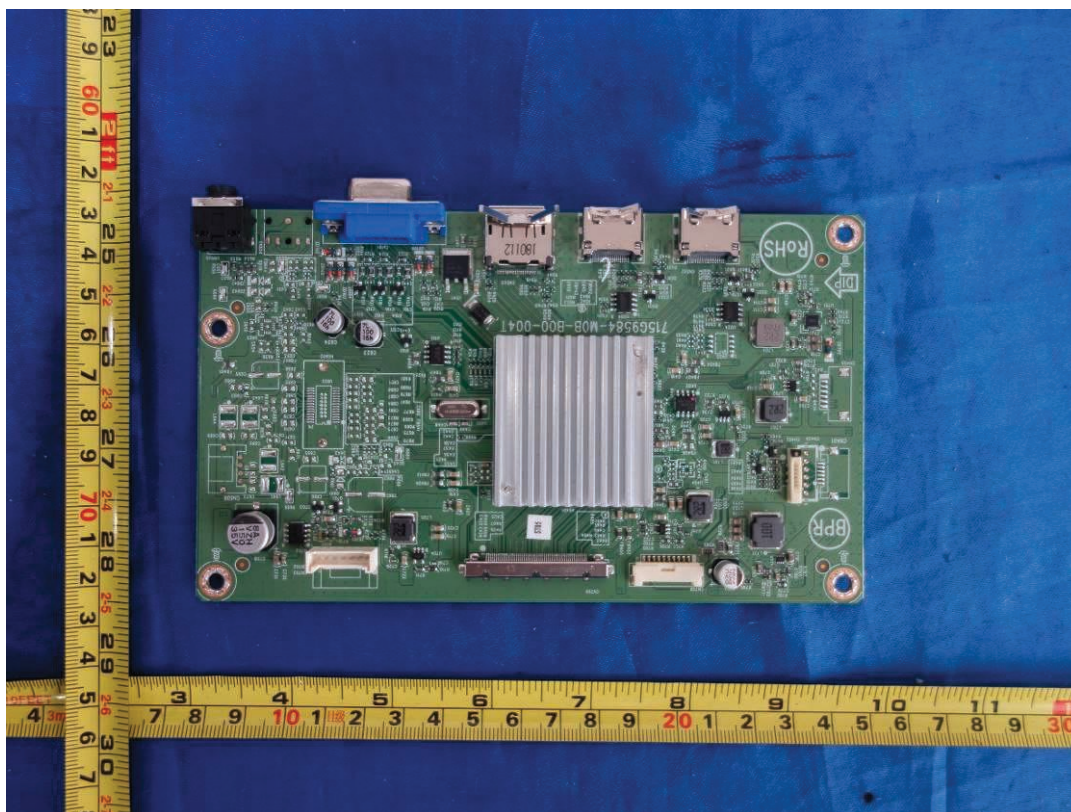

Figure 20. Main board 715G9584

Product: LCD Monitor

Type Designation: See in main report

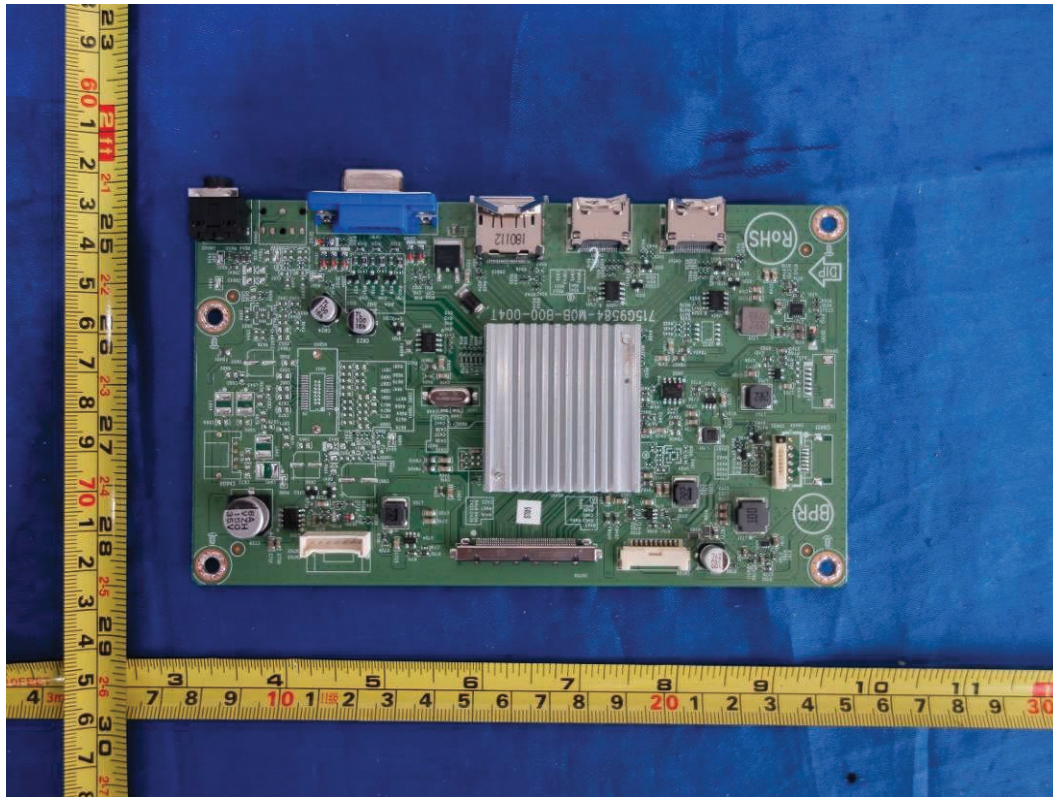

Figure 21. Main board 715G9584

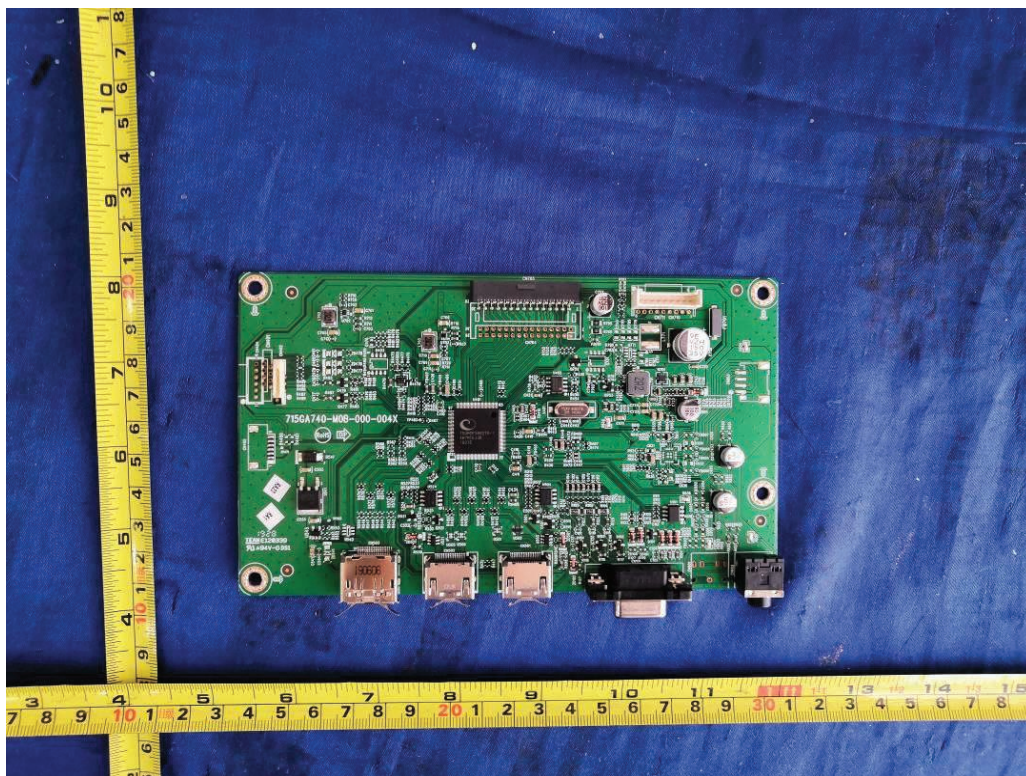

Figure 22. Main board 715GA740

Product: LCD Monitor

Type Designation: See in main report

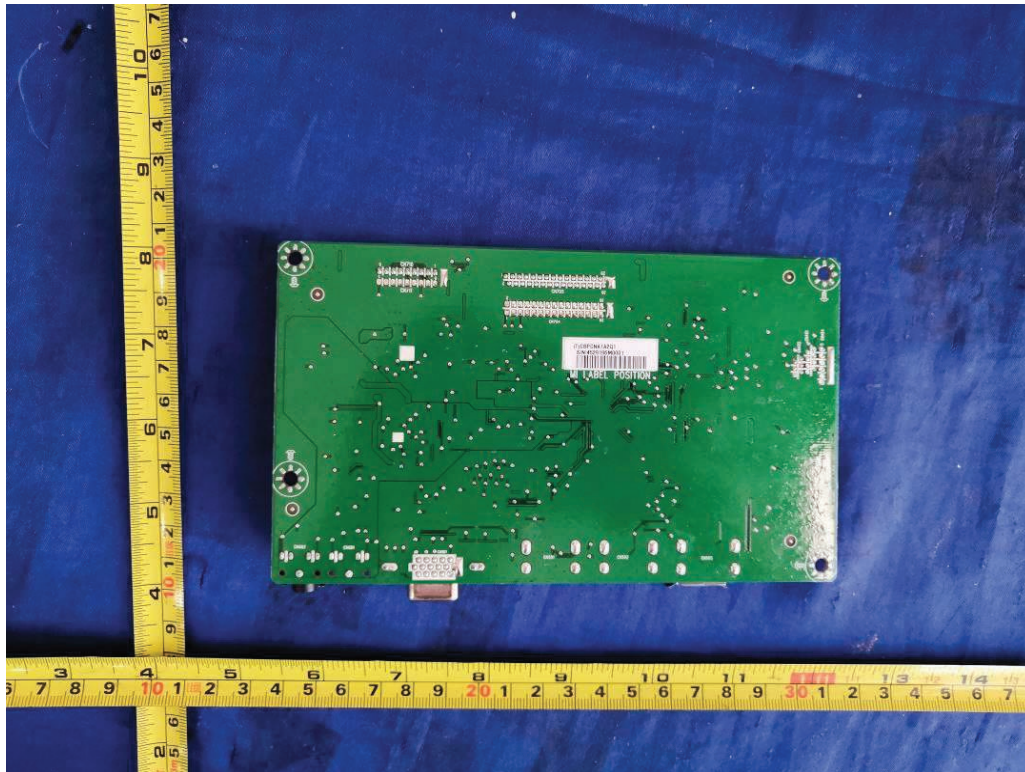

Figure 23. Main board 715GA740

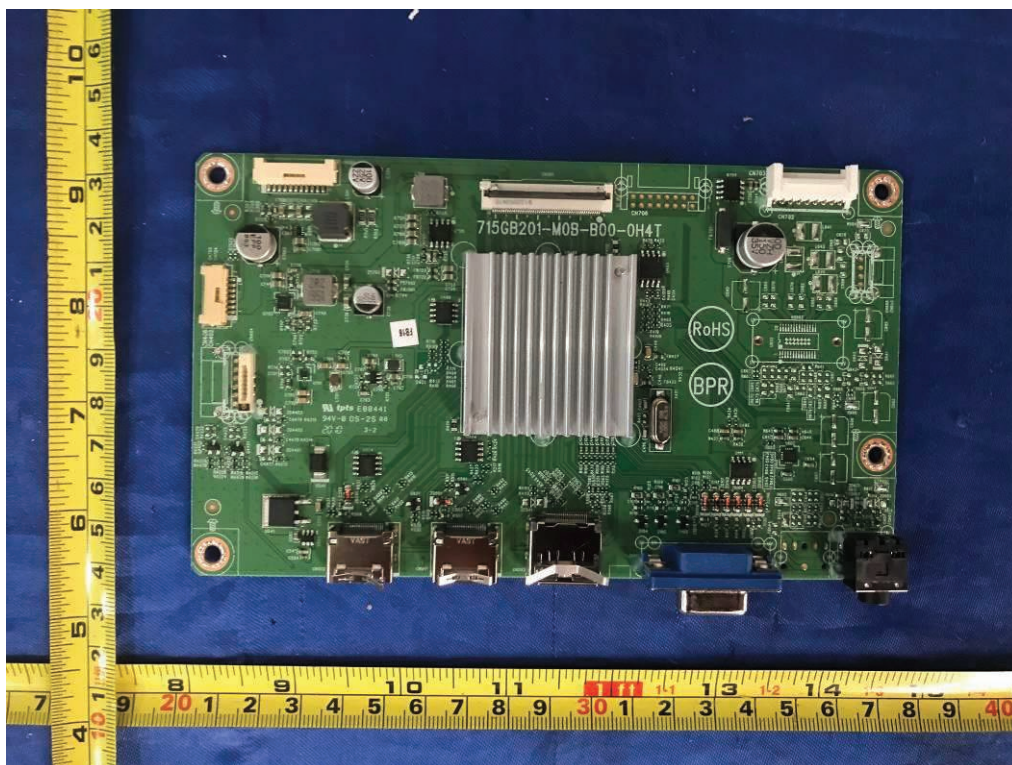

Figure 24. Main board 715GB201 without AUDIO port and without USB board port

Product: LCD Monitor

Type Designation: See in main report

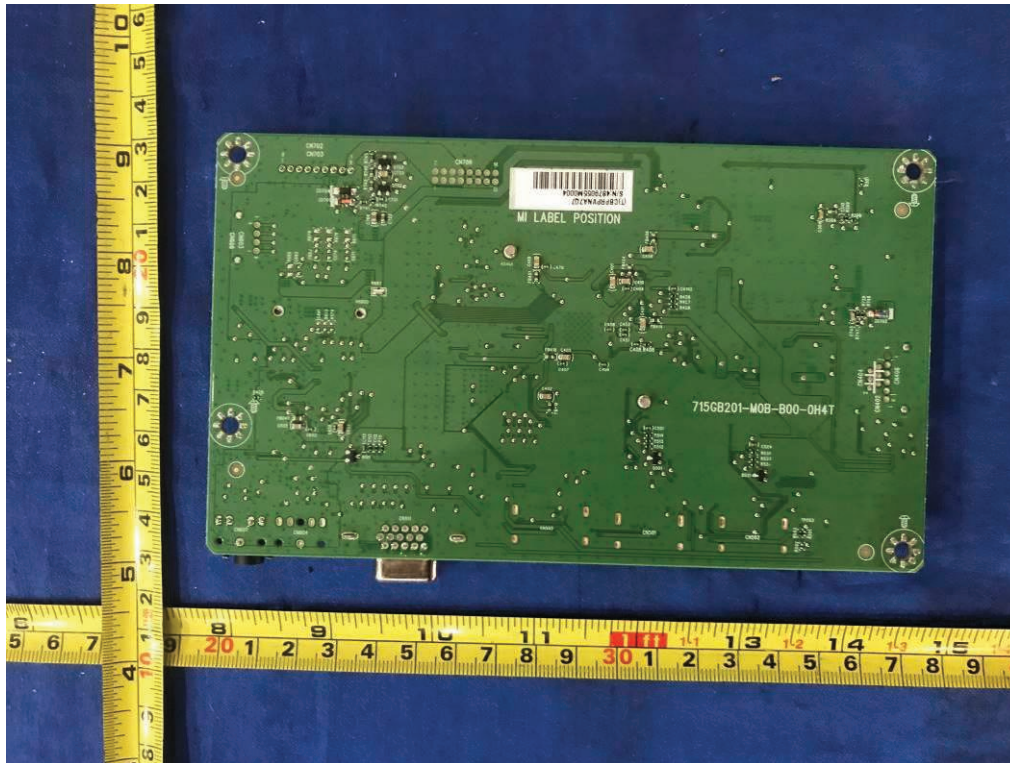

Figure 25. Main board 715GB201 without AUDIO port and without USB board port

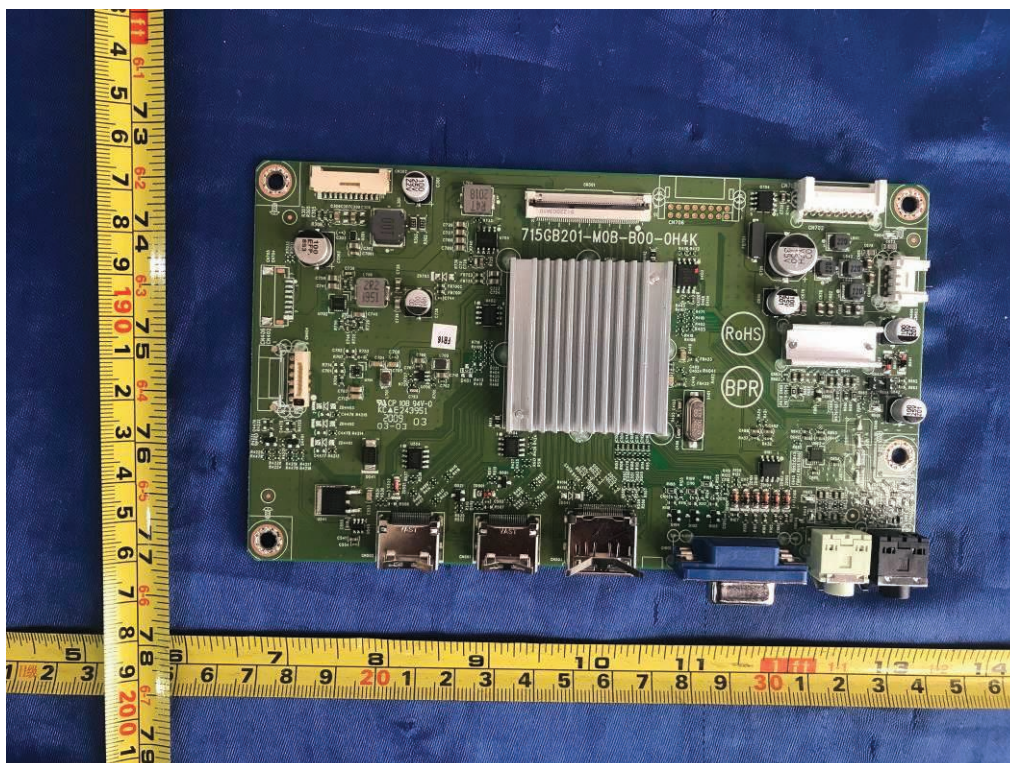

Figure 26. Main board 715GB201 with AUDIO port and with USB board port

Product: LCD Monitor

Type Designation: See in main report

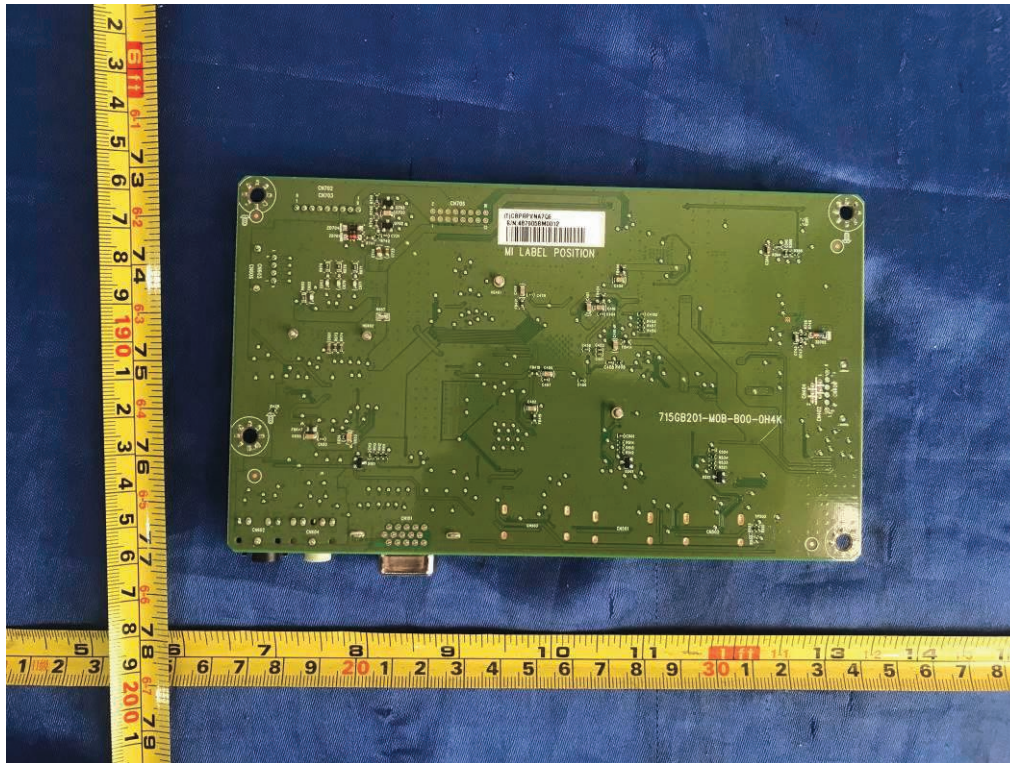

Figure 27. Main board 715GB201 with AUDIO port and with USB board port



Figure 28. Front view of horizon position for 27.0 inch models

Product: LCD Monitor

Type Designation: See in main report



Figure 29. Front view of horizon position for 27.0 inch models



Figure 30. Main board 715G9500 used for 27.0 inch models

Product: LCD Monitor

Type Designation: See in main report

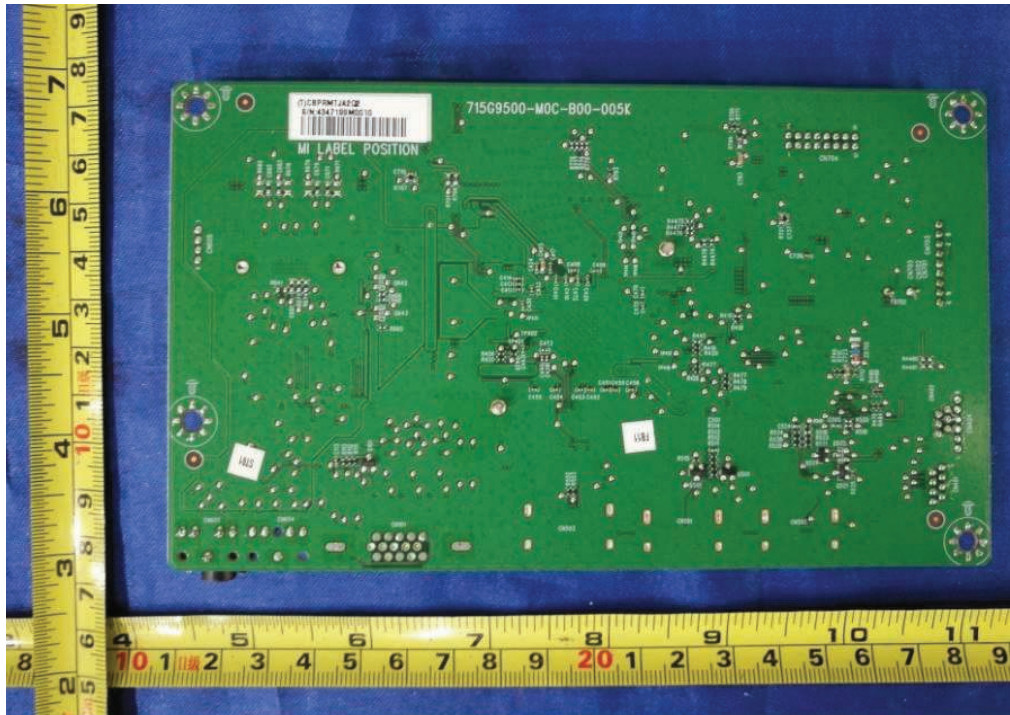

Figure 31. Main board 715G9500 used for 27.0 inch models



Figure 32. Main board 715GA531 used for 27.0 inch models

Product: LCD Monitor

Type Designation: See in main report

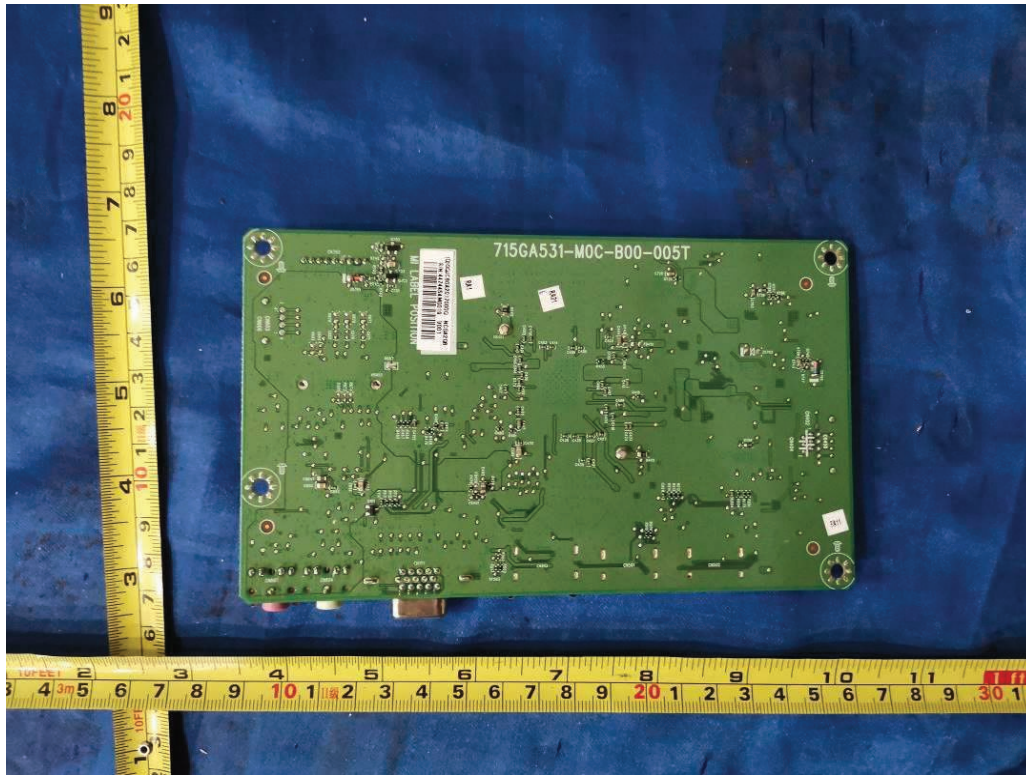

Figure 33. Main board 715GA531 used for 27.0 inch models