



Test Report issued under the responsibility of:



**TEST REPORT
IEC 62368-1**

**Audio/video, information and communication technology equipment
Part 1: Safety requirements**

Report Number: 60424117 001
 Date of issue: 2020-Oct-31
 Total number of pages: 55

Applicant's name.....: TPV Electronics (Fujian) Co., Ltd.
 Address: Rongqiao Economic and Technological Development Zone, Fuqing City, Fujian, P.R.China

Test specification:
 Standard.....: IEC 62368-1:2014 (Second Edition)
 Test procedure: CB Scheme
 Non-standard test method.....: N/A

Test Report Form No.: IEC62368_1B
 Test Report Form(s) Originator.....: UL(US)
 Master TRF: 2014-03

Copyright © 2014 Worldwide System for Conformity Testing and Certification of Electrotechnical Equipment and Components (IECEE), Geneva, Switzerland. All rights reserved.

This publication may be reproduced in whole or in part for non-commercial purposes as long as the IECEE is acknowledged as copyright owner and source of the material. IECEE takes no responsibility for and will not assume liability for damages resulting from the reader's interpretation of the reproduced material due to its placement and context.

If this Test Report Form is used by non-IECEE members, the IECEE/IEC logo and the reference to the CB Scheme procedure shall be removed.

This report is not valid as a CB Test Report unless signed by an approved CB Testing Laboratory and appended to a CB Test Certificate issued by an NCB in accordance with IECEE 02.

General disclaimer:
 The test results presented in this report relate only to the object tested.
 This report shall not be reproduced, except in full, without the written approval of the Issuing CB Testing Laboratory. The authenticity of this Test Report and its contents can be verified by contacting the NCB, responsible for this Test Report.

Test Item description	LCD Monitor
Trade Mark	AOC
Manufacturer	Same as applicant
Model/Type reference	27B2, 27B2*****, C27B2*****, 24B2, 24B2*****, C24B2***** (* can be 0-9, A-Z, a-z, -, \, /, + or blank for marketing purpose only, no technical difference.)
Ratings	I/P: 19Vdc, 1.31A

Testing procedure and testing location:		
<input checked="" type="checkbox"/>	CB Testing Laboratory:	TÜV Rheinland (Shenzhen) Co., Ltd.
Testing location/ address		1601 R&D Room, 1602-1604, 17-18F, Building 7 Site C, Vanke Cloud City Phase I, Xingke First Street, Xili Street, Xili Community, Nanshan District, Shenzhen 518052, P.R. China
<input type="checkbox"/>	Associated CB Testing Laboratory:	
Testing location/ address		
Tested by (name + signature)		Solina Zhao Project Handler
Approved by (name + signature).....		Anderson Wang Technical Reviewer
<input type="checkbox"/>	Testing procedure: TMP/CTF Stage 1:	
Testing location/ address		
Tested by (name + signature)		
Approved by (name + signature).....		
<input type="checkbox"/>	Testing procedure: WMT/CTF Stage 2:	
Testing location/ address		
Tested by (name + signature)		
Witnessed by (name + signature).....		
Approved by (name + signature).....		
<input type="checkbox"/>	Testing procedure: SMT/CTF Stage 3 or 4:	
Testing location/ address		
Tested by (name + signature)		
Witnessed by (name + signature).....		
Approved by (name + signature).....		
Supervised by (name + signature)		

<p>List of Attachments (including a total number of pages in each attachment):</p> <ul style="list-style-type: none"> - Photo documentation (5 Pages) - National Differences (51 Pages) 																	
<p>Summary of testing:</p>																	
<p>Tests performed (name of test and test clause):</p> <p>The tests were carried out under the most unfavorable combination within the manufacturer's operating specifications of the following parameters:</p> <ul style="list-style-type: none"> -supply voltage 19Vdc -operating temperature, Max. ambient temperature 40°C declared by the client -operating mode: continuous <p>The critical tests were performed for this equipment included clauses:</p> <table border="1"> <thead> <tr> <th>name of test</th> <th>test clause number</th> </tr> </thead> <tbody> <tr> <td>Classification of electrical energy sources</td> <td>5.2</td> </tr> <tr> <td>Maximum operating temperature test (Heating test)</td> <td>5.4.1.4, 6.3.2, 9.0, B.2.6</td> </tr> <tr> <td>Electrical Power Source (PS) measurements for classification</td> <td>6.2.2</td> </tr> <tr> <td>Stability</td> <td>8.6</td> </tr> <tr> <td>Input test</td> <td>Annex B.2.5</td> </tr> <tr> <td>Simulated abnormal operating and single fault conditions</td> <td>B.3, B.4</td> </tr> <tr> <td>Test for permanence of markings</td> <td>Annex F.3.10</td> </tr> </tbody> </table> <p>The EUT passed the test.</p>	name of test	test clause number	Classification of electrical energy sources	5.2	Maximum operating temperature test (Heating test)	5.4.1.4, 6.3.2, 9.0, B.2.6	Electrical Power Source (PS) measurements for classification	6.2.2	Stability	8.6	Input test	Annex B.2.5	Simulated abnormal operating and single fault conditions	B.3, B.4	Test for permanence of markings	Annex F.3.10	<p>Testing location:</p> <p>All tests as described in Test Case and Measurement Sections were performed at the laboratory described on page 2.</p>
name of test	test clause number																
Classification of electrical energy sources	5.2																
Maximum operating temperature test (Heating test)	5.4.1.4, 6.3.2, 9.0, B.2.6																
Electrical Power Source (PS) measurements for classification	6.2.2																
Stability	8.6																
Input test	Annex B.2.5																
Simulated abnormal operating and single fault conditions	B.3, B.4																
Test for permanence of markings	Annex F.3.10																
<p>Summary of compliance with National Differences:</p> <p>List of countries addressed:</p> <p><u>Summary of compliance with National Differences to IEC 62368-1:2014 (Second Edition) and EN 62368-1:2014+ A11: 2017 (for explanation of codes see below):</u></p> <p>EU Group Differences, EU Special National Conditions, AU, CA, DE, DK, FI, IT, JP, NO, SE, US, NZ</p> <p>Explanation of used codes: AU=Australia, CA=Canada, DE=Germany, DK=Denmark, FI=Finland, IT=Italy, JP=Japan, NO=Norway, SE=Sweden, US=United States of America, NZ=New Zealand</p> <p>The product fulfils the requirements of <u>EN 62368-1:2014+ A11:2017</u></p> <p>For National Differences see corresponding Attachment.</p>																	

Copy of marking plate:





The artwork below may be only a draft. The use of certification marks on a product must be authorized by the respective NCBs that own these marks.

AOC LCD MONITOR (LED backlight)

Product No.: 24B2XH
 Model No.: 24B2
 Power Rating: 19V \Rightarrow 1.31A

Warning: Shock Hazard, Do Not Open.
 Pour éviter une électrocution, ne retirez pas le couvercle!

For applicable power supplies see user manual
 Voir le manuel d'utilisateur pour les courants d'alimentation applicables
 CAN ICES-3(B)/NMB-3(B)
 www.aoc.com Made in China

  AOC International Europe B.V.
 Amstelgebouw, 6th floor
 Prins Bernhardplein 200
 1097 JB Amsterdam
 The Netherlands
 Envision Peripherals, Inc.
 47490 Seabridge Drive
 Fremont, CA 94538
 USA Q40G024N-615-XXX

机种名: XXXXXXXXXXXXXXXX
 Serial/No.: XXXXXXXXXXXXXXXX







Manufactured: 201X-XX-XX

AOC LCD MONITOR (LED backlight)

Product No.: 27B2H
 Model No.: 27B2
 Power Rating: 19V \Rightarrow 1.31A

Warning: Shock Hazard, Do Not Open.
 Pour éviter une électrocution, ne retirez pas le couvercle!

For applicable power supplies see user manual
 Voir le manuel d'utilisateur pour les courants d'alimentation applicables
 CAN ICES-3(B)/NMB-3(B)
 www.aoc.com Made in China

  AOC International Europe B.V.
 Amstelgebouw, 6th floor
 Prins Bernhardplein 200
 1097 JB Amsterdam
 The Netherlands
 Envision Peripherals, Inc.
 47490 Seabridge Drive
 Fremont, CA 94538
 USA Q40G024N-615-XXX

机种名: XXXXXXXXXXXXXXXX
 Serial/No.: XXXXXXXXXXXXXXXX



Manufactured: 201X-XX-XX

AOC LCD MONITOR (LED backlight)

Product No.: C24B2
 Model No.: C24B2
 Power Rating: 19V \Rightarrow 1.31A

Warning: Shock Hazard, Do Not Open.
 Pour éviter une électrocution, ne retirez pas le couvercle!

For applicable power supplies see user manual
 Voir le manuel d'utilisateur pour les courants d'alimentation applicables
 CAN ICES-3(B)/NMB-3(B)
 www.aoc.com Made in China/сделано в Китае

机种名: XXXXXXXXXXXXXXXX
 Serial/No.: XXXXXXXXXXXXXXXX



Manufactured: 201X-XX-XX

AOC LCD MONITOR /LED backlight
 ЖК-МОНИТОР

Product No.: C24B2
 Model No./
 модель номер: C24B2
 Power Rating/
 Входная мощность: 19V \Rightarrow 1.31A

Warning: Shock Hazard, Do Not Open.
 Pour éviter une électrocution, ne retirez pas le couvercle!

For applicable power supplies see user manual
 Voir le manuel d'utilisateur pour les courants d'alimentation applicables
 CAN ICES-3(B)/NMB-3(B)
 www.aoc.com
 Made in China/сделано в Китае
 TPV Electronics (Fujian) Co., Ltd.
 D40G024E-615-XXX





  AOC International Europe B.V.
 Amstelgebouw, 6th floor
 Prins Bernhardplein 200
 1097 JB Amsterdam
 The Netherlands

机种名: XXXXXXXXXXXXXXXX
 Serial/No.: XXXXXXXXXXXXXXXX



Manufactured: 201X-XX-XX

AOC	LCD MONITOR /LED backlight ЖК-монитор		Warning: Shock Hazard, Do Not Open. Pour éviter une électrocution, ne retirez pas le couvercle!
Product No.:	C27B2	For applicable power supplies see user manual Voir le manuel d'utilisateur pour les courants d'alimentation applicables	
Model No./	C27B2	CAN ICES-3(B)/NMB-3(B)	
модель номер:	C27B2	www.aoc.com	
Power Rating/	Входная мощность: 19V \approx 1.31A	Made in China/сделано в Китае	
		TPV Electronics (Fujian) Co., Ltd.	
		D40G024E-615-XXX	
			

Note: All models' rating labels are in the same design except for type designation. Above labels are representing the other models.

TEST ITEM PARTICULARS:	
Classification of use by.....:	<input checked="" type="checkbox"/> Ordinary person <input type="checkbox"/> Instructed person <input type="checkbox"/> Skilled person <input checked="" type="checkbox"/> Children likely to be present
Supply Connection	<input type="checkbox"/> AC Mains <input type="checkbox"/> DC Mains <input checked="" type="checkbox"/> External Circuit - not Mains connected - <input checked="" type="checkbox"/> ES1 <input type="checkbox"/> ES2 <input type="checkbox"/> ES3
Supply % Tolerance	<input type="checkbox"/> +10%/-10% <input type="checkbox"/> +20%/-15% <input type="checkbox"/> + ___ %/ - ___ % <input checked="" type="checkbox"/> None
Supply Connection – Type	<input type="checkbox"/> pluggable equipment type A - <input type="checkbox"/> non-detachable supply cord <input type="checkbox"/> appliance coupler <input type="checkbox"/> direct plug-in <input type="checkbox"/> mating connector <input type="checkbox"/> pluggable equipment type B - <input type="checkbox"/> non-detachable supply cord <input type="checkbox"/> appliance coupler <input type="checkbox"/> permanent connection <input type="checkbox"/> mating connector <input checked="" type="checkbox"/> other: <u>not directly connected to the mains</u>
Considered current rating of protective device as part of building or equipment installation.....:	N/A Installation location: <input type="checkbox"/> building; <input type="checkbox"/> equipment
Equipment mobility.....:	<input checked="" type="checkbox"/> movable <input type="checkbox"/> hand-held <input type="checkbox"/> transportable <input type="checkbox"/> stationary <input type="checkbox"/> for building-in <input type="checkbox"/> direct plug-in <input type="checkbox"/> rack-mounting <input type="checkbox"/> wall-mounted
Over voltage category (OVC)	<input type="checkbox"/> OVC I <input type="checkbox"/> OVC II <input type="checkbox"/> OVC III <input type="checkbox"/> OVC IV <input checked="" type="checkbox"/> other: <u>not directly connected to the mains</u>
Class of equipment	<input type="checkbox"/> Class I <input type="checkbox"/> Class II <input checked="" type="checkbox"/> Class III
Access location	<input type="checkbox"/> restricted access location <input checked="" type="checkbox"/> N/A
Pollution degree (PD)	<input type="checkbox"/> PD 1 <input checked="" type="checkbox"/> PD 2 <input type="checkbox"/> PD 3
Manufacturer's specified maximum operating ambient:	<u>40</u> °C
IP protection class	<input checked="" type="checkbox"/> IPX0 <input type="checkbox"/> IP___
Power Systems	<input type="checkbox"/> TN <input type="checkbox"/> TT <input type="checkbox"/> IT - ___ V _{L-L}
Altitude during operation (m)	<input type="checkbox"/> 2000 m or less <input checked="" type="checkbox"/> <u>5000</u> m
Altitude of test laboratory (m)	<input checked="" type="checkbox"/> 2000 m or less <input type="checkbox"/> ___ m
Mass of equipment (kg)	<input checked="" type="checkbox"/> 3.49kg (with base weight for 27.0 inch models) <input checked="" type="checkbox"/> 2.68kg (with base weight for 23.8 inch models)
POSSIBLE TEST CASE VERDICTS:	
- test case does not apply to the test object	N/A
- test object does meet the requirement.....:	P (Pass)

- test object does not meet the requirement.....:	F (Fail)
- test object not yet conducted	N/T
TESTING:	
Date of receipt of test item	26.Aug.2020
Date (s) of performance of tests	22.Oct.2020 – 29.Oct.2020
GENERAL REMARKS:	
<p>“(See Enclosure #)” refers to additional information appended to the report. “(See appended table)” refers to a table appended to the report.</p> <p>Throughout this report a <input type="checkbox"/> comma / <input checked="" type="checkbox"/> point is used as the decimal separator.</p>	
Manufacturer’s Declaration per sub-clause 4.2.5 of IEC60068-2-21:	
The application for obtaining a CB Test Certificate includes more than one factory location and a declaration from the Manufacturer stating that the sample(s) submitted for evaluation is (are) representative of the products from each factory has been provided	<input checked="" type="checkbox"/> Yes <input type="checkbox"/> Not applicable
When differences exist; they shall be identified in the General product information section.	
Name and address of factory (ies).....:	
1 TPV Display Technology (Wuhan) Co., Ltd Unique No.11 Zhuankou Development District of Economic Technological Development Zone , 430056 Wuhan City, P. R. China 2 TPV Electronics (Fujian) Co., Ltd. Shangzheng, Yuan Hong Road Fuqing City, Fujian, P.R.China 3 L&T Display Technology (Fujian) Ltd Optoelectronic Park, Rongqiao Economic and Technological Development Zone Fuqing, 350301 Fujian, P.R. China 4 TPV Electronics (Fujian) Co., Ltd. Rongqiao Economic and Technological Development Zone Fuqing City, Fujian, P.R.China 5 TPV Display Technology (Beihai) Co.,Ltd. China Electronic Beihai Industry Park, Northeast of the Crossing between Taiwan Road and Jilin Road, Beihai City, Guangxi, P.R.China 6 TPV Display Technology (China) Co., Ltd No.106 Jinghai 3 Rd., BDA, 100176 Beijing, P. R. China 7 Trend Smart CE Mexico S de RL de CV Avenida Sor Juana Ines de la Cruz de 19602 Nueva Tijuana, 22435 Tijuana Baja California, MEXICO 8 TPV Technology(Qingdao) Co.,Ltd. NO.99 Huoju Road, High-tech Industrial Development Zone, Qingdao City, Shandong, P. R. China 9 Envision Indústria de Produtos Eletrônicos Ltda. Av. Torquato Tapajós, 2236, Flores - CEP 69058-830 - Manaus/AM Brazil 10 Pro Concept Manufacturer Co., Ltd. 88/1 Moo 12, Soi Phetkasem 120, Phetkasem Road, Omnoi, Krathumbaen, Samutsakhon 74130, Thailand	

11	TPV Technology (Thailand) Co., Ltd. No.267 Mu7, Tha Tum Sub- District, Si Maha Pho District,Prachin Buri Province, Thailand	
12	TPV Electronics (Fujian) Co., Ltd. Optoelectronic Park, Rongqiao Economic and Technological Development Zone, Fuqing City, 350301, Fujian, P. R. China	
13	GeneTouch Corp. No. 9 Neixi Rd., Luzhu Dist., Taoyuan City, 33852 Taiwan	
GENERAL PRODUCT INFORMATION:		
Product Description –		
The models are LCD Monitor intended for general office use and information technology equipment with following features:		
<ol style="list-style-type: none"> 1. LCD Type: TFT LCD with LED backlight. 2. External approved adapter ADPC1925EX, which are evaluated with altitude 5000m and maximum ambient temperature 40°C. The output of approved external adapter complied with ES1 and PS2. 3. Main board 715G9284 with HDMI, VGA and audio-out ports (all data ports are optional). Main board 715G9620 with HDMI, DVI, VGA, audio-in and audio-out ports (all data ports are optional). 4. The external plastic enclosure is regarded as decorative part. 5. Base stand (optional use), made of min. HB material. 6. Maximum declared ambient: 40°C. 		
<u>Definition of variable(s):</u>		
Variable:	Range of variable:	Content:
*	0-9, A-Z, a-z, – , \ , / , + or blank	Represent different enclosure colour for marketing purpose, no constructional differences.
Model Differences –		
23.8 inch models are identical to 27.0 inch models except for panel and plastic enclosure size.		
Additional application considerations –		
N/A		

ENERGY SOURCE IDENTIFICATION AND CLASSIFICATION TABLE:	
(Note 1: Identify the following six (6) energy source forms based on the origin of the energy.) (Note 2: The identified classification e.g., ES2, TS1, should be with respect to its ability to cause pain or injury on the body or its ability to ignite a combustible material. Any energy source can be declared Class 3 as a worse case classification e.g. PS3, ES3.)	
Electrically-caused injury (Clause 5): (Note: Identify type of source, list sub-assembly or circuit designation and corresponding energy source classification) Example: +5 V dc input ES1	
Source of electrical energy	Corresponding classification (ES)
All circuit on main boards	ES1
All ports of main boards	ES1
Electrically-caused fire (Clause 6): (Note: List sub-assembly or circuit designation and corresponding energy source classification) Example: Battery pack (maximum 85 watts): PS2	
Source of power or PIS	Corresponding classification (PS)
All circuits on main boards	PS2
All data ports of main boards	PS2
Injury caused by hazardous substances (Clause 7) (Note: Specify hazardous chemicals, whether produces ozone or other chemical construction not addressed as part of the component evaluation.) Example: Liquid in filled component Glycol	
Source of hazardous substances	Corresponding chemical
N/A	N/A
Mechanically-caused injury (Clause 8) (Note: List moving part(s), fan, special installations, etc. & corresponding MS classification based on Table 35.) Example: Wall mount unit MS2	
Source of kinetic/mechanical energy	Corresponding classification (MS)
Sharp edges and corners	MS1
Equipment mass	MS1
Thermal burn injury (Clause 9) (Note: Identify the surface or support, and corresponding energy source classification based on type of part, location, operating temperature and contact time in Table 38.) Example: Hand-held scanner – thermoplastic enclosure TS1	
Source of thermal energy	Corresponding classification (TS)
Accessible parts	TS1
Radiation (Clause 10) (Note: List the types of radiation present in the product and the corresponding energy source classification.) Example: DVD – Class 1 Laser Product RS1	
Type of radiation	Corresponding classification (RS)
Indicating lights	RS1
LED backlight of LCD panel	RS1

ENERGY SOURCE DIAGRAM

Indicate which energy sources are included in the energy source diagram. Insert diagram below

ES1, PS2 (all circuit)

For main board 715G9284

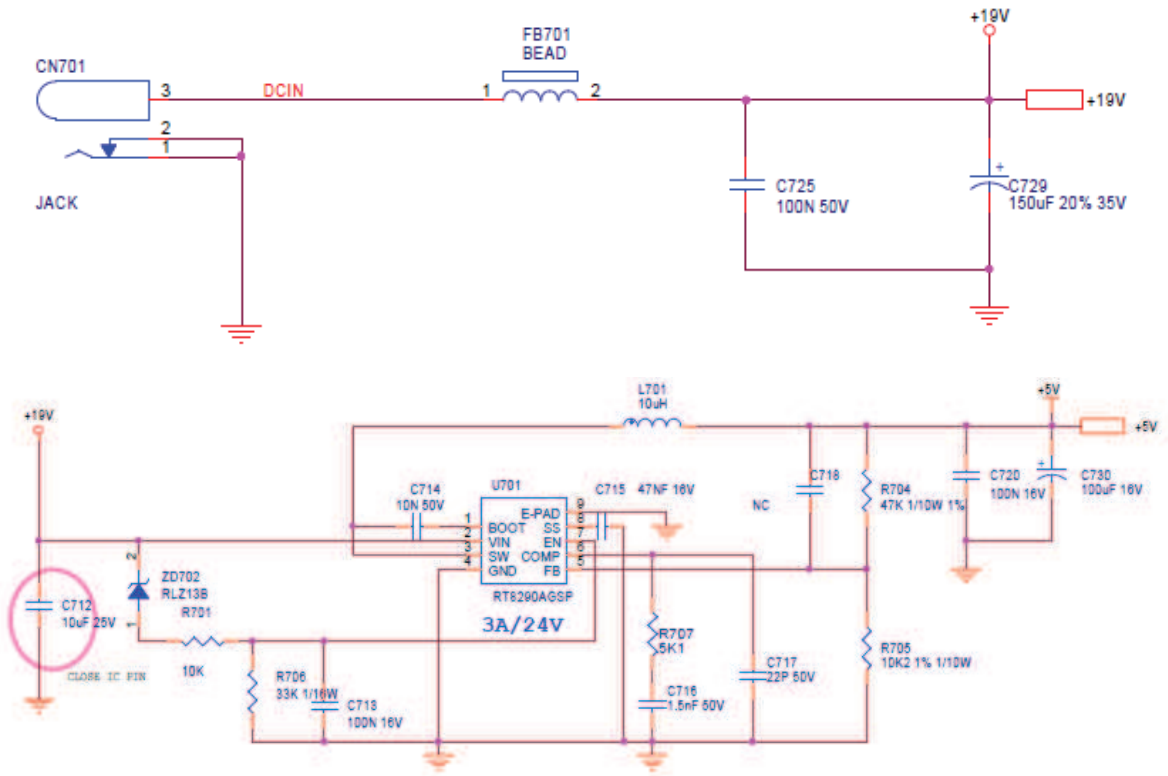

For main board 715G9620

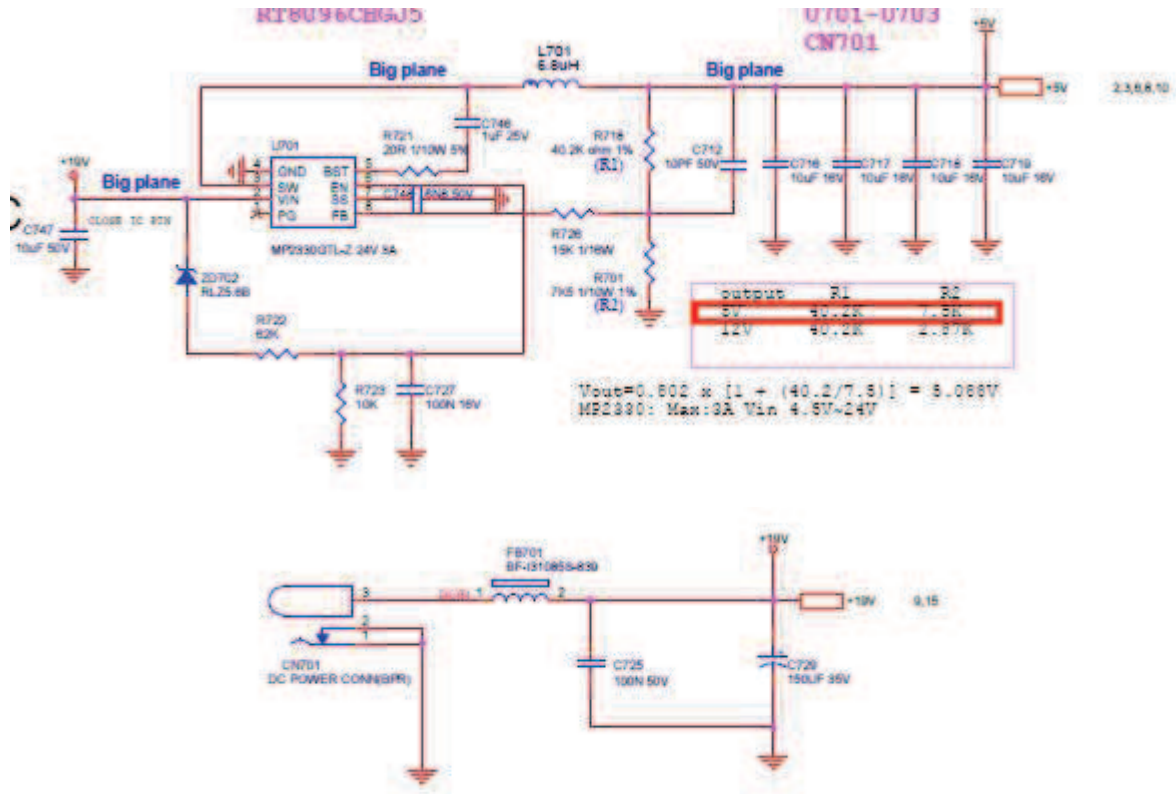

OVERVIEW OF EMPLOYED SAFEGUARDS				
Clause	Possible Hazard			
5.1	Electrically-caused injury			
Body Part (e.g. Ordinary)	Energy Source (ES3: Primary Filter circuit)	Safeguards		
		Basic	Supplementary	Reinforced (Enclosure)
Ordinary	ES1: All ports of main boards	N/A	N/A	N/A
6.1	Electrically-caused fire			
Material part (e.g. mouse enclosure)	Energy Source (PS2: 100 Watt circuit)	Safeguards		
		Basic	Supplementary	Reinforced
Combustible materials of main boards	PS2	Ignition not occur	Mounted on V-1 min. PCB	--
7.1	Injury caused by hazardous substances			
Body Part (e.g., skilled)	Energy Source (hazardous material)	Safeguards		
		Basic	Supplementary	Reinforced
N/A	N/A	N/A	N/A	N/A
8.1	Mechanically-caused injury			
Body Part (e.g. Ordinary)	Energy Source (MS3: High Pressure Lamp)	Safeguards		
		Basic	Supplementary	Reinforced (Enclosure)
Ordinary	MS1: Equipment mass	N/A	N/A	N/A
9.1	Thermal Burn			
Body Part (e.g., Ordinary)	Energy Source (TS2)	Safeguards		
		Basic	Supplementary	Reinforced
Ordinary	TS1: Accessible parts	N/A	N/A	N/A
10.1	Radiation			
Body Part (e.g., Ordinary)	Energy Source (Output from audio port)	Safeguards		
		Basic	Supplementary	Reinforced
Ordinary	RS1: Indicating lights	N/A	N/A	N/A
Ordinary	RS1: LED backlight of LCD panel	N/A	N/A	N/A
Supplementary information:				
(1) See attached energy source diagram for additional details.				
(2) "N" – Normal Condition; "A" – Abnormal Condition; "S" Single Fault				

IEC 62368-1			
Clause	Requirement + Test	Result - Remark	Verdict
4	GENERAL REQUIREMENTS		P
4.1.1	Acceptance of materials, components and subassemblies	See appended table 4.1.2.	P
4.1.2	Use of components	Components which are certified to IEC and/or national standards are used correctly within their ratings. Components not covered by IEC standards are tested under the conditions present in the equipment.	P
4.1.3	Equipment design and construction	No accessible part which could cause injury.	P
4.1.15	Markings and instructions	(See Annex F)	P
4.4.4	Safeguard robustness	EUT supplied by approved AC/DC adapters are considered as ES1, no hazardous live parts inside.	N/A
4.4.4.2	Steady force tests		N/A
4.4.4.3	Drop tests		N/A
4.4.4.4	Impact tests		N/A
4.4.4.5	Internal accessible safeguard enclosure and barrier tests		N/A
4.4.4.6	Glass Impact tests	Laminated glass used.	N/A
4.4.4.7	Thermoplastic material tests		N/A
4.4.4.8	Air comprising a safeguard		N/A
4.4.4.9	Accessibility and safeguard effectiveness		N/A
4.5	Explosion	No explosion occurs during normal/abnormal operation and single fault conditions.	P
4.6	Fixing of conductors		N/A
4.6.1	Fix conductors not to defeat a safeguard		N/A
4.6.2	10 N force test applied to		N/A
4.7	Equipment for direct insertion into mains socket - outlets		N/A
4.7.2	Mains plug part complies with the relevant standard		N/A
4.7.3	Torque (Nm)		N/A
4.8	Products containing coin/button cell batteries	No lithium coin/button batteries used.	N/A
4.8.2	Instructional safeguard		N/A
4.8.3	Battery Compartment Construction		N/A
	Means to reduce the possibility of children removing the battery		—
4.8.4	Battery Compartment Mechanical Tests		N/A

IEC 62368-1			
Clause	Requirement + Test	Result - Remark	Verdict
4.8.5	Battery Accessibility		N/A
4.9	Likelihood of fire or shock due to entry of conductive object.....:	Complied.	P
5	ELECTRICALLY-CAUSED INJURY		P
5.2.1	Electrical energy source classifications.....:	EUT supplied by approved AC/DC adapters considered as ES1, no hazardous live parts inside.	P
5.2.2	ES1, ES2 and ES3 limits	See below.	P
5.2.2.2	Steady-state voltage and current.....:	(See appended table 5.2)	P
5.2.2.3	Capacitance limits.....:		N/A
5.2.2.4	Single pulse limits.....:		N/A
5.2.2.5	Limits for repetitive pulses.....:		N/A
5.2.2.6	Ringing signals.....:		N/A
5.2.2.7	Audio signals.....:	(See Clause E.1)	N/A
5.3	Protection against electrical energy sources	ES1.	N/A
5.3.1	General Requirements for accessible parts to ordinary, instructed and skilled persons	See "OVERVIEW OF EMPLOYED SAFEGUARDS" table.	N/A
5.3.2.1	Accessibility to electrical energy sources and safeguards	ES1.	N/A
5.3.2.2	Contact requirements		N/A
	a) Test with test probe from Annex V.....:		N/A
	b) Electric strength test potential (V).....:		N/A
	c) Air gap (mm).....:		N/A
5.3.2.4	Terminals for connecting stripped wire	No such terminals.	N/A
5.4	Insulation materials and requirements		N/A
5.4.1.2	Properties of insulating material		N/A
5.4.1.3	Humidity conditioning.....:		N/A
5.4.1.4	Maximum operating temperature for insulating materials.....:		N/A
5.4.1.5	Pollution degree.....:	Pollution degree 2.	—
5.4.1.5.2	Test for pollution degree 1 environment and for an insulating compound		N/A
5.4.1.5.3	Thermal cycling		N/A
5.4.1.6	Insulation in transformers with varying dimensions		N/A
5.4.1.7	Insulation in circuits generating starting pulses		N/A
5.4.1.8	Determination of working voltage		N/A
5.4.1.9	Insulating surfaces		N/A
5.4.1.10	Thermoplastic parts on which conductive metallic parts are directly mounted		N/A

IEC 62368-1			
Clause	Requirement + Test	Result - Remark	Verdict
5.4.1.10.2	Vicat softening temperature..... :		N/A
5.4.1.10.3	Ball pressure :		N/A
5.4.2	Clearances		N/A
5.4.2.2	Determining clearance using peak working voltage		N/A
5.4.2.3	Determining clearance using required withstand voltage :		N/A
	a) a.c. mains transient voltage :		—
	b) d.c. mains transient voltage :		—
	c) external circuit transient voltage :		—
	d) transient voltage determined by measurement ... : :		—
5.4.2.4	Determining the adequacy of a clearance using an electric strength test		N/A
5.4.2.5	Multiplication factors for clearances and test voltages :		N/A
5.4.3	Creepage distances :		N/A
5.4.3.1	General		N/A
5.4.3.3	Material Group :		—
5.4.4	Solid insulation		N/A
5.4.4.2	Minimum distance through insulation :		N/A
5.4.4.3	Insulation compound forming solid insulation		N/A
5.4.4.4	Solid insulation in semiconductor devices		N/A
5.4.4.5	Cemented joints		N/A
5.4.4.6	Thin sheet material		N/A
5.4.4.6.1	General requirements		N/A
5.4.4.6.2	Separable thin sheet material		N/A
	Number of layers (pcs) :		N/A
5.4.4.6.3	Non-separable thin sheet material		N/A
5.4.4.6.4	Standard test procedure for non-separable thin sheet material :		N/A
5.4.4.6.5	Mandrel test		N/A
5.4.4.7	Solid insulation in wound components		N/A
5.4.4.9	Solid insulation at frequencies >30 kHz :		N/A
5.4.5	Antenna terminal insulation		N/A
5.4.5.1	General		N/A
5.4.5.2	Voltage surge test		N/A
	Insulation resistance (M Ω)..... :		—
5.4.6	Insulation of internal wire as part of supplementary safeguard :		N/A

IEC 62368-1			
Clause	Requirement + Test	Result - Remark	Verdict
5.4.7	Tests for semiconductor components and for cemented joints		N/A
5.4.8	Humidity conditioning		N/A
	Relative humidity (%).....:		—
	Temperature (°C)		—
	Duration (h)		—
5.4.9	Electric strength test		N/A
5.4.9.1	Test procedure for a solid insulation type test		N/A
5.4.9.2	Test procedure for routine tests		N/A
5.4.10	Protection against transient voltages between external circuit		N/A
5.4.10.1	Parts and circuits separated from external circuits		N/A
5.4.10.2	Test methods		N/A
5.4.10.2.1	General		N/A
5.4.10.2.2	Impulse test		N/A
5.4.10.2.3	Steady-state test.....:		N/A
5.4.11	Insulation between external circuits and earthed circuitry		N/A
5.4.11.1	Exceptions to separation between external circuits and earth		N/A
5.4.11.2	Requirements		N/A
	Rated operating voltage U_{op} (V).....:		—
	Nominal voltage U_{peak} (V).....:		—
	Max increase due to variation U_{sp}		—
	Max increase due to ageing ΔU_{sa}		—
	$U_{op} = U_{peak} + \Delta U_{sp} + \Delta U_{sa}$		—
5.5	Components as safeguards		N/A
5.5.1	General		N/A
5.5.2	Capacitors and RC units		N/A
5.5.2.1	General requirement		N/A
5.5.2.2	Safeguards against capacitor discharge after disconnection of a connector.....:		N/A
5.5.3	Transformers		N/A
5.5.4	Optocouplers		N/A
5.5.5	Relays		N/A
5.5.6	Resistors		N/A
5.5.7	SPD's		N/A
5.5.7.1	Use of an SPD connected to reliable earthing		N/A

IEC 62368-1			
Clause	Requirement + Test	Result - Remark	Verdict
5.5.7.2	Use of an SPD between mains and protective earth		N/A
5.5.8	Insulation between the mains and external circuit consisting of a coaxial cable		N/A
5.6	Protective conductor		N/A
5.6.2	Requirement for protective conductors		N/A
5.6.2.1	General requirements		N/A
5.6.2.2	Colour of insulation		N/A
5.6.3	Requirement for protective earthing conductors		N/A
	Protective earthing conductor size (mm ²)		—
5.6.4	Requirement for protective bonding conductors		N/A
5.6.4.1	Protective bonding conductors		N/A
	Protective bonding conductor size (mm ²).		—
	Protective current rating (A)		—
5.6.4.3	Current limiting and overcurrent protective devices		N/A
5.6.5	Terminals for protective conductors		N/A
5.6.5.1	Requirement		N/A
	Conductor size (mm ²), nominal thread diameter (mm).		N/A
5.6.5.2	Corrosion		N/A
5.6.6	Resistance of the protective system		N/A
5.6.6.1	Requirements		N/A
5.6.6.2	Test Method Resistance (Ω).....		N/A
5.6.7	Reliable earthing		N/A
5.7	Prospective touch voltage, touch current and protective conductor current		N/A
5.7.2	Measuring devices and networks		N/A
5.7.2.1	Measurement of touch current		N/A
5.7.2.2	Measurement of prospective touch voltage		N/A
5.7.3	Equipment set-up, supply connections and earth connections		N/A
	System of interconnected equipment (separate connections/single connection)	Single equipment.	—
	Multiple connections to mains (one connection at a time/simultaneous connections)	Single connection.	—
5.7.4	Earthed conductive accessible parts		N/A
5.7.5	Protective conductor current		N/A
	Supply Voltage (V).....		—
	Measured current (mA).....		—

IEC 62368-1			
Clause	Requirement + Test	Result - Remark	Verdict
	Instructional Safeguard.....:		N/A
5.7.6	Prospective touch voltage and touch current due to external circuits		N/A
5.7.6.1	Touch current from coaxial cables		N/A
5.7.6.2	Prospective touch voltage and touch current from external circuits		N/A
5.7.7	Summation of touch currents from external circuits		N/A
	a) Equipment with earthed external circuits Measured current (mA).....:		N/A
	b) Equipment whose external circuits are not referenced to earth. Measured current (mA).....:		N/A

6	ELECTRICALLY- CAUSED FIRE		P
6.2	Classification of power sources (PS) and potential ignition sources (PIS)		P
6.2.2	Power source circuit classifications	See ENERGY SOURCE IDENTIFICATION AND CLASSIFICATION TABLE.	P
6.2.2.1	General		P
6.2.2.2	Power measurement for worst-case load fault ... :		N/A
6.2.2.3	Power measurement for worst-case power source fault:		N/A
6.2.2.4	PS1:		N/A
6.2.2.5	PS2:	(See appended table 6.2.2)	P
6.2.2.6	PS3:	(See appended table 6.2.2)	P
6.2.3	Classification of potential ignition sources		P
6.2.3.1	Arcing PIS:	EUT supplied by approved AC/DC adapters complied with PS2.	N/A
6.2.3.2	Resistive PIS:	All components located within the equipment are considered as resistive PIS.	P
6.3	Safeguards against fire under normal operating and abnormal operating conditions		P
6.3.1 (a)	No ignition and attainable temperature value less than 90 % defined by ISO 871 or less than 300 °C for unknown materials:	(See appended table 5.4.1.5, 6.3.2, 9.0, B.2.6)	P
6.3.1 (b)	Combustible materials outside fire enclosure		N/A
6.4	Safeguards against fire under single fault conditions		P
6.4.1	Safeguard Method	The method "Control fire spread" is selected.	P
6.4.2	Reduction of the likelihood of ignition under single fault conditions in PS1 circuits		N/A
6.4.3	Reduction of the likelihood of ignition under single fault conditions in PS2 and PS3 circuits		N/A

IEC 62368-1			
Clause	Requirement + Test	Result - Remark	Verdict
6.4.3.1	General		N/A
6.4.3.2	Supplementary Safeguards		N/A
	Special conditions if conductors on printed boards are opened or peeled		N/A
6.4.3.3	Single Fault Conditions :		N/A
	Special conditions for temperature limited by fuse		N/A
6.4.4	Control of fire spread in PS1 circuits		N/A
6.4.5	Control of fire spread in PS2 circuits	See below.	P
6.4.5.2	Supplementary safeguards:	- All components in a PS2 are mounted on V-1 class material of printed boards and comply with the requirements of the relevant IEC components standard. - Certified wire insulation is used.	P
6.4.6	Control of fire spread in PS3 circuit		N/A
6.4.7	Separation of combustible materials from a PIS		N/A
6.4.7.1	General:		N/A
6.4.7.2	Separation by distance		N/A
6.4.7.3	Separation by a fire barrier		N/A
6.4.8	Fire enclosures and fire barriers		N/A
6.4.8.1	Fire enclosure and fire barrier material properties		N/A
6.4.8.2.1	Requirements for a fire barrier		N/A
6.4.8.2.2	Requirements for a fire enclosure		N/A
6.4.8.3	Constructional requirements for a fire enclosure and a fire barrier		N/A
6.4.8.3.1	Fire enclosure and fire barrier openings		N/A
6.4.8.3.2	Fire barrier dimensions		N/A
6.4.8.3.3	Top Openings in Fire Enclosure: dimensions (mm):		N/A
	Needle Flame test		N/A
6.4.8.3.4	Bottom Openings in Fire Enclosure, condition met a), b) and/or c) dimensions (mm):		N/A
	Flammability tests for the bottom of a fire enclosure:		N/A
6.4.8.3.5	Integrity of the fire enclosure, condition met: a), b) or c):		N/A
6.4.8.4	Separation of PIS from fire enclosure and fire barrier distance (mm) or flammability rating :		N/A
6.5	Internal and external wiring		P

IEC 62368-1			
Clause	Requirement + Test	Result - Remark	Verdict
6.5.1	Requirements	Internal or external wiring materials are compliant with IEC 60950-1 according to Sub-clause 4.1.1. Furthermore, the test method described in IEC 60695-11-21 is considered equivalent to that test wiring materials for VW-1. All internal wiring are using VW-1 material.	P
6.5.2	Cross-sectional area (mm ²)	See above.	—
6.5.3	Requirements for interconnection to building wiring		N/A
6.6	Safeguards against fire due to connection to additional equipment	The connections to additional equipment are supplied by PS2.	P
	External port limited to PS2 or complies with Clause Q.1		N/A

7	INJURY CAUSED BY HAZARDOUS SUBSTANCES		N/A
7.2	Reduction of exposure to hazardous substances		N/A
7.3	Ozone exposure		N/A
7.4	Use of personal safeguards (PPE)		N/A
	Personal safeguards and instructions		—
7.5	Use of instructional safeguards and instructions		N/A
	Instructional safeguard (ISO 7010).....		—
7.6	Batteries.....		N/A

8	MECHANICALLY-CAUSED INJURY		P
8.1	General		P
8.2	Mechanical energy source classifications	See ENERGY SOURCE IDENTIFICATION AND CLASSIFICATION TABLE.	P
8.3	Safeguards against mechanical energy sources	See "OVERVIEW OF EMPLOYED SAFEGUARDS" table.	P
8.4	Safeguards against parts with sharp edges and corners	No sharp edges and corners in accessible area.	P
8.4.1	Safeguards		N/A
8.5	Safeguards against moving parts		N/A
8.5.1	MS2 or MS3 part required to be accessible for the function of the equipment		N/A
8.5.2	Instructional Safeguard		—
8.5.4	Special categories of equipment comprising moving parts		N/A

IEC 62368-1			
Clause	Requirement + Test	Result - Remark	Verdict
8.5.4.1	Large data storage equipment		N/A
8.5.4.2	Equipment having electromechanical device for destruction of media		N/A
8.5.4.2.1	Safeguards and Safety Interlocks		N/A
8.5.4.2.2	Instructional safeguards against moving parts		N/A
	Instructional Safeguard		—
8.5.4.2.3	Disconnection from the supply		N/A
8.5.4.2.4	Probe type and force (N)		N/A
8.5.5	High Pressure Lamps		N/A
8.5.5.1	Energy Source Classification		N/A
8.5.5.2	High Pressure Lamp Explosion Test		N/A
8.6	Stability	See below	P
8.6.1	Product classification	See Clause 8.2 & 8.3	P
	Instructional Safeguard		—
8.6.2	Static stability	MS1 equipment.	P
8.6.2.2	Static stability test	Test was conducted by client's request. Unit did not fall over when tilted to an angle of 10° from its normal upright position.	P
	Applied Force	See above.	—
8.6.2.3	Downward Force Test	Not floor standing equipment.	N/A
8.6.3	Relocation stability test		N/A
	Unit configuration during 10° tilt.....		—
8.6.4	Glass slide test		N/A
8.6.5	Horizontal force test (Applied Force).....		N/A
	Position of feet or movable parts		—
8.7	Equipment mounted to wall or ceiling		N/A
8.7.1	Mounting Means (Length of screws (mm) and mounting surface)		N/A
8.7.2	Direction and applied force		N/A
8.8	Handles strength		N/A
8.8.1	Classification		N/A
8.8.2	Applied Force		N/A
8.9	Wheels or casters attachment requirements		N/A
8.9.1	Classification		N/A
8.9.2	Applied force		—
8.10	Carts, stands and similar carriers		N/A
8.10.1	General		N/A

IEC 62368-1			
Clause	Requirement + Test	Result - Remark	Verdict
8.10.2	Marking and instructions		N/A
	Instructional Safeguard		—
8.10.3	Cart, stand or carrier loading test and compliance		N/A
	Applied force		—
8.10.4	Cart, stand or carrier impact test		N/A
8.10.5	Mechanical stability		N/A
	Applied horizontal force (N)		—
8.10.6	Thermoplastic temperature stability (°C).....		N/A
8.11	Mounting means for rack mounted equipment		N/A
8.11.1	General		N/A
8.11.2	Product Classification		N/A
8.11.3	Mechanical strength test, variable <i>N</i>		N/A
8.11.4	Mechanical strength test 250N, including end stops		N/A
8.12	Telescoping or rod antennas		N/A
	Button/Ball diameter (mm)		—

9	THERMAL BURN INJURY		
9.2	Thermal energy source classifications	See ENERGY SOURCE IDENTIFICATION AND CLASSIFICATION TABLE.	P
9.3	Safeguard against thermal energy sources	No safeguards are required for TS1.	N/A
9.4	Requirements for safeguards		N/A
9.4.1	Equipment safeguard		N/A
9.4.2	Instructional safeguard		N/A

10	RADIATION		P
10.2	Radiation energy source classification	See below.	P
10.2.1	General classification	The following parts are considered as RS1 without tests: - Indicating lights; - LED backlight of LCD panel	P
10.3	Protection against laser radiation		N/A
	Laser radiation that exists equipment:		—
	Normal, abnormal, single-fault.....		N/A
	Instructional safeguard		—
	Tool		—
10.4	Protection against visible, infrared, and UV radiation		N/A

IEC 62368-1			
Clause	Requirement + Test	Result - Remark	Verdict
10.4.1	General		N/A
10.4.1.a)	RS3 for Ordinary and instructed persons		N/A
10.4.1.b)	RS3 accessible to a skilled person		N/A
	Personal safeguard (PPE) instructional safeguard		—
10.4.1.c)	Equipment visible, IR, UV does not exceed RS1 .. :		N/A
10.4.1.d)	Normal, abnormal, single-fault conditions		N/A
10.4.1.e)	Enclosure material employed as safeguard is opaque		N/A
10.4.1.f)	UV attenuation		N/A
10.4.1.g)	Materials resistant to degradation UV		N/A
10.4.1.h)	Enclosure containment of optical radiation		N/A
10.4.1.i)	Exempt Group under normal operating conditions		N/A
10.4.2	Instructional safeguard		N/A
10.5	Protection against x-radiation		N/A
10.5.1	X- radiation energy source that exists equipment :		N/A
	Normal, abnormal, single fault conditions		N/A
	Equipment safeguards		N/A
	Instructional safeguard for skilled person		N/A
10.5.3	Most unfavourable supply voltage to give maximum radiation		—
	Abnormal and single-fault condition		N/A
	Maximum radiation (pA/kg)		N/A
10.6	Protection against acoustic energy sources		N/A
10.6.1	General		N/A
10.6.2	Classification		N/A
	Acoustic output, dB(A)		N/A
	Output voltage, unweighted r.m.s. :		N/A
10.6.4	Protection of persons		N/A
	Instructional safeguards		N/A
	Equipment safeguard prevent ordinary person to RS2		—
	Means to actively inform user of increase sound pressure		—
	Equipment safeguard prevent ordinary person to RS2		—
10.6.5	Requirements for listening devices (headphones, earphones, etc.)		N/A
10.6.5.1	Corded passive listening devices with analog		N/A

IEC 62368-1			
Clause	Requirement + Test	Result - Remark	Verdict
	input		
	Input voltage with 94 dB(A) L_{Aeq} acoustic pressure output..... :		—
10.6.5.2	Corded listening devices with digital input		N/A
	Maximum dB(A)..... :		—
10.6.5.3	Cordless listening device		N/A
	Maximum dB(A)..... :		—

B	NORMAL OPERATING CONDITION TESTS, ABNORMAL OPERATING CONDITION TESTS AND SINGLE FAULT CONDITION TESTS		P
B.2	Normal Operating Conditions	See below	P
B.2.1	General requirements..... :	(See Test Item Particulars and appended test tables)	P
	Audio Amplifiers and equipment with audio amplifiers..... :	No such equipment.	N/A
B.2.3	Supply voltage and tolerances		N/A
B.2.5	Input test..... :	(See appended table B.2.5)	P
B.3	Simulated abnormal operating conditions		P
B.3.1	General requirements..... :		N/A
B.3.2	Covering of ventilation openings		N/A
B.3.3	D.C. mains polarity test		N/A
B.3.4	Setting of voltage selector..... :		N/A
B.3.5	Maximum load at output terminals..... :		N/A
B.3.6	Reverse battery polarity		N/A
B.3.7	Abnormal operating conditions as specified in Clause E.2.		N/A
B.3.8	Safeguards functional during and after abnormal operating conditions		N/A
B.4	Simulated single fault conditions		P
B.4.2	Temperature controlling device open or short-circuited..... :		N/A
B.4.3	Motor tests		N/A
B.4.3.1	Motor blocked or rotor locked increasing the internal ambient temperature..... :		N/A
B.4.4	Short circuit of functional insulation	(See appended table B.4)	P
B.4.4.1	Short circuit of clearances for functional insulation	(See appended table B.4)	P
B.4.4.2	Short circuit of creepage distances for functional insulation	(See appended table B.4)	P
B.4.4.3	Short circuit of functional insulation on coated printed boards		N/A

IEC 62368-1			
Clause	Requirement + Test	Result - Remark	Verdict
B.4.5	Short circuit and interruption of electrodes in tubes and semiconductors	(See appended table B.4)	P
B.4.6	Short circuit or disconnect of passive components	(See appended table B.4)	P
B.4.7	Continuous operation of components		N/A
B.4.8	Class 1 and Class 2 energy sources within limits during and after single fault conditions		P
B.4.9	Battery charging under single fault conditions.... :		N/A
C	UV RADIATION		N/A
C.1	Protection of materials in equipment from UV radiation		N/A
C.1.2	Requirements		N/A
C.1.3	Test method		N/A
C.2	UV light conditioning test		N/A
C.2.1	Test apparatus		N/A
C.2.2	Mounting of test samples		N/A
C.2.3	Carbon-arc light-exposure apparatus		N/A
C.2.4	Xenon-arc light exposure apparatus		N/A
D	TEST GENERATORS		N/A
D.1	Impulse test generators		N/A
D.2	Antenna interface test generator		N/A
D.3	Electronic pulse generator		N/A
E	TEST CONDITIONS FOR EQUIPMENT CONTAINING AUDIO AMPLIFIERS		N/A
E.1	Audio amplifier normal operating conditions	No such equipment.	N/A
	Audio signal voltage (V)..... :		—
	Rated load impedance (Ω) :		—
E.2	Audio amplifier abnormal operating conditions		N/A
F	EQUIPMENT MARKINGS, INSTRUCTIONS, AND INSTRUCTIONAL SAFEGUARDS		P
F.1	General requirements	See below.	P
	Instructions – Language :	English. Versions in other languages will be provided when national certificate approval.	—
F.2	Letter symbols and graphical symbols		P
F.2.1	Letter symbols according to IEC60027-1		P
F.2.2	Graphic symbols IEC, ISO or manufacturer specific		P
F.3	Equipment markings		P
F.3.1	Equipment marking locations	The equipment marking is provided and is readily visible in operator access area.	P

IEC 62368-1			
Clause	Requirement + Test	Result - Remark	Verdict
F.3.2	Equipment identification markings	See below.	P
F.3.2.1	Manufacturer identification	See copy of marking plate.	—
F.3.2.2	Model identification	See copy of marking plate.	—
F.3.3	Equipment rating markings	See below.	P
F.3.3.1	Equipment with direct connection to mains	See below.	P
F.3.3.2	Equipment without direct connection to mains		N/A
F.3.3.3	Nature of supply voltage..... :	See copy of marking plate.	—
F.3.3.4	Rated voltage	See copy of marking plate.	—
F.3.3.4	Rated frequency	See copy of marking plate.	—
F.3.3.6	Rated current or rated power..... :	See copy of marking plate.	—
F.3.3.7	Equipment with multiple supply connections		N/A
F.3.4	Voltage setting device		N/A
F.3.5	Terminals and operating devices	See below.	P
F.3.5.1	Mains appliance outlet and socket-outlet markings		N/A
F.3.5.2	Switch position identification marking..... :		N/A
F.3.5.3	Replacement fuse identification and rating markings		N/A
F.3.5.4	Replacement battery identification marking		N/A
F.3.5.5	Terminal marking location		N/A
F.3.6	Equipment markings related to equipment classification		N/A
F.3.6.1	Class I Equipment	Class III equipment.	N/A
F.3.6.1.1	Protective earthing conductor terminal		N/A
F.3.6.1.2	Neutral conductor terminal		N/A
F.3.6.1.3	Protective bonding conductor terminals		N/A
F.3.6.2	Class II equipment (IEC60417-5172)		N/A
F.3.6.2.1	Class II equipment with or without functional earth		N/A
F.3.6.2.2	Class II equipment with functional earth terminal marking		N/A
F.3.7	Equipment IP rating marking		—
F.3.8	External power supply output marking		N/A
F.3.9	Durability, legibility and permanence of marking	See below.	P
F.3.10	Test for permanence of markings	Marking is durable and legible. The marking plate has no curling and is not able to be removed easily.	P
F.4	Instructions		P

IEC 62368-1			
Clause	Requirement + Test	Result - Remark	Verdict
	a) Equipment for use in locations where children not likely to be present - marking		N/A
	b) Instructions given for installation or initial use	Provided in user's manual.	P
	c) Equipment intended to be fastened in place		N/A
	d) Equipment intended for use only in restricted access area		N/A
	e) Audio equipment terminals classified as ES3 and other equipment with terminals marked in accordance F.3.6.1		N/A
	f) Protective earthing employed as safeguard		N/A
	g) Protective earthing conductor current exceeding ES 2 limits	Not exceed the ES2 limits.	N/A
	h) Symbols used on equipment	Graphical symbols not used as an instructional safeguard.	N/A
	i) Permanently connected equipment not provided with all-pole mains switch		N/A
j)	j) Replaceable components or modules providing safeguard function		N/A
F.5	Instructional safeguards	No instructional safeguard required.	N/A
	Where "instructional safeguard" is referenced in the test report it specifies the required elements, location of marking and/or instruction		N/A
G	COMPONENTS		N/A
G.1	Switches		N/A
G.1.1	General requirements		N/A
G.1.2	Ratings, endurance, spacing, maximum load		N/A
G.2	Relays		N/A
G.2.1	General requirements		N/A
G.2.2	Overload test		N/A
G.2.3	Relay controlling connectors supply power		N/A
G.2.4	Mains relay, modified as stated in G.2		N/A
G.3	Protection Devices		N/A
G.3.1	Thermal cut-offs		N/A
G.3.1.1a) &b)	Thermal cut-outs separately approved according to IEC 60730 with conditions indicated in a) & b)		N/A
G.3.1.1c)	Thermal cut-outs tested as part of the equipment as indicated in c)		N/A
G.3.1.2	Thermal cut-off connections maintained and secure		N/A
G.3.2	Thermal links		N/A
G.3.2.1a)	Thermal links separately tested with IEC 60691		N/A

IEC 62368-1			
Clause	Requirement + Test	Result - Remark	Verdict
G.3.2.1b)	Thermal links tested as part of the equipment		N/A
	Aging hours (H)		—
	Single Fault Condition		—
	Test Voltage (V) and Insulation Resistance (Ω) ..		—
G.3.3	PTC Thermistors		N/A
G.3.4	Overcurrent protection devices		N/A
G.3.5	Safeguards components not mentioned in G.3.1 to G.3.5		N/A
G.3.5.1	Non-resettable devices suitably rated and marking provided		N/A
G.3.5.2	Single faults conditions		N/A
G.4	Connectors		N/A
G.4.1	Spacings		N/A
G.4.2	Mains connector configuration		N/A
G.4.3	Plug is shaped that insertion into mains socket-outlets or appliance coupler is unlikely		N/A
G.5	Wound Components		N/A
G.5.1	Wire insulation in wound components		N/A
G.5.1.2 a)	Two wires in contact inside wound component, angle between 45° and 90°		N/A
G.5.1.2 b)	Construction subject to routine testing		N/A
G.5.2	Endurance test on wound components		N/A
G.5.2.1	General test requirements		N/A
G.5.2.2	Heat run test		N/A
	Time (s).....		—
	Temperature (°C).....		—
G.5.2.3	Wound Components supplied by mains		N/A
G.5.3	Transformers		N/A
G.5.3.1	Requirements applied (IEC61204-7, IEC61558-1/-2, and/or IEC62368-1)		N/A
	Position		—
	Method of protection		—
G.5.3.2	Insulation		N/A
	Protection from displacement of windings		—
G.5.3.3	Overload test		N/A
G.5.3.3.1	Test conditions		N/A
G.5.3.3.2	Winding Temperatures testing in the unit		N/A
G.5.3.3.3	Winding Temperatures - Alternative test method		N/A
G.5.4	Motors		N/A

IEC 62368-1			
Clause	Requirement + Test	Result - Remark	Verdict
G.5.4.1	General requirements		N/A
	Position		—
G.5.4.2	Test conditions		N/A
G.5.4.3	Running overload test		N/A
G.5.4.4	Locked-rotor overload test		N/A
	Test duration (days)		—
G.5.4.5	Running overload test for d.c. motors in secondary circuits		N/A
G.5.4.5.2	Tested in the unit		N/A
	Electric strength test (V)		—
G.5.4.5.3	Tested on the Bench - Alternative test method; test time (h)		N/A
	Electric strength test (V)		—
G.5.4.6	Locked-rotor overload test for d.c. motors in secondary circuits		N/A
G.5.4.6.2	Tested in the unit		N/A
	Maximum Temperature		N/A
	Electric strength test (V)		N/A
G.5.4.6.3	Tested on the bench - Alternative test method; test time (h).....		N/A
	Electric strength test (V)		N/A
G.5.4.7	Motors with capacitors		N/A
G.5.4.8	Three-phase motors		N/A
G.5.4.9	Series motors		N/A
	Operating voltage		—
G.6	Wire Insulation		N/A
G.6.1	General		N/A
G.6.2	Solvent-based enamel wiring insulation		N/A
G.7	Mains supply cords		N/A
G.7.1	General requirements	No mains supply cord provided.	N/A
	Type.....		—
	Rated current (A).....		—
	Cross-sectional area (mm ²), (AWG).....		—
G.7.2	Compliance and test method		N/A
G.7.3	Cord anchorages and strain relief for non-detachable power supply cords		N/A
G.7.3.2	Cord strain relief		N/A
G.7.3.2.1	Requirements		N/A
	Strain relief test force (N).....		—

IEC 62368-1			
Clause	Requirement + Test	Result - Remark	Verdict
G.7.3.2.2	Strain relief mechanism failure		N/A
G.7.3.2.3	Cord sheath or jacket position, distance (mm).....:		—
G.7.3.2.4	Strain relief comprised of polymeric material		N/A
G.7.4	Cord Entry.....:		N/A
G.7.5	Non-detachable cord bend protection		N/A
G.7.5.1	Requirements		N/A
G.7.5.2	Mass (g)		—
	Diameter (m).....:		—
	Temperature (°C).....:		—
G.7.6	Supply wiring space		N/A
G.7.6.2	Stranded wire		N/A
G.7.6.2.1	Test with 8 mm strand		N/A
G.8	Varistors		N/A
G.8.1	General requirements		N/A
G.8.2	Safeguard against shock		N/A
G.8.3	Safeguard against fire		N/A
G.8.3.2	Varistor overload test.....:		N/A
G.8.3.3	Temporary overvoltage.....:		N/A
G.9	Integrated Circuit (IC) Current Limiters		N/A
G.9.1 a)	Manufacturer defines limit at max. 5A.		N/A
G.9.1 b)	Limiters do not have manual operator or reset		N/A
G.9.1 c)	Supply source does not exceed 250 VA		—
G.9.1 d)	IC limiter output current (max. 5A)		—
G.9.1 e)	Manufacturers' defined drift		—
G.9.2	Test Program 1		N/A
G.9.3	Test Program 2		N/A
G.9.4	Test Program 3		N/A
G.10	Resistors		N/A
G.10.1	General requirements		N/A
G.10.2	Resistor test		N/A
G.10.3	Test for resistors serving as safeguards between the mains and an external circuit consisting of a coaxial cable		N/A
G.10.3.1	General requirements		N/A
G.10.3.2	Voltage surge test		N/A
G.10.3.3	Impulse test		N/A
G.11	Capacitor and RC units		N/A

IEC 62368-1			
Clause	Requirement + Test	Result - Remark	Verdict
G.11.1	General requirements		N/A
G.11.2	Conditioning of capacitors and RC units		N/A
G.11.3	Rules for selecting capacitors		N/A
G.12	Optocouplers		N/A
	Optocouplers comply with IEC 60747-5-5:2007 Spacing or Electric Strength Test (specify option and test results)		N/A
	Type test voltage V_{ini}		—
	Routine test voltage, $V_{ini,b}$		—
G.13	Printed boards		N/A
G.13.1	General requirements		N/A
G.13.2	Uncoated printed boards		N/A
G.13.3	Coated printed boards		N/A
G.13.4	Insulation between conductors on the same inner surface		N/A
	Compliance with cemented joint requirements (Specify construction)		—
G.13.5	Insulation between conductors on different surfaces		N/A
	Distance through insulation		N/A
	Number of insulation layers (pcs)		—
G.13.6	Tests on coated printed boards		N/A
G.13.6.1	Sample preparation and preliminary inspection		N/A
G.13.6.2a)	Thermal conditioning		N/A
G.13.6.2b)	Electric strength test		N/A
G.13.6.2c)	Abrasion resistance test		N/A
G.14	Coating on components terminals		N/A
G.14.1	Requirements		N/A
G.15	Liquid filled components		N/A
G.15.1	General requirements		N/A
G.15.2	Requirements		N/A
G.15.3	Compliance and test methods		N/A
G.15.3.1	Hydrostatic pressure test		N/A
G.15.3.2	Creep resistance test		N/A
G.15.3.3	Tubing and fittings compatibility test		N/A
G.15.3.4	Vibration test		N/A
G.15.3.5	Thermal cycling test		N/A
G.15.3.6	Force test		N/A

IEC 62368-1			
Clause	Requirement + Test	Result - Remark	Verdict
G.15.4	Compliance		N/A
G.16	IC including capacitor discharge function (ICX)		N/A
a)	Humidity treatment in accordance with sc5.4.8 – 120 hours		N/A
b)	Impulse test using circuit 2 with $U_c =$ to transient voltage		N/A
C1)	Application of ac voltage at 110% of rated voltage for 2.5 minutes		N/A
C2)	Test voltage		—
D1)	10,000 cycles on and off using capacitor with smallest capacitance resistor with largest resistance specified by manufacturer		N/A
D2)	Capacitance		—
D3)	Resistance		—
H	CRITERIA FOR TELEPHONE RINGING SIGNALS		N/A
H.1	General		N/A
H.2	Method A		N/A
H.3	Method B		N/A
H.3.1	Ringling signal		N/A
H.3.1.1	Frequency (Hz)		—
H.3.1.2	Voltage (V)		—
H.3.1.3	Cadence; time (s) and voltage (V)		—
H.3.1.4	Single fault current (mA):.....		—
H.3.2	Tripping device and monitoring voltage.....		N/A
H.3.2.1	Conditions for use of a tripping device or a monitoring voltage complied with		N/A
H.3.2.2	Tripping device		N/A
H.3.2.3	Monitoring voltage (V)		—
J	INSULATED WINDING WIRES FOR USE WITHOUT INTERLEAVED INSULATION		N/A
	General requirements		N/A
K	SAFETY INTERLOCKS		N/A
K.1	General requirements		N/A
K.2	Components of safety interlock safeguard mechanism		N/A
K.3	Inadvertent change of operating mode		N/A
K.4	Interlock safeguard override		N/A
K.5	Fail-safe		N/A
	Compliance		N/A
K.6	Mechanically operated safety interlocks		N/A

IEC 62368-1			
Clause	Requirement + Test	Result - Remark	Verdict
K.6.1	Endurance requirement		N/A
K.6.2	Compliance and Test method		N/A
K.7	Interlock circuit isolation		N/A
K.7.1	Separation distance for contact gaps & interlock circuit elements (type and circuit location)		N/A
K.7.2	Overload test, Current (A)		N/A
K.7.3	Endurance test		N/A
K.7.4	Electric strength test		N/A
L	DISCONNECT DEVICES		N/A
L.1	General requirements		N/A
L.2	Permanently connected equipment		N/A
L.3	Parts that remain energized		N/A
L.4	Single phase equipment		N/A
L.5	Three-phase equipment		N/A
L.6	Switches as disconnect devices		N/A
L.7	Plugs as disconnect devices		N/A
L.8	Multiple power sources		N/A
M	EQUIPMENT CONTAINING BATTERIES AND THEIR PROTECTION CIRCUITS		N/A
M.1	General requirements		N/A
M.2	Safety of batteries and their cells		N/A
M.2.1	Requirements		N/A
M.2.2	Compliance and test method (identify method) ...		N/A
M.3	Protection circuits		N/A
M.3.1	Requirements		N/A
M.3.2	Tests		N/A
	- Overcharging of a rechargeable battery		N/A
	- Unintentional charging of a non-rechargeable battery		N/A
	- Reverse charging of a rechargeable battery		N/A
	- Excessive discharging rate for any battery		N/A
M.3.3	Compliance		N/A
M.4	Additional safeguards for equipment containing secondary lithium battery		N/A
M.4.1	General		N/A
M.4.2	Charging safeguards		N/A
M.4.2.1	Charging operating limits		N/A
M.4.2.2a)	Charging voltage, current and temperature		—
M.4.2.2 b)	Single faults in charging circuitry.....		—

IEC 62368-1			
Clause	Requirement + Test	Result - Remark	Verdict
M.4.3	Fire Enclosure		N/A
M.4.4	Endurance of equipment containing a secondary lithium battery		N/A
M.4.4.2	Preparation		N/A
M.4.4.3	Drop and charge/discharge function tests		N/A
	Drop		N/A
	Charge		N/A
	Discharge		N/A
M.4.4.4	Charge-discharge cycle test		N/A
M.4.4.5	Result of charge-discharge cycle test		N/A
M.5	Risk of burn due to short circuit during carrying		N/A
M.5.1	Requirement		N/A
M.5.2	Compliance and Test Method (Test of P.2.3)		N/A
M.6	Prevention of short circuits and protection from other effects of electric current		N/A
M.6.1	Short circuits		N/A
M.6.1.1	General requirements		N/A
M.6.1.2	Test method to simulate an internal fault		N/A
M.6.1.3	Compliance (Specify M.6.1.2 or alternative method)		N/A
M.6.2	Leakage current (mA)		N/A
M.7	Risk of explosion from lead acid and NiCd batteries		N/A
M.7.1	Ventilation preventing explosive gas concentration		N/A
M.7.2	Compliance and test method		N/A
M.8	Protection against internal ignition from external spark sources of lead acid batteries		N/A
M.8.1	General requirements		N/A
M.8.2	Test method		N/A
M.8.2.1	General requirements		N/A
M.8.2.2	Estimation of hypothetical volume V_z (m ³ /s).....		—
M.8.2.3	Correction factors		—
M.8.2.4	Calculation of distance d (mm)		—
M.9	Preventing electrolyte spillage		N/A
M.9.1	Protection from electrolyte spillage		N/A
M.9.2	Tray for preventing electrolyte spillage		N/A
M.10	Instructions to prevent reasonably foreseeable misuse (Determination of compliance: inspection, data review; or abnormal testing)		N/A

IEC 62368-1			
Clause	Requirement + Test	Result - Remark	Verdict
N	ELECTROCHEMICAL POTENTIALS		P
	Metal(s) used.....:	Complied.	—
O	MEASUREMENT OF CREEPAGE DISTANCES AND CLEARANCES		N/A
	Figures O.1 to O.20 of this Annex applied	Class III equipment.	—
P	SAFEGUARDS AGAINST ENTRY OF FOREIGN OBJECTS AND SPILLAGE OF INTERNAL LIQUIDS		N/A
P.1	General requirements		N/A
P.2.2	Safeguards against entry of foreign object		N/A
	Location and Dimensions (mm)		—
P.2.3	Safeguard against the consequences of entry of foreign object		N/A
P.2.3.1	Safeguards against the entry of a foreign object		N/A
	Openings in transportable equipment		N/A
	Transportable equipment with metalized plastic parts.....:		N/A
P.2.3.2	Openings in transportable equipment in relation to metallized parts of a barrier or enclosure (identification of supplementary safeguard)		N/A
P.3	Safeguards against spillage of internal liquids		N/A
P.3.1	General requirements		N/A
P.3.2	Determination of spillage consequences		N/A
P.3.3	Spillage safeguards		N/A
P.3.4	Safeguards effectiveness		N/A
P.4	Metallized coatings and adhesive securing parts		N/A
P.4.2 a)	Conditioning testing		N/A
	Tc (°C).....:		—
	Tr (°C).....:		—
	Ta (°C).....:		—
P.4.2 b)	Abrasion testing		N/A
P.4.2 c)	Mechanical strength testing		N/A
Q	CIRCUITS INTENDED FOR INTERCONNECTION WITH BUILDING WIRING		N/A
Q.1	Limited power sources		N/A
Q.1.1 a)	Inherently limited output		N/A
Q.1.1 b)	Impedance limited output		N/A
	- Regulating network limited output under normal operating and simulated single fault condition		N/A
Q.1.1 c)	Overcurrent protective device limited output		N/A
Q.1.1 d)	IC current limiter complying with G.9		N/A
Q.1.2	Compliance and test method		N/A

IEC 62368-1			
Clause	Requirement + Test	Result - Remark	Verdict
Q.2	Test for external circuits – paired conductor cable		N/A
	Maximum output current (A)		—
	Current limiting method		—
R	LIMITED SHORT CIRCUIT TEST		N/A
R.1	General requirements	Class III equipment.	N/A
R.2	Determination of the overcurrent protective device and circuit		N/A
R.3	Test method Supply voltage (V) and short-circuit current (A).		N/A
S	TESTS FOR RESISTANCE TO HEAT AND FIRE		N/A
S.1	Flammability test for fire enclosures and fire barrier materials of equipment where the steady state power does not exceed 4 000 W		N/A
	Samples, material.....		—
	Wall thickness (mm)		—
	Conditioning (°C).....		—
	Test flame according to IEC 60695-11-5 with conditions as set out		N/A
	- Material not consumed completely		N/A
	- Material extinguishes within 30s		N/A
	- No burning of layer or wrapping tissue		N/A
S.2	Flammability test for fire enclosure and fire barrier integrity		N/A
	Samples, material.....		—
	Wall thickness (mm)		—
	Conditioning (°C).....		—
	Test flame according to IEC 60695-11-5 with conditions as set out		N/A
	Test specimen does not show any additional hole		N/A
S.3	Flammability test for the bottom of a fire enclosure		N/A
	Samples, material.....		—
	Wall thickness (mm)		—
	Cheesecloth did not ignite		N/A
S.4	Flammability classification of materials		N/A
S.5	Flammability test for fire enclosures and fire barrier materials of equipment where the steady state power does not exceed 4 000 W		N/A
	Samples, material.....		—
	Wall thickness (mm)		—

IEC 62368-1			
Clause	Requirement + Test	Result - Remark	Verdict
	Conditioning (test condition), (°C)		—
	Test flame according to IEC 60695-11-20 with conditions as set out		N/A
	After every test specimen was not consumed completely		N/A
	After fifth flame application, flame extinguished within 1 min		N/A
T	MECHANICAL STRENGTH TESTS		N/A
T.1	General requirements		N/A
T.2	Steady force test, 10 N		N/A
T.3	Steady force test, 30 N		N/A
T.4	Steady force test, 100 N		N/A
T.5	Steady force test, 250 N		N/A
T.6	Enclosure impact test		N/A
	Fall test		N/A
	Swing test		N/A
T.7	Drop test		N/A
T.8	Stress relief test.....		N/A
T.9	Impact Test (glass)		N/A
T.9.1	General requirements		N/A
T.9.2	Impact test and compliance		N/A
	Impact energy (J)		—
	Height (m).....		—
T.10	Glass fragmentation test.....		N/A
T.11	Test for telescoping or rod antennas		N/A
	Torque value (Nm)		—
U	MECHANICAL STRENGTH OF CATHODE RAY TUBES (CRT) AND PROTECTION AGAINST THE EFFECTS OF IMPLOSION		N/A
U.1	General requirements		N/A
U.2	Compliance and test method for non-intrinsically protected CRTs		N/A
U.3	Protective Screen.....		N/A
V	DETERMINATION OF ACCESSIBLE PARTS (FINGERS, PROBES AND WEDGES)		N/A
V.1	Accessible parts of equipment		N/A
V.2	Accessible part criterion		N/A

IEC 62368-1			
Clause	Requirement + Test	Result - Remark	Verdict

4.1.2	TABLE: List of critical components					P
Object / part No.	Manufacturer/ trademark	Type / model	Technical data	Standard	Mark(s) of conformity ¹	
LCD Panel with LED backlight type (for 27.0 inch models)	TPV	TPM270W**- ***** (* can be 0~9, A~Z, "." or blank)	27.0 inch TFT LCD, power consumption: 20.9W; LED array voltage: 54V	--	Tested in equipment	
Alt.)	BOE	MV270***-*** (* can be 0~9, A~Z, "." or blank)	27.0 inch TFT LCD, power consumption: 10.6W; LED array voltage: 59V	--	Tested in equipment	
Alt.)	CHIMEI INNOLUX	M270HGE-*** (* can be 0-9, A-Z or blank for marketing purpose only)	27.0 inch TFT LCD, power consumption: 22.72W; LED Array Voltage: 60V	--	Tested in equipment	
Alt.)	SAMSUNG	LTM270HP** (* can be 0-9, A-Z or blank for marketing purpose only)	27.0 inch TFT LCD, power consumption: 21.3W; LED Array Voltage: 47.0V	--	Tested in equipment	
Alt.)	LG Display	LM270W** (* can be 0-9, A-Z or blank for marketing purpose only)	27.0 inch TFT LCD, power consumption: 24.1W; LED Array Voltage: 54.7V	--	Tested in equipment	
Alt.)	INNOLUX	M270K**-*** (* can be 0-9, A-Z or blank for marketing purpose only)	27.0 inch TFT LCD, power consumption: 27.9W; LED Array Voltage: 36.3V	--	Tested in equipment	
Alt.)	L&T	LM270W**-**** (* can be 0-9, A-Z or blank for marketing purpose only)	27.0 inch TFT LCD, power consumption: 14.75W; LED Array Voltage: 47.3V	--	Tested in equipment	
LCD Panel with LED backlight type (for 23.8 inch models)	TPV	TPM236W**- ***** (* can be 0~9, A~Z, "." or blank)	23.8 inch TFT LCD power consumption: 15.9 W; LED array voltage: 57.8V	--	Tested in equipment	
Alt.)	L&T	LM238***-**** (* can be 0-9, A-Z or blank for marketing purpose only)	23.8 inch TFT LCD, power consumption: 12.1W; LED Array Voltage: 38.8V	--	Tested in equipment	

IEC 62368-1					
Clause	Requirement + Test		Result - Remark		Verdict
Alt.)	BOE	MV238***-*** (* can be 0-9, A-Z or blank for marketing purpose only)	23.8 inch TFT LCD, power consumption: 16.9W; LED Array Voltage: 51.5V	--	Tested in equipment
Alt.)	LG Display	LM238WF*-**** (* can be 0-9, A-Z or blank for marketing purpose only)	23.8 inch TFT LCD, power consumption: 17.76W; LED Array Voltage: 58.9V	--	Tested in equipment
Alt.)	TPV	TPM238WF* (* can be 0-9, A-Z or blank for marketing purpose only)	23.8 inch TFT LCD, power consumption: 15.11W; LED Array Voltage: 52.7V	--	Tested in equipment
Plastic Enclosure	LOTTE ADVANCED MATERIALS CO LTD (SAMSUNG SDI)	SD-0150(+), VH-0810(+), VE-0812(+), NH-1000T(+)(&), GC-0700(++)(RR28), GC-0700A(RR), GC-0750(+)(RR70), VE-1890(+), BF-0675(+), BF-0670(+), NH-1017(p), NH-1017SG(+), BF-0677(+), HS-7000(+), HG-0760(+), NE-1030(+), HR-1360(+), LX-0951(+), TH-1100(+), TN-1100(+)	HB or better, min. 1.6mm thickness	UL 94	UL (E115797)
Alt.)	GRAND PACIFIC PETROCHEMICAL CORP	D-150, D-1000, D-1000A	HB or better, min. 1.6mm thickness	UL 94	UL (E88637)
Alt.)	CHI MEI CORPORATION	PA-757(+), PH-88, PA-756S	HB or better, min. 1.6mm thickness	UL 94	UL (E56070)
Alt.)	ALBIS PLASTIC GMBH	GP-35, GP-22, 495F	HB or better, min. 1.6mm thickness	UL 94	UL (E80168)

IEC 62368-1					
Clause	Requirement + Test		Result - Remark		Verdict
Alt.)	COVESTRO DEUTSCHLAND AG [PC RESINS]	FR3000 series, FR3005 series	HB or better, min. 1.6mm thickness	UL 94	UL (E41613)
Alt.)	LG CHEM LTD	HF380NS, HF380X, AF312T1, LUPOY GN- 5001TF(#), GN-5001RFD, LUPOY GN- 5008HF(#), LUPOY GP- 5008BF(#), SE750(#), XG568(#), XG569(#), GP-1000L, GP-1000F(#), SE750(#), LUPOY GN- 5001RF(T)	HB or better, min. 1.6mm thickness	UL 94	UL (E67171)
Alt.)	CHI LIN	GA-1(aaa)	HB or better, min. 1.6mm thickness	UL 94	UL (E177071)
Alt.)	PONTEX	AFE5000N, AFE5100N, 9004BK	HB or better, min. 1.6mm thickness	UL 94	UL (E205938)
Alt.)	TOTAL PETROCHEMIC ALS SOUTH EAST ASIA PTE LTD	3441, 260-XX	HB or better, min. 1.6mm thickness	UL 94	UL (E314268)
Alt.)	DOOSAN CORPORATION ELECTRO- MATERIALS BG	DS-1107A; DS-1202G; DS-7106	HB or better, min. 1.6mm thickness	UL 94	UL (E103670)
Alt.)	SABIC JAPAN L L C	C6600(GG)(X)(VS) , C6600E (VS)(X)	HB or better, min. 1.6mm thickness	UL 94	UL (E207780)

IEC 62368-1					
Clause	Requirement + Test		Result - Remark		Verdict
Alt.)	KINGFA SCI & TECH CO LTD	4418, 5197, FRABS-518, HIPS-5197, HF-606, HF-626, FRABS-518, GAR-011C, JH960 6(M), FRHIPS-960, GAR-011, GAR-011(L65), GAR-011(L85), GAR-011(HG6), CK-100, CK-900, HIPS-4418, HIPS-3399, HIPS-CM(ee), HIPS-HG(ee), HIPS-510 (o), HIPS-550, CK-61(M) (##), RS-(hh)0, HP-126, ABS-660, ABS-122, GAR-322, GAR-332, GAR-220, H12, G360, CK-55(M) (##), CK-58(M) (##), GAR-011C, GAR-011(ww)	HB or better, min. 1.6mm thickness	UL 94	UL (E171666)
Alt.)	QINGDAO HAIER NEW MATERIAL R & D CO LTD	HRABS-RS, HRABS-HG, CR-3003	HB or better, min. 1.6mm thickness	UL 94	UL (E230779)
Alt.)	DONGGUAN HINGLONG PLASTIC TECHNOLOGY CO LTD	HL-ABS-PCR85, HL-ABS-PCR65, HL-ABS-PCR35	HB or better, min. 1.6mm thickness	UL 94	UL (E345434)
Alt.)	ORINKO (HEFEI) ADVANCED PLASTIC CO LTD	ABS-3070H, HIPS-2000, ABS-3406, ABS-340X	HB or better, min. 1.6mm thickness	UL 94	UL (E328304)
Alt.)	WISTRON ADVANCED MATERIALS (KUNSHAN) CO LTD	GA(M)(b)(c)	HB or better, min. 1.6mm thickness	UL 94	UL (E359575)

IEC 62368-1					
Clause	Requirement + Test			Result - Remark	Verdict
Alt.)	UNIC TECHNOLOGY CORP	UR-3006+(RXX), UR-200+	HB or better, min. 1.6mm thickness	UL 94	UL (E135175)
Alt.)	GUO HENG (DONGGUAN)	YOUHO(#####)(Y)	HB or better, min. 1.6mm thickness	UL 94	UL (E471190)
Alt.)	HUIZHOU WOTE	2100	HB or better, min. 1.6mm thickness	UL 94	UL (E310240)
Alt.)	TEIJIN LIMITED RESIN AND PLASTIC	TN-7500(c), TN-7500F(#), MN-3600V(#), MN-3600H(#)	HB or better, min. 1.6mm thickness	UL 94	UL (E98529)
Alt.)	INEOS STYROLUTION GROUP GMBH	495F GR2, 495F KG2, 495F GR21, 495F KG21, PC2065	HB or better, min. 1.6mm thickness	UL 94	UL (E108538)
Alt.)	STYRON	STYRON A-TECH 1200	HB or better, min. 1.6mm thickness	UL 94	UL (E162447)
Alt.)	YONGHUI	A34G3885-BQV-A1X-****	HB or better, min. 1.6mm thickness	UL 94	UL
Alt.)	CHI LIN QINGDAO GUOEN TECHNOLOGY CO LTD	GA1535, ABS21(xx)G-A, ABS2030A, ABS20(xx)B	HB or better, min. 1.6mm thickness	UL 94	UL
Power Adapter	TPV	ADPC1925EX	IP: 100-240 Vac, 50-60 Hz, 1.3A. OP: 19Vdc, 1.31A, 40°C, Class I, 5000m Comply with ES1 and PS2.	IEC 62368-1: 2014	CB by Nemko (Certificate No. NO106527)
PCB	CHANG CHUN PLASTICS CO LTD	CCP-508	V-1 or better, min. 105°C	UL 94	UL E108591
Alt.)	Interchangeable	Interchangeable	V-1 or better, min. 105°C	UL 94	UL
Rating information of components which are not critical components					
Base stand	Interchangeable	Interchangeable	HB or better	UL 94	UL
Power cord set listed below by client's request					
Mains cord set (Saudi Arabia) (Optional)					
Plug	I-SHENG	SP-62	13A,250V or 10A, 250V or 5A, 250V	SASO 2203:2018	Intertek (ASTA)

IEC 62368-1					
Clause	Requirement + Test		Result - Remark		Verdict
Cable	I-SHENG	H05VV-F	2X0.75mm ²	SASO 2203:2018	Intertek (ASTA)
Plug	CHANGHZOU Hongchang Electronics CO., Ltd	DTII-3P-22	13A,250V or 5A, 250V	SASO 2203:2018	Intertek (ASTA)
Cable	CHANGHZOU Hongchang Electronics CO., Ltd	H05VV-F	2 x 0.75 mm ²	SASO 2203:2018	Intertek (ASTA)
Plug	HONGLIN	HL-044	13A,250V or 5A, 250V	SASO 2203:2018	Intertek (ASTA)
Cable	HONGLIN	HL-052	2 x 0.75 mm ²	SASO 2203:2018	Intertek (ASTA)
Plug	FUND RESOURCES ELECTRIC INDUSTRY CO.,LTD	BS-01J	13A,250V or 10A,250V or 5A, 250V	SASO 2203:2018	Intertek (ASTA)
Cable	FUND RESOURCES ELECTRIC INDUSTRY CO.,LTD	H05VV-F	2 x 0.75 mm ²	SASO 2203:2018	Intertek (ASTA)
Plug	Longwell	LP-61L, LP-61LA	13A, 250V	SASO 2203:2018	Intertek (ASTA)
Cable	Longwell	H05VV-F	2 x 0.75 mm ²	SASO 2203:2018	Intertek (ASTA)
Plug	ASAP	A12-0031-AC2, A12-0058-AC2, A12-0059-AC2	3A, 250V or 5A, 250V or 10A, 250V or 13A, 250V	SASO 2203:2018	Intertek (ASTA)
Cable	ASAP	H05VV-F	2 x 0.75 mm ²	SASO 2203:2018	Intertek (ASTA)
Plug	ASAP	A12-0136-AC2, A12-0137-AC2	3A, 250V or 5A, 250V or 10A, 250V or 13A, 250V	SASO 2203:2018	Intertek (ASTA)
Cable	ASAP	H05VV-F	2 x 0.75 mm ²	SASO 2203:2018	Intertek (ASTA)

Supplementary information:
 1) Provided evidence ensures the agreed level of compliance.

IEC 62368-1			
Clause	Requirement + Test	Result - Remark	Verdict
4.8.4, 4.8.5	TABLE: Lithium coin/button cell batteries mechanical tests		N/A
(The following mechanical tests are conducted in the sequence noted.)			
4.8.4.2	TABLE: Stress Relief test		—
	Part	Material	Oven Temperature (°C)
4.8.4.3	TABLE: Battery replacement test		—
	Battery part no. :		—
	Battery Installation/withdrawal	Battery Installation/Removal Cycle	Comments
		1	
		2	
		3	
		4	
		5	
		6	
		7	
		8	
		9	
		10	
4.8.4.4	TABLE: Drop test		—
	Impact Area	Drop Distance	Drop No.
			2
4.8.4.5	TABLE: Impact		—
	Impacts per surface	Surface tested	Impact energy (Nm)
4.8.4.6	TABLE: Crush test		—
	Test position	Surface tested	Crushing Force (N)
			Duration force applied (s)
Supplementary information:			
4.8.5	TABLE: Lithium coin/button cell batteries mechanical test result		N/A
	Test position	Surface tested	Force (N)
			Duration force applied (s)
Supplementary information:			

IEC 62368-1			
Clause	Requirement + Test	Result - Remark	Verdict

5.2	Table: Classification of electrical energy sources		P
------------	---	--	---

5.2.2.2 – Steady State Voltage and Current conditions

No.	Supply Voltage	Location (e.g. circuit designation)	Test conditions	Parameters			ES Class
				U (Vrms or Vpk)	I (Apk or Arms)	Hz	
1	19Vdc	LED driver circuit (Test with main board 715G9284)	Normal	54.2Vdc	--	--	ES1
			Abnormal	54.2Vdc	--	--	
			Single fault – (see table B.4 for details, maximum result recorded)	0Vdc	--	--	
2	19Vdc	LED driver circuit (Test with main board 715G9620)	Normal	55.0Vdc	--	--	ES1
			Abnormal	55.0Vdc	--	--	
			Single fault – (see table B.4 for details, maximum result recorded)	0Vdc	--	--	

5.2.2.3 - Capacitance Limits

No.	Supply Voltage	Location (e.g. circuit designation)	Test conditions	Parameters		ES Class
				Capacitance, nF	Upk (V)	
--	--	--	Normal	--	--	--
			Abnormal	--	--	
			Single fault – SC/OC	--	--	

5.2.2.4 - Single Pulses

No.	Supply Voltage	Location (e.g. circuit designation)	Test conditions	Parameters			ES Class
				Duration (ms)	Upk (V)	lpk (mA)	
--	--	--	Normal	--	--	--	--
			Abnormal	--	--	--	
			Single fault – SC/OC	--	--	--	

5.2.2.5 - Repetitive Pulses

No.	Supply Voltage	Location (e.g. circuit designation)	Test conditions	Parameters			ES Class
				Off time (ms)	Upk (V)	lpk (mA)	
--	--	--	Normal	--	--	--	--
			Abnormal	--	--	--	
			Single fault – SC/OC	--	--	--	

IEC 62368-1			
Clause	Requirement + Test	Result - Remark	Verdict

Test Conditions:

Normal – Max. normal load

Supplementary information: SC=Short Circuit, OC=Open Circuit

5.4.1.4, 6.3.2, 9.0, B.2.6	TABLE: Temperature measurements						P
	Supply voltage (V)	19Vdc	--	--	--	---	
	Ambient T _{min} (°C)	40.0	--	--	--	---	
	Ambient T _{max} (°C)	40.0	--	--	--	---	
	T _{ma} (°C)	40.0	--	--	--	---	
Maximum measured temperature T of part/at:		T (°C)				Allowed T _{max} (°C)	
Test on 27 inch models with main board 715G9284 and panel M270K**-*** (INNOLUX), HDMI mode							
	DC inlet CN701 (on main board)	55.6	--	--	--	70	
	PCB near U401 (on main board)	65.1	--	--	--	105	
	PCB near L701 (on main board)	73.5	--	--	--	105	
	PCB near L702 (on main board)	68.5	--	--	--	105	
	PCB near L801 (on main board)	77.1	--	--	--	105	
	PCB near Q801 (on main board)	78.1	--	--	--	105	
	PCB near U801 (on main board)	77.0	--	--	--	105	
	Ambient	40.0 (19.7)	--	--	--	--	
Touch temperature for accessible part under normal condition							
	Plastic enclosure outside (near U801)	34.9	--	--	--	94	
	Panel surface	34.0	--	--	--	94	
	Button	30.6	--	--	--	77	
	Ambient	25.0 (19.7)	--	--	--	--	
Supplementary information:							
Temperature T of winding:	t ₁ (°C)	R ₁ (Ω)	t ₂ (°C)	R ₂ (Ω)	T (°C)	Allowed T _{max} (°C)	Insulation class
Supplementary information:							
Note 1: T _{ma} should be considered as directed by applicable requirement							
Note 2: T _{ma} is not included in assessment of Touch Temperatures (Clause 9).							

IEC 62368-1							
Clause	Requirement + Test			Result - Remark			Verdict
5.4.1.4, 6.3.2, 9.0, B.2.6	TABLE: Temperature measurements						P
	Supply voltage (V)	19Vdc	--	--	--	--	---
	Ambient T _{min} (°C)	40.0	--	--	--	--	---
	Ambient T _{max} (°C)	40.0	--	--	--	--	---
	T _{ma} (°C)	40.0	--	--	--	--	---
Maximum measured temperature T of part/at:		T (°C)				Allowed T _{max} (°C)	
Test on 23.8 inch models with main board 715G9284 and panel LM238WF*-**** (LG Display), HDMI mode							
	DC inlet CN701 (on main board)	51.9	--	--	--	--	70
	PCB near U401 (on main board)	67.6	--	--	--	--	105
	PCB near L701 (on main board)	72.1	--	--	--	--	105
	PCB near L702 (on main board)	69.8	--	--	--	--	105
	PCB near L801 (on main board)	74.3	--	--	--	--	105
	PCB near Q801 (on main board)	76.4	--	--	--	--	105
	PCB near U801 (on main board)	74.1	--	--	--	--	105
	Ambient	40.0 (19.0)	--	--	--	--	--
Touch temperature for accessible part under normal condition							
	Plastic enclosure outside (near U801)	36.6	--	--	--	--	94
	Panel surface	32.8	--	--	--	--	94
	Button	31.2	--	--	--	--	77
	Ambient	25.0 (19.0)	--	--	--	--	--
Supplementary information:							
Temperature T of winding:	t ₁ (°C)	R ₁ (Ω)	t ₂ (°C)	R ₂ (Ω)	T (°C)	Allowed T _{max} (°C)	Insulation class
Supplementary information:							
Note 1: T _{ma} should be considered as directed by applicable requirement							
Note 2: T _{ma} is not included in assessment of Touch Temperatures (Clause 9).							

IEC 62368-1			
Clause	Requirement + Test	Result - Remark	Verdict
5.4.1.10.2	TABLE: Vicat softening temperature of thermoplastics		N/A
Penetration (mm).....:			—
Object/ Part No./Material		Manufacturer/t rademark	T softening (°C)
Supplementary information:			

5.4.1.10.3	TABLE: Ball pressure test of thermoplastics			N/A
Allowed impression diameter (mm)				—
Object/Part No./Material		Manufacturer/trademark	Test temperature (°C)	Impression diameter (mm)
Supplementary information:				

5.4.2.2, 5.4.2.4 and 5.4.3	TABLE: Minimum Clearances/Creepage distance						N/A
Clearance (cl) and creepage distance (cr) at/of/between:	Up (V)	U r.m.s. (V)	Frequency (kHz)	Required cl (mm)	cl (mm)	Required cr (mm)	cr (mm)
Reinforced:							
Supplementary information:							

5.4.2.3	TABLE: Minimum Clearances distances using required withstand voltage				N/A
Overvoltage Category (OV):					
Pollution Degree:					
Clearance distanced between:	Required withstand voltage	Required cl (mm)	Measured cl (mm)		
Supplementary information:					

5.4.2.4	TABLE: Clearances based on electric strength test			N/A
Test voltage applied between:	Required cl (mm)	Test voltage (kV) peak/ r.m.s. / d.c.	Breakdown Yes / No	
Supplementary information:				

IEC 62368-1					
Clause	Requirement + Test			Result - Remark	Verdict
5.4.4.2, 5.4.4.5 c) 5.4.4.9	TABLE: Distance through insulation measurements				N/A
Distance through insulation di at/of:	Peak voltage (V)	Frequency (kHz)	Material	Required DTI (mm)	DTI (mm)
Supplementary information:					

5.4.9	TABLE: Electric strength tests			N/A
Test voltage applied between:	Voltage shape (AC, DC)	Test voltage (V)	Breakdown Yes / No	
Basic/supplementary:				
Reinforced:				
Supplementary information:				

5.5.2.2	TABLE: Stored discharge on capacitors					N/A
Supply Voltage (V), Hz	Test Location	Operating Condition (N, S)	Switch position On or off	Measured Voltage (after 2 seconds)	ES Classification	
Supplementary information:						
X-capacitors installed for testing are:						
<input type="checkbox"/> Approved						
<input type="checkbox"/> ICX:						
Notes:						
A. Test Location:						
Phase to Neutral; Phase to Phase; Phase to Earth; and/or Neutral to Earth						
B. Operating condition abbreviations:						
N – Normal operating condition (e.g., normal operation, or open fuse); S –Single fault condition						

5.6.6.2	TABLE: Resistance of protective conductors and terminations				N/A
Accessible part	Test current (A)	Duration (min)	Voltage drop (V)	Resistance (mΩ)	
Supplementary information:					

IEC 62368-1			
Clause	Requirement + Test	Result - Remark	Verdict
5.7.2.2, 5.7.4	TABLE: Earthed accessible conductive part		N/A
Supply voltage			—
Location		Test conditions specified in 6.1 of IEC 60990 or Fault Condition No in IEC 60990 clause 6.2.2.1 through 6.2.2.8, except for 6.2.2.7	Touch current (mA)
Line to earth,		1	--
Neutral to earth,		2*	--
Line to secondary connector,		3	--
Neutral to secondary connector,		4	--
Line to metal enclosure,		5	--
Neutral to metal enclosure,		6	--
Line to plastic enclosure with copper foil,		7	--
Neutral to plastic enclosure with copper foil		8	--
Supplementary information: [1] Supply voltage is the anticipated maximum Touch Voltage [2] Earthed neutral conductor [Voltage differences less than 1% or more] [3] Specify method used for measurement as described in IEC 60990 sub-clause 4.3 [4] IEC60990, sub-clause 6.2.2.7, Fault 7 not applicable. [5] (*) IEC60990, sub-clause 6.2.2.2 is not applicable if switch or disconnect device (e.g., appliance coupler) provided. [6] Tested with normal, abnormal and single-fault condition, and maximum value was recorded.			

6.2.2		Table: Electrical power sources (PS) measurements for classification			N/A
Source	Description	Measurement	Max Power after 3 s	Max Power after 5 s [*]	PS Classification
A	--	Power (W) :	--	--	--
		V _A (V) :	--	--	
		I _A (A) :	--	--	
Supplementary information: (*) Measurement taken only when limits at 3 seconds exceed PS1 limits					

6.2.3.1		Table: Determination of Potential Ignition Sources (Arcing PIS)			N/A
Location	Open circuit voltage After 3 s (V _p)	Measured r.m.s current (I _{rms})	Calculated value (V _p x I _{rms})	Arcing PIS? Yes / No	
Supplementary information: 1) An Arcing PIS requires a minimum of 50 V (peak) a.c. or d.c. An Arcing PIS is established when the product of the open circuit voltage (V _p) and normal operating condition rms current (I _{rms}) is greater than 15.					

IEC 62368-1			
Clause	Requirement + Test	Result - Remark	Verdict

6.2.3.2	Table: Determination of Potential Ignition Sources (Resistive PIS)				P
Circuit Location (x-y)	Operating Condition (Normal / Describe Single Fault)	Measured wattage or VA During first 30 s (W / VA)	Measured wattage or VA After 30 s (W / VA)	Protective Circuit, Regulator, or PTC Operated? Yes / No (Comment)	Resistive PIS? Yes/No
3)	3)	3)	3)	--	Yes

Supplementary information:

- 1) A combination of voltmeter, VA and ammeter IA may be used instead of a wattmeter. If a separate voltmeter and ammeter are used, the product of (VA x IA) is used to determine Resistive PIS classification.
- 2) A Resistive PIS: (a) dissipates more than 15 W, measured after 30 s of normal operation, or (b) under single fault conditions has either a power exceeding 100 W measured immediately after the introduction of the fault if electronic circuits, regulators or PTC devices are used, or has an available power exceeding 15 W measured 30 s after introduction of the fault.
- 3) All components located within the EUT are considered as resistive PIS.

8.5.5	TABLE: High Pressure Lamp		N/A
Description	Values	Energy Source Classification	
Lamp type.....:		—	
Manufacturer		—	
Cat no.:		—	
Pressure (cold) (MPa).....:		MS_	
Pressure (operating) (MPa)		MS_	
Operating time (minutes)		—	
Explosion method		—	
Max particle length escaping enclosure (mm) .:		MS_	
Max particle length beyond 1 m (mm).....:		MS_	
Overall result			

Supplementary information:

B.2.5	TABLE: Input test						P
U (V)	I (A)	I rated (A)	P (W)	P rated (W)	Fuse No	I fuse (A)	Condition/status
Test on 27.0 inch models with main board 715G9284 and panel M270K**-*** (INNOLUX)							
VGA mode							
18.34	1.12	1.31	20.54	--	--	--	Max. normal load condition.
HDMI mode							
18.34	1.13	1.31	20.72	--	--	--	Max. normal load condition.
Test on 27.0 inch models with main board 715G9620 and panel M270K**-*** (INNOLUX)							
VGA mode							

IEC 62368-1							
Clause	Requirement + Test			Result - Remark			Verdict
19.0	1.09	1.31	20.40	--	--	--	Max. normal load condition.
HDMI mode							
19.0	1.10	1.31	20.60	--	--	--	Max. normal load condition.
DVI mode							
19.0	1.09	1.31	20.40	--	--	--	Max. normal load condition.
Test on 23.8 inch models with main board 715G9284 and panel LM238WF*-**** (LG Display)							
VGA mode							
18.38	0.89	1.31	16.36	--	--	--	Max. normal load condition.
HDMI mode							
18.35	0.89	1.31	16.33	--	--	--	Max. normal load condition.
Test on 23.8 inch models with main board 715G9620 and panel LM238WF*-**** (LG Display)							
VGA mode							
19.0	0.75	1.31	14.10	--	--	--	Max. normal load condition.
HDMI mode							
19.0	0.80	1.31	15.00	--	--	--	Max. normal load condition.
DVI mode							
19.0	0.75	1.31	14.10	--	--	--	Max. normal load condition.
Supplementary information:							
1. Maximum normal load: maximum brightness, maximum contrast, full white screen.							

B.3	TABLE: Abnormal operating condition tests							N/A
Ambient temperature (°C)							—	
Power source for EUT: Manufacturer, model/type, output rating ...:							—	
Component No.	Abnormal Condition	Supply voltage (V)	Test time (ms)	Fuse no.	Fuse current (A)	T-couple	Temp. (°C)	Observation
Supplementary information:								

IEC 62368-1								
Clause	Requirement + Test				Result - Remark			Verdict
B.4	TABLE: Fault condition tests							P
Ambient temperature (°C)					See below			—
Power source for EUT: Manufacturer, model/type, output rating ...:								—
Component No.	Fault Condition	Supply voltage, (V)	Test time (ms)	Fuse no.	Fuse current, (A)	T-couple	Temp. (°C)	Observation
Test on main board 715G9284								
D801	s-c	19Vdc	5 min	--	--	--	--	Unit shut down, no hazard.
L801	s-c	19Vdc	5 min	--	--	--	--	Unit shut down, no hazard.
Q801	s-c	19Vdc	5 min	--	--	--	--	Unit shut down, no hazard.
C805	s-c	19Vdc	5 min	--	--	--	--	Unit shut down, no hazard.
Test on main board 715G9620								
C805	s-c	19Vdc	5 min	--	--	--	--	Unit shut down, no hazard.
D801	s-c	19Vdc	5 min	--	--	--	--	Unit shut down, no hazard.
Q801 pin G-S	s-c	19Vdc	5 min	--	--	--	--	Unit shut down, no hazard.
Supplementary information:								
1) In fault column, where s-c=short-circuited.								

Annex M	TABLE: Batteries								N/A
The tests of Annex M are applicable only when appropriate battery data is not available									
Is it possible to install the battery in a reverse polarity position?									
	Non-rechargeable batteries			Rechargeable batteries					
	Discharging		Un-intentional charging	Charging		Discharging		Reversed charging	
	Meas. current	Manuf. Specs.		Meas. current	Manuf. Specs.	Meas. current	Manuf. Specs.	Meas. current	Manuf. Specs.
Max. current during normal condition									
Max. current during fault condition									
Test results:									
- Chemical leaks									Verdict

IEC 62368-1			
Clause	Requirement + Test	Result - Remark	Verdict
	- Explosion of the battery		
	- Emission of flame or expulsion of molten metal		
	- Electric strength tests of equipment after completion of tests		
Supplementary information:			

Annex M.4	Table: Additional safeguards for equipment containing secondary lithium batteries				N/A
Battery/Cell No.	Test conditions	Measurements			Observation
		U	I (A)	Temp (C)	
	Normal				
	Abnormal				
	Single fault –SC/OC				
	Normal				
	Abnormal				
	Single fault – SC/OC				
Supplementary information:					
Battery identification	Charging at T _{lowest} (°C)	Observation	Charging at T _{highest} (°C)	Observation	
Supplementary information:					

Annex Q.1	TABLE: Circuits intended for interconnection with building wiring (LPS)				N/A	
Note: Measured UOC (V) with all load circuits disconnected:						
Output Circuit	Components	U _{oc} (V)	I _{sc} (A)		S (VA)	
			Meas.	Limit	Meas.	Limit
Supplementary information:						

T.2, T.3, T.4, T.5	TABLE: Steady force test					N/A
Part/Location	Material	Thickness (mm)	Force (N)	Test Duration (sec)	Observation	
Supplementary information:						

IEC 62368-1					
Clause	Requirement + Test			Result - Remark	Verdict
T.6, T.9	TABLE: Impact tests				N/A
Part/Location	Material	Thickness (mm)	Vertical distance (mm)	Observation	
Supplementary information:					

T.7	TABLE: Drop tests				N/A
Part/Location	Material	Thickness (mm)	Drop Height (mm)	Observation	
Supplementary information:					

T.8	TABLE: Stress relief test					N/A
Part/Location	Material	Thickness (mm)	Oven Temperature (°C)	Duration (h)	Observation	
Supplementary information:						

List of test equipment used:

A completed list of used test equipment shall be provided in the Test Reports when a Manufacturer Testing Laboratory according to TMP/CTF stage 1 or WMT/CTF stage 2 procedure has been used.

Clause	Measurement / testing	Testing / measuring equipment / material used	Range used	Calibration date

Information:

"No listing of test equipment used necessary for chosen test procedure".

IEC62368_1B - ATTACHMENT			
Clause	Requirement + Test	Result - Remark	Verdict

ATTACHMENT TO TEST REPORT																																								
IEC 62368-1																																								
EUROPEAN GROUP DIFFERENCES AND NATIONAL DIFFERENCES																																								
(Audio/video, information and communication technology equipment - Part 1: Safety requirements)																																								
Differences according to: EN 62368-1:2014+A11:2017																																								
Attachment Form No.: EU_GD_IEC62368_1B_II																																								
Attachment Originator: Nemko AS																																								
Master Attachment: Date 2017-09-22																																								
Copyright © 2017 IEC System for Conformity Testing and Certification of Electrical Equipment (IECEE), Geneva, Switzerland. All rights reserved.																																								
	CENELEC COMMON MODIFICATIONS (EN)																																							
	Clauses, subclauses, notes, tables, figures and annexes which are additional to those in IEC 62368-1:2014 are prefixed "Z".			P																																				
CONTENTS	Add the following annexes: Annex ZA (normative) Normative references to international publications with their corresponding European publications Annex ZB (normative) Special national conditions Annex ZC (informative) A-deviations Annex ZD (informative) IEC and CENELEC code designations for flexible cords			P																																				
	Delete all the "country" notes in the reference document (IEC 62368-1:2014) according to the following list:			P																																				
	<table border="1"> <tr> <td>0.2.1</td> <td>Note</td> <td>1</td> <td>Note 3</td> <td>4.1.15</td> <td>Note</td> </tr> <tr> <td>4.7.3</td> <td>Note 1 and 2</td> <td>5.2.2.2</td> <td>Note</td> <td>5.4.2.3.2.2 Table 13</td> <td>Note c</td> </tr> <tr> <td>5.4.2.3.2.4</td> <td>Note 1 and 3</td> <td>5.4.2.5</td> <td>Note 2</td> <td>5.4.5.1</td> <td>Note</td> </tr> <tr> <td>5.5.2.1</td> <td>Note</td> <td>5.5.6</td> <td>Note</td> <td>5.6.4.2.1</td> <td>Note 2 and 3</td> </tr> <tr> <td>5.7.5</td> <td>Note</td> <td>5.7.6.1</td> <td>Note 1 and 2</td> <td>10.2.1 Table 39</td> <td>Note 2, 3 and 4</td> </tr> <tr> <td>10.5.3</td> <td>Note 2</td> <td>10.6.2.1</td> <td>Note 3</td> <td>F.3.3.6</td> <td>Note 3</td> </tr> </table>				0.2.1	Note	1	Note 3	4.1.15	Note	4.7.3	Note 1 and 2	5.2.2.2	Note	5.4.2.3.2.2 Table 13	Note c	5.4.2.3.2.4	Note 1 and 3	5.4.2.5	Note 2	5.4.5.1	Note	5.5.2.1	Note	5.5.6	Note	5.6.4.2.1	Note 2 and 3	5.7.5	Note	5.7.6.1	Note 1 and 2	10.2.1 Table 39	Note 2, 3 and 4	10.5.3	Note 2	10.6.2.1	Note 3	F.3.3.6	Note 3
0.2.1	Note	1	Note 3	4.1.15	Note																																			
4.7.3	Note 1 and 2	5.2.2.2	Note	5.4.2.3.2.2 Table 13	Note c																																			
5.4.2.3.2.4	Note 1 and 3	5.4.2.5	Note 2	5.4.5.1	Note																																			
5.5.2.1	Note	5.5.6	Note	5.6.4.2.1	Note 2 and 3																																			
5.7.5	Note	5.7.6.1	Note 1 and 2	10.2.1 Table 39	Note 2, 3 and 4																																			
10.5.3	Note 2	10.6.2.1	Note 3	F.3.3.6	Note 3																																			
	For special national conditions, see Annex ZB.																																							
1	Add the following note: NOTE Z1 The use of certain substances in electrical and electronic equipment is restricted within the EU: see Directive 2011/65/EU.		Added.	P																																				

IEC62368_1B - ATTACHMENT			
Clause	Requirement + Test	Result - Remark	Verdict
4.Z1	<p>Add the following new subclause after 4.9:</p> <p>To protect against excessive current, short-circuits and earth faults in circuits connected to an a.c. mains, protective devices shall be included either as integral parts of the equipment or as parts of the building installation, subject to the following, a), b) and c):</p> <p>a) except as detailed in b) and c), protective devices necessary to comply with the requirements of B.3.1 and B.4 shall be included as parts of the equipment;</p> <p>b) for components in series with the mains input to the equipment such as the supply cord, appliance coupler, r.f.i. filter and switch, short-circuit and earth fault protection may be provided by protective devices in the building installation;</p> <p>c) it is permitted for pluggable equipment type B or permanently connected equipment, to rely on dedicated overcurrent and short-circuit protection in the building installation, provided that the means of protection, e.g. fuses or circuit breakers, is fully specified in the installation instructions.</p> <p>If reliance is placed on protection in the building installation, the installation instructions shall so state, except that for pluggable equipment type A the building installation shall be regarded as providing protection in accordance with the rating of the wall socket outlet.</p>	Replaced.	N/A
5.4.2.3.2.4	<p>Add the following to the end of this subclause:</p> <p>The requirement for interconnection with external circuit is in addition given in EN 50491-3:2009.</p>	Added.	N/A
10.2.1	<p>Add the following to ^{c)} and ^{d)} in table 39:</p> <p>For additional requirements, see 10.5.1.</p>	No such radiation from the equipment.	N/A

IEC62368_1B - ATTACHMENT			
Clause	Requirement + Test	Result - Remark	Verdict
10.5.1	<p>Add the following after the first paragraph: <i>For RS 1 compliance is checked by measurement under the following conditions:</i></p> <p><i>In addition to the normal operating conditions, all controls adjustable from the outside by hand, by any object such as a tool or a coin, and those internal adjustments or presets which are not locked in a reliable manner, are adjusted so as to give maximum radiation whilst maintaining an intelligible picture for 1 h, at the end of which the measurement is made.</i></p> <p>NOTE Z1 Soldered joints and paint lockings are examples of adequate locking.</p> <p><i>The dose-rate is determined by means of a radiation monitor with an effective area of 10 cm², at any point 10 cm from the outer surface of the apparatus.</i></p> <p><i>Moreover, the measurement shall be made under fault conditions causing an increase of the high-voltage, provided an intelligible picture is maintained for 1 h, at the end of which the measurement is made.</i></p> <p><i>For RS1, the dose-rate shall not exceed 1 μSv/h taking account of the background level.</i></p> <p>NOTE Z2 These values appear in Directive 96/29/Euratom of 13 May 1996.</p>	LED indicator used.	N/A
10.6.1	<p>Add the following paragraph to the end of the subclause: EN 71-1:2011, 4.20 and the related tests methods and measurement distances apply.</p>	No such consideration for the purpose of personal music players.	N/A
10.Z1	<p>Add the following new subclause after 10.6.5. 10.Z1 Non-ionizing radiation from radio frequencies in the range 0 to 300 GHz</p> <p>The amount of non-ionizing radiation is regulated by European Council Recommendation 1999/519/EC of 12 July 1999 on the limitation of exposure of the general public to electromagnetic fields (0 Hz to 300 GHz).</p> <p>For intentional radiators, ICNIRP guidelines should be taken into account for Limiting Exposure to Time-Varying Electric, Magnetic, and Electromagnetic Fields (up to 300 GHz). For hand-held and body-mounted devices, attention is drawn to EN 50360 and EN 50566</p>		N/A
G.7.1	<p>Add the following note: NOTE Z1 The harmonized code designations corresponding to the IEC cord types are given in Annex ZD.</p>		P

IEC62368_1B - ATTACHMENT			
Clause	Requirement + Test	Result - Remark	Verdict
Bibliography	<p>Add the following standards:</p> <p>Add the following notes for the standards indicated:</p> <p>IEC 60130-9 NOTE Harmonized as EN 60130-9. IEC 60269-2 NOTE Harmonized as HD 60269-2. IEC 60309-1 NOTE Harmonized as EN 60309-1. IEC 60364 NOTE some parts harmonized in HD 384/HD 60364 series. IEC 60601-2-4 NOTE Harmonized as EN 60601-2-4. IEC 60664-5 NOTE Harmonized as EN 60664-5. IEC 61032:1997 NOTE Harmonized as EN 61032:1998 (not modified). IEC 61508-1 NOTE Harmonized as EN 61508-1. IEC 61558-2-1 NOTE Harmonized as EN 61558-2-1. IEC 61558-2-4 NOTE Harmonized as EN 61558-2-4. IEC 61558-2-6 NOTE Harmonized as EN 61558-2-6. IEC 61643-1 NOTE Harmonized as EN 61643-1. IEC 61643-21 NOTE Harmonized as EN 61643-21. IEC 61643-311 NOTE Harmonized as EN 61643-311. IEC 61643-321 NOTE Harmonized as EN 61643-321. IEC 61643-331 NOTE Harmonized as EN 61643-331.</p>		P
ZB	ANNEX ZB, SPECIAL NATIONAL CONDITIONS (EN)		
4.1.15	<p>Denmark, Finland, Norway and Sweden</p> <p>To the end of the subclause the following is added:</p> <p>Class I pluggable equipment type A intended for connection to other equipment or a network shall, if safety relies on connection to reliable earthing or if surge suppressors are connected between the network terminals and accessible parts, have a marking stating that the equipment shall be connected to an earthed mains socket-outlet.</p> <p>The marking text in the applicable countries shall be as follows:</p> <p>In Denmark: "Apparatets stikprop skal tilsluttes en stikkontakt med jord som giver forbindelse til stikproppens jord." In Finland: "Laite on liitettävä suojakoskettimilla varustettuun pistorasiaan" In Norway: "Apparatet må tilkoples jordet stikkontakt" In Sweden: "Apparaten skall anslutas till jordat uttag"</p>	The equipment is Class III equipment.	N/A
4.7.3	<p>United Kingdom</p> <p>To the end of the subclause the following is added:</p> <p>The torque test is performed using a socket-outlet complying with BS 1363, and the plug part shall be assessed to the relevant clauses of BS 1363. Also see Annex G.4.2 of this annex</p>	The equipment is not direct plug-in equipment.	N/A

IEC62368_1B - ATTACHMENT			
Clause	Requirement + Test	Result - Remark	Verdict
5.2.2.2	<p>Denmark</p> <p>After the 2nd paragraph add the following: A warning (marking safeguard) for high touch current is required if the touch current exceeds the limits of 3,5 mA a.c. or 10 mA d.c.</p>	No high touch current.	N/A
5.4.11.1 and Annex G	<p>Finland and Sweden</p> <p>To the end of the subclause the following is added: For separation of the telecommunication network from earth the following is applicable: If this insulation is solid, including insulation forming part of a component, it shall at least consist of either</p> <ul style="list-style-type: none"> • two layers of thin sheet material, each of which shall pass the electric strength test below, or • one layer having a distance through insulation of at least 0,4 mm, which shall pass the electric strength test below. <p>If this insulation forms part of a semiconductor component (e.g. an optocoupler), there is no distance through insulation requirement for the insulation consisting of an insulating compound completely filling the casing, so that clearances and creepage distances do not exist, if the component passes the electric strength test in accordance with the compliance clause below and in addition</p> <ul style="list-style-type: none"> • passes the tests and inspection criteria of 5.4.8 with an electric strength test of 1,5 kV multiplied by 1,6 (the electric strength test of 5.4.9 shall be performed using 1,5 kV), and • is subject to routine testing for electric strength during manufacturing, using a test voltage of 1,5kV. <p>It is permitted to bridge this insulation with a capacitor complying with EN 60384-14:2005, subclass Y2.</p> <p>A capacitor classified Y3 according to EN 60384-14:2005, may bridge this insulation under the following conditions:</p> <ul style="list-style-type: none"> • the insulation requirements are satisfied by having a capacitor classified Y3 as defined by EN 60384-14, which in addition to the Y3 testing, is tested with an impulse test of 2,5 kV defined in 5.4.11; • the additional testing shall be performed on all the test specimens as described in EN 60384-14; <p>the impulse test of 2,5 kV is to be performed before the endurance test in EN 60384-14, in the sequence of tests as described in EN 60384-14.</p>	No TNV circuits.	N/A
5.5.2.1	<p>Norway</p> <p>After the 3rd paragraph the following is added: Due to the IT power system used, capacitors are required to be rated for the applicable line-to-line voltage (230 V).</p>	The equipment is Class III equipment.	N/A

IEC62368_1B - ATTACHMENT			
Clause	Requirement + Test	Result - Remark	Verdict
5.5.6	<p>Finland, Norway and Sweden</p> <p>To the end of the subclause the following is added: Resistors used as basic safeguard or bridging basic insulation in class I pluggable equipment type A shall comply with G.10.1 and the test of G.10.2.</p>	No such resistors.	N/A
5.6.1	<p>Denmark</p> <p>Add to the end of the subclause</p> <p>Due to many existing installations where the socket-outlets can be protected with fuses with higher rating than the rating of the socket-outlets the protection for pluggable equipment type A shall be an integral part of the equipment.</p> <p><i>Justification:</i> In Denmark an existing 13 A socket outlet can be protected by a 20 A fuse.</p>	Considered.	N/A
5.6.4.2.1	<p>Ireland and United Kingdom</p> <p>After the indent for pluggable equipment type A, the following is added:</p> <p>– the protective current rating is taken to be 13 A, this being the largest rating of fuse used in the mains plug.</p>	Considered.	N/A
5.6.5.1	<p>To the second paragraph the following is added:</p> <p>The range of conductor sizes of flexible cords to be accepted by terminals for equipment with a rated current over 10 A and up to and including 13 A is: 1,25 mm² to 1,5 mm² in cross-sectional area.</p>	See above.	N/A
5.7.5	<p>Denmark</p> <p>To the end of the subclause the following is added:</p> <p>The installation instruction shall be affixed to the equipment if the protective conductor current exceeds the limits of 3,5 mA a.c. or 10 mA d.c.</p>	No high protective conductor current.	N/A

IEC62368_1B - ATTACHMENT			
Clause	Requirement + Test	Result - Remark	Verdict
5.7.6.1	<p>Norway and Sweden</p> <p>To the end of the subclause the following is added: The screen of the television distribution system is normally not earthed at the entrance of the building and there is normally no equipotential bonding system within the building. Therefore the protective earthing of the building installation needs to be isolated from the screen of a cable distribution system.</p> <p>It is however accepted to provide the insulation external to the equipment by an adapter or an interconnection cable with galvanic isolator, which may be provided by a retailer, for example.</p> <p>The user manual shall then have the following or similar information in Norwegian and Swedish language respectively, depending on in what country the equipment is intended to be used in: “Apparatus connected to the protective earthing of the building installation through the mains connection or through other apparatus with a connection to protective earthing – and to a television distribution system using coaxial cable, may in some circumstances create a fire hazard. Connection to a television distribution system therefore has to be provided through a device providing electrical isolation below a certain frequency range (galvanic isolator, see EN 60728-11)”</p> <p>NOTE In Norway, due to regulation for CATV-installations, and in Sweden, a galvanic isolator shall provide electrical insulation below 5 MHz. The insulation shall withstand a dielectric strength of 1,5 kV r.m.s., 50 Hz or 60 Hz, for 1 min.</p> <p>Translation to Norwegian (the Swedish text will also be accepted in Norway): “Apparater som er koplet til beskyttelsesjord via nettplugg og/eller via annet jordtilkøplet utstyr – og er tilkøplet et koaksialbasert kabel-TV nett, kan forårsake brannfare. For å unngå dette skal det ved tilkøpling av apparater til kabel-TV nett installeres en galvanisk isolator mellom apparatet og kabel-TV nettet.”</p> <p>Translation to Swedish: ”Apparater som är kopplad till skyddsjord via jordat vägguttag och/eller via annan utrustning och samtidigt är kopplad till kabel-TV nät kan i vissa fall medföra risk för brand. För att undvika detta skall vid anslutning av apparaten till kabel-TV nät galvanisk isolator finnas mellan apparaten och kabel-TV nätet.”</p>	Not such system.	N/A

IEC62368_1B - ATTACHMENT			
Clause	Requirement + Test	Result - Remark	Verdict
5.7.6.2	<p>Denmark</p> <p>To the end of the subclause the following is added: The warning (marking safeguard) for high touch current is required if the touch current or the protective current exceed the limits of 3,5 mA .</p>	No external circuits.	N/A
B.3.1 and B.4	<p>Ireland and United Kingdom</p> <p>The following is applicable: To protect against excessive currents and short-circuits in the primary circuit of direct plug-in equipment, tests according to Annexes B.3.1 and B.4 shall be conducted using an external miniature circuit breaker complying with EN 60898-1, Type B, rated 32A. If the equipment does not pass these tests, suitable protective devices shall be included as an integral part of the direct plug-in equipment, until the requirements of Annexes B.3.1 and B.4 are met</p>	The equipment is not direct plug-in equipment.	N/A
G.4.2	<p>Denmark</p> <p>To the end of the subclause the following is added: Supply cords of single phase appliances having a rated current not exceeding 13 A shall be provided with a plug according to DS 60884-2-D1:2011. CLASS I EQUIPMENT provided with socket-outlets with earth contacts or which are intended to be used in locations where protection against indirect contact is required according to the wiring rules shall be provided with a plug in accordance with standard sheet DK 2-1a or DK 2-5a. If a single-phase equipment having a RATED CURRENT exceeding 13 A or if a poly-phase equipment is provided with a supply cord with a plug, this plug shall be in accordance with the standard sheets DK 6-1a in DS 60884-2-D1 or EN 60309-2. Mains socket outlets intended for providing power to Class II apparatus with a rated current of 2,5 A shall be in accordance DS 60884-2-D1:2011 standard sheet DKA 1-4a. Other current rating socket outlets shall be in compliance with Standard Sheet DKA 1-3a or DKA 1-1c. Mains socket-outlets with earth shall be in compliance with DS 60884-2-D1:2011 Standard Sheet DK 1-3a, DK 1-1c, DK1-1d, DK 1-5a or DK 1-7a <i>Justification:</i> Heavy Current Regulations, Section 6c</p>		N/A

IEC62368_1B - ATTACHMENT			
Clause	Requirement + Test	Result - Remark	Verdict
G.4.2	<p>United Kingdom</p> <p>To the end of the subclause the following is added: The plug part of direct plug-in equipment shall be assessed to BS 1363: Part 1, 12.1, 12.2, 12.3, 12.9, 12.11, 12.12, 12.13, 12.16, and 12.17, except that the test of 12.17 is performed at not less than 125 °C. Where the metal earth pin is replaced by an Insulated Shutter Opening Device (ISOD), the requirements of clauses 22.2 and 23 also apply.</p>	The equipment is not direct plug-in equipment.	N/A
G.7.1	<p>United Kingdom</p> <p>To the first paragraph the following is added: Equipment which is fitted with a flexible cable or cord and is designed to be connected to a mains socket conforming to BS 1363 by means of that flexible cable or cord shall be fitted with a 'standard plug' in accordance with the Plugs and Sockets etc (Safety) Regulations 1994, Statutory Instrument 1994 No. 1768, unless exempted by those regulations.</p> <p>NOTE "Standard plug" is defined in SI 1768:1994 and essentially means an approved plug conforming to BS 1363 or an approved conversion plug.</p>		N/A
G.7.1	<p>Ireland</p> <p>To the first paragraph the following is added: Apparatus which is fitted with a flexible cable or cord shall be provided with a plug in accordance with Statutory Instrument 525: 1997, "13 A Plugs and Conversion Adapters for Domestic Use Regulations: 1997. S.I. 525 provides for the recognition of a standard of another Member State which is equivalent to the relevant Irish Standard</p>	The power supply cord has not been checked, see GENERAL PRODUCT INFORMATION.	N/A
G.7.2	<p>Ireland and United Kingdom</p> <p>To the first paragraph the following is added: A power supply cord with a conductor of 1,25 mm² is allowed for equipment which is rated over 10 A and up to and including 13 A.</p>	The power supply cord has not been checked, see GENERAL PRODUCT INFORMATION.	N/A

IEC62368_1B - ATTACHMENT			
Clause	Requirement + Test	Result - Remark	Verdict
ZC	ANNEX ZC, NATIONAL DEVIATIONS (EN)		P
10.5.2	<p>Germany</p> <p>The following requirement applies: For the operation of any cathode ray tube intended for the display of visual images operating at an acceleration voltage exceeding 40 kV, authorization is required, or application of type approval (Bauartzulassung) and marking.</p> <p><i>Justification:</i> German ministerial decree against ionizing radiation (Röntgenverordnung), in force since 2002-07-01, implementing the European Directive 96/29/EURATOM.</p> <p>NOTE Contact address: Physikalisch-Technische Bundesanstalt, Bundesallee 100, D-38116 Braunschweig, Tel.: Int +49-531-592-6320, Internet: http://www.ptb.de</p>	No CRT within the equipment.	N/A

IEC62368_1B - ATTACHMENT			
Clause	Requirement + Test	Result - Remark	Verdict

ATTACHMENT TO TEST REPORT IEC 62368-1 DENMARK NATIONAL DIFFERENCES Audio/video, information and communication technology equipment – Part 1: Safety requirements			
Differences according to: DS/EN 62368-1:2014			
Attachment Form No.: DK_ND_IEC62368_1B			
Attachment Originator: UL (Demko)			
Master Attachment: 2014-10			
Copyright © 2014 IEC System for Conformity Testing and Certification of Electrical Equipment (IECEE), Geneva, Switzerland. All rights reserved.			

	National Differences		P
4.1.15	<p>To the end of the subclause the following is added:</p> <p>Class I pluggable equipment type A intended for connection to other equipment or a network shall, if safety relies on connection to reliable earthing or if surge suppressors are connected between the network terminals and accessible parts, have a marking stating that the equipment shall be connected to an earthed mains socket-outlet.</p> <p>The marking text in the applicable countries shall be as follows:</p> <p>“Apparatets stikprop skal tilsluttes en stikkontakt med jord som giver forbindelse til stikproppens jord.”</p>	The equipment is Class III equipment.	N/A
5.2.2.2	<p>After the 2nd paragraph add the following:</p> <p>A warning (marking safeguard) for high touch current is required if the touch current exceeds the limits of 3,5 mA a.c. or 10 mA d.c.</p>	Added.	N/A
5.6.1	<p>Add to the end of the subclause:</p> <p>Due to many existing installations where the socket-outlets can be protected with fuses with higher rating than the rating of the socket-outlets the protection for pluggable equipment type A shall be an integral part of the equipment.</p> <p>Justification:</p> <p>In Denmark an existing 13 A socket outlet can be protected by a 20 A fuse.</p>	Added. No socket outlet is provided.	N/A
5.7.5	<p>To the end of the subclause the following is added:</p> <p>The installation instruction shall be affixed to the equipment if the protective conductor current exceeds the limits of 3,5 mA a.c. or 10 mA d.c.</p>	Added.	N/A

IEC62368_1B - ATTACHMENT			
Clause	Requirement + Test	Result - Remark	Verdict
5.7.6.2	<p>To the end of the subclause the following is added:</p> <p>The warning (marking safeguard) for high touch current is required if the touch current or the protective current exceed the limits of 3,5 mA.</p>	Added.	N/A
G.4.2	<p>To the end of the subclause the following is added:</p> <p>Supply cords of single phase appliances having a rated current not exceeding 13 A shall be provided with a plug according to DS 60884-2-D1:2011.</p> <p>CLASS I EQUIPMENT provided with socket-outlets with earth contacts or which are intended to be used in locations where protection against indirect contact is required according to the wiring rules shall be provided with a plug in accordance with standard sheet DK 2-1a or DK 2-5a.</p> <p>If a single-phase equipment having a RATED CURRENT exceeding 13 A or if a poly-phase equipment is provided with a supply cord with a plug, this plug shall be in accordance with the standard sheets DK 6-1a in DS 60884-2-D1 or EN 60309-2.</p> <p>Mains socket outlets intended for providing power to Class II apparatus with a rated current of 2,5 A shall be in accordance DS 60884-2-D1:2011 standard sheet DKA 1-4a.</p> <p>Other current rating socket outlets shall be in compliance with Standard Sheet DKA 1-3a or DKA 1-1c.</p> <p>Mains socket-outlets with earth shall be in compliance with DS 60884-2-D1:2011 Standard Sheet DK 1-3a, DK 1-1c, DK1-1d, DK 1-5a or DK 1-7a</p> <p>Justification: Heavy Current Regulations, Section 6c</p>	Added.	N/A

IEC62368_1B - ATTACHMENT			
Clause	Requirement + Test	Result - Remark	Verdict

ATTACHMENT TO TEST REPORT IEC 62368-1 2th Ed. U.S.A. NATIONAL DIFFERENCES Audio/video, information and communication technology equipment – Part 1: Safety requirements			
Differences according to	CSA/UL 62368-1:2014		
Attachment Form No.	US&CA_ND_IEC623681B		
Attachment Originator	UL(US)		
Master Attachment	Date 2015-06		
Copyright © 2015 IEC System for Conformity Testing and Certification of Electrical Equipment (IECEE), Geneva, Switzerland. All rights reserved.			

IEC 62368-1 - US and Canadian National Differences Special National Conditions based on Regulations and Other National Differences			
1.1	All equipment is to be designed to allow installation according to the National Electrical Code (NEC), ANSI/NFPA 70, the Canadian Electrical Code (CEC), Part I, CAN/CSA C22.1, and when applicable, the National Electrical Safety Code, IEEE C2. Also, for such equipment marked or otherwise identified, installation is allowed per the Standard for the Protection of Information Technology Equipment, ANSI/NFPA 75.	In accordance with the National Electrical Code (NEC) and the Canadian Electrical Code (CEC) part 1 CAN/CSA C22.1, ANSI/NFPA 70, and unless marked or otherwise identified, the Standard for Electronic Computer/Data-Processing Equipment, ANSI/NFPA 75.	P
1.4	Additional requirements apply to some forms of power distribution equipment, including sub-assemblies.	Considered.	P
4.1.17	For lengths exceeding 3.05 m, external interconnecting flexible cord and cable assemblies are required to be a suitable cable type (e.g., DP, CL2) specified in the NEC.		N/A
	For lengths 3.05 m or less, external interconnecting flexible cord and cable assemblies that are not types specified in the NEC generally are required to have special construction features and identification markings.	See above.	N/A
4.8	Lithium coin / button cell batteries have modified special construction and performance requirements.	No such parts.	N/A
5.6.3	Protective earthing conductors comply with the minimum conductor sizes in Table G.5, except as required by Table G.7ADV.1 for cord connected equipment, or Annex DVH for permanently connected equipment		N/A
5.7.7	Equipment intended to receive telecommunication ringing signals complies with a special touch current measurement tests.	No TNV circuits within the equipment.	N/A

IEC62368_1B - ATTACHMENT			
Clause	Requirement + Test	Result - Remark	Verdict
6.5.1	PS3 wiring outside a fire enclosure complies with single fault testing in B.4, or be current limited per one of the permitted methods.	No such parts.	N/A
Annex F (F.3.3.8)	Output terminals provided for supply of other equipment, except mains, supply are marked with a maximum rating or references to which equipment it is permitted to be connected.	No DC output connector is provided.	N/A
Annex G (G.7.1)	Permanent connection of equipment to the mains supply by a power supply cord is not permitted, except for certain equipment, such as ATMs.	The equipment is not permanent connection equipment.	N/A
Annex G (G.7.3)	Power supply cords are required to have attachment plugs rated not less than 125 percent of the rated current of the equipment.		N/A
	Flexible power supply cords are required to be compatible with Article 400 of the NEC, and Tables 11 and 12 of the CEC.	See above.	N/A
Annex G (G.7.5)	Minimum cord length is required to be 1.5 m, with certain constructions such as external power supplies allowed to consider both input and output cord lengths into the requirement. Power supply cords are required to be no longer than 4.5 m in length if used in ITE Rooms.	See above.	N/A
Annex H.2	Continuous ringing signals under normal operating conditions up to 16 mA only are permitted if the equipment is subjected to special installation and performance restrictions.	No TNV circuits within the equipment.	N/A
Annex H.4	For circuits with other than ringing signals and with voltages exceeding 42.4 V _{peak} or 60 V d.c., the maximum acceptable current through a 2000 ohm resistor (or greater) connected across the voltage source with other loads disconnected is 7.1 mA peak or 30 mA d.c. under normal operating conditions.	No TNV circuits within the equipment.	N/A
Annex M	Battery packs for stationary applications comply with special component requirements.	No such parts.	N/A
Annex DVA (1)	Equipment intended for use in spaces used for environmental air are subjected to special flammability requirements for heat and visible smoke release.	The equipment not intended to be used within such environments.	N/A
	For ITE room applications, automated information storage systems with combustible media greater than 0.76 m ³ (27 cu ft) have a provision for connection of either automatic sprinklers or a gaseous agent extinguishing system with an extended discharge.	Not such equipment.	N/A
	Consumer products designed or intended primarily for children 12 years of age or younger are subject to additional requirements in accordance with U.S. & Canadian Regulations.	The equipment is not for children used.	N/A

IEC62368_1B - ATTACHMENT			
Clause	Requirement + Test	Result - Remark	Verdict
	Baby monitors additionally comply with ASTM F2951, Consumer Safety Specification for Baby Monitors.	Not a baby monitors.	N/A
Annex DVA (5.6.3)	For Pluggable Equipment Type A, the protection in the installation is assumed to be 20A.	Considered.	P
Annex DVA (6.3)	The maximum quantity of flammable liquid stored in equipment complies with NFPA 30.	No flammable liquids within the equipment.	N/A
Annex DVA (6.4.8)	For ITE room applications, enclosures with combustible material measuring greater than 0.9 m ² (10 sq ft) or a single dimension greater than 1.8 m (6 ft) have a flame spread rating of 50 or less. For equipment with the same dimensions for other applications, an external surface that is not a fire enclosure requires a min. flammability classification of V-1.	No such application.	N/A
Annex DVA (10.3.1)	Equipment with lasers meets the U.S. Code of Federal Regulations 21 CFR 1040 (and the Canadian Radiation Emitting Devices Act, REDR C1370).	No such parts.	N/A
Annex DVA (10.5.1)	Equipment that produces ionizing radiation complies with the U.S. Code of Federal Regulations, 21 CFR 1020 (and the Canadian Radiation Emitting Devices Act, REDR C1370).	No such parts.	N/A
Annex DVA (F.3.3.3)	Equipment for use on a.c. mains supply systems with a neutral and more than one phase conductor (e.g. 120/240 V, 3-wire) require a special marking format for electrical ratings. Additional considerations apply for voltage ratings that exceed the attachment cap rating or are lower than the "Normal Operating Condition" in Table 2 of CAN/CSA C22.2 No. 235."	Single phase only.	N/A
Annex DVA (F.3.3.5)	Equipment identified for ITE (computer) room installation is marked with the rated current	Not such application.	N/A
Annex DVA (G.1)	Vertically-mounted disconnect switches and circuit breakers have the "on" position indicated by the handle in the up position	No such parts.	N/A
Annex DVA (G.3.4)	Suitable NEC/CEC branch circuit protection rated at the maximum circuit rating is required for all standard supply outlets and receptacles (such as supplied in power distribution units) if the supply branch circuit protection is not suitable.	No standard supply outlets, receptacles, medium-base or smaller lampholders are provided.	N/A
Annex DVA (G.4.2)	Equipment with isolated ground (earthing) receptacles complies with NEC 250.146(D) and CEC 10-112 and 10-906(8).	No such parts.	N/A
Annex DVA (G.4.3)	Where a fuse is used to provide Class 2 or Class 3 current limiting, it is not operator-accessible unless it is non- interchangeable.	No such parts.	N/A

IEC62368_1B - ATTACHMENT			
Clause	Requirement + Test	Result - Remark	Verdict
Annex DVA (G.5.3)	Power distribution transformers distributing power at 100 volts or more, and rated 10 kVA or more, require special transformer overcurrent protection.	No such parts.	N/A
Annex DVA (G.5.4)	Motor control devices are required for cord-connected equipment with a mains-connected motor if the equipment is rated more than 12 A, or if the equipment has a nominal voltage rating greater than 120 V, or if the motor is rated more than 1/3 hp (locked rotor current over 43 A).	No such parts.	N/A
Annex DVA (Annex M)	For ITE room applications, equipment with battery systems capable of supplying 750 VA for five minutes have a battery disconnect means that may be connected to the ITE room remote power-off circuit.	Not such application.	N/A
Annex DVA (Q)	Wiring terminals intended to supply Class 2 outputs according to the NEC or CEC Part 1 are marked with the voltage rating and "Class 2" or equivalent; marking is located adjacent to the terminals and visible during wiring.	Not applicable for the equipment.	N/A
Annex DVB (1)	Additional requirements apply for equipment used for entertainment purposes intended for installation in general patient care areas of health care facilities.	Not such application.	N/A
Annex DVC (1)	Additional requirements apply for equipment intended for mounting under kitchen cabinets.	Not such application.	N/A
Annex DVE (4.1.1)	Some equipment, components, sub-assemblies and materials associated with the risk of fire, electric shock, or personal injury have component or material ratings in accordance with the applicable national (U.S. and Canadian) component or material requirements. Components required to comply include: appliance couplers, attachment plugs, battery back-up systems, battery packs, circuit breakers, communication circuit accessories, connectors (used for current interruption of non-LPS circuits), power supply cords, direct plug-in equipment, electrochemical capacitor modules (energy storage modules with ultra-capacitors), enclosures (outdoor), flexible cords and cables, fuses (branch circuit), ground-fault current interrupters, interconnecting cables, data storage equipment, printed wiring, protectors for communications circuits, receptacles, surge protective devices, vehicle battery adapters, wire connectors, and wire and cables.	UL approved components are used. Refer to table 4.1.2 of IEC 62368-1 test report for details.	P
Annex DVH	Equipment for permanent connection to the mains supply is subjected to additional requirements.	The equipment is not permanently connected equipment.	N/A

IEC62368_1B - ATTACHMENT			
Clause	Requirement + Test	Result - Remark	Verdict
Annex DVH (DVH.1)	Wiring methods (terminals, leads, etc.) used for the connection of the equipment to the mains are in accordance with the NEC/CEC.	The equipment is pluggable equipment type A.	N/A
Annex DVH (DVH.3.2)	Terminals for permanent wiring, including protective earthing terminals, are suitable for U.S./Canadian wire gauge sizes, rated 125 percent of the equipment rating, and are specially marked when specified.	No terminals for permanent wiring.	N/A
Annex DVH (DVH.3.2)	Wire binding screws are not permitted to attach conductors larger than 10 AWG (5.3 mm ²).	No wire binding screws.	N/A
Annex DVH (DVH.4)	Permanently connected equipment is required to have a suitable wiring compartment and wire bending space.	The equipment is not permanently connected equipment.	N/A
Annex DVH (DVH 5.5)	Equipment connected to a centralized d.c. power system, and having one pole of the DC mains input terminal connected to the main protective earthing terminal in the equipment, complies with special earthing, wiring, marking and installation instruction requirements.	The equipment not connected to a centralized d.c. power system.	N/A
Annex DVI (6.7)	Equipment intended for connection to telecommunication network outside plant cable is required to be protected against overvoltage from power line crosses.	No TNV circuits within the equipment.	N/A
Annex DVJ (10.6.1)	Equipment connected to a telecommunication and cable distribution networks and supplied with an earphone intended to be held against, or in the ear is required to comply with special acoustic pressure requirements.	No TNV circuits within the equipment.	N/A

IEC62368_1B - ATTACHMENT			
Clause	Requirement + Test	Result - Remark	Verdict

ATTACHMENT TO TEST REPORT IEC 62368-1 (AUSTRALIA / NEW ZEALAND) NATIONAL DIFFERENCES (Audio/video, information and communication technology equipment)			
Differences according to: AS/NZS 62368.1:2018			
Attachment Form No.: AU_NZ_ND_IEC62368_1B			
Attachment Originator: JAS-ANZ			
Master Attachment: 2018-02			
Copyright © 2017 IEC System for Conformity Testing and Certification of Electrical Equipment (IECEE), Geneva, Switzerland. All rights reserved.			
	National Differences		
Appendix ZZ	Variations to IEC 62368-1:2014 (ED. 2.0) for Australia and New Zealand		P
ZZ1 Scope	This Appendix lists the normative variations to IEC 62368-1:2014 (ED. 2.0)		P
ZZ2 Variations	The following modifications are required for Australian/New Zealand conditions:		P
2	<p>Add the following to the list of normative references:</p> <p>The following normative documents are referenced in Appendix ZZ:</p> <ul style="list-style-type: none"> -AS/NZS 3112, <i>Approval and test specification—Plugs and socket-outlets</i> -AS/NZS 3123, <i>Approval and test specification—Plugs, socket-outlets and couplers for general industrial application</i> -AS/NZS 3191, <i>Electric flexible cords</i> -AS/NZS 60065, <i>Audio, video and similar electronic apparatus—Safety requirements (IEC 60065:2015 (ED.8.0) MOD)</i> -AS/NZS 60320.1, <i>Appliance couplers for household and similar general purposes, Part 1: General requirements (IEC 60320-1, Ed.2.1 (2007) MOD)</i> -AS/NZS 60320.2.2, <i>Appliance couplers for household and similar general purposes Part 2.2: Interconnection couplers for household and similar equipment (IEC 60320-2-2, Ed.2.0 (1998) MOD)</i> -AS/NZS 60695.2.11, <i>Fire hazard testing, Part 2.11: Glowing/hot wire based test methods—Glow-wire flammability test method for end-products</i> -AS/NZS 60695.11.5, <i>Fire hazard testing, Part 11.5: Test flames—Needle-flame test method—</i> 	Added.	P

IEC62368_1B - ATTACHMENT			
Clause	Requirement + Test	Result - Remark	Verdict
	<p><i>Apparatus, confirmatory test arrangement and guidance</i></p> <p>-AS/NZS 60695.11.10, <i>Fire hazard testing, Part 11.10: Test flames—50 W horizontal and vertical flame test methods</i></p> <p>-AS/NZS 60884.1, <i>Plugs and socket-outlets for household and similar purposes, Part 1: General requirements</i></p> <p>-AS/NZS 60950.1:2015, <i>Information technology equipment—Safety, Part 1: General requirements (IEC 60950-1, Ed.2.2 (2013), MOD)</i></p> <p>IEC 61032:1997, <i>Protection of persons and equipment by enclosures—Probes for verification</i></p> <p>-AS/NZS 61558.1:2008 (including Amendment 2:2015), <i>Safety of Power Transformers, Power Supplies, Reactors and Similar Products, Part 1: General requirements and tests (IEC 61558-1 Ed 2.1, MOD)</i></p> <p>-AS/NZS 61558.2.16, <i>Safety of transformers, reactors, power supply units and similar products for voltages up to 1 100 V, Part 2.16: Particular requirements and tests for switch mode power supply units and transformers for switch mode power supply units.</i></p>		
4.1.1	<p>Application of requirements and acceptance of materials, components and subassemblies</p> <p>1 <i>Replace</i> the text 'IEC 60950-1' with 'AS/NZS 60950.1:2015'.</p> <p>2 <i>Replace</i> the text 'IEC 60065' with 'AS/NZS 60065'.</p>	Replaced.	N/A
4.7	Equipment for direct insertion into mains socket-outlets		
4.7.2	<p>Requirements</p> <p><i>Delete</i> the text of the second paragraph and <i>replace</i> with the following:</p> <p>Equipment with a plug portion, suitable for insertion into a 10 A 3-pin flat-pin socket-outlet complying with AS/NZS 3112 shall comply with the requirements in AS/NZS 3112 for equipment with integral pins for insertion into socket-outlets.</p>	Deleted.	N/A
4.7.3	<p>Compliance Criteria</p> <p><i>Delete</i> the first paragraph and Note 1 and Note 2 and <i>replace</i> with the following:</p> <p><i>Compliance is checked by inspection and, if necessary, by the tests in AS/NZS 3112.</i></p>	Deleted.	N/A
4.8	<p><i>Delete</i> existing clause title and <i>replace</i> with the following:</p> <p>4.8 Products containing coin/button cell batteries</p>		

IEC62368_1B - ATTACHMENT			
Clause	Requirement + Test	Result - Remark	Verdict
4.8.1	<p>General</p> <p>1 Second dashed point, <i>delete</i> the text and <i>replace</i> with the following: – include coin/button cell batteries with a diameter of 32 mm or less.</p> <p>2 After the second dashed point, <i>insert</i> the following Note: NOTE 1: Batteries are specified in IEC 60086-2.</p> <p>3 After the third dashed point, <i>renumber</i> the existing Note as 'NOTE 2'.</p> <p>4 Fifth dashed point, <i>delete</i> the word 'lithium'.</p>		N/A
4.8.2	<p>Instructional Safeguard</p> <p>First line, <i>delete</i> the word 'lithium'.</p>		N/A
4.8.3	<p>Construction</p> <p>First line, after the word 'Equipment' <i>insert</i> the words 'containing one or more coin/button batteries and'</p>		N/A
4.8.5	<p>Compliance criteria</p> <p><i>Delete</i> the first paragraph and <i>replace</i> with the following: <i>Compliance is checked by applying a force of 30 N +/-1 N for 10 s to the battery compartment door/cover by a rigid test finger according to test probe 11 of IEC 61032:1997 at the most unfavourable place and in the most unfavourable direction. The force shall be applied in one direction at a time.</i></p>	Deleted.	N/A
5.4.10.2	<p>Test methods</p>		N/A
5.4.10.2.1	<p>General</p> <p><i>Delete</i> the first paragraph and <i>replace</i> with the following: In Australia only, the separation is checked by the test of both Clause 5.4.10.2.2 and Clause 5.4.10.2.3. In New Zealand, the separation is checked by the test of either Clause 5.4.10.2.2 or Clause 5.4.10.2.3.</p>	Deleted.	N/A
Table 29	<p><i>Replace</i> the table with the following:</p>		

IEC62368_1B - ATTACHMENT				
Clause	Requirement + Test		Result - Remark	Verdict
Parts	Impulse test		Steady state test	
	New Zealand	Australia	New Zealand	Australia
Parts indicated in Clause 5.4.10.1 a) ^a	2.5 kV 10/700 μ s	7.0 kV for hand-held telephones and headsets, 2.5 kV for other equipment. 10/700 μ s	1.5 kV	3 kV
Parts indicated in Clause 5.4.10.1 b) and c) ^b	1.5 kV 10/700 μ s ^c		1.0 kV	1.5 kV
^a Surge suppressors shall not be removed. ^b Surge suppressors may be removed, provided that such devices pass the impulse test of Clause 5.4.10.2.2 when tested as components outside the equipment. ^c During this test, it is allowed for a surge suppressor to operate and for a sparkover to occur in a GDT.				
5.4.10.2.2	After the first paragraph, <i>insert</i> new Notes 201 and 202 as follows: NOTE 201 For Australia, the 7 kV impulse simulates lightning surges on typical rural and semi-rural network lines. NOTE 202 For Australia, the value of 2.5 kV for Clause 5.4.10.1 a) was chosen to ensure the adequacy of the insulation concerned and does not necessarily simulate likely overvoltages.			N/A
5.4.10.2.3	After the first paragraph, <i>insert</i> new Notes 201 and 202 as follows: NOTE 201 For Australia, where there are capacitors across the insulation under test, it is recommended that d.c. test voltages are used. NOTE 202 The 3 kV and 1.5 kV values for Australia have been determined considering the low frequency induced voltages from the power supply distribution system.			N/A
6	Electrically-caused fire			P
6.1	General After the first paragraph, <i>insert</i> the following new paragraph: Alternatively, the requirements of Clauses 6.2 to 6.5.2 are considered to be fulfilled if the equipment complies with the requirements of Clause 6.202		Added	N/A
6.6	After Clause 6.6, <i>add</i> the new Clauses 6.201 and 6.202 as follows: 6.201 External power supplies, docking stations and other similar devices and 6.202 Resistance to fire—Alternative tests (see special national conditions)			N/A
8.5.4	Special categories of equipment comprising moving parts			N/A

IEC62368_1B - ATTACHMENT			
Clause	Requirement + Test	Result - Remark	Verdict
8.5.4.1	Large data storage equipment In the first dashed row and the second dashed rows <i>replace</i> 'IEC 60950-1:2005' with 'AS/NZS 60950.1:2015'.		N/A
8.6	Stability of equipment		P
8.6.1 and Table 36	Requirements 1. Table 36, <i>insert</i> Footnote c at the end of the 'Glass slide' heading, and <i>add</i> a new Footnote c after the text of Footnote b in the last row of Table 36 as follows: c The glass slide test is not applicable to floor standing equipment, even though the equipment may have controls or a display. 2. Table 36, fifth row, <i>insert</i> '201' at the end of 'No stability requirements' 3. Table 36, ninth row, <i>insert</i> '201' at the end of 'No stability requirements' 4. Table 36, <i>add</i> the following new footnote: 201 MS2 and MS3 television sets and display devices, designed only for fixing to a wall, ceiling or equipment rack, are not subjected to stability requirements only if the instructional safeguard of Clause 8.6.1.201 is provided. Otherwise, the glass slide requirements of Clause 8.6.4 and horizontal force requirements of Clause 8.6.5 apply. 5. Second paragraph beneath Table 36, <i>delete</i> the words 'MS2 and MS3 television sets' and <i>replace</i> with 'MS2 and MS3 television sets and display devices'	Considered.	P
8.6.1	After Clause 8.6.1 <i>add</i> the following new clauses: 8.6.1.201 Instructional safeguard for fixed-mount television sets (see special national conditions)	Added. No such equipment.	N/A
Annex F Paragraph F.3.5.1	Mains appliance outlet and socket-outlet markings <i>Replace</i> 'IEC 60320-2-2' with 'AS/NZS 60320.2.2'.	Replaced.	N/A
Annex G Paragraph G.4.2	Mains connectors 1 In the second line <i>insert</i> 'or AS/NZS 3123' after 'IEC 60906-1'. 2 In the second line <i>insert</i> 'or AS/NZS 60320 series' after 'IEC 60320 series' 3 <i>Add</i> the following new paragraph: 10 A or 15 A 250 V flat pin plugs for the connection of equipment to mains-powered socket-outlets for household or similar general use shall comply with AS/NZS 3112 or AS/NZS 60884.1.		N/A

IEC62368_1B - ATTACHMENT			
Clause	Requirement + Test	Result - Remark	Verdict
Paragraph G.5.3.1	<p>Transformers, General</p> <p>1 In the third dashed point <i>replace</i> 'IEC 61558-1 and the relevant parts of IEC 61558-2' with 'AS/NZS 61558-1 and the relevant parts of AS/NZS 61558.2'</p> <p>2 In the fourth dashed point <i>replace</i> 'IEC 61558-2-16' with 'AS/NZS 61558.2.16'.</p>		N/A
Paragraph G.7.1	<p>Mains supply cords, General</p> <p>In the fourth dashed paragraph, <i>replace</i> 'IEC 60320-1' with 'AS/NZS 60320.1'</p>		N/A
Table G.5	<p>Sizes of conductors</p> <p>1 In the second row, first column, <i>delete</i> '6' and <i>replace</i> with '7.5'</p> <p>2 In the second row, second column, <i>delete</i> '0,75' and <i>replace</i> with '0.75^b'</p> <p>3 <i>Delete</i> Note 1.</p> <p>4 <i>Replace</i> 'NOTE 2' with 'NOTE:'.</p> <p>5 <i>Delete</i> the text of 'Footnote b' and <i>replace</i> with the following:</p> <p>^b This nominal cross-sectional area is only allowed for Class II appliances if the length of the power supply cord, measured between the point where the cord, or cord guard, enters the appliance, and the entry to the plug does not exceed 2 m (0.5 mm² three-core supply flexible cords are not permitted; see AS/NZS 3191).</p> <p>6 In Footnote c <i>replace</i> 'IEC 60320-1' with 'AS/NZS 60320.1'</p> <p>7 In Footnote d <i>replace</i> 'IEC 60320-1' with 'AS/NZS 60320.1'</p>		
Annex M Paragraph M.3.2	<p>Protection circuits for batteries provided within the equipment, Test method</p> <p>After the first dashed point <i>add</i> the following Note:</p> <p>NOTE 201: In cases where the voltage source is provided by power from an unassociated power source, consideration should be given to the effects of possible single fault conditions in the unassociated equipment. If the power source is unknown then it should be assumed that the maximum limit of SELV may be applied to the source input under assumed single fault conditions in the source when assessing the charging circuit in the equipment under test.</p>	No such construction.	N/A
	Special national conditions (if any)		N/A

IEC62368_1B - ATTACHMENT			
Clause	Requirement + Test	Result - Remark	Verdict
6.201	<p>External power supplies, docking stations and other similar devices</p> <p>For external power supplies, docking stations and other similar devices, during and after abnormal operating conditions and during single fault conditions the output voltage—</p> <ul style="list-style-type: none"> – at all ES1 outlets or connectors shall not increase by more than 10% of its rated output voltage under normal operating condition; and – of a USB outlet or connector shall not increase by more than 3 V or 10% of its rated output voltage under normal operating conditions, whichever is higher. <p>For equipment with multiple rated output voltages, the requirements apply with the equipment configured for each rated output voltage in turn.</p> <p>NOTE: This is intended to reduce the possibility of battery fire or explosion in attached equipment or accessories when charging secondary lithium batteries.</p> <p><i>Compliance shall be checked by measurement, taking into account the abnormal operating conditions of Annex B.3 and the simulated single-fault conditions of Annex B.4</i></p>	Replaced.	N/A
6.202	Resistance to fire—Alternative tests		N/A
6.202.1	<p>General</p> <p>Parts of non-metallic material shall be resistant to ignition and spread of fire.</p> <p>This requirement does not apply to decorative trims, knobs and other parts unlikely to be ignited or to propagate flames from inside the equipment, or the following:</p> <ol style="list-style-type: none"> a) Components that are contained in an enclosure having a flammability category of V-0 according to AS/NZS 60695.11.10 and having openings only for the connecting wires filling the openings completely, and for ventilation not exceeding 1 mm in width regardless of length. b) The following parts which would contribute negligible fuel to a fire: <ul style="list-style-type: none"> – small mechanical parts, the mass of which does not exceed 4 g, such as mounting parts, gears, cams, belts and bearings; – small electrical components, such as capacitors with a volume not exceeding 1 750 mm³, integrated circuits, transistors and optocoupler packages, if these components are mounted on material of flammability category V-1, or better, 		N/A

IEC62368_1B - ATTACHMENT			
Clause	Requirement + Test	Result - Remark	Verdict
	<p>according to AS/NZS 60695.11.10.</p> <p>NOTE: In considering how to minimize propagation of fire and what 'small parts' are, account should be taken of the cumulative effect of small parts adjacent to each other for the possible effect of propagating the fire from one part to another.</p>		
	<p><i>Compliance shall be checked by the tests of Clauses 6.202.2, 6.202.3 and 6.202.4.</i></p> <p>For the base material of printed boards, compliance shall be checked by the test of Clause 6.202.5.</p> <p>The tests shall be carried out on parts of non-metallic material which have been removed from the equipment. When the glow-wire test is carried out, the parts shall be placed in the same orientation as they would be in normal use.</p> <p>These tests are not carried out on internal wiring.</p>		N/A
6.202.2	<p>Testing of non-metallic materials</p> <p>Parts of non-metallic material shall be subject to the glow-wire test of AS/NZS 60695.2.11 which shall be carried out at 550°C.</p> <p>Parts for which the glow-wire test cannot be carried out, such as those made of soft or foamy material, shall meet the requirements specified in ISO 9772 for category FH-3 material. The glow-wire test shall be not carried out on parts of material classified at least FH-3 according to ISO 9772 provided that the relevant part is not thinner than the sample tested.</p>		N/A
6.202.3	<p>Testing of insulating materials</p> <p>Parts of insulating material supporting Potential Ignition Sources shall be subject to the glow-wire test of AS/NZS 60695.2.11 which shall be carried out at 750°C.</p> <p>The test shall be also carried out on other parts of insulating material which are within a distance of 3 mm of the connection.</p> <p>NOTE: Contacts in components such as switch contacts are considered to be connections</p>		N/A
	<p>For parts which withstand the glow-wire test but produce a flame, other parts above the connection within the envelope of a vertical cylinder having a diameter of 20 mm and a height of 50 mm shall be subjected to the needle-flame test.</p> <p>However, parts shielded by a barrier which meets the needle-flame test need not be tested</p>		N/A
	<p>The needle-flame test shall be made in accordance with AS/NZS 60695.11.5 with the following modifications:</p>		N/A

IEC62368_1B - ATTACHMENT			
Clause	Requirement + Test	Result - Remark	Verdict
	<p>Clause of AS/NZS 60695.11.5</p> <p>9 Test procedure</p> <p>9.2 Application of needle-flame</p> <p>9.3 Number of test specimens</p> <p>11 Evaluation of test results</p> <p>The needle-flame test shall not be carried out on parts of material classified as V-0 or V-1 according to AS/NZS 60695.11.10, provided that the relevant part is not thinner than the sample tested.</p>	<p>Change</p> <p><i>Delete</i> the first and second paragraphs and <i>replace</i> with the following: The specimen shall be arranged so that the flame can be applied to a vertical or horizontal edge as shown in the examples of Figure 1. If possible the flame shall be applied at least 10 mm from a corner. The duration of application of the test flame shall be 30 s ± 1 s.</p> <p><i>Replace</i> with the following: The test shall be made on one specimen. If the specimen does not withstand the test, the test may be repeated on two further specimens, both of which shall withstand the test.</p> <p><i>Replace</i> with the following: The duration of burning (tb) shall not exceed 30 s. However, for printed circuit boards, it shall not exceed 15 s.</p>	
6.202.4	<p>Testing in the event of non-extinguishing material</p> <p>If parts, other than enclosures, do not withstand</p>		N/A

IEC62368_1B - ATTACHMENT			
Clause	Requirement + Test	Result - Remark	Verdict
	<p>the glow wire tests of Clause 6.202.3, by failure to extinguish within 30 s after the removal of the glow wire tip, the needle-flame test detailed in Clause 6.202.3 shall be made on all parts of non-metallic material which are within a distance of 50 mm or which are likely to be impinged upon by flame during the tests of Clause 6.202.3. Parts shielded by a separate barrier which meets the needle-flame test need not be tested.</p> <p>NOTE 1: If the enclosure does not withstand the glow-wire test the equipment is considered to have failed to meet the requirements of Clause 6.202 without the need for consequential testing.</p> <p>NOTE 2: If other parts do not withstand the glow-wire test due to ignition of the tissue paper and if this indicates that burning or glowing particles can fall onto an external surface underneath the equipment, the equipment is considered to have failed to meet the requirements of Clause 6.202 without the need for consequential testing.</p> <p>NOTE 3: Parts likely to be impinged upon by the flame are considered to be those within the envelope of a vertical cylinder having a radius of 10 mm and a height equal to the height of the flame, positioned above the point of the material supporting, in contact with, or in close proximity to, connections.</p>		
6.202.5	<p>Testing of printed boards</p> <p>The base material of printed boards shall be subjected to the needle-flame test of Clause 6.202.3. The flame shall be applied to the edge of the board where the heat sink effect is lowest when the board is positioned as in normal use. The flame shall not be applied to an edge, consisting of broken perforations, unless the edge is less than 3 mm from a potential ignition source.</p> <p>The test is not carried out if—</p> <ul style="list-style-type: none"> – the printed board does not carry any potential ignition source; – the base material of printed boards, on which the available apparent power at a connection exceeds 15 VA operating at a voltage exceeding 50 V and equal or less than 400 V (peak) a.c. or d.c. under normal operating conditions, is of flammability category V-1 or better according to AS/NZS 60695.11.10, or the printed boards are protected by an enclosure meeting the flammability category V-0 according to AS/NZS 60695.11.10, or made of metal, having openings only for connecting wires which fill the openings completely; or – the base material of printed boards, on which the available equipment power at a connection exceeds 15 VA operating at a voltage exceeding 		N/A

IEC62368_1B - ATTACHMENT			
Clause	Requirement + Test	Result - Remark	Verdict
	<p>400 V (peak) a.c. or d.c. under normal operating conditions, and base material of printed boards supporting spark gaps which provides protection against overvoltages, is of flammability category V-0 according to AS/NZS 60695.11.10 or the printed boards are contained in a metal enclosure, having openings only for connecting wires which fill the openings completely.</p> <p><i>Conformance shall be determined using the smallest thickness of the material.</i></p> <p>NOTE: Available apparent power is the maximum apparent power which can be drawn from the supplying circuit through a resistive load whose value is chosen to maximize the apparent power for more than 2 min when the circuit supplied is disconnected.</p>		
6.202.6	<p>For open circuit voltages greater than 4 kV</p> <p>Potential ignition sources with open circuit voltages exceeding 4 kV (peak) a.c. or d.c. under normal operating conditions shall be contained in a FIRE ENCLOSURE which shall comply with flammability category V-1 or better according to AS/NZS 60695.11.10.</p>		N/A
8.6.1.201	<p>8.6.1.201 Instructional safeguard for fixed-mount television sets</p> <p>MS2 and MS3 television sets and display devices designed only for fixed mounting to a wall of ceiling or equipment rack shall, where required in Table 36, footnote 201, have an instructional safeguard in accordance with Clause F.5 which may be on the equipment or included in the installation instructions or equivalent document accompanying the equipment.</p> <p>The elements of the instructional safeguard shall be as follows:</p> <ul style="list-style-type: none"> – element 1a: not available; – element 2: ‘Stability Hazard’ or equivalent wording; – element 3: ‘The television set may fall, causing serious personal injury or death’ or equivalent text; – element 4: the following or equivalent text: To prevent injury, this television set must be securely attached to the floor/wall in accordance with the installation instructions 	Equipment designed not only for fixed mounting to a wall of ceiling or equipment rack shall.	N/A

IEC62368_1B - ATTACHMENT			
Clause	Requirement + Test	Result - Remark	Verdict
8.6.1.202	<p>Restraining device</p> <p>MS2 and MS3 television sets and display devices that are not solely fixed-mounted should be provided with a restraining device such as a fixing point to facilitate restraining the equipment from toppling forward. The restraining device shall be capable of withstanding a pull of 100 N in all directions without damage.</p> <p>Where a restraining device is provided, instructions shall be provided in the instructions for installation or instructions for use to ensure correct and safe installation.</p>		N/A

NDs of J62368-1(H30) (JIS C 62368-1:2018) for IEC 62368-1:2014			
Clause	Requirement + Test	Result - Remark	Verdict
National Differences - Japan			
3.3	Addition: Before Item CLASS I listed in sub-clause 3.3, add "CLASS 0I 3.3.15.4A".	Class III equipment.	N/A
3.3.3.5	Replacement: NOTE in sub-clause 3.3.3.5, replace "IEC/TR 60083 and IEC 60320-1." with "JIS C 8282 sereis, JIS C 8283-1 and JIS C 8303".	Replaced.	N/A
3.3.3.6	Replacement: NOTE in sub-clause 3.3.3.6, replace "IEC 60309-1" with "JIS C 8285 and IEC 60309-1".	Replaced.	N/A
3.3.4.2	Replacement: NOTE in sub-clause 3.3.4.2, replace "IEC 60695-11-10, IEC 60695-11-20, ISO 9772 or ISO 9773" with "JIS C 60695-11-10, JIS C 60695-11-20, JIS K 7341 or ISO 9772".	Replaced.	N/A
3.3.15.1	Addition: After sub-clause 3.3.15.4, add the following Note 3. Note 3: Even if class I equipment, 2-pin conversion plug with protective earthing lead-wire or cord set provided 2 pin plug with protective earthing lead-wire shall be provided as an optional parts or recommend for user to use the them, refer to the 3.3.15.4A	Class III equipment.	N/A

NDs of J62368-1(H30) (JIS C 62368-1:2018) for IEC 62368-1:2014			
Clause	Requirement + Test	Result - Remark	Verdict
3.3.15.4A	<p>Addition: After sub-clause 3.3.15.4, add the following new sub-clause.</p> <p>3.3.15.4A CLASS 0I equipment equipment in which protection against electric shock does not rely on basic insulation only, as a supplementary safeguard, which, for the connection of accessible conductive parts to the protective (earthing) conductor in the fixed wiring of the installation in such a way, pluggable equipment with protective earthing conductor or protective earthing lead-wire instead of plug without earthing blade.</p> <p>2-pin conversion plug with protective earthing lead-wire or cord set provided 2 pin plug with protective earthing lead-wire shall be provided as an optional parts or recommend for user to use the them.</p> <p>Note to entry: CLASS01 equipment may be provided with CLASS II construction.</p>	Class III equipment.	N/A
4.1.2	<p>Replacement: In the sub-clause 4.1.2, replace the first paragraph with the following.</p> <p>Where the component, or a characteristic of a component, is a safeguard or a part of a safeguard, components shall comply with the requirements of this standard or, where specified in a requirements clause, with the safety aspects of the relevant JIS or IEC component standards, otherwise, shall have same or better performances than those components.</p>	Replaced.	N/A

NDs of J62368-1(H30) (JIS C 62368-1:2018) for IEC 62368-1:2014			
Clause	Requirement + Test	Result - Remark	Verdict
	<p>Addition: After the first paragraph of sub-clause 4.1.2, addition to the existing NOTE with the following.</p> <p>NOTE 0A Components complying with “Interpretation of Ministerial Ordinance establishing Technical Requirements for Electrical Appliances and Materials (20130605, shokyoku No. 3)” (hereinafter, described as “Interpretation of Technical Requirements”) are regarded to be of having equivalent or better performances.</p>	Added.	P
	<p>Replacement: After the first paragraph of sub-clause 4.1.2, replace the existing NOTE with the following. NOTE 2 A JIS or IEC component standard etc. (hereinafter, described as “component standard”) is considered relevant only if the component in question clearly falls within its scope.</p>	Replaced.	P
4.1.3	<p>Addition: After the last paragraph of sub-clause 4.1., addition to the existing NOTE with the following.</p> <p>NOTE: transportable equipment or similar equipment, for equipment used by moving often and used, for equipments installed under the circumstances where the earthing connection is obviously difficult when installing, by considering the power distribution circumstances in Japan, it is recommended to avoid the insulation construction of CLASS I or CLASS 0I, except apparatus intended for installation by the instructed person or skilled person.</p>	Not such equipment.	N/A
5.3.2.3	<p>Replacement: In the sub-clause 5.3.2.3, replace the third paragraph with the following.</p> <p>Comply with clause 4.1.2, components and subassemblies that comply with their respective IEC standards do not have to be tested when such components and subassemblies are used in the final product.</p>	Replaced.	P

NDs of J62368-1(H30) (JIS C 62368-1:2018) for IEC 62368-1:2014			
Clause	Requirement + Test	Result - Remark	Verdict
5.4.1.4.3 Table10	<p>Addition: In the bottom cell of Table 10 in sub-clause 5.4.1.4.3 add the following NOTE between Footnote b and Footnote c.</p> <p>NOTE For the case where no data for the material is available, 1. (1) □(△) of Appendix 4 of “Interpretation of Ministerial Ordinance establishing Technical Requirements for Electrical Appliances and Materials” is regarded that it is for determining the maximum temperature limit of the material concerned.</p>	Added.	P
5.4.2.3.2.4	<p>Addition: After the Note 2 of sub-clause 5.4.2.3.2.4, addition to the existing NOTE with the following. Refer to the Annex JA additional applicable requirement.</p>	Added.	N/A
5.4.3.4 Table 18	<p>Addition: At the end of table 18 sub-clause 5.4.3.4, add the following.</p> <p>NOTE “-” means it is not exist the requirement.</p>	Added.	P
5.4.9.2	<p>Addition: After the Note of sub-clause 5.4.9.2, addition to the existing NOTE with the following. Additonally routine testing for manufacturing may be used sub-clause 5.2 of IEC 62911.</p>	Added. No additionally routine testing for manufacturer.	N/A
5.6.1	<p>Addition: After the last paragraph of sub-clause 5.6.1, addition to the existing NOTE with the following. Mains appliance outlet and interconnection couplers shall comply with the requirements specified in the sub-clause G 4.2A.</p>	Not such equipment.	N/A
5.6.2.1	<p>Addition: After the third paragraph of sub-clause 5.6.2.1, addition to the existing NOTE with the following. Mains connection for Class 01 complying with F3.6.1A are regarded to comply with this requirement.</p>	Class III equipment.	N/A

NDs of J62368-1(H30) (JIS C 62368-1:2018) for IEC 62368-1:2014			
Clause	Requirement + Test	Result - Remark	Verdict
	<p>Addition: Add the following new sub-clause after sub-clause 5.6.2.1</p> <p>Mains plug with a protective earthing lead-wire of class 01 is followings Plugs with a protective earthing lead-wire shall not be used for equipment of which the rated voltage of the plug is to be of 150V or more. For plug with a protective earthing lead-wire, the protective earthing lead-wire shall not be earthed by a clip. The earthing lead-wire which is provided in the MAINS plug shall be a length of at least 10 cm.</p> <p>For CLASS 01 EQUIPMENT provided with an independent terminal as the main protective earthing terminal, if ordinary person intended for install the equipment, a protective earthing connection wire is not packed together with the equipment.</p>	Class III equipment.	N/A
5.6.2.2	<p>Addition: At the end of the first paragraph of sub-clause 5.6.2.2, add the following.</p> <p>However, this requirement does not apply to the internal conductor of the supply cord (cord set) which was covered by sheath and integrally molded together with plug and coupler.</p>	Class III equipment.	N/A
5.6.3	<p>Addition: At the end of the first paragraph of sub-clause 5.6.3, add the following.</p> <p>Additionally, if single-core conductor is used for the protective earthing lead wire or protective earthing connection wire for CLASS 01 EQUIPMENT, it shall be any of:</p> <ul style="list-style-type: none"> - annealed copper wire of a diameter of 1,6 mm, or metal wire having equivalent to or more strength and thickness than that and not easily corroding easily; and - single-core cord or single-core cable with a cross-sectional area of 1,25 mm² or more. 	Class III equipment.	N/A

NDs of J62368-1(H30) (JIS C 62368-1:2018) for IEC 62368-1:2014			
Clause	Requirement + Test	Result - Remark	Verdict
	<p>Replacement: NOTE 3 in sub-clause 5.6.3, replace to following. NOTE 3 Heavy duty is defined in IEC 62440.</p>	Class III equipment.	N/A
5.6.4.2.1	<p>Addition: After Note3 of sub-clause 5.6.4.2.1, addition to the existing NOTE4 with the following.</p> <p>NOTE 4 In Japan, the protective current rating of the circuit supplied from the mains is widely taken as 20 A in case of connection to outlet rated at 20A or less.</p>	Added.	N/A
5.7.3	<p>Addition: At the end of sub-clause F.3.5.1, add the following.</p> <p>According to the requirement of G.4.2A, JIS C 8282 series, JIS C 8303 or Class 01 equipment have mains appliance outlet can connect class 1 equipment specified related standard Intended for interconnection, or provided with mains appliance outlet specified JIS C 8232-2-2, shall be measured as a interconnected equipment system have only connection to the mains.</p> <p>NOTE 2 Limit of class 01 equipment is specified 5.7.4. NOTE 3 Complying with Appendix 4 of "Interpretation of Technical Requirements" are regarded to be complied with relevant standard.</p>	Class III equipment.	N/A
5.7.4	<p>Addition: At the end of the first paragraph of sub-clause 5.7.4, add the following.</p> <p>For Class 01 equipment, measuring the touch current using the circuit specified Figure 4 of IEC 60990, the touch current shall not exceed 1.41mA (peak value) or 1.0mA (r.m.s value) in case if sine wave.</p>	Class III equipment.	N/A
6.4.3.2	<p>Replacement: In the paragraph of second, third and fourth dash in sub-clause 6.4.3.2 replace "the relevant IEC component standard" with "the relevant JIS or IEC component standard".</p>	Replaced.	N/A

NDs of J62368-1(H30) (JIS C 62368-1:2018) for IEC 62368-1:2014			
Clause	Requirement + Test	Result - Remark	Verdict
6.4.3.3	<p>Replacement: First dash in sub-clause 6.4.3.3, replace the following.</p> <p>a fuse complying with the IEC 60127 series or having equivalent or better properties shall open within 1 s.</p> <p>NOTE Fuses complying with Appendix 3 of "Interpretation of Technical Requirements" are regarded to be of having equivalent or better properties.</p>	Replaced.	N/A
	<p>Replacement: Second dash in sub-clause 6.4.3.3, replace the following.</p> <p>a fuse not complying with the IEC 60127 series and not having equivalent or better properties shall open within 1 s for three consecutive times</p>	Replaced.	N/A
	<p>Addition: After the last dash in sub-clause 6.4.3.3, add the following new paragraph including NOTE 3.</p> <p>For Type A fuse specified in JIS C 6575 series of standards, replace "2,1 times" with "1,35 times", and for Type B fuse, "2,1 times" with "1,6 times". For fuses having other than operating characteristics specified in JIS C 6575 series of standards, the tests shall be carried out by taking into account the characteristics.</p> <p>NOTE According to pre-arcing time-current characteristics specified in Appendix 3 of "Interpretation of Technical Requirements", for Type A fuse, "2,1 times" is replaceable with "1,35 times", and for Type B fuse, "2,1 times" is replaceable with "1,6 times".</p>	Replaced.	N/A
8.5.4.1	<p>Replacement: First dash in sub-clause 8.5.4.1, replace the following.</p> <p>Replace the requirement of Safety interlock (Protection of persons in the work cell) of sub-clause 4 by Annex sub-clause K</p>	Replaced.	N/A

NDs of J62368-1(H30) (JIS C 62368-1:2018) for IEC 62368-1:2014			
Clause	Requirement + Test	Result - Remark	Verdict
	<p>Replacement: Second dash in sub-clause 8.5.4.1, replace the following.</p> <p>Replace the requirement of interlock override (General of Interlock override) of sub-clause 5.1 by Annex sub-clause K</p>	Replaced.	N/A
8.5.4.2.1	<p>Replacement: After Note1 of in sub-clause 8.5.4.2.1, replace the following.</p> <p>For equipment that it is limited to a stationary type that is directly connected to a power supply of 3 phase 200 V or more, for use in locations where children are not likely to be present, see sub-clause F.4.</p>	Replaced.	N/A
8.5.4.2.2	<p>Replacement: Replace first paragraph of sub-clause 8.5.4.2.2 with the following.</p> <p>For equipment installed where children may be present, an instructional safeguard shall be provided in accordance with Clause F.5, except that element 3 is optional.</p>	Replaced.	N/A

NDs of J62368-1(H30) (JIS C 62368-1:2018) for IEC 62368-1:2014			
Clause	Requirement + Test	Result - Remark	Verdict
	<p>Addition: After the element 1a of sub-clause 8.5.4.2.2, addition to the following.</p> <p>Instructed safeguard shall be provided and marked with the symbol of JIS S 0101:2000, 6.2.1 (general precaution) using easily understandable word and the following precautions for use, on the readily visible part adjacent to the feed opening for documents, by a method being clearly legible and permanent, and with easily understandable terms:</p> <ul style="list-style-type: none"> - that use by an infant/children may cause a hazard of injury etc.; - that touching by a hand to the feed opening for documents may cause drawing of the hand into the shred mechanism; - that contacting of clothes with the feed opening for documents may cause drawing of the clothes into the shred mechanism; - that contacting of hairs with the feed opening for documents may cause drawing of hairs into the shred mechanism; and - that spraying of flammable gas may cause ignition or explosion (limited to equipment incorporated with a commutator motor). 	Added.	N/A
8.5.4.2.4	<p>Replacement: After the first paragraph of sub-clause 8.5.4.2.4, replace the following.</p> <p>The media destruction device is tested with the wedge probe of Figure V.4 applied to the opening using test probe with provided applicable jointed test probe by applied sub-clause V1.2, further is tested with the wedge probe of Figure V.4 applied in any direction relative to the opening.</p>		N/A
8.5.4.2.5	<p>Replacement: After the first paragraph of sub-clause 8.5.4.2.5, replace the following.</p> <p>Compliance is checked in accordance with sub-clause V.1.2 and sub-clause V.1.5. Applicable jointed test prove of Annex V and the wedge probe of Figure V.4 shall not contact any moving part.</p>		N/A

NDs of J62368-1(H30) (JIS C 62368-1:2018) for IEC 62368-1:2014			
Clause	Requirement + Test	Result - Remark	Verdict
	<p>Addition: At the end of sub-clause 8.5.4.2.5, add the following.</p> <p>Alternative construction that prevent access to the hazard moving parts shall not use the warnings.</p>		N/A
8.9.1	<p>Replacement: In the paragraph of sub-clause 8.9.1, replace "MS3 and some MS2 equipment" with "MS3 equipment".</p>		N/A
9.2.5	<p>Replacement: In the paragraph of sub-clause 9.2.5, replace "room ambient temperature shall be 25 $\begin{smallmatrix} -5 \\ +0 \end{smallmatrix}$" with "room ambient temperature shall be 25 $\begin{smallmatrix} -5 \\ +5 \end{smallmatrix}$".</p>	Replaced.	P
9.2.6 Table38	<p>Addition: In the top cell of TS2 of Table 38 in sub-clause 9.2.6 add the following</p> <p>Handles, knobs, grips, etc., and external surfaces held, touched or worn against the body in normal use(> 1 min) ^c</p>	Added.	P

NDs of J62368-1(H30) (JIS C 62368-1:2018) for IEC 62368-1:2014			
Clause	Requirement + Test	Result - Remark	Verdict
F.3.5.1	<p>Addition: At the end of sub-clause F.3.5.1, add the following.</p> <p>According to the requirement of sub-clause G.4.2A, JIS C 8282 series, JIS C 8303 or Class 01 equipment have mains appliance outlet can connect class 1 equipment specified related standard Intended for interconnection, shall be provided with instructed safeguard specified F.5. However mains socket-outlet exclude only accessible to a skilled person.</p> <p>NOTE Appendix 4 of “Interpretation of Ministerial Ordinance establishing Technical Requirements for Electrical Appliances and Materials” is relevant national standard.</p> <p>The elements of the instructed safeguard shall be as follows:</p> <ul style="list-style-type: none"> - element 1a: not applied - element 2: “(equipment name) Exclusive socket-outlet” or equivalent text - element 4: “This socket-outlet intended for connect only with (manufacturer’s name), (model number or series), (equipment name)” or better wording - element 3: “Connect with other equipment may result in electric hazard” or equivalent text <p>This elements shall be in the order 2,4, and 3. element 2 shall be marked near the mains socket-outlet. If this instructed safeguard provided, may not mark rated valtage and assigned current or power.</p>		N/A
F.3.5.3	<p>Addition: As examples in the first dash of sub-clause F.3.5.3, add the following at the end of the first dash.</p> <p>Ⓐ, denoting Type A; Ⓑ, denoting Type B;</p>	Added.	P

NDs of J62368-1(H30) (JIS C 62368-1:2018) for IEC 62368-1:2014			
Clause	Requirement + Test	Result - Remark	Verdict
F.3.6.1A	<p>Addition: After sub-clause F.3.6.1, add the following new sub-clause.</p> <p>F.3.6.1A Marking for CLASS 0I EQUIPMENT Requirement of sub-clause F.3.6.1.1 and sub-clause F.3.6.1.1 also apply for CLASS 0I EQUIPMENT.</p> <p>For CLASS 0I EQUIPMENT, mains plug or on the easily visible location shall be provided with the marking of the following content or the equivalent. Make an earthing connection</p> <p>Additionally for CLASS 0I EQUIPMENT, it shall be marked on the easily visible location of equipment body or indicated in the operating instructions: Make an earthing connection before plugging the mains plug to the mains, and when disconnecting the earthing connection, disconnect after unplugging the mains plug from the mains.</p>	Class III equipment.	N/A
F.3.6.2.1	<p>Addition: After second paragraph of sub-clause F.3.6.2.1, add the following. The above symbols shall not be used for class I equipment and class 0I equipment.</p>	Not such construction.	N/A
F.4	<p>Replacement: Replace fourth dash of sub-clause F.4 with the following.</p> <p>– For audio equipment with terminals classified as ES3 in accordance with Table E.1, and for other equipment with terminals marked in accordance with F.3.6.1, the instructions shall require that the external wiring connected to these terminals shall be installed by a skilled person, or shall be connected by means of ready-made leads or cords that are constructed in a way that would prevent contact with any ES3 circuit.</p>		N/A

NDs of J62368-1(H30) (JIS C 62368-1:2018) for IEC 62368-1:2014			
Clause	Requirement + Test	Result - Remark	Verdict
G.3.2.1	<p>Replacement: Replace second paragraphs of sub-clause G.3.2.1 with the following.</p> <p>The thermal link when tested as a separate component, shall comply with the requirements of JIS C 60691 or be of having equivalent or better performances.</p> <p>NOTE Fuses complying with Appendix 3 of "Interpretation of Technical Requirements" are regarded to be of having equivalent or better properties.</p>		N/A
G.3.4	<p>Replacement: Replace second paragraphs of sub-clause G.3.4 with the following.</p> <p>Except for devices covered by sub-clause G.3.5, overcurrent protective devices used as a safeguard shall comply with their applicable JIS standards confirming to the IEC standard or be of having equivalent or better properties. If they do not applied, shall be comply with their applicable IEC standard.</p> <p>NOTE Fuses complying with Appendix 3 of "Interpretation of Technical Requirements" circuit breaker or leakage detection devices complying with Appendix 4 of "Interpretation of Technical Requirements" are regarded to be of having equivalent or better properties.</p>	Replaced.	N/A
G.4.1	<p>Addition: After the last paragraph of sub-clause G.4.1., addition to the following.</p> <p>sub-clause G.4.2 and sub-clause G.4.2A are not applied to above requirements.</p>	Added.	N/A

NDs of J62368-1(H30) (JIS C 62368-1:2018) for IEC 62368-1:2014			
Clause	Requirement + Test	Result - Remark	Verdict
G.4.2	<p>Replacement: In sub-clause G.4.2, replace including NOTE with the following.</p> <p>Mains connectors shall be complied with one of the following standards JIS C 8282 series, JIS C 8283 series, JIS C 8285, JIS C 8303 or IEC 60309 series. Mains plug and appliance couplers shall be complied with one of the following standards JIS C 8282 series, JIS C 8285, JIS C 8303 or IEC 60309 series or be of having equivalent or better performances</p> <p>NOTE Complying with Appendix 4 of "Interpretation of Technical Requirements" are regarded to be complied with relevant standard.</p> <p>Power cord set have a shape not fittingable into the connection part specified in other relevant JIS standards than JIS C 8285 shall comply with JIS C 8286</p> <p>Where using an appliance coupler, the apparatus shall have a construction that the soldered parts of terminals of the appliance inlet is not subjected to mechanical stress, during insertion and removal of the connector, except the case where the appliance inlet itself is secured so that the fixing does not rely on only soldering.</p> <p>By limiting to the case where the rated voltage of the apparatus is 125 V or less, appliance inlets of type C14 and C18, complying with JIS C 8283 series may be used up to 15 A, if following all requirement shall be complied.</p> <ul style="list-style-type: none"> - the temperature of the appliance inlet does not exceed the limit specified in JIS C 8283-1 even under the normal operation conditions specified in B.2.1. - "It shall be only used specified power cord set packed together with the equipment. ", or having same or better wording was described in the operation manual. If power cord set was not packed together with the equipment, applicable information of power cord set shall be described in the operation manual. 	Class III equipment.	N/A

NDs of J62368-1(H30) (JIS C 62368-1:2018) for IEC 62368-1:2014			
Clause	Requirement + Test	Result - Remark	Verdict
G.4.2A	<p>Addition: In sub-clause G.4.2, add including NOTE with the following.</p> <p>G.4.2A Mains socket-outlet and main interconnection coupler provide with equipment</p> <p>If mains socket-outlet specified with JIS C 8282 series, JIS C 8303 or related standard or main interconnection coupler in accordance with JIS C 8283-2-2 is provided on the equipment, it shall be complied with followings.</p> <ul style="list-style-type: none"> - Mains socket-outlet and main interconnection coupler provided with Class II equipment shall be only connected to other Class II equipment. - Mains socket-outlet and main interconnection coupler provided with Class I equipment shall be only connected to other Class II equipment or be provided with protective earth pole ensurelly connected to protective earth terminal or protective earth point pole of the equipment. - Main interconnection coupler provided with Class 0I equipment shall be only connected to other Class II equipment. However Class I equipment may be connected if following condition complied. <ul style="list-style-type: none"> • Main interconnection coupler shall be provided with protective earth pole ensurelly connected to protective earth terminal or protective earth point pole of the equipment. • According to the sub-clause 5.7.3, touch current value measured as interconnected system provided with one connection to mains supply, is less than the limit of class 0I equipment specified in sub-clause 5.7.4. - Mains socket-outlet provided with Class 0I eaupment shall be only connected to other Class II equipment. However providing with mains socket-outlet as an interconnection coupler, Class I equipment can be connect if following condition complied. • Main socket-outlet shall be provided with protective earth pole ensurelly connected to protective earth terminal or protective earth point pole of the equipment. 	No mains socket-outlet and main interconnection coupler.	N/A

NDs of J62368-1(H30) (JIS C 62368-1:2018) for IEC 62368-1:2014			
Clause	Requirement + Test	Result - Remark	Verdict
	<ul style="list-style-type: none"> • Mains socket-outlet exclude only accessible to a skilled person, shall be provided instructed safeguard specified sub-clause F3.5.1 only to connect to equipment which manufacture intended for. • According to the sub-clause 5.7.3, touch current value measured as interconnected system provided with one connection to mains supply, is less than the limit of class 01 equipment specified in sub-clause 5.7.4. <p>NOTE 1: transportable equipment or similar equipment, for equipment used by moving often and used, by considering the power distribution circumstances in Japan, it is recommended to avoid the insulation construction of CLASS 0I provided with mains socket outlet complied with JIS C 8282 series, JIS C 8303 or related standard, except apparatus intended for installation by the skilled person.</p> <p>NOTE 2: Appendix 4 of "Interpretation of Ministerial Ordinance establishing Technical Requirements for Electrical Appliances and Materials" is relevant national standard</p>		
G.4.3	<p>Addition: After the EXAMPLE in sub-clause G.4.3, add NOTE as follows.</p> <p>NOTE: It was deleted the sentence of "An example of a connector not meeting the requirements of this subclause is the so-called "banana" plug." from national standard example.</p>	Added.	N/A
G.7.1	<p>Replacement: Third dash in sub-clause G.7.1, replace to following.</p> <ul style="list-style-type: none"> - other types of cords may be used if they have similar electro-mechanical and fire safety properties as above having equivalent or better. 	Replaced.	N/A

NDs of J62368-1(H30) (JIS C 62368-1:2018) for IEC 62368-1:2014			
Clause	Requirement + Test	Result - Remark	Verdict
	<p>Addition: After the NOTE3 in sub-clause G.7.1, add NOTE 3A as follows.</p> <p>NOTE 3A Sheathed MAINS supply cords complying with Appendix 1 of "Interpretation of Technical Requirements" are regarded to be of having equivalent or better electro-mechanical and fire safety properties.</p>		N/A
	<p>Addition: After the NOTE3A in sub-clause G.7.1, add NOTE 3A as follows.</p> <p>For pluggable equipment type A or pluggable equipment type B that has protective earthing, a protective earthing conductor shall be included in the mains supply cord. However if Class 0I equipment have another protective earth terminal, mains power cord do not need to provided with protective earth cable. For all other equipment, if a mains supply cord is supplied without a protective earthing conductor, a protective earthing conductor cable shall be supplied as well</p>		N/A
G.7.2	<p>Addition: In sub-clause G.7.12 add NOTE 0A as follows.</p> <p>NOTE 0A Cross sectional area of power supply cord complying with Appendix 1 of "Interpretation of Technical Requirements" deemed to have equivalent or higher safety performance in sub-clause G 7.1 may be applied with related wiring standard.</p>		N/A
G.7.6.1	<p>Replacement: In the paragraph of sub-clause G.7.6.1, replace "Table G.4" with "Table G.5".</p>		N/A

NDs of J62368-1(H30) (JIS C 62368-1:2018) for IEC 62368-1:2014			
Clause	Requirement + Test	Result - Remark	Verdict
	<p>Addition: After the NOTE0A in sub-clause G.7.12 add as follows.</p> <p>NOTE 0A Cross sectional area of power supply cord complying with Appendix 1 of "Interpretation of Technical Requirements" deemed to have equivalent or higher safety performance in sub-clause G 7.1 may be applied with related wiring standard.</p>		N/A
G.8.1	<p>Replacement: In the second paragraph of sub-clause G.8.1, replace "a varistor" with "a varistor voltage of the varistor".</p>	Replaced.	N/A
G.8.3.3	<p>Replacement: In the first dash of sub-clause G.8.3.3, replace "1.71" with "1.71 x 1.1".</p>	Replaced.	N/A
	<p>Replacement: In sub-clause G.8.3.3, replace including NOTE with the following.</p> <p>NOTE 2 For different power distribution systems, the temporary overvoltages are defined in Table B.3 of JIS C 5381-11 (TOV tested parameter for Japan distribution system).</p>	Replaced.	N/A
G9.3	<p>Replacement: Last dash in sub-clause 6.4.3.3, replace the following.</p> <p>7 days with the output short-circuited and the device wrapped in a double layer of cheesecloth. A quick acting 5 A fuse (complied with JIS C 6575-2) kept in series with the output shall not open and a current meter shall not show a current of more than 5 A.</p>		N/A
G16.3	<p>Addition: Before the NOTE in sub-clause G.16.3 add as follows.</p> <p>Refer to the sub-clause 5.2.2.2.</p>	Replaced.	N/A

NDs of J62368-1(H30) (JIS C 62368-1:2018) for IEC 62368-1:2014			
Clause	Requirement + Test	Result - Remark	Verdict
Annex H.1	<p>Replacement: In the sub-clause Annex H.1, replace with the following.</p> <p>It can be select one of the two alternative methods described in this annex. Method A is typical of analogue telephone networks in Europe, and Method B of those in North America.</p>		N/A
M.2.1	<p>Replacement: In the sub-clause M.2.1, replace with the following.</p> <p>Batteries and their cells shall comply with the relevant standards for batteries as listed below.</p> <ul style="list-style-type: none"> - JIS C 8513 or IEC 60086-4 - JIS C 8514 or IEC 60086-5 - JIS C 8704-1 or IEC 60896-11 - JIS C 8704-2-1 or IEC 60896-21 - JIS C 8704-2-2 or IEC 60896-22 - JIS C 8702-1 or IEC 61056-1 - JIS C 8702-2 or IEC 61056-2 - IEC 61427 - IEC/TS 61430 - IEC 61434 - JIS C 8713 - JIS C 8712 or IEC 62133 - IEC 62281 - IEC 62485-2 <p>NOTE Other battery safety standards are under development, and are intended to be included in future.</p>		P
M.8.2.1	<p>Replacement: In the sub-clause M.8.2.1, replace the first paragraph with the following.</p> <p>The test shall be carried out according to JIS C 8704-2-1 or IEC 60896-21:2004, 6.4</p>		P

NDs of J62368-1(H30) (JIS C 62368-1:2018) for IEC 62368-1:2014			
Clause	Requirement + Test	Result - Remark	Verdict
M.8.2.2	<p>Addition: After the description of LEL in sub-clause M.8.2.2, add the follows.</p> <p>However it is necessary to convert to mass fraction (kg/m^3). The fraction refer to the Sub clause B.4.2.2 Note 1 of JIS C 60079-10.</p>		N/A

IEC62368_1B - ATTACHMENT			
Clause	Requirement + Test	Result - Remark	Verdict
Appendix	Appendix 12, J3000(H25) Special National conditions, National deviation and other information according to MITI Ordinance No. 85.		—
1	General requirement When equipment provides with appliance inlet complying with JIS C 8283-1(2008), soldered parts of appliance inlet is not applied by force during insert or removal of connector. This is not applied when inlet body is fixed itself and not fixed by solder.	Inlet is fixed by adequate mechanical construction, not rely on soldering.	P
2	Requirement for equipment		—
2.1	Heater Appliances When diode is used in parallel for adjustment of power, the equipment shall remain safe for operation under open condition of one diode.	Not electric stove.	N/A
	The current rating of one diode shall be more than main current. The diodes connected in parallel are same type.		N/A
	The heating test specified by clause 11 of JIS C 9335-2-30(2006) under open condition of one diode shall comply with the requirements.		N/A
2.2	Electric heater with glowing heating elements	Not electric stove.	N/A
	Surface treatment by paint or adhesive on protective frame or protective mesh shall not be used.		N/A
	Caution marking like below shall be on - easily visible place of the equipment or - Instruction manual 「注意 当該機器から、使用初期段階で揮発性有機化合物及びカルボニル化合物が最も放散するおそれがあるため、その際には十分換気を行うこと。」		N/A
3	Components used in equipment	No such equipment /components.	N/A

IEC62368_1B - ATTACHMENT			
Clause	Requirement + Test	Result - Remark	Verdict
3.1	Motor capacitors used in ventilating fan, electric fan, air conditioner, electric washing machine, refrigerator or electric freezer shall be comply with <ul style="list-style-type: none"> - capacitors with protective elements or protective mechanism complying with JIS C 4908(2007) - P2 capacitor complying with IEC 60252-1(2001) Capacitor complying with below is acceptable		N/A
	Enclosed by metal or ceramic		N/A
	No non-metallic materials within 50 mm from capacitor surface		N/A
	Non-metallic material within 50 mm from capacitor surface comply with needle frame test of JIS C 9335-1(2003), Annex E		N/A
	Non-metallic material within 50 mm from capacitor surface comply with V-1 test of JIS C 60965-11-10(2006).		N/A
3.2	Plug directly inserted to outlet used refrigerator or electric freezer. Shall comply with <ul style="list-style-type: none"> - Face contact with outlet shall have CTI with more than 400 according to JIS C 2134(2007) or - Supporting material of blades shall comply with glow wire test by temperature of 750°C according to JIS C 60695-2-11(2004) or JIS C 60695-2-12(2004). Materials having glow wire frame temperature of 775 °C are acceptable.		N/A

Product: LCD Monitor

Type Designation: 27B2, 27B2*****, C27B2*****, 24B2, 24B2*****, C24B2***** (* can be 0-9, A-Z, a-z, -, \, /, + or blank for marketing purpose only, no technical difference.)



Figure 1. Front view of 27.0 inch models



Figure 2. Back view of 27.0 inch models

Product: LCD Monitor

Type Designation: 27B2, 27B2*****, C27B2*****; 24B2, 24B2*****, C24B2***** (* can be 0-9, A-Z, a-z, -, \, /, + or blank for marketing purpose only, no technical difference.)



Figure 3. Internal view of 27.0 inch models



Figure 4. Front view of 23.8 inch models

Product: LCD Monitor

Type Designation: 27B2, 27B2*****, C27B2*****, 24B2, 24B2*****, C24B2***** (* can be 0-9, A-Z, a-z, -, \, /, + or blank for marketing purpose only, no technical difference.)



Figure 5. Back view of 23.8 inch models



Figure 6. Internal view of 23.8 inch models

Product: LCD Monitor

Type Designation: 27B2, 27B2*****, C27B2*****, 24B2, 24B2*****, C24B2***** (* can be 0-9, A-Z, a-z, -, \, /, + or blank for marketing purpose only, no technical difference.)

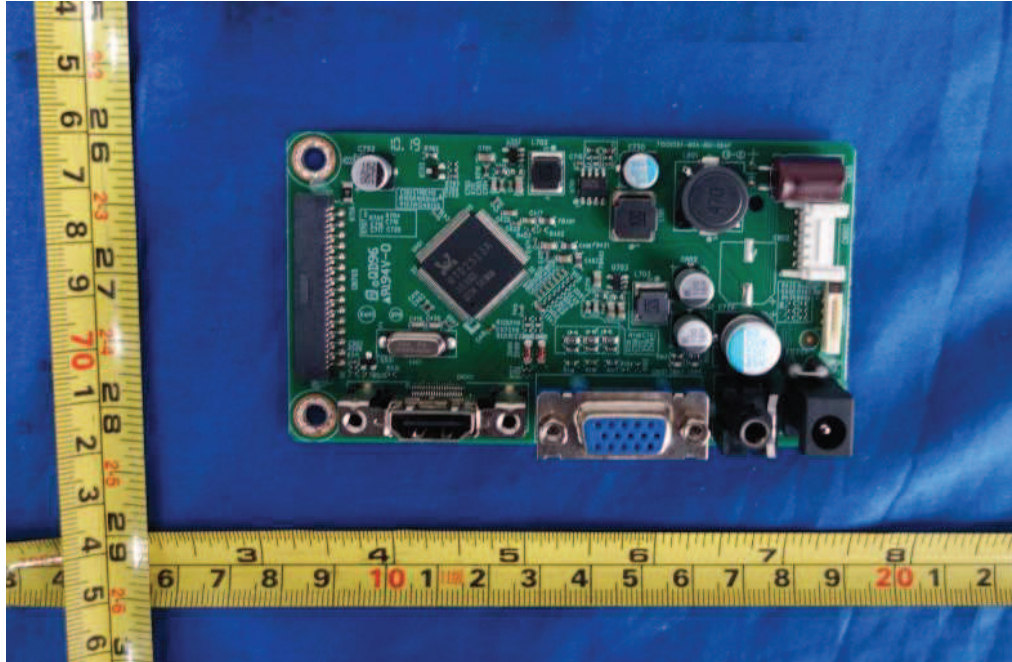

Figure 7. Main board 715G9284

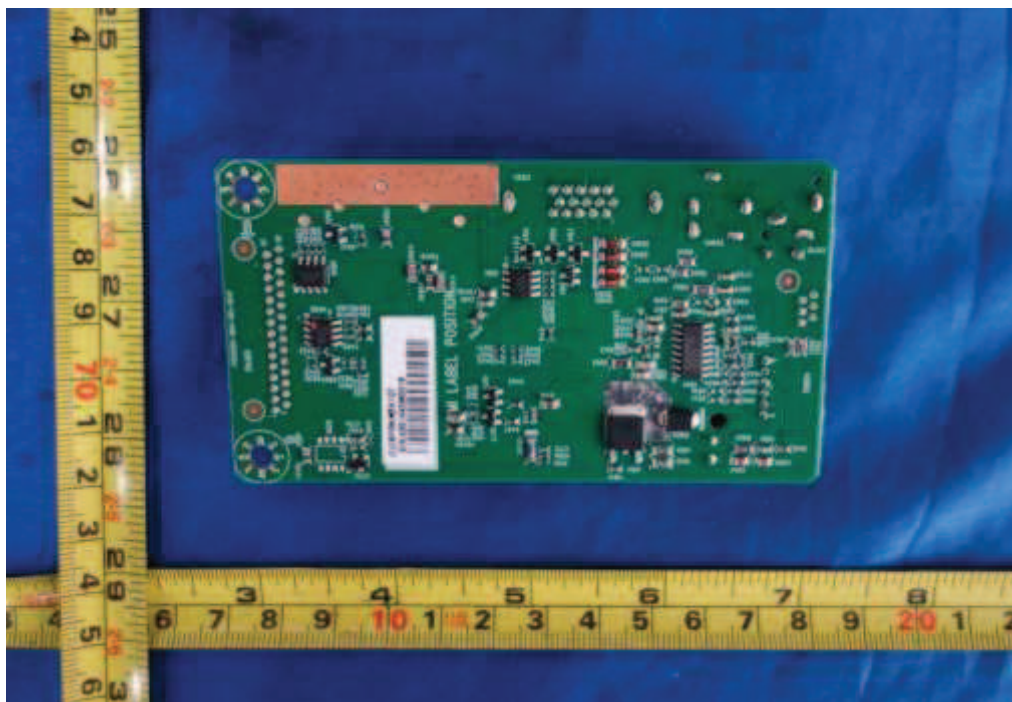

Figure 8. Main board 715G9284

Product: LCD Monitor

Type Designation: 27B2, 27B2*****, C27B2*****, 24B2, 24B2*****, C24B2***** (* can be 0-9, A-Z, a-z, -, \, /, + or blank for marketing purpose only, no technical difference.)

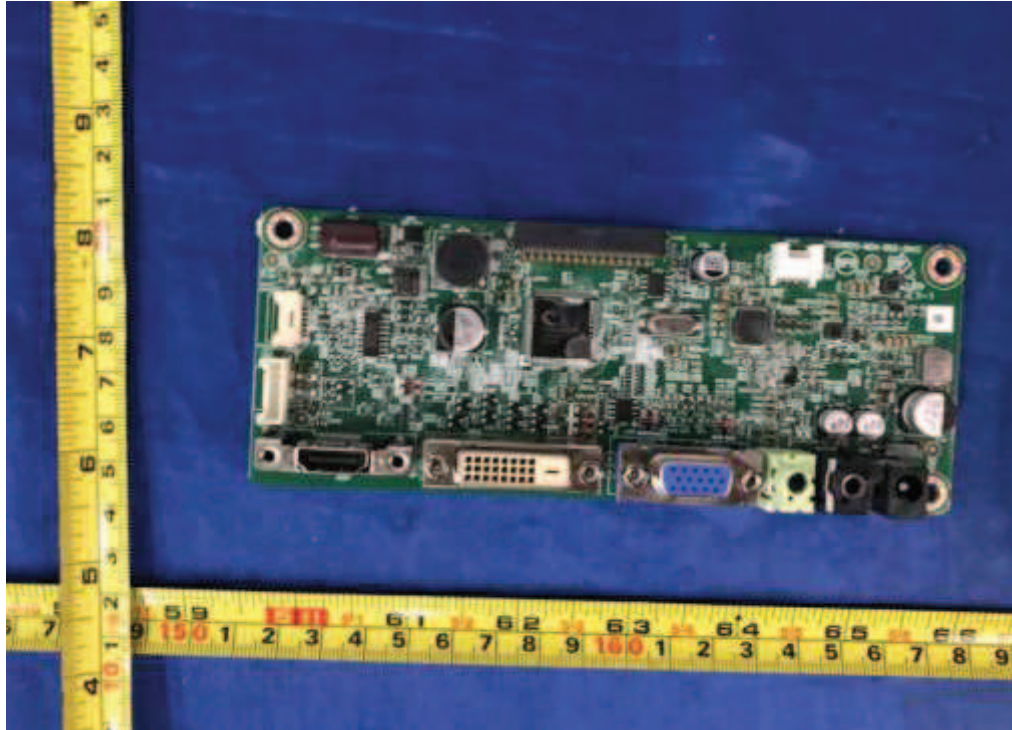

Figure 9. Main board 715G9620

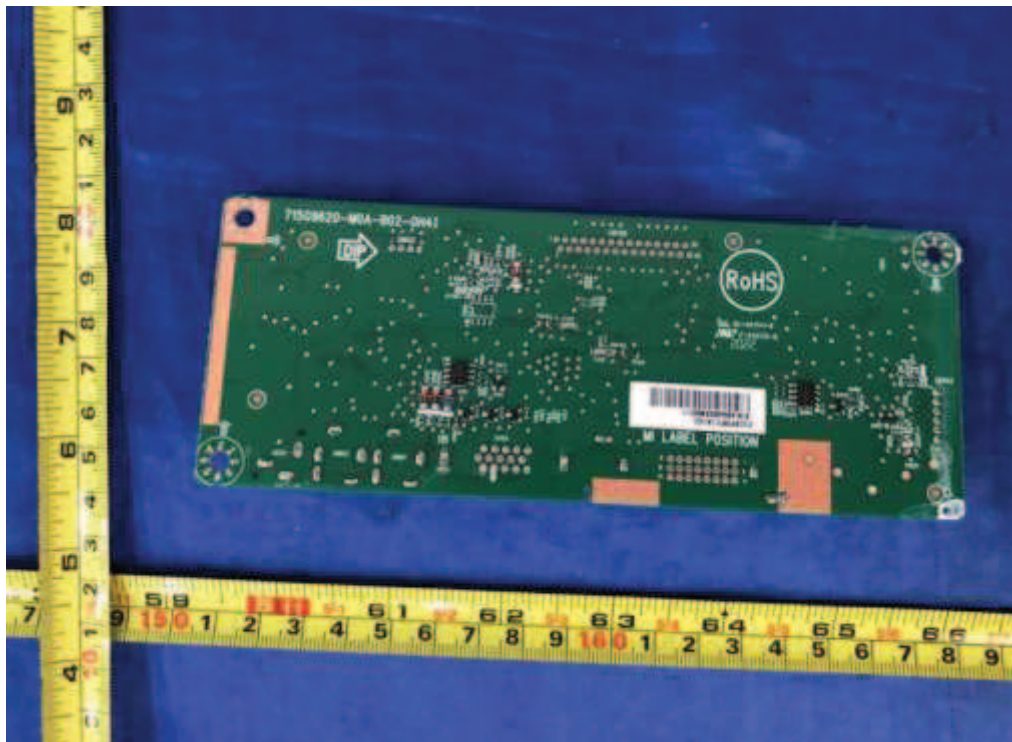

Figure 10. Main board 715G9620