

FCC&ISED EMC Test Report

Project No. : 2006C052
Equipment : LCD Monitor
Brand Name : N/A
Test Model : **PD27***** (*=0-9,A-Z,a-z,+,-,/,) or blank)
Series Model : N/A
Applicant : TPV Electronics (Fujian) Co., Ltd.
Address : Rongqiao Economic and Technological Development Zone, Fuqing City,
Fujian Province, P.R. China
Date of Receipt : Jun. 15, 2020
Date of Test : Jun. 15, 2020 ~ Jun. 29, 2020
Issued Date : Jul. 03, 2020
Report Version : R00
Test Sample : Engineering Sample No.: DG2020061623
Standard(s) : FCC CFR Title 47,Part 15,Subpart B
ICES-003 Issue 6:January 2016
ICES-003 Issue 6:January 2016 (updated April 2019)

The above equipment has been tested and found compliance with the requirement of the relative standards by BTL Inc.

Derek Tong

Prepared by : Derek Tong

Kevin Li

Approved by : Kevin Li



Certificate #5123.02

Add: No.3, Jinshagang 1st Road, Shixia, Dalang Town,Dongguan, Guangdong, China.

Tel: +86-769-8318-3000

Web: www.newbtl.com

Declaration

BTL represents to the client that testing is done in accordance with standard procedures as applicable and that test instruments used has been calibrated with standards traceable to international standard(s) and/or national standard(s).

BTL's reports apply only to the specific samples tested under conditions. It is manufacture's responsibility to ensure that additional production units of this model are manufactured with the identical electrical and mechanical components. **BTL** shall have no liability for any declarations, inferences or generalizations drawn by the client or others from **BTL** issued reports.

The report must not be used by the client to claim product certification, approval, or endorsement by NIST, A2LA, or any agency of the U.S. Government.

This report is the confidential property of the client. As a mutual protection to the clients, the public and ourselves, the test report shall not be reproduced, except in full, without our written approval.

BTL's laboratory quality assurance procedures are in compliance with the **ISO/IEC 17025** requirements, and accredited by the conformity assessment authorities listed in this test report.

BTL is not responsible for the sampling stage, so the results only apply to the sample as received.

The information, data and test plan are provided by manufacturer which may affect the validity of results, so it is manufacturer's responsibility to ensure that the apparatus meets the essential requirements of applied standards and in all the possible configurations as representative of its intended use.

Limitation

For the use of the authority's logo is limited unless the Test Standard(s)/Scope(s)/Item(s) mentioned in this test report is (are) included in the conformity assessment authorities acceptance respective.

Please note that the measurement uncertainty is provided for informational purpose only and are not use in determining the Pass/Fail results.

Table of Contents	Page
REPORT ISSUED HISTORY	4
1 . SUMMARY OF TEST RESULTS	5
1.1 TEST FACILITY	6
1.2 MEASUREMENT UNCERTAINTY	6
1.3 TEST ENVIRONMENT CONDITIONS	7
2 . GENERAL INFORMATION	8
2.1 GENERAL DESCRIPTION OF EUT	8
2.2 DESCRIPTION OF TEST MODES	9
2.3 EUT OPERATING CONDITIONS	10
2.4 BLOCK DIAGRAM SHOWING THE CONFIGURATION OF SYSTEM TESTED	10
2.5 DESCRIPTION OF SUPPORT UNITS	11
3 . EMC EMISSION TEST	12
3.1 AC POWER LINE CONDUCTED EMISSIONS TEST	12
3.1.1 LIMIT	12
3.1.2 MEASUREMENT INSTRUMENTS LIST	12
3.1.3 TEST PROCEDURE	13
3.1.4 DEVIATION FROM TEST STANDARD	13
3.1.5 TEST SETUP	13
3.1.6 TEST RESULTS	13
3.2 RADIATED EMISSIONS 30 MHZ TO 1 GHZ	20
3.2.1 LIMIT	20
3.2.2 MEASUREMENT INSTRUMENTS LIST	20
3.2.3 TEST PROCEDURE	21
3.2.4 DEVIATION FROM TEST STANDARD	21
3.2.5 TEST SETUP	21
3.2.6 TEST RESULTS-BELOW 1 GHZ	21
3.3 RADIATED EMISSIONS ABOVE 1 GHZ	28
3.3.1 LIMIT	28
3.3.2 MEASUREMENT INSTRUMENTS LIST	28
3.3.3 TEST PROCEDURE	29
3.3.4 DEVIATION FROM TEST STANDARD	29
3.3.5 TEST SETUP	29
3.3.6 TEST RESULTS-ABOVE 1 GHZ	30
4 . EUT TEST PHOTO	37

REPORT ISSUED HISTORY

Report Version	Description	Issued Date
R00	Original Issue.	Jul. 03, 2020

1. SUMMARY OF TEST RESULTS

Emission		
Ref Standard(s)	Test Item	Result
FCC CFR Title 47,Part 15,Subpart B ICES-003 Issue 6:January 2016 ICES-003 Issue 6:January 2016 (updated April 2019)	AC Power Line Conducted Emissions	PASS
	Radiated Emissions 30 MHz to 1 GHz	PASS
	Radiated Emissions Above 1 GHz	PASS

1.1 TEST FACILITY

The test facilities used to collect the test data in this report at the location of No.3, Jinshagang 1st Road, Shixia, Dalang Town, Dongguan, Guangdong, China.

BTL's Test Firm Registration Number for FCC: 357015

BTL's Designation Number for FCC: CN1240

BTL's Test Firm Registration Number for ISED: 4428B

1.2 MEASUREMENT UNCERTAINTY

ISO/IEC 17025 requires that an estimate of the measurement uncertainties associated with the emissions test results be included in the report. The measurement uncertainties given below are based on a 95% confidence level (based on a coverage factor (k=2))

The BTL measurement uncertainty as below table:

A. AC power line conducted emissions test:

Test Site	Method	Measurement Frequency Range	U,(dB)
DG-C01	CISPR	150kHz ~ 30MHz	2.90

B. Radiated emissions test:

Test Site	Method	Measurement Frequency Range	Ant. H / V	U,(dB)
DG-CB08 (10m)	CISPR	30MHz ~ 200MHz	V	4.44
		30MHz ~ 200MHz	H	3.44
		200MHz ~ 1,000MHz	V	4.28
		200MHz ~ 1,000MHz	H	3.52

Test Site	Method	Measurement Frequency Range	U,(dB)
DG-CB08 (3m)	CISPR	1GHz ~ 6GHz	4.36

Note: Unless specifically mentioned, the uncertainty of measurement has not been taken into account to declare the compliance or non-compliance to the specification.

1.3 TEST ENVIRONMENT CONDITIONS

Test Item	Temperature	Humidity	Tested By
AC Power Line Conducted Emissions	25°C	53%	Bang Liang
Radiated emissions 30 MHz to 1 GHz	25°C	60%	Albe Zhou
Radiated emissions above 1 GHz	25°C	60%	Dylan Hong

2. GENERAL INFORMATION

2.1 GENERAL DESCRIPTION OF EUT

Equipment	LCD Monitor
Brand Name	N/A
Test Model	**PD27***** (*=0-9,A-Z,a-z,+,-,/,\ or blank)
Series Model	N/A
Model Difference(s)	N/A
Power Source	DC Voltage supplied from AC adapter. Model: ADPC20120
Power Rating	I/P:100-240V~, 1.5A 50-60Hz O/P:20V --- 6.0A
Connecting I/O Port(s)	1* DC port 2* HDMI port 5* USB port 2* DP port 2* Audio port
Classification Of EUT	Class B
Highest Internal Frequency(Fx)	600MHz

Cable Type	Shielded Type	Ferrite Core	Length(m)	Note
AC Power Cord	Non-shielded	NO	1.8/1.5	1.8m is worst case Detachable
DP	Shielded	NO	1.8/1.5	-
HDMI	Shielded	NO	1.8/1.5	-
USB	Shielded	NO	1.8/1.5	-
Audio	Non-shielded	NO	1.8/1.5	-

Note:

1. For a more detailed features description, please refer to the manufacturer's specifications or the user's manual.
2. Power cable 1.8m, 1.5m length, worst case is Power cable 1.8m with DP+HDMI+USB+Audio length testing and recording in test report.

2.2 DESCRIPTION OF TEST MODES

To investigate the maximum EMI emission characteristics generated from EUT, the test system was pre-scanning tested based on the consideration of following EUT operation mode or test configuration mode which possibly have effect on EMI emission level. Each of these EUT operation mode(s) or test configuration mode(s) mentioned above was evaluated respectively.

Pretest Mode	Description
Mode 1	HDMI1 2560*1440/144Hz 1.8m
Mode 2	HDMI2 2560*1440/144Hz 1.8m
Mode 3	DP1 2560*1440/240Hz 1.8m
Mode 4	DP2 2560*1440/240Hz 1.8m
Mode 5	HDMI1 1080P 1.8m
Mode 6	HDMI2 1080P 1.8m
Mode 7	HDMI 1280*720/60Hz 1.8m
Mode 8	HDMI 640*480/60Hz 1.8m
Mode 9	HDMI1 2560*1440/144Hz 1.5m

AC Power Line Conducted Emissions test	
Final Test Mode	Description
Mode 1	HDMI1 2560*1440/144Hz 1.8m
Mode 3	DP1 2560*1440/240Hz 1.8m
Mode 5	HDMI1 1080P 1.8m

Radiated emissions 30 MHz to 1 GHz test	
Final Test Mode	Description
Mode 1	HDMI1 2560*1440/144Hz 1.8m
Mode 3	DP1 2560*1440/240Hz 1.8m
Mode 5	HDMI1 1080P 1.8m

Radiated emissions Above 1 GHz test	
Final Test Mode	Description
Mode 1	HDMI1 2560*1440/144Hz 1.8m
Mode 3	DP1 2560*1440/240Hz 1.8m
Mode 5	HDMI1 1080P 1.8m

Evaluation description:

1. The maximum resolution is evaluated Mode 1-6. The worst case is Mode 1 and evaluated the middle and low resolution Mode 6 and Mode 7.
2. According to the client's requirement, choose Mode 1, Mode 3, Mode 5 and recorded in test report.

2.3 EUT OPERATING CONDITIONS

The EUT exercise program used during radiated and/or conducted emission measurement was designed to exercise the various system components in a manner similar to a typical use. The standard test signals and output signal as following:

1. EUT connected to Adapter via DC cable.
2. EUT connected to PC via DP&HDMI&USB&Audio cable.
3. EUT connected to Headset via Audio cable.
4. EUT connected to HDD via USB cable.
5. Mouse and Keyboard connected to PC via USB cable.
6. Printer connected to PC via Parallel cable.
7. Modem connected to PC via RS232 cable.

2.4 BLOCK DIAGRAM SHOWING THE CONFIGURATION OF SYSTEM TESTED

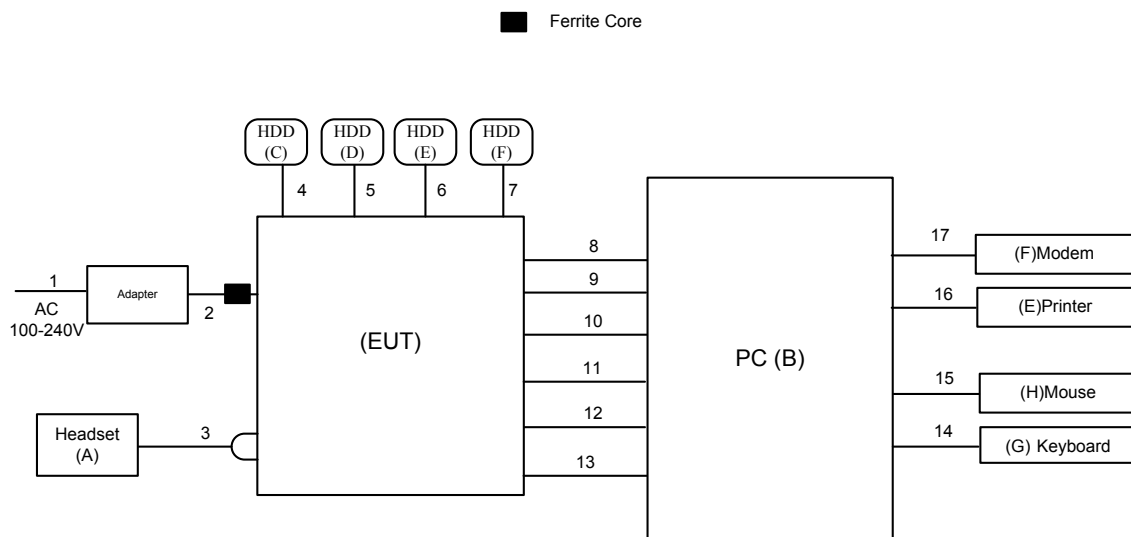

2.5 DESCRIPTION OF SUPPORT UNITS

The EUT has been tested as an independent unit together with other necessary accessories or support units. The following support units or accessories were used to form a representative test configuration during the tests.

Item	Equipment	Mfr/Brand	Model/Type No.	Series No.
A	Headset	PHILIPS	SHM1500	N/A
B	PC	DELL	Vostro 470	24454162837
C	HDD	LACIE	Lacie S.A	NL34BFER
D	HDD	LACIE	Lacie S.A	NL34BJSJSM
E	HDD	LACIE	Lacie S.A	NL33PVLS
F	HDD	LACIE	Lacie S.A	NL34BJRF
G	Keyboard	DELL	KB212-B	CN0HTXH97158125004DXA01
H	Mouse	DELL	MS111-P	CN011D3V71581279OLOT
I	Printer	SII	DPU-414	3018507 B
J	Modem	ACEEX	DM-1414V	603002131

Item	Cable Type	Shielded Type	Ferrite Core	Length
1	AC Cable	NO	NO	1.8/1.5m
2	DC Cable	NO	YES	1m
3	Audio Cable	NO	NO	1.8m
4	USB Cable	YES	NO	1m
5	USB Cable	YES	NO	1m
6	USB Cable	YES	NO	1m
7	USB Cable	YES	NO	1m
8	HDMI Cable	YES	NO	1.8/1.5m
9	HDMI Cable	YES	NO	1.8/1.5m
10	DP Cable	YES	NO	1.8/1.5m
11	DP Cable	YES	NO	1.8/1.5m
12	Audio Cable	NO	NO	1.8/1.5m
13	USB Cable	YES	NO	1.8/1.5m
14	USB Cable	YES	NO	1.8m
15	USB Cable	YES	NO	1.8m
16	Parallel Cable	YES	NO	1.8m
17	RS232 Cable	YES	NO	1.8m

3. EMC EMISSION TEST

3.1 AC POWER LINE CONDUCTED EMISSIONS TEST

3.1.1 LIMIT

Frequency of Emission (MHz)	Class B (dBuV)	
	Quasi-peak	Average
0.15 - 0.5	66 - 56 *	56 - 46 *
0.5 - 5.0	56.00	46.00
5.0 - 30.0	60.00	50.00

Note:

- (1) The tighter limit applies at the band edges.
- (2) The limit of " * " marked band means the limitation decreases linearly with the logarithm of the frequency in the range.
- (3) The test result calculated as following:
 Measurement Value = Reading Level + Correct Factor
 Correct Factor = Insertion Loss + Cable Loss + Attenuator Factor(if use)
 Margin Level = Measurement Value - Limit Value

3.1.2 MEASUREMENT INSTRUMENTS LIST

Item	Kind of Equipment	Manufacturer	Type No.	Serial No.	Calibrated until
1	50Ω Terminator	SHX	TF2-3G-A	8122901	Feb. 28, 2021
2	TWO-LINE V-NETWORK	R&S	ENV216	100526	Mar. 01, 2021
3	EMI Test Receiver	R&S	ESR3	101862	Aug. 03, 2020
4	Artificial-Mains Network	SCHWARZBECK	NSLK 8127	8127685	Mar. 01, 2021
5	TRANSIENT LIMITER	EM	EM-7600	772	Mar. 01, 2021
6	Cable	N/A	RG400	N/A(12m)	Mar. 10, 2021
7	Measurement Software	Farad	EZ-EMC Ver.NB-03A1-01	N/A	N/A

Remark: "N/A" denotes no model name, serial no. or calibration specified.

All calibration period of equipment list is one year.

3.1.3 TEST PROCEDURE

- a. The EUT was placed 0.8 meters from the horizontal ground plane with EUT being connected to the power mains through a line impedance stabilization network (LISN). All other support equipment powered from additional LISN(s). The LISN provide 50 Ohm/ 50uH of coupling impedance for the measuring instrument.
- b. Interconnecting cables that hang closer than 40 cm to the ground plane shall be folded back and forth in the center forming a bundle 30 to 40 cm long.
- c. I/O cables that are not connected to a peripheral shall be bundled in the center. The end of the cable may be terminated, if required, using the correct terminating impedance. The overall length shall not exceed 1 m.
- d. LISN at least 80 cm from nearest part of EUT chassis.
- e. For the actual test configuration, please refer to the related Item –EUT Test Photos.
- f. Measuring frequency range from 150KHz to 30MHz.

3.1.4 DEVIATION FROM TEST STANDARD

No deviation

3.1.5 TEST SETUP

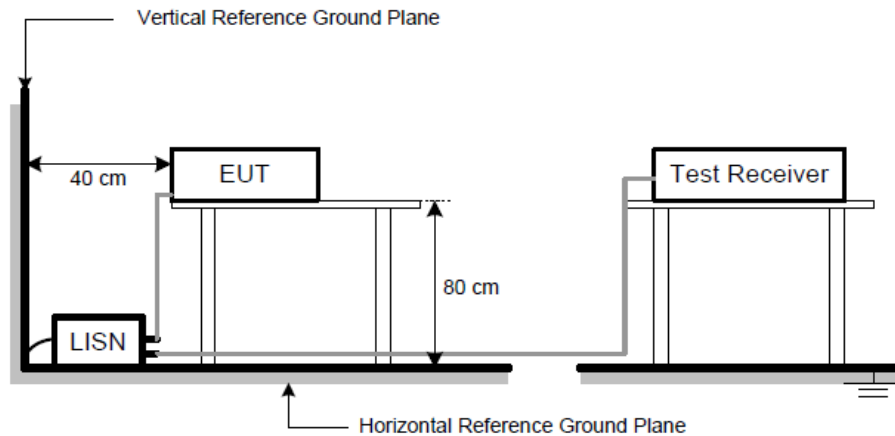

3.1.6 TEST RESULTS

Remark

- (1) Reading in which marked as QP means measurements by using are Quasi-Peak Mode with Detector BW=9 kHz; SPA setting in RBW=10 kHz, VBW =10 kHz, Swp. Time = 0.3 sec./MHz. Reading in which marked as AV means measurements by using are Average Mode with instrument setting in RBW=10 kHz, VBW=10 kHz, Swp. Time =0.3 sec./MHz.
- (2) All readings are QP Mode value unless otherwise stated AVG in column of 『Note』 . If the QP Mode Measured value compliance with the QP Limits and lower than AVG Limits, the EUT shall be deemed to meet both QP & AVG Limits and then only QP Mode was measured, but AVG Mode didn't perform. In this case, a “ * ” marked in AVG Mode column of Interference Voltage Measured.

Test Voltage	AC 120V/60Hz	Phase	Line
Test Mode	HDMI1 2560*1440/144Hz 1.8m		

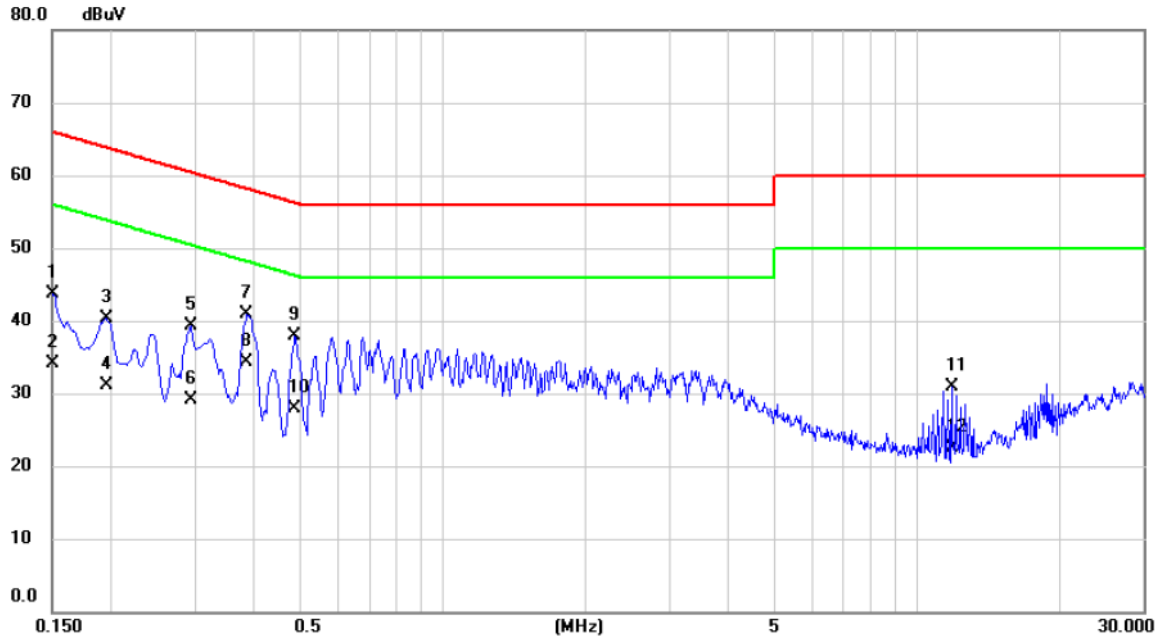

No.	Mk.	Freq. MHz	Reading Level dBuV	Correct Factor dB	Measure- ment dBuV	Limit dBuV	Margin dB	Detector	Comment
1		0.1500	34.01	9.60	43.61	66.00	-22.39	QP	
2		0.1500	24.50	9.60	34.10	56.00	-21.90	AVG	
3		0.1950	30.77	9.59	40.36	63.82	-23.46	QP	
4		0.1950	21.60	9.59	31.19	53.82	-22.63	AVG	
5		0.2940	29.76	9.59	39.35	60.41	-21.06	QP	
6		0.2940	19.50	9.59	29.09	50.41	-21.32	AVG	
7		0.3862	31.32	9.61	40.93	58.15	-17.22	QP	
8	*	0.3862	24.65	9.61	34.26	48.15	-13.89	AVG	
9		0.4875	28.20	9.61	37.81	56.21	-18.40	QP	
10		0.4875	18.30	9.61	27.91	46.21	-18.30	AVG	
11		11.8455	20.54	10.31	30.85	60.00	-29.15	QP	
12		11.8455	12.20	10.31	22.51	50.00	-27.49	AVG	

Test Voltage	AC 120V/60Hz	Phase	Neutral
Test Mode	HDMI1 2560*1440/144Hz 1.8m		

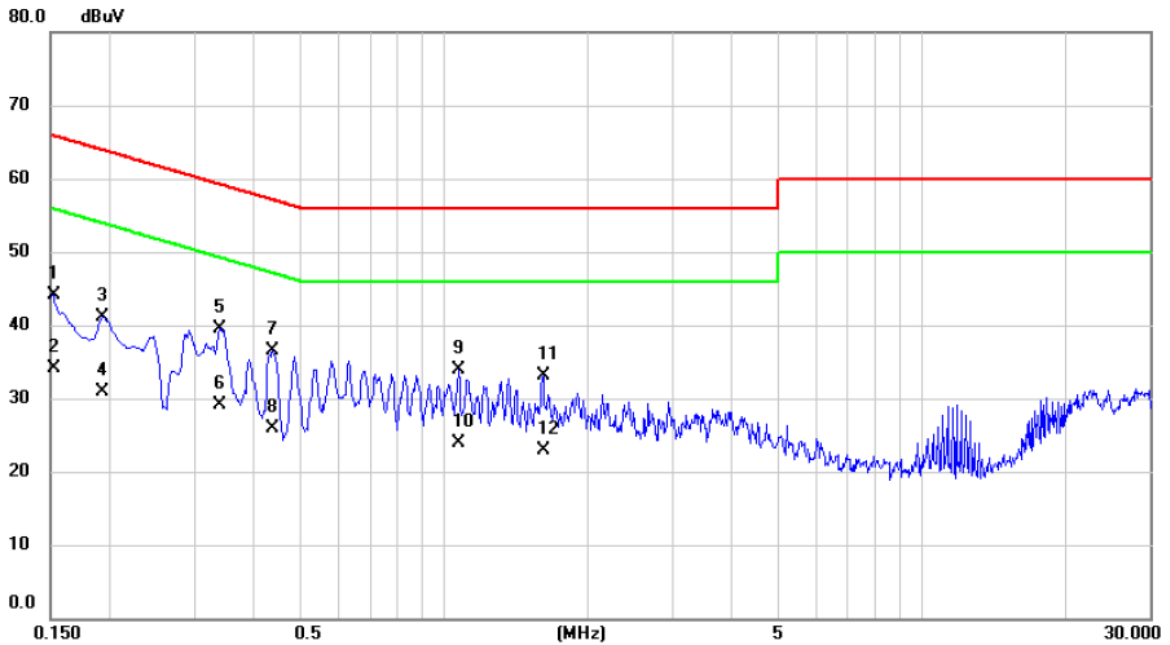

No.	Mk.	Freq. MHz	Reading Level dBuV	Correct Factor dB	Measure- ment dBuV	Limit dBuV	Margin dB	Detector	Comment
1		0.1522	34.45	9.57	44.02	65.88	-21.86	QP	
2		0.1522	24.50	9.57	34.07	55.88	-21.81	AVG	
3		0.1928	31.57	9.57	41.14	63.92	-22.78	QP	
4		0.1928	21.30	9.57	30.87	53.92	-23.05	AVG	
5	*	0.3390	29.98	9.58	39.56	59.23	-19.67	QP	
6		0.3390	19.60	9.58	29.18	49.23	-20.05	AVG	
7		0.4380	26.92	9.60	36.52	57.10	-20.58	QP	
8		0.4380	16.30	9.60	25.90	47.10	-21.20	AVG	
9		1.0725	24.15	9.67	33.82	56.00	-22.18	QP	
10		1.0725	14.20	9.67	23.87	46.00	-22.13	AVG	
11		1.6125	23.47	9.70	33.17	56.00	-22.83	QP	
12		1.6125	13.30	9.70	23.00	46.00	-23.00	AVG	

Test Voltage	AC 120V/60Hz	Phase	Line
Test Mode	DP1 2560*1440/240Hz 1.8m		

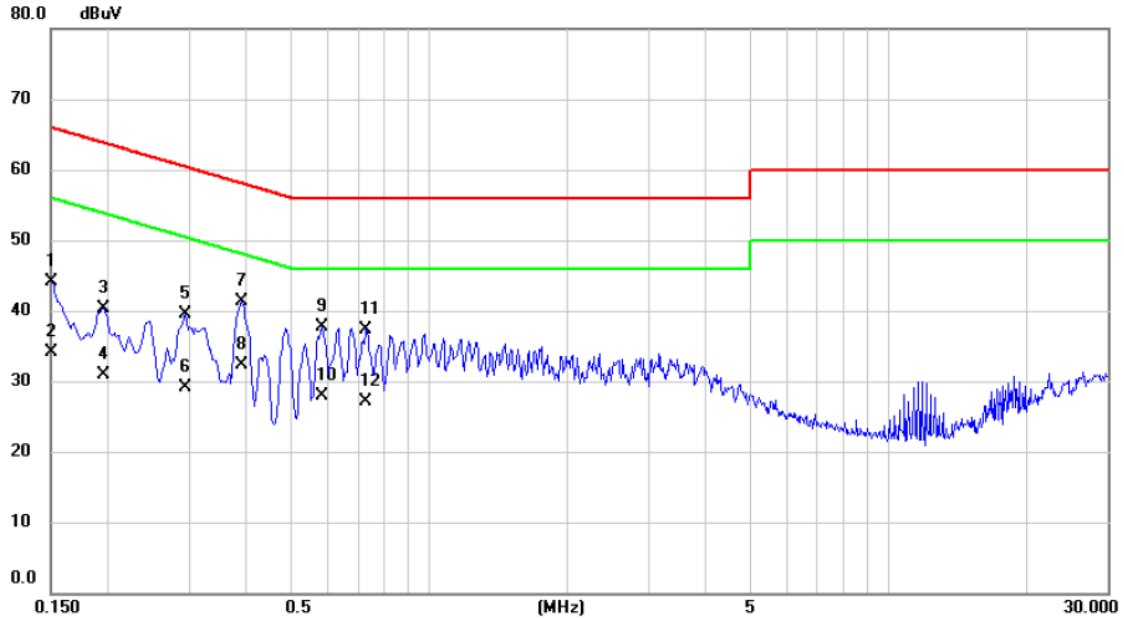

No.	Mk.	Freq. MHz	Reading Level dBuV	Correct Factor dB	Measure- ment dBuV	Limit dBuV	Margin dB	Detector	Comment
1		0.1500	34.58	9.60	44.18	66.00	-21.82	QP	
2		0.1500	24.50	9.60	34.10	56.00	-21.90	AVG	
3		0.1950	30.78	9.59	40.37	63.82	-23.45	QP	
4		0.1950	21.30	9.59	30.89	53.82	-22.93	AVG	
5		0.2940	29.85	9.59	39.44	60.41	-20.97	QP	
6		0.2940	19.60	9.59	29.19	50.41	-21.22	AVG	
7		0.3907	31.60	9.61	41.21	58.05	-16.84	QP	
8	*	0.3907	22.60	9.61	32.21	48.05	-15.84	AVG	
9		0.5842	28.10	9.62	37.72	56.00	-18.28	QP	
10		0.5842	18.20	9.62	27.82	46.00	-18.18	AVG	
11		0.7282	27.69	9.63	37.32	56.00	-18.68	QP	
12		0.7282	17.40	9.63	27.03	46.00	-18.97	AVG	

Test Voltage	AC 120V/60Hz	Phase	Neutral
Test Mode	DP1 2560*1440/240Hz 1.8m		

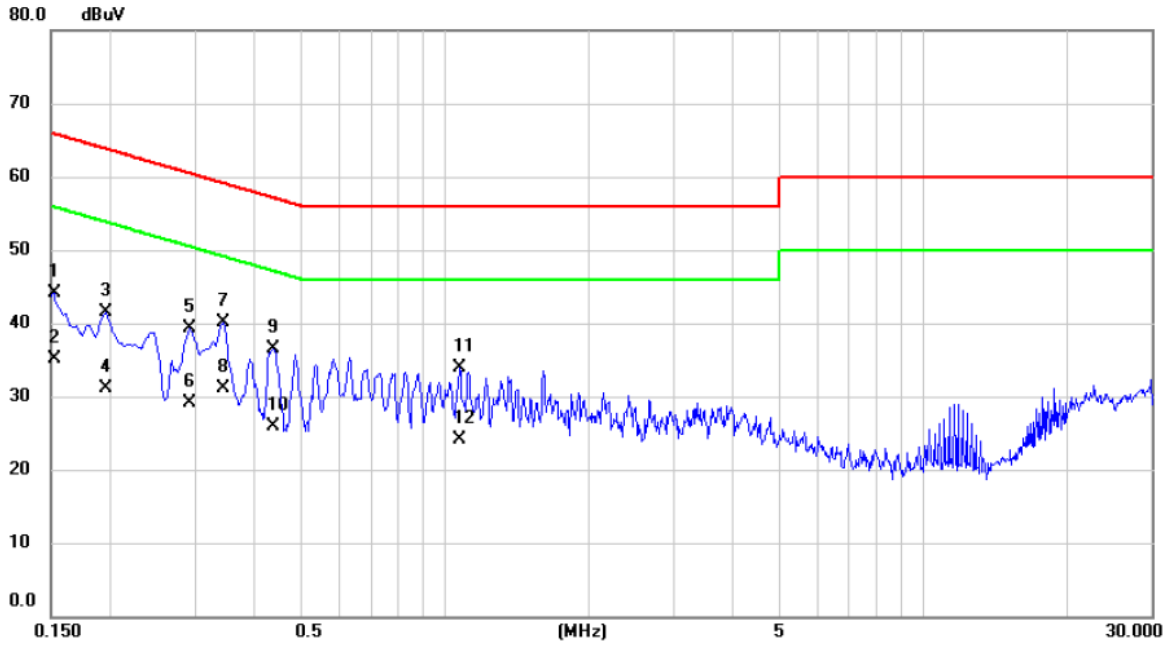

No.	Mk.	Freq. MHz	Reading Level dBuV	Correct Factor dB	Measure- ment dBuV	Limit dBuV	Margin dB	Detector	Comment
1		0.1522	34.52	9.57	44.09	65.88	-21.79	QP	
2		0.1522	25.60	9.57	35.17	55.88	-20.71	AVG	
3		0.1950	31.85	9.57	41.42	63.82	-22.40	QP	
4		0.1950	21.50	9.57	31.07	53.82	-22.75	AVG	
5		0.2917	29.72	9.57	39.29	60.48	-21.19	QP	
6		0.2917	19.60	9.57	29.17	50.48	-21.31	AVG	
7		0.3435	30.43	9.58	40.01	59.12	-19.11	QP	
8	*	0.3435	21.60	9.58	31.18	49.12	-17.94	AVG	
9		0.4380	26.92	9.60	36.52	57.10	-20.58	QP	
10		0.4380	16.30	9.60	25.90	47.10	-21.20	AVG	
11		1.0725	24.26	9.67	33.93	56.00	-22.07	QP	
12		1.0725	14.50	9.67	24.17	46.00	-21.83	AVG	

Test Voltage	AC 120V/60Hz	Phase	Line
Test Mode	HDMI1 1080P 1.8m		

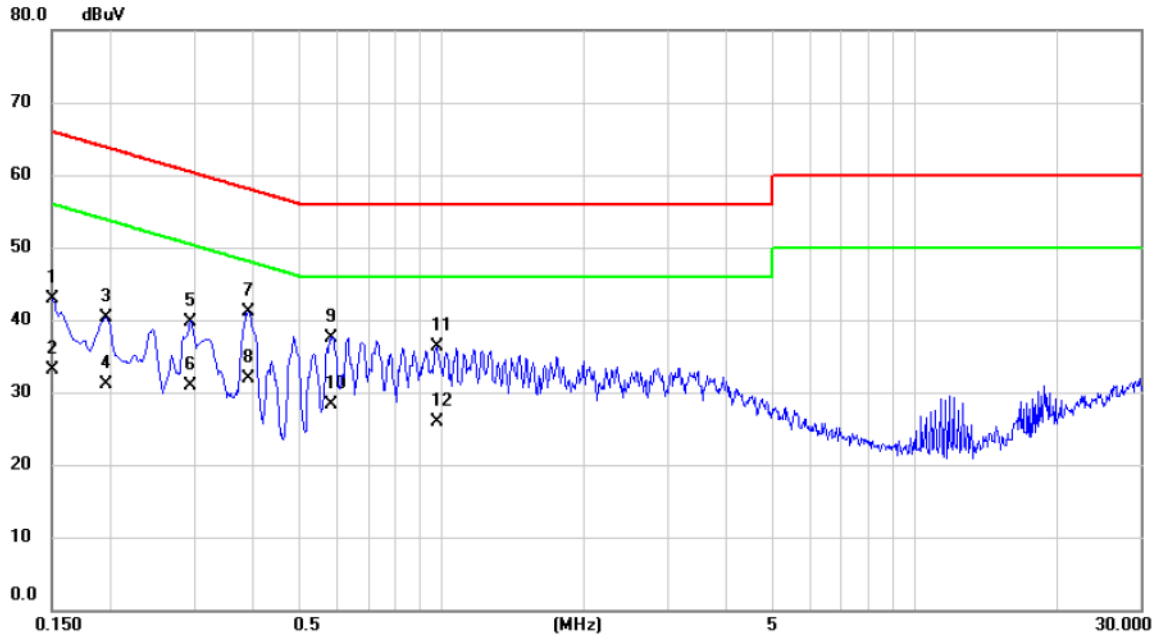

No.	Mk.	Freq. MHz	Reading Level dBuV	Correct Factor dB	Measure- ment dBuV	Limit dBuV	Margin dB	Detector	Comment
1		0.1500	33.27	9.60	42.87	66.00	-23.13	QP	
2		0.1500	23.60	9.60	33.20	56.00	-22.80	AVG	
3		0.1950	30.65	9.59	40.24	63.82	-23.58	QP	
4		0.1950	21.50	9.59	31.09	53.82	-22.73	AVG	
5		0.2940	30.21	9.59	39.80	60.41	-20.61	QP	
6		0.2940	21.40	9.59	30.99	50.41	-19.42	AVG	
7		0.3907	31.48	9.61	41.09	58.05	-16.96	QP	
8	*	0.3907	22.30	9.61	31.91	48.05	-16.14	AVG	
9		0.5842	27.98	9.62	37.60	56.00	-18.40	QP	
10		0.5842	18.60	9.62	28.22	46.00	-17.78	AVG	
11		0.9757	26.73	9.67	36.40	56.00	-19.60	QP	
12		0.9757	16.30	9.67	25.97	46.00	-20.03	AVG	

Test Voltage	AC 120V/60Hz	Phase	Neutral
Test Mode	HDMI1 1080P 1.8m		

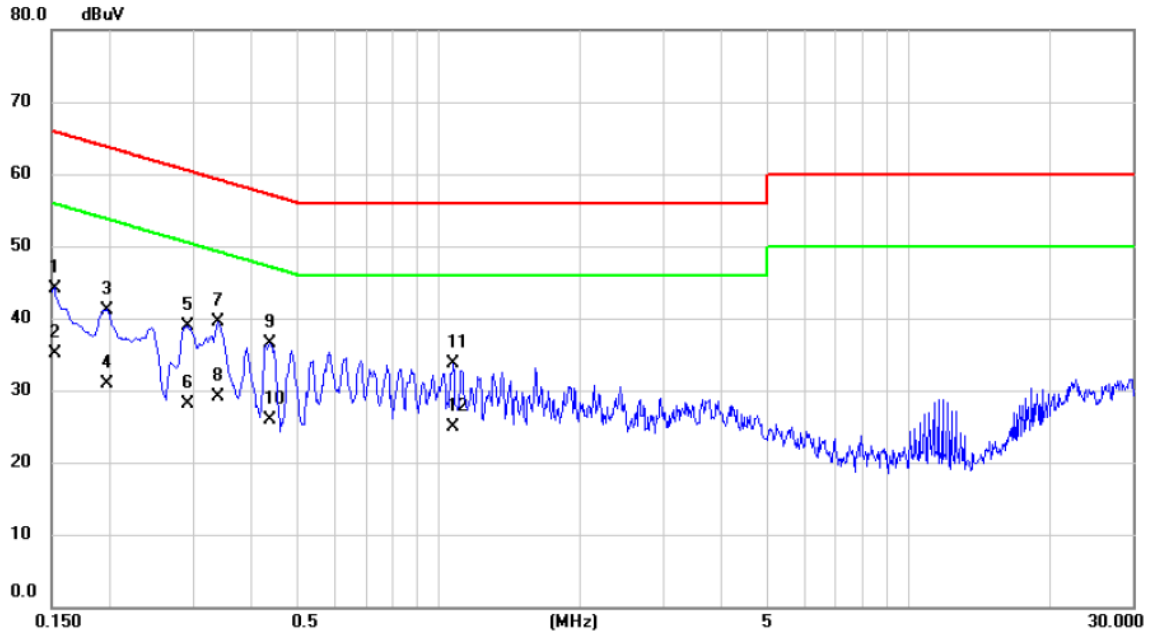

No.	Mk.	Freq. MHz	Reading Level dBuV	Correct Factor dB	Measure- ment dBuV	Limit dBuV	Margin dB	Detector	Comment
1		0.1522	34.63	9.57	44.20	65.88	-21.68	QP	
2		0.1522	25.60	9.57	35.17	55.88	-20.71	AVG	
3		0.1973	31.63	9.57	41.20	63.72	-22.52	QP	
4		0.1973	21.30	9.57	30.87	53.72	-22.85	AVG	
5		0.2917	29.43	9.57	39.00	60.48	-21.48	QP	
6		0.2917	18.50	9.57	28.07	50.48	-22.41	AVG	
7	*	0.3390	29.86	9.58	39.44	59.23	-19.79	QP	
8		0.3390	19.50	9.58	29.08	49.23	-20.15	AVG	
9		0.4380	26.86	9.60	36.46	57.10	-20.64	QP	
10		0.4380	16.30	9.60	25.90	47.10	-21.20	AVG	
11		1.0747	24.13	9.67	33.80	56.00	-22.20	QP	
12		1.0747	15.30	9.67	24.97	46.00	-21.03	AVG	

3.2 RADIATED EMISSIONS 30 MHZ TO 1 GHZ

3.2.1 LIMIT

30 MHz to 1 GHz

Frequency (MHz)	Class B (at 10m)
	dBuV/m
30 - 230	30
230 - 1000	37

NOTE:

- (1) The tighter limit applies at the band edges.
- (2) Emission level (dBuV/m) = 20log Emission level (uV/m).
3m Emission level = 10m Emission level + 20log(10m/3m).
- (3) The test result calculated as following:
Measurement Value = Reading Level + Correct Factor
Correct Factor = Antenna Factor + Cable Loss - Amplifier Gain(if use)
Margin Level = Measurement Value - Limit Value

3.2.2 MEASUREMENT INSTRUMENTS LIST

Item	Kind of Equipment	Manufacturer	Type No.	Serial No.	Calibrated until
1	Receiver	Keysight	N9038A	MY54450004	Aug. 03, 2020
2	Pre-Amplifier	EMC INSTRUMENT	EMC 9135	980284	Mar. 01, 2021
3	Trilog-Broadband Antenna	Schwarzbeck	VULB9168	946	Oct. 26, 2020
4	Cable	emci	LMR-400(5m+11m+15m)	N/A	Nov. 22, 2020
5	Measurement Software	Farad	EZ-EMC Ver.BTL-2ANT-1	N/A	N/A
6	Multi-Device Controller	ETS-Lindgren	2090	N/A	N/A
7	Attenuator	EMCI	EMCI-N-6-06	N0670	Dec. 02, 2020

Remark: "N/A" denotes no model name, no serial no. or no calibration specified.

All calibration period of equipment list is one year.

3.2.3 TEST PROCEDURE

- The measuring distance of 10 m shall be used for measurements. The EUT was placed on the top of a rotating table 0.8 meter above the ground at a 10 meter semi-anechoic chamber. The table was rotated 360 degrees to determine the position of the highest radiation.
- The height of the equipment or of the substitution antenna shall be 0.8 m, the height of the test antenna shall vary between 1 m to 4 m. Both horizontal and vertical polarizations of the antenna are set to make the measurement.
- For each suspected emission, the EUT was arranged to its worst case and then the antenna was tuned to heights find the maximum reading (used Bore sight function).
- The initial step in collecting radiated emission data is a receiver peak detector mode pre-scanning the measurement frequency range. Significant peaks are then marked and then Quasi Peak detector mode re-measured.
- All readings are Peak unless otherwise stated QP in column of Note. Peak denotes that the Peak reading compliance with the QP Limits and then QP Mode measurement didn't perform.
- For the actual test configuration, please refer to the related Item - Block Diagram of system tested.

3.2.4 DEVIATION FROM TEST STANDARD

No deviation

3.2.5 TEST SETUP

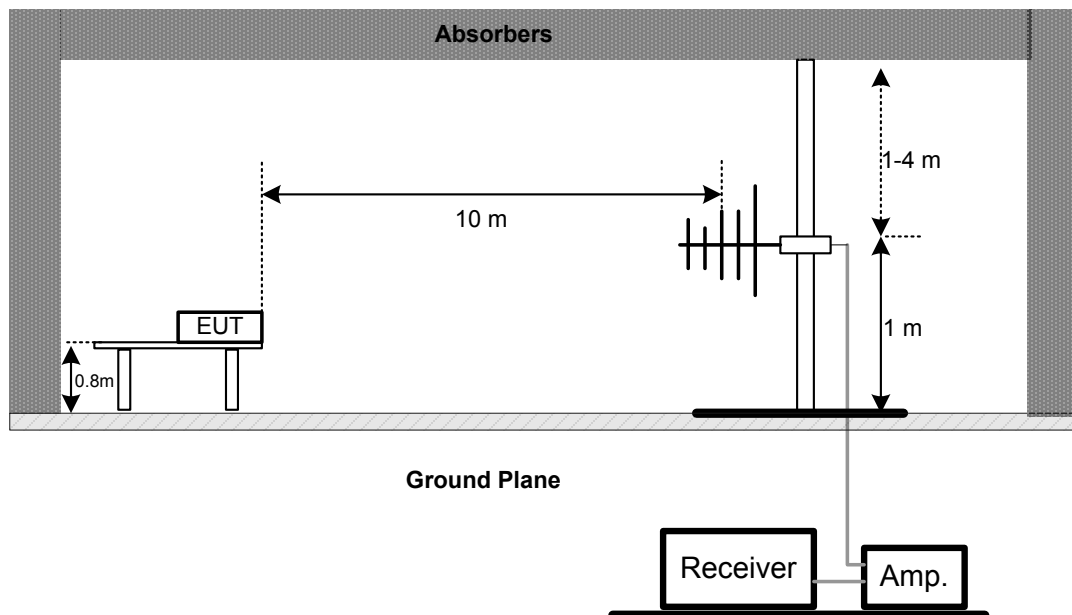

3.2.6 TEST RESULTS-BELOW 1 GHZ

Remark :

- Measuring frequency range from 30 MHz to 1000 MHz
- If the peak scan value lower limit more than 20 dB, then this signal data does not show in table.

Test Voltage	AC 120V/60Hz	Polarization	Vertical
Test Mode	HDMI1 2560*1440/144Hz 1.8m		

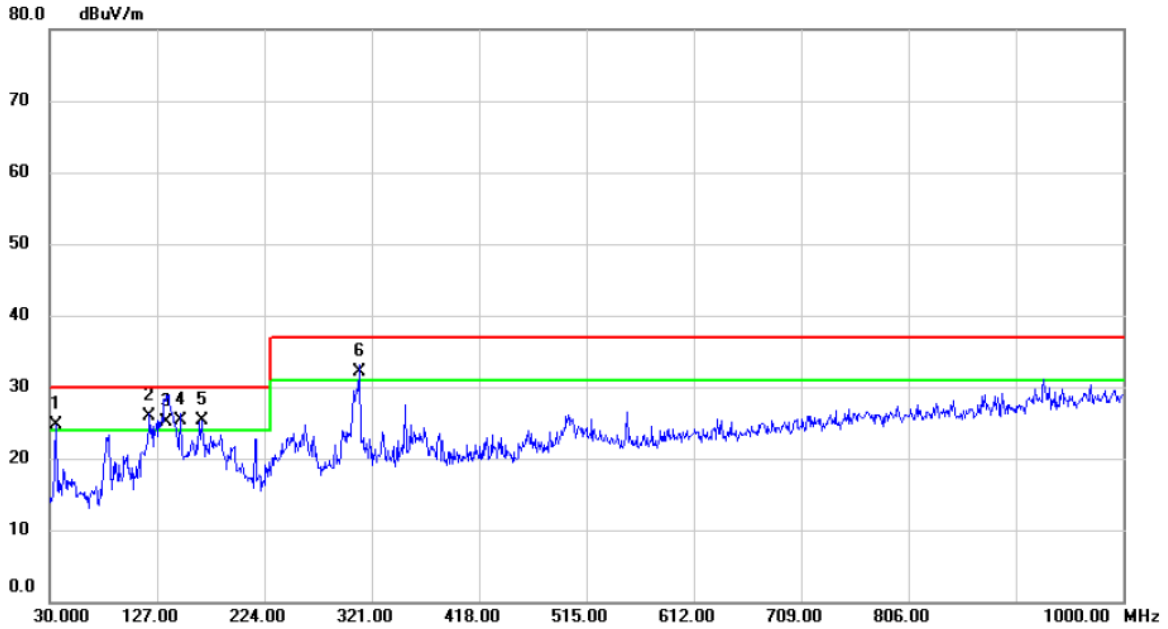

No.	Mk.	Freq. MHz	Reading Level dBuV	Correct Factor dB	Measure- ment dBuV/m	Limit dBuV/m	Margin dB	Detector	Comment
1	!	35.8200	43.06	-18.38	24.68	30.00	-5.32	QP	
2	*	120.2100	44.72	-18.73	25.99	30.00	-4.01	QP	
3	!	135.7300	42.16	-16.97	25.19	30.00	-4.81	QP	
4	!	148.3400	41.28	-15.96	25.32	30.00	-4.68	QP	
5	!	167.7400	41.28	-15.99	25.29	30.00	-4.71	QP	
6	!	310.3300	46.16	-14.15	32.01	37.00	-4.99	QP	

Test Voltage	AC 120V/60Hz	Polarization	Horizontal
Test Mode	HDMI1 2560*1440/144Hz 1.8m		

80 dBuV/m

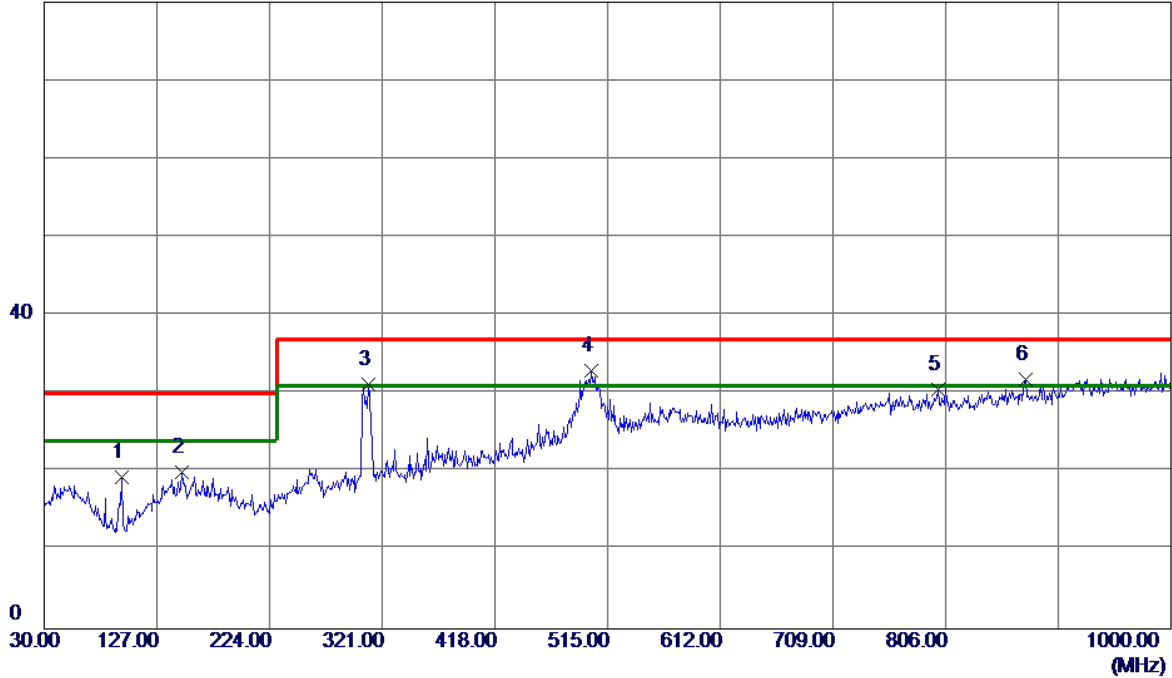

No.	Freq. MHz	Reading Level dBuV/m	Correct Factor dB	Measure ment dBuV/m	Limit dBuV/m	Margin dB	Detector
1	96.9300	40.56	-21.15	19.41	30.00	-10.59	QP
2	148.3400	35.55	-15.59	19.96	30.00	-10.04	QP
3	309.3599	45.15	-14.01	31.14	37.00	-5.86	QP
4 *	501.4200	42.47	-9.48	32.99	37.00	-4.01	QP
5	799.2100	34.84	-4.22	30.62	37.00	-6.38	QP
6	874.8700	35.15	-3.35	31.80	37.00	-5.20	QP

Test Voltage	AC 120V/60Hz	Polarization	Vertical
Test Mode	DP1 2560*1440/240Hz 1.8m		

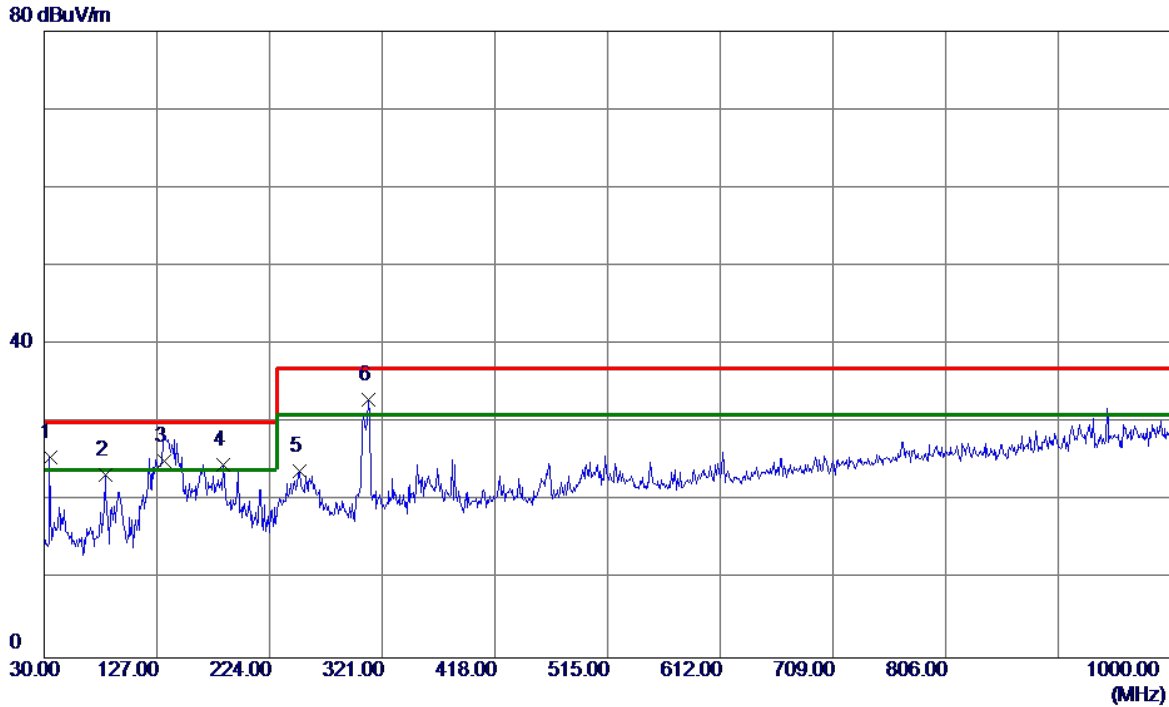

No.	Freq. MHz	Reading Level dBuV/m	Correct Factor dB	Measure ment dBuV/m	Limit dBuV/m	Margin dB	Detector
1	34.8500	44.07	-18.54	25.53	30.00	-4.47	QP
2	82.3800	43.53	-20.19	23.34	30.00	-6.66	QP
3	133.7899	42.28	-17.17	25.11	30.00	-4.89	QP
4	184.2300	42.05	-17.39	24.66	30.00	-5.34	QP
5	250.1900	40.15	-16.38	23.77	37.00	-13.23	QP
6 *	309.3599	47.11	-14.19	32.92	37.00	-4.08	QP

Test Voltage	AC 120V/60Hz	Polarization	Horizontal
Test Mode	DP1 2560*1440/240Hz 1.8m		

80 dBuV/m

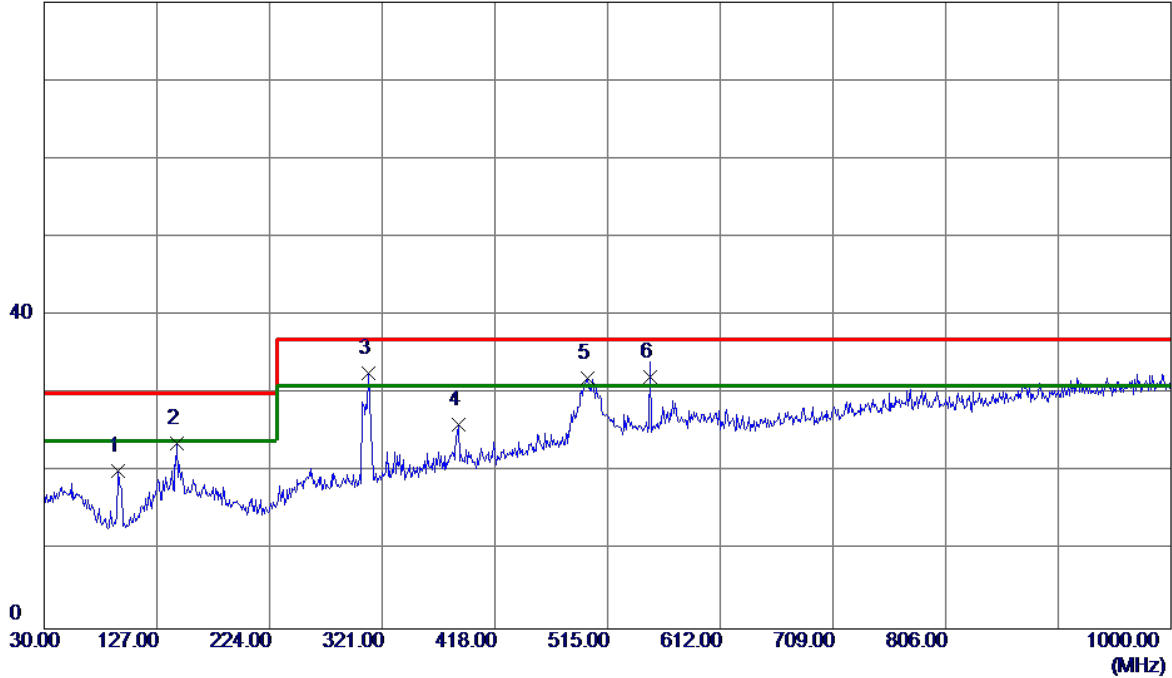

No.	Freq. MHz	Reading Level dBuV/m	Correct Factor dB	Measure ment dBuV/m	Limit dBuV/m	Margin dB	Detector
1	94.0199	41.71	-21.60	20.11	30.00	-9.89	QP
2	144.4600	39.42	-15.81	23.61	30.00	-6.39	QP
3 *	309.3599	46.60	-14.01	32.59	37.00	-4.41	QP
4	386.9600	38.21	-12.16	26.05	37.00	-10.95	QP
5	497.5400	41.55	-9.55	32.00	37.00	-5.00	QP
6	551.8600	40.66	-8.51	32.15	37.00	-4.85	QP

Test Voltage	AC 120V/60Hz	Polarization	Vertical
Test Mode	HDMI1 1080P 1.8m		

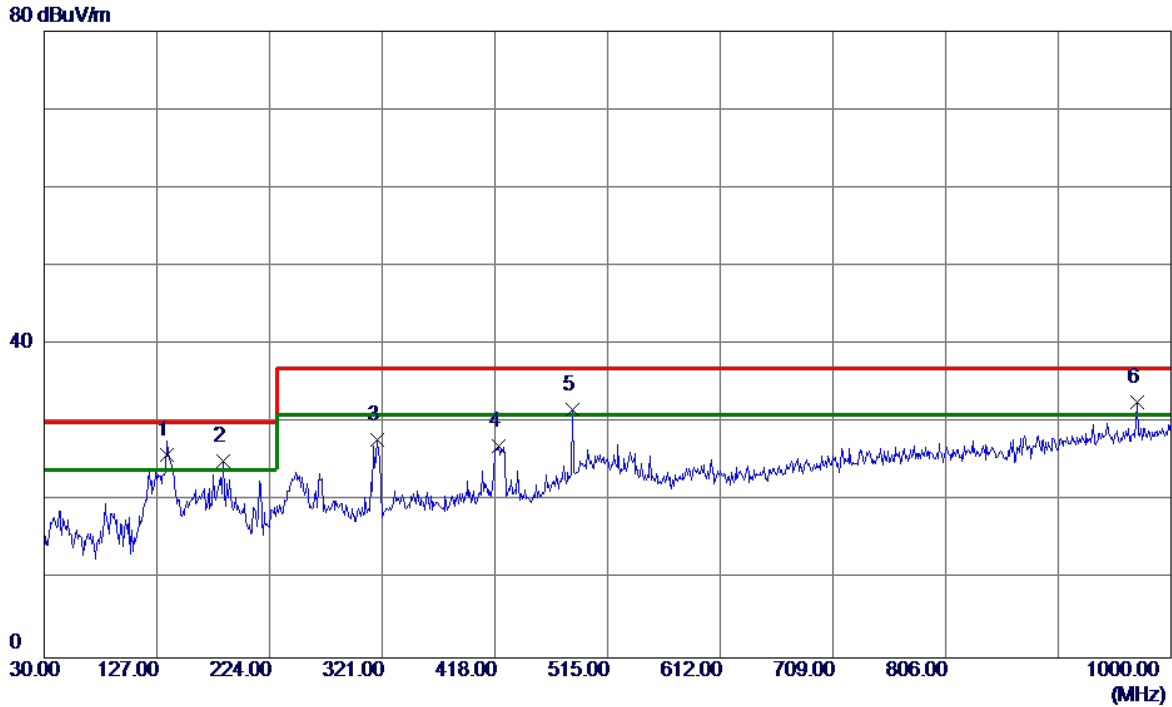

No.	Freq. MHz	Reading Level dBuV/m	Correct Factor dB	Measure ment dBuV/m	Limit dBuV/m	Margin dB	Detector
1 *	135.7300	42.95	-16.97	25.98	30.00	-4.02	QP
2	184.2300	42.56	-17.39	25.17	30.00	-4.83	QP
3	317.1200	41.76	-13.92	27.84	37.00	-9.16	QP
4	420.9100	38.52	-11.48	27.04	37.00	-9.96	QP
5	484.9300	41.63	-9.91	31.72	37.00	-5.28	QP
6	970.9000	34.78	-2.07	32.71	37.00	-4.29	QP

Test Voltage	AC 120V/60Hz	Polarization	Horizontal
Test Mode	HDMI1 1080P 1.8m		

80 dBuV/m

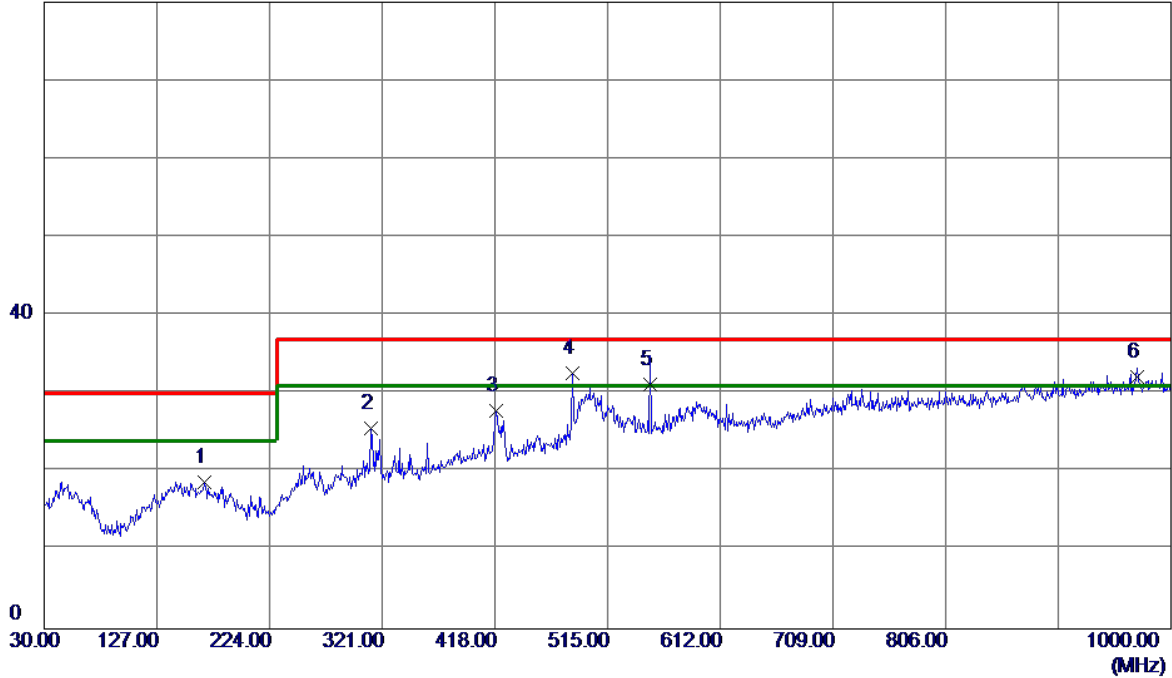

No.	Freq. MHz	Reading Level dBuV/m	Correct Factor dB	Measure ment dBuV/m	Limit dBuV/m	Margin dB	Detector
1	167.7400	34.61	-15.84	18.77	30.00	-11.23	QP
2	311.3000	39.51	-13.94	25.57	37.00	-11.43	QP
3	418.9700	39.16	-11.34	27.82	37.00	-9.18	QP
4 *	484.9300	42.41	-9.78	32.63	37.00	-4.37	QP
5	551.8600	39.77	-8.51	31.26	37.00	-5.74	QP
6	970.9000	33.89	-1.67	32.22	37.00	-4.78	QP

3.3 RADIATED EMISSIONS ABOVE 1 GHZ

3.3.1 LIMIT

Above 1 GHz

Frequency (MHz)	Class B	
	(dBuV/m) (at 3m)	
	Peak	Average
Above 1000	74	54

FREQUENCY RANGE OF RADIATED MEASUREMENT (FOR UNINTENTIONAL RADIATORS)

Highest frequency generated or Upper frequency of measurement used in the device or on which the device operates or tunes (MHz)	Range (MHz)
Below 1.705	30
1.705 - 108	1000
108 - 500	2000
500 - 1000	5000
Above 1000	5 th harmonic of the highest frequency or 40 GHz, whichever is lower

NOTE:

- (1) The tighter limit applies at the band edges.
- (2) Emission level (dBuV/m) = 20log Emission level (uV/m).
3m Emission level = 10m Emission level + 20log(10m/3m).
- (3) The test result calculated as following:
Measurement Value = Reading Level + Correct Factor
Correct Factor = Antenna Factor + Cable Loss - Amplifier Gain(if use)
Margin Level = Measurement Value - Limit Value

3.3.2 MEASUREMENT INSTRUMENTS LIST

Item	Kind of Equipment	Manufacturer	Type No.	Serial No.	Calibrated until
1	Horn Antenna	EMCO	3115	9605-4803	May. 12, 2021
2	Amplifier	Agilent	8449B	3008A02333	Mar. 01, 2021
3	MXE EMI Receiver	Agilent	N9038A	MY53220133	Feb. 28, 2021
4	Measurement Software	Farad	EZ-EMC Ver.BTL-2ANT-1	N/A	N/A
5	Multi-Device Controller	ETS-Lindgren	2090	N/A	N/A
6	Controller	MF	MF-7802	MF780208159	N/A
7	Cable	Mlcable Inc.	B10-01-01-5M	18047123	Feb. 28, 2021
8	Cable	Mlcable Inc.	B10-01-01-12M	18072743	Feb. 28, 2021
9	Cable	RegalWay	RWLPS50-7.9A-SMSM-1 M	20200102 001	Feb. 28, 2021

Remark: "N/A" denotes no model name, no serial no. or no calibration specified.

All calibration period of equipment list is one year.

3.3.3 TEST PROCEDURE

- a. The measuring distance of 3 m shall be used for measurements. The EUT was placed on the top of a rotating table 0.8 meter above the ground at a 10 meter semi-anechoic chamber. The table was rotated 360 degrees to determine the position of the highest radiation.
- b. The height of the equipment or of the substitution antenna shall be 0.8 m, the height of the test antenna shall vary between 1 m to 4 m. Both horizontal and vertical polarizations of the antenna are set to make the measurement.
- c. For each suspected emission, the EUT was arranged to its worst case and then the antenna was tuned to heights find the maximum reading (used Bore sight function).
- d. The initial step in collecting radiated emission data is a receiver peak detector mode pre-scanning the measurement frequency range. Significant peaks are then marked and then Quasi Peak detector mode re-measured.
- e. The receiver system was set to peak and average detect function and specified bandwidth with maximum hold mode when the test frequency is above 1 GHz.
- f. All readings are Peak Mode value unless otherwise stated AVG in column of Note. If the Peak Mode Measured value compliance with the Peak Limits and lower than AVG Limits, the EUT shall be deemed to meet both Peak & AVG Limits and then only Peak Mode was measured, but AVG Mode didn't perform.
- g. For the actual test configuration, please refer to the related Item - Block Diagram of system tested.

3.3.4 DEVIATION FROM TEST STANDARD

No deviation

3.3.5 TEST SETUP

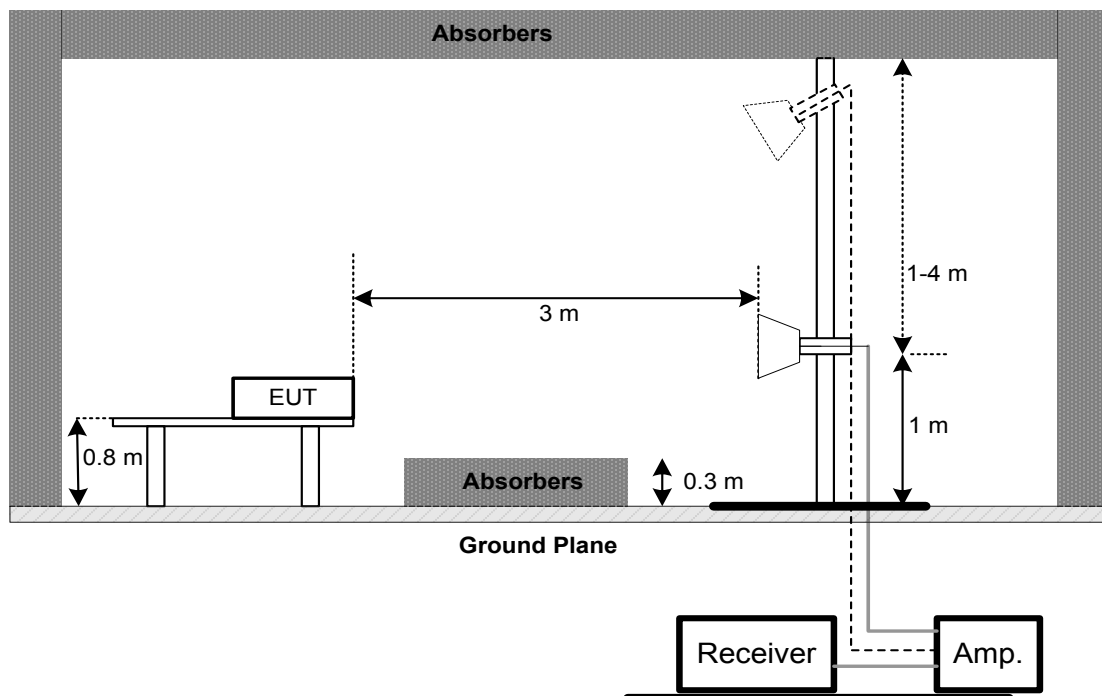

3.3.6 TEST RESULTS-ABOVE 1 GHZ

Remark :

- (1) Radiated emissions measured in frequency range above 1000 MHz were made with an instrument using Peak detector mode and AV detector mode of the emission.
- (2) Data of measurement within this frequency range shown “ * ” in the table above means the reading of emissions are attenuated more than 20 dB below the permissible limits or the field strength is too small to be measured.
- (3) A preamp and high pass filter were used for this test in order to provide sufficient measurement sensitivity.

Test Voltage	AC 120V/60Hz	Polarization	Vertical
Test Mode	HDMI1 2560*1440/144Hz 1.8m		

86.9 dBuV/m

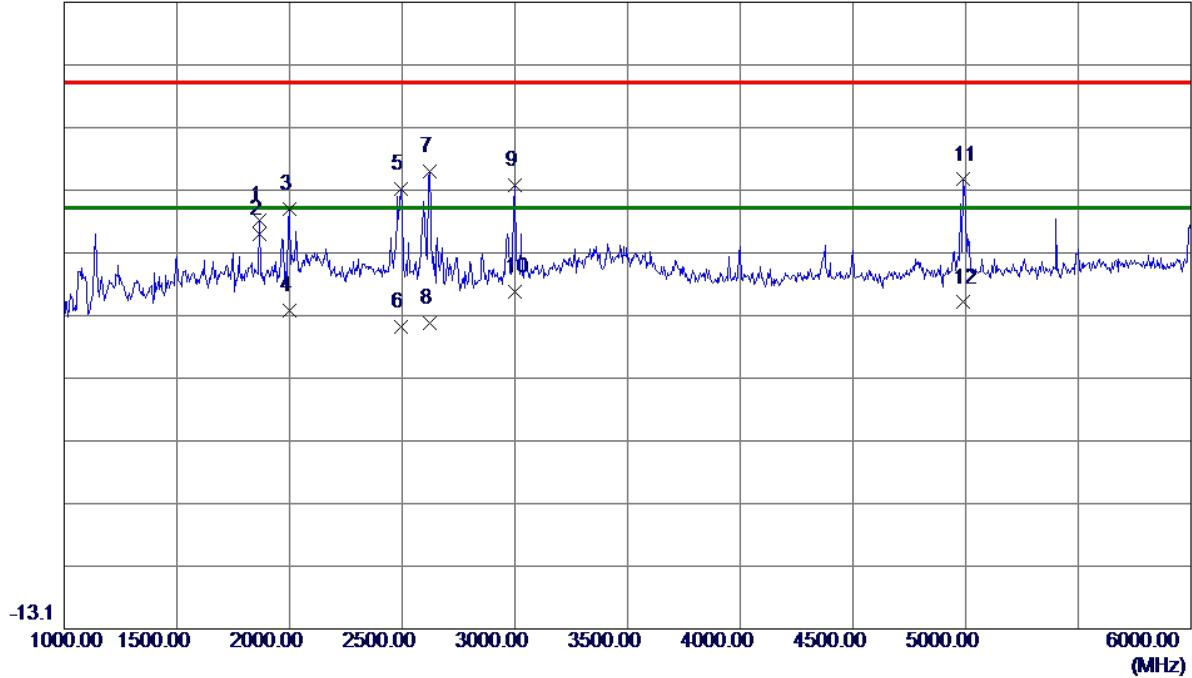

No.	Freq. MHz	Reading Level dBuV/m	Correct Factor dB	Measure ment dBuV/m	Limit dBuV/m	Margin dB	Detector
1	1865.0000	52.78	-0.64	52.14	74.00	-21.86	Peak
2 *	1865.0000	50.46	-0.64	49.82	54.00	-4.18	AVG
3	1997.5000	53.63	0.21	53.84	74.00	-20.16	Peak
4	1997.5000	37.58	0.21	37.79	54.00	-16.21	AVG
5	2495.0000	55.08	2.00	57.08	74.00	-16.92	Peak
6	2495.0000	33.17	2.00	35.17	54.00	-18.83	AVG
7	2620.0000	57.25	2.58	59.83	74.00	-14.17	Peak
8	2620.0000	33.20	2.58	35.78	54.00	-18.22	AVG
9	2997.5000	53.35	4.36	57.71	74.00	-16.29	Peak
10	2997.5000	36.29	4.36	40.65	54.00	-13.35	AVG
11	4990.0000	48.45	10.15	58.60	74.00	-15.40	Peak
12	4990.0000	28.85	10.15	39.00	54.00	-15.00	AVG

Test Voltage	AC 120V/60Hz	Polarization	Horizontal
Test Mode	HDMI1 2560*1440/144Hz 1.8m		

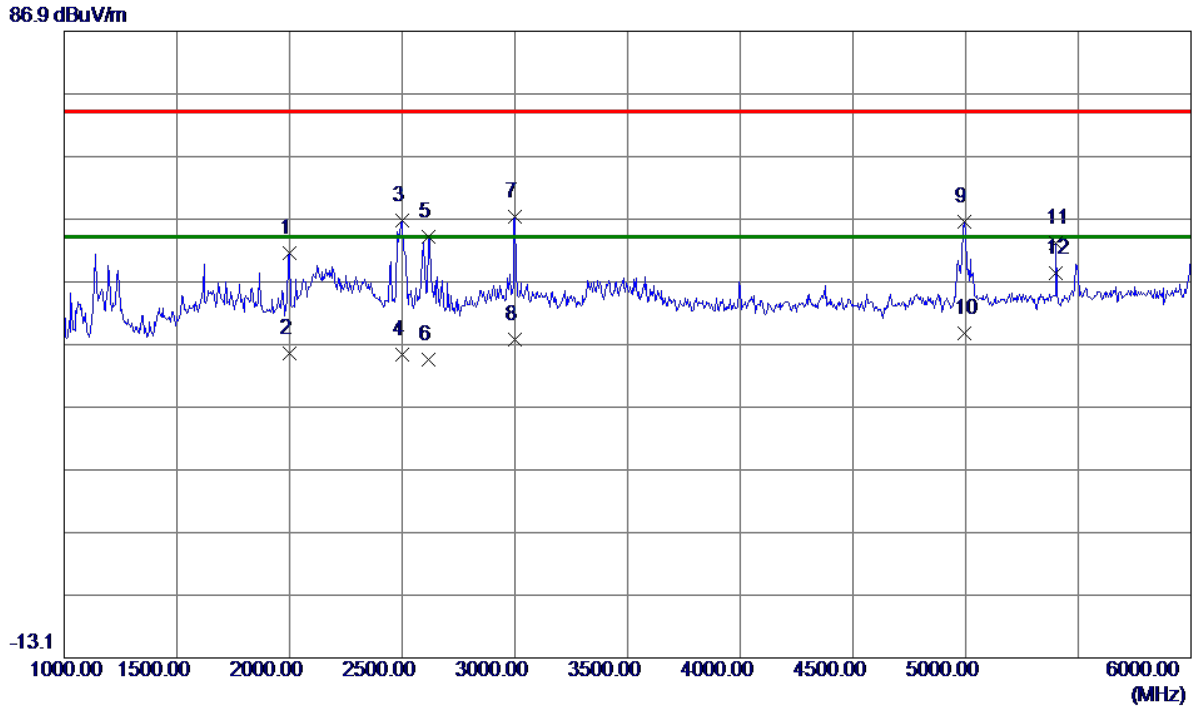

No.	Freq. MHz	Reading Level dBuV/m	Correct Factor dB	Measure ment dBuV/m	Limit dBuV/m	Margin dB	Detector
1	2000.0000	51.26	0.23	51.49	74.00	-22.51	Peak
2	2000.0000	35.24	0.23	35.47	54.00	-18.53	AVG
3	2497.5000	54.68	2.01	56.69	74.00	-17.31	Peak
4	2497.5000	33.38	2.01	35.39	54.00	-18.61	AVG
5	2617.5000	51.57	2.57	54.14	74.00	-19.86	Peak
6	2617.5000	32.00	2.57	34.57	54.00	-19.43	AVG
7	3000.0000	52.88	4.37	57.25	74.00	-16.75	Peak
8	3000.0000	33.31	4.37	37.68	54.00	-16.32	AVG
9	4995.0000	46.31	10.16	56.47	74.00	-17.53	Peak
10	4995.0000	28.61	10.16	38.77	54.00	-15.23	AVG
11	5400.0000	41.88	11.18	53.06	74.00	-20.94	Peak
12 *	5400.0000	37.14	11.18	48.32	54.00	-5.68	AVG

Test Voltage	AC 120V/60Hz	Polarization	Vertical
Test Mode	DP1 2560*1440/240Hz 1.8m		

86.9 dBuV/m

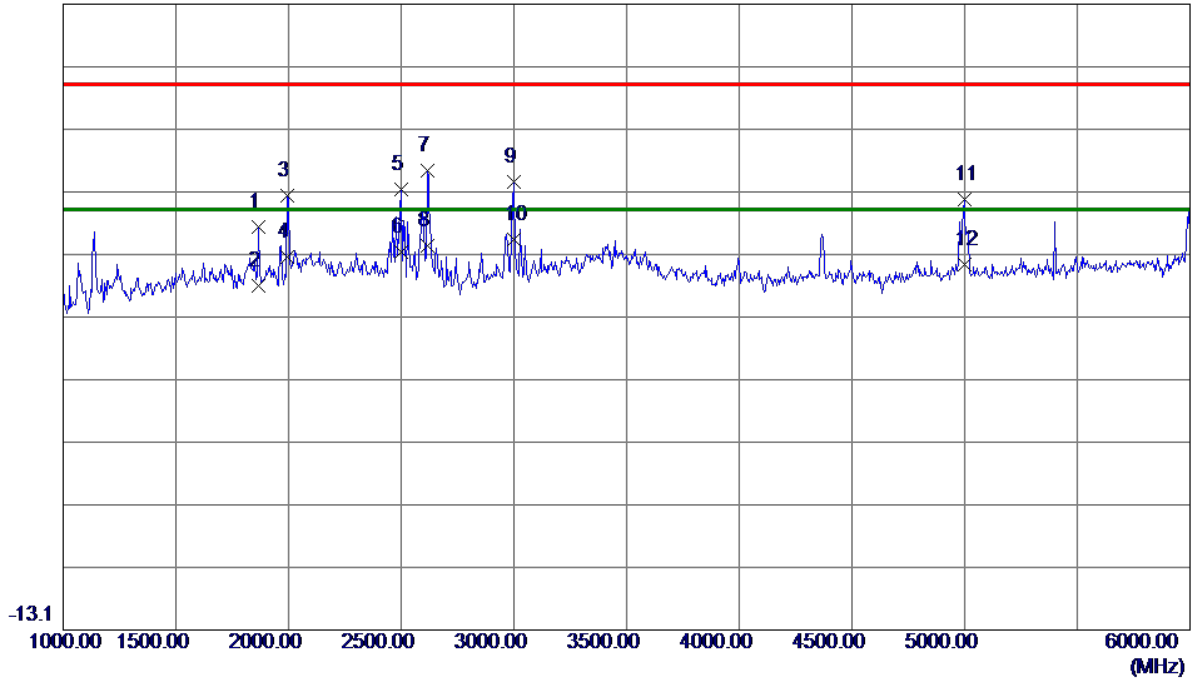

No.	Freq. MHz	Reading Level dBuV/m	Correct Factor dB	Measure ment dBuV/m	Limit dBuV/m	Margin dB	Detector
1	1865.0000	51.94	-0.64	51.30	74.00	-22.70	Peak
2	1865.0000	42.56	-0.64	41.92	54.00	-12.08	AVG
3	1992.5000	56.14	0.18	56.32	74.00	-17.68	Peak
4	1992.5000	46.34	0.18	46.52	54.00	-7.48	AVG
5	2497.5000	55.30	2.01	57.31	74.00	-16.69	Peak
6	2497.5000	45.31	2.01	47.32	54.00	-6.68	AVG
7	2617.5000	57.78	2.57	60.35	74.00	-13.65	Peak
8	2617.5000	45.75	2.57	48.32	54.00	-5.68	AVG
9	2997.5000	54.23	4.36	58.59	74.00	-15.41	Peak
10 *	2997.5000	44.96	4.36	49.32	54.00	-4.68	AVG
11	4997.5000	45.57	10.16	55.73	74.00	-18.27	Peak
12	4997.5000	35.10	10.16	45.26	54.00	-8.74	AVG

Test Voltage	AC 120V/60Hz	Polarization	Horizontal
Test Mode	DP1 2560*1440/240Hz 1.8m		

86.9 dBuV/m

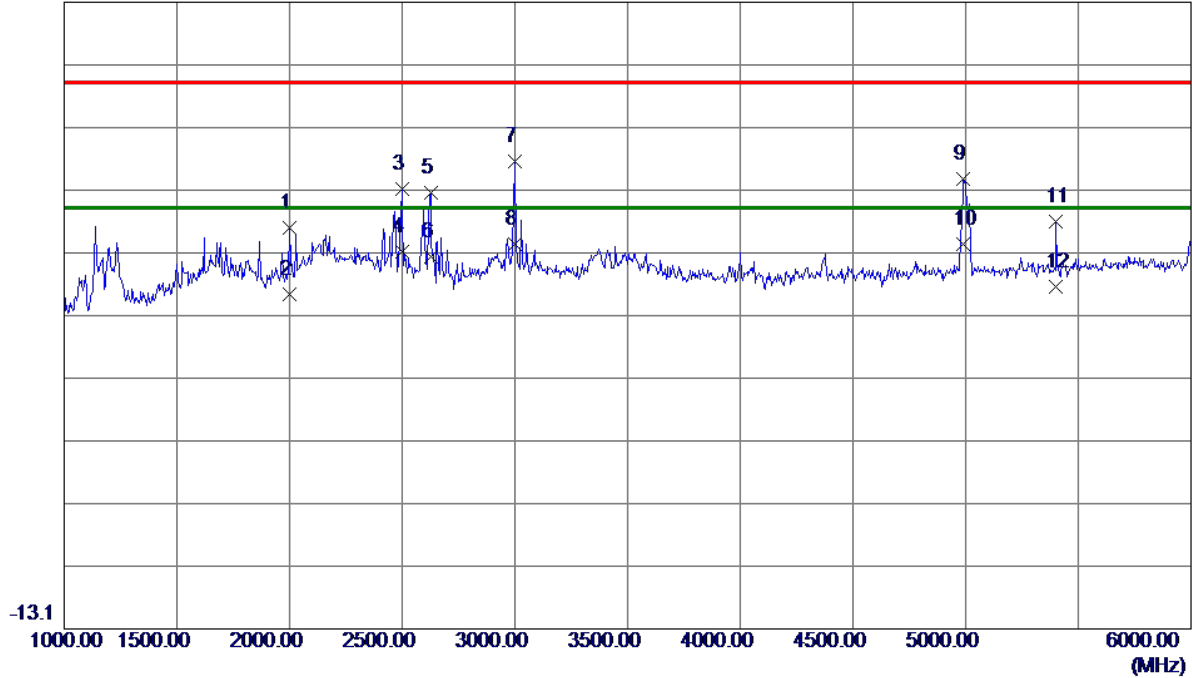

No.	Freq. MHz	Reading Level dBuV/m	Correct Factor dB	Measure ment dBuV/m	Limit dBuV/m	Margin dB	Detector
1	2000.0000	50.73	0.23	50.96	74.00	-23.04	Peak
2	2000.0000	40.09	0.23	40.32	54.00	-13.68	AVG
3	2497.5000	55.18	2.01	57.19	74.00	-16.81	Peak
4	2497.5000	45.15	2.01	47.16	54.00	-6.84	AVG
5	2627.5000	53.87	2.62	56.49	74.00	-17.51	Peak
6	2627.5000	43.70	2.62	46.32	54.00	-7.68	AVG
7	2997.5000	57.05	4.36	61.41	74.00	-12.59	Peak
8 *	2997.5000	43.96	4.36	48.32	54.00	-5.68	AVG
9	4990.0000	48.48	10.15	58.63	74.00	-15.37	Peak
10	4990.0000	38.17	10.15	48.32	54.00	-5.68	AVG
11	5400.0000	40.81	11.18	51.99	74.00	-22.01	Peak
12	5400.0000	30.28	11.18	41.46	54.00	-12.54	AVG

Test Voltage	AC 120V/60Hz	Polarization	Vertical
Test Mode	HDMI1 1080P 1.8m		

86.9 dBuV/m

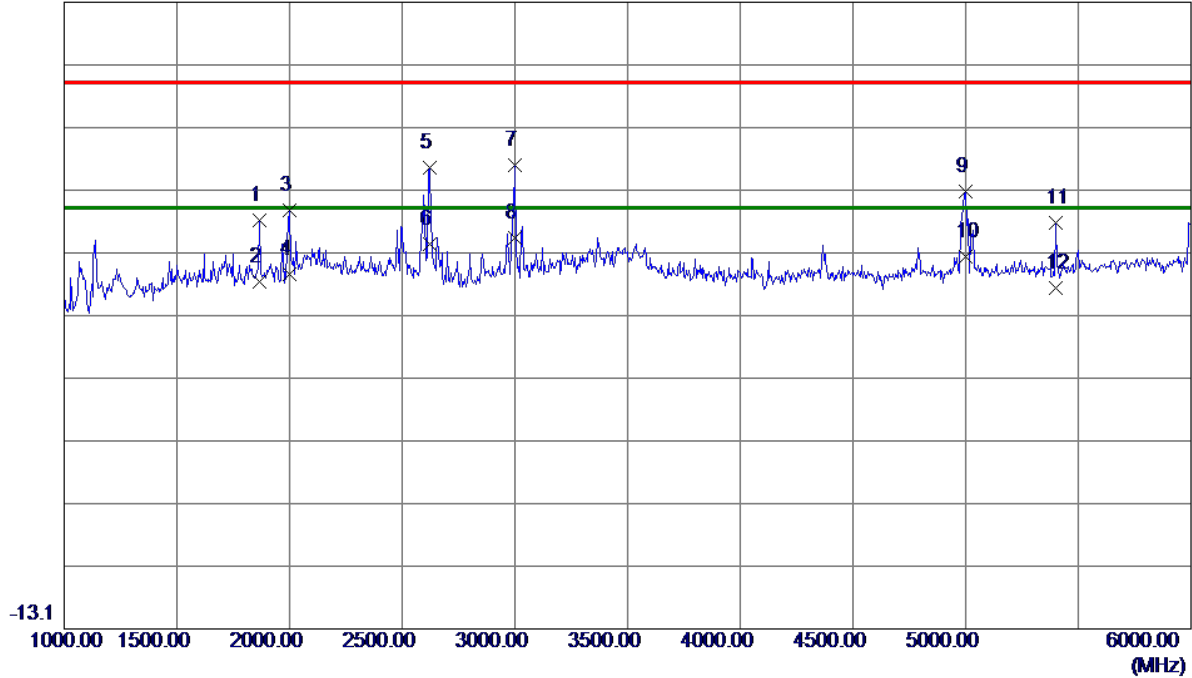

No.	Freq. MHz	Reading Level dBuV/m	Correct Factor dB	Measure ment dBuV/m	Limit dBuV/m	Margin dB	Detector
1	1865.0000	52.71	-0.64	52.07	74.00	-21.93	Peak
2	1865.0000	42.96	-0.64	42.32	54.00	-11.68	AVG
3	2000.0000	53.49	0.23	53.72	74.00	-20.28	Peak
4	2000.0000	43.29	0.23	43.52	54.00	-10.48	AVG
5	2622.5000	57.83	2.60	60.43	74.00	-13.57	Peak
6	2622.5000	45.72	2.60	48.32	54.00	-5.68	AVG
7	2997.5000	56.59	4.36	60.95	74.00	-13.05	Peak
8 *	2997.5000	44.96	4.36	49.32	54.00	-4.68	AVG
9	4997.5000	46.64	10.16	56.80	74.00	-17.20	Peak
10	4997.5000	36.07	10.16	46.23	54.00	-7.77	AVG
11	5400.0000	40.61	11.18	51.79	74.00	-22.21	Peak
12	5400.0000	30.07	11.18	41.25	54.00	-12.75	AVG

Test Voltage	AC 120V/60Hz	Polarization	Horizontal
Test Mode	HDMI1 1080P 1.8m		

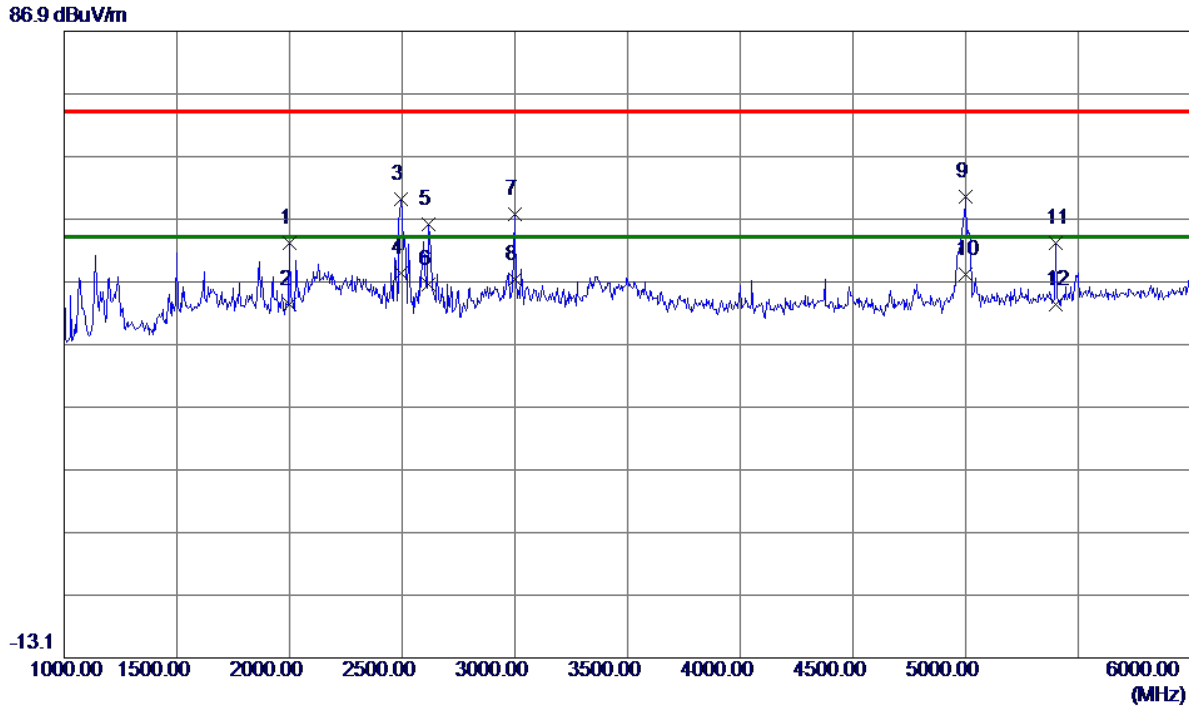

No.	Freq. MHz	Reading Level dBuV/m	Correct Factor dB	Measure ment dBuV/m	Limit dBuV/m	Margin dB	Detector
1	1997.5000	52.84	0.21	53.05	74.00	-20.95	Peak
2	1997.5000	43.11	0.21	43.32	54.00	-10.68	AVG
3	2495.0000	58.09	2.00	60.09	74.00	-13.91	Peak
4 *	2495.0000	46.32	2.00	48.32	54.00	-5.68	AVG
5	2617.5000	53.49	2.57	56.06	74.00	-17.94	Peak
6	2617.5000	43.95	2.57	46.52	54.00	-7.48	AVG
7	2997.5000	53.28	4.36	57.64	74.00	-16.36	Peak
8	2997.5000	42.87	4.36	47.23	54.00	-6.77	AVG
9	5000.0000	50.34	10.17	60.51	74.00	-13.49	Peak
10	5000.0000	38.02	10.17	48.19	54.00	-5.81	AVG
11	5400.0000	41.87	11.18	53.05	74.00	-20.95	Peak
12	5400.0000	32.14	11.18	43.32	54.00	-10.68	AVG

4. EUT TEST PHOTO

AC Power Line Conducted Emissions



Radiated Emissions 30 MHz to 1 GHz

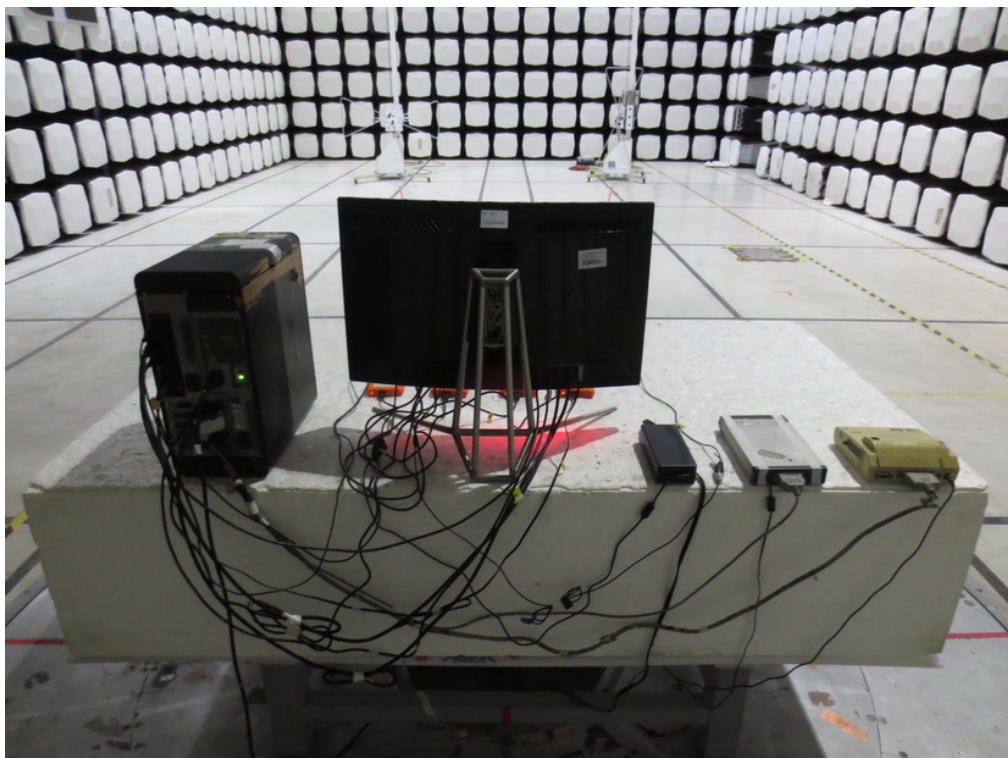

Radiated Emissions Above 1 GHz

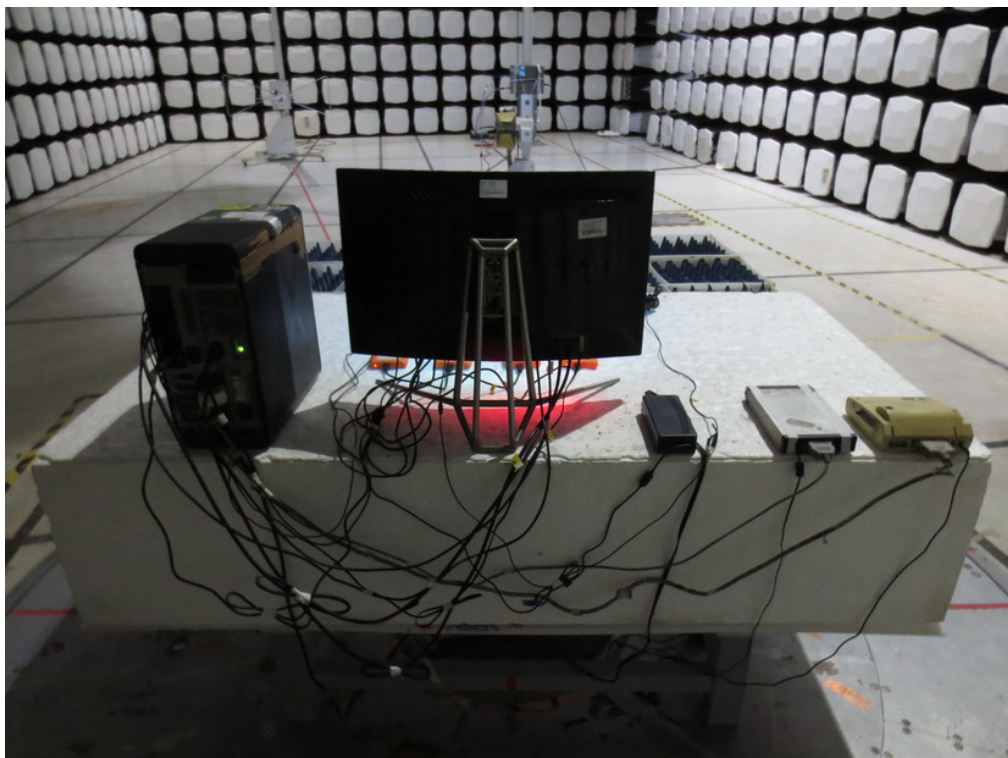

End of Test Report