

EMC TEST REPORT

Report No. : ACS-E21206

Applicant : TPV Electronics (FuJian) Co., Ltd.
Rongqiao Economic and Technological Development
Zone, Fuqing City, Fujian Province, P.R. China

Product : LCD Monitor

Model No. : AG274U; AG274U*****
(* = 0-9, A-Z, a-z, +, -, /, \ or blank)

Brand : AOC

Test Lab. : Audix Technology (Shenzhen) Co., Ltd.
No. 6, Kefeng Road, Science & Technology Park,
Nanshan District, Shenzhen, Guangdong, China
Tel: (0755) 26639496
Fax: (0755) 26632877

Date of Test : Apr.02~Jun.20, 2021

Date of Report : Jun.28, 2021



TABLE OF CONTENTS

Description	Page
TEST REPORT VERIFICATION.....	5
1. SUMMARY OF STANDARDS AND RESULTS	6
1.1. Description of Standards and Results	6
2. GENERAL INFORMATION	7
2.1. Description of Device (EUT)	7
2.2. Tested Supporting System Details.....	8
2.3. Block Diagram of connection between EUT and simulators	9
2.4. Test Facility	10
2.5. Measurement Uncertainty (95% confidence levels, k=2)	10
3. CONDUCTED EMISSION AT MAINS TERMINALS TEST	11
3.1. Test Equipments	11
3.2. Block Diagram of Test Setup	11
3.3. Test Standard.....	11
3.4. Power Line Conducted Emission at Mains Terminals Class B Limit	11
3.5. EUT Configuration on Test.....	12
3.6. Operating Condition of EUT	12
3.7. Test Procedure.....	12
3.8. Conducted Emission at Mains Terminals Test Results	13
4. RADIATED EMISSION MEASUREMENT	19
4.1. Test Equipments	19
4.2. Block Diagram of Test Setup	20
4.3. Test Standard.....	21
4.4. Radiated Emission Class B Limit.....	21
4.5. EUT Configuration on Test.....	21
4.6. Operating Condition of EUT	21
4.7. Test Procedure.....	21
4.8. Radiated Emission Test Results	23
5. HARMONIC CURRENT TEST	35
5.1. Test Equipments	35
5.2. Block Diagram of Test Setup	35
5.3. Test Standard.....	35
5.4. Limits of Harmonic Current	35
5.5. EUT Configuration on Test.....	36
5.6. Operating Condition of EUT	36
5.7. Test Procedure.....	36
5.8. Test Results	36
6. VOLTAGE FLUCTUATIONS & FLICKER TEST	55
6.1. Test Equipment.....	55
6.2. Block Diagram of Test Setup	55
6.3. Test Standard.....	55
6.4. Limits of Voltage Fluctuation and Flick	55
6.5. EUT Configuration on Test.....	55
6.6. Operating Condition of EUT	55
6.7. Test Procedure.....	55
6.8. Test Results	55
7. IMMUNITY PERFORMANCE CRITERIA	58
8. ELECTROSTATIC DISCHARGE IMMUNITY TEST.....	59
8.1. Test Equipments	59
8.2. Block Diagram of Test Setup	59
8.3. Test Standard.....	59

8.4.	Severity Levels and Performance Criterion	59
8.5.	EUT Configuration.....	60
8.6.	Operating Condition of EUT	60
8.7.	Test Procedure.....	60
8.8.	Test Results	60
8.9.	ESD Test Point Photos	62
9.	RF FIELD STRENGTH SUSCEPTIBILITY TEST	64
9.1.	Test Equipments	64
9.2.	Block Diagram of Test Setup	65
9.3.	Test Standard.....	65
9.4.	Severity Levels and Performance Criterion	66
9.5.	EUT Configuration.....	66
9.6.	Operating Condition of EUT	66
9.7.	Test Procedure.....	66
9.8.	Test Results	66
10.	ELECTRICAL FAST TRANSIENT/BURST IMMUNITY TEST.....	68
10.1.	Test Equipments	68
10.2.	Block Diagram of Test Setup	68
10.3.	Test Standard.....	68
10.4.	Severity Levels and Performance Criterion	68
10.5.	EUT Configuration.....	69
10.6.	Operating Condition of EUT	69
10.7.	Test Procedure.....	69
10.8.	Test Results	69
11.	SURGE TEST	71
11.1.	Test Equipments	71
11.2.	Block Diagram of Test Setup	71
11.3.	Test Standard.....	71
11.4.	Severity Levels and Performance Criterion	71
11.5.	EUT Configuration.....	71
11.6.	Operating Condition of EUT	72
11.7.	Test Procedure.....	72
11.8.	Test Results	72
12.	CONTINUOUS CONDUCTED DISTURBANCE TEST	74
12.1.	Test Equipments	74
12.2.	Block Diagram of Test Setup	74
12.3.	Test Standard.....	74
12.4.	Severity Levels and Performance Criterion	75
12.5.	EUT Configuration.....	75
12.6.	Operating Condition of EUT	75
12.7.	Test Procedure.....	75
12.8.	Test Results	75
13.	MAGNETIC FIELD IMMUNITY TEST.....	77
13.1.	Test Equipment.....	77
13.2.	Block Diagram of Test Setup	77
13.3.	Test Standard.....	77
13.4.	Severity Levels and Performance Criterion	77
13.5.	EUT Configuration on Test.....	78
13.6.	Operating Condition of EUT	78
13.7.	Test Procedure.....	78
13.8.	Test Results	78
14.	VOLTAGE DIPS AND INTERRUPTIONS TEST	80
14.1.	Test Equipment.....	80
14.2.	Block Diagram of Test Setup	80
14.3.	Test Standard.....	80
14.4.	Severity Levels and Performance Criterion	80

14.5.	EUT Configuration.....	80
14.6.	Operating Condition of EUT.....	81
14.7.	Test Procedure.....	81
14.8.	Test Results	81
15.	PHOTOGRAPHS	83
15.1.	Photos of Power Line Conducted Emission Test.....	83
15.2.	Photos of Radiated Emission Test (In 10m Anechoic Chamber).....	84
15.3.	Photo of Harmonic / Flicker Test.....	86
15.4.	Photos of Electrostatic Discharge Immunity Test.....	86
15.5.	Photo of RF Strength Susceptibility Test.....	87
15.6.	Photos of Electrical Fast Transient/Burst Immunity Test	88
15.7.	Photos of Surge Test.....	89
15.8.	Photos of Continuous Conducted disturbance Test.....	89
15.9.	Photo of Magnetic Field Test.....	90
15.10.	Photo of Voltage Dips and interruptions test	90

TEST REPORT VERIFICATION

Applicant : TPV Electronics (FuJian) Co., Ltd.
 Product : LCD Monitor
 Model No. : AG274U; AG274U*****(* = 0-9, A-Z, a-z, +, -, /, \ or blank)
 Brand : AOC
 Report No. : ACS-E21206
 Power Supply : AC 100-240V; 50/60Hz
 Test Voltage : AC 230V/50Hz; AC 110V/60Hz; AC 100V/50Hz
 Standards : EN 55032: 2015 / CISPR 32: 2015(Class B)
 EN 55032: 2015+AC: 2016/CISPR 32: 2015+cor1: 2016(Class B)
 EN 55032: 2015+A11: 2020(Class B)
 AS/NZS CISPR 32: 2015
 AS/NZS CISPR 32: 2020
 BS EN 55032: 2015 (Class B)
 BS EN 55032: 2015+A11: 2020
 EN 61000-3-2: 2014/ IEC 61000-3-2: 2014, Class D
 EN IEC 61000-3-2: 2019/IEC 61000-3-2: 2018, Class D
 BS EN 61000-3-2: 2014; BS EN IEC 61000-3-2: 2019
 EN 61000-3-3: 2013 /IEC 61000-3-3: 2013
 EN 61000-3-3: 2013+A1:2019 /IEC 61000-3-3: 2013+A1:2017
 BS EN 61000-3-3: 2013; BS EN 61000-3-3: 2013+A1:2019
 EN 55035: 2017 / CISPR 35: 2016; EN 55035: 2017+A11:2020
 BS EN 55035: 2017 / CISPR 35: 2016
 BS EN 55035: 2017+A11:2020
 (IEC 61000-4-2: 2008, IEC 61000-4-3: 2010, IEC 61000-4-4: 2012
 IEC 61000-4-5: 2014; IEC 61000-4-5: 2014+A1: 2017,
 IEC 61000-4-6: 2013; IEC 61000-4-8: 2009; IEC 61000-4-11: 2004
 IEC-61000-4-11: 2004+A1: 2017; IEC-61000-4-11: 2020)

The device described above is tested by Audix Technology (Shenzhen) Co., Ltd. to determine the maximum emission levels emanating from the device and the severe levels of the device can endure and its performance criterion. The test results are contained in this test report and Audix Technology (Shenzhen) Co., Ltd. is assumed full responsibility for the accuracy and completeness of test. Also, this report shows that the EUT is technically compliant with the requirements of EN 55032, BS EN 55032, BS EN 61000-3-2, EN 61000-3-2, BS EN 61000-3-3, EN 61000-3-3 and BS EN 55035, EN 55035 standards.

The report must not be used by the client to claim product certification, approval, or endorsement by NVLAP, NIST, or any agency of the federal government.

This report applies to single evaluation of one sample of above mentioned products. This report shall not be reproduced in parts without written approval of Audix Technology (Shenzhen) Co., Ltd.

Date of Test : Apr.02~Jun.20, 2021 Report of date: Jun.28, 2021

Prepared by : Kayli He (Reviewed by) Fire Zhang
 Kayli He / Assistant Audix Technology (Shenzhen) Co., Ltd. Fire Zhang / Assistant Manager
 EMC 部門報告專用章



Approved & Authorized Signer : Signature: Bensun Chen
 Bensun Chen / Manager

1. SUMMARY OF STANDARDS AND RESULTS

1.1. Description of Standards and Results

The EUT has been tested according to the applicable standards as referenced below.

EMISSION				
Description of Test Item	Standard	Results	Remark	
Conducted emission at mains terminals	EN 55032; BS EN 55032	PASS	Minimum passing margin is 6.39dB at 0.346MHz	
Conducted emission at telecommunication port	EN 55032; BS EN 55032	N/A	N/A	
Radiated emission (30-1000MHz)	EN 55032; BS EN 55032	PASS	Minimum passing margin is 4.08dB at 874.870MHz	
Radiated emission (1-6GHz)	EN 55032; BS EN 55032	PASS	Minimum passing margin is 4.21dB at 2622.656MHz	
Harmonic current emissions	EN 61000-3-2 EN IEC 61000-3-2 BS EN 61000-3-2	PASS	Meets the Class D requirement	
Voltage fluctuations & flicker	EN 61000-3-3 BS EN 61000-3-3	PASS	Meets the requirement	
IMMUNITY				
Description of Test Item	Basic Standard	Results	Performance Criteria	Observation
Electrostatic discharge (ESD)	IEC 61000-4-2	PASS	B	A & B
Radiated, radio-frequency, electromagnetic field immunity test	IEC 61000-4-3	PASS	A	A
Electrical fast transient (EFT)	IEC 61000-4-4	PASS	B	A & B
Surge (Input a.c. power port)	IEC 61000-4-5	PASS	B	A&B
Surge(Telecommunication port)		N/A	N/A	N/A
Surge (Coaxial or Shielding)		N/A	N/A	N/A
Continuous Conducted disturbance	IEC 61000-4-6	PASS	A	A
Power frequency magnetic field	IEC 61000-4-8	PASS	A	A
Voltage dips, >95% reduction	IEC 61000-4-11	PASS	B	A
Voltage dips, 30% reduction		PASS	C	A & C
Voltage interruptions		PASS	C	C

N/A is an abbreviation for Not Applicable.

2. GENERAL INFORMATION

2.1. Description of Device (EUT)

Product	: LCD Monitor
Model No.	: AG274U; AG274U*****(* = 0-9, A-Z, a-z, +, -, /, \ or blank)
Brand	: AOC
Applicant	: TPV Electronics (FuJian) Co., Ltd. Rongqiao Economic and Technological Development Zone, Fuqing City, Fujian Province, P.R. China
Max. Resolution	: 3840*2160@144Hz
Max. Work Frequency	: 1400MHz
I/O Port	: (1) One DC In Port (2) Micro Out Port (3) Micro InPort (4) Audio Out Port (5) Micro USB Port (6) One DP Port (7) Two HDMI Ports (8) One Type-C Port (9) One USB Up-stream Port (10) Four USB 3.0 Ports
Adapter#1	: ADP-230JB D
Adapter#2	: FSP 230-AJAN3
Power Cord	: Unshielded, Detachable, 1.8m/1.5m(3 pins)
Audio Cable	: Shielded, Detachable, 1.8m/1.5m
DP Cable	: Shielded, Detachable, 1.8m/1.5m
HDMI Cable	: Shielded, Detachable, 1.8m /1.5m
USB3.0 Cable	: Shielded, Detachable, 1.8m /1.5m
Type-C Cable	: Shielded, Detachable, 1.8m /1.5m
USB Type-C Cable	: Shielded, Detachable, 1.8m /1.5m
Date of Test	: Apr.02~Jun.20, 2021
Date of Receipt	: Feb.08, 2021
Sample Type	: Prototype production

2.2. Tested Supporting System Details

No.	Description	ACS No.	Manufacturer	Model	Serial Number
1.	Personal Computer	Test PC Q	acer	Veriton T630	DTVMKCN00560900F629600
		Power Cord(3C): Unshielded, Detachable, 1.8m			
2.	USB Keyboard	ACS-EMC-K03R	DELL	SK-8120	CN-ODJ365-71616-2BE-0DCE-A00
		USB Cable: Shielded, Undetachable, 1.5m			
3.	USB Mouse	ACS-EMC-M03R	DELL	M0C5UO	512023253
		SB Cable: Shielded, Undetachable, 1.8m			
4.	Printer	ACS-EMC-PT04	HP	C9079A	908A1001201
		USB Cable: Shielded, Detachable, 1.8m			
		Power Cord(2C): Unshielded, Detachable, 1.8m			
5.	Headphone	ACS-EMC-EP01	OVANN	OV880V	---
		Data Cable: Shielded, Undetachable, 2.0m			
6.	HDD	ACS-EMC-HDD01	Terasys	F12-UF	A0100215-5390031
		USB Cable: Shielded, Detachable, 1.8m			
7.	HDD#1	ACS-EMC-HDD38	WD	WD Elements	WXA1E63CEME4
		Data Cable: Shielded, Detachable, 1.0m			
8.	HDD#2	ACS-EMC-HDD39	WD	WD Elements	WX61A8360420
		Data Cable: Shielded, Detachable, 1.0m			
9.	HDD#3	ACS-EMC-HDD40	WD	WD Elements	WXA1E63CEMWP7
		Data Cable: Shielded, Detachable, 1.0m			
10.	HDD#4	ACS-EMC-HDD41	WD	WD Elements	WXA1E63XVF03
		Data Cable: Shielded, Detachable, 1.0m			
11.	DVD	---	Pioneer	DV-310NC-K	---
		Power Cord(2C): Unshielded, Detachable, 1.5m			
12.	Notebook	---	DELL	precision 5550	---
		Power Cord: Unshielded, Detachable, 1.8m			
		Power Adapter: Manufacturer: DELL, M/N: LA65NS1-00 Cable: Unshielded, Detachable, 4.0m(Bond one ferrite core)			
13.	Load	DC 20V, 3.25A			

2.3. Block Diagram of connection between EUT and simulators

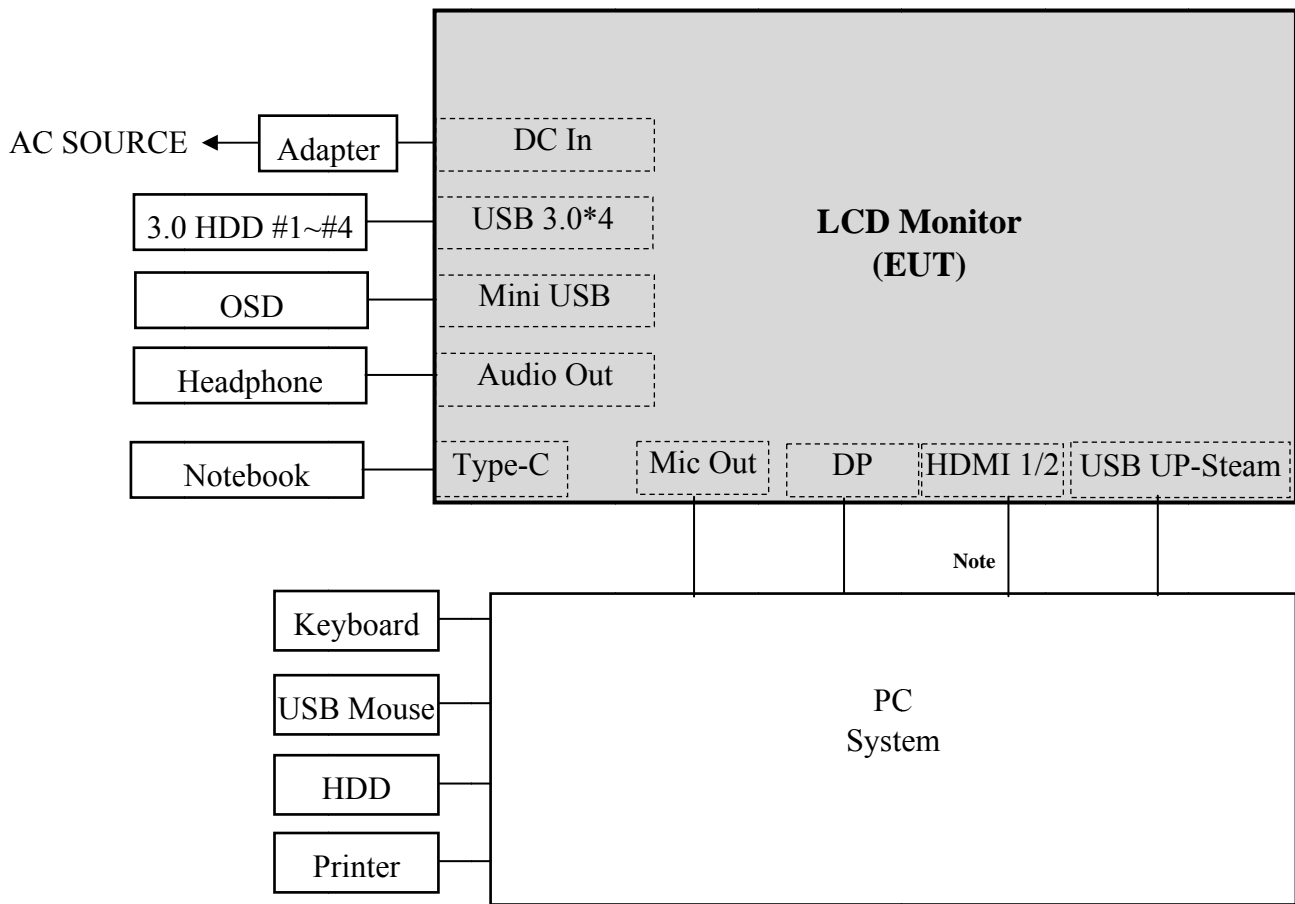

Note: HDMI terminal respectively applies to PC, DVD Mode, but it can't be work at the same time for the two modes.
(EUT: LCD Monitor)

2.4. Test Facility
Site Description

Name of Firm : Audix Technology (Shenzhen) Co., Ltd.
No. 6, Kefeng Road, Science & Technology Park,
Nanshan District, Shenzhen, Guangdong, China

EMC Lab. : Accredited by NVLAP, USA
NVLAP Code: 200372-0
Valid Date: Mar.31, 2022

Certificated by FCC, USA
Designation No: CN5022
Valid Date: Mar.31, 2022

Accredited by TAF, Taiwan
Registration No: 1418
Valid Date: Nov.30, 2023

2.5. Measurement Uncertainty (95% confidence levels, k=2)

Test Item	Uncertainty
Uncertainty for Conduction Emission test in No. 2 Conduction	2.4dB (150 kHz to 30MHz)
Uncertainty for Radiation Emission test in 10m chamber (Distance: 10m)	3.6dB (30~200MHz, Polarization: H)
	3.6dB (30~200MHz, Polarization: V)
	3.6dB (200M~1GHz, Polarization: H)
	3.8dB (200M~1GHz, Polarization: V)
Uncertainty for Radiation Emission test in 10m chamber (1GHz-18GHz)	5.0dB (1~6GHz, Distance: 3m)
	5.0dB (6~18GHz, Distance: 3m)
Uncertainty for S _{VSWR} in 10m Chamber	2.8dB (1~6GHz, Distance: 3m)
	2.8dB (6~18GHz, Distance: 3m)
Uncertainty for Flicker test	1.5%
Uncertainty for Harmonic test	8.0%
Uncertainty for C/S Test	1.4dB (Using CDN test)
	3.2dB (Using EM clamp test)
Uncertainty for R/S Test	2.31dB (80MHz~200MHz)
	2.56dB (200MHz~1000MHz)
	2.64dB(1GHz~6GHz)
Uncertainty for Magnetic Field Immunity test	2%
Uncertainty for test site temperature and humidity and pressure	0.6°C
	3%
	1kPa

Note: EMI uncertainty is evaluated by CISPR16-4-2.

The value of measurement uncertainty of EMI is less than U_{CISPR}.

The value is not calculated in the test results.

3. CONDUCTED EMISSION AT MAINS TERMINALS TEST

3.1. Test Equipments

Item	Equipment	Manufacturer	Model No.	Serial No.	Last Cal.	Cal. Interval
1.	2# Shielding Room	AUDIX	N/A	N/A	Apr.15,18	5 Year
2.	EMI Test Receiver	Rohde & Schwarz	ESCI	100843	Oct.11,20	1 Year
3.	L.I.S.N.#1	Rohde & Schwarz	ENV4200	100041	Apr.07,21	1 Year
4.	L.I.S.N.#2	Kyoritsu	KNW-407	8-1628-5	Apr.07,21	1 Year
5.	Terminator	Hubersuhner	50Ω	No.4	Apr.06,21	1 Year
6.	Terminator	Hubersuhner	50Ω	No.5	Apr.06,21	1 Year
7.	RF Cable	EMCI	EMCCFD300-B M-NM-2000	190421	Apr.13,21	1 Year
8.	Test Software	AUDIX	e3	6.100913a	N/A	N/A

Note: N/A means Not applicable.

3.2. Block Diagram of Test Setup

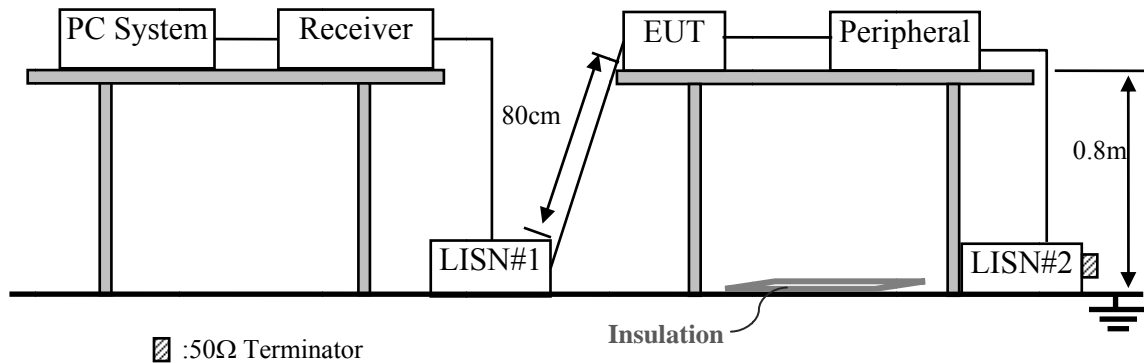

3.3. Test Standard

- EN 55032: 2015(Class B)
- EN 55032: 2015+AC: 2016
- EN 55032: 2015+A11: 2020
- BS EN 55032: 2015
- BS EN 55032: 2015+A11: 2020

3.4. Power Line Conducted Emission at Mains Terminals Class B Limit

Frequency	Maximum RF Line Voltage	
	Quasi-Peak Level dB(μV)	Average Level dB(μV)
150kHz ~ 500kHz	66 ~ 56*	56 ~ 46*
500kHz ~ 5MHz	56	46
5MHz ~ 30MHz	60	50

- Notes:
1. * Decreasing linearly with logarithm of frequency.
 2. The lower limit shall apply at the transition frequencies.
 3. Emission Level (dBμV) = Factor (L.I.S.N.) (dB) + Cable Loss (dB) + Reading (Receiver) (dBμV).

3.5. EUT Configuration on Test

The following equipments are installed on Conducted Emission Test to meet EN 55032 requirement and operating in a manner which tends to maximize its emission characteristics in a normal application.

3.5.1. LCD Monitor (EUT)

Model No. : AG274U

3.5.2. Support Equipment : As Tested Supporting System Detail, in Section 2.2.

3.6. Operating Condition of EUT

3.6.1. Setup the EUT and simulator as shown as Section 3.2.

3.6.2. Turn on the power of all equipments.

3.6.3. For EMI: PC system sent “Color Bars with moving picture element to LCD Monitor (EUT) through HDMI / DP / Type-C card.

3.6.4. For EMS: Standard color bar image with a small moving element for(Digital television set, set-top box, personal computer, DVD player, video game player, video camera); Standard color bar for analog TV; text image for EUT without graphic capability.

3.6.5. DVD Mode: The DVD player played DVD Disk and sent “DVD 1kHz Signal Playing” image to the LCD Monitor (EUT).

3.6.6. The PC system was running the program “1kHz signal playing” and sending sound to EUT.

3.6.7. R-Load mode: The EUT is connected to a 20V, 6.25A resistive load via a USB Type-C signal cable for measurement.

3.6.8. The other peripheral devices were driven and operated in turn during all testing.

3.6.9. The EUT is designed with AC power of rating AC 100V-240V, 50/60Hz. AC 230V/50Hz & AC 110V/60Hz (for EN55032 & CISPR 32 & AS/NZS CISPR 32) had been covered during the pre-test. The worst data was found at AC 230V/50Hz and recorded in the applied test report.

3.7. Test Procedure

The EUT was placed on a non-metallic table, 80cm above the ground plane. The EUT Power connected to the power mains through a line impedance stabilization network (L.I.S.N. #1). This provided a 50-ohm coupling impedance for the EUT (Please refer to the block diagram of the test setup and photographs). The other peripheral devices power cord connected to the power mains through a line impedance stabilization network (L.I.S.N. #2). Both sides of power line were checked for maximum conducted interference. In order to find the maximum emission, the relative positions of equipments and all of the interface cables were changed according to EN 55032, BS EN 55032 Class B on conducted emission test.

The bandwidth of test receiver (R & S ESCI) is set at 9kHz.

The frequency range from 150kHz to 30MHz is checked. These test results of the conducted disturbance are recorded in section 3.8.

3.8. Conducted Emission at Mains Terminals Test Results
PASS. (All emissions not reported below are too low against the prescribed limits.)

EUT: LCD Monitor Model No. : AG274U

The EUT with following test modes were pre-tested:

No.	Adapter	Test Voltage	Test Mode	Input Port	Cable Length	Resolution & Frequency	
1.	Adapter#1: ADP-230JB D	AC 230V/50Hz	PC Mode	DP	1.8m	640*480@60Hz	
2.						1280*1024@75Hz	
3.						3840*2160@144Hz	
4.					1.5m	3840*2160@144Hz	
5.					HDMI 1	1.8m	640*480@60Hz
6.							1280*1024@75Hz
7.				3840*2160@144Hz			
8.				HDMI 2	1.8m	640*480@60Hz	
9.						1280*1024@75Hz	
10.						3840*2160@144Hz	
11.				Type-C	1.8m	640*480@60Hz	
12.						1280*1024@75Hz	
13.						3840*2160@120Hz	
14.				DVD Mode	HDMI 1/2	1.8m	Color Bar
15.				Standby	---	---	---
16.				R Load	Type-C	1.8m	5V/3A
17.							15V/3A
18.							20V/3.25A
19.				AC 110V/60Hz	PC Mode	DP	1.8m
20.	Adapter#2: FSP 230-AJAN3	AC 230V/50Hz	PC Mode	DP	1.8m	640*480@60Hz	
21.						1280*1024@75Hz	
22.						3840*2160@144Hz	
23.					1.5m	3840*2160@144Hz	
24.					HDMI 1	1.8m	640*480@60Hz
25.							1280*1024@75Hz
26.				3840*2160@144Hz			
27.				HDMI 2	1.8m	640*480@60Hz	
28.						1280*1024@75Hz	
29.						3840*2160@144Hz	
30.				Type-C	1.8m	640*480@60Hz	
31.						1280*1024@75Hz	
32.						3840*2160@120Hz	
33.				DVD Mode	HDMI 1/2	1.8m	Color Bar
34.				Standby	---	---	---
35.				R Load	Type-C	1.8m	5V/3A
36.							15V/3A
37.							20V/3.25A
38.				AC 110V/60Hz	PC Mode	DP	1.8m

The result of worst test mode is presented in the report as below and the test data are listed in next pages.

No.	Adapter	Test Voltage	Cable Length	Test Mode	Input Port	Resolution & Frequency	Reference Test Data No.	
							Line	Neutral
1.*	ADP-230JB D	AC 230V/50Hz	1.8m	PC (Running ITU-R BT 1729)	HDMI 1	3840*2160@144Hz	#1	#2
2.				PC (Running ITU-R BT 471-1)			#3	#4

(* means the worst test mode)

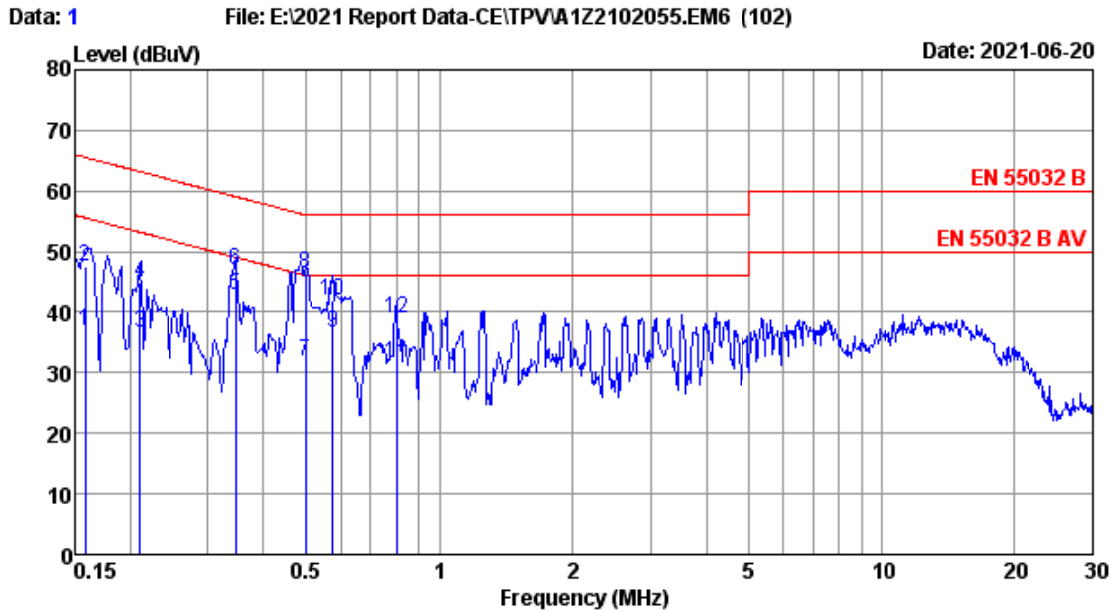

Site no	:2# Conduction	Data No	:1
Dis./Lisn	:2020 ENV4200-L1	LISN phase	:LINE
Limit	:EN 55032 B	Pressure	:101.6kPa
Env./Ins.	:20.6°C/47%	Engineer	:Gavin
EUT	:M/N:AG274U		
Power Rating	:AC 230V/50Hz		
Test Mode	:Running ITU-R BT 1729		
	HDMI1:3840*2160@144Hz		
	Line:1.8m		

No	Freq (MHz)	LISN Factor (dB)	Cable Loss (dB)	Reading (dBuV)	Emission Level (dBuV)	Limits (dBuV)	Margin (dB)	Remark
1	0.158	10.13	0.23	26.60	36.96	55.56	18.60	Average
2	0.158	10.13	0.23	37.05	47.41	65.56	18.15	QP
3	0.211	10.46	0.23	25.80	36.49	53.18	16.69	Average
4	0.211	10.46	0.23	34.04	44.73	63.18	18.45	QP
5	0.346	10.65	0.23	31.79	42.67	49.06	6.39	Average
6	0.346	10.65	0.23	36.20	47.08	59.06	11.98	QP
7	0.498	10.83	0.23	20.90	31.96	46.03	14.07	Average
8	0.498	10.83	0.23	35.20	46.26	56.03	9.77	QP
9	0.574	10.84	0.23	25.60	36.67	46.00	9.33	Average
10	0.574	10.84	0.23	30.90	41.97	56.00	14.03	QP
11	0.800	10.87	0.24	20.50	31.61	46.00	14.39	Average
12	0.800	10.87	0.24	27.93	39.04	56.00	16.96	QP

Remarks: 1.Emission Level=LISN Factor+Cable Loss+Reading.
 2.If the average limit is met when using a quasi-peak detector, the EUT shall be deemed to meet both limits and measurement with average detector is unnecessary.

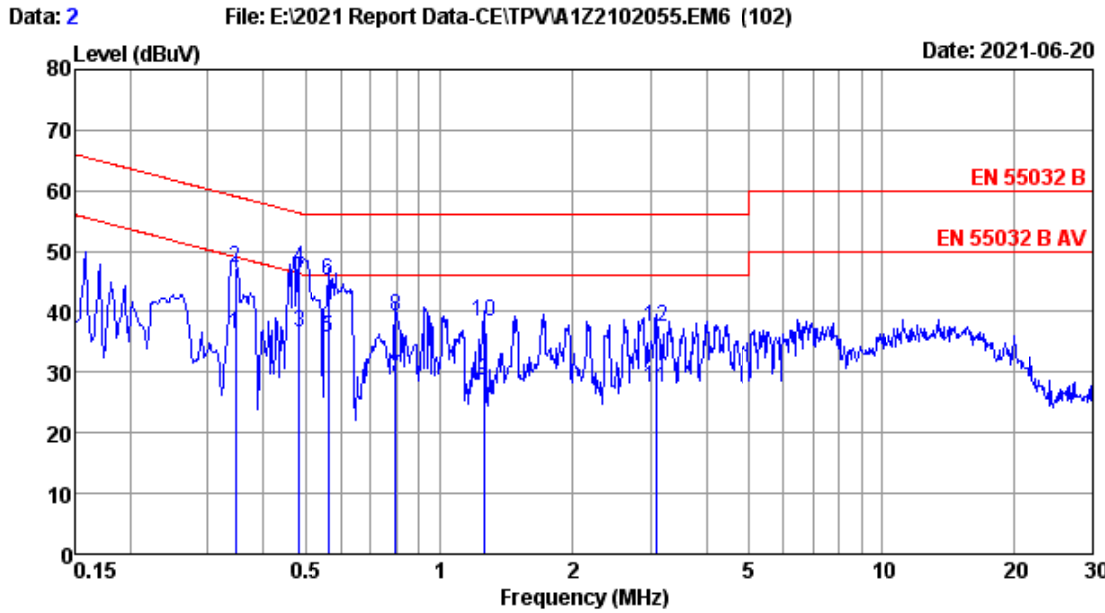

```

Site no      :2# Conduction           Data No     :2
Dis./Lisn   :2020 ENV4200-N         LISN phase :NEUTRAL
Limit       :EN 55032 B              Pressure   :101.6kPa
Env./Ins.   :20.6*C/47%             Engineer   :Gavin
EUT         :M/N:AG274U
Power Rating :AC 230V/50Hz
Test Mode    :Running ITU-R BT 1729
              HDMI1:3840*2160@144Hz
              Line:1.8m
    
```

No	Freq (MHz)	LISN Factor (dB)	Cable Loss (dB)	Reading (dBuV)	Emission Level (dBuV)	Limits (dBuV)	Margin (dB)	Remark
1	0.346	9.89	0.23	26.13	36.25	49.05	12.80	Average
2	0.346	9.89	0.23	37.17	47.29	59.05	11.76	QP
3	0.481	9.83	0.23	26.48	36.54	46.32	9.78	Average
4	0.481	9.83	0.23	37.09	47.15	56.32	9.17	QP
5	0.561	9.82	0.23	25.75	35.80	46.00	10.20	Average
6	0.561	9.82	0.23	35.18	45.23	56.00	10.77	QP
7	0.796	9.81	0.24	19.23	29.28	46.00	16.72	Average
8	0.796	9.81	0.24	29.14	39.19	56.00	16.81	QP
9	1.262	9.80	0.25	18.53	28.58	46.00	17.42	Average
10	1.262	9.80	0.25	28.20	38.25	56.00	17.75	QP
11	3.090	9.81	0.27	17.49	27.57	46.00	18.43	Average
12	3.090	9.81	0.27	27.52	37.60	56.00	18.40	QP

Remarks: 1.Emission Level=LISN Factor+Cable Loss+Reading.
 2.If the average limit is met when using a quasi-peak detector, the EUT shall be deemed to meet both limits and measurement with average detector is unnecessary.

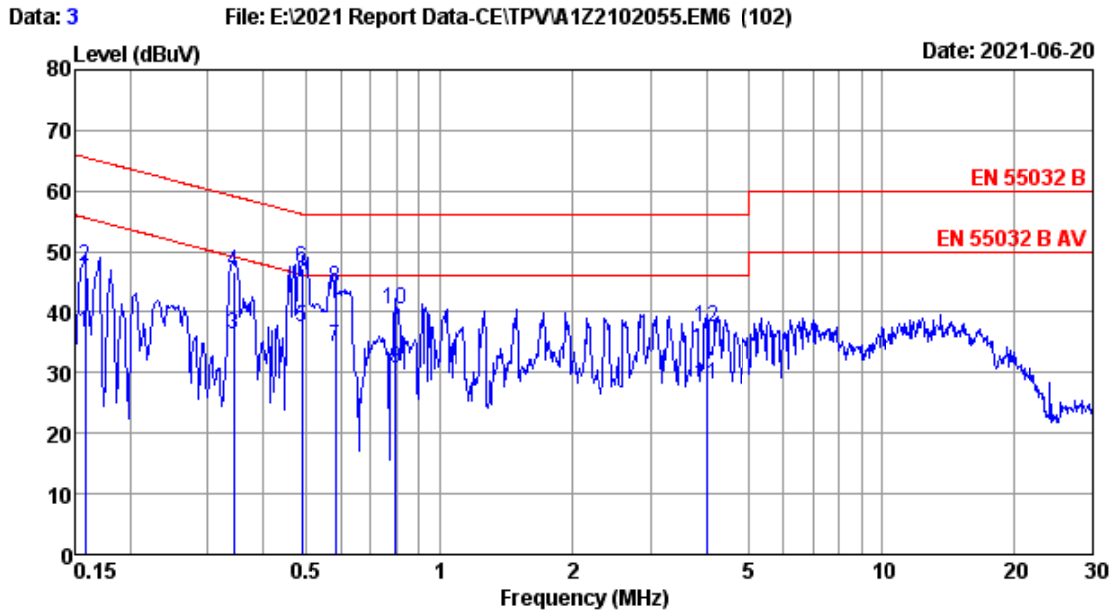

```

Site no       :2# Conduction           Data No      :3
Dis./Lisn    :2020 ENV4200-L1         LISN phase:LINE
Limit        :EN 55032 B              Pressure    :101.6kPa
Env./Ins.    :20.6*C/47%             Engineer    :Gavin
EUT          :M/N:AG274U
Power Rating :AC 230V/50Hz
Test Mode    :Running ITU-R BT 471-1
              HDMI1:3840*2160@144Hz
              Line:1.8m
    
```

No	Freq (MHz)	LISN Factor (dB)	Cable Loss (dB)	Reading (dBuV)	Emission Level (dBuV)	Limits (dBuV)	Margin (dB)	Remark
1	0.158	10.13	0.23	26.19	36.55	55.56	19.01	Average
2	0.158	10.13	0.23	37.14	47.50	65.56	18.06	QP
3	0.343	10.61	0.23	25.48	36.32	49.13	12.81	Average
4	0.343	10.61	0.23	35.92	46.76	59.13	12.37	QP
5	0.489	10.79	0.23	26.35	37.37	46.19	8.82	Average
6	0.489	10.79	0.23	36.32	47.34	56.19	8.85	QP
7	0.582	10.84	0.23	23.18	34.25	46.00	11.75	Average
8	0.582	10.84	0.23	33.02	44.09	56.00	11.91	QP
9	0.796	10.87	0.24	19.63	30.74	46.00	15.26	Average
10	0.796	10.87	0.24	29.25	40.36	56.00	15.64	QP
11	4.027	10.89	0.27	16.75	27.91	46.00	18.09	Average
12	4.027	10.89	0.27	26.28	37.44	56.00	18.56	QP

Remarks: 1.Emission Level=LISN Factor+Cable Loss+Reading.
 2.If the average limit is met when using a quasi-peak detector, the EUT shall be deemed to meet both limits and measurement with average detector is unnecessary.

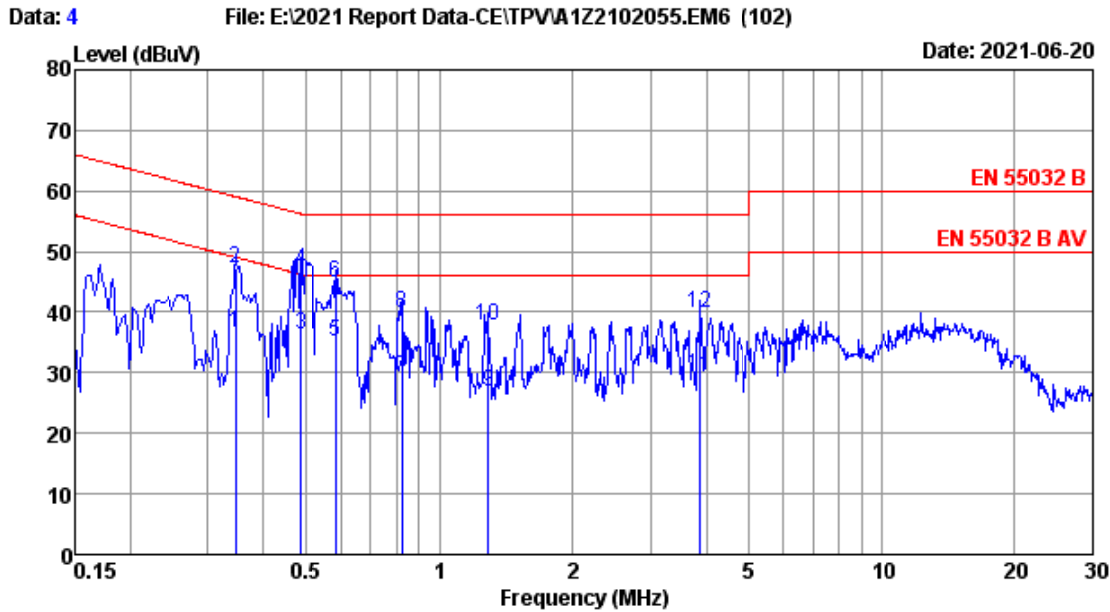

Site no	:2# Conduction	Data No	:4
Dis./Lisn	:2020 ENV4200-N	LISN phase	:NEUTRAL
Limit	:EN 55032 B	Pressure	:101.6kPa
Env./Ins.	:20.6°C/47%	Engineer	:Gavin
EUT	:M/N:AG274U		
Power Rating	:AC 230V/50Hz		
Test Mode	:Running ITU-R BT 471-1		
	HDMI1:3840*2160@144Hz		
	Line:1.8m		

No	Freq (MHz)	LISN Factor (dB)	Cable Loss (dB)	Reading (dBuV)	Emission Level (dBuV)	Limits (dBuV)	Margin (dB)	Remark
1	0.346	9.89	0.23	26.35	36.47	49.05	12.58	Average
2	0.346	9.89	0.23	36.97	47.09	59.05	11.96	QP
3	0.486	9.83	0.23	26.18	36.24	46.23	9.99	Average
4	0.486	9.83	0.23	36.82	46.88	56.23	9.35	QP
5	0.582	9.82	0.23	25.15	35.20	46.00	10.80	Average
6	0.582	9.82	0.23	34.90	44.95	56.00	11.05	QP
7	0.822	9.81	0.24	19.31	29.36	46.00	16.64	Average
8	0.822	9.81	0.24	29.74	39.79	56.00	16.21	QP
9	1.289	9.80	0.25	16.75	26.80	46.00	19.20	Average
10	1.289	9.80	0.25	27.73	37.78	56.00	18.22	QP
11	3.881	9.82	0.27	19.35	29.44	46.00	16.56	Average
12	3.881	9.82	0.27	29.79	39.88	56.00	16.12	QP

Remarks: 1.Emission Level=LISN Factor+Cable Loss+Reading.
 2.If the average limit is met when using a quasi-peak detector, the EUT shall be deemed to meet both limits and measurement with average detector is unnecessary.

4. RADIATED EMISSION MEASUREMENT

4.1. Test Equipments

4.1.1. For frequency range 30MHz~1000MHz (In 10m Anechoic Chamber)

Item	Equipment	Manufacturer	Model No.	Serial No.	Last Cal.	Cal. Interval
1.	10m Chamber(NSA)	AUDIX	N/A	N/A	Apr.14,21	1 Year
2.	10m Chamber(SE)	AUDIX	N/A	N/A	Apr.15,18	5 Year
3.	Signal Analyzer	Rohde & Schwarz	FSV30	103669	Oct.11,20	1 Year
4.	Signal Analyzer	Rohde & Schwarz	FSV30	103670	Oct.11,20	1 Year
5.	EMI Test Receiver	Rohde & Schwarz	ESR3	101931	Apr.06,21	1 Year
6.	Amplifier	EMCI	EMC9135	980347	Apr.06,21	1 Year
7.	Amplifier	EMCI	EMC9135	980348	Mar.02,21	1 Year
8.	Tri-log-Broadband Antenna	Schwarzbeck	VULB 9168	429	Jul.06,20	1 Year
9.	Tri-log-Broadband Antenna	Schwarzbeck	VULB 9168	493	Aug.28,20	1 Year
10.	RF Cable	SPUMA	CFD400NL-LW	No.4	Apr.06,21	1 Year
11.	RF Cable	SPUMA	CFD400-NM-NM	160727+160728	Apr.06,21	1 Year
12.	Coaxial Switch	Anritsu	MP59B	6201397220	Apr.06,21	1 Year
13.	Coaxial Switch	Anritsu	MP59B	6201397221	Apr.06,21	1 Year
14.	Coaxial Switch	Anritsu	MP59B	6201397224	Apr.06,21	1 Year
15.	Test Software	AUDIX	e3	6.100913a	N/A	N/A

Note: N/A means Not applicable.

4.1.2. For frequency range 1GHz~6GHz (In 10m Anechoic Chamber)

Item	Equipment	Manufacturer	Model No.	Serial No.	Last Cal.	Cal. Interval
1.	10m Chamber(Svswr)	AUDIX	N/A	N/A	Apr.11,21	1 Year
2.	10m Chamber(SE)	AUDIX	N/A	N/A	Apr.15,18	5 Year
3.	Signal Analyzer	Rohde & Schwarz	FSV30	103670	Oct.11,20	1 Year
4.	Horn Antenna	ETS	3117	00218552	Dec.09,20	1 Year
5.	Amplifier	KEYSIGHT	83017A	39500711	Apr.06,21	1 Year
6.	RF Cable	ETS	SMS-100-SMS-350IN	NO.1	Apr.06,21	1 Year
7.	Test Software	AUDIX	e3	6.100913a	N/A	N/A

Note: N/A means Not applicable.

4.2. Block Diagram of Test Setup

4.2.1. In 10m Anechoic Chamber Test Setup Diagram for 30-1000MHz

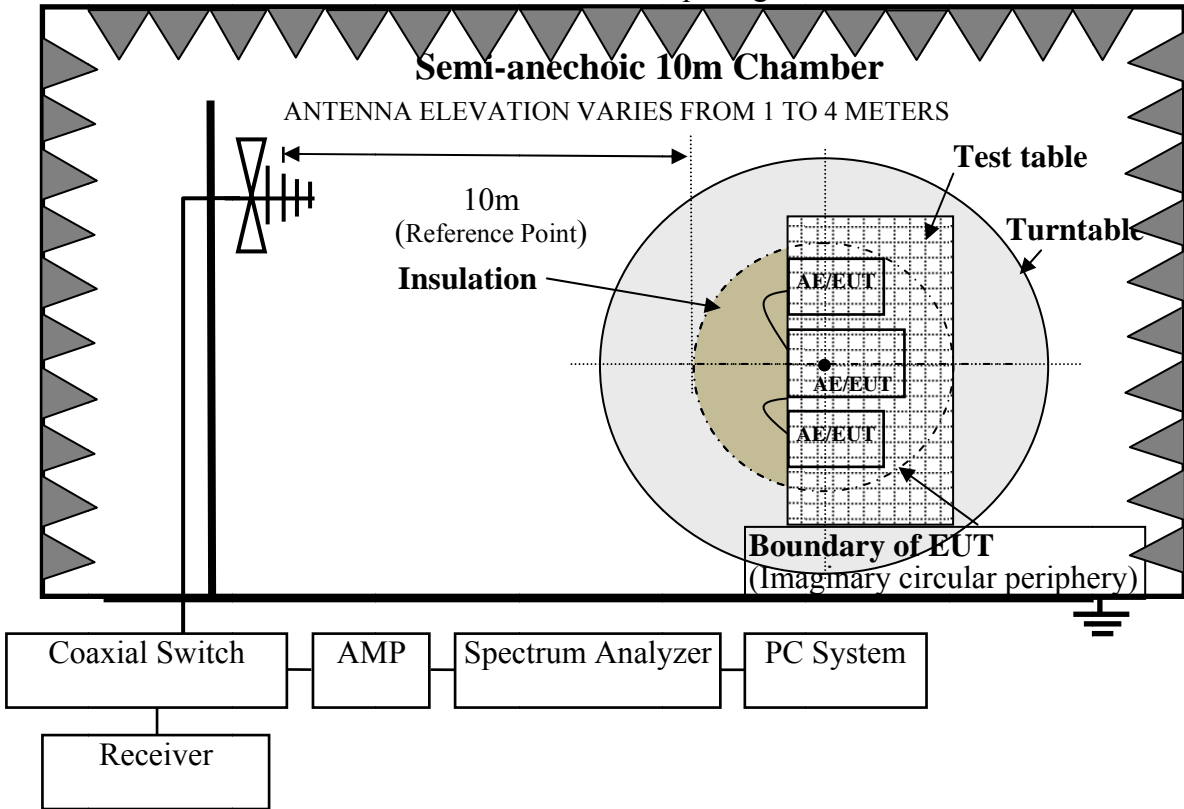

4.2.2. In 10m Anechoic Chamber Test Setup Diagram for 1-6GHz

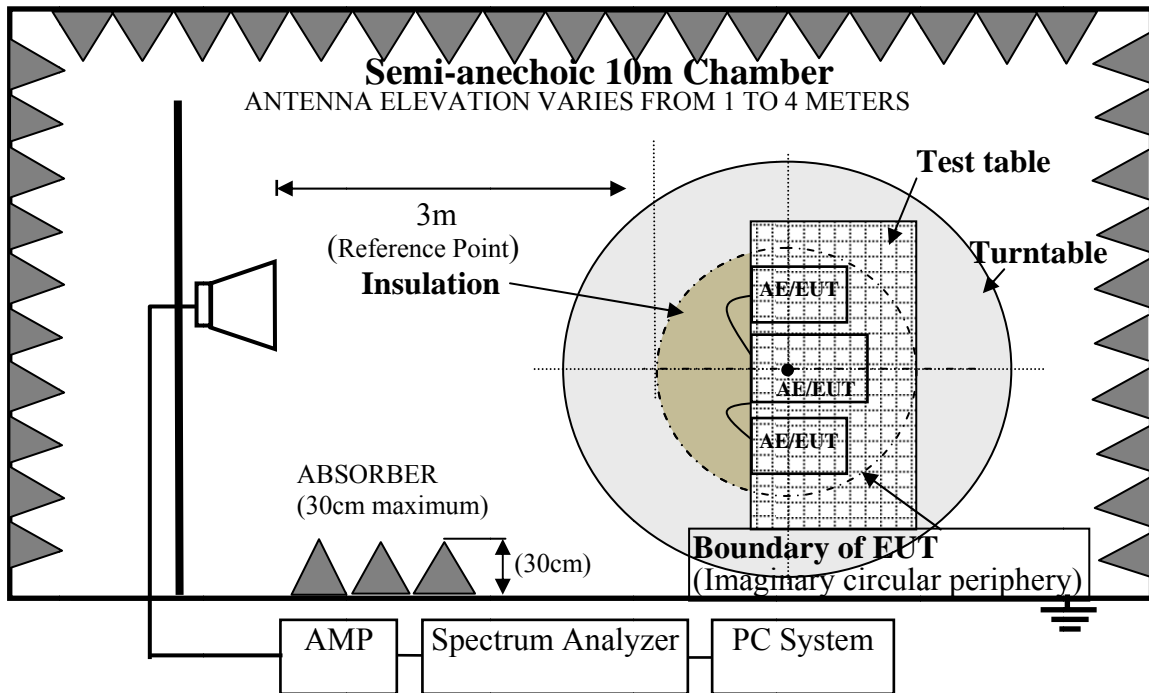

4.3. Test Standard

- EN 55032: 2015(Class B)
- EN 55032: 2015+AC: 2016
- EN 55032: 2015+A11: 2020
- BS EN 55032: 2015
- BS EN 55032: 2015+A11: 2020

4.4. Radiated Emission Class B Limit

All emanations from a Class B computing devices or system, including any network of conductors and apparatus connected thereto, shall not exceed the level of field strengths specified below:

Frequency (MHz)	Distance (Meters)	Field Strengths Limits (dB μ V/m)
30~230	10	30
230~1000	10	37
1000~3000	3	70(Peak) 50(Average)
3000~6000	3	74(Peak) 54(Average)

- Notes: (1) Emission level (dB μ V/m) = Antenna Factor (dB/m) + Cable Loss (dB) + Reading (dB μ V) (30MHz~1000MHz);
 Emission level (dB μ V/m) =Antenna Factor (dB/m) - Amp Factor (dB) + Cable Loss (dB) + Reading (dB μ V) (above 1000MHz).
 (2) The lower limit shall apply at the transition frequencies.

4.5. EUT Configuration on Test

The configurations of EUT are listed in Section 3.5.

4.6. Operating Condition of EUT

Same as Conducted Emission test that listed in Section 3.6. Except the test set up replaced by Section 4.2.

4.7. Test Procedure

The EUT was placed on a non-metallic table, 80 cm above the ground plane measurement distance was 10m at a semi-anechoic chamber. An antenna was located 10m from the periphery of test system on an adjustable mast. A pre-scan was first performed in order to find prominent radiated emissions. For final emissions measurements at each frequency of interest, the EUT were rotated and the antenna height was varied between 1m and 4m in order to maximize the emission. measurements in both horizontal and vertical polarities were made and the data was recorded. In order to find the maximum emission, the relative positions of equipments and all the interface cables were changed according to EN 55032 Class B on radiated emission test.

The bandwidth setting on the test receiver (R&S ESR3) is 120 kHz.

The resolution bandwidth of the Spectrum Analyzer FSV30 was set at 1MHz. (For above 1GHz)

The frequency range from 30MHz to 1000MHz was pre-scanned with a peak detector and all final readings of measurement from Test Receiver are Quasi-Peak values.

The frequency range from 1GHz to 6GHz was checked and all final readings of measurement were with Peak and Average detector, measurement distance was 3m at semi-anechoic chamber. The EUT were rotated and the antenna height was varied between 1m and 4m in order to maximize the emission. The portion of the test volume that was obstructed by absorber placed on the floor (30cm maximum).

Finally, selected operating situations at Anechoic Chamber measurement, all the test results are listed in section 4.8.

4.8. Radiated Emission Test Results

PASS. (All emissions not reported below are too low against the prescribed limits.)

EUT: LCD Monitor Model No. : AG274U

For frequency range 30MHz~1000MHz

The EUT with following test modes were pre-tested:

No.	Adapter	Test Voltage	Test Mode	Input Port	Cable Length	Resolution & Frequency	
1.	Adapter#1: ADP-230JB D	AC 230V/50Hz	PC Mode	DP	1.8m	640*480@60Hz	
2.						1280*1024@75Hz	
3.						3840*2160@144Hz	
4.					1.5m	3840*2160@144Hz	
5.					1.8m	640*480@60Hz	
6.						1280*1024@75Hz	
7.				3840*2160@144Hz			
8.				HDMI 2	1.8m	640*480@60Hz	
9.						1280*1024@75Hz	
10.						3840*2160@144Hz	
11.				Type-C	1.8m	640*480@60Hz	
12.						1280*1024@75Hz	
13.						3840*2160@120Hz	
14.				DVD Mode	HDMI 1/2	1.8m	Color Bar
15.				Standby	---	---	---
16.				R Load	Type-C	1.8m	5V/3A
17.							15V/3A
18.							20V/3.25A
19.				AC 110V/60Hz	PC Mode	DP	1.8m
20.	Adapter#2: FSP 230-AJAN3	AC 230V/50Hz	PC Mode	DP	1.8m	640*480@60Hz	
21.						1280*1024@75Hz	
22.						3840*2160@144Hz	
23.					1.5m	3840*2160@144Hz	
24.					1.8m	640*480@60Hz	
25.						1280*1024@75Hz	
26.				3840*2160@144Hz			
27.				HDMI 2	1.8m	640*480@60Hz	
28.						1280*1024@75Hz	
29.						3840*2160@144Hz	
30.				Type-C	1.8m	640*480@60Hz	
31.						1280*1024@75Hz	
32.						3840*2160@120Hz	
33.				DVD Mode	HDMI 1/2	1.8m	Color Bar
34.				Standby	---	---	---
35.				R Load	Type-C	1.8m	5V/3A
36.							15V/3A
37.							20V/3.25A
38.				AC 110V/60Hz	PC Mode	DP	1.8m

The result of worst test mode is presented in the report as below and the test data are listed in next pages.

No.	Adapter	Test Voltage	Cable Length	Test Mode	Input Port	Resolution & Frequency	Reference Test Data No.	
							Horizontal	Vertical
1.*	ADP-230JB D	AC 230V/50Hz	1.8m	PC (Running ITU-R BT 1729)	HDMI 1	3840*2160@144Hz	#44	#43
2.				PC (Running ITU-R BT 471-1)				

(* means the worst test mode)

For frequency range 1GHz~6GHz

The EUT with following test modes were pre-tested:

No.	Adapter	Test Voltage	Test Mode	Input Port	Cable Length	Resolution & Frequency	
1.	Adapter#1: ADP-230JB D	AC 230V/50Hz	PC Mode	DP	1.8m	1280*1024@75Hz	
2.						3840*2160@144Hz	
3.					1.5m	3840*2160@144Hz	
4.				HDMI 1	1.8m	1280*1024@75Hz	
5.						3840*2160@144Hz	
6.				HDMI 2	1.8m	1280*1024@75Hz	
7.						3840*2160@144Hz	
8.				Type-C	1.8m	1280*1024@75Hz	
9.						3840*2160@120Hz	
10.				DVD Mode	HDMI 1/2	1.8m	Color Bar
11.				Standby	---	---	---
12.				R Load	Type-C	1.8m	15V/3A
13.							20V/3.25A
14.				AC 110V/60Hz	PC Mode	DP	1.8m
15.	Adapter#2: FSP 230-AJAN3	AC 230V/50Hz	PC Mode	DP	1.8m	1280*1024@75Hz	
16.						3840*2160@144Hz	
17.					1.5m	3840*2160@144Hz	
18.				HDMI 1	1.8m	1280*1024@75Hz	
19.						3840*2160@144Hz	
20.				HDMI 2	1.8m	1280*1024@75Hz	
21.						3840*2160@144Hz	
22.				Type-C	1.8m	1280*1024@75Hz	
23.						3840*2160@120Hz	
24.				DVD Mode	HDMI 1/2	1.8m	Color Bar
25.				Standby	---	---	---
26.				R Load	Type-C	1.8m	15V/3A
27.							20V/3.25A
28.				AC 110V/60Hz	PC Mode	DP	1.8m

The result of worst test mode is presented in the report as below and the test data are listed in next pages.

No.	Adapter	Test Voltage	Cable Length	Test Mode	Input Port	Resolution & Frequency	Reference Test Data No.	
							Horizontal	Vertical
1.*	ADP-230JB D	AC 230V/50Hz	1.8m	PC (Running ITU-R BT 1729)	HDMI 1	3840*2160@144Hz	#2	#1
2.				PC (Running ITU-R BT 471-1)				

(* means the worst test mode)

Data: 44

File: E:\2021 Report Data\T\TPVA1Z2102055.EM6 (214)

Date: 2021-06-20

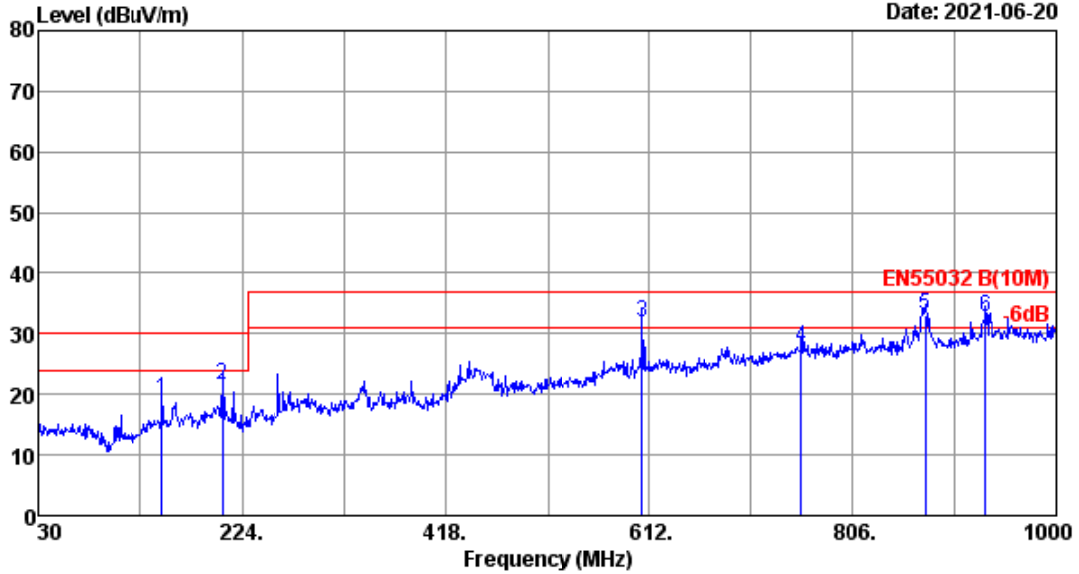

Site no.	: 10m Chamber	Data no.	: 44
Dis. / Ant.	: 10m 2020 VULB9168-429	Ant. pol.	: HORIZONTAL
Limit	: EN55032 B(10M)	Pressure	: 101.6kPa
Env. / Ins.	: 21.6°C/48%	Engineer	: Dream
EUT	: M/N:AG274U		
Power rating	: AC 230V/50Hz		
Test Mode	: Running ITU-R BT 1729		
	HDMI1:3840*2160@144Hz		
	Line:1.8m		

No.	Freq. (MHz)	Ant. Factor (dB/m)	Cable Loss (dB)	Reading (dBuV)	Emission Level (dBuV/m)	Limits (dBuV/m)	Margin (dB)	Remark
1	148.340	19.40	1.13	-1.30	19.23	30.00	10.77	QP
2	205.570	15.50	1.19	4.76	21.45	30.00	8.55	QP
3	605.210	25.70	2.93	3.24	31.87	37.00	5.13	QP
4	756.530	28.00	3.68	-4.04	27.64	37.00	9.36	QP
5	874.870	28.90	3.74	0.28	32.92	37.00	4.08	QP*
6	932.100	29.70	3.75	-0.81	32.64	37.00	4.36	QP

- Remarks:
1. Emission Level= Antenna Factor + Cable Loss + Reading.
 2. The emission levels that are 20dB below the official limit are not reported.
 3. The worst emission was detected at 874.870MHz with corrected signal level of 32.92dBuV/m. (Antenna height 2.4m; Turntable degree 123°).
 4. 0° was the table front facing the antenna. Degree is calculated from 0°clockwise facing the antenna.

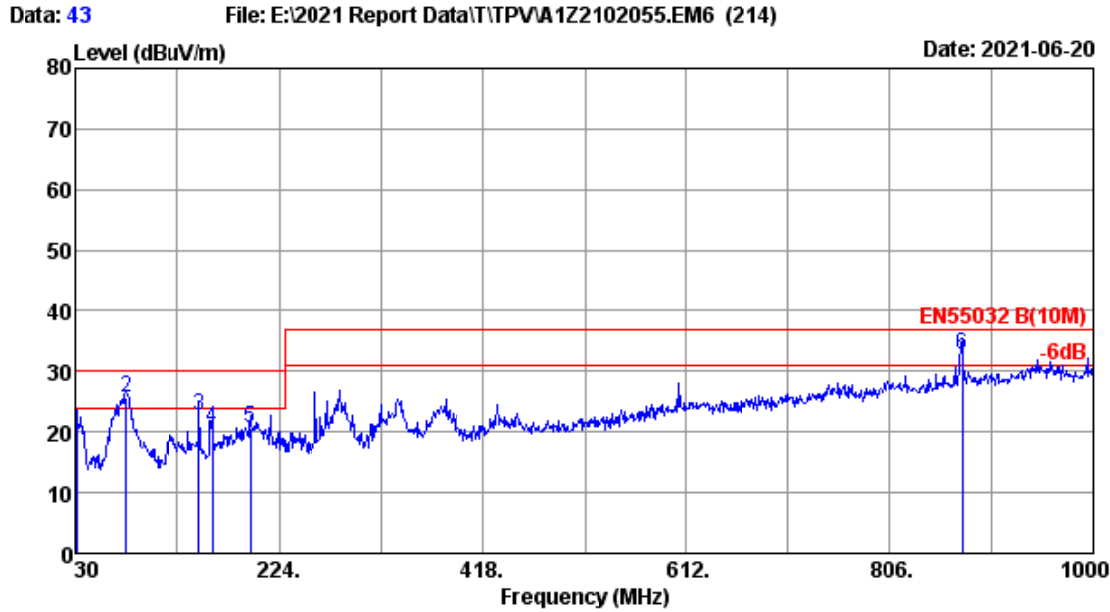

Site no.	: 10m Chamber	Data no.	: 43
Dis. / Ant.	: 10m 2020 VULB9168-493	Ant. pol.	: VERTICAL
Limit	: EN55032 B(10M)	Pressure	: 101.6kPa
Env. / Ins.	: 21.6°C/48%	Engineer	: Dream
EUT	: M/N:AG274U		
Power rating	: AC 230V/50Hz		
Test Mode	: Running ITU-R BT 1729		
	HDMI1:3840*2160@144Hz		
	Line:1.8m		

No.	Freq. (MHz)	Ant. Factor (dB/m)	Cable Loss (dB)	Emission				Remark
				Reading (dBuV)	Level (dBuV/m)	Limits (dBuV/m)	Margin (dB)	
1	30.970	18.40	0.89	2.25	21.54	30.00	8.46	QP
2	78.500	14.95	1.31	9.42	25.68	30.00	4.32	QP
3	148.340	19.30	1.75	1.61	22.66	30.00	7.34	QP
4	160.950	19.10	1.81	-0.13	20.78	30.00	9.22	QP
5	196.840	15.90	1.98	2.85	20.73	30.00	9.27	QP
6	874.870	28.90	4.72	-0.80	32.82	37.00	4.18	QP*

- Remarks:
1. Emission Level= Antenna Factor + Cable Loss + Reading.
 2. The emission levels that are 20dB below the official limit are not reported.
 3. The worst emission was detected at 874.870MHz with corrected signal level of 32.82dBμV/m. (Antenna height 0.25m; Turntable degree 325°).
 4. 0° was the table front facing the antenna. Degree is calculated from 0°clockwise facing the antenna

Data: 46

File: E:\2021 Report Data\T\TPVA1Z2102055.EM6 (214)

Date: 2021-06-20

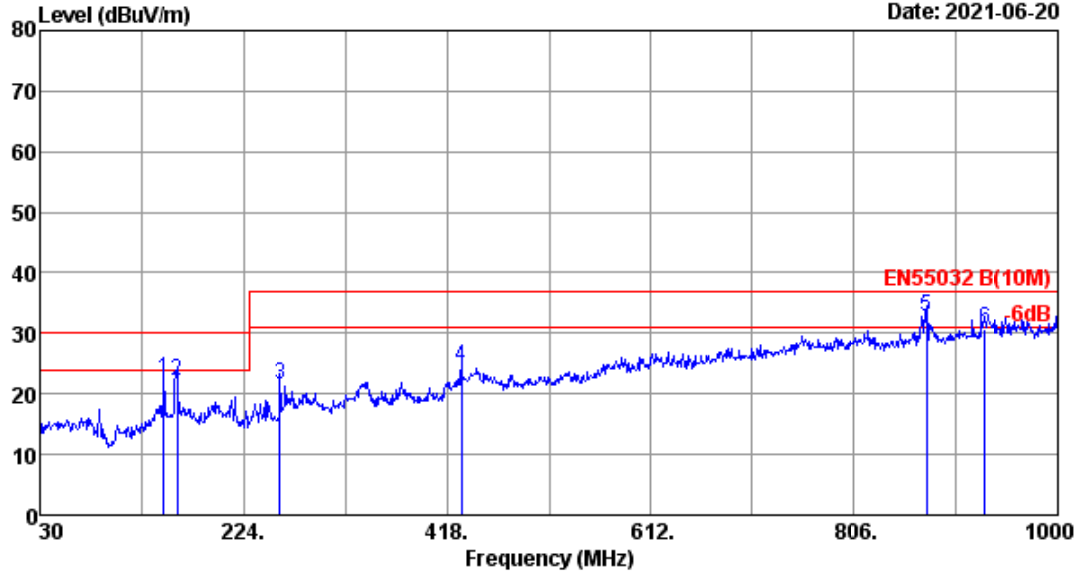

Site no.	: 10m Chamber	Data no.	: 46
Dis. / Ant.	: 10m 2020 VULB9168-429	Ant. pol.	: HORIZONTAL
Limit	: EN55032 B(10M)	Pressure	: 101.6kPa
Env. / Ins.	: 21.6°C/48%	Engineer	: Dream
EUT	: M/N:AG274U		
Power rating	: AC 230V/50Hz		
Test Mode	: Running ITU-R BT 471-1		
	HDMI1:3840*2160@144Hz		
	Line:1.8m		

No.	Freq. (MHz)	Ant. Factor (dB/m)	Cable Loss (dB)	Emission		Limits (dBuV/m)	Margin (dB)	Remark
				Reading (dBuV)	Level (dBuV/m)			
1	148.340	19.40	1.13	1.99	22.52	30.00	7.48	QP
2	160.950	19.10	1.14	1.80	22.04	30.00	7.96	QP
3	258.920	17.70	1.56	2.20	21.46	37.00	15.54	QP
4	431.580	22.47	2.23	-0.32	24.38	37.00	12.62	QP
5	874.870	28.90	3.74	0.03	32.67	37.00	4.33	QP
6	930.160	29.70	3.75	-2.74	30.71	37.00	6.29	QP

Remarks: 1. Emission Level= Antenna Factor + Cable Loss + Reading.
 2. The emission levels that are 20dB below the official limit are not reported.

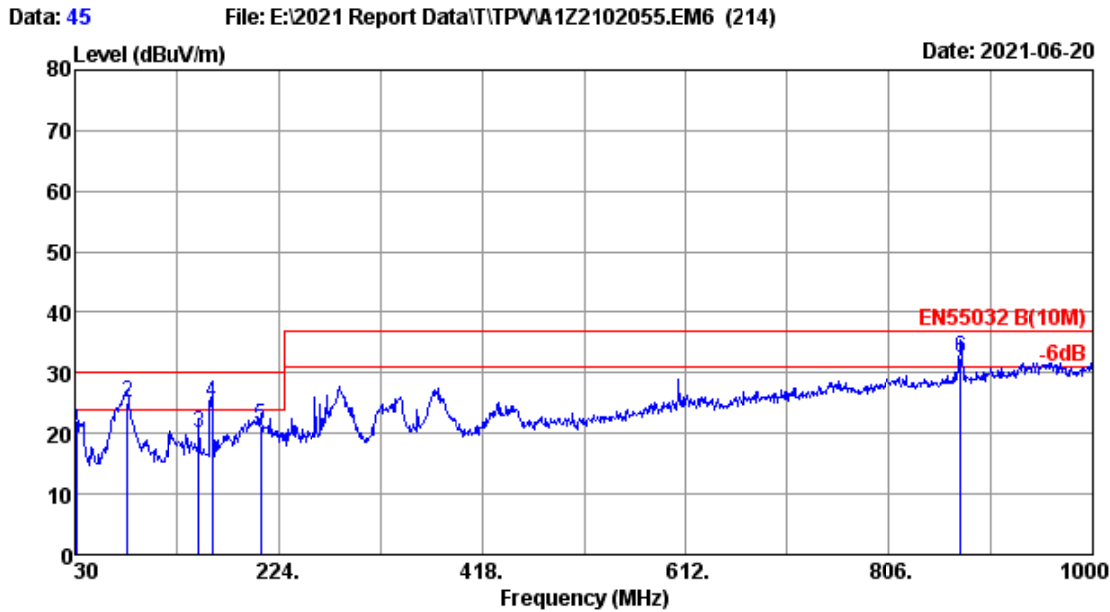

Site no.	: 10m Chamber	Data no.	: 45
Dis. / Ant.	: 10m 2020 VULB9168-493	Ant. pol.	: VERTICAL
Limit	: EN55032 B(10M)	Pressure	: 101.6kPa
Env. / Ins.	: 21.6°C/48%	Engineer	: Dream
EUT	: M/N:AG274U		
Power rating	: AC 230V/50Hz		
Test Mode	: Running ITU-R BT 471-1		
	HDMI1:3840*2160@144Hz		
	Line:1.8m		

No.	Freq. (MHz)	Ant. Factor (dB/m)	Cable Loss (dB)	Emission				Remark
				Reading (dBuV)	Level (dBuV/m)	Limits (dBuV/m)	Margin (dB)	
1	30.970	18.40	0.89	2.77	22.06	30.00	7.94	QP
2	79.470	14.70	1.32	9.07	25.09	30.00	4.91	QP
3	148.340	19.30	1.75	-1.01	20.04	30.00	9.96	QP
4	160.950	19.10	1.81	4.23	25.14	30.00	4.86	QP
5	206.540	15.60	1.99	3.70	21.29	30.00	8.71	QP
6	873.900	28.90	4.72	-1.06	32.56	37.00	4.44	QP

Remarks: 1. Emission Level= Antenna Factor + Cable Loss + Reading.
 2. The emission levels that are 20dB below the official limit are not reported.

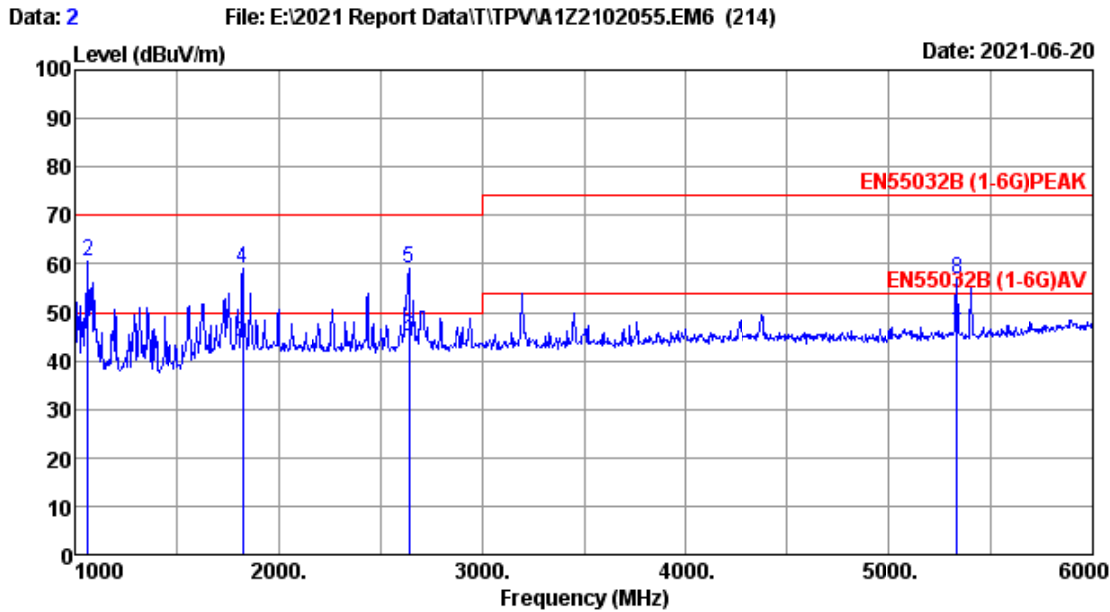

Site no.	: 10m Chamber	Data no.	: 2
Dis. / Ant.	: 3m 2020 3117	Ant. pol.	: HORIZONTAL
Limit	: EN55032B (1-6G)PEAK	Pressure	: 101.4kPa
Env. / Ins.	: 22.3°C/46%	Engineer	: Fire
EUT	: M/N:AG274U		
Power rating	: AC 230V/50Hz		
Test Mode	: Running ITU-R BT 1729		
	HDMI1:3840*2160@144Hz		
	Line:1.8m		

No.	Freq. (MHz)	Ant. Factor (dB/m)	Cable Loss (dB)	AMP factor (dB)	Reading (dBuV)	Emission			Remark
						Level (dBuV/m)	Limits (dBuV/m)	Margin (dB)	
1	1062.635	26.93	2.68	34.91	48.32	43.02	50.00	6.98	Average
2	1065.442	26.93	2.68	34.91	65.78	60.48	70.00	9.52	Peak
3	1822.635	30.68	3.52	32.82	42.14	43.52	50.00	6.48	Average
4	1825.416	30.80	3.53	32.77	57.34	58.90	70.00	11.10	Peak
5	2640.419	32.26	4.23	31.80	54.49	59.18	70.00	10.82	Peak
6	2642.635	32.28	4.25	31.78	40.15	44.90	50.00	5.10	Average
7	5332.635	34.37	6.27	30.57	35.15	45.22	54.00	8.78	Average
8	5335.416	34.37	6.27	30.57	46.66	56.73	74.00	17.27	Peak

Remarks: 1. Emission Level= Antenna Factor + Cable Loss + Reading - Amp Factor
 2. The emission levels that are 20dB below the official limit are not reported.

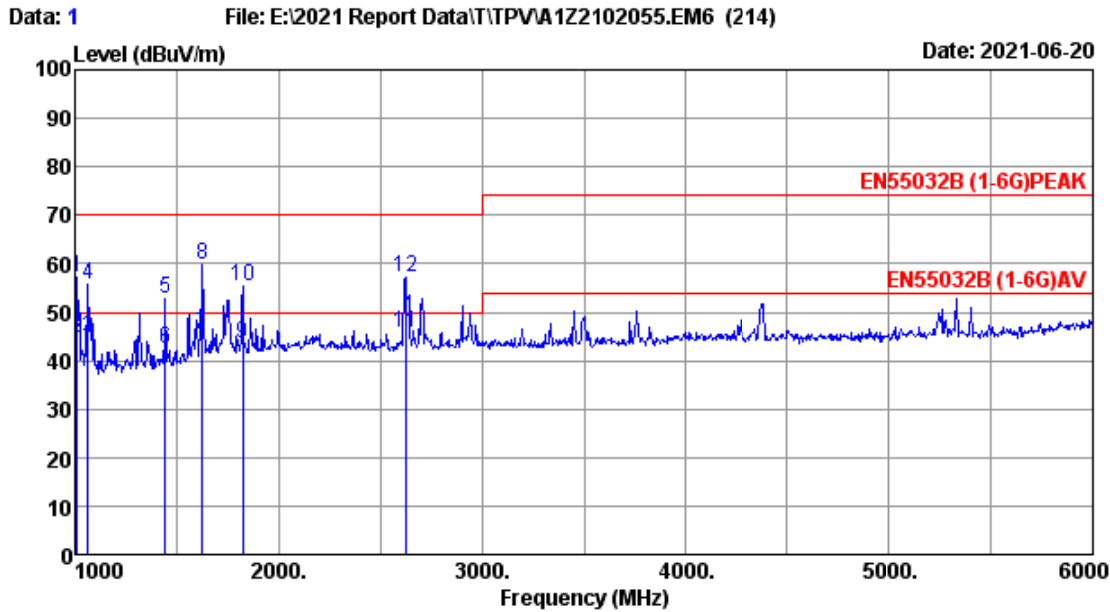

Site no.	: 10m Chamber	Data no.	: 1
Dis. / Ant.	: 3m 2020 3117	Ant. pol.	: VERTICAL
Limit	: EN55032B (1-6G) PEAK	Pressure	: 101.4kPa
Env. / Ins.	: 22.3°C/46%	Engineer	: Fire
EUT	: M/N:AG274U		
Power rating	: AC 230V/50Hz		
Test Mode	: Running ITU-R BT 1729		
	HDMI1:3840*2160@144Hz		
	Line:1.8m		

No.	Freq. (MHz)	Ant. Factor (dB/m)	Cable Loss (dB)	AMP factor (dB)	Reading (dBuV)	Emission Level (dBuV/m)	Limits (dBuV/m)	Margin (dB)	Remark
1	1010.412	26.76	2.62	35.05	62.84	57.17	70.00	12.83	Peak
2	1012.965	26.76	2.62	35.05	50.23	44.56	50.00	5.44	Average
3	1062.448	26.93	2.68	34.91	50.11	44.81	50.00	5.19	Average
4	1065.419	26.93	2.68	34.91	60.84	55.54	70.00	14.46	Peak
5	1440.416	28.22	3.14	33.87	55.32	52.81	70.00	17.19	Peak
6	1442.635	28.22	3.14	33.87	45.13	42.62	50.00	7.38	Average
7	1622.635	29.36	3.33	33.34	46.15	45.50	50.00	4.50	Average
8	1625.416	29.36	3.33	33.34	60.37	59.72	70.00	10.28	Peak
9	1822.635	30.68	3.52	32.82	42.12	43.50	50.00	6.50	Average
10	1825.745	30.80	3.53	32.77	53.77	55.33	70.00	14.67	Peak
11	2622.656	32.24	4.22	31.81	41.14	45.79	50.00	4.21	Average
12	2625.542	32.26	4.23	31.80	52.49	57.18	70.00	12.82	Peak

Remarks: 1. Emission Level= Antenna Factor + Cable Loss + Reading - Amp Factor
 2. The emission levels that are 20dB below the official limit are not reported.

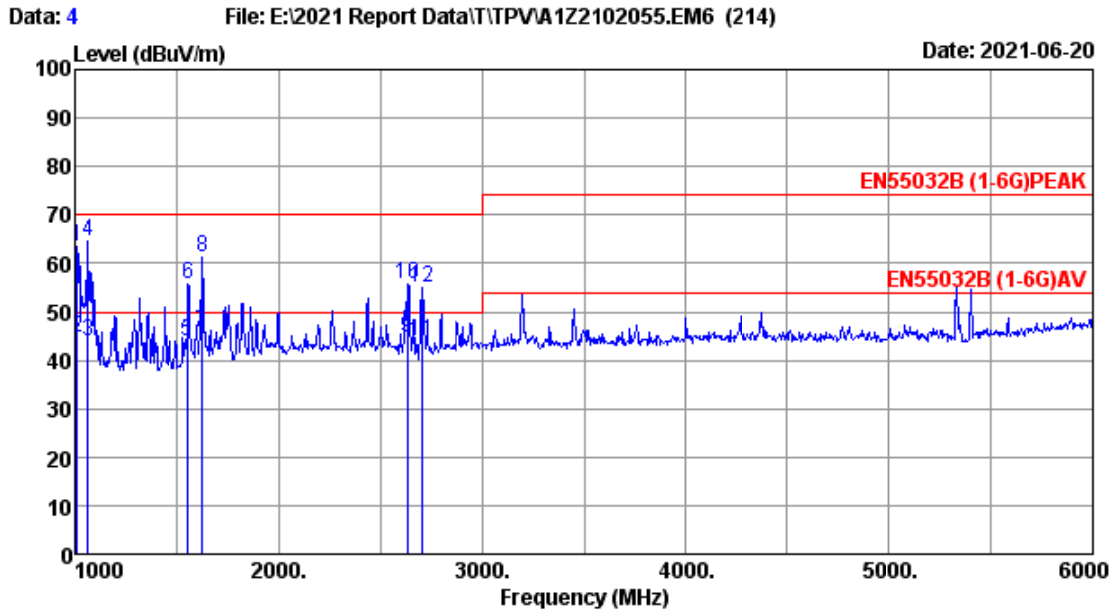

Site no.	: 10m Chamber	Data no.	: 4
Dis. / Ant.	: 3m 2020 3117	Ant. pol.	: HORIZONTAL
Limit	: EN55032B (1-6G)PEAK	Pressure	: 101.4kPa
Env. / Ins.	: 22.3°C/46%	Engineer	: Fire
EUT	: M/N:AG274U		
Power rating	: AC 230V/50Hz		
Test Mode	: Running ITU-R BT 471-1		
	HDMI1:3840*2160@144Hz		
	Line:1.8m		

No.	Freq. (MHz)	Ant. Factor (dB/m)	Cable Loss (dB)	AMP factor (dB)	Reading (dBuV)	Emission Level (dBuV/m)	Limits (dBuV/m)	Margin (dB)	Remark
1	1010.634	26.76	2.62	35.05	68.99	63.32	70.00	6.68	Peak
2	1012.545	26.76	2.62	35.05	50.16	44.49	50.00	5.51	Average
3	1062.548	26.93	2.68	34.91	49.16	43.86	50.00	6.14	Average
4	1065.629	26.93	2.68	34.91	69.73	64.43	70.00	5.57	Peak
5	1552.635	28.88	3.27	33.53	45.14	43.76	50.00	6.24	Average
6	1555.745	28.88	3.27	33.53	57.13	55.75	70.00	14.25	Peak
7	1622.548	29.36	3.33	33.34	46.23	45.58	50.00	4.42	Average
8	1625.419	29.36	3.33	33.34	61.85	61.20	70.00	8.80	Peak
9	2632.968	32.26	4.23	31.80	40.03	44.72	50.00	5.28	Average
10	2635.516	32.26	4.23	31.80	51.01	55.70	70.00	14.30	Peak
11	2702.659	32.34	4.30	31.74	39.02	43.92	50.00	6.08	Average
12	2705.075	32.34	4.30	31.74	50.26	55.16	70.00	14.84	Peak

Remarks: 1. Emission Level= Antenna Factor + Cable Loss + Reading - Amp Factor
 2. The emission levels that are 20dB below the official limit are not reported.

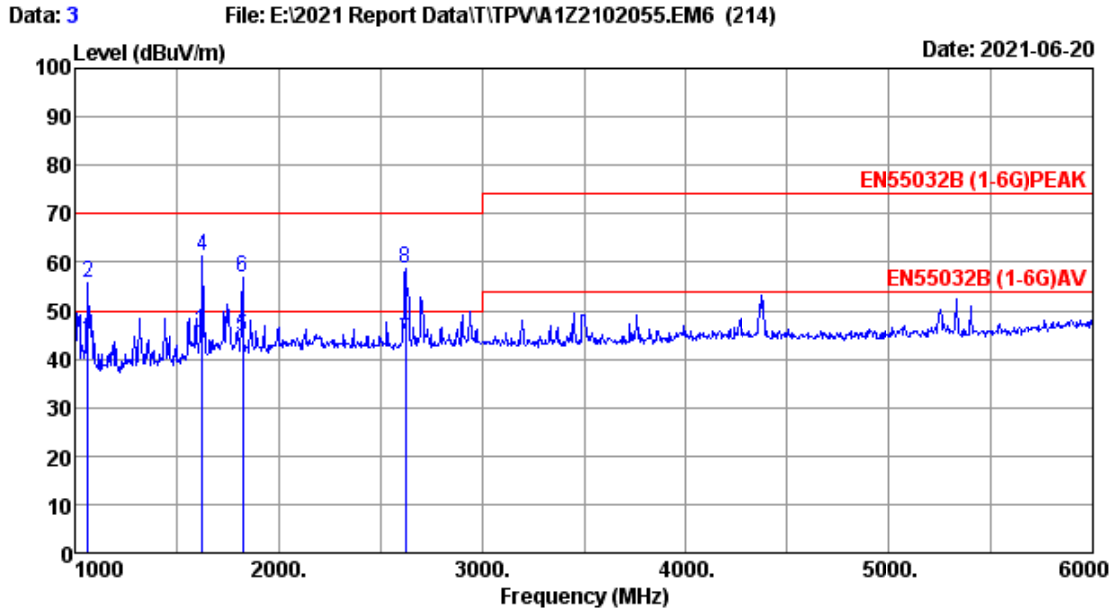

Site no.	: 10m Chamber	Data no.	: 3
Dis. / Ant.	: 3m 2020 3117	Ant. pol.	: VERTICAL
Limit	: EN55032B (1-6G)PEAK	Pressure	: 101.4kPa
Env. / Ins.	: 22.3°C/46%	Engineer	: Fire
EUT	: M/N:AG274U		
Power rating	: AC 230V/50Hz		
Test Mode	: Running ITU-R BT 471-1		
	HDMI1:3840*2160@144Hz		
	Line:1.8m		

No.	Freq. (MHz)	Ant. Factor (dB/m)	Cable Loss (dB)	AMP factor (dB)	Reading (dBuV)	Emission Level (dBuV/m)	Limits (dBuV/m)	Margin (dB)	Remark
1	1062.635	26.93	2.68	34.91	49.33	44.03	50.00	5.97	Average
2	1065.749	26.93	2.68	34.91	61.09	55.79	70.00	14.21	Peak
3	1622.516	29.36	3.33	33.34	46.02	45.37	50.00	4.63	Average
4	1625.635	29.36	3.33	33.34	61.75	61.10	70.00	8.90	Peak
5	1822.748	30.68	3.52	32.82	43.14	44.52	50.00	5.48	Average
6	1825.640	30.80	3.53	32.77	55.13	56.69	70.00	13.31	Peak
7	2622.848	32.24	4.22	31.81	39.12	43.77	50.00	6.23	Average
8	2625.418	32.26	4.23	31.80	53.94	58.63	70.00	11.37	Peak

Remarks: 1. Emission Level= Antenna Factor + Cable Loss + Reading - Amp Factor
 2. The emission levels that are 20dB below the official limit are not reported.

5. HARMONIC CURRENT TEST

5.1. Test Equipments

Item	Equipment	Manufacturer	Model No.	Serial No.	Last Cal.	Cal. Interval
1.	H/F Room	AUDIX	N/A	N/A	Apr.16,19	3 Year
2.	AC Power Source	California Instruments	5001ix	58481	Oct.12,20	1 Year
3.	Impedance Network	California Instruments	OMNI 1-18i	1247A02235	Oct.12,20	1 Year
4.	Power Analyzer	California Instruments	PACS-1	72627	Oct.12,20	1 Year
5.	Test Software	California Instruments	CTS 4.0	V 4.26	N/A	N/A

Note: N/A means Not applicable.

5.2. Block Diagram of Test Setup

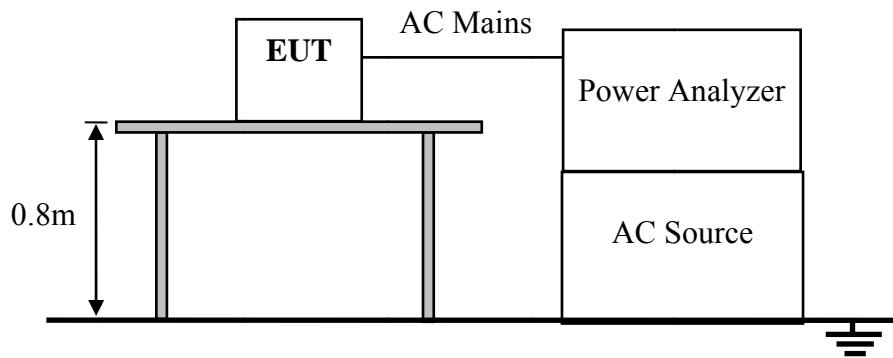

5.3. Test Standard

- EN 61000-3-2: 2014
- IEC 61000-3-2: 2014
- EN IEC 61000-3-2: 2019
- IEC 61000-3-2: 2018
- BS EN 61000-3-2: 2014;
- BS EN IEC 61000-3-2: 2019; Class D

5.4. Limits of Harmonic Current

Limits for Class D Equipment		
Harmonic order (n)	Maximum permissible harmonic current per watt (mA/W)	Maximum permissible harmonic current (A)
3	3.4	2.30
5	1.9	1.14
7	1.0	0.77
9	0.5	0.40
11	0.35	0.33
13	0.30	0.21
15 ≤ n ≤ 39 (odd harmonic only)	3.85/n	0.15 × 15/n

Remark: if the EUT Power level is below 75 Watts and therefore has no defined limits.

5.5. EUT Configuration on Test

The configurations of EUT are listed in Section 3.5.

5.6. Operating Condition of EUT

Same as Conducted Emission test that listed in Section 3.6. except the test set up replaced by Section 5.2.

5.7. Test Procedure

The EUT was placed on the top of a wooden table 0.8 meters above the ground and operated to produce the maximum harmonic components under normal operating conditions for each successive harmonic component in turn. The correspondent test program of test instrument to measure the current harmonics emanated from EUT is chosen. The measure time shall be not less than the necessary for the EUT to be exercised.

5.8. Test Results

PASS. (Test results are recorded in next page)

+Harmonics – Class-D per Ed. 5.0 (2018)(Run time)

EUT: M/N:AG274U
 Test category: Class-D per Ed. 5.0 (2018) (European limits)
 Test date: 2021-4-2
 Test duration (min): 2.5
 Comment: Running "H" Pattern And 1KHz Playing
 Customer: TPV

Tested by: Kennen
 Test Margin: 100
 Start time: 14:58:32
 End time: 15:01:13
 Data file name: H-001012.cts_data

Test Result: Pass Source qualification: Normal

Current & voltage waveforms

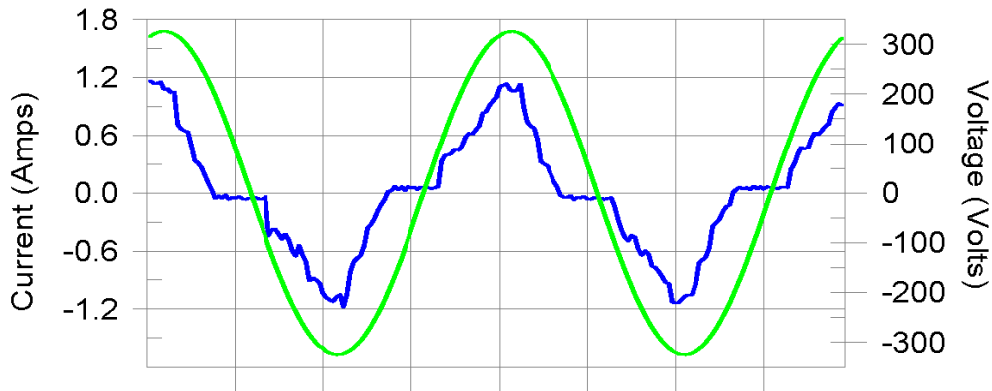

Harmonics and Class D limit line European Limits

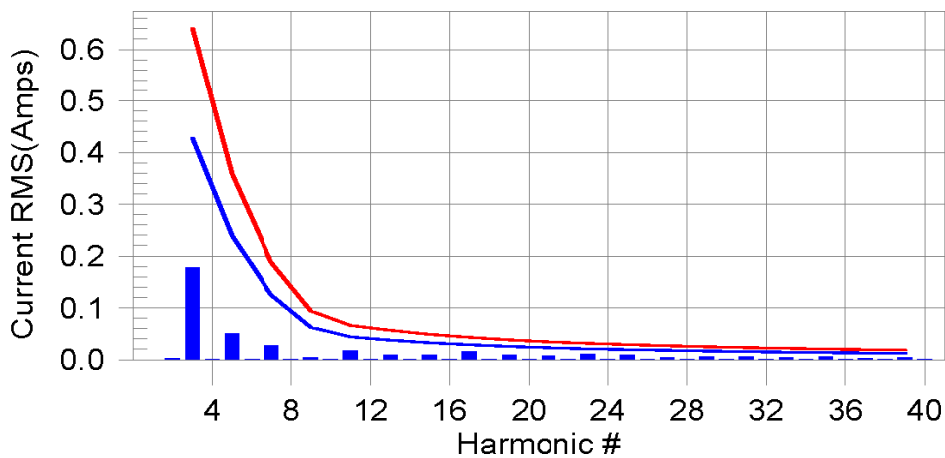

Test result: Pass **Worst harmonics H17-55.3% of 150% limit, H17-56% of 100% limit**

Current Test Result Summary (Run time)

EUT: M/N:AG274U Tested by: Kennen
 Test category: Class-D per Ed. 5.0 (2018) (European limits) Test Margin: 100
 Test date: 2021-4-2 Start time: 14:58:32 End time: 15:01:13
 Test duration (min): 2.5 Data file name: H-001012.cts_data
 Comment: Running "H" Pattern And 1KHz Playing
 Customer: TPV

Test Result: Pass Source qualification: Normal
 THC(A): 0.191 I-THD(%): 33.8 POHC(A): 0.021 POHC Limit(A): 0.054

Highest parameter values during test:

V_RMS (Volts): 230.07	Frequency(Hz): 50.00
I_Peak (Amps): 1.374	I_RMS (Amps): 0.602
I_Fund (Amps): 0.565	Crest Factor: 2.563
Power (Watts): 125.7	Power Factor: 0.909

Harm#	Harms(avg)	100%Limit	%of Limit	Harms(max)	150%Limit	%of Limit	Status
2	0.002	0.000	N/A	0.003	0.000	N/A	Pass
3	0.179	0.427	41.8	0.194	0.641	30.3	Pass
4	0.001	0.000	N/A	0.002	0.000	N/A	Pass
5	0.051	0.239	21.3	0.053	0.358	14.7	Pass
6	0.001	0.000	N/A	0.001	0.000	N/A	Pass
7	0.027	0.126	21.7	0.028	0.189	15.1	Pass
8	0.000	0.000	N/A	0.001	0.000	N/A	Pass
9	0.005	0.063	N/A	0.010	0.094	N/A	Pass
10	0.000	0.000	N/A	0.001	0.000	N/A	Pass
11	0.018	0.044	40.5	0.020	0.066	30.8	Pass
12	0.000	0.000	N/A	0.001	0.000	N/A	Pass
13	0.009	0.038	25.0	0.012	0.057	20.3	Pass
14	0.000	0.000	N/A	0.001	0.000	N/A	Pass
15	0.008	0.033	25.9	0.010	0.049	20.4	Pass
16	0.001	0.000	N/A	0.001	0.000	N/A	Pass
17	0.016	0.029	56.0	0.024	0.043	55.3	Pass
18	0.001	0.000	N/A	0.001	0.000	N/A	Pass
19	0.008	0.026	32.6	0.020	0.038	53.0	Pass
20	0.001	0.000	N/A	0.001	0.000	N/A	Pass
21	0.008	0.023	33.1	0.011	0.035	33.3	Pass
22	0.001	0.000	N/A	0.001	0.000	N/A	Pass
23	0.011	0.021	51.6	0.013	0.031	41.0	Pass
24	0.001	0.000	N/A	0.001	0.000	N/A	Pass
25	0.009	0.019	47.2	0.012	0.029	39.8	Pass
26	0.000	0.000	N/A	0.001	0.000	N/A	Pass
27	0.004	0.018	N/A	0.009	0.027	N/A	Pass
28	0.000	0.000	N/A	0.001	0.000	N/A	Pass
29	0.007	0.017	39.3	0.009	0.025	35.1	Pass
30	0.000	0.000	N/A	0.001	0.000	N/A	Pass
31	0.006	0.016	38.4	0.010	0.023	44.4	Pass
32	0.000	0.000	N/A	0.001	0.000	N/A	Pass
33	0.004	0.015	N/A	0.007	0.022	N/A	Pass
34	0.000	0.000	N/A	0.001	0.000	N/A	Pass
35	0.006	0.014	41.7	0.007	0.021	36.1	Pass
36	0.000	0.000	N/A	0.001	0.000	N/A	Pass
37	0.003	0.013	N/A	0.006	0.020	N/A	Pass
38	0.001	0.000	N/A	0.001	0.000	N/A	Pass
39	0.003	0.012	N/A	0.008	0.019	N/A	Pass
40	0.001	0.000	N/A	0.001	0.000	N/A	Pass

Note: Dynamic limits were applied for this test. The highest harmonics values in the above table may not occur at the same window as the maximum harmonics/limit ratio.

Voltage Source Verification Data (Run time)

EUT: M/N:AG274U Tested by: Kennen
 Test category: Class-D per Ed. 5.0 (2018) (European limits) Test Margin: 100
 Test date: 2021-4-2 Start time: 14:58:32 End time: 15:01:13
 Test duration (min): 2.5 Data file name: H-001012.cts_data
 Comment: Running "H" Pattern And 1KHz Playing
 Customer: TPV

Test Result: Pass Source qualification: Normal

Highest parameter values during test:

Voltage (Vrms): 230.07	Frequency(Hz): 50.00
I_Peak (Amps): 1.374	I_RMS (Amps): 0.602
I_Fund (Amps): 0.565	Crest Factor: 2.563
Power (Watts): 125.7	Power Factor: 0.909

Harm#	Harmonics V-rms	Limit V-rms	% of Limit	Status
2	0.093	0.460	20.28	OK
3	0.481	2.070	23.24	OK
4	0.062	0.460	13.53	OK
5	0.043	0.920	4.71	OK
6	0.035	0.460	7.70	OK
7	0.051	0.690	7.34	OK
8	0.019	0.460	4.14	OK
9	0.019	0.460	4.20	OK
10	0.017	0.460	3.79	OK
11	0.018	0.230	7.64	OK
12	0.021	0.230	9.00	OK
13	0.015	0.230	6.64	OK
14	0.011	0.230	4.71	OK
15	0.016	0.230	6.94	OK
16	0.014	0.230	5.98	OK
17	0.023	0.230	9.96	OK
18	0.017	0.230	7.29	OK
19	0.021	0.230	8.96	OK
20	0.014	0.230	6.11	OK
21	0.016	0.230	6.78	OK
22	0.007	0.230	2.83	OK
23	0.016	0.230	7.17	OK
24	0.008	0.230	3.69	OK
25	0.017	0.230	7.42	OK
26	0.007	0.230	2.83	OK
27	0.017	0.230	7.54	OK
28	0.008	0.230	3.45	OK
29	0.015	0.230	6.55	OK
30	0.007	0.230	3.11	OK
31	0.016	0.230	6.90	OK
32	0.007	0.230	3.02	OK
33	0.013	0.230	5.62	OK
34	0.007	0.230	2.95	OK
35	0.013	0.230	5.83	OK
36	0.006	0.230	2.63	OK
37	0.013	0.230	5.54	OK
38	0.006	0.230	2.59	OK
39	0.016	0.230	6.91	OK
40	0.006	0.230	2.62	OK

Harmonics – Class-D per Ed. 5.0 (2018)(Run time)

EUT: M/N:AG274U
 Test category: Class-D per Ed. 5.0 (2018) (European limits)
 Test date: 2021-4-2
 Test duration (min): 2.5
 Comment: Running "H" Pattern And 1KHz Playing (Type C:R Load)
 Customer: TPV

Tested by: Kennen
 Test Margin: 100
 Start time: 15:04:44
 End time: 15:07:26
 Data file name: H-001014.cts_data

Test Result: Pass Source qualification: Normal

Current & voltage waveforms

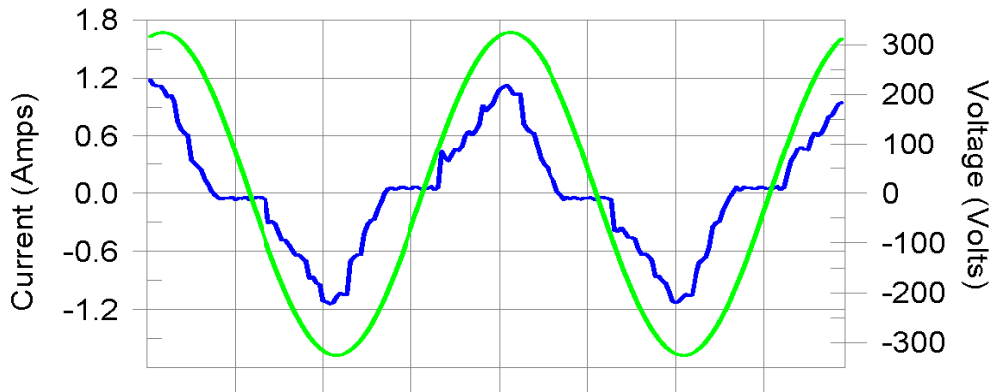

Harmonics and Class D limit line European Limits

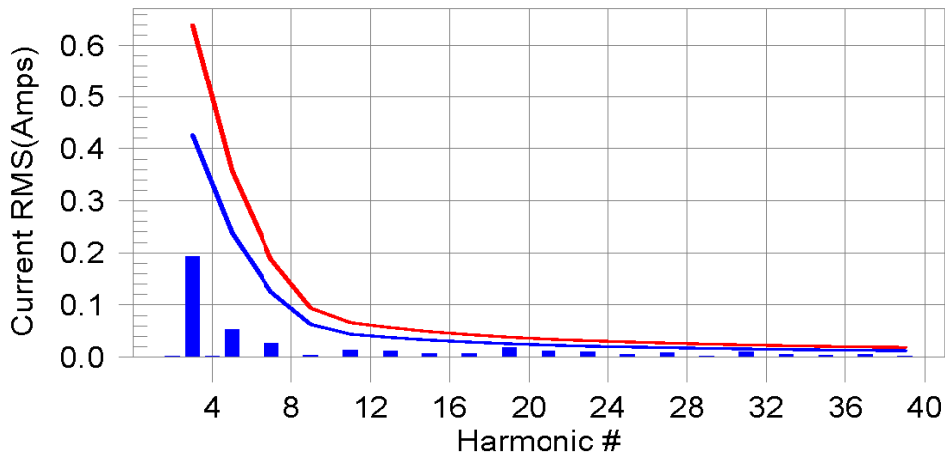

Test result: Pass Worst harmonics H19-50.7% of 150% limit, H19-74.3% of 100% limit

Current Test Result Summary (Run time)

EUT: M/N:AG274U Tested by: Kennen
 Test category: Class-D per Ed. 5.0 (2018) (European limits) Test Margin: 100
 Test date: 2021-4-2 Start time: 15:04:44 End time: 15:07:26
 Test duration (min): 2.5 Data file name: H-001014.cts_data
 Comment: Running "H" Pattern And 1KHz Playing (Type C:R Load)
 Customer: TPV

Test Result: Pass Source qualification: Normal
 THC(A): 0.205 I-THD(%): 36.4 POHC(A): 0.023 POHC Limit(A): 0.054

Highest parameter values during test:

V_RMS (Volts): 230.07	Frequency(Hz): 50.00
I_Peak (Amps): 1.386	I_RMS (Amps): 0.601
I_Fund (Amps): 0.563	Crest Factor: 2.323
Power (Watts): 125.3	Power Factor: 0.909

Harm#	Harms(avg)	100%Limit	%of Limit	Harms(max)	150%Limit	%of Limit	Status
2	0.002	0.000	N/A	0.003	0.000	N/A	Pass
3	0.193	0.426	45.2	0.194	0.639	30.3	Pass
4	0.001	0.000	N/A	0.001	0.000	N/A	Pass
5	0.052	0.238	21.9	0.052	0.357	14.7	Pass
6	0.001	0.000	N/A	0.001	0.000	N/A	Pass
7	0.027	0.125	21.5	0.028	0.188	14.6	Pass
8	0.000	0.000	N/A	0.001	0.000	N/A	Pass
9	0.004	0.063	N/A	0.004	0.094	N/A	Pass
10	0.000	0.000	N/A	0.001	0.000	N/A	Pass
11	0.014	0.044	31.9	0.014	0.066	21.8	Pass
12	0.000	0.000	N/A	0.001	0.000	N/A	Pass
13	0.011	0.038	29.1	0.011	0.056	20.0	Pass
14	0.000	0.000	N/A	0.001	0.000	N/A	Pass
15	0.007	0.033	21.9	0.007	0.049	15.1	Pass
16	0.000	0.000	N/A	0.001	0.000	N/A	Pass
17	0.007	0.029	25.7	0.008	0.043	18.0	Pass
18	0.000	0.000	N/A	0.001	0.000	N/A	Pass
19	0.019	0.025	74.3	0.019	0.038	50.7	Pass
20	0.000	0.000	N/A	0.001	0.000	N/A	Pass
21	0.012	0.023	51.1	0.012	0.034	35.3	Pass
22	0.000	0.000	N/A	0.001	0.000	N/A	Pass
23	0.011	0.021	50.5	0.011	0.031	35.1	Pass
24	0.001	0.000	N/A	0.001	0.000	N/A	Pass
25	0.006	0.019	29.7	0.006	0.029	21.6	Pass
26	0.001	0.000	N/A	0.001	0.000	N/A	Pass
27	0.008	0.018	44.2	0.009	0.027	32.1	Pass
28	0.000	0.000	N/A	0.001	0.000	N/A	Pass
29	0.002	0.017	N/A	0.003	0.025	N/A	Pass
30	0.000	0.000	N/A	0.001	0.000	N/A	Pass
31	0.010	0.016	65.5	0.011	0.023	45.3	Pass
32	0.000	0.000	N/A	0.001	0.000	N/A	Pass
33	0.005	0.015	N/A	0.005	0.022	N/A	Pass
34	0.000	0.000	N/A	0.000	0.000	N/A	Pass
35	0.003	0.014	N/A	0.003	0.021	N/A	Pass
36	0.000	0.000	N/A	0.001	0.000	N/A	Pass
37	0.006	0.013	42.3	0.006	0.020	29.4	Pass
38	0.000	0.000	N/A	0.001	0.000	N/A	Pass
39	0.001	0.012	N/A	0.002	0.019	N/A	Pass
40	0.000	0.000	N/A	0.001	0.000	N/A	Pass

Note: Dynamic limits were applied for this test. The highest harmonics values in the above table may not occur at the same window as the maximum harmonics/limit ratio.

Voltage Source Verification Data (Run time)

EUT: M/N:AG274U Tested by: Kennen
 Test category: Class-D per Ed. 5.0 (2018) (European limits) Test Margin: 100
 Test date: 2021-4-2 Start time: 15:04:44 End time: 15:07:26
 Test duration (min): 2.5 Data file name: H-001014.cts_data
 Comment: Running "H" Pattern And 1KHz Playing (Type C:R Load)
 Customer: TPV

Test Result: Pass Source qualification: Normal

Highest parameter values during test:

Voltage (Vrms): 230.07	Frequency(Hz): 50.00
I_Peak (Amps): 1.386	I_RMS (Amps): 0.601
I_Fund (Amps): 0.563	Crest Factor: 2.323
Power (Watts): 125.3	Power Factor: 0.909

Harm#	Harmonics V-rms	Limit V-rms	% of Limit	Status
2	0.099	0.460	21.60	OK
3	0.482	2.070	23.28	OK
4	0.068	0.460	14.87	OK
5	0.042	0.920	4.55	OK
6	0.039	0.460	8.38	OK
7	0.052	0.690	7.55	OK
8	0.016	0.460	3.42	OK
9	0.021	0.460	4.60	OK
10	0.019	0.460	4.06	OK
11	0.019	0.230	8.06	OK
12	0.020	0.230	8.62	OK
13	0.012	0.230	5.22	OK
14	0.009	0.230	4.03	OK
15	0.013	0.230	5.78	OK
16	0.014	0.230	6.27	OK
17	0.011	0.230	4.64	OK
18	0.017	0.230	7.59	OK
19	0.018	0.230	7.96	OK
20	0.014	0.230	6.25	OK
21	0.016	0.230	7.05	OK
22	0.006	0.230	2.66	OK
23	0.016	0.230	6.94	OK
24	0.008	0.230	3.67	OK
25	0.015	0.230	6.66	OK
26	0.007	0.230	3.02	OK
27	0.017	0.230	7.51	OK
28	0.008	0.230	3.36	OK
29	0.011	0.230	4.71	OK
30	0.006	0.230	2.51	OK
31	0.016	0.230	7.15	OK
32	0.006	0.230	2.40	OK
33	0.010	0.230	4.55	OK
34	0.006	0.230	2.48	OK
35	0.006	0.230	2.71	OK
36	0.006	0.230	2.57	OK
37	0.012	0.230	5.39	OK
38	0.006	0.230	2.43	OK
39	0.008	0.230	3.42	OK
40	0.006	0.230	2.44	OK

Harmonics – Class-D per Ed. 5.0 (2018)(Run time)

EUT: M/N:AG274U
 Test category: Class-D per Ed. 5.0 (2018) (European limits)
 Test date: 2021-4-2
 Test duration (min): 2.5
 Comment: Default Mode
 Customer: TPV

Tested by: Kennen
 Test Margin: 100
 Start time: 15:08:08
 End time: 15:10:50
 Data file name: H-001015.cts_data

Test Result: N/L Source qualification: Normal

Current & voltage waveforms

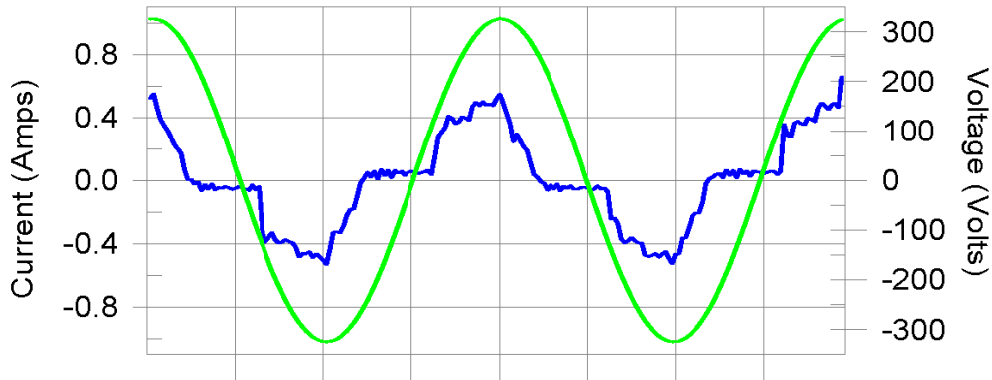

Harmonics and Class D limit line European Limits

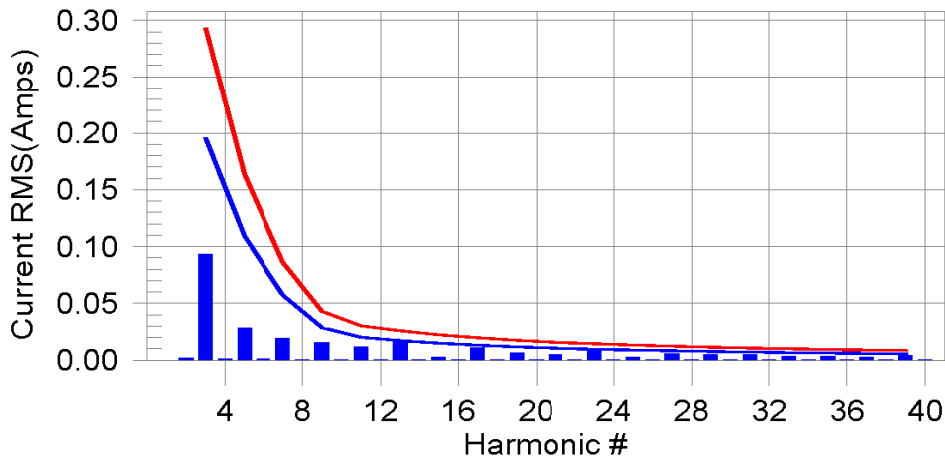

Test result: N/L Worst harmonics H0-0.0% of 150% limit, H0-0% of 100% limit

Current Test Result Summary (Run time)

EUT: M/N:AG274U Tested by: Kennen
 Test category: Class-D per Ed. 5.0 (2018) (European limits) Test Margin: 100
 Test date: 2021-4-2 Start time: 15:08:08 End time: 15:10:50
 Test duration (min): 2.5 Data file name: H-001015.cts_data
 Comment: Default Mode
 Customer: TPV

Test Result: N/L Source qualification: Normal
 THC(A): 0.105 I-THD(%): 38.1 POHC(A): 0.015 POHC Limit(A): 0.025

Highest parameter values during test:

V_RMS (Volts): 230.07	Frequency(Hz): 50.00
I_Peak (Amps): 0.727	I_RMS (Amps): 0.296
I_Fund (Amps): 0.275	Crest Factor: 2.475
Power (Watts): 57.4	Power Factor: 0.847

Harm#	Harms(avg)	100%Limit	%of Limit	Harms(max)	150%Limit	%of Limit	Status
2	0.002	0.000	N/A	0.003	0.000	N/A	N/L
3	0.093	0.195	N/A	0.095	0.293	N/A	N/L
4	0.001	0.000	N/A	0.002	0.000	N/A	N/L
5	0.028	0.109	N/A	0.029	0.164	N/A	N/L
6	0.001	0.000	N/A	0.001	0.000	N/A	N/L
7	0.019	0.057	N/A	0.020	0.086	N/A	N/L
8	0.001	0.000	N/A	0.001	0.000	N/A	N/L
9	0.016	0.029	N/A	0.016	0.043	N/A	N/L
10	0.001	0.000	N/A	0.001	0.000	N/A	N/L
11	0.012	0.020	N/A	0.012	0.030	N/A	N/L
12	0.001	0.000	N/A	0.001	0.000	N/A	N/L
13	0.016	0.017	N/A	0.017	0.026	N/A	N/L
14	0.000	0.000	N/A	0.001	0.000	N/A	N/L
15	0.003	0.015	N/A	0.003	0.022	N/A	N/L
16	0.000	0.000	N/A	0.001	0.000	N/A	N/L
17	0.011	0.013	N/A	0.012	0.020	N/A	N/L
18	0.000	0.000	N/A	0.001	0.000	N/A	N/L
19	0.007	0.012	N/A	0.007	0.017	N/A	N/L
20	0.000	0.000	N/A	0.001	0.000	N/A	N/L
21	0.005	0.011	N/A	0.006	0.016	N/A	N/L
22	0.000	0.000	N/A	0.001	0.000	N/A	N/L
23	0.008	0.010	N/A	0.008	0.014	N/A	N/L
24	0.000	0.000	N/A	0.000	0.000	N/A	N/L
25	0.003	0.009	N/A	0.003	0.013	N/A	N/L
26	0.000	0.000	N/A	0.000	0.000	N/A	N/L
27	0.006	0.008	N/A	0.007	0.012	N/A	N/L
28	0.000	0.000	N/A	0.001	0.000	N/A	N/L
29	0.005	0.008	N/A	0.005	0.011	N/A	N/L
30	0.000	0.000	N/A	0.001	0.000	N/A	N/L
31	0.005	0.007	N/A	0.005	0.011	N/A	N/L
32	0.000	0.000	N/A	0.001	0.000	N/A	N/L
33	0.003	0.007	N/A	0.003	0.010	N/A	N/L
34	0.000	0.000	N/A	0.001	0.000	N/A	N/L
35	0.004	0.006	N/A	0.004	0.009	N/A	N/L
36	0.000	0.000	N/A	0.001	0.000	N/A	N/L
37	0.003	0.006	N/A	0.003	0.009	N/A	N/L
38	0.000	0.000	N/A	0.000	0.000	N/A	N/L
39	0.004	0.006	N/A	0.004	0.009	N/A	N/L
40	0.000	0.000	N/A	0.001	0.000	N/A	N/L

Note: The EUT power level is below 75.0 Watts and therefore has no defined limits

Voltage Source Verification Data (Run time)

EUT: M/N:AG274U Tested by: Kennen
 Test category: Class-D per Ed. 5.0 (2018) (European limits) Test Margin: 100
 Test date: 2021-4-2 Start time: 15:08:08 End time: 15:10:50
 Test duration (min): 2.5 Data file name: H-001015.cts_data
 Comment: Default Mode
 Customer: TPV

Test Result: N/L Source qualification: Normal

Highest parameter values during test:

Voltage (Vrms): 230.07	Frequency(Hz): 50.00
I_Peak (Amps): 0.727	I_RMS (Amps): 0.296
I_Fund (Amps): 0.275	Crest Factor: 2.475
Power (Watts): 57.4	Power Factor: 0.847

Harm#	Harmonics V-rms	Limit V-rms	% of Limit	Status
2	0.085	0.460	18.47	OK
3	0.461	2.070	22.28	OK
4	0.065	0.460	14.13	OK
5	0.045	0.920	4.93	OK
6	0.037	0.460	7.96	OK
7	0.053	0.690	7.63	OK
8	0.016	0.460	3.45	OK
9	0.023	0.460	5.02	OK
10	0.016	0.460	3.46	OK
11	0.015	0.230	6.37	OK
12	0.019	0.230	8.11	OK
13	0.019	0.230	8.43	OK
14	0.009	0.230	3.94	OK
15	0.013	0.230	5.57	OK
16	0.012	0.230	5.27	OK
17	0.015	0.230	6.51	OK
18	0.018	0.230	7.68	OK
19	0.012	0.230	5.07	OK
20	0.014	0.230	6.14	OK
21	0.007	0.230	2.99	OK
22	0.006	0.230	2.67	OK
23	0.013	0.230	5.61	OK
24	0.008	0.230	3.37	OK
25	0.011	0.230	4.66	OK
26	0.007	0.230	2.83	OK
27	0.015	0.230	6.51	OK
28	0.007	0.230	2.95	OK
29	0.013	0.230	5.80	OK
30	0.005	0.230	2.24	OK
31	0.009	0.230	3.97	OK
32	0.006	0.230	2.40	OK
33	0.009	0.230	3.76	OK
34	0.006	0.230	2.51	OK
35	0.010	0.230	4.37	OK
36	0.006	0.230	2.42	OK
37	0.006	0.230	2.70	OK
38	0.006	0.230	2.48	OK
39	0.010	0.230	4.24	OK
40	0.006	0.230	2.62	OK

Harmonics – Class-D per Ed. 5.0 (2018)(Run time)

EUT: AG274U Adapter: FSP230-AJAN3 Tested by: Kennen
 Test category: Class-D per Ed. 5.0 (2018) (European limits) Test Margin: 100
 Test date: 2021-5-7 Start time: 17:14:45 End time: 17:17:26
 Test duration (min): 2.5 Data file name: H-000117.cts_data
 Comment: Running "H" Pattern And 1KHz Playing
 Customer: TPV

Test Result: N/L Source qualification: Normal

Current & voltage waveforms

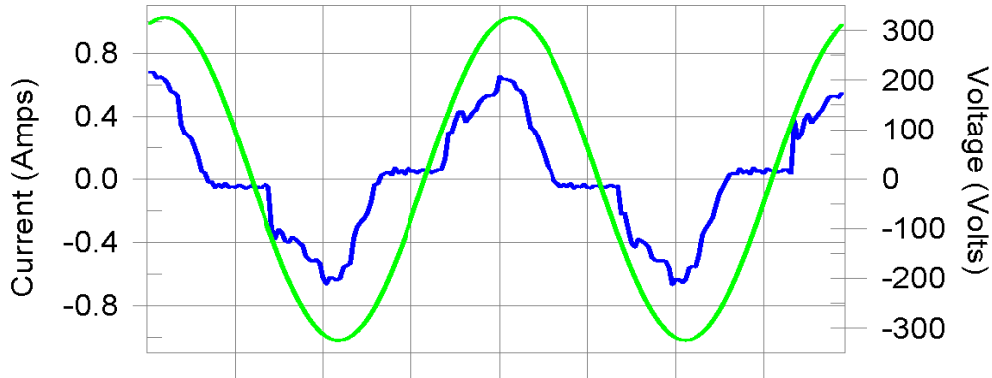

Harmonics and Class D limit line European Limits

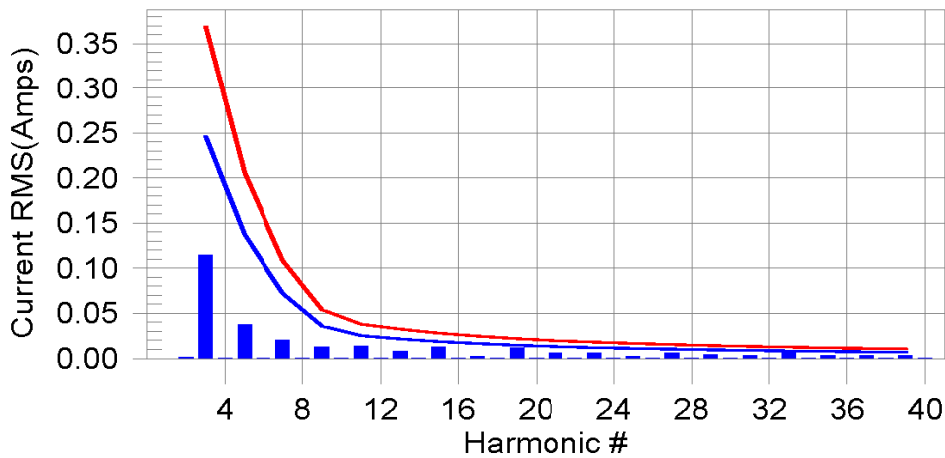

Test result: N/L Worst harmonics H0-0.0% of 150% limit, H0-0% of 100% limit

Current Test Result Summary (Run time)

EUT: AG274U Adapter: FSP230-AJAN3 Tested by: Kennen
 Test category: Class-D per Ed. 5.0 (2018) (European limits) Test Margin: 100
 Test date: 2021-5-7 Start time: 17:14:45 End time: 17:17:26
 Test duration (min): 2.5 Data file name: H-000117.cts_data
 Comment: Running "H" Pattern And 1KHz Playing
 Customer: TPV

Test Result: N/L Source qualification: Normal
 THC(A): 0.126 I-THD(%): 37.6 POHC(A): 0.016 POHC Limit(A): 0.031

Highest parameter values during test:

V_RMS (Volts): 230.07 Frequency(Hz): 50.00
 I_Peak (Amps): 0.719 I_RMS (Amps): 0.360
 I_Fund (Amps): 0.336 Crest Factor: 1.999
 Power (Watts): 72.4 Power Factor: 0.876

Harm#	Harms(avg)	100%Limit	%of Limit	Harms(max)	150%Limit	%of Limit	Status
2	0.001	0.000	N/A	0.002	0.000	N/A	N/L
3	0.114	0.246	N/A	0.116	0.369	N/A	N/L
4	0.001	0.000	N/A	0.001	0.000	N/A	N/L
5	0.037	0.137	N/A	0.038	0.206	N/A	N/L
6	0.000	0.000	N/A	0.000	0.000	N/A	N/L
7	0.021	0.072	N/A	0.021	0.109	N/A	N/L
8	0.000	0.000	N/A	0.000	0.000	N/A	N/L
9	0.013	0.036	N/A	0.013	0.054	N/A	N/L
10	0.000	0.000	N/A	0.000	0.000	N/A	N/L
11	0.014	0.025	N/A	0.014	0.038	N/A	N/L
12	0.000	0.000	N/A	0.000	0.000	N/A	N/L
13	0.008	0.022	N/A	0.009	0.033	N/A	N/L
14	0.000	0.000	N/A	0.000	0.000	N/A	N/L
15	0.013	0.019	N/A	0.014	0.028	N/A	N/L
16	0.000	0.000	N/A	0.000	0.000	N/A	N/L
17	0.003	0.017	N/A	0.003	0.025	N/A	N/L
18	0.000	0.000	N/A	0.000	0.000	N/A	N/L
19	0.012	0.015	N/A	0.013	0.022	N/A	N/L
20	0.000	0.000	N/A	0.000	0.000	N/A	N/L
21	0.006	0.013	N/A	0.007	0.020	N/A	N/L
22	0.000	0.000	N/A	0.000	0.000	N/A	N/L
23	0.006	0.012	N/A	0.007	0.018	N/A	N/L
24	0.000	0.000	N/A	0.000	0.000	N/A	N/L
25	0.003	0.011	N/A	0.003	0.017	N/A	N/L
26	0.000	0.000	N/A	0.000	0.000	N/A	N/L
27	0.006	0.010	N/A	0.006	0.016	N/A	N/L
28	0.000	0.000	N/A	0.000	0.000	N/A	N/L
29	0.004	0.010	N/A	0.004	0.014	N/A	N/L
30	0.000	0.000	N/A	0.000	0.000	N/A	N/L
31	0.004	0.009	N/A	0.004	0.013	N/A	N/L
32	0.000	0.000	N/A	0.000	0.000	N/A	N/L
33	0.007	0.008	N/A	0.008	0.013	N/A	N/L
34	0.000	0.000	N/A	0.000	0.000	N/A	N/L
35	0.003	0.008	N/A	0.003	0.012	N/A	N/L
36	0.000	0.000	N/A	0.000	0.000	N/A	N/L
37	0.003	0.008	N/A	0.004	0.011	N/A	N/L
38	0.000	0.000	N/A	0.000	0.000	N/A	N/L
39	0.004	0.007	N/A	0.004	0.011	N/A	N/L
40	0.000	0.000	N/A	0.000	0.000	N/A	N/L

Note: The EUT power level is below 75.0 Watts and therefore has no defined limits

Voltage Source Verification Data (Run time)

EUT: AG274U Adapter: FSP230-AJAN3 Tested by: Kennen
 Test category: Class-D per Ed. 5.0 (2018) (European limits) Test Margin: 100
 Test date: 2021-5-7 Start time: 17:14:45 End time: 17:17:26
 Test duration (min): 2.5 Data file name: H-000117.cts_data
 Comment: Running "H" Pattern And 1KHz Playing
 Customer: TPV

Test Result: N/L Source qualification: Normal

Highest parameter values during test:

Voltage (Vrms): 230.07 Frequency(Hz): 50.00
 I_Peak (Amps): 0.719 I_RMS (Amps): 0.360
 I_Fund (Amps): 0.336 Crest Factor: 1.999
 Power (Watts): 72.4 Power Factor: 0.876

Harm#	Harmonics V-rms	Limit V-rms	% of Limit	Status
2	0.091	0.460	19.75	OK
3	0.467	2.070	22.56	OK
4	0.061	0.460	13.16	OK
5	0.046	0.920	4.99	OK
6	0.034	0.460	7.44	OK
7	0.049	0.690	7.09	OK
8	0.014	0.460	3.08	OK
9	0.020	0.460	4.38	OK
10	0.016	0.460	3.45	OK
11	0.015	0.230	6.33	OK
12	0.016	0.230	7.13	OK
13	0.013	0.230	5.64	OK
14	0.008	0.230	3.67	OK
15	0.019	0.230	8.06	OK
16	0.010	0.230	4.27	OK
17	0.007	0.230	3.10	OK
18	0.017	0.230	7.42	OK
19	0.014	0.230	5.88	OK
20	0.011	0.230	4.68	OK
21	0.007	0.230	2.90	OK
22	0.004	0.230	1.56	OK
23	0.012	0.230	5.37	OK
24	0.005	0.230	2.31	OK
25	0.010	0.230	4.50	OK
26	0.004	0.230	1.72	OK
27	0.014	0.230	6.20	OK
28	0.007	0.230	2.98	OK
29	0.012	0.230	5.03	OK
30	0.003	0.230	1.45	OK
31	0.008	0.230	3.38	OK
32	0.004	0.230	1.66	OK
33	0.011	0.230	4.96	OK
34	0.004	0.230	1.58	OK
35	0.007	0.230	2.85	OK
36	0.004	0.230	1.56	OK
37	0.005	0.230	2.38	OK
38	0.003	0.230	1.47	OK
39	0.009	0.230	4.10	OK
40	0.004	0.230	1.55	OK

Harmonics – Class-D per Ed. 5.0 (2018)(Run time)

EUT: AG274U Adapter: FSP230-AJAN3 Tested by: Kennen
 Test category: Class-D per Ed. 5.0 (2018) (European limits) Test Margin: 100
 Test date: 2021-5-7 Start time: 16:53:40 End time: 16:56:22
 Test duration (min): 2.5 Data file name: H-000114.cts_data
 Comment: Default Mode
 Customer: TPV

Test Result: N/L Source qualification: Normal

Current & voltage waveforms

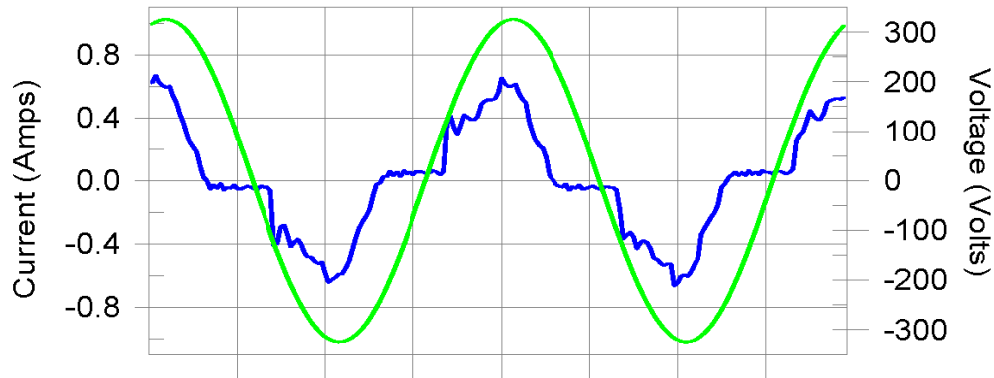

Harmonics and Class D limit line European Limits

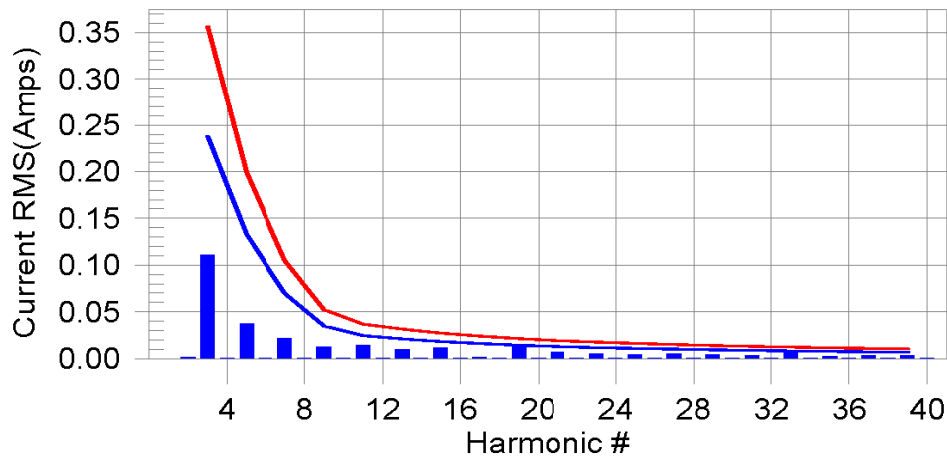

Test result: N/L Worst harmonics H0-0.0% of 150% limit, H0-0% of 100% limit

Current Test Result Summary (Run time)

EUT: AG274U Adapter: FSP230-AJAN3 Tested by: Kennen
 Test category: Class-D per Ed. 5.0 (2018) (European limits) Test Margin: 100
 Test date: 2021-5-7 Start time: 16:53:40 End time: 16:56:22
 Test duration (min): 2.5 Data file name: H-000114.cts_data
 Comment: Default Mode
 Customer: TPV

Test Result: N/L Source qualification: Normal
 THCA(A): 0.123 I-THD(%): 37.8 POHC(A): 0.015 POHC Limit(A): 0.030

Highest parameter values during test:

V_RMS (Volts): 230.07 Frequency(Hz): 50.00
 I_Peak (Amps): 0.698 I_RMS (Amps): 0.352
 I_Fund (Amps): 0.326 Crest Factor: 2.014
 Power (Watts): 69.9 Power Factor: 0.872

Harm#	Harms(avg)	100%Limit	%of Limit	Harms(max)	150%Limit	%of Limit	Status
2	0.001	0.000	N/A	0.002	0.000	N/A	N/L
3	0.111	0.238	N/A	0.112	0.357	N/A	N/L
4	0.001	0.000	N/A	0.001	0.000	N/A	N/L
5	0.037	0.133	N/A	0.037	0.199	N/A	N/L
6	0.000	0.000	N/A	0.001	0.000	N/A	N/L
7	0.022	0.070	N/A	0.023	0.105	N/A	N/L
8	0.000	0.000	N/A	0.000	0.000	N/A	N/L
9	0.012	0.035	N/A	0.012	0.052	N/A	N/L
10	0.000	0.000	N/A	0.000	0.000	N/A	N/L
11	0.014	0.024	N/A	0.015	0.037	N/A	N/L
12	0.000	0.000	N/A	0.000	0.000	N/A	N/L
13	0.010	0.021	N/A	0.014	0.031	N/A	N/L
14	0.000	0.000	N/A	0.000	0.000	N/A	N/L
15	0.011	0.018	N/A	0.012	0.027	N/A	N/L
16	0.000	0.000	N/A	0.000	0.000	N/A	N/L
17	0.002	0.016	N/A	0.003	0.024	N/A	N/L
18	0.000	0.000	N/A	0.000	0.000	N/A	N/L
19	0.013	0.014	N/A	0.013	0.021	N/A	N/L
20	0.000	0.000	N/A	0.000	0.000	N/A	N/L
21	0.007	0.013	N/A	0.008	0.019	N/A	N/L
22	0.000	0.000	N/A	0.000	0.000	N/A	N/L
23	0.005	0.012	N/A	0.005	0.018	N/A	N/L
24	0.000	0.000	N/A	0.000	0.000	N/A	N/L
25	0.004	0.011	N/A	0.006	0.016	N/A	N/L
26	0.000	0.000	N/A	0.000	0.000	N/A	N/L
27	0.005	0.010	N/A	0.005	0.015	N/A	N/L
28	0.000	0.000	N/A	0.000	0.000	N/A	N/L
29	0.004	0.009	N/A	0.005	0.014	N/A	N/L
30	0.000	0.000	N/A	0.000	0.000	N/A	N/L
31	0.003	0.009	N/A	0.005	0.013	N/A	N/L
32	0.000	0.000	N/A	0.000	0.000	N/A	N/L
33	0.008	0.008	N/A	0.008	0.012	N/A	N/L
34	0.000	0.000	N/A	0.000	0.000	N/A	N/L
35	0.002	0.008	N/A	0.003	0.012	N/A	N/L
36	0.000	0.000	N/A	0.000	0.000	N/A	N/L
37	0.003	0.007	N/A	0.005	0.011	N/A	N/L
38	0.000	0.000	N/A	0.000	0.000	N/A	N/L
39	0.003	0.007	N/A	0.004	0.010	N/A	N/L
40	0.000	0.000	N/A	0.000	0.000	N/A	N/L

Note: The EUT power level is below 75.0 Watts and therefore has no defined limits

Voltage Source Verification Data (Run time)

EUT: AG274U Adapter: FSP230-AJAN3 Tested by: Kennen
 Test category: Class-D per Ed. 5.0 (2018) (European limits) Test Margin: 100
 Test date: 2021-5-7 Start time: 16:53:40 End time: 16:56:22
 Test duration (min): 2.5 Data file name: H-000114.cts_data
 Comment: Default Mode
 Customer: TPV

Test Result: N/L Source qualification: Normal

Highest parameter values during test:

Voltage (Vrms): 230.07 Frequency(Hz): 50.00
 I_Peak (Amps): 0.698 I_RMS (Amps): 0.352
 I_Fund (Amps): 0.326 Crest Factor: 2.014
 Power (Watts): 69.9 Power Factor: 0.872

Harm#	Harmonics V-rms	Limit V-rms	% of Limit	Status
2	0.100	0.460	21.67	OK
3	0.462	2.070	22.34	OK
4	0.061	0.460	13.17	OK
5	0.046	0.920	4.95	OK
6	0.034	0.460	7.37	OK
7	0.050	0.690	7.25	OK
8	0.015	0.460	3.34	OK
9	0.020	0.460	4.40	OK
10	0.017	0.460	3.66	OK
11	0.014	0.230	6.04	OK
12	0.019	0.230	8.13	OK
13	0.014	0.230	6.08	OK
14	0.008	0.230	3.66	OK
15	0.017	0.230	7.52	OK
16	0.009	0.230	4.01	OK
17	0.007	0.230	3.06	OK
18	0.015	0.230	6.55	OK
19	0.014	0.230	6.29	OK
20	0.012	0.230	5.03	OK
21	0.007	0.230	3.13	OK
22	0.004	0.230	1.71	OK
23	0.012	0.230	5.22	OK
24	0.006	0.230	2.51	OK
25	0.011	0.230	4.93	OK
26	0.004	0.230	1.86	OK
27	0.014	0.230	5.94	OK
28	0.006	0.230	2.75	OK
29	0.011	0.230	4.89	OK
30	0.003	0.230	1.52	OK
31	0.007	0.230	3.20	OK
32	0.004	0.230	1.87	OK
33	0.012	0.230	5.32	OK
34	0.003	0.230	1.49	OK
35	0.006	0.230	2.51	OK
36	0.003	0.230	1.48	OK
37	0.005	0.230	2.36	OK
38	0.003	0.230	1.50	OK
39	0.008	0.230	3.56	OK
40	0.004	0.230	1.67	OK

Harmonics – Class-D per Ed. 5.0 (2018)(Run time)

EUT: AG274U Adapter: FSP230-AJAN3 Tested by: Kennen
 Test category: Class-D per Ed. 5.0 (2018) (European limits) Test Margin: 100
 Test date: 2021-5-7 Start time: 16:58:20 End time: 17:01:01
 Test duration (min): 2.5 Data file name: H-000115.cts_data
 Comment: Running "H" Pattern And 1KHz Playing (Type C:R Load)
 Customer: TPV

Test Result: Pass Source qualification: Normal

Current & voltage waveforms

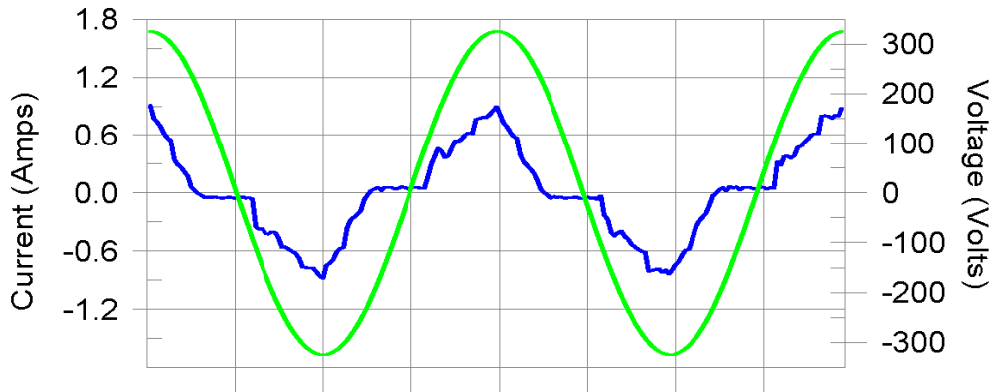

Harmonics and Class D limit line European Limits

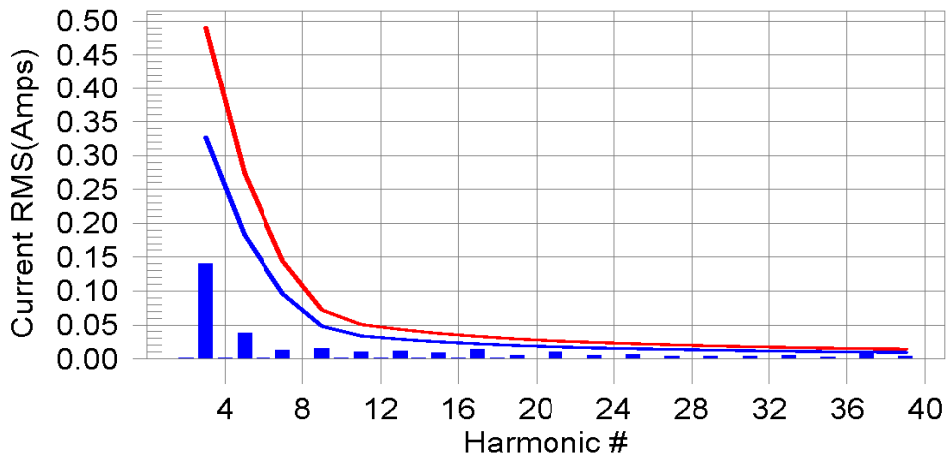

Test result: Pass Worst harmonics H17-53.8% of 150% limit, H37-74.5% of 100% limit

Current Test Result Summary (Run time)

EUT: AG274U Adapter: FSP230-AJAN3 Tested by: Kennen
 Test category: Class-D per Ed. 5.0 (2018) (European limits) Test Margin: 100
 Test date: 2021-5-7 Start time: 16:58:20 End time: 17:01:01
 Test duration (min): 2.5 Data file name: H-000115.cts_data
 Comment: Running "H" Pattern And 1KHz Playing (Type C:R Load)
 Customer: TPV

Test Result: Pass Source qualification: Normal
 THCA(A): 0.150 I-THD(%): 34.3 POHC(A): 0.019 POHC Limit(A): 0.041

Highest parameter values during test:

V_RMS (Volts): 230.08 Frequency(Hz): 50.00
 I_Peak (Amps): 0.971 I_RMS (Amps): 0.464
 I_Fund (Amps): 0.437 Crest Factor: 2.102
 Power (Watts): 96.1 Power Factor: 0.902

Harm#	Harms(avg)	100%Limit	%of Limit	Harms(max)	150%Limit	%of Limit	Status
2	0.001	0.000	N/A	0.003	0.000	N/A	Pass
3	0.140	0.327	42.9	0.145	0.490	29.5	Pass
4	0.001	0.000	N/A	0.002	0.000	N/A	Pass
5	0.038	0.183	21.0	0.040	0.274	14.7	Pass
6	0.001	0.000	N/A	0.002	0.000	N/A	Pass
7	0.013	0.096	13.1	0.015	0.144	10.5	Pass
8	0.001	0.000	N/A	0.001	0.000	N/A	Pass
9	0.016	0.048	32.8	0.018	0.072	24.6	Pass
10	0.001	0.000	N/A	0.002	0.000	N/A	Pass
11	0.011	0.034	31.5	0.013	0.050	26.2	Pass
12	0.001	0.000	N/A	0.001	0.000	N/A	Pass
13	0.011	0.029	38.0	0.012	0.043	28.7	Pass
14	0.001	0.000	N/A	0.001	0.000	N/A	Pass
15	0.009	0.025	37.4	0.011	0.037	30.6	Pass
16	0.001	0.000	N/A	0.001	0.000	N/A	Pass
17	0.014	0.022	63.4	0.018	0.033	53.8	Pass
18	0.001	0.000	N/A	0.001	0.000	N/A	Pass
19	0.005	0.020	27.2	0.008	0.029	28.6	Pass
20	0.001	0.000	N/A	0.001	0.000	N/A	Pass
21	0.010	0.018	58.3	0.012	0.026	45.1	Pass
22	0.000	0.000	N/A	0.001	0.000	N/A	Pass
23	0.006	0.016	35.7	0.006	0.024	25.2	Pass
24	0.001	0.000	N/A	0.001	0.000	N/A	Pass
25	0.007	0.015	47.5	0.008	0.022	37.2	Pass
26	0.001	0.000	N/A	0.001	0.000	N/A	Pass
27	0.004	0.014	N/A	0.006	0.021	N/A	Pass
28	0.001	0.000	N/A	0.001	0.000	N/A	Pass
29	0.004	0.013	N/A	0.006	0.019	N/A	Pass
30	0.001	0.000	N/A	0.001	0.000	N/A	Pass
31	0.004	0.012	N/A	0.006	0.018	N/A	Pass
32	0.001	0.000	N/A	0.001	0.000	N/A	Pass
33	0.006	0.011	49.7	0.007	0.017	42.9	Pass
34	0.000	0.000	N/A	0.001	0.000	N/A	Pass
35	0.003	0.011	N/A	0.004	0.016	N/A	Pass
36	0.000	0.000	N/A	0.001	0.000	N/A	Pass
37	0.007	0.010	74.5	0.008	0.015	52.2	Pass
38	0.000	0.000	N/A	0.000	0.000	N/A	Pass
39	0.004	0.010	N/A	0.004	0.014	N/A	Pass
40	0.000	0.000	N/A	0.001	0.000	N/A	Pass

Note: Dynamic limits were applied for this test. The highest harmonics values in the above table may not occur at the same window as the maximum harmonics/limit ratio.

Voltage Source Verification Data (Run time)

EUT: AG274U Adapter: FSP230-AJAN3 Tested by: Kennen
 Test category: Class-D per Ed. 5.0 (2018) (European limits) Test Margin: 100
 Test date: 2021-5-7 Start time: 16:58:20 End time: 17:01:01
 Test duration (min): 2.5 Data file name: H-000115.cts_data
 Comment: Running "H" Pattern And 1KHz Playing (Type C:R Load)
 Customer: TPV

Test Result: Pass Source qualification: Normal

Highest parameter values during test:

Voltage (Vrms): 230.08	Frequency(Hz): 50.00
I_Peak (Amps): 0.971	I_RMS (Amps): 0.464
I_Fund (Amps): 0.437	Crest Factor: 2.102
Power (Watts): 96.1	Power Factor: 0.902

Harm#	Harmonics V-rms	Limit V-rms	% of Limit	Status
2	0.098	0.460	21.40	OK
3	0.476	2.070	22.98	OK
4	0.063	0.460	13.65	OK
5	0.050	0.920	5.39	OK
6	0.035	0.460	7.67	OK
7	0.055	0.690	7.96	OK
8	0.016	0.460	3.58	OK
9	0.022	0.460	4.74	OK
10	0.019	0.460	4.19	OK
11	0.012	0.230	5.40	OK
12	0.018	0.230	7.72	OK
13	0.012	0.230	5.05	OK
14	0.009	0.230	3.90	OK
15	0.015	0.230	6.73	OK
16	0.011	0.230	4.66	OK
17	0.018	0.230	7.83	OK
18	0.017	0.230	7.40	OK
19	0.012	0.230	5.18	OK
20	0.013	0.230	5.59	OK
21	0.012	0.230	5.15	OK
22	0.005	0.230	2.18	OK
23	0.013	0.230	5.53	OK
24	0.006	0.230	2.70	OK
25	0.013	0.230	5.73	OK
26	0.005	0.230	2.39	OK
27	0.014	0.230	6.10	OK
28	0.006	0.230	2.70	OK
29	0.011	0.230	4.87	OK
30	0.004	0.230	1.83	OK
31	0.009	0.230	3.78	OK
32	0.004	0.230	1.71	OK
33	0.011	0.230	4.88	OK
34	0.004	0.230	1.88	OK
35	0.009	0.230	3.79	OK
36	0.004	0.230	1.71	OK
37	0.014	0.230	6.03	OK
38	0.003	0.230	1.45	OK
39	0.007	0.230	3.07	OK
40	0.004	0.230	1.62	OK

6. VOLTAGE FLUCTUATIONS & FLICKER TEST

6.1. Test Equipment

Same as Section 6.1.

6.2. Block Diagram of Test Setup

Same as Section 6.2.

6.3. Test Standard

EN 61000-3-3: 2013

IEC 61000-3-3: 2013

EN 61000-3-3: 2013+A1:2019

IEC 61000-3-3: 2013+A1:2017

BS EN 61000-3-3: 2013

BS EN 61000-3-3: 2013+A1:2019

6.4. Limits of Voltage Fluctuation and Flick

Test Item	Limit	Note
P_{st}	1.0	P_{st} means Short-term flicker indicator
P_{lt}	0.65	P_{lt} means long-term flicker indicator
T_{max}	500ms	T_{max} means maximum time that $d(t)$ exceeds 3.3%
$d_{max}(\%)$	4%	d_{max} means maximum relative voltage change.
$d_c(\%)$	3.3%	d_c means relative steady-state voltage change.

6.5. EUT Configuration on Test

The configurations of EUT are listed in Section 3.5.

6.6. Operating Condition of EUT

Same as Section 6.6.

6.7. Test Procedure

The EUT was placed on the top of a wooden table 0.8 meters above the ground and operated to produce the most unfavorable sequence of voltage changes under normal conditions. During the flick measurement, the measure time shall include that part of whole operation changes. The observation period for short-term flicker indicator is 10 minutes and the observation period for long-term flicker indicator is 2 hours.

6.8. Test Results

PASS. (Test results are recorded in next page)

Flicker Test Summary per EN/IEC61000-3-3 Ed. 3.0 (2013) (Run time)

EUT: M/N:AG274U
 Test category: All parameters (European limits)
 Test date: 2021-4-2
 Test duration (min): 10
 Comment: Running "H" Pattern And 1KHz Playing
 Customer: TPV

Tested by: Kennen
 Test Margin: 100
 Start time: 15:11:34
 End time: 15:22:02
 Data file name: F-001016.cts_data

Test Result: Pass Status: Test Completed

Pst, and limit line

European Limits

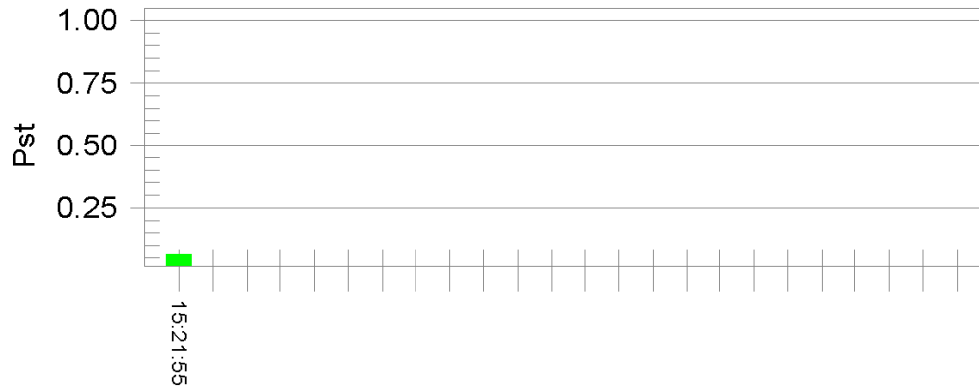

Plt and limit line



Parameter values recorded during the test:

Vrms at the end of test (Volt):	230.01		
T-max (mS):	0	Test limit (mS):	500.0 Pass
Highest dc (%):	0.00	Test limit (%):	3.30 Pass
Highest dmax (%):	0.00	Test limit (%):	4.00 Pass
Highest Pst (10 min. period):	0.064	Test limit:	1.000 Pass
Highest Plt (2 hr. period):	0.028	Test limit:	0.650 Pass

Flicker Test Summary per EN/IEC61000-3-3 Ed. 3.0 (2013) (Run time)

EUT: AG274U Adapter: FSP230-AJAN3 Tested by: Kennen
 Test category: All parameters (European limits) Test Margin: 100
 Test date: 2021-5-7 Start time: 17:18:47 End time: 17:29:14
 Test duration (min): 10 Data file name: F-000118.cts_data
 Comment: Running "H" Pattern And 1KHz Playing
 Customer: TPV

Test Result: Pass

Status: Test Completed

Pst and limit line

European Limits

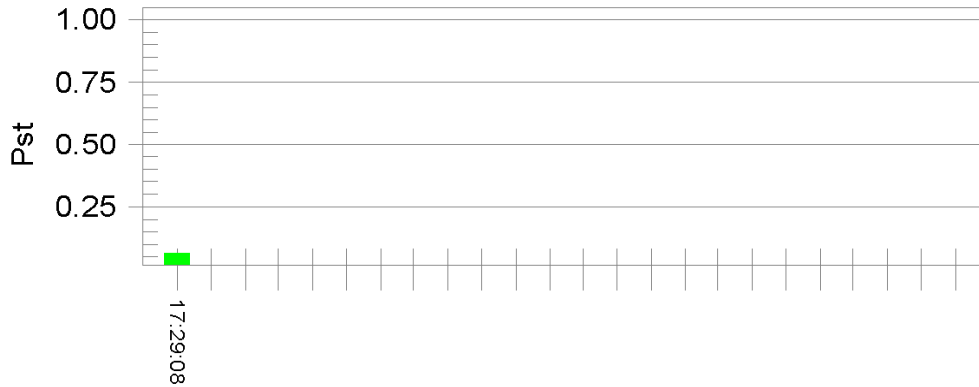

Plt and limit line

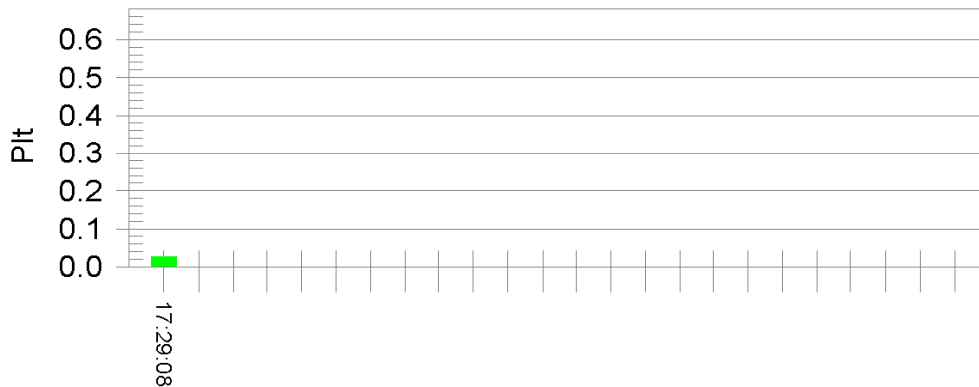

Parameter values recorded during the test:

Vrms at the end of test (Volt):	229.95		
T-max (mS):	0	Test limit (mS):	500.0 Pass
Highest dc (%):	0.00	Test limit (%):	3.30 Pass
Highest dmax (%):	0.00	Test limit (%):	4.00 Pass
Highest Pst (10 min. period):	0.064	Test limit:	1.000 Pass
Highest Plt (2 hr. period):	0.028	Test limit:	0.650 Pass

7. IMMUNITY PERFORMANCE CRITERIA

Performance Level

The test results shall be classified in terms of the loss of function or degradation of performance of the equipment under test, relative to a performance level by its manufacturer or the requestor of the test, or the agreed between the manufacturer and the purchaser of the product.

Definition related to the performance level:

1. Based on the used product standard
2. Based on the declaration of the manufacturer, requestor or purchaser

For EN 55035

Performance criterion A:

The equipment shall continue to operate as intended without operator intervention. No degradation of performance, loss of function or change of operating state is allowed below a performance level specified by the manufacturer when the equipment is used as intended. The performance level may be replaced by a permissible loss of performance. If the minimum performance level or the permissible performance loss is not specified by the manufacturer, then either of these may be derived from the product description and documentation, and by what the user may reasonably expect from the equipment if used as intended.

Performance criterion B:

During the application of the disturbance, degradation of performance is allowed. However, no unintended change of actual operating state or stored data is allowed to persist after the test.

After the test, the equipment shall continue to operate as intended without operator intervention; no degradation of performance or loss of function is allowed, below a performance level specified by the manufacturer, when the equipment is used as intended. The performance level may be replaced by a permissible loss of performance.

If the minimum performance level (or the permissible performance loss), or recovery time, is not specified by the manufacturer, then either of these may be derived from the product description and documentation, and by what the user may reasonably expect from the equipment if used as intended.

Performance criterion C:

Loss of function is allowed, provided the function is self-recoverable, or can be restored by the operation of the controls by the user in accordance with the manufacturer's instructions. A reboot or re-start operation is allowed.

Information stored in non-volatile memory, or protected by a battery backup, shall not be lost.

Performance criteria for audio output function

Performance criterion for all other devices	
Criteria A	The measured acoustic interference ratio and/or the measured electrical interference ratio during the test shall be -20 dB or better.
Criteria B	Use the general performance criterion B.
Criteria C	Use the general performance criterion C

8. ELECTROSTATIC DISCHARGE IMMUNITY TEST

8.1. Test Equipments

Item	Equipment	Manufacturer	Model No.	Serial No.	Last Cal.	Cal. Interval
1.	ESD Room	AUDIX	N/A	N/A	Apr.17,19	3 Year
2.	ESD Tester	EM Test	Dito	P1723199429	Oct.21,20	1 Year

8.2. Block Diagram of Test Setup

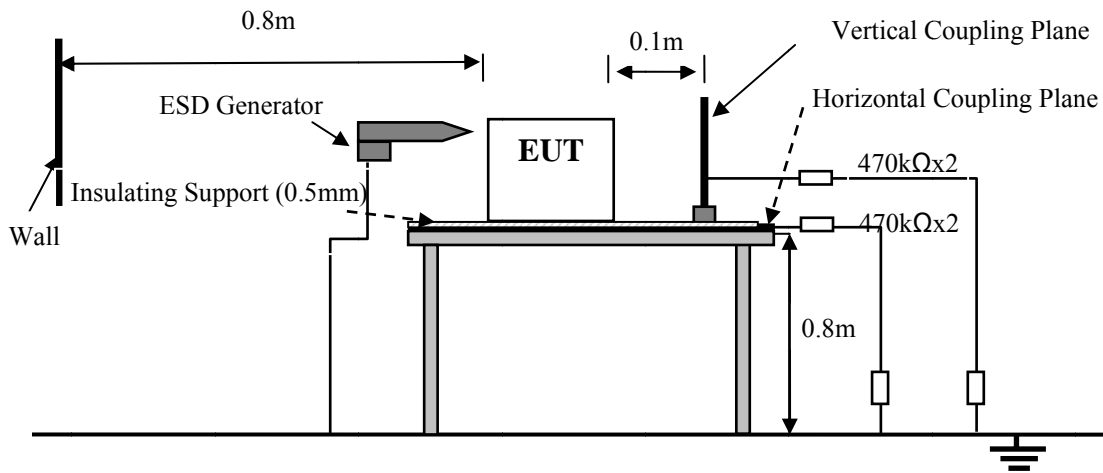

8.3. Test Standard

IEC 61000-4-2: 2008

(Severity for Air Discharge was Level 1 at ± 2 kV & Level 2 at ± 4 kV & Level 3 at ± 8 kV, for Contact Discharge was Level 2 at ± 4 kV)

8.4. Severity Levels and Performance Criterion

Severity Level	Test Voltage Contact Discharge (kV)	Test Voltage Air Discharge (kV)	Performance criterion
1.	2	2	B
2.	4	4	
3.	6	8	
4.	8	15	
X	Special	Special	

8.5. EUT Configuration

The configurations of EUT are listed in Section 3.5.

8.6. Operating Condition of EUT

Same as Conducted Emission test that listed in Section 3.6. except the test set up replaced by Section 8.2.

8.7. Test Procedure

8.7.1. Air Discharge:

The test was applied on non-conductive surfaces of EUT. The round discharge tip of the discharge electrode was approached as fast as possible to touch the EUT. After each discharge, the discharge electrode was removed from the EUT. The generator was re-triggered for a new single discharge and repeated 20 times for each pre-selected test point. This procedure was repeated until all the air discharge completed

8.7.2. Contact Discharge:

All the procedure was same as Section 8.7.1. except that the generator was re-triggered for a new single discharge and repeated 20 times for each pre-selected test point. The tip of the discharge electrode was touching the EUT before the discharge switch was operated.

8.7.3. Indirect discharge for horizontal coupling plane:

At least 10 single discharges were applied to the horizontal coupling plane, at points on each side of the EUT. The discharge electrode positions vertically at a distance of 0.1m from the EUT and with the discharge electrode touching the coupling plane.

8.7.4. Indirect discharge for vertical coupling plane:

At least 10 single discharges were applied to the center of one vertical edge of the coupling plane. The coupling plane, of dimensions 0.5m X 0.5m, was placed parallel to, and positioned at a distance of 0.1m from the EUT. Discharges were applied to the coupling plane, with this plane in sufficient different positions that the four faces of the EUT are completely illuminated.

8.8. Test Results

PASS. (Test results are recorded in next page)

Electrostatic Discharge Test Results

Audix Technology (Shenzhen) Co., Ltd.

EUT	LCD Monitor	Model No.	AG274U
Test Date	Jun.21, 2021	Temperature	23.6±0.6℃
Input Power	AC 230V/50Hz; AC 100V/50Hz	Humidity	52±3%
Test Mode	PC Mode	Pressure	101.6±1kPa
Tested By	Kennen	Result	Pass

Air Discharge	Voltage Level kV / Discharge per polarity 10 / Observation								
Test Location	+2	-2	+4	-4	+8	-8	---	---	Comments
DC Ports(1)	ND	ND	ND	ND	ND	ND	---	---	---
MIC OUT (2)	ND	ND	ND	ND	ND	ND	---	---	---
HDMI Port(3)	A	A	A	A	B*	B*	---	---	---
DP Port (4)	A	A	A	A	B*	B*	---	---	---
USB 3.0 Ports (5)	A	A	A	A	B*	B*	---	---	---
Type-C Port (6)	A	A	A	A	B*	B*	---	---	---
Mini USB Port (7)	ND	ND	ND	ND	A	A	---	---	---
USB UP-Stream Port (8)	ND	ND	ND	ND	B*	B*	---	---	---
MIC In Port (9)	ND	ND	ND	ND	ND	ND	---	---	---
Slots (10)	ND	ND	ND	ND	ND	ND	---	---	---
Screen (11)	ND	ND	ND	ND	B*	B*	---	---	---
LED (12)	ND	ND	ND	ND	ND	ND	---	---	---
Buttons (13)	ND	ND	ND	ND	A	A	---	---	---
Keylock (14)	ND	ND	ND	ND	ND	ND	---	---	---
AUDIO OUT (17)	ND	ND	ND	ND	A	A			

Contact Discharge	Voltage Level Kv / Discharge per polarity 10 / Observation								
Test Location	+4	-4	---	---	---	---	---	---	Comments
Metal (15)	B*	B*	---	---	---	---	---	---	---
Screws (16)	B*	B*	---	---	---	---	---	---	---

Indirect Contact	Voltage Level Kv / Discharge per polarity 10 / Observation								
Test Location	+4	-4	---	---	---	---	---	---	Comments
VCP Front	A	A	---	---	---	---	---	---	---
VCP Right	A	A	---	---	---	---	---	---	---
VCP Left	A	A	---	---	---	---	---	---	---
VCP Back	A	A	---	---	---	---	---	---	---
HCP Bottom	A	A	---	---	---	---	---	---	---

Additional Notes

Measurement Points Please refer to the Photos of ESD Test Points

ND=No Discharge; Meets criteria but unable to obtain an electrostatic discharge (ESD) at this test point.
 Note: The class "B*" means the screen of EUT will be twinkle during test, but it can recover by itself after test.

Adapter	
Adapter#1	ADP-230JB D
Adapter#2	FSP230-AJAN3

After discharge to the ungrounded part of EUT, it needs the bleeder resistor to remove the charge prior to next ESD pulse.
 Discharge was considered on Contact and Air and Horizontal Coupling Plane (HCP) and Vertical Coupling Plane (VCP).

8.9. ESD Test Point Photos

ESD Figure 1
General Appearance of the EUT

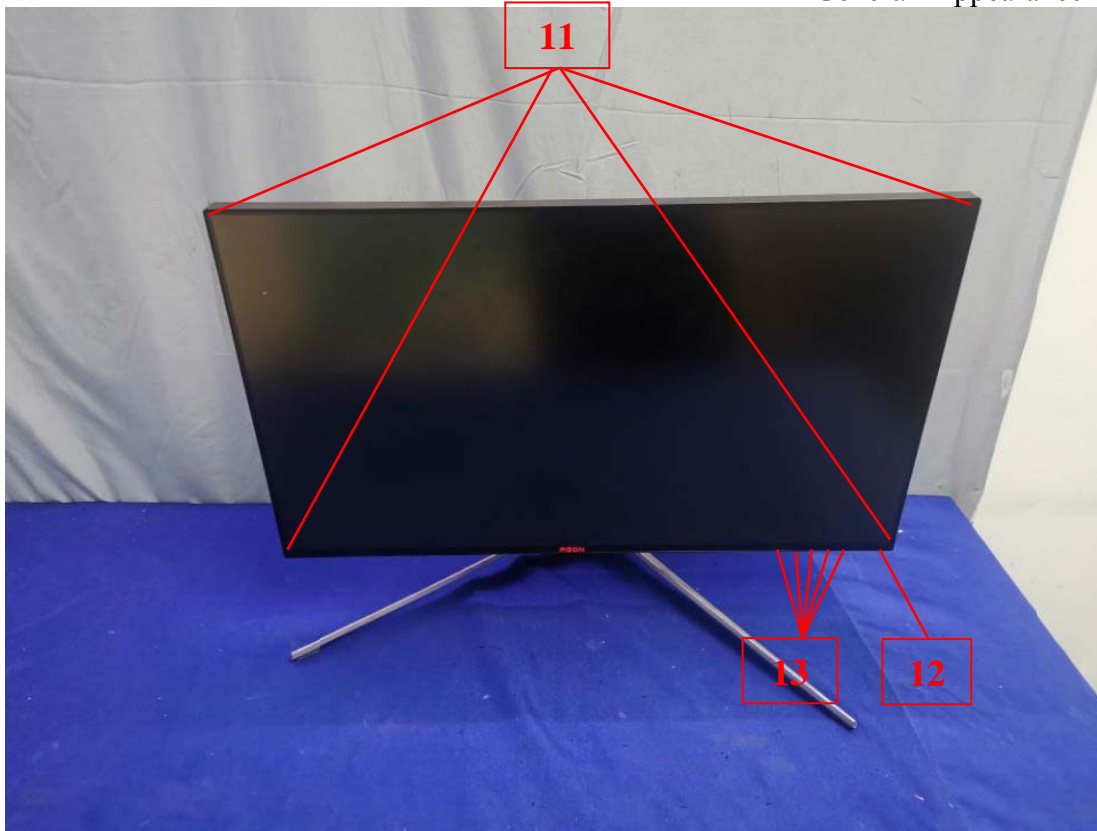

ESD Figure 2
General Appearance of the EUT

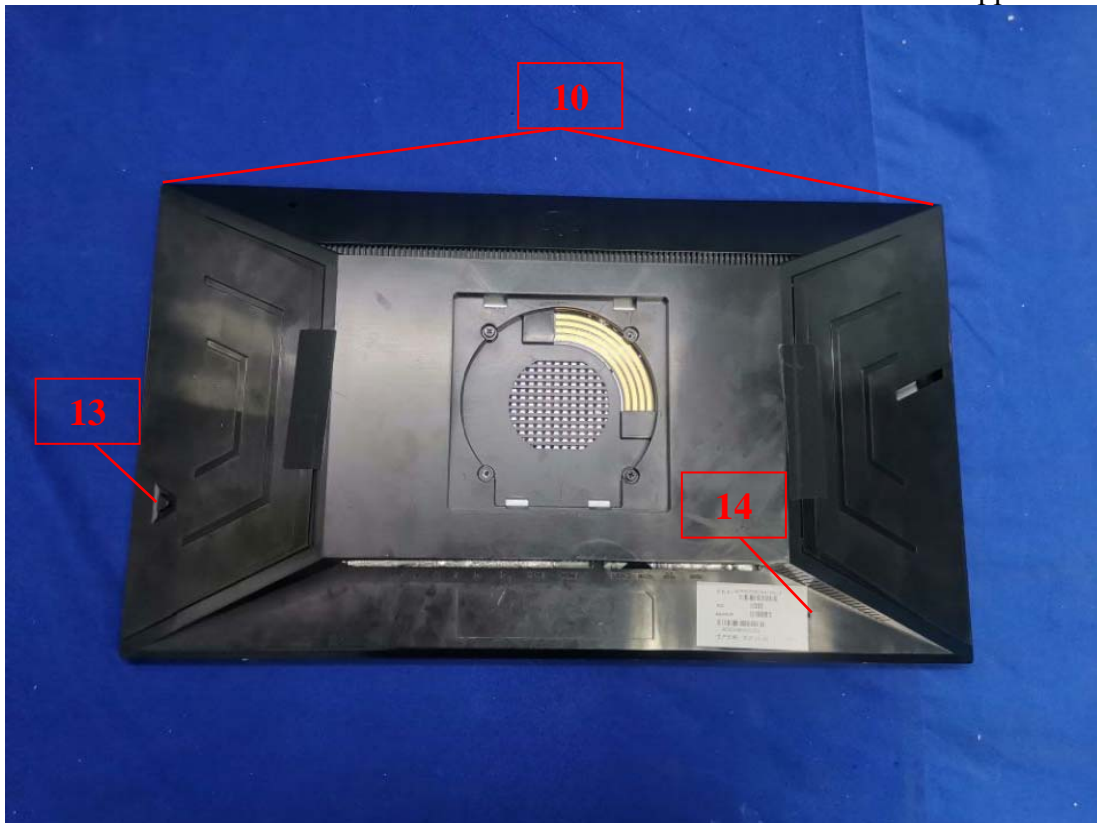

ESD Figure 4
General Appearance of the EUT



9. RF FIELD STRENGTH SUSCEPTIBILITY TEST

9.1. Test Equipments

For frequency range: 80-1000MHz

Item	Equipment	Manufacturer	Model No.	Serial No.	Last Cal.	Cal. Interval
1.	RS Chamber(FU)	AUDIX	N/A	N/A	Apr.12,21	1 Year
2.	RS Chamber(SE)	AUDIX	N/A	N/A	Apr.16,19	3 Year
3.	MXG Analog Signal Generator	Agilent	N5181A	MY49061013	Oct.11,20	1 Year
4.	Amplifier	R flight	NTWPA-00810 200E	19053131	Apr.07,21	1 Year
5.	Field Monitor	A&R	FM7004	325983	NCR	NCR
6.	Field Probe	A&R	FM7006	0325736	Oct.30,20	1 Year
7.	Log-periodic Antenna	A&R	AT1080	16512	NCR	NCR
8.	RF Cable	STORM	MFR-57500	NO.2	NCR	NCR
9.	RF Cable	EMCI	EMCCFD400- NM-NM-5000	190410	NCR	NCR
10.	Audio Analyzer	Rohde & Schwarz	UPL	100687	Apr.13,21	1 Year
11.	Test Software	AUDIX	i2	3.2010-1-7	N/A	N/A

Notes: NCR means no calibration required(calibrated with system).

Notes: N/A means Not applicable.

Frequency Range: Above 1000MHz

Item	Equipment	Manufacturer	Model No.	Serial No.	Last Cal.	Cal. Interval
1.	RS Chamber(FU)	AUDIX	N/A	N/A	Apr.12,21	1 Year
2.	RF Chamber(FU)	AUDIX	N/A	N/A	Apr.12,21	1 Year
3.	RS Chamber(SE)	AUDIX	N/A	N/A	Apr.16,19	3 Year
4.	MXG Analog Signal Generator	Agilent	N5181A	MY49061013	Oct.11,20	1 Year
5.	Amplifier	R flight	NTWPA-1060 100E	19053151	Apr.07,21	1 Year
6.	MICROWAVE HORN ANTENNA	SCHWARZBEC K	STLP9149	00600	NCR	NCR
7.	Field Monitor	A&R	FM7004	325983	NCR	NCR
8.	Field Probe	A&R	FM7006	0325736	Oct.30,20	1 Year
9.	RF Cable	STORM	MFR-57500	NO.2	NCR	NCR
10.	RF Cable	EMCI	EMCCFD400- NM-NM-5000	190410	NCR	NCR
11.	Audio Analyzer	Rohde & Schwarz	UPL	100687	Apr.13,21	1 Year
12.	Test Software	AUDIX	i2	3.2010-1-7	N/A	N/A

Notes: NCR means no calibration required (calibrated with system).

Notes: N/A means Not applicable.

9.2. Block Diagram of Test Setup

For frequency range: 80-1000MHz

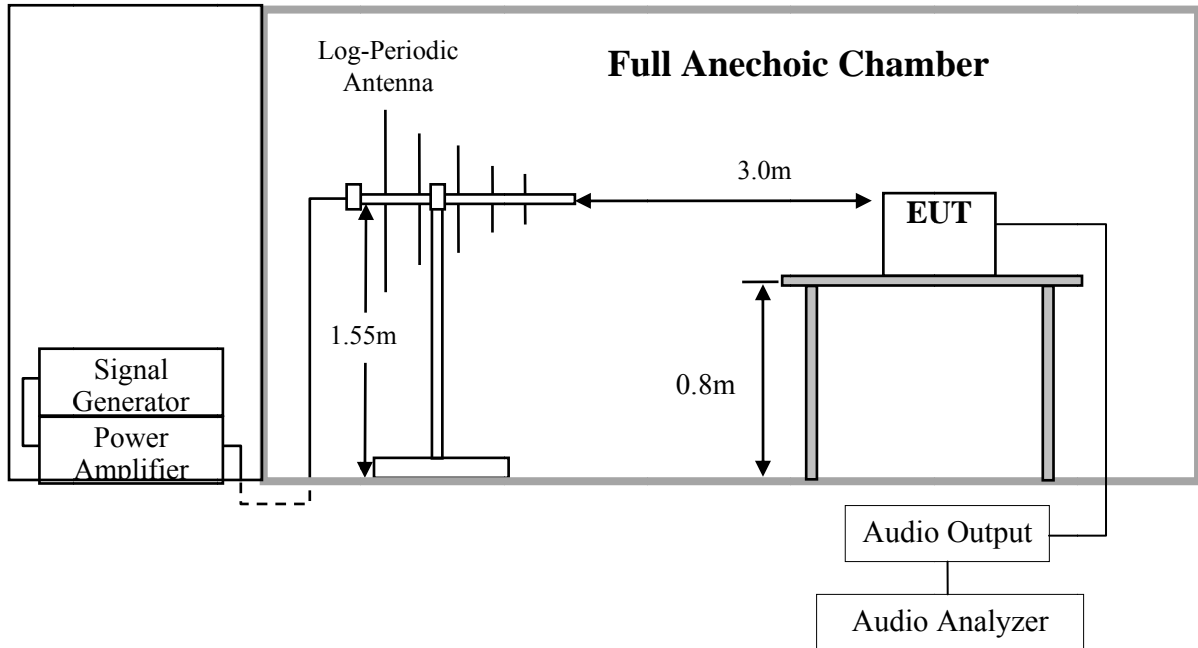

For frequency range above 1GHz

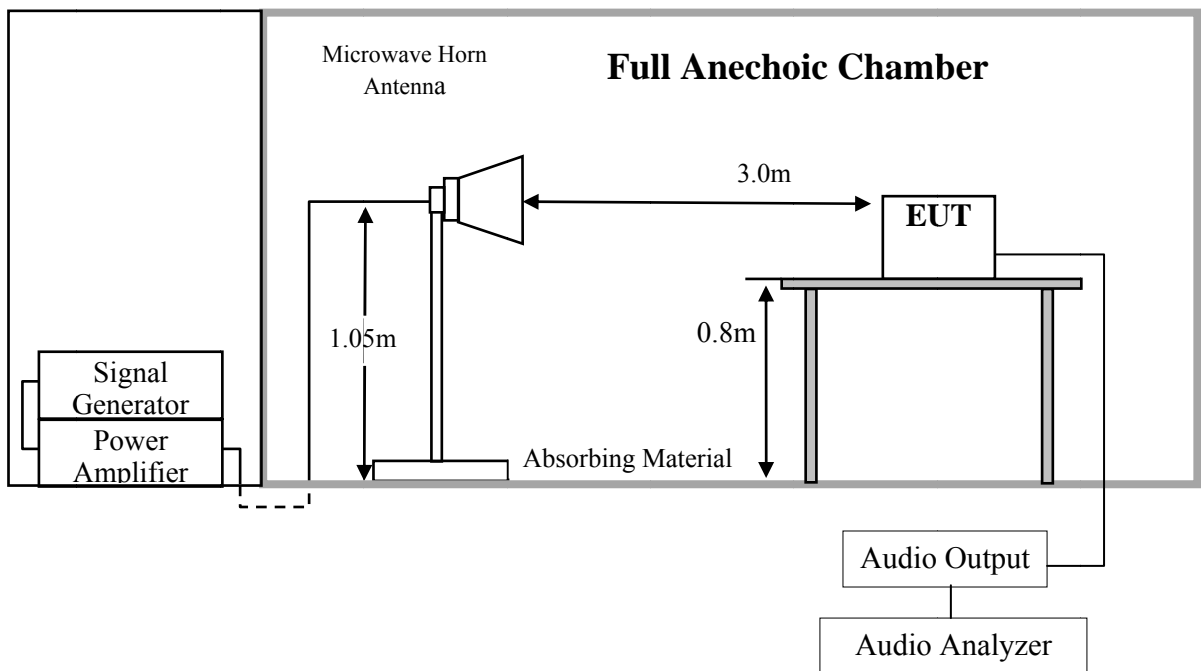

9.3. Test Standard

IEC 61000-4-3: 2010

(Severity Level: 2 at 3V / m)

9.4. Severity Levels and Performance Criterion

Severity Level	Test Field Strength V/m	Performance Criteria
1.	1	A
2.	3	
3.	10	
X.	Special	

9.5. EUT Configuration

The configurations of EUT are listed in Section 3.5.

9.6. Operating Condition of EUT

Same as Conducted Emission test that listed in Section 3.6. Except the test set up replaced by Section 9.2.

9.7. Test Procedure

The field sensor is placed on the EUT table which is 3 meters away from the transmitting antenna. Through the signal generator, power amplifier and transmitting antenna to produce a uniformity field strength around the EUT table from frequency range 80MHz-1000MHz and records the signal generator's output level at the same time for whole measured frequency range. Then, put EUT and its simulators on the non-metallic table and keep them 3 meters (3V/m measured by field sensor) away from the transmitting antenna which is mounted on an antenna tower and fixes at 1.55 meter height(for frequency range 80MHz-1000MHz) or 1.05 meter height (for frequency range above 1GHz) above the ground. Using the recorded signal generator's output level to measure the EUT from frequency range 80MHz-1000MHz or for frequency range above 1GHz and both horizontal & vertical polarization of antenna must be set and measured. Each of the four sides of EUT must be faced this transmitting antenna and measures individually.

All the scanning conditions are as follows:

Test conditions	
Frequency	80MHz-1GHz; 1.8GHz; 2.6GHz; 3.5GHz; 5GHz
Frequency increments step	1% of momentary used
Test level	3V/m (un-modulated)
Dwell time	3s
Test signal	80% amplitude modulated by 1kHz sinusoidal audio signal

9.8. Test Results

PASS. (Test results are recorded in next page)

RF Field Strength Susceptibility Test Results

Audix Technology(Shenzhen) Co.,Ltd.

EUT	LCD Monitor	Model No.	AG274U
Test Date	Jun.20, 2021	Temperature	25.2±0.6℃
Input Power	AC 230V/50Hz; AC 100V/50Hz	Humidity	53±3%
Test Mode	PC Mode	Pressure	101.5±1kPa
Tested By	Kennen	Result	Pass
Test Field Strength	3V/m		

Modulation: AM 1kHz 80% Pulse none

Frequency Range : 80-1000MHz; 1.8GHz; 2.6GHz; 3.5GHz; 5GHz

	Horizontal		Vertical		Result (Pass / Fail)
	Required	Observation	Required	Observation	
Front	A	A	A	A	Pass
Right	A	A	A	A	Pass
Rear	A	A	A	A	Pass
Left	A	A	A	A	Pass

Audio output function test

Port	Polarization	Demodulated Audio Level (dBV)	Electrical Reference Level(dBV)	Electrical interference ratio(dB)	Limit(dB)
AUDIO OUT	V	-43.6 ^{Note}	-4.2	-39.4 ^{Note}	-20
AUDIO OUT	H	-44.8 ^{Note}	-4.2	-40.6 ^{Note}	-20
Speaker R	V	-48.9 ^{Note}	-5.9	-43 ^{Note}	-20
Speaker R	H	-48.2 ^{Note}	-5.9	-42.3 ^{Note}	-20
Speaker L	V	-49.5 ^{Note}	-5.9	-43.6 ^{Note}	-20
Speaker L	H	-49.6 ^{Note}	-5.9	-43.7 ^{Note}	-20

Note means worst frequency between 80-5000MHz

Adapter

Adapter#1	ADP-230JB D
Adapter#2	FSP230-AJAN3

10. ELECTRICAL FAST TRANSIENT/BURST IMMUNITY TEST

10.1. Test Equipments

Item	Equipment	Manufacturer	Model No.	Serial No.	Last Cal.	Cal. Interval
1.	ESD Room	AUDIX	N/A	N/A	Apr.17,19	3 Year
2.	Burst Tester	TESEQ	NSG 3025	28017	Apr.07,21	1 Year
3.	Test Software	Schaffner	Win3025	V 4.00	N/A	N/A

Note: N/A means Not applicable.

10.2. Block Diagram of Test Setup

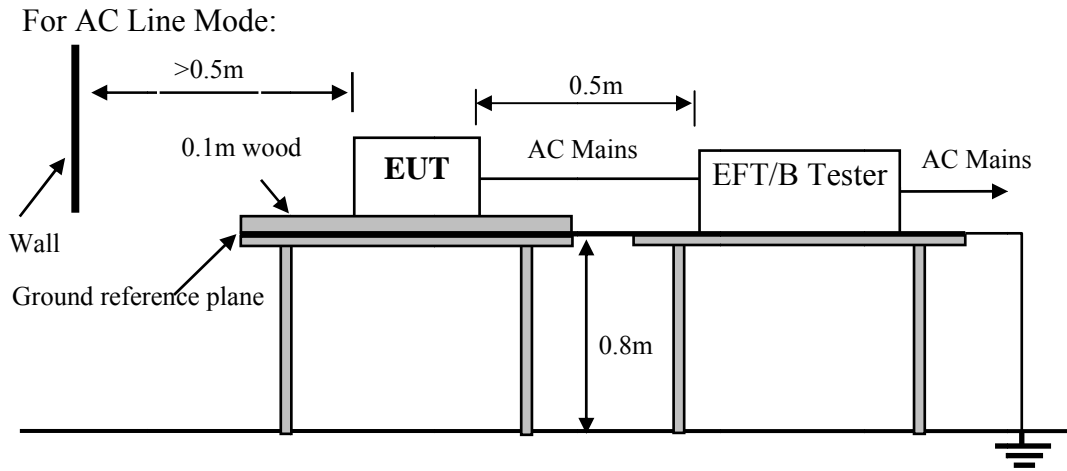

10.3. Test Standard

IEC 61000-4-4: 2012

(Severity Level: Level 1 at 0.5kV, Level 2 at 1kV)

10.4. Severity Levels and Performance Criterion

Open Circuit Output Test Voltage $\pm 10\%$			
Severity Level	On Power Supply Lines	On I/O (Input / Output) Signal data and control lines	Performance criterion
1.	0.5 kV	0.25 kV	B
2.	1 kV	0.5 kV	
3.	2 kV	1 kV	
4.	4 kV	2 kV	
X	Special	Special	

10.5. EUT Configuration

The configurations of EUT are listed in Section 3.5.

10.6. Operating Condition of EUT

Same as Conducted Emission test that listed in Section 3.6. except the test set up replaced by Section 10.2.

10.7. Test Procedure

The EUT and its simulators were placed on the ground reference plane and were insulated from it by a wood support $0.1\text{m} \pm 0.01\text{m}$ thick. The ground reference plane was $1\text{m} \times 1\text{m}$ metallic sheet with 0.65mm minimum thickness. This reference ground plane was project beyond the EUT by at least 0.1m on all sides and the minimum distance between EUT and all other conductive structure, except the ground plane was more than 0.5m. All cables to the EUT was placed on the wood support, cables not subject to EFT/B was routed as far as possible from the cable under test to minimize the coupling between the cables.

10.7.1. For input and AC power ports:

The EUT was connected to the power mains by using a coupling device that couples the EFT interference signal to AC power lines. Both positive transients and negative transients of test voltage were applied during compliance test and the duration of the test can't less than 1min.

10.7.2. For signal lines and control lines ports:

It's unnecessary to test.

10.7.3. For DC input and DC output power ports:

It's unnecessary to test.

10.8. Test Results

PASS. (Test results are recorded in next page)

Electrical Fast Transient/Burst Test Results

Audix Technology (Shenzhen) Co., Ltd.

EUT	LCD Monitor	Model No.	AG274U
Test Date	Jun.21, 2021	Temperature	23.2±0.6°C
Input Power	AC 230V/50Hz; AC 100V/50Hz	Humidity	54±3%
Test Mode	PC Mode	Pressure	101.6±1kPa
Tested By	Kennen	Result	Pass

Repetition Frequency : 5 kHz Burst Duration : 15ms Burst Period: 300ms

Inject Time(s): 120s
 Inject Line(Inject Method): AC Mains (Direct) DC Supply Signal(Capacitive Clamp)

Line	Test Voltage	Performance			Result (Pass/Fail)
		Required	Observation(+)	Observation(-)	
L	0.5kV	B	A	A	Pass
	1kV	B	B*	B*	Pass
N	0.5kV	B	A	A	Pass
	1kV	B	B*	B*	Pass
PE	0.5kV	B	A	A	Pass
	1kV	B	B*	B*	Pass
L N	0.5kV	B	A	A	Pass
	1kV	B	B*	B*	Pass
L PE	0.5kV	B	A	A	Pass
	1kV	B	B*	B*	Pass
N PE	0.5kV	B	A	A	Pass
	1kV	B	B*	B*	Pass
L N PE	0.5kV	B	A	A	Pass
	1kV	B	B*	B*	Pass

Remark: The class "B*" means the screen of EUT will be twinkle during the test, but it will recover to by itself.

Adapter	
Adapter#1	ADP-230JB D
Adapter#2	FSP230-AJAN3

11. SURGE TEST

11.1. Test Equipments

Item	Equipment	Manufacturer	Model No.	Serial No.	Last Cal.	Cal. Interval
1.	ESD Room	AUDIX	N/A	N/A	Apr.17,19	3 Year
2.	Transient Test System	EMC PARTNER	TRANSIENT 2000	TRA2006 F-S-T-D-R -1500	Apr,08,21	1 Year
3.	Test Software	EMC PARTNER	Genecs	V3.25	N/A	N/A

Note: N/A means Not applicable.

11.2. Block Diagram of Test Setup

For AC Line Mode:

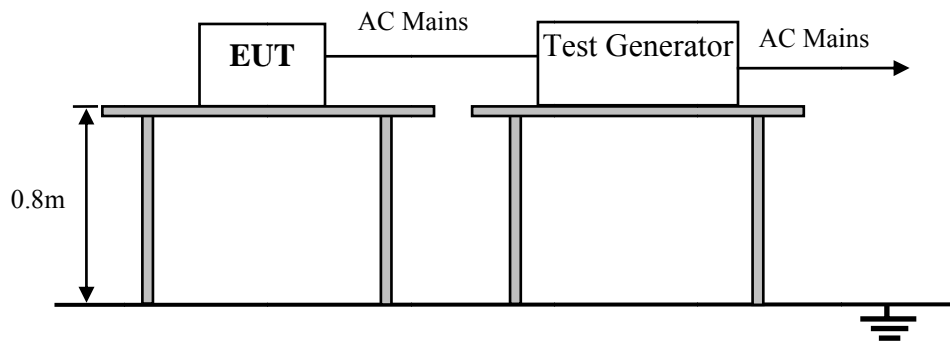

11.3. Test Standard

IEC 61000-4-5: 2014

IEC 61000-4-5: 2014+A1: 2017

(Severity Level: Line to Line was Level 2 at 1kV,

Line to Ground was Level 2 at 1kV& Level 3 at 2kV)

11.4. Severity Levels and Performance Criterion

Severity Level	Open-Circuit Test Voltage kV	Performance criterion
1	0.5	B
2	1.0	
3	2.0	
4	4.0	
*	Special	

11.5. EUT Configuration

The configurations of EUT are listed in Section 3.5.

11.6. Operating Condition of EUT

Same as Conducted Emission test that listed in Section 3.6. except the test set up replaced by Section 11.2

11.7. Test Procedure

- 1) Set up the EUT and test generator as shown on Section 11.2.
- 2) For line-to-line coupling mode, provide a 1kV 1.2/50us voltage surge (at open-circuit condition) and 8/20us current surge to EUT selected points, and for active line / neutral lines to ground are same except test level is 2kV.
- 3) At least 5 positive and 5 negative (polarity) tests with a maximum 1/min repetition rate are applied during test.
- 4) Different phase angles are done individually.
- 5) Record the EUT operating situation during compliance test and decide the EUT immunity criterion for above each test.

11.8. Test Results

PASS. (Test results are recorded in next page)

Surge Immunity Test Results

Audix Technology (Shenzhen) Co., Ltd.

EUT	LCD Monitor	Model No.	AG274U
Test Date	Jun.21, 2021	Temperature	24.6±0.6°C
Input Power	AC 230V/50Hz; AC 100V/50Hz	Humidity	52±3%
Test Mode	PC Mode	Pressure	101.6±1kPa
Tested By	Kennen	Result	Pass

Repetition: 5 times per test Interval:60 Seconds

Line : AC Mains DC Supply Signal(LAN)

Location	Volt	500V			1kV			2kV			Result
	Phase	Performance			Performance			Performance			(Pass/Fail)
		Required	+	-	Required	+	-	Required	+	-	
L-N	0°	---	---	---	B	A	A	---	---	---	Pass
	90°	---	---	---	B	A	A	---	---	---	Pass
	180°	---	---	---	B	A	A	---	---	---	Pass
	270°	---	---	---	B	A	A	---	---	---	Pass
L-PE	0°	---	---	---	B	A	A	B	B*	B*	Pass
	90°	---	---	---	B	A	A	B	B*	B*	Pass
	180°	---	---	---	B	A	A	B	B*	B*	Pass
	270°	---	---	---	B	A	A	B	B*	B*	Pass
N-PE	0°	---	---	---	B	A	A	B	B*	B*	Pass
	90°	---	---	---	B	A	A	B	B*	B*	Pass
	180°	---	---	---	B	A	A	B	B*	B*	Pass
	270°	---	---	---	B	A	A	B	B*	B*	Pass
LAN Line	---	---	---	---	---	---	---	---	---	---	---

Remark: The class “B*” Means the screen of the EUT will be twinkle during test, but it can recover by itself.

Adapter

Adapter#1	ADP-230JB D
Adapter#2	FSP230-AJAN3

12. CONTINUOUS CONDUCTED DISTURBANCE TEST

12.1. Test Equipments

Item	Equipment	Manufacturer	Model No.	Serial No.	Last Cal.	Cal. Interval
1.	MXG Analog Signal Generator	Agilent	N5181A	MY49061013	Oct.11,20	1 Year
2.	Amplifier	Rflight	NTWPA-4K04100	20073132	Jul.11,20	1 Year
3.	Power meter	HP	436A	2016A07891	Apr.06,21	1 Year
4.	Power sensor	Agilent	8482B	MY41090514	Apr.06,21	1 Year
5.	CDN	FCC	FCC-801-M3-25A	07045	Apr.07,21	1 Year
6.	CDN	TESEQ	CDN M016	34609	Apr.07,21	1 Year
7.	Attenuator	Weinschel	40-6-34	LJ092	Apr.07,21	1 Year
8.	Terminator	Hubersuhner	50Ω	No.3	Apr.06,21	1 Year
9.	RF Cable	MICABLE	A04-07-07-7M	09111341	NCR	NCR
10.	RF Cable	STORM	MFR-57500	NO.2	NCR	NCR
11.	RF Cable	STORM	MFR-57500	NO.3	NCR	NCR
12.	Audio Analyzer	Rohde & Schwarz	UPL	100687	Apr.13,21	1 Year
13.	Test Software	AUDIX	i2	3.2010-1-7	N/A	N/A

Notes: NCR means no calibration required (calibrated with system).

Notes: N/A means Not applicable.

12.2. Block Diagram of Test Setup

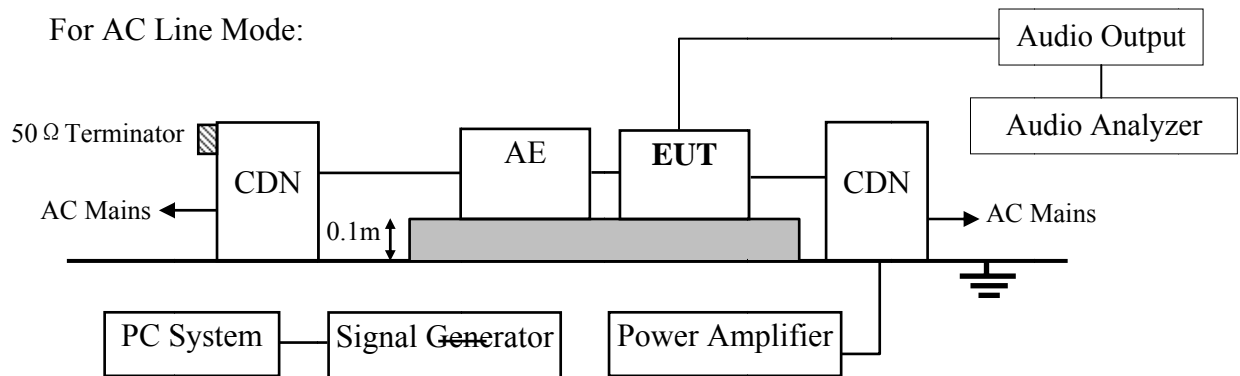

12.3. Test Standard

IEC 61000-4-6: 2013

12.4. Severity Levels and Performance Criterion

Severity Level	Voltage Level (e.m.f.) V	Performance criterion
1	1	A
2	3	
3	10	
X	Special	

12.5. EUT Configuration

The configurations of EUT are listed in Section 3.5.

12.6. Operating Condition of EUT

Same as Conducted Emission test that listed in Section 3.6. except the test set up replaced by Section 12.2.

12.7. Test Procedure

- 1) Set up the EUT, CDN and test generators as shown on Section 12.2.
- 2) Let the EUT work in test mode and test it.
- 3) The EUT are placed on an insulating support 0.1m high above a ground reference plane. CDN (coupling and decoupling device) is placed on the ground plane about 0.3m from EUT. Cables between CDN and EUT are as short as possible, and their height above the ground reference plane shall be between 10 and 30 mm (where possible).
- 4) The disturbance signal described below is injected to EUT through CDN.
- 5) The EUT operates within its operational mode(s) under intended climatic conditions after power on.
- 6) The frequency range is swept from 0.150MHz to 10MHz using 3V signal level, from 10MHz to 30MHz using 3V to 1V signal level, from 30MHz to 80MHz using 1V signal level and with the disturbance signal 80% amplitude modulated with a 1kHz sine wave.
- 7) The rate of sweep shall not exceed 1.5×10^{-3} decades/s. Where the frequency is swept incrementally, the step size shall not exceed 1% of the start and thereafter 1% of the preceding frequency value.
- 8) Recording the EUT operating situation during compliance testing and decide the EUT immunity criterion.

12.8. Test Results

PASS. (Test results are recorded in next page)

Continuous Conducted disturbance Test Results

Audix Technology (Shenzhen)Co.,Ltd.

EUT	LCD Monitor	Model No.	AG274U
Test Date	Jun.20, 2021	Temperature	24.5±0.6°C
Input Power	AC 230V/50Hz; AC 100V/50Hz	Humidity	51±3%
Test Mode	PC Mode	Pressure	101.6±1kPa
Tested By	Hogen	Result	Pass

Frequency Range (MHz)	Injected Position	Voltage Level (e.m.f.)	Required	Observation	Result
					(Pass / Fail)
0.15 ~ 10	AC Mains	3V	A	A	PASS
10 ~ 30	AC Mains	3V~1V	A	A	PASS
30 ~ 80	AC Mains	1V	A	A	PASS

Audio output function test

Port	Injected Position	Demodulated Audio Level (dBV)	Electrical Reference Level(dBV)	Electrical interference ratio(dB)	Limit(dB)
Audio Out	AC Mains	-43.6 ^{Note}	-2.5	-41.1 ^{Note}	-20
Speaker L	AC Mains	-45.8 ^{Note}	-3.8	-42 ^{Note}	-20
Speaker R	AC Mains	-46.2 ^{Note}	-3.8	-42.4 ^{Note}	-20

Note means worst frequency between 0.15-80MHz

Modulation Signal:1kHz 80% AM

Dwell time: 3s

Adapter

Adapter#1	ADP-230JB D
Adapter#2	FSP230-AJAN3

13.MAGNETIC FIELD IMMUNITY TEST

13.1. Test Equipment

Item	Equipment	Manufacturer	Model No.	Serial No.	Last Cal.	Cal. Interval
1.	H/F Room	AUDIX	N/A	N/A	Apr.16,19	3 Year
2.	Magnetic Field Tester	HAEFELY	Mag100.1	083858-10	Apr.08,21	1 Year
3.	Line Disturbances Tester	HAEFELY	PLINE 1610	083690-05	Apr.07,21	1 Year

13.2. Block Diagram of Test Setup

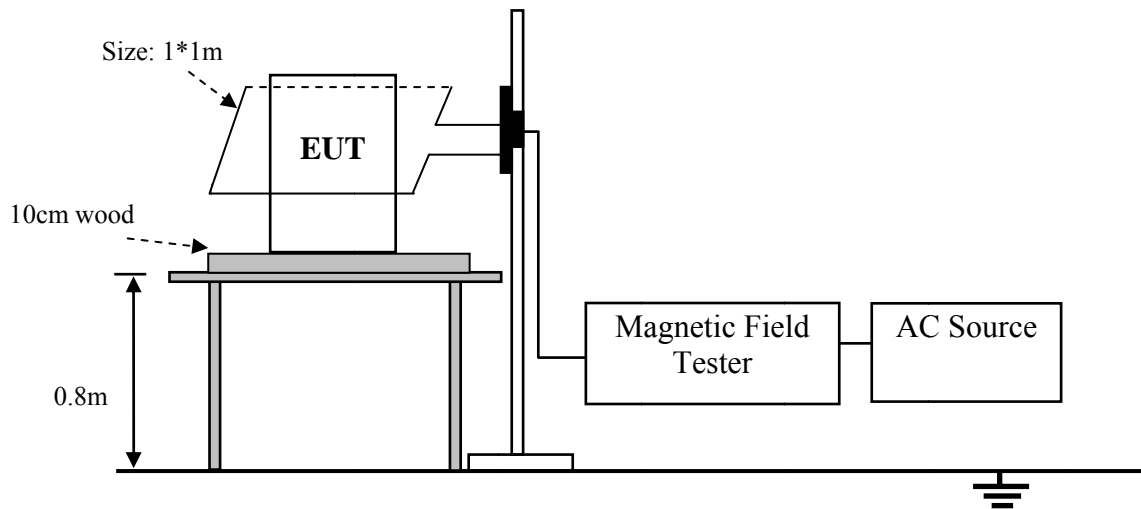

13.3. Test Standard

IEC 61000-4-8: 2009

(Severity Level 1 at 1A/m)

13.4. Severity Levels and Performance Criterion

Severity Level	Magnetic Field Strength A/m	Performance criterion
1.	1	A
2.	3	
3.	10	
4.	30	
5.	100	
X.	Special	

13.5. EUT Configuration on Test

The configurations of EUT are listed in Section 3.5.

13.6. Operating Condition of EUT

Same as Conducted Emission test that listed in Section 3.6. except the test set up replaced by Section 13.2.

13.7. Test Procedure

The EUT was subjected to the test magnetic field by using the induction coil of standard dimensions (1m*1m) and shown in Section 13.2. The induction coil was then rotated by 90° in order to expose the EUT to the test field with different orientations.

13.8. Test Results

PASS. (Test results are recorded in next page)

Magnetic Field Immunity Test Results

Audix Technology (Shenzhen) Co., Ltd.

EUT	LCD Monitor	Model No.	AG274U		
Test Date	Jun.20, 2021	Temperature	24.1±0.6°C		
Input Power	AC 230V/50Hz; AC 100V/50Hz	Humidity	53±3%		
Test Mode	PC Mode	Pressure	101.7±1kPa		
Tested By	Hogen	Result	Pass		
Test Level	Testing Duration	Coil Orientation	Required	Observation	Result
					(Pass/Fail)
1A/m	5 min / coil	X-axis	A	A	PASS
1A/m	5 min / coil	Y-axis	A	A	PASS
1A/m	5 min / coil	Z-axis	A	A	PASS
Adapter					
Adapter#1			ADP-230JB D		
Adapter#2			FSP230-AJAN3		

14. VOLTAGE DIPS AND INTERRUPTIONS TEST

14.1. Test Equipment

Item	Equipment	Manufacturer	Model No.	Serial No.	Last Cal.	Cal. Interval
1.	H/F Room	AUDIX	N/A	N/A	Apr.16,19	3 Year
2.	Line Disturbances Tester	HAEFELY	PLINE 1610	083690-05	Apr.07,21	1 Year

14.2. Block Diagram of Test Setup

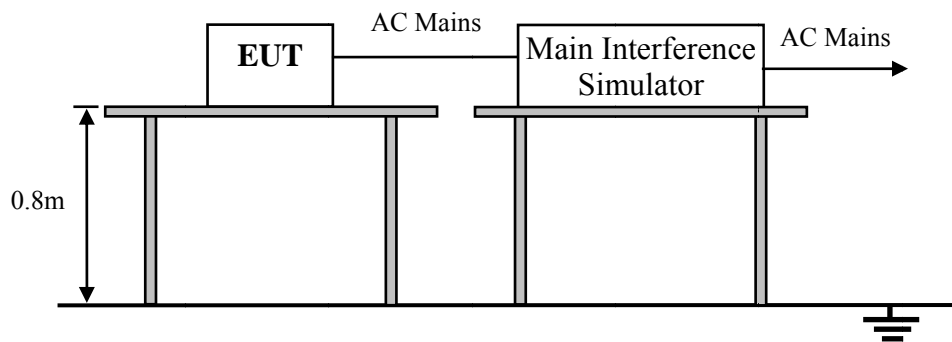

14.3. Test Standard

IEC 61000-4-11: 2004

IEC 61000-4-11: 2004+A1: 2017

IEC 61000-4-11: 2020

14.4. Severity Levels and Performance Criterion

Test Level $\%U_T$	Voltage dip and short interruptions $\%U_T$	Duration (in period)	Performance Criterion
0	100	250/300 ^{Note}	C
0	100	0.5	B
70	30	25/30 ^{Note}	C

Note: "25/30 Cycles" means "25 cycles for 50Hz test" and "30 cycles for 60Hz test".
 "250/300 Cycles" means "250 cycles for 50Hz test" and "300 cycles for 60Hz test"

14.5. EUT Configuration

The configurations of EUT are listed in Section 3.5.

14.6. Operating Condition of EUT

Same as Conducted Emission test that is listed in Section 3.6. except the test set up replaced by Section 14.2.

14.7. Test Procedure

- 1) The EUT and test generator were setup as shown on Section 14.2.
- 2) The interruption is introduced at selected phase angles with specified duration.
- 3) Record any degradation of performance.

14.8. Test Results

PASS. (Test results are recorded in next page)

Voltage Dips And Interruptions Test Results

Audix Technology (Shenzhen) Co., Ltd.

EUT	LCD Monitor	Model No.	AG274U
Test Date	Jun.20, 2021	Temperature	23.6±0.6°C
Input Power	AC 230V/50Hz & AC 100V/50Hz	Humidity	52±3%
Test Mode	PC Mode	Pressure	101.7±1kPa
Tested By	Kennen	Result	Pass

AC 230V/50Hz

Test Level % U _T	Voltage Dips & Short Interruptions % U _T	Duration (in period)	Phase Angle	Required	Observation	Result
						(Pass / Fail)
0	100	0.5P	0°, 90°, 180°, 270°	B	A	PASS
70	30	25P	0°, 90°, 180°, 270°	C	A	PASS
0	100	250P	0°, 90°, 180°, 270°	C	C*	PASS

AC 100V/50Hz

Test Level % U _T	Voltage Dips & Short Interruptions % U _T	Duration (in period)	Phase Angle	Required	Observation	Result
						(Pass / Fail)
0	100	0.5P	0°, 90°, 180°, 270°	B	A	PASS
70	30	25P	0°, 90°, 180°, 270°	C	C*	PASS
0	100	250P	0°, 90°, 180°, 270°	C	C*	PASS

Note 1: U_T is the rated voltage for the equipment.

Note 2: The frequency of the test voltage shall be within ±2% of the rated frequency, the output voltage shall be within ±5% of the rated voltage.

Remark: The Class “C*” means the EUT black screen when power off and data transmitting will interrupted, it need to recover by manual.

Adapter

Adapter#1	ADP-230JB D
Adapter#2	FSP230-AJAN3

15. PHOTOGRAPHS

15.1. Photos of Power Line Conducted Emission Test



15.2. Photos of Radiated Emission Test (In 10m Anechoic Chamber)

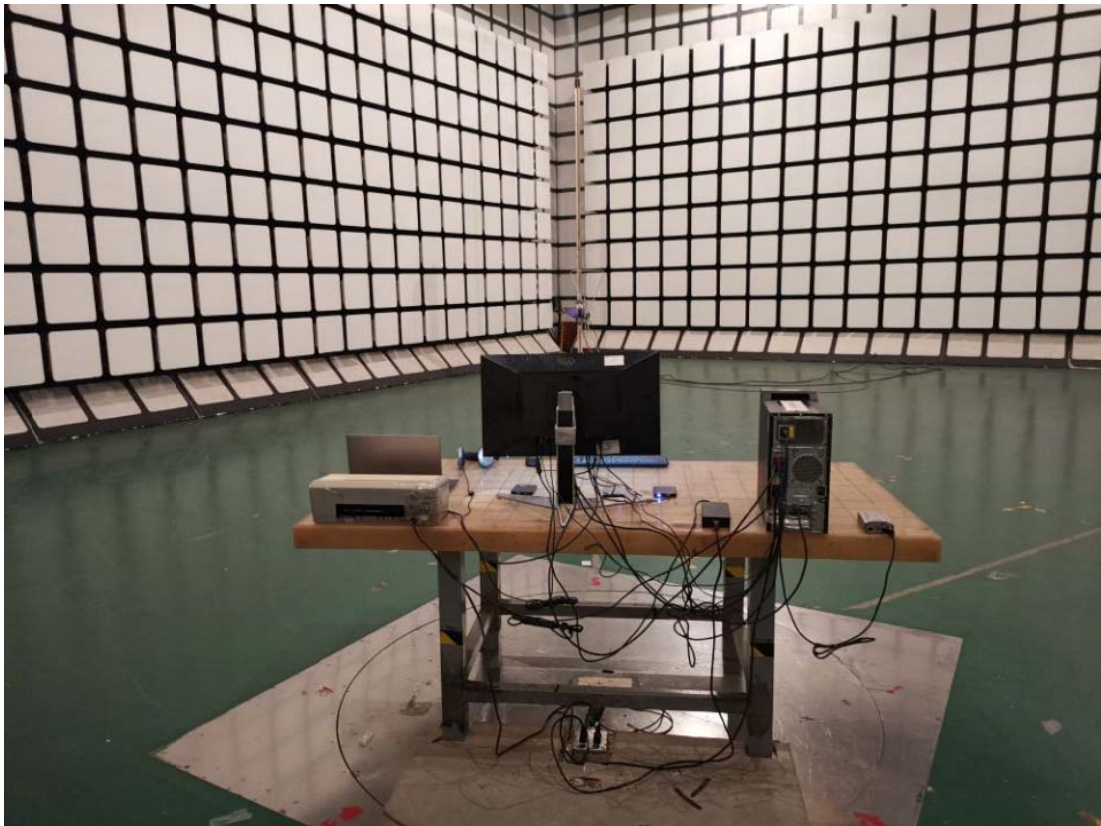

In 10m Anechoic Chamber Test 1GHz – 6GHz

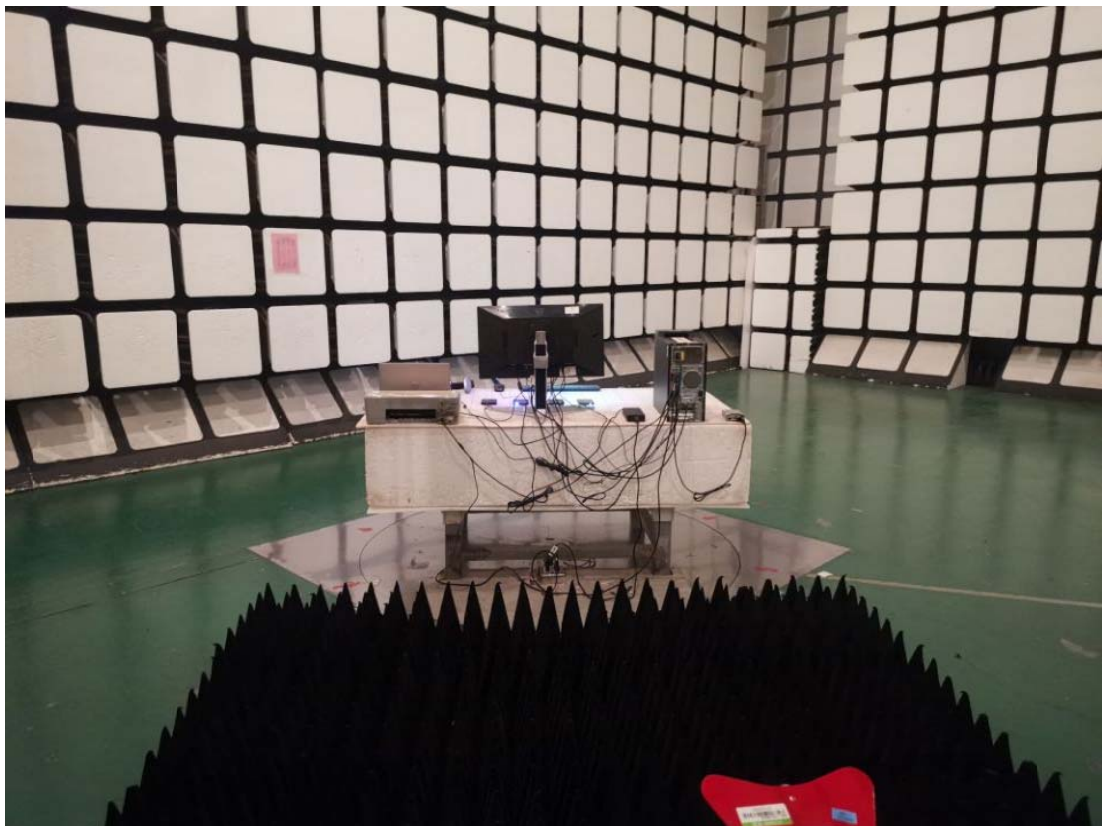

15.3. Photo of Harmonic / Flicker Test



15.4. Photos of Electrostatic Discharge Immunity Test





15.5. Photo of RF Strength Susceptibility Test

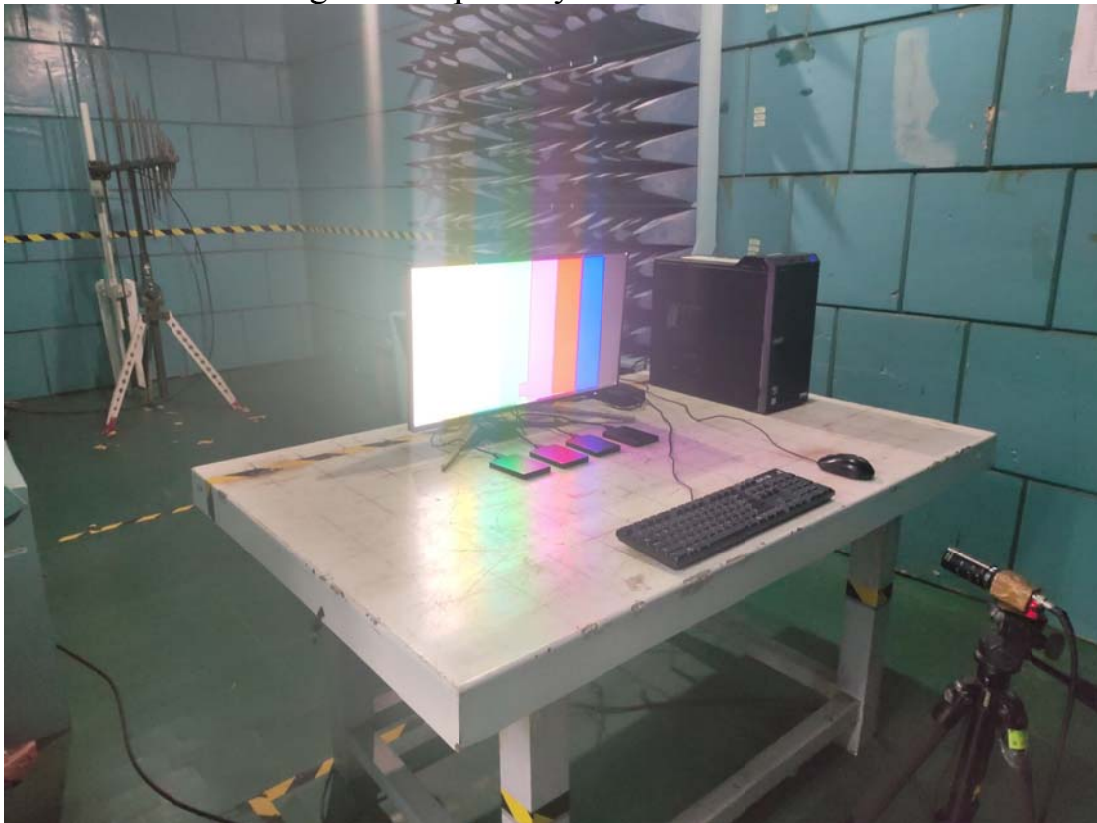

For frequency range above 1GHz

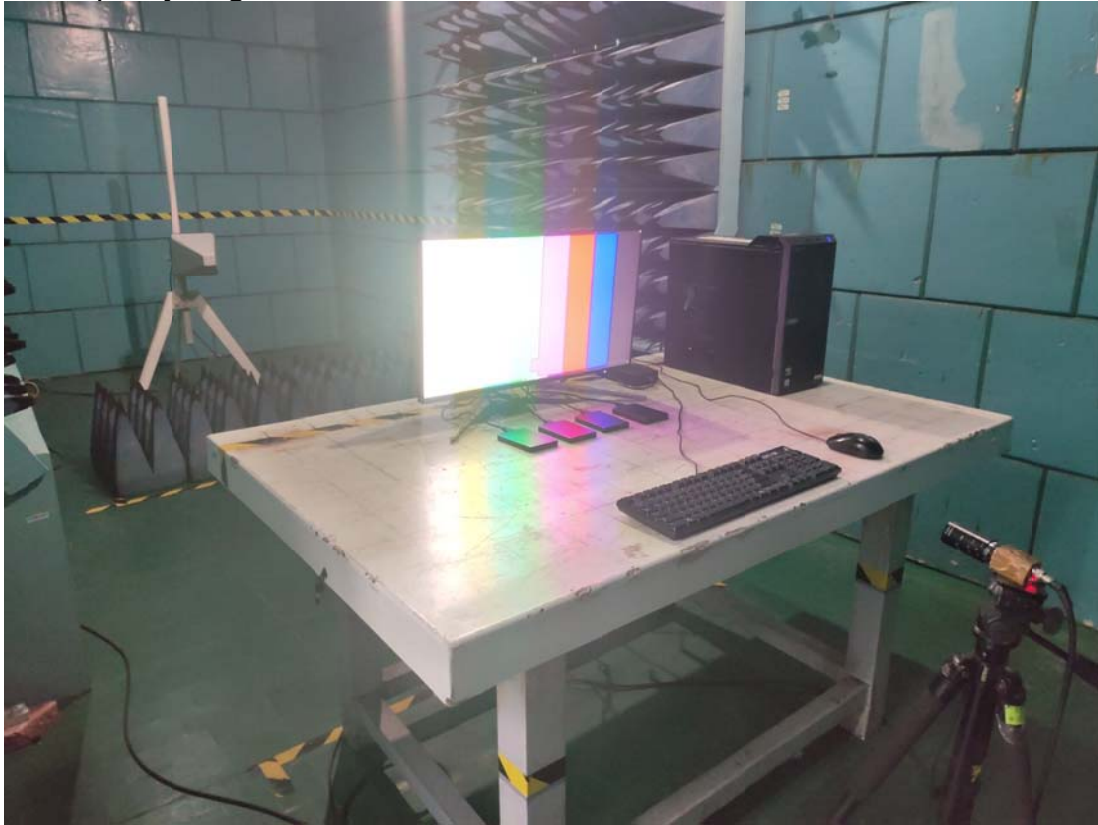

15.6. Photos of Electrical Fast Transient/Burst Immunity Test



15.7. Photos of Surge Test

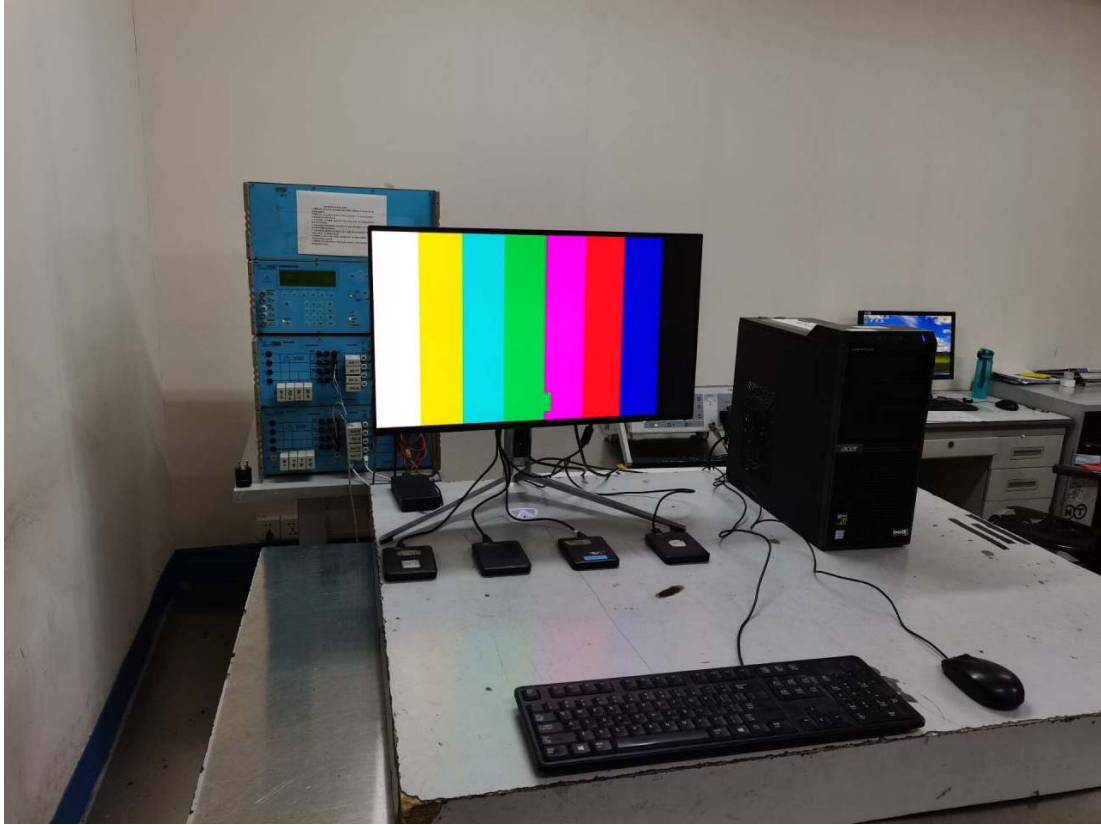

15.8. Photos of Continuous Conducted disturbance Test



15.9. Photo of Magnetic Field Test



15.10. Photo of Voltage Dips and interruptions test



..... **THE END**