



Test Report issued under the responsibility of:



TEST REPORT
IEC 62368-1
Audio/video, information and communication technology equipment
Part 1: Safety requirements

Report Number..... : 60436687 001

Date of issue : Jul.16.2021

Total number of pages : 113

Name of Testing Laboratory
preparing the Report : TÜV Rheinland (Shenzhen) Co., Ltd.

Applicant's name : TPV Electronics (Fujian) Co., Ltd.

Address : Rongqiao Economic and Technological Development Zone,
Fuqing City, Fujian, P.R.China

Test specification:

Standard : IEC 62368-1:2018

Test procedure..... : CB Scheme

Non-standard test method..... : N/A

TRF template used : IECEE OD-2020-F1:2020, Ed.1.3

Test Report Form No..... : IEC62368_1E

Test Report Form(s) Originator.... : UL(US)

Master TRF : Dated 2021-02-04

Copyright © 2021 IEC System of Conformity Assessment Schemes for Electrotechnical Equipment and Components (IECEE System). All rights reserved.

This publication may be reproduced in whole or in part for non-commercial purposes as long as the IECEE is acknowledged as copyright owner and source of the material. IECEE takes no responsibility for and will not assume liability for damages resulting from the reader's interpretation of the reproduced material due to its placement and context.

If this Test Report Form is used by non-IECEE members, the IECEE/IEC logo and the reference to the CB Scheme procedure shall be removed.

This report is not valid as a CB Test Report unless signed by an approved CB Testing Laboratory and appended to a CB Test Certificate issued by an NCB in accordance with IECEE 02.

General disclaimer:

The test results presented in this report relate only to the object tested.

This report shall not be reproduced, except in full, without the written approval of the Issuing CB Testing Laboratory. The authenticity of this Test Report and its contents can be verified by contacting the NCB, responsible for this Test Report.

Test item description	LCD MONITOR (LED backlight)	
Trade Mark(s)	AOC	
Manufacturer	Same as applicant	
Model/Type reference	24G1*****, C24G1*****, C*24G1*****, Q24G1*****, U24G1*****, 24G2*****, C24G2*****, C*24G2*****, Q24G2*****, U24G2*****, 27G1*****, C27G1*****, C*27G1*****, Q27G1*****, U27G1*****, 27G2*****, C27G2*****, C*27G2*****, Q27G2*****, U27G2*****, (* can be 0-9, A-Z, a-z, "+", "-", "/", "\", or blank, Represent different enclosure colour and sales region for marketing purpose. No technology differences)	
Ratings	I/P: 100-240V~, 50/60Hz, 1.5A	
Responsible Testing Laboratory (as applicable), testing procedure and testing location(s):		
<input checked="" type="checkbox"/>	CB Testing Laboratory:	TÜV Rheinland (Shenzhen) Co., Ltd.
Testing location/ address	1601 R&D Room, 1602-1604, 17-18F, Building 7 Site C, Vanke Cloud City Phase I, Xingke First Street, Xili Street, Xili Community, Nanshan District, Shenzhen 518052, P.R. China	
Tested by (name, function, signature)	Anderson Wang Senior Project Manager	
Approved by (name, function, signature) ..	Steven Lin Technical Reviewer	
<input type="checkbox"/>	Testing procedure: CTF Stage 1:	
Testing location/ address		
Tested by (name, function, signature)		
Approved by (name, function, signature) ..		
<input type="checkbox"/>	Testing procedure: CTF Stage 2:	
Testing location/ address		
Tested by (name, function, signature)		
Witnessed by (name, function, signature) . :		
Approved by (name, function, signature) .. :		
<input type="checkbox"/>	Testing procedure: CTF Stage 3:	
<input type="checkbox"/>	Testing procedure: CTF Stage 4:	
Testing location/ address		
Tested by (name, function, signature)		
Witnessed by (name, function, signature) . :		
Approved by (name, function, signature) .. :		

Supervised by (name, function, signature) :		
--	--	--

List of Attachments (including a total number of pages in each attachment):

- Measurement Section (8 Pages)
- National Differences (30 Pages)
- Photo documentation (30 Pages)

Summary of testing:

Tests performed (name of test and test clause):

name of test	test clause number
Classification of electrical energy sources	5.2
Accessibility to electrical energy sources and safeguards (Accessibility test)	5.3.2
Maximum operating temperature test (Heating test)	5.4.1.4, 6.3.2, 9.0, B.2.6
Determination of working voltage	5.4.1.8
Humidity test	5.4.8
Electric strength test	5.4.9
Safeguards against capacitance discharge test	5.5.2.2
Resistance of the protective bonding system (Ground continuity test)	5.6.6.2
Earthed accessible conductive part test	5.7.2.2, 5.7.4
Electrical Power Source (PS) measurements for classification	6.2.2
Stability	8.6
Wall or ceiling mount loading test	8.7
Input test	Annex B.2.5
Simulated abnormal operating and single fault conditions	Annex B.3, B.4
Test for permanence of markings	Annex F.3.10
Transformer insulation	Annex G.5.3.2
Transformer overload	Annex G.5.3.3
Safeguards against entry of foreign object	Annex P.2.2
Adhesive test	Annex P.4
Limited power source test (LPS)	Annex Q.1
Limited short circuit test	Annex R
Steady force test, 10N, 30N, 250N	Annex T.2, T.3, T.5
Enclosure impact test	Annex T.6
Stress relief test	Annex T.8

Testing location:

All tests as described in Test Case and Measurement Sections were performed at the laboratory described on page 2.

The EUT passed the test.

Summary of compliance with National Differences (List of countries addressed):

Summary of compliance with National Differences to IEC 62368-1:2020 (Third Edition) and EN IEC 62368-1:2020+ A11: 2020 (for explanation of codes see below):

EU Group Differences, EU Special National Conditions, CA, DK, US

Explanation of used codes: CA=Canada, DK=Denmark, US=United States of America

The product fulfils the requirements of EN IEC 62368-1:2020+ A11:2020

For National Differences see corresponding Attachment.

Statement concerning the uncertainty of the measurement systems used for the tests

(may be required by the product standard or client)

Internal procedure used for type testing through which traceability of the measuring uncertainty has been established:

Procedure number, issue date and title:

Calculations leading to the reported values are on file with the NCB and testing laboratory that conducted the testing.

Statement not required by the standard used for type testing

(Note: When IEC or ISO standard requires a statement concerning the uncertainty of the measurement systems used for tests, this should be reported above. The informative text in parenthesis should be deleted in both cases after selecting the applicable option)

Copy of marking plate:

The artwork below may be only a draft. The use of certification marks on a product must be authorized by the respective NCBs that own these marks.



Test item particulars:			
Product group	<input checked="" type="checkbox"/> end product	<input type="checkbox"/> built-in component	
Classification of use by	<input checked="" type="checkbox"/> Ordinary person	<input checked="" type="checkbox"/> Children likely present	
	<input type="checkbox"/> Instructed person		
	<input type="checkbox"/> Skilled person		
Supply connection	<input checked="" type="checkbox"/> AC mains	<input type="checkbox"/> DC mains	
	<input type="checkbox"/> not mains connected:		
	<input type="checkbox"/> ES1	<input type="checkbox"/> ES2	<input type="checkbox"/> ES3
Supply tolerance	<input checked="" type="checkbox"/> +10%/-10%		
	<input type="checkbox"/> +20%/-15%		
	<input type="checkbox"/> + %/ - %		
	<input type="checkbox"/> None		
Supply connection – type	<input checked="" type="checkbox"/> pluggable equipment type A -		
	<input type="checkbox"/> non-detachable supply cord		
	<input checked="" type="checkbox"/> appliance coupler		
	<input type="checkbox"/> direct plug-in		
	<input type="checkbox"/> pluggable equipment type B -		
	<input type="checkbox"/> non-detachable supply cord		
	<input type="checkbox"/> appliance coupler		
	<input type="checkbox"/> permanent connection		
	<input type="checkbox"/> mating connector	<input type="checkbox"/> other:	
Considered current rating of protective device	<input checked="" type="checkbox"/> 20 A;		
	Location:	<input checked="" type="checkbox"/> building	<input type="checkbox"/> equipment
	<input type="checkbox"/> N/A		
Equipment mobility	<input checked="" type="checkbox"/> movable	<input type="checkbox"/> hand-held	<input type="checkbox"/> transportable
	<input type="checkbox"/> direct plug-in	<input type="checkbox"/> stationary	<input type="checkbox"/> for building-in
	<input checked="" type="checkbox"/> wall/ceiling-mounted	<input type="checkbox"/> SRME/rack-mounted	
	<input type="checkbox"/> other:		
Overvoltage category (OVC)	<input type="checkbox"/> OVC I	<input checked="" type="checkbox"/> OVC II	<input type="checkbox"/> OVC III
	<input type="checkbox"/> OVC IV	<input type="checkbox"/> other:	
Class of equipment	<input checked="" type="checkbox"/> Class I	<input type="checkbox"/> Class II	<input type="checkbox"/> Class III
	<input type="checkbox"/> Not classified	<input type="checkbox"/>	
Special installation location	<input checked="" type="checkbox"/> N/A	<input type="checkbox"/> restricted access area	
	<input type="checkbox"/> outdoor location	<input type="checkbox"/>	
Pollution degree (PD)	<input type="checkbox"/> PD 1	<input checked="" type="checkbox"/> PD 2	<input type="checkbox"/> PD 3
Manufacturer's specified T_{ma}	40 °C	<input type="checkbox"/> Outdoor: minimum	°C
IP protection class	<input checked="" type="checkbox"/> IPX0	<input type="checkbox"/> IP__	
Power systems	<input checked="" type="checkbox"/> TN	<input type="checkbox"/> TT	<input type="checkbox"/> IT - V _{L-L}
	<input type="checkbox"/> not AC mains		
Altitude during operation (m)	<input type="checkbox"/> 2000 m or less	<input checked="" type="checkbox"/> 5000 m	
Altitude of test laboratory (m)	<input checked="" type="checkbox"/> 2000 m or less	<input type="checkbox"/> m	
Mass of equipment (kg)	For 23.6 inch model: 4.47kg (with base stand type A); For 23.8 inch model: 4.47kg (with base stand type A); For 27.0 inch model: 6.15kg (with base stand type A); For base stand type A: approx. 1.51kg; For base stand type B: approx. 1.35kg		

Possible test case verdicts:	
- test case does not apply to the test object.....: N/A	
- test object does meet the requirement.....: P (Pass)	
- test object does not meet the requirement.....: F (Fail)	
Testing:	
Date of receipt of test item: 25.Feb.2021	
Date (s) of performance of tests: 25.Feb.2021 - 24.Mar.2021	
General remarks:	
"(See Enclosure #)" refers to additional information appended to the report. "(See appended table)" refers to a table appended to the report.	
Throughout this report a <input type="checkbox"/> comma / <input checked="" type="checkbox"/> point is used as the decimal separator.	
Manufacturer's Declaration per sub-clause 4.2.5 of IECCE 02:	
The application for obtaining a CB Test Certificate includes more than one factory location and a declaration from the Manufacturer stating that the sample(s) submitted for evaluation is (are) representative of the products from each factory has been provided	<input checked="" type="checkbox"/> Yes <input type="checkbox"/> Not applicable
When differences exist; they shall be identified in the General product information section.	
Name and address of factory (ies) :	
1 TPV Display Technology (Wuhan) Co., Ltd Unique No.11 Zhuankou Development District of Economic Technological Development Zone , 430056 Wuhan City, P. R. China	
2 TPV Electronics (Fujian) Co., Ltd. Shangzheng, Yuan Hong Road Fuqing City, Fujian, P.R.China	
3 L&T Display Technology (Fujian) Ltd Optoelectronic Park, Rongqiao Economic and Technological Development Zone Fuqing, 350301 Fujian, P.R. China	
4 TPV Electronics (Fujian) Co., Ltd. Rongqiao Economic and Technological Development Zone Fuqing City, Fujian, P.R.China	
5 TPV Display Technology (Beihai) Co.,Ltd. China Electronic Beihai Industry Park, Northeast of the Crossing between Taiwan Road and Jilin Road, Beihai City, Guangxi, P.R.China	
6 TPV Display Technology (China) Co., Ltd No.106 Jinghai 3 Rd., BDA, 100176 Beijing, P. R. China	
7 Trend Smart CE Mexico S de RL de CV Avenida Sor Juana Ines de la Cruz de 19602 Nueva Tijuana, 22435 Tijuana Baja California, MEXICO	
8 TPV Technology(Qingdao) Co.,Ltd. NO.99 Huoju Road, High-tech Industrial Development Zone, Qingdao City, Shandong, P. R. China	
9 Envision Indústria de Produtos Eletrônicos Ltda. Av. Torquato Tapajós, 2236, Flores - CEP 69058-830 - Manaus/AM Brasil	

- 10 Pro Concept Manufacturer Co., Ltd.
88/1 Moo 12, Soi Phetkasem 120, Phetkasem Road, Omnoi, Krathumbaen, Samutsakhon 74130, Thailand
- 11 TPV Technology (Thailand) Co., Ltd.
No.267 Mu7, Tha Tum Sub- District, Si Maha Pho District, Prachin Buri Province, Thailand
- 12 TPV Electronics (Fujian) Co., Ltd.
Optoelectronic Park, Rongqiao Economic and Technological Development Zone, Fuqing City, 350301, Fujian, P. R. China
- 13 GeneTouch Corp.
No. 9 Neixi Rd., Luzhu Dist., Taoyuan City, 33852 Taiwan

General product information and other remarks:

Product Description –

The models are LCD Monitor intended for general office use and information technology equipment with following features:

1. LCD panel: 23.6 inch, 23.8 inch, 27.0 inch TFT LCD with LED backlight;
2. Three building-in type switching power supply boards 715G9611, 715GB018 and 715GC031;
3. Six building-in main board 715G9584, 715GB201, 715GA740, 715G9500, 715GA531 and 715GC003 supplied by secondary output of power board mentioned above;
4. The internal metal chassis is considered as fire enclosure and mechanical enclosure, and the external plastic enclosure is regarded as electrical enclosure and mechanical enclosure, made of min. HB material;
5. Two types of base stand (optional use): Type A is stationary type, and type B is rotatable type which can be rotated with 90° clockwise;
6. Maximum declared ambient: 40°C

Model Differences –

Model name	Power board	Main board	USB board (optional)	Metal enclosure	Base stand	Panel
24G1*****, C24G1*****, C*24G1*****, Q24G1*****, U24G1*****, 24G2*****, C24G2*****, C*24G2*****, Q24G2*****, U24G2*****	715G9611	715G9584 715GB201	715GA629	Type A	Type A	23.6 inch or 23.8 inch Curved
	715G9611	715G9584 715GA740 715GB201		Type B	Type A Type B	23.6 inch or 23.8 inch Flat
	715GB018			Type C		
27G1*****, C27G1*****, C*27G1*****, Q27G1*****, U27G1*****, 27G2*****, C27G2*****, C*27G2*****, Q27G2*****, U27G2*****	715G9611	715G9584 715G9500 715GA531	715GA629	Type A	Type A	27.0 inch Curved
		715GB201	715G9509			
	715GC031	715GC003	N/A	Type B	Type A Type B	27.0 inch Flat
	715G9611	715G9584 715GA531	715GA629			
715GB201	715G9509					
715GC031	715GC003	N/A				

Definition of variable(s):		
Variable:	Range of variable:	Content:
*	0-9, A-Z, a-z, -, \, /, + or blank	For marketing purpose only, no technical difference.

Additional information:

1. All data ports on main boards are optional use.

OVERVIEW OF ENERGY SOURCES AND SAFEGUARDS				
Clause	Possible Hazard			
5	Electrically-caused injury			
Class and Energy Source (e.g. ES3: Primary circuit)	Body Part (e.g. Ordinary)	Safeguards		
		B	S	R
ES3: L/N pin of appliance inlet	Ordinary	--	--	Bleeder Resistors or Discharge ICX
ES3: Primary circuit	Ordinary	Air gap	Enclosure	Transformers, Y1-caps, Photo Couplers
ES1: +19V output of SPS	Ordinary	N/A	N/A	N/A
6	Electrically-caused fire			
Class and Energy Source (e.g. PS2: 100 Watt circuit)	Material part (e.g. Printed board)	Safeguards		
		B	1 st S	2 nd S
PS3	Combustible materials inside primary circuit	Ignition not occur	Fire enclosure	--
PS2	Combustible materials supplied by +19V output of SPS	Ignition not occur	Mounted on V-1 min. PCB	--
7	Injury caused by hazardous substances			
Class and Energy Source (e.g. Ozone)	Body Part (e.g., Skilled)	Safeguards		
		B	S	R
N/A	N/A	N/A	N/A	N/A
8	Mechanically-caused injury			
Class and Energy Source (e.g. MS3: Plastic fan blades)	Body Part (e.g. Ordinary)	Safeguards		
		B	S	R
MS3: Wall mount	Ordinary	--	--	Compliance with test 8.7.2
MS1: Sharp edges and corners	Ordinary	N/A	N/A	N/A
MS1: Equipment mass	Ordinary	N/A	N/A	N/A
9	Thermal burn			
Class and Energy Source (e.g. TS1: Keyboard caps)	Body Part (e.g., Ordinary)	Safeguards		
		B	S	R
TS1: Accessible parts	Ordinary	N/A	N/A	N/A
10	Radiation			
Class and Energy Source (e.g. RS1: PMP sound output)	Body Part (e.g., Ordinary)	Safeguards		
		B	S	R
RS1: Indicating lights	Ordinary	N/A	N/A	N/A

RS1: LED backlight of LCD panel	Ordinary	N/A	N/A	N/A
---------------------------------	----------	-----	-----	-----

Supplementary Information:

“B” – Basic Safeguard; “S” – Supplementary Safeguard; “R” – Reinforced Safeguard

ENERGY SOURCE DIAGRAM

Optional. Manufacturers are to provide the energy sources diagram identify declared energy sources and identifying the demarcations are between power sources. Recommend diagram be provided included in power supply and multipart systems.

Insert diagram below. Example diagram designs are; Block diagrams; image(s) with layered data; mechanical drawings

**ES3, ES1 (See Source of electrical energy for the details),
PS3, PS2 (See Source of power or PIS for the details)**

Power board 715G9611

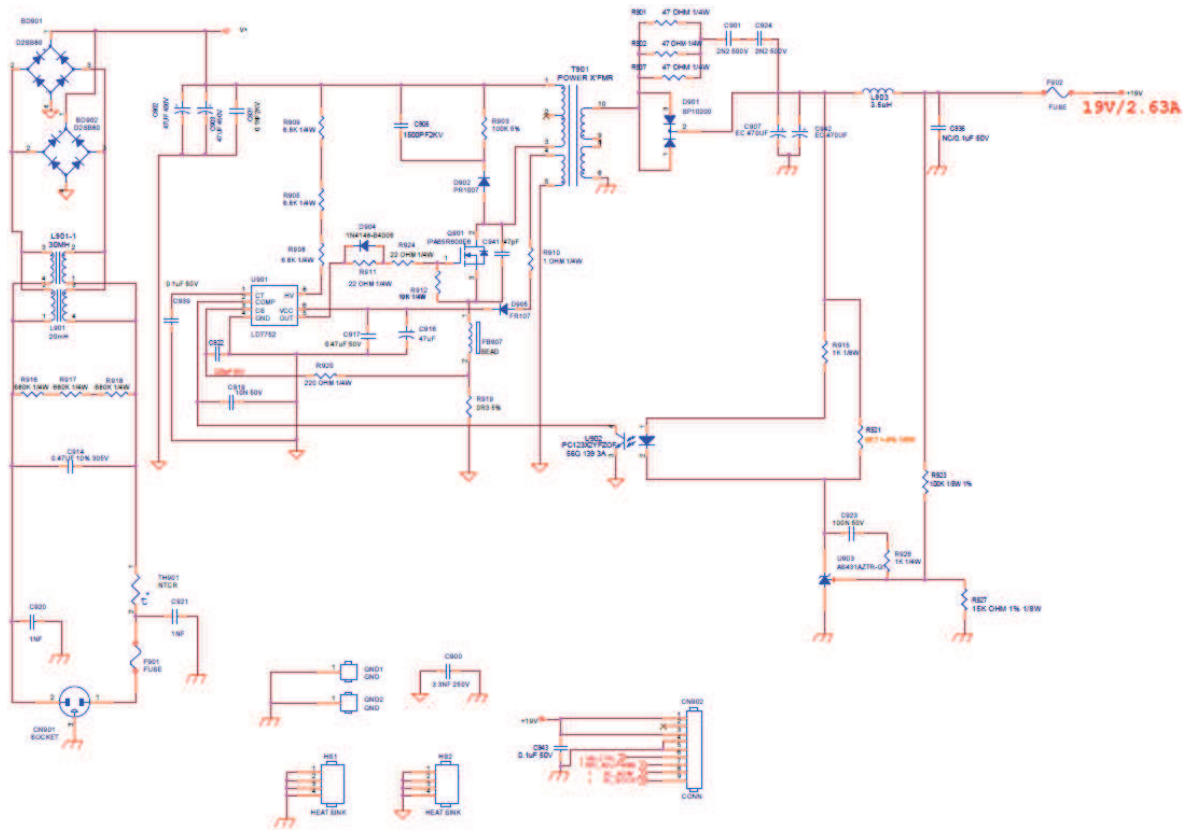

IEC 62368-1			
Clause	Requirement + Test	Result - Remark	Verdict
4	GENERAL REQUIREMENTS		P
4.1.1	Acceptance of materials, components and subassemblies	See appended table 4.1.2.	P
4.1.2	Use of components	Components which are certified to IEC and/or national standards are used correctly within their ratings. Components not covered by IEC standards are tested under the conditions present in the equipment.	P
4.1.3	Equipment design and construction	No accessible part which could cause injury.	P
4.1.4	Specified ambient temperature for outdoor use (°C):		N/A
4.1.5	Constructions and components not specifically covered		N/A
4.1.8	Liquids and liquid filled components (LFC)	(See G.15)	N/A
4.1.15	Markings and instructions	(See Annex F)	P
4.4.3	Safeguard robustness	For adhesives securing parts serving as safeguards, see Annex P.4. Others see below.	P
4.4.3.1	General		P
4.4.3.2	Steady force tests	(See Clause T.3, T.4, T.5)	P
4.4.3.3	Drop tests		N/A
4.4.3.4	Impact tests	See Annex T.	P
4.4.3.5	Internal accessible safeguard tests	See Annex T.	P
4.4.3.6	Glass impact tests	Laminated glass used.	N/A
4.4.3.7	Glass fixation tests	No such construction.	N/A
	Glass impact test (1J)		N/A
	Push/pull test (10 N)		N/A
4.4.3.8	Thermoplastic material tests	Phenolic material used and described in subclauses 5.4.1.10 to 5.4.1.10.3. 70°C, 7 hours, no deformation on all sources of plastic enclosure.	P
4.4.3.9	Air comprising a safeguard		P
4.4.3.10	Accessibility, glass, safeguard effectiveness	Compliance checked.	P
4.4.4	Displacement of a safeguard by an insulating liquid	No such component.	N/A
4.4.5	Safety interlocks		N/A

IEC 62368-1			
Clause	Requirement + Test	Result - Remark	Verdict
4.5	Explosion		P
4.5.1	General	No explosion occurs during normal/abnormal operation and single fault conditions.	P
4.5.2	No explosion during normal/abnormal operating condition	(See Clause B.2, B.3)	P
	No harm by explosion during single fault conditions	(See Clause B.4)	P
4.6	Fixing of conductors		P
	Fix conductors not to defeat a safeguard		P
	Compliance is checked by test..... :	(See Clause T.2)	P
4.7	Equipment for direct insertion into mains socket-outlets		N/A
4.7.2	Mains plug part complies with relevant standard .. :		N/A
4.7.3	Torque (Nm) .. :		N/A
4.8	Equipment containing coin/button cell batteries		N/A
4.8.1	General	No lithium coin/button batteries used.	N/A
4.8.2	Instructional safeguard .. :		N/A
4.8.3	Battery compartment door/cover construction		N/A
	Open torque test		N/A
4.8.4.2	Stress relief test		N/A
4.8.4.3	Battery replacement test		N/A
4.8.4.4	Drop test		N/A
4.8.4.5	Impact test		N/A
4.8.4.6	Crush test		N/A
4.8.5	Compliance		N/A
	30N force test with test probe		N/A
	20N force test with test hook		N/A
4.9	Likelihood of fire or shock due to entry of conductive object		P
4.10	Component requirements		P
4.10.1	Disconnect Device	(See Annex L)	P
4.10.2	Switches and relays	No such component.	N/A
5	ELECTRICALLY-CAUSED INJURY		P
5.2	Classification and limits of electrical energy sources		P
5.2.2	ES1, ES2 and ES3 limits	See below.	P
5.2.2.2	Steady-state voltage and current limits..... :	(See appended table 5.2)	P

IEC 62368-1			
Clause	Requirement + Test	Result - Remark	Verdict
5.2.2.3	Capacitance limits..... :	(See appended table 5.2)	P
5.2.2.4	Single pulse limits :		N/A
5.2.2.5	Limits for repetitive pulses :		N/A
5.2.2.6	Ringing signals		N/A
5.2.2.7	Audio signals	(See Clause E.1)	N/A
5.3	Protection against electrical energy sources		P
5.3.1	General Requirements for accessible parts to ordinary, instructed and skilled persons		P
5.3.1 a)	Accessible ES1/ES2 derived from ES2/ES3 circuits	See "OVERVIEW OF EMPLOYED SAFEGUARDS" table.	P
5.3.1 b)	Skilled persons not unintentional contact ES3 bare conductors	See above.	P
5.3.2.1	Accessibility to electrical energy sources and safeguards	ES2 or ES3 source cannot accessed by ordinary persons and ES3 source cannot accessed by instructed persons. Double or reinforced safeguard is provided between ES2 or ES3 and ordinary persons or instructed persons.	P
	Accessibility to outdoor equipment bare parts		N/A
5.3.2.2	Contact requirements	See below.	P
	Test with test probe from Annex V	Test probe V.1, V.2 applied.	-
5.3.2.2 a)	Air gap – electric strength test potential (V)..... :	(See appended table 5.4.9)	P
5.3.2.2 b)	Air gap – distance (mm) :	Complied with the minimum distance requirement. (See appended table 5.4.2, 5.4.3.)	P
5.3.2.3	Compliance		P
5.3.2.4	Terminals for connecting stripped wire	No such terminals.	N/A
5.4	Insulation materials and requirements		P
5.4.1.2	Properties of insulating material	Hygroscopic materials are not used for insulating material.	P
5.4.1.3	Material is non-hygroscopic	(See sub-clause 5.4.8)	P
5.4.1.4	Maximum operating temperature for insulating materials..... :	(See appended table 5.4.1.4)	P
5.4.1.5	Pollution degrees :	Pollution degree 2	P
5.4.1.5.2	Test for pollution degree 1 environment and for an insulating compound		N/A

IEC 62368-1			
Clause	Requirement + Test	Result - Remark	Verdict
5.4.1.5.3	Thermal cycling test		N/A
5.4.1.6	Insulation in transformers with varying dimensions		N/A
5.4.1.7	Insulation in circuits generating starting pulses		N/A
5.4.1.8	Determination of working voltage	(See appended table 5.4.1.8)	P
5.4.1.9	Insulating surfaces		P
5.4.1.10	Thermoplastic parts on which conductive metallic parts are directly mounted	Bobbin materials of transformers and some of line chocks are Phenolic that is accepted without further tests. Others see appended table 5.4.1.10.3.	P
5.4.1.10.2	Vicat test.....		N/A
5.4.1.10.3	Ball pressure test	(See appended table 5.4.1.10.3)	P
5.4.2	Clearances		N/A
5.4.2.1	General requirements	See above.	P
	Clearances in circuits connected to AC Mains, Alternative method	See below.	P
5.4.2.2	Procedure 1 for determining clearance	(See appended table 5.4.2, 5.4.3.)	P
	Temporary overvoltage	2000V	—
5.4.2.3	Procedure 2 for determining clearance	(See appended table 5.4.2, 5.4.3.)	P
5.4.2.3.2.2	a.c. mains transient voltage.....	2500V	—
5.4.2.3.2.3	d.c. mains transient voltage		—
5.4.2.3.2.4	External circuit transient voltage		—
5.4.2.3.2.5	Transient voltage determined by measurement		—
5.4.2.4	Determining the adequacy of a clearance using an electric strength test	(See appended table 5.4.2)	N/A
5.4.2.5	Multiplication factors for clearances and test voltages	Multiplication factor is 1.48 for altitude up to 5000m.	P
5.4.2.6	Clearance measurement	(See appended table 5.4.2)	P
5.4.3	Creepage distances		P
5.4.3.1	General		P
5.4.3.3	Material group	Material group IIIb assumed.	—
5.4.3.4	Creepage distances measurement	(See appended table 5.4.3)	P
5.4.4	Solid insulation		P
5.4.4.1	General requirements		P
5.4.4.2	Minimum distance through insulation	(See appended table 5.4.4.2)	P

IEC 62368-1			
Clause	Requirement + Test	Result - Remark	Verdict
5.4.4.3	Insulating compound forming solid insulation		N/A
5.4.4.4	Solid insulation in semiconductor devices		N/A
5.4.4.5	Insulating compound forming cemented joints		N/A
5.4.4.6	Thin sheet material		P
5.4.4.6.1	General requirements		P
5.4.4.6.2	Separable thin sheet material	Reinforced insulation.	P
	Number of layers (pcs) :	2.	P
5.4.4.6.3	Non-separable thin sheet material	Not used.	N/A
	Number of layers (pcs) :		N/A
5.4.4.6.4	Standard test procedure for non-separable thin sheet material..... :		N/A
5.4.4.6.5	Mandrel test		N/A
5.4.4.7	Solid insulation in wound components		N/A
5.4.4.9	Solid insulation at frequencies >30 kHz, E_P , K_R , d , V_{PW} (V)..... :	(See appended Table 5.4.4.9) or (See appended Table 5.4.9)	P
	Alternative by electric strength test, tested voltage (V), K_R :		N/A
5.4.5	Antenna terminal insulation		N/A
5.4.5.1	General		N/A
5.4.5.2	Voltage surge test		N/A
5.4.5.3	Insulation resistance ($M\Omega$) :		N/A
	Electric strength test :		N/A
5.4.6	Insulation of internal wire as part of supplementary safeguard		N/A
5.4.7	Tests for semiconductor components and for cemented joints		N/A
5.4.8	Humidity conditioning		P
	Relative humidity (%), temperature ($^{\circ}C$), duration (h) :	Performed at 40 $^{\circ}C$, 95% R.H. for 120h.	—
5.4.9	Electric strength test		P
5.4.9.1	Test procedure for type test of solid insulation :	(See appended table 5.4.9)	P
5.4.9.2	Test procedure for routine test		N/A
5.4.10	Safeguards against transient voltages from external circuits		N/A
5.4.10.1	Parts and circuits separated from external circuits		N/A
5.4.10.2	Test methods		N/A
5.4.10.2.1	General		N/A

IEC 62368-1			
Clause	Requirement + Test	Result - Remark	Verdict
5.4.10.2.2	Impulse test		N/A
5.4.10.2.3	Steady-state test		N/A
5.4.10.3	Verification for insulation breakdown for impulse test.....		N/A
5.4.11	Separation between external circuits and earth		N/A
5.4.11.1	Exceptions to separation between external circuits and earth		N/A
5.4.11.2	Requirements		N/A
	SPDs bridge separation between external circuit and earth		N/A
	Rated operating voltage U_{op} (V)		—
	Nominal voltage U_{peak} (V)		—
	Max increase due to variation ΔU_{sp}		—
	Max increase due to ageing ΔU_{sa}		—
5.4.11.3	Test method and compliance		N/A
5.4.12	Insulating liquid		N/A
5.4.12.1	General requirements		N/A
5.4.12.2	Electric strength of an insulating liquid		N/A
5.4.12.3	Compatibility of an insulating liquid		N/A
5.4.12.4	Container for insulating liquid		N/A
5.5	Components as safeguards		P
5.5.1	General		P
5.5.2	Capacitors and RC units		P
5.5.2.1	General requirement	X-Cap. and Y-Cap. are IEC 60384-14 approval components and complied with Annex G.11.	P
5.5.2.2	Safeguards against capacitor discharge after disconnection of a connector.....	(See appended table 5.5.2.2)	P
5.5.3	Transformers	(See Annex G.5.3)	P
5.5.4	Optocouplers	(See Clause G.12)	P
5.5.5	Relays		N/A
5.5.6	Resistors	(See Annex G.10)	P
5.5.7	SPDs		N/A
5.5.8	Insulation between the mains and an external circuit consisting of a coaxial cable		N/A
5.5.9	Safeguards for socket-outlets in outdoor equipment		N/A
	RCD rated residual operating current (mA).....		—

IEC 62368-1			
Clause	Requirement + Test	Result - Remark	Verdict
5.6	Protective conductor		P
5.6.2	Requirement for protective conductors		P
5.6	Protective conductor		P
5.6.2	Requirement for protective conductors		P
5.6.2.1	General requirements	No switch or overcurrent protective device in protective conductor.	P
5.6.2.2	Colour of insulation	No green-and-yellow wire used.	N/A
5.6.3	Requirement for protective earthing conductors	Not used with power cord	N/A
	Protective earthing conductor size (mm ²)		—
	Protective earthing conductor serving as a reinforced safeguard		N/A
	Protective earthing conductor serving as a double safeguard		N/A
5.6.4	Requirements for protective bonding conductors	See below.	P
5.6.4.1	Protective bonding conductors	Protective bonding complied with requirement of Clause 5.6.6 and Annex R.	P
	Protective bonding conductor size (mm ²).....	See above.	—
5.6.4.2	Protective current rating (A)	20A	P
5.6.5	Terminals for protective conductors	Screws fixing earthed PCB trace to metal chassis for protective bonding. Size of screws is according with Table 32.	P
5.6.5.1	Terminal size for connecting protective earthing conductors (mm)	No power cord used.	P
	Terminal size for connecting protective bonding conductors (mm).....	3.7 mm	P
5.6.5.2	Corrosion	Complied.	P
5.6.6	Resistance of the protective bonding system	See below.	P
5.6.6.1	Requirements	See below.	P
5.6.6.2	Test Method.....	(See appended table 5.6.6)	P
5.6.6.3	Resistance (Ω) or voltage drop	(See appended table 5.6.6)	P
5.6.7	Reliable connection of a protective earthing conductor		N/A
5.6.8	Functional earthing		N/A
	Conductor size (mm ²)		N/A
	Class II with functional earthing marking		N/A
	Appliance inlet cl & cr (mm).....		N/A

IEC 62368-1			
Clause	Requirement + Test	Result - Remark	Verdict
5.7	Prospective touch voltage, touch current and protective conductor current		P
5.7.2	Measuring devices and networks		P
5.7.2.1	Measurement of touch current	Figure 5 of IEC 60990 was used in determining of the limit of ES2.	P
5.7.2.2	Measurement of voltage	See above.	P
5.7.3	Equipment set-up, supply connections and earth connections		P
5.7.4	Unearthed accessible parts	(See appended table 5.7.4)	P
5.7.5	Earthed accessible conductive parts	(See appended table 5.7.5)	P
5.7.6	Requirements when touch current exceeds ES2 limits		N/A
	Protective conductor current (mA)		N/A
	Instructional Safeguard		N/A
5.7.7	Prospective touch voltage and touch current associated with external circuits		N/A
5.7.7.1	Touch current from coaxial cables		N/A
5.7.7.2	Prospective touch voltage and touch current associated with paired conductor cables		N/A
5.7.8	Summation of touch currents from external circuits		N/A
	a) Equipment connected to earthed external circuits, current (mA)		N/A
	b) Equipment connected to unearthed external circuits, current (mA)		N/A
5.8	Backfeed safeguard in battery backed up supplies		N/A
	Mains terminal ES		N/A
	Air gap (mm)		N/A
6	ELECTRICALLY- CAUSED FIRE		P
6.2	Classification of PS and PIS		P
6.2.2	Power source circuit classifications	See ENERGY SOURCE IDENTIFICATION AND CLASSIFICATION TABLE.	P
6.2.3	Classification of potential ignition sources		P
6.2.3.1	Arcing PIS	All components located within power board are considered as arcing PIS.	P
6.2.3.2	Resistive PIS	All components located within the equipment are considered as resistive PIS.	P

IEC 62368-1			
Clause	Requirement + Test	Result - Remark	Verdict
6.3	Safeguards against fire under normal operating and abnormal operating conditions		P
6.3.1	No ignition and attainable temperature value less than 90 % defined by ISO 871 or less than 300 °C for unknown materials	(See appended table B.1.5 and B.3)	P
	Combustible materials outside fire enclosure	Min. HB	P
6.4	Safeguards against fire under single fault conditions		P
6.4.1	Safeguard method	The method "Control fire spread" is selected.	P
6.4.2	Reduction of the likelihood of ignition under single fault conditions in PS1 circuits		N/A
6.4.3	Reduction of the likelihood of ignition under single fault conditions in PS2 and PS3 circuits		N/A
6.4.3.1	Supplementary safeguards		N/A
6.4.3.2	Single Fault Conditions	(See appended table B.4)	N/A
	Special conditions for temperature limited by fuse		N/A
6.4.4	Control of fire spread in PS1 circuits		N/A
6.4.5	Control of fire spread in PS2 circuits		P
6.4.5.2	Supplementary safeguards	Certified wire insulation is used. Components other than PCB and wires are: - mounted on PCB rated V-1 or better, or - made of V-2/VTM-2 or better. (See appended tables 4.1.2 and Annex G)	P
6.4.6	Control of fire spread in PS3 circuits	Providing fire enclosure for PS3 circuit.	P
6.4.7	Separation of combustible materials from a PIS	Providing fire enclosure for PS3 circuit.	P
6.4.7.2	Separation by distance		N/A
6.4.7.3	Separation by a fire barrier		N/A
6.4.8	Fire enclosures and fire barriers		P
6.4.8.2	Fire enclosure and fire barrier material properties	See below	P
6.4.8.2.1	Requirements for a fire barrier	Internal metal enclosure and V-0 Mylar sheet served as fire enclosure.	P
6.4.8.2.2	Requirements for a fire enclosure	Metal enclosure and V-0 Mylar sheet as fire enclosure.	P
6.4.8.3	Constructional requirements for a fire enclosure and a fire barrier		P

IEC 62368-1			
Clause	Requirement + Test	Result - Remark	Verdict
6.4.8.3.1	Fire enclosure and fire barrier openings		P
6.4.8.3.2	Fire barrier dimensions		N/A
6.4.8.3.3	Top openings and properties		P
	Openings dimensions (mm)	See attachment: Measurement Section for the details.	P
6.4.8.3.4	Bottom openings and properties		P
	Openings dimensions (mm)	See attachment: Measurement Section for the details.	P
	Flammability tests for the bottom of a fire enclosure		N/A
	Instructional Safeguard.....		N/A
6.4.8.3.5	Side openings and properties		P
	Openings dimensions (mm)	See attachment: Measurement Section for the details.	P
6.4.8.3.6	Integrity of a fire enclosure, condition met: a), b) or c).....		N/A
6.4.8.4	Separation of a PIS from a fire enclosure and a fire barrier distance (mm) or flammability rating	Metal enclosure and V-0 Mylar sheet used as fire enclosure.	P
6.4.9	Flammability of insulating liquid		N/A
6.5	Internal and external wiring		P
6.5.1	General requirements	Internal or external wiring materials are compliant with IEC 60950-1 according to Sub-clause 4.1.1. Furthermore, the test method described in IEC 60695-11-21 is considered equivalent to that test wiring materials for VW-1. All internal wiring are using VW-1 material.	P
6.5.2	Requirements for interconnection to building wiring		N/A
6.5.3	Internal wiring size (mm ²) for socket-outlets		N/A
6.6	Safeguards against fire due to the connection to additional equipment		P

7	INJURY CAUSED BY HAZARDOUS SUBSTANCES		N/A
7.2	Reduction of exposure to hazardous substances		N/A
7.3	Ozone exposure		N/A
7.4	Use of personal safeguards or personal protective equipment (PPE)		N/A
	Personal safeguards and instructions.....		—

IEC 62368-1			
Clause	Requirement + Test	Result - Remark	Verdict
7.5	Use of instructional safeguards and instructions		N/A
	Instructional safeguard (ISO 7010)..... :		—
7.6	Batteries and their protection circuits		N/A

8	MECHANICALLY-CAUSED INJURY		P
8.2	Mechanical energy source classifications		P
8.3	Safeguards against mechanical energy sources		P
8.4	Safeguards against parts with sharp edges and corners		P
8.4.1	Safeguards	No sharp edges and corners in accessible area.	P
	Instructional Safeguard :		N/A
8.4.2	Sharp edges or corners		N/A
8.5	Safeguards against moving parts		N/A
8.5.1	Fingers, jewellery, clothing, hair, etc., contact with MS2 or MS3 parts	No moving parts.	N/A
	MS2 or MS3 part required to be accessible for the function of the equipment		N/A
	Moving MS3 parts only accessible to skilled person		N/A
8.5.2	Instructional safeguard :		N/A
8.5.4	Special categories of equipment containing moving parts		N/A
8.5.4.1	General		N/A
8.5.4.2	Equipment containing work cells with MS3 parts		N/A
8.5.4.2.1	Protection of persons in the work cell		N/A
8.5.4.2.2	Access protection override		N/A
8.5.4.2.2.1	Override system		N/A
8.5.4.2.2.2	Visual indicator		N/A
8.5.4.2.3	Emergency stop system		N/A
	Maximum stopping distance from the point of activation (m)..... :		N/A
	Space between end point and nearest fixed mechanical part (mm) :		N/A
8.5.4.2.4	Endurance requirements		N/A
	Mechanical system subjected to 100 000 cycles of operation		N/A
	- Mechanical function check and visual inspection		N/A

IEC 62368-1			
Clause	Requirement + Test	Result - Remark	Verdict
	- Cable assembly..... :		N/A
8.5.4.3	Equipment having electromechanical device for destruction of media		N/A
8.5.4.3.1	Equipment safeguards		N/A
8.5.4.3.2	Instructional safeguards against moving parts..... :		N/A
8.5.4.3.3	Disconnection from the supply		N/A
8.5.4.3.4	Cut type and test force (N)..... :		N/A
8.5.4.3.5	Compliance		N/A
8.5.5	High pressure lamps	Not that equipment.	N/A
	Explosion test..... :		N/A
8.5.5.3	Glass particles dimensions (mm)..... :		N/A
8.6	Stability of equipment		P
8.6.1	General	See Clause 8.2 & 8.3	P
	Instructional safeguard..... :	No such MS2 or MS3 television set.	N/A
8.6.2	Static stability	MS2 equipment.	P
8.6.2.2	Static stability test..... :	Test was conducted with two types of stand base. Unit did not fall over when tilted to an angle of 10° from its normal upright position.	P
8.6.2.3	Downward force test	Not floor standing equipment.	N/A
8.6.3	Relocation stability		N/A
	Wheels diameter (mm)..... :		—
	Tilt test		N/A
8.6.4	Glass slide test	The equipment does not tip over during the test.	P
8.6.5	Horizontal force test..... :		N/A
8.7	Equipment mounted to wall, ceiling or other structure		P
8.7.1	Mount means type..... :	See below	P
8.7.2	Test methods		P
	Test 1, additional downwards force (N)..... :		N/A
	Test 2, number of attachment points and test force (N)..... :	Max. 4.64kg applied for each point (four directions plus inward and outward).	P
	Test 3 Nominal diameter (mm) and applied torque (Nm)..... :	1.2 Nm applied.	P

IEC 62368-1			
Clause	Requirement + Test	Result - Remark	Verdict
8.8	Handles strength		N/A
8.8.1	General		N/A
8.8.2	Handle strength test		N/A
	Number of handles		—
	Force applied (N).....		—
8.9	Wheels or casters attachment requirements		N/A
8.9.2	Pull test		N/A
8.10	Carts, stands and similar carriers		N/A
8.10.1	General		N/A
8.10.2	Marking and instructions		N/A
8.10.3	Cart, stand or carrier loading test		N/A
	Loading force applied (N).....		N/A
8.10.4	Cart, stand or carrier impact test		N/A
8.10.5	Mechanical stability		N/A
	Force applied (N).....		—
8.10.6	Thermoplastic temperature stability		N/A
8.11	Mounting means for slide-rail mounted equipment (SRME)		N/A
8.11.1	General		N/A
8.11.2	Requirements for slide rails		N/A
	Instructional Safeguard		N/A
8.11.3	Mechanical strength test		N/A
8.11.3.1	Downward force test, force (N) applied		N/A
8.11.3.2	Lateral push force test		N/A
8.11.3.3	Integrity of slide rail end stops		N/A
8.11.4	Compliance		N/A
8.12	Telescoping or rod antennas		N/A
	Button/ball diameter (mm).....		—

9	THERMAL BURN INJURY		P
9.2	Thermal energy source classifications		P
9.3	Touch temperature limits		P
9.3.1	Touch temperatures of accessible parts	(See appended table 5.4.1.4, 9.3, B.1.5, B.2.6)	P
9.3.2	Test method and compliance	(See appended table 5.4.1.4, 9.3, B.1.5, B.2.6)	P

IEC 62368-1			
Clause	Requirement + Test	Result - Remark	Verdict
9.4	Safeguards against thermal energy sources		N/A
9.5	Requirements for safeguards		N/A
9.5.1	Equipment safeguard	TS1 considered.	N/A
9.5.2	Instructional safeguard		N/A
9.6	Requirements for wireless power transmitters		N/A
9.6.1	General		N/A
9.6.2	Specification of the foreign objects		N/A
9.6.3	Test method and compliance	(See appended table 9.6)	N/A

10	RADIATION		P
10.2	Radiation energy source classification		P
10.2.1	General classification	The following parts are considered as RS1 without tests: - Indicating lights; - backlight of LCD panel	P
	Lasers		—
	Lamps and lamp systems		—
	Image projectors		—
	X-Ray		—
	Personal music player		—
10.3	Safeguards against laser radiation		N/A
	The standard(s) equipment containing laser(s) comply		N/A
10.4	Safeguards against optical radiation from lamps and lamp systems (including LED types)		N/A
10.4.1	General requirements		N/A
	Instructional safeguard provided for accessible radiation level needs to exceed		N/A
	Risk group marking and location		N/A
	Information for safe operation and installation		N/A
10.4.2	Requirements for enclosures		N/A
	UV radiation exposure	(See Annex C)	N/A
10.4.3	Instructional safeguard		N/A
10.5	Safeguards against X-radiation		N/A
10.5.1	Requirements		N/A

IEC 62368-1			
Clause	Requirement + Test	Result - Remark	Verdict
	Instructional safeguard for skilled persons		—
10.5.3	Maximum radiation (pA/kg).....	(See appended tables B.3 & B.4)	—
10.6	Safeguards against acoustic energy sources		N/A
10.6.1	General		N/A
10.6.2	Classification		N/A
	Acoustic output $L_{Aeq,T}$, dB(A).....		N/A
	Unweighted RMS output voltage (mV).....		N/A
	Digital output signal (dBFS)		N/A
10.6.3	Requirements for dose-based systems		N/A
10.6.3.1	General requirements		N/A
10.6.3.2	Dose-based warning and automatic decrease		N/A
10.6.3.3	Exposure-based warning and requirements		N/A
	30 s integrated exposure level (MEL30)		N/A
	Warning for MEL \geq 100 dB(A)		N/A
10.6.4	Measurement methods		N/A
10.6.5	Protection of persons		N/A
	Instructional safeguards		N/A
10.6.6	Requirements for listening devices (headphones, earphones, etc.)		N/A
10.6.6.1	Corded listening devices with analogue input		N/A
	Listening device input voltage (mV)		N/A
10.6.6.2	Corded listening devices with digital input		N/A
	Max. acoustic output $L_{Aeq,T}$, dB(A)		N/A
10.6.6.3	Cordless listening devices		N/A
	Max. acoustic output $L_{Aeq,T}$, dB(A)		N/A

B	NORMAL OPERATING CONDITION TESTS, ABNORMAL OPERATING CONDITION TESTS AND SINGLE FAULT CONDITION TESTS		P
B.1	General		P
B.1.5	Temperature measurement conditions	(See appended table B.1.5)	P
B.2	Normal operating conditions		P
B.2.1	General requirements.....	(See Test Item Particulars and appended test tables)	P
	Audio Amplifiers and equipment with audio amplifiers	For internal speakers, adjusted to the maximum volume while testing.	P

IEC 62368-1			
Clause	Requirement + Test	Result - Remark	Verdict
B.2.3	Supply voltage and tolerances	±10%	P
B.2.5	Input test	(See appended table B.2.5)	P
B.3	Simulated abnormal operating conditions		P
B.3.1	General	(See appended table B.3)	P
B.3.2	Covering of ventilation openings	Normal heating tested with ventilation blocked.	P
	Instructional safeguard		N/A
B.3.3	DC mains polarity test		N/A
B.3.4	Setting of voltage selector		N/A
B.3.5	Maximum load at output terminals	(See appended table B.3)	P
B.3.6	Reverse battery polarity		N/A
B.3.7	Audio amplifier abnormal operating conditions	(See appended table B.3)	P
B.3.8	Safeguards functional during and after abnormal operating conditions	(See appended table B.3)	P
B.4	Simulated single fault conditions		P
B.4.1	General	See below.	P
B.4.2	Temperature controlling device		N/A
B.4.3	Blocked motor test		N/A
B.4.4	Functional insulation	For traces before fuse, comply with the clearance/creepage for basic insulation, others are considered to perform short-circuited during the tests.	P
B.4.4.1	Short circuit of clearances for functional insulation	See above.	P
B.4.4.2	Short circuit of creepage distances for functional insulation	See above.	P
B.4.4.3	Short circuit of functional insulation on coated printed boards		N/A
B.4.5	Short-circuit and interruption of electrodes in tubes and semiconductors		P
B.4.6	Short circuit or disconnection of passive components		P
B.4.7	Continuous operation of components		N/A
B.4.8	Compliance during and after single fault conditions		P
B.4.9	Battery charging and discharging under single fault conditions		N/A
C	UV RADIATION		N/A
C.1	Protection of materials in equipment from UV radiation		N/A

IEC 62368-1			
Clause	Requirement + Test	Result - Remark	Verdict
C.1.2	Requirements		N/A
C.1.3	Test method		N/A
C.2	UV light conditioning test		N/A
C.2.1	Test apparatus..... :		N/A
C.2.2	Mounting of test samples		N/A
C.2.3	Carbon-arc light-exposure test		N/A
C.2.4	Xenon-arc light-exposure test		N/A
D	TEST GENERATORS		N/A
D.1	Impulse test generators		N/A
D.2	Antenna interface test generator		N/A
D.3	Electronic pulse generator		N/A
E	TEST CONDITIONS FOR EQUIPMENT CONTAINING AUDIO AMPLIFIERS		N/A
E.1	Electrical energy source classification for audio signals		N/A
	Maximum non-clipped output power (W)..... :	Internal speaker and its supply circuit cannot be accessible by ordinary person.	—
	Rated load impedance (Ω)		—
	Open-circuit output voltage (V)..... :		—
	Instructional safeguard		—
E.2	Audio amplifier normal operating conditions		N/A
	Audio signal source type		—
	Audio output power (W)..... :		—
	Audio output voltage (V)		—
	Rated load impedance (Ω)		—
	Requirements for temperature measurement		N/A
E.3	Audio amplifier abnormal operating conditions		N/A
F	EQUIPMENT MARKINGS, INSTRUCTIONS, AND INSTRUCTIONAL SAFEGUARDS		P
F.1	General		P
	Language	English. Versions in other languages will be provided when national certificate approval.	—
F.2	Letter symbols and graphical symbols		P
F.2.1	Letter symbols according to IEC60027-1		P

IEC 62368-1			
Clause	Requirement + Test	Result - Remark	Verdict
F.2.2	Graphic symbols according to IEC, ISO or manufacturer specific		P
F.3	Equipment markings		P
F.3.1	Equipment marking locations	The equipment marking is provided and is readily visible in operator access area.	P
F.3.2	Equipment identification markings	See below.	P
F.3.2.1	Manufacturer identification	See copy of marking plate.	P
F.3.2.2	Model identification	See copy of marking plate.	P
F.3.3	Equipment rating markings	See below.	P
F.3.3.1	Equipment with direct connection to mains	See below.	P
F.3.3.2	Equipment without direct connection to mains		N/A
F.3.3.3	Nature of the supply voltage	See copy of marking plate.	P
F.3.3.4	Rated voltage	See copy of marking plate.	P
F.3.3.5	Rated frequency	See copy of marking plate.	P
F.3.3.6	Rated current or rated power.....	See copy of marking plate.	P
F.3.3.7	Equipment with multiple supply connections		N/A
F.3.4	Voltage setting device		N/A
F.3.5	Terminals and operating devices		P
F.3.5.1	Mains appliance outlet and socket-outlet markings		N/A
F.3.5.2	Switch position identification marking.....		N/A

IEC 62368-1			
Clause	Requirement + Test	Result - Remark	Verdict
F.3.5.3	Replacement fuse identification and rating markings :	<p>The fuse marking is marked near fuse on PCB as follow:</p> <p>For power board 715G9611: F901(on primary): T4AL/250Vac</p> <p>CAUTION: RISK OF FIRE REPLACE ONLY WITH SAME TYPE AND RATING OF FUSE.</p> <p>F902 (on secondary) T5AL/250Vac</p> <p>For power board 715GB018: F9901(on primary): T5AL/250V</p> <p>CAUTION: RISK OF FIRE REPLACE ONLY WITH SAME TYPE AND RATING OF FUSE.</p> <p>F9902 and F9903 (on secondary): T5AL/250V F801 (on secondary): T3.15AL/250V</p> <p>For power board 715GC031: F901(on primary): T4AL/250Vac</p> <p>CAUTION: RISK OF FIRE REPLACE ONLY WITH SAME TYPE AND RATING OF FUSE.</p> <p>F902, F903 (on secondary) T5AL/250Vac</p> <p>Not located in operator access areas.</p>	P
	Instructional safeguards for neutral fuse :	No such fuse used.	N/A
F.3.5.4	Replacement battery identification marking :		N/A
F.3.5.5	Neutral conductor terminal		N/A
F.3.5.6	Terminal marking location		P
F.3.6	Equipment markings related to equipment classification		P
F.3.6.1	Class I equipment		P
F.3.6.1.1	Protective earthing conductor terminal..... :	Appliance inlet is provided. The symbol IEC 60417-5019 was located on appliance inlet.	P
F.3.6.1.2	Protective bonding conductor terminals :	Terminals was not identified.	P
F.3.6.2	Equipment class marking :		N/A
F.3.6.3	Functional earthing terminal marking :		N/A

IEC 62368-1			
Clause	Requirement + Test	Result - Remark	Verdict
F.3.7	Equipment IP rating marking		N/A
F.3.8	External power supply output marking		N/A
F.3.9	Durability, legibility and permanence of marking	See below.	P
F.3.10	Test for permanence of markings	Marking is durable and legible. The marking plate has no curling and is not able to be removed easily.	P
F.4	Instructions		P
	a) Information prior to installation and initial use	Provided in user's manual.	P
	b) Equipment for use in locations where children not likely to be present	Figure V.1 considered for test.	N/A
	c) Instructions for installation and interconnection	Provided in user's manual.	P
	d) Equipment intended for use only in restricted access area		N/A
	e) Equipment intended to be fastened in place	For wall mounted function, provided in user's manual.	P
	f) Instructions for audio equipment terminals		N/A
	g) Protective earthing used as a safeguard	The instruction is provided in the user's manual.	P
	h) Protective conductor current exceeding ES2 limits		N/A
	i) Graphic symbols used on equipment	Graphical symbols not used as an instructional safeguard.	N/A
	j) Permanently connected equipment not provided with all-pole mains switch		N/A
	k) Replaceable components or modules providing safeguard function		N/A
	l) Equipment containing insulating liquid		N/A
	m) Installation instructions for outdoor equipment		N/A
F.5	Instructional safeguards		N/A
G	COMPONENTS		P
G.1	Switches		N/A
G.1.1	General		N/A
G.1.2	Ratings, endurance, spacing, maximum load		N/A
G.1.3	Test method and compliance		N/A
G.2	Relays		N/A
G.2.1	Requirements		N/A
G.2.2	Overload test		N/A

IEC 62368-1			
Clause	Requirement + Test	Result - Remark	Verdict
G.2.3	Relay controlling connectors supplying power to other equipment		N/A
G.2.4	Test method and compliance		N/A
G.3	Protective devices		P
G.3.1	Thermal cut-offs		N/A
	Thermal cut-outs separately approved according to IEC 60730 with conditions indicated in a) & b)		N/A
	Thermal cut-outs tested as part of the equipment as indicated in c)		N/A
G.3.1.2	Test method and compliance		N/A
G.3.2	Thermal links		N/A
G.3.2.1	a) Thermal links tested separately according to IEC 60691 with specifics		N/A
	b) Thermal links tested as part of the equipment		N/A
G.3.2.2	Test method and compliance		N/A
G.3.3	PTC thermistors		N/A
G.3.4	Overcurrent protection devices	Current fuse complying with IEC 60127 as overcurrent protection device.	P
G.3.5	Safeguards components not mentioned in G.3.1 to G.3.4		N/A
G.3.5.1	Non-resettable devices suitably rated and marking provided		N/A
G.3.5.2	Single faults conditions..... :	(See appended table B.4)	N/A
G.4	Connectors		P
G.4.1	Spacings	The appliance inlet complied with IEC 60320-1.	P
G.4.2	Mains connector configuration..... :	The appliance inlet complied with IEC 60320-1.	N/A
G.4.3	Plug is shaped that insertion into mains socket-outlets or appliance coupler is unlikely	No misconnection likely.	P
G.5	Wound components		P
G.5.1	Wire insulation in wound components	Approved triple insulated wire of all secondary windings of transformers used as separation for insulation between primary windings and secondary windings.	P

IEC 62368-1			
Clause	Requirement + Test	Result - Remark	Verdict
G.5.1.2	Protection against mechanical stress	Physical separation provided by insulation tube to relieve mechanical stress at the crossover point.	P
G.5.2	Endurance test		N/A
G.5.2.1	General test requirements		N/A
G.5.2.2	Heat run test		N/A
	Test time (days per cycle)		—
	Test temperature (°C).....		—
G.5.2.3	Wound components supplied from the mains		N/A
G.5.2.4	No insulation breakdown		N/A
G.5.3	Transformers		P
G.5.3.1	Compliance method.....	Meet the requirements in G.5.3.2 and G.5.3.3.	P
	Position	All transformer on power board	P
	Method of protection.....	Overcurrent protection.	P
G.5.3.2	Insulation	See attachment of Transformer table.	P
	Protection from displacement of windings.....	Displacement of windings is unlikely.	—
G.5.3.3	Transformer overload tests	(See appended table B.3 & B.4)	P
G.5.3.3.1	Test conditions	Tested in the complete equipment.	P
G.5.3.3.2	Winding temperatures	(See appended table B.3 & B.4)	P
G.5.3.3.3	Winding temperatures - alternative test method		N/A
G.5.3.4	Transformers using FIW		N/A
G.5.3.4.1	General		N/A
	FIW wire nominal diameter.....		—
G.5.3.4.2	Transformers with basic insulation only		N/A
G.5.3.4.3	Transformers with double insulation or reinforced insulation.....	See attachment Transformer table.	P
G.5.3.4.4	Transformers with FIW wound on metal or ferrite core		N/A
G.5.3.4.5	Thermal cycling test and compliance		N/A
G.5.3.4.6	Partial discharge test		N/A
G.5.3.4.7	Routine test		N/A
G.5.4	Motors		N/A
G.5.4.1	General requirements		N/A

IEC 62368-1			
Clause	Requirement + Test	Result - Remark	Verdict
G.5.4.2	Motor overload test conditions		N/A
G.5.4.3	Running overload test		N/A
G.5.4.4.2	Locked-rotor overload test		N/A
	Test duration (days)		—
G.5.4.5	Running overload test for DC motors		N/A
G.5.4.5.2	Tested in the unit		N/A
G.5.4.5.3	Alternative method		N/A
G.5.4.6	Locked-rotor overload test for DC motors		N/A
G.5.4.6.2	Tested in the unit		N/A
	Maximum Temperature		N/A
G.5.4.6.3	Alternative method		N/A
G.5.4.7	Motors with capacitors		N/A
G.5.4.8	Three-phase motors		N/A
G.5.4.9	Series motors		N/A
	Operating voltage		—
G.6	Wire Insulation		P
G.6.1	General		P
G.6.2	Enamelled winding wire insulation		N/A
G.7	Mains supply cords		N/A
G.7.1	General requirements	No mains supply cord provided.	N/A
	Type.....		—
G.7.2	Cross sectional area (mm ² or AWG)		N/A
G.7.3	Cord anchorages and strain relief for non-detachable power supply cords		N/A
G.7.3.2	Cord strain relief		N/A
G.7.3.2.1	Requirements		N/A
	Strain relief test force (N).....		N/A
G.7.3.2.2	Strain relief mechanism failure		N/A
G.7.3.2.3	Cord sheath or jacket position, distance (mm)		N/A
G.7.3.2.4	Strain relief and cord anchorage material		N/A
G.7.4	Cord Entry		N/A
G.7.5	Non-detachable cord bend protection		N/A
G.7.5.1	Requirements		N/A
G.7.5.2	Test method and compliance		N/A

IEC 62368-1			
Clause	Requirement + Test	Result - Remark	Verdict
	Overall diameter or minor overall dimension, D (mm)		—
	Radius of curvature after test (mm)		—
G.7.6	Supply wiring space		N/A
G.7.6.1	General requirements		N/A
G.7.6.2	Stranded wire		N/A
G.7.6.2.1	Requirements		N/A
G.7.6.2.2	Test with 8 mm strand		N/A
G.8	Varistors		N/A
G.8.1	General requirements		N/A
G.8.2	Safeguards against fire		N/A
G.8.2.1	General		N/A
G.8.2.2	Varistor overload test		N/A
G.8.2.3	Temporary overvoltage test		N/A
G.9	Integrated circuit (IC) current limiters		N/A
G.9.1	Requirements		N/A
	IC limiter output current (max. 5A)		—
	Manufacturers' defined drift		—
G.9.2	Test Program		N/A
G.9.3	Compliance		N/A
G.10	Resistors		P
G.10.1	General	For power board 715GC031: Resistors are used in parallel. (See appended table 4.1.2) For power board 715G9611: Approved bleeding resistors used. (See appended table 4.1.2)	P
G.10.2	Conditioning		N/A
G.10.3	Resistor test		N/A
G.10.4	Voltage surge test		N/A
G.10.5	Impulse test		N/A
G.10.6	Overload test		N/A
G.11	Capacitors and RC units		P

IEC 62368-1			
Clause	Requirement + Test	Result - Remark	Verdict
G.11.1	General requirements	X-Capacitors and Y-Capacitors used as safeguard and complied with IEC/EN 60384-14. (See appended table 4.1.2)	P
G.11.2	Conditioning of capacitors and RC units	At least 21 days at $40 \pm 2^\circ\text{C}$ and $93 \pm 3\%$ RH.	P
G.11.3	Rules for selecting capacitors	The selection followed with tables G.9 and G.12.	P
G.12	Optocouplers		P
	Optocouplers comply with IEC 60747-5-5 with specifics	The optocouplers used in the equipment are complied with the requirements of IEC 60747-5-5. (see appended table 4.1.2)	P
	Type test voltage $V_{ini,a}$	See above.	—
	Routine test voltage, $V_{ini,b}$	See above.	—
G.13	Printed boards		P
G.13.1	General requirements	See below.	P
G.13.2	Uncoated printed boards	(see appended table 5.4.2.2, 5.4.2.4 and 5.4.3)	P
G.13.3	Coated printed boards		N/A
G.13.4	Insulation between conductors on the same inner surface		N/A
G.13.5	Insulation between conductors on different surfaces		N/A
	Distance through insulation		N/A
	Number of insulation layers (pcs)		—
G.13.6	Tests on coated printed boards		N/A
G.13.6.1	Sample preparation and preliminary inspection		N/A
G.13.6.2	Test method and compliance		N/A
G.14	Coating on components terminals		N/A
G.14.1	Requirements		N/A
G.15	Pressurized liquid filled components		N/A
G.15.1	Requirements		N/A
G.15.2	Test methods and compliance		N/A
G.15.2.1	Hydrostatic pressure test		N/A
G.15.2.2	Creep resistance test		N/A
G.15.2.3	Tubing and fittings compatibility test		N/A
G.15.2.4	Vibration test		N/A
G.15.2.5	Thermal cycling test		N/A

IEC 62368-1			
Clause	Requirement + Test	Result - Remark	Verdict
G.15.2.6	Force test		N/A
G.15.3	Compliance		N/A
G.16	IC including capacitor discharge function (ICX)		P
G.16.1	Condition for fault tested is not required	Approved components used.	P
	ICX with associated circuitry tested in equipment		N/A
	ICX tested separately		N/A
G.16.2	Tests		N/A
	Smallest capacitance and smallest resistance specified by ICX manufacturer for impulse test..... :		—
	Mains voltage that impulses to be superimposed on :		—
	Largest capacitance and smallest resistance for ICX tested by itself for 10000 cycles test :		—
G.16.3	Capacitor discharge test..... :		N/A
H	CRITERIA FOR TELEPHONE RINGING SIGNALS		N/A
H.1	General		N/A
H.2	Method A		N/A
H.3	Method B		N/A
H.3.1	Ringling signal		N/A
H.3.1.1	Frequency (Hz) :		—
H.3.1.2	Voltage (V) :		—
H.3.1.3	Cadence; time (s) and voltage (V) :		—
H.3.1.4	Single fault current (mA):..... :		—
H.3.2	Tripping device and monitoring voltage		N/A
H.3.2.1	Conditions for use of a tripping device or a monitoring voltage		N/A
H.3.2.2	Tripping device		N/A
H.3.2.3	Monitoring voltage (V) :		N/A
J	INSULATED WINDING WIRES FOR USE WITHOUT INTERLEAVED INSULATION		P
J.1	General		P
	Winding wire insulation..... :	Approved triple insulated wire used. See appended table 4.1.2.	—
	Solid round winding wire, diameter (mm)..... :		N/A
	Solid square and rectangular (flatwise bending) winding wire, cross-sectional area (mm ²)..... :		N/A
J.2/J.3	Tests and Manufacturing		—

IEC 62368-1			
Clause	Requirement + Test	Result - Remark	Verdict
K	SAFETY INTERLOCKS		N/A
K.1	General requirements		N/A
	Instructional safeguard		N/A
K.2	Components of safety interlock safeguard mechanism		N/A
K.3	Inadvertent change of operating mode		N/A
K.4	Interlock safeguard override		N/A
K.5	Fail-safe		N/A
K.5.1	Under single fault condition		N/A
K.6	Mechanically operated safety interlocks		N/A
K.6.1	Endurance requirement		N/A
K.6.2	Test method and compliance		N/A
K.7	Interlock circuit isolation		N/A
K.7.1	Separation distance for contact gaps & interlock circuit elements		N/A
	In circuit connected to mains, separation distance for contact gaps (mm).....		N/A
	In circuit isolated from mains, separation distance for contact gaps (mm).....		N/A
	Electric strength test before and after the test of K.7.2	(See appended table 5.4.9)	N/A
K.7.2	Overload test, Current (A)		N/A
K.7.3	Endurance test		N/A
K.7.4	Electric strength test		N/A
L	DISCONNECT DEVICES		P
L.1	General requirements	Appliance Inlet as disconnect device.	P
L.2	Permanently connected equipment		N/A
L.3	Parts that remain energized	When the power cord is removed from the inlet no remaining parts with hazardous voltage in the equipment.	P
L.4	Single-phase equipment	The disconnect device disconnects both poles simultaneously.	P
L.5	Three-phase equipment		N/A
L.6	Switches as disconnect devices		N/A
L.7	Plugs as disconnect devices		N/A
L.8	Multiple power sources		N/A

IEC 62368-1			
Clause	Requirement + Test	Result - Remark	Verdict
	Instructional safeguard		N/A
M	EQUIPMENT CONTAINING BATTERIES AND THEIR PROTECTION CIRCUITS		N/A
M.1	General requirements		N/A
M.2	Safety of batteries and their cells		N/A
M.2.1	Batteries and their cells comply with relevant IEC standards		N/A
M.3	Protection circuits for batteries provided within the equipment		N/A
M.3.1	Requirements		N/A
M.3.2	Test method		N/A
	Overcharging of a rechargeable battery		N/A
	Excessive discharging		N/A
	Unintentional charging of a non-rechargeable battery		N/A
	Reverse charging of a rechargeable battery		N/A
M.3.3	Compliance	(See appended table M.3)	N/A
M.4	Additional safeguards for equipment containing a portable secondary lithium battery		N/A
M.4.1	General		N/A
M.4.2	Charging safeguards		N/A
M.4.2.1	Requirements		N/A
M.4.2.2	Compliance.....	(See appended table M.4.2)	N/A
M.4.3	Fire enclosure		N/A
M.4.4	Drop test of equipment containing a secondary lithium battery		N/A
M.4.4.2	Preparation and procedure for the drop test		N/A
M.4.4.3	Drop, Voltage on reference and dropped batteries (V); voltage difference during 24 h period (%):		N/A
M.4.4.4	Check of the charge/discharge function		N/A
M.4.4.5	Charge / discharge cycle test		N/A
M.4.4.6	Compliance		N/A
M.5	Risk of burn due to short-circuit during carrying		N/A
M.5.1	Requirement		N/A
M.5.2	Test method and compliance		N/A
M.6	Safeguards against short-circuits		N/A
M.6.1	External and internal faults		N/A
M.6.2	Compliance		N/A

IEC 62368-1			
Clause	Requirement + Test	Result - Remark	Verdict
M.7	Risk of explosion from lead acid and NiCd batteries		N/A
M.7.1	Ventilation preventing explosive gas concentration		N/A
	Calculated hydrogen generation rate		N/A
M.7.2	Test method and compliance		N/A
	Minimum air flow rate, Q (m ³ /h).....		N/A
M.7.3	Ventilation tests		N/A
M.7.3.1	General		N/A
M.7.3.2	Ventilation test – alternative 1		N/A
	Hydrogen gas concentration (%).....		N/A
M.7.3.3	Ventilation test – alternative 2		N/A
	Obtained hydrogen generation rate.....		N/A
M.7.3.4	Ventilation test – alternative 3		N/A
	Hydrogen gas concentration (%).....		N/A
M.7.4	Marking		N/A
M.8	Protection against internal ignition from external spark sources of batteries with aqueous electrolyte		N/A
M.8.1	General		N/A
M.8.2	Test method		N/A
M.8.2.1	General		N/A
M.8.2.2	Estimation of hypothetical volume V_z (m ³ /s)		—
M.8.2.3	Correction factors		—
M.8.2.4	Calculation of distance d (mm)		—
M.9	Preventing electrolyte spillage		N/A
M.9.1	Protection from electrolyte spillage		N/A
M.9.2	Tray for preventing electrolyte spillage		N/A
M.10	Instructions to prevent reasonably foreseeable misuse		N/A
	Instructional safeguard		N/A
N	ELECTROCHEMICAL POTENTIALS		P
	Material(s) used	The internal metal enclosure is made of mild steel, screw spring washer are made of Ni on steel, the combined electrochemical potential is below 0.6V according to Annex N.	—
O	MEASUREMENT OF CREEPAGE DISTANCES AND CLEARANCES		P
	Value of X (mm).....	Considered.	—

IEC 62368-1			
Clause	Requirement + Test	Result - Remark	Verdict
P	SAFEGUARDS AGAINST CONDUCTIVE OBJECTS		P
P.1	General		P
P.2	Safeguards against entry or consequences of entry of a foreign object		P
P.2.1	General	See below.	P
P.2.2	Safeguards against entry of a foreign object	External plastic enclosure and internal metal enclosure used.	P
	Location and Dimensions (mm)	See attachment: Measurement Section for the details.	—
P.2.3	Safeguards against the consequences of entry of a foreign object	See above.	P
P.2.3.1	Safeguard requirements	Complied.	P
	The ES3 and PS3 keep-out volume in Figure P.3 not applicable to transportable equipment		N/A
	Transportable equipment with metalized plastic parts		N/A
P.2.3.2	Consequence of entry test.....		N/A
P.3	Safeguards against spillage of internal liquids		N/A
P.3.1	General		N/A
P.3.2	Determination of spillage consequences		N/A
P.3.3	Spillage safeguards		N/A
P.3.4	Compliance		N/A
P.4	Metallized coatings and adhesives securing parts		P
P.4.1	General	Adhesive for Ripple Capacitors is considered as safeguard; Adhesive for Mylar sheet is considered as safeguard.	P
P.4.2	Tests	After test mentioned above, all safeguards remain effective.	P
	Conditioning, T _c (°C)	112.4 for Adhesive for Ripple Capacitors; 100 for Adhesive for Mylar sheet	—
	Duration (weeks)	1	—
Q	CIRCUITS INTENDED FOR INTERCONNECTION WITH BUILDING WIRING		P
Q.1	Limited power sources		P
Q.1.1	Requirements		P
	a) Inherently limited output		N/A
	b) Impedance limited output		N/A
	c) Regulating network limited output		N/A

IEC 62368-1			
Clause	Requirement + Test	Result - Remark	Verdict
	d) Overcurrent protective device limited output	Output of power board applied. (See appended table Annex Q.1)	P
	e) IC current limiter complying with G.9		N/A
Q.1.2	Test method and compliance	(See appended table Q.1)	P
	Current rating of overcurrent protective device (A)	(See appended Table 4.1.2)	P
Q.2	Test for external circuits – paired conductor cable		N/A
	Maximum output current (A)		N/A
	Current limiting method		—
R	LIMITED SHORT CIRCUIT TEST		P
R.1	General		P
R.2	Test setup		P
	Overcurrent protective device for test	20A circuit breaker is used.	—
R.3	Test method		P
	Cord/cable used for test	1500A passed. Tested between: - AC inlet GND trace and primary Y cap earthed trace; - AC inlet GND trace and primary earthed screw hole trace.	—
R.4	Compliance		P
S	TESTS FOR RESISTANCE TO HEAT AND FIRE		P
S.1	Flammability test for fire enclosures and fire barrier materials of equipment where the steady state power does not exceed 4 000 W		N/A
	Samples, material		—
	Wall thickness (mm)		—
	Conditioning (°C)		—
	Test flame according to IEC 60695-11-5 with conditions as set out		N/A
	- Material not consumed completely		N/A
	- Material extinguishes within 30s		N/A
	- No burning of layer or wrapping tissue		N/A
S.2	Flammability test for fire enclosure and fire barrier integrity		
	Samples, material		—
	Wall thickness (mm)		—

IEC 62368-1			
Clause	Requirement + Test	Result - Remark	Verdict
	Conditioning (°C)		—
S.3	Flammability test for the bottom of a fire enclosure		N/A
S.3.1	Mounting of samples		N/A
S.3.2	Test method and compliance		N/A
	Mounting of samples		—
	Wall thickness (mm)		—
S.4	Flammability classification of materials	See table 4.1.2 for detail	P
S.5	Flammability test for fire enclosure materials of equipment with a steady state power exceeding 4 000 W		N/A
	Samples, material		—
	Wall thickness (mm)		—
	Conditioning (°C)		—
T	MECHANICAL STRENGTH TESTS		P
T.1	General		P
T.2	Steady force test, 10 N	(See appended table T.2)	P
T.3	Steady force test, 30 N	(See appended table T.3)	P
T.4	Steady force test, 100 N		N/A
T.5	Steady force test, 250 N	(See appended table T.5)	P
T.6	Enclosure impact test	(See appended table T.6)	P
	Fall test		P
	Swing test		P
T.7	Drop test		N/A
T.8	Stress relief test.....	(See appended table T.8)	P
T.9	Glass Impact Test		N/A
T.10	Glass fragmentation test		N/A
	Number of particles counted.....		N/A
T.11	Test for telescoping or rod antennas		N/A
	Torque value (Nm)		N/A
U	MECHANICAL STRENGTH OF CATHODE RAY TUBES (CRT) AND PROTECTION AGAINST THE EFFECTS OF IMPLOSION		N/A
U.1	General		N/A
	Instructional safeguard :		N/A
U.2	Test method and compliance for non-intrinsically protected CRTs		N/A
U.3	Protective screen		N/A

IEC 62368-1			
Clause	Requirement + Test	Result - Remark	Verdict
V	DETERMINATION OF ACCESSIBLE PARTS		P
V.1	Accessible parts of equipment		P
V.1.1	General		P
V.1.2	Surfaces and openings tested with jointed test probes		P
V.1.3	Openings tested with straight unjointed test probes		P
V.1.4	Plugs, jacks, connectors tested with blunt probe		N/A
V.1.5	Slot openings tested with wedge probe		N/A
V.1.6	Terminals tested with rigid test wire		N/A
V.2	Accessible part criterion		P
X	ALTERNATIVE METHOD FOR DETERMINING CLEARANCES FOR INSULATION IN CIRCUITS CONNECTED TO AN AC MAINS NOT EXCEEDING 420 V PEAK (300 V RMS)		N/A
	Clearance	(See appended table X)	N/A
Y	CONSTRUCTION REQUIREMENTS FOR OUTDOOR ENCLOSURES		N/A
Y.1	General		N/A
Y.2	Resistance to UV radiation		N/A
Y.3	Resistance to corrosion		N/A
Y.3	Resistance to corrosion		N/A
Y.3.1	Metallic parts of outdoor enclosures are resistant to effects of water-borne contaminants by		N/A
Y.3.2	Test apparatus		N/A
Y.3.3	Water – saturated sulphur dioxide atmosphere		N/A
Y.3.4	Test procedure		N/A
Y.3.5	Compliance		N/A
Y.4	Gaskets		N/A
Y.4.1	General		N/A
Y.4.2	Gasket tests		N/A
Y.4.3	Tensile strength and elongation tests		N/A
	Alternative test methods		N/A
Y.4.4	Compression test		N/A
Y.4.5	Oil resistance		N/A
Y.4.6	Securing means	(See Annex P.4)	N/A
Y.5	Protection of equipment within an outdoor enclosure		N/A
Y.5.1	General		N/A
Y.5.2	Protection from moisture		N/A

IEC 62368-1			
Clause	Requirement + Test	Result - Remark	Verdict
	Relevant tests of IEC 60529 or Y.5.3		N/A
Y.5.3	Water spray test		N/A
Y.5.4	Protection from plants and vermin		N/A
Y.5.5	Protection from excessive dust		N/A
Y.5.5.1	General		N/A
Y.5.5.2	IP5X equipment		N/A
Y.5.5.3	IP6X equipment		N/A
Y.6	Mechanical strength of enclosures		N/A
Y.6.1	General		N/A
Y.6.2	Impact test		N/A

IEC 62368-1			
Clause	Requirement + Test	Result - Remark	Verdict

5.2		TABLE: Classification of electrical energy sources					P
Supply Voltage	Location (e.g. circuit designation)	Test conditions	Parameters				ES Class
			U (V)	I (mA)	Type ¹⁾	Additional Info ²⁾	
Tested on power board 715G9611							
264V, 60Hz	+19V output of power board to “-”/GND	Normal	19.4Vdc	--	SS	--	ES1
		Abnormal – (see table B.3 for details, maximum result recorded)	19.4Vdc	--	SS	--	
		Single fault – (see table B.4 for details, maximum result recorded)	19.1Vdc	--	SS	--	
264V, 60Hz	LED backlight output to “-” /GND	Normal	56.6Vdc	--	SS	--	ES1
		Abnormal – (see table B.3 for details, maximum result recorded)	56.6Vdc	--	SS	--	
		Single fault – (see table B.4 for details, maximum result recorded)	56.6Vdc	--	SS	--	
Tested on power board 715GB018							
264V, 60Hz	+19V output of SPS to “-”/GND	Normal	19.1Vdc	--	SS	--	ES1
		Abnormal – (see table B.3 for details, maximum result recorded)	19.1Vdc	--	SS	--	
		Single fault – (see table B.4 for details, maximum result recorded)	19.1Vdc	--	SS	--	
264V, 60Hz	LED backlight output to “-” /GND	Normal	37.4Vdc	--	SS	--	ES1
		Abnormal – (see table B.3 for details, maximum result recorded)	37.4Vdc	--	SS	--	

IEC 62368-1			
Clause	Requirement + Test	Result - Remark	Verdict

		Single fault – (see table B.4 for details, maximum result recorded)	37.4Vdc	--	SS	--	ES1
--	--	---	---------	----	----	----	-----

Tested on power board 715GC031

264V, 60Hz	+19V output of SPS to “-”/GND	Normal	19.2Vdc	--	SS	--	ES1
		Abnormal – (see table B.3 for details, maximum result recorded)	19.2Vdc	--	SS	--	
		Single fault – (see table B.4 for details, maximum result recorded)	19.2Vdc	--	SS	--	
264V, 60Hz	LED backlight output to “-”/GND	Normal	57.9Vdc	--	SS	--	ES1
		Abnormal – (see table B.3 for details, maximum result recorded)	57.9Vdc	--	SS	--	
		Single fault – (see table B.4 for details, maximum result recorded)	57.9Vdc	--	SS	--	

Supplementary information:

- 1) Type: Steady state (SS), Capacitance (CP), Single pulse (SP), Repetitive pulses (RP), etc.
- 2) Additional Info: Frequency, Pulse duration, Pulse off time, Capacitance value, etc.

5.4.1.8	TABLE: Working voltage measurement				P
Location	RMS voltage (V)	Peak voltage (V)	Frequency (Hz)	Comments	
Tested on power board 715G9611					
T901 Pin 1-6	219	344			
T901 Pin 1-10	225	231			
T901 Pin 3-6	332	610	100k	The Max. Vpeak	
T901 Pin 3-10	337	360	100k	The Max. Vrms	
T901 Pin 4-6	125	192			
T901 Pin 4-10	214	385			

IEC 62368-1				
Clause	Requirement + Test	Result - Remark		Verdict
T901 Pin 5-6	207	367		
T901 Pin 5-10	227	341		
U902 Pin 1-3	196	359		
U902 Pin 1-4	195	358		
U902 Pin 2-3	195	358		
U902 Pin 2-4	196	359		
C900/C944 Pin 1-2	222	345		
Test with power board 715GB018				
T9101: Pin 1 to pin 7,8	265	405		
T9101: Pin 1 to pin 10,11,12	268	484		
T9101: Pin 3 to pin 7,8	276	525	65k	Max. Vrms & Vpeak
T9101: Pin 3 to pin 10,11,12	271	503	--	
T9101: Pin 5 to pin 7,8	203	419	--	
T9101: Pin 5 to pin 10,11,12	203	353	--	
T9101: Pin 6 to pin 7,8	205	348	--	
T9101: Pin 6 to pin 10,11,12	207	362		
C9911 primary pin – secondary pin	205	352	--	
U9102 pin 1 to 3	215	362	--	
U9102 pin 1 to 4	215	362	--	
U9102 pin 2 to 3	217	362	--	
U9102 pin 2 to 4	213	362	--	
U9401 pin 1 to 3	193	362	--	
U9401 pin 1 to 4	189	362	--	
U9401 pin 2 to 3	190	362		
U9401 pin 2 to 4	193	362		
Tested on power board 715GC031				
T901 Pin 1 to pin 6	214	335		
T901 Pin 1 to pin 10	216	434		
T901 Pin 3 to pin 6	251	469	90k	The Max. Vrms
T901 Pin 3 to pin 10	235	501	90k	The Max. Vpeak
T901 Pin 4 to pin 6	212	419		
T901 Pin 4 to pin 10	215	394		
T901 Pin 5 to pin 6	217	344		
T901 Pin 5 to pin 10	220	369		

IEC 62368-1				
Clause	Requirement + Test	Result - Remark		Verdict
U902 Pin 1 to pin 3	232	369		
U902 Pin 1 to pin 4	232	369		
U902 Pin 2 to pin 3	232	369		
U902 Pin 2 to pin 4	232	369		
C900 primary pin – secondary pin	222	345		
Supplementary information:				
Input Voltage is 264Vac, 60Hz.				

5.4.1.10.2	TABLE: Vicat softening temperature of thermoplastics			N/A
Method	ISO 306 / B50			—
Object/ Part No./Material	Manufacturer/trademark	Thickness (mm)	T softening (°C)	
Supplementary information:				

5.4.1.10.3	TABLE: Ball pressure test of thermoplastics				P
Allowed impression diameter (mm)	≤ 2 mm				—
Object/Part No./Material	Manufacturer/trademark	Thickness (mm)	Test temperature (°C)	Impression diameter (mm)	
Line choke, type PBT-4115	Chang Chun	See Table 4.1.2	125	1.0	
Line choke, type PBT-4130	Chang Chun	See Table 4.1.2	125	1.0	
Line choke, type FR-530L	E I De Nemours & Co., Ltd.	See Table 4.1.2	125	1.0	
Plastic enclosure: HIPS-5197, 2.5mm	Kingfa	See Table 4.1.2	90	1.59	
Plastic enclosure: GAR-011(L85), 2.5mm	Kingfa	See Table 4.1.2	85	1.31	
Plastic enclosure: GAR-011(L65), 2.5mm	Kingfa	See Table 4.1.2	85	1.29	
Plastic enclosure: HIPS-510(H), 2.5mm	Kingfa	See Table 4.1.2	80	1.29	
Plastic enclosure: FRHIPS-960, 2.5mm	Kingfa	See Table 4.1.2	85	1.88	
Plastic enclosure: GC-0750(+), 2.5mm	Cheil	See Table 4.1.2	80	1.61	

IEC 62368-1				
Clause	Requirement + Test		Result - Remark	Verdict
Plastic enclosure: GC-0700(+), 2.5mm	Cheil	See Table 4.1.2	80	1.94
Plastic enclosure: HG-0760(+), 2.5mm	Cheil	See Table 4.1.2	85	1.73
Plastic enclosure: LX-0951(+), 2.5mm	Cheil	See Table 4.1.2	85	1.83
Plastic enclosure: SD-0150, 2.5mm	Cheil	See Table 4.1.2	85	1.48
Plastic enclosure: HR-1360, 2.5mm	Cheil	See Table 4.1.2	85	1.71
Plastic enclosure: BF-0670F, 2.5mm	Cheil	See Table 4.1.2	80	1.59
Plastic enclosure: HF380, 2.5mm	LG	See Table 4.1.2	85	1.48
Plastic enclosure: SE885, 2.5mm	LG	See Table 4.1.2	80	1.42
Plastic enclosure: LUPOY GP-1000(#), 2.5mm	LG	See Table 4.1.2	95	1.21
Plastic enclosure: XG568, 2.5mm	LG	See Table 4.1.2	80	1.81
Plastic enclosure: XG569C, 2.5mm	LG	See Table 4.1.2	80	1.85
Plastic enclosure: HF388H, 2.5mm	LG	See Table 4.1.2	85	1.39
Plastic enclosure: SE750, 2.5mm	LG	See Table 4.1.2	80	1.5
Plastic enclosure: TN-7500, 2.5mm	Teijin	See Table 4.1.2	85	1.57
Plastic enclosure: HIPS-2000, 2.5mm	ORINKO	See Table 4.1.2	85	1.48
Plastic enclosure: GAR-011C, 2.5mm	Kingfa	See Table 4.1.2	90	1.91
Supplementary information:				
Above mentioned plastic enclosure material was tested by client's request.				

IEC 62368-1			
Clause	Requirement + Test	Result - Remark	Verdict

5.4.2, 5.4.3 TABLE: Minimum Clearances/Creepage distance								P
Clearance (cl) and creepage distance (cr) at/of/between:	U _p (V)	U _{rms} (V)	Freq ¹⁾ (Hz)	Required cl (mm)	cl (mm)	E.S. ²⁾ (V)	Required cr (mm)	cr (mm)
Tested on power board 715G9611								
Basic/supplementary:								
Under fuse (F901)	420	250	--	2.3	2.8	--	2.5	4.2
Before fuse (between L-N)	420	250	--	2.3	4.3	--	2.5	4.3
Line-GND ^{1.}	420	250	--	2.3	3.1	--	2.5	3.6
Neutral-GND ^{1.}	420	250	--	2.3	3.1	--	2.5	3.6
Under C920 ^{1.}	420	250	--	2.3	3.5	--	2.5	3.5
Under C921 ^{1.}	420	250	--	2.3	4.1	--	2.5	4.1
Primary component (main transformer) to metal enclosure	610	337	100	2.3	4.5	--	3.4	4.5
Primary component trace to panel ^{6.}	610	337	100	2.3	5.	--	3.4	5.
Reinforced:								
Under T901	610	337	100	4.5	8.1	--	6.8	8.1
Under C900 ^{1.}	420	250	--	4.5	7.6	--	5.0	9.4
Under U902 ^{1.}	420	250	--	4.5	7.8	--	5.6	9.2
Secondary component (C942) to core of transformer (T901)	610	337	100	4.5	7.6	--	6.8	7.6
Supplementary information:								
Note 1: Only for frequency above 30 kHz								
Note 2: Complete Electric Strength voltage (E.S. (V) when 5.4.2.4 applied)								
1. There is one slot measured 1mm width.								
2. Core of main transformer T901 consider as primary, and Core of transformer T901 wrapped with two layers of tape.								
3. Glued components: C902 and C903.								
4. Considered altitude correction factor 1.48 for clearances for an altitude of 5000m.								
5. For clearance and creepage that did not describe above are far larger than limit above.								
6. One Mylar sheet is fixed between power board and panel plate to fulfill the requirement for basic insulation. See Table 5.4.9 for the electric strength test for Mylar.								

IEC 62368-1			
Clause	Requirement + Test	Result - Remark	Verdict

5.4.2, 5.4.3 TABLE: Minimum Clearances/Creepage distance								P
Clearance (cl) and creepage distance (cr) at/of/between:	U _p (V)	U _{rms} (V)	Freq ¹⁾ (Hz)	Required cl (mm)	cl (mm)	E.S. ²⁾ (V)	Required cr (mm)	cr (mm)
Test with power board 715GB018								
Basic/supplementary:								
Under fuse (F9901)	420	250	--	2.3	2.6	--	2.5	2.6
Before fuse (between L-N)	420	250	--	2.3	3.2	--	2.5	3.2
Line-GND ^{1.}	420	250	--	2.3	3.1	--	3.0	4.2
Neutral-GND ^{1.}	420	250	--	2.3	3.1	--	3.0	4.2
Under C9901	420	250	--	2.3	7.6	--	3.0	7.6
Under C9902	420	250	--	2.3	7.6	--	3.0	7.6
Under C9909	420	250	--	2.3	7.6	--	3.0	7.6
Under C9910	420	250	--	2.3	7.6	--	3.0	7.6
Primary component (main transformer) to metal enclosure	525	276	65k	2.3	4.4	--	2.8	4.4
Primary component trace to panel ^{4.}	525	276	65k	2.3	6.	--	2.8	6.
Reinforced:								
Under T9101	525	276	65k	4.5	13.4	--	5.6	13.4
U9102 primary pin to U9102 secondary pin (trace side)	420	250	--	4.5	8.0	--	6.0	8.0
U9401 primary pin to U9401 secondary pin (trace side)	420	250	--	4.5	8.0	--	6.0	8.0
Under C9911	420	250	--	4.5	7.8	--	6.0	7.8
Secondary component D805 to core of T9101	525	276	65k	4.5	6.7	--	5.6	6.7
Supplementary information:								

IEC 62368-1			
Clause	Requirement + Test	Result - Remark	Verdict

Note 1: Only for frequency above 30 kHz

Note 2: Complete Electric Strength voltage (E.S. (V) when 5.4.2.4 applied)

1. There is one slot measured 1mm width.
2. Core of main transformer T9101 consider as primary.
3. One Mylar sheet is fixed between primary component trace and panel to fulfill the requirement for reinforced insulation. See table 5.4.9 for the electric strength test for Mylar.
4. One Mylar sheet is fixed between power board and panel plate to fulfill the requirement for basic insulation. See table 5.4.9 for the electric strength test for Mylar.
5. Glued component: C9814
6. Considered altitude correction factor 1.48 for clearances for an altitude of 5000m.

5.4.2, 5.4.3 TABLE: Minimum Clearances/Creepage distance								P
Clearance (cl) and creepage distance (cr) at/of/between:	U _p (V)	U _{rms} (V)	Freq ¹⁾ (Hz)	Required cl (mm)	cl (mm)	E.S. ²⁾ (V)	Required cr (mm)	cr (mm)
Test with power board 715GC031								
Basic/supplementary:								
Under fuse (F901)	420	250	--	2.3	3.0	--	2.5	3.4
Before fuse (between L-N) ^{1.}	420	250	--	2.3	3.6	--	2.5	3.6
Line-GND ^{1.}	420	250	--	2.3	3.0	--	3.0	3.8
Neutral-GND ^{1.}	420	250	--	2.3	3.0	--	3.0	3.8
Under C920 ^{1.}	420	250	--	2.3	3.8	--	3.0	3.8
Under C921 ^{1.}	420	250	--	2.3	5.9	--	3.0	5.9
Primary component (main transformer) to metal enclosure	501	251	90k	2.3	4.0	--	2.6	^{6.}
Primary component trace to panel ^{4.}	501	251	90k	2.3	^{6.}	--	2.6	^{6.}
Reinforced:								
Under T901	501	251	90k	4.5	12.0	--	5.1	12.0
Under C900 ^{1.}	420	250	--	4.5	7.5	--	5.0	7.5
Under U902 ^{1.}	420	250	--	4.5	7.5	--	5.0	7.5
Secondary component (C942) to core of transformer (T901)	501	251	90k	4.5	7.6	--	5.1	7.6
Supplementary information:								

IEC 62368-1			
Clause	Requirement + Test	Result - Remark	Verdict

Note 1: Only for frequency above 30 kHz

Note 2: Complete Electric Strength voltage (E.S. (V) when 5.4.2.4 applied)

1. There is one slot measured 1mm width.
2. Core of main transformer T901 consider as primary, and Core of transformer T901 wrapped with two layers of tape.
3. One mylar sheet is fixed between primary component trace and panel to fulfill the requirement for reinforced insulation. See table 5.2 for the electric strength test for mylar.
4. One mylar sheet is fixed between power board and panel plate to fulfill the requirement for basic insulation. See table 5.2 for the electric strength test for mylar.
5. Glued components: C902 and C903.
6. For clearance and creepage that did not describe above are far larger than limit above.
7. Considered altitude correction factor 1.48 for clearances for an altitude of 5000m.

5.4.4.2	TABLE: Minimum distance through insulation				P
Distance through insulation (DTI) at/of	Peak voltage (V)	Insulation	Required DTI (mm)	Measured DTI (mm)	
Plastic enclosure	420	Basic	0.4	See table 4.1.2	
Photo Coupler	420	Reinforced	0.4	See table 4.1.2	
Bobbin of transformer	See Table 5.4.2.2, 5.4.2.4 and 5.4.3	Reinforced	0.4	See table 4.1.2	
Mylar sheet	See Table 5.4.2.2, 5.4.2.4 and 5.4.3	Basic	0.4	See table 4.1.2	
Supplementary information:					

5.4.4.9	TABLE: Solid insulation at frequencies >30 kHz					N/A
Insulation material	E_P	Frequency (kHz)	K_R	Thickness d (mm)	Insulation	V_{PW} (Vpk)
Supplementary information:						
Electric strength test according to 5.4.9 will be applied.						

IEC 62368-1			
Clause	Requirement + Test	Result - Remark	Verdict

5.4.9	TABLE: Electric strength tests			P
Test voltage applied between:	Voltage shape (Surge, Impulse, AC, DC, etc.)	Test voltage (V)	Breakdown Yes / No	
Tested on power board 715G9611				
Basic/supplementary:				
Unit primary to earthed metal part	AC	2500	No	
Mylar sheet ²⁾	AC	2500	No	
Reinforced:				
L/N to accessible plastic enclosure with metal foil	AC	4000	No	
Unit primary to secondary (output)	DC	4000	No	
T901 ¹⁾ : primary to secondary	AC	4000	No	
T901 ¹⁾ : secondary to core	AC	4000	No	
T901 ¹⁾ : each layer of insulation tape	AC	4000	No	
Supplementary information:				
<ol style="list-style-type: none"> For all sources of transformer; For all source of mylar sheet; The tests mentioned above were performed after humidity test and heating test. 				

5.4.9	TABLE: Electric strength tests			P
Test voltage applied between:	Voltage shape (Surge, Impulse, AC, DC, etc.)	Test voltage (V)	Breakdown Yes / No	
Tested with power board 715GB018				
Basic/supplementary:				
Unit primary to earthed metal part	AC	2500	No	
Mylar sheet ²⁾	AC	2500	No	
Reinforced:				
L/N to external plastic enclosure with metal foil	AC	4000	No	
L/N to output terminals	DC	4000	No	
T9101 ¹⁾ : primary to secondary	AC	4000	No	
T9101 ¹⁾ : core to primary	AC	4000	No	
T9101 ¹⁾ : each layer of insulation tape	AC	4000	No	
Supplementary information:				

IEC 62368-1			
Clause	Requirement + Test	Result - Remark	Verdict

<ol style="list-style-type: none"> For all sources of transformer; For all source of mylar sheet; The tests mentioned above were performed after humidity test and heating test.

5.4.9	TABLE: Electric strength tests			P
Test voltage applied between:	Voltage shape (Surge, Impulse, AC, DC, etc.)	Test voltage (V)	Breakdown Yes / No	
Tested on power board 715GC031				
Basic/supplementary:				
Unit primary to earthed metal part	AC	2500	No	
Mylar sheet ²⁾	AC	2500	No	
Reinforced:				
L/N to accessible plastic enclosure with metal foil	AC	4000	No	
Unit primary to secondary (output)	DC	4000	No	
T901 ¹⁾ : primary to secondary	AC	4000	No	
T901 ¹⁾ : core to secondary	AC	4000	No	
T901 ¹⁾ : two layers of three insulation tapes (for insulation layer wrap core)	AC	4000	No	
Supplementary information:				
<ol style="list-style-type: none"> For all sources of transformer; For all source of mylar sheet; The tests mentioned above were performed after humidity test and heating test. 				

5.5.2.2	TABLE: Stored discharge on capacitors				P
Location	Supply voltage (V)	Operating and fault condition ¹⁾	Switch position	Measured voltage (Vpk)	ES Class
Tested on power board 715G9611					
L-N	264V, 60Hz	N	N/A	0V	ES1
Supplementary information:					
X-capacitors installed for testing: See Table 4.1.2 [x] Approved bleeding resistor rating: Table 4.1.2 [] ICX: 1) Normal operating condition (e.g., normal operation, or open fuse), SC= short circuit, OC= open circuit					

IEC 62368-1			
Clause	Requirement + Test	Result - Remark	Verdict

5.5.2.2	TABLE: Stored discharge on capacitors					P
Location	Supply voltage (V)	Operating and fault condition ¹⁾	Switch position	Measured voltage (Vpk)	ES Class	
Tested on power board 715GB018						
L-N	264V, 60Hz	N	N/A	0V	ES1	
Supplementary information:						
X-capacitors installed for testing: See Table 4.1.2						
<input type="checkbox"/> Bleeding resistor rating: <input checked="" type="checkbox"/> ICX: Table 4.1.2 for the details. 1) Normal operating condition (e.g., normal operation, or open fuse), SC= short circuit, OC= open circuit						

5.5.2.2	TABLE: Stored discharge on capacitors					P
Location	Supply voltage (V)	Operating and fault condition ¹⁾	Switch position	Measured voltage (Vpk)	ES Class	
Tested on power board 715GC031						
L-N	264V, 60Hz	N	N/A	0V	ES1	
L-N	264V, 60Hz	S (R916 opened)	N/A	17V	ES1	
Supplementary information:						
X-capacitors installed for testing: See Table 4.1.2						
<input checked="" type="checkbox"/> Bleeding resistor rating: See Table 4.1.2 for the details. <input type="checkbox"/> ICX: 1) Normal operating condition (e.g., normal operation, or open fuse), SC= short circuit, OC= open circuit						

5.6.6	TABLE: Resistance of protective conductors and terminations				P
Location	Test current (A)	Duration (min)	Voltage drop (V)	Resistance (Ω)	
Tested on power board 715G9611					
PE terminal of AC inlet to internal metal enclosure	40	2	0.60	0.015	
PE terminal of AC inlet to C902 trace	40	2	0.36	0.009	
PE terminal of AC inlet to C903 trace	40	2	0.32	0.008	
Tested on power board 715GB018					
PE terminal of AC inlet to internal metal enclosure	40	2	0.24	0.006	

IEC 62368-1				
Clause	Requirement + Test	Result - Remark		Verdict
PE terminal of AC inlet to C9901/C9902 trace	40	2	0.24	0.006
PE terminal of AC inlet to C9909/C9910 trace	40	2	0.32	0.008
Tested on power board 715GC031				
PE terminal of AC inlet to internal metal enclosure	40	2	0.16	0.004
PE terminal of AC inlet to C920/C921 secondary earth trace	40	2	0.16	0.004
Supplementary information:				

5.7.4	TABLE: Unearthed accessible parts					P
Location	Operating and fault conditions	Supply Voltage (V)	Parameters			ES class
			Voltage (V _{rms} or V _{pk})	Current (A _{rms} or A _{pk})	Freq. (Hz)	
L/N to All secondary port	Normal	264V, 60Hz	--	0.01mA _{pk}	--	ES1
	Abnormal		--	0.01mA _{pk}	--	
	Single fault		--	0.01mA _{pk}	--	
L/N to button of key board	Normal	264V, 60Hz	--	0.01mA _{pk}	--	ES1
	Abnormal		--	0.01mA _{pk}	--	
	Single fault		--	0.01mA _{pk}	--	
Supplementary information:						
Abbreviation: SC= short circuit; OC= open circuit						
Tested on three power boards, and worst test result was recorded in this table.						

5.7.5	TABLE: Earthed accessible conductive part			P
Supply voltage (V)	264Vac			—
Phase(s)	<input type="checkbox"/> Single Phase; <input type="checkbox"/> Three Phase: <input checked="" type="checkbox"/> Delta <input type="checkbox"/> Wye			
Power Distribution System	<input checked="" type="checkbox"/> TN <input type="checkbox"/> TT <input type="checkbox"/> IT			
Location	Fault Condition No in IEC 60990 clause 6.2.2	Touch current (mA)	Comment	
Tested on power board 715G9611				
L – metal enclosure	1	0.35	Switch “e” open	
N – metal enclosure	1	0.35	Switch “e” open	
Tested on power board 715GC031				
L – metal enclosure	1	0.36	Switch “e” open	

IEC 62368-1			
Clause	Requirement + Test	Result - Remark	Verdict
N – metal enclosure	1	0.36	Switch “e” open
Tested on power board 715GB018			
L – metal enclosure	1	0.33	Switch “e” open
N – metal enclosure	1	0.33	Switch “e” open
Supplementary Information:			
Tested with normal, abnormal and single-fault condition, and maximum value was recorded.			

5.8	TABLE: Backfeed safeguard in battery backed up supplies					N/A
Location	Supply voltage (V)	Operating and fault condition	Time (s)	Open-circuit voltage (V)	Touch current (A)	ES Class
Supplementary information:						
Abbreviation: SC= short circuit, OC= open circuit						

6.2.2	TABLE: Power source circuit classifications					P
Location	Operating and fault condition	Voltage (V)	Current (A)	Max. Power ¹⁾ (W)	Time (S)	PS class
+19V output after fuse of power boards	(See Table Annex Q.1)	(See Table Annex Q.1)	(See Table Annex Q.1)	(See Table Annex Q.1)	5	PS2
All data ports output of main boards	(See Table Annex Q.1)	(See Table Annex Q.1)	(See Table Annex Q.1)	(See Table Annex Q.1)	5	PS2
Supplementary information:						
Abbreviation: SC= short circuit; OC= open circuit						
1) Measured after 3 s for PS1 and measured after 5 s for PS2 and PS3.						

6.2.3.1	TABLE: Determination of Arcing PIS				P
Location	Open circuit voltage after 3 s (V _{pk})	Measured r.m.s current (A)	Calculated value	Arcing PIS? Yes / No	
2)	2)	2)	2)	Yes	
Supplementary information:					
1) An Arcing PIS requires a minimum of 50 V (peak) a.c. or d.c. An Arcing PIS is established when the product of the open circuit voltage (V _p) and normal operating condition rms current (I _{rms}) is greater than 15.					
2) All components located within the power board are considered as arcing PIS.					

IEC 62368-1			
Clause	Requirement + Test	Result - Remark	Verdict

6.2.3.2	TABLE: Determination of resistive PIS			P
Location	Operating and fault condition		Dissipate power (W)	Arcing PIS? Yes / No
3)	3)		3)	Yes
Supplementary information:				
<p>1) A combination of voltmeter, VA and ammeter IA may be used instead of a wattmeter. If a separate voltmeter and ammeter are used, the product of (VA x IA) is used to determine Resistive PIS classification.</p> <p>2) A Resistive PIS: (a) dissipates more than 15 W, measured after 30 s of normal operation, or (b) under single fault conditions has either a power exceeding 100 W measured immediately after the introduction of the fault if electronic circuits, regulators or PTC devices are used, or has an available power exceeding 15 W measured 30 s after introduction of the fault.</p> <p>3) All components located within the EUT are considered as resistive PIS.</p>				

8.5.5	TABLE: High pressure lamp				N/A
Lamp manufacturer	Lamp type	Explosion method	Longest axis of glass particle (mm)	Particle found beyond 1 m Yes / No	
Supplementary information:					

9.6	TABLE: Temperature measurements for wireless power transmitters								N/A
Supply voltage (V)..... :								—	
Max. transmit power of transmitter (W)..... :								—	
Foreign objects	w/o receiver and direct contact		with receiver and direct contact		with receiver and at distance of 2 mm		with receiver and at distance of 5 mm		
	Object (°C)	Ambient (°C)	Object (°C)	Ambient (°C)	Object (°C)	Ambient (°C)	Object (°C)	Ambient (°C)	
Supplementary information:									

IEC 62368-1			
Clause	Requirement + Test	Result - Remark	Verdict

5.4.1.4, 9.3, B.1.5, B.2.6	TABLE: Temperature measurements				P
Supply voltage (V)	90V/ 60Hz	264V/ 60Hz	90V/ 60Hz	264V/ 60Hz	—
Ambient temperature during test T_{amb} (°C)	See below	See below	See below	See below	—
Maximum measured temperature T of part/at:	T (°C)				Allowed T_{max} (°C)
Tested on 23.8 inch models with power board 715G9611, mainboard 715G9584 and USB board 715GA629, HDMI mode					
--	Horizontal		Vertical		--
Line pin of AC Inlet CN901 (on power board)	56.0	55.9	59.7	--	70
PCB near TH901 (on power board)	73.0	65.7	76.7	--	130
C900 body (on power board)	71.8	60.7	75.5	--	85
L901 coil (on power board)	75.5	64.2	79.2	--	105
PCB near BD901 (on power board)	92.2	67.8	95.9	--	130
C921 body (on power board)	57.8	72.7	61.5	--	85
U902 body (on power board)	75.1	69.2	78.8	--	100
T901 coil (on power board)	103.9	89.2	107.6	--	110
T901 core (on power board)	101.5	79.4	105.2	--	110
C914 body (on power board)	68.3	60.1	72.0	--	85
C902 body (on power board)	82.8	62.3	86.5	--	100
PCB near D906 (on power board)	106.7	91.4	110.4	--	130
PCB near U401 body (main board)	66.0	67.7	69.7	--	130
PCB near L801 (on power board)	78.7	71.1	82.4	--	130
Ambient	40	40	40	--	--
Touch temperature for accessible part under normal condition					
Metal enclosure near T901	42.7	40.6	43.0	--	70
Plastic enclosure outside near T901	35.1	33.4	35.4	--	94
Panel surface	34.6	29.9	34.9	--	94
Button	32.4	32.6	32.7	--	77
Ambient	25	25	25	--	--
Tested on 27 inch model with power board 715G9611, main board 715G9584 and USB board 715GA629					
Line pin of AC Inlet CN901 (on power board)	55.1	55.1	58.8	--	70
PCB near TH901 (on power board)	85.5	72.3	89.2	--	130

IEC 62368-1					
Clause	Requirement + Test	Result - Remark			Verdict
C900 body (on power board)	72.8	64.4	76.5	--	85
L901 coil (on power board)	83.6	73.3	87.3	--	105
PCB near BD901 (on power board)	89.0	73.4	92.7	--	130
C921 body (on power board)	61.9	74.9	65.6	--	85
U902 body (on power board)	84.6	79.7	88.3	--	100
T901 coil (on power board)	97.6	89.2	101.3	--	110
T901 core (on power board)	93.4	95.9	97.1	--	110
C914 body (on power board)	63.4	69.3	67.1	--	85
C902 body (on power board)	83.9	90.5	87.6	--	100
PCB near D906 (on power board)	117.6	92.1	121.3	--	130
PCB near U401 body (main board)	66.1	91.4	69.8	--	130
PCB near L801 (on power board)	81.7	73.6	85.4	--	130
Ambient	40	40	40	--	--
Touch temperature for accessible part under normal condition					
Metal enclosure near T901	45.7	43.9	46.0	--	70
Plastic enclosure outside near T901	33.5	40.5	33.8	--	94
Panel surface	31.8	34.0	32.1	--	94
Button	26.1	37.5	26.4	--	77
Ambient	25	25	25	--	--
Tested on 23.8 inch model with power board 715GB018, main board 715G9584 and USB 715GA629, HDMI mode					
AC inlet CN9901 (on power board)	55.1	59.0	--	60.8	70
X-cap C9905 (on power board)	61.2	67.8	--	66.5	85
Y-cap C9909 (on power board)	60.7	66.5	--	69.6	85
Y-cap C9901 (on power board)	58.1	61.4	--	61.2	85
Y-cap C9911 (on power board)	66.5	67.9	--	75.0	85
E-cap C9814 (on power board)	67.6	79.5	--	83.1	105
L9902 Coil (on power board)	68.0	85.0	--	82.6	105
L9801 Coil (on power board)	66.0	70.6	--	66.0	105
L801 Coil (on power board)	85.7	88.5	--	76.9	105
T9101 Coil (on power board)	89.0	90.5	--	84.0	110
T9101 Core (on power board)	89.8	90.0	--	83.9	110
Opto-coupler U9401 body (on power board)	65.8	66.5	--	75.8	100
PCB near NR9901 (on power board)	67.1	80.7	--	85.6	105

IEC 62368-1					
Clause	Requirement + Test		Result - Remark		Verdict
PCB near BD9901 (on power board)	71.1	89.6	--	89.2	105
PCB near Q9101 (on power board)	78.6	78.9	--	85.5	105
PCB near D9105 (on power board)	84.3	83.9	--	85.5	105
PCB near Q9801 (on power board)	63.5	67.7	--	64.0	105
PCB near main IC (on main board)	40.6	39.2	--	39.5	105
Ambient	40	40	--	40	--
Touch temperature for accessible part under normal condition					
Metal enclosure	44.1	45.7	--	41.1	70
Plastic enclosure outside near T901	32.9	33.4	--	31.2	94
Panel surface	35.4	36.4	--	33.2	94
Ambient	25	25	--	25	--
Tested on 27 inch model with power board 715GC031, main board 715GC003, HDMI mode					
AC Inlet body CN901	53.8	56.8	--	61.1	70
Y-cap C920	56.3	59.2	--	66.6	85
Y-cap C900	70.0	77.3	--	72.2	85
X-cap C914	65.6	73.4	--	74.8	85
E cap C902	68.1	75.7	--	84.4	105
L901 coil	66.9	80.7	--	83.2	105
L801 coil	96.5	100.3	--	87.7	105
L903 coil	84.1	83.9	--	87.8	105
PCB near TH901	76.8	93	--	88.1	105
PCB near Q901	77.4	77.4	--	88.1	105
PCB near BD901	69.8	81.8	--	84.0	105
PCB near D901	98.7	97.3	--	101.4	105
PCB near D801	89.2	93.4	--	87.0	105
Opto coupler U902	73.8	74.3	--	83.0	100
T901 coil	96.1	97.8	--	97.5	110
T901 core	96.2	96.8	--	96.5	110
PCB near main IC (on main board)	72.7	73.8	--	69.8	105
Ambient	40	40	--	40	--
Touch temperature for accessible part under normal condition					
Metal enclosure	45.8	47.8	--	45.4	70
Plastic enclosure outside near T901	32.2	32.7	--	32.4	94
Panel surface	36.4	37	--	35.4	94

IEC 62368-1			
Clause	Requirement + Test	Result - Remark	Verdict

Ambient			25	25	--	25	--
Temperature T of winding:	t ₁ (°C)	R ₁ (Ω)	t ₂ (°C)	R ₂ (Ω)	T (°C)	Allowed T _{max} (°C)	Insulation class
--	--	--	--	--	--	--	--
Supplementary information:							
<p>1. The temperatures were measured under worst case normal mode defined in B.2.5 and at voltages as described above.</p> <p>2. The instruction installation manual defines the T_{ma} at 40 °C.</p> <p><u>Winding components (providing safety isolation):</u></p> <p>- Class 130 material (B) T_{max} = 120 °C – 10 °C = 110 °C</p> <p><u>Components with maximum absolute temperature of others:</u></p> <p>T_{max} = T_{max} of component</p> <p>3. All values for T (°C) are re-calculated from actual ambient.</p>							

B.2.5		TABLE: Input test							P
U (V)	Hz	I (A)	I rated (A)	P (W)	P rated (W)	Fuse No	I fuse (A)	Condition/status	
Tested on 23.8 inch model with power board 715G9611, main board 715G9584 and USB board 715GA629									
HDMI mode									
90	50	0.952	--	53.4	--	F901	0.952	Maximum normal load ^{1.}	
90	60	0.907	--	53.0	--	F901	0.907	Maximum normal load ^{1.}	
100	50	0.849	1.5	52.5	--	F901	0.849	Maximum normal load ^{1.}	
100	60	0.817	1.5	52.4	--	F901	0.817	Maximum normal load ^{1.}	
240	50	0.406	1.5	51.4	--	F901	0.406	Maximum normal load ^{1.}	
240	60	0.397	1.5	51.3	--	F901	0.397	Maximum normal load ^{1.}	
264	50	0.377	--	51.4	--	F901	0.377	Maximum normal load ^{1.}	
264	60	0.370	--	51.4	--	F901	0.370	Maximum normal load ^{1.}	
DisplayPort mode									
90	50	0.943	--	53.0	--	F901	0.943	Maximum normal load ^{1.}	
90	60	0.904	--	52.8	--	F901	0.904	Maximum normal load ^{1.}	
100	50	0.847	1.5	52.5	--	F901	0.847	Maximum normal load ^{1.}	
100	60	0.816	1.5	52.3	--	F901	0.816	Maximum normal load ^{1.}	
240	50	0.403	1.5	51.2	--	F901	0.403	Maximum normal load ^{1.}	
240	60	0.395	1.5	51.2	--	F901	0.395	Maximum normal load ^{1.}	
264	50	0.375	--	51.4	--	F901	0.375	Maximum normal load ^{1.}	

IEC 62368-1								
Clause	Requirement + Test					Result - Remark	Verdict	
264	60	0.368	--	51.4	--	F901	0.368	Maximum normal load ^{1.}
VGA mode								
90	50	0.873	--	48.8	--	F901	0.873	Maximum normal load ^{1.}
90	60	0.853	--	48.6	--	F901	0.853	Maximum normal load ^{1.}
100	50	0.794	1.5	48.3	--	F901	0.794	Maximum normal load ^{1.}
100	60	0.778	1.5	48.2	--	F901	0.778	Maximum normal load ^{1.}
240	50	0.392	1.5	47.4	--	F901	0.392	Maximum normal load ^{1.}
240	60	0.387	1.5	47.3	--	F901	0.387	Maximum normal load ^{1.}
264	50	0.368	--	47.6	--	F901	0.368	Maximum normal load ^{1.}
264	60	0.363	--	47.2	--	F901	0.363	Maximum normal load ^{1.}
Tested on 27 inch model with power board 715G9611, main board 715G9584 and USB board 715GA629								
HDMI mode								
90	50	1.036	--	58.2	--	F901	1.036	Maximum normal load ^{1.}
90	60	1.006	--	58.3	--	F901	1.006	Maximum normal load ^{1.}
100	50	0.936	1.5	57.5	--	F901	0.936	Maximum normal load ^{1.}
100	60	0.914	1.5	57.2	--	F901	0.914	Maximum normal load ^{1.}
240	50	0.452	1.5	55.5	--	F901	0.452	Maximum normal load ^{1.}
240	60	0.448	1.5	56.0	--	F901	0.448	Maximum normal load ^{1.}
264	50	0.422	--	55.5	--	F901	0.422	Maximum normal load ^{1.}
264	60	0.416	--	55.5	--	F901	0.416	Maximum normal load ^{1.}
DisplayPort mode								
90	50	1.040	--	57.9	--	F901	1.040	Maximum normal load ^{1.}
90	60	1.007	--	58.0	--	F901	1.007	Maximum normal load ^{1.}
100	50	0.931	1.5	57.2	--	F901	0.931	Maximum normal load ^{1.}
100	60	0.949	1.5	57.1	--	F901	0.949	Maximum normal load ^{1.}
240	50	0.449	1.5	55.9	--	F901	0.449	Maximum normal load ^{1.}
240	60	0.446	1.5	55.9	--	F901	0.446	Maximum normal load ^{1.}
264	50	0.418	--	56.0	--	F901	0.418	Maximum normal load ^{1.}
264	60	0.415	--	56.1	--	F901	0.415	Maximum normal load ^{1.}
VGA mode								
90	50	1.000	--	56.0	--	F901	1.000	Maximum normal load ^{1.}
90	60	0.974	--	55.8	--	F901	0.974	Maximum normal load ^{1.}
100	50	0.901	1.5	55.3	--	F901	0.901	Maximum normal load ^{1.}

IEC 62368-1								
Clause	Requirement + Test					Result - Remark	Verdict	
100	60	0.875	1.5	55.1	--	F901	0.875	Maximum normal load ^{1.}
240	50	0.436	1.5	53.5	--	F901	0.436	Maximum normal load ^{1.}
240	60	0.432	1.5	53.4	--	F901	0.432	Maximum normal load ^{1.}
264	50	0.407	--	53.5	--	F901	0.407	Maximum normal load ^{1.}
264	60	0.403	--	54.0	--	F901	0.403	Maximum normal load ^{1.}
Tested on 23.8 inch model with power board 715GB018, main board 715G9584 and USB board 715GA629								
HDMI mode								
90	50	0.958	--	50.1	--	F9901	0.958	Maximum normal load ²⁾
90	60	0.901	--	49.9	--	F9901	0.901	Maximum normal load ²⁾
100	50	0.843	1.5	49.7	--	F9901	0.843	Maximum normal load ²⁾
100	60	0.804	1.5	49.6	--	F9901	0.804	Maximum normal load ²⁾
240	50	0.394	1.5	48.4	--	F9901	0.394	Maximum normal load ²⁾
240	60	0.387	1.5	48.4	--	F9901	0.387	Maximum normal load ²⁾
264	50	0.367	--	48.5	--	F9901	0.367	Maximum normal load ²⁾
264	60	0.361	--	48.5	--	F9901	0.361	Maximum normal load ²⁾
DisplayPort mode								
90	50	0.957	--	50.0	--	F9901	0.957	Maximum normal load ²⁾
90	60	0.900	--	49.8	--	F9901	0.900	Maximum normal load ²⁾
100	50	0.842	1.5	49.6	--	F9901	0.842	Maximum normal load ²⁾
100	60	0.802	1.5	49.6	--	F9901	0.802	Maximum normal load ²⁾
240	50	0.392	1.5	48.3	--	F9901	0.392	Maximum normal load ²⁾
240	60	0.385	1.5	48.3	--	F9901	0.385	Maximum normal load ²⁾
264	50	0.365	--	48.4	--	F9901	0.365	Maximum normal load ²⁾
264	60	0.358	--	48.4	--	F9901	0.358	Maximum normal load ²⁾
Tested on 27 inch model with power board 715GC031, main board 715GC003								
HDMI mode								
90	50	0.740	--	40.2	--	F901	0.740	Maximum normal load ²⁾
90	60	0.715	--	40.1	--	F901	0.715	Maximum normal load ²⁾
100	50	0.669	1.5	40.0	--	F901	0.669	Maximum normal load ²⁾
100	60	0.648	1.5	39.9	--	F901	0.648	Maximum normal load ²⁾
240	50	0.325	1.5	39.2	--	F901	0.325	Maximum normal load ²⁾
240	60	0.319	1.5	39.1	--	F901	0.319	Maximum normal load ²⁾
264	50	0.303	--	39.3	--	F901	0.303	Maximum normal load ²⁾

IEC 62368-1								
Clause	Requirement + Test					Result - Remark	Verdict	

264	60	0.299	--	39.2	--	F901	0.299	Maximum normal load ²⁾
DisplayPort mode								
90	50	0.738	--	40.1	--	F901	0.738	Maximum normal load ²⁾
90	60	0.713	--	40.0	--	F901	0.713	Maximum normal load ²⁾
100	50	0.667	1.5	39.9	--	F901	0.667	Maximum normal load ²⁾
100	60	0.645	1.5	39.8	--	F901	0.645	Maximum normal load ²⁾
240	50	0.323	1.5	39.1	--	F901	0.323	Maximum normal load ²⁾
240	60	0.317	1.5	39.0	--	F901	0.317	Maximum normal load ²⁾
264	50	0.301	--	39.2	--	F901	0.301	Maximum normal load ²⁾
264	60	0.296	--	39.1	--	F901	0.296	Maximum normal load ²⁾

Supplementary information:

1. Maximum normal load: maximum brightness, maximum contrast, full white screen; speakers (two sets) were loaded with 1KHz sinusoidal signal and turned to maximum volume; each USB 3.0 port loaded with 5V/0.9A; USB fast charge port loaded with 5V/1.5A;
2. Maximum normal load: maximum brightness, maximum contrast, full white screen; speakers (two sets) were loaded with 1KHz sinusoidal signal and turned to maximum volume
3. Tests have performed with all main board and USB board, and the worst test result was recorded in this table. If not specified particularly, HDMI mode was used for all other tests.

B.3, B.4 TABLE: Abnormal operating and fault condition tests							P
Ambient temperature T _{amb} (°C)..... :						See below	—
Power source for EUT: Manufacturer, model/type, outputrating .. :						See table 4.1.2	—
Component No.	Condition	Supply voltage (V)	Test time	Fuse no.	Fuse current (A)	Observation	
Tested on power board 715G9611							
Ventilation openings for 23.8 inch model	blocked	264	3hrs	F901	0.37	Unit operated normally, no hazards, no damage. Max. measured temperature: T901 coil = 53.9°C; T901 core = 54.7°C; AC inlet = 38.6°C; Metal enclosure = 38.4°C; Plastic enclosure outside near T901 = 27.9°C; Panel = 39.2°C; Button = 26.4°C; Ambient = 22.2°C	

IEC 62368-1						
Clause	Requirement + Test			Result - Remark	Verdict	
Ventilation openings (for 27.0 inch models)	blocked	264	3hrs	F901	0.42	Unit operated normally, no hazards, no damage. Max. measured temperature: T901 coil = 54.9°C; T901 core = 56.5°C; AC inlet = 37.8°C; Metal enclosure = 38.9°C; Plastic enclosure outside near T901= 32.3°C; Panel = 40.7°C; Button = 24.2°C; Ambient = 22.2°C
T901 pin 7,8-pin 11 after D904 (+19V)	o-l	264	3hrs	F901	0.67	Before shutdown winding is loaded to 2.78A, No damage, no hazards. Max. measured temperature: T901 coil = 87.9°C; T901 core = 86.8°C; AC inlet = 38.5°C; Metal enclosure = 40.3°C; Plastic enclosure outside near T901= 31.1°C; Panel = 37.9°C; Button = 25.6°C; Ambient = 22.2°C
BD901 pin 1-3	s-c	264	<1 sec	F901	--	Fuse F901 open instantly, no hazard.
C902	s-c	264	5 min	F901	0.02	Unit shutdown, no damage, no hazard.
U901 pin 3-8 ⁴⁾	s-c	264	5 min	F901	0.04	Unit shutdown, U901 damaged, no hazards.
U901 pin 2-8 ⁴⁾	s-c	264	5 min	F901	0.04	Unit shutdown, U901 damaged, no hazards.
U901 pin 6-8 ⁴⁾	s-c	264	5 min	F901	0.04	Unit shutdown, U901 damaged, no hazards.
T901 pin 1 to pin 3	s-c	264	5 min	F901	0.02	Unit shutdown, no damage, no hazard.
T901 pin 4 to pin 5	s-c	264	5 min	F901	0.02	Unit shutdown, no damage, no hazard.
T901 pin 6 to pin 10	s-c	264	5 min	F901	0.02	Unit shutdown, no damage, no hazard.
+19V output to earth	s-c	264	5 min	F901	0.02	Unit shutdown, no damage, no hazard.
U902 pin 1 - 2	s-c	264	5 min	F901	0.02	Unit shutdown, no damage, no hazard.
U902 pin 3 - 4	s-c	264	5 min	F901	0.02	Unit shutdown, no damage, no hazard.

IEC 62368-1						
Clause	Requirement + Test				Result - Remark	Verdict
U902 pin 1	o-c	264	5 min	F901	0.02	Unit shutdown, no damage, no hazard.
U903 Pin 1	o-c	240	5 min	F901	0.02	Unit shutdown, no damage, no hazard.
U903 Pin 3	o-c	240	5 min	F901	0.02	Unit shutdown, no damage, no hazard.
Q901 pin G-S	s-c	264	5 min	F901	0.02	Unit shutdown, no damage, no hazard.
Q901 pin D-G ⁴⁾	s-c	264	5 min	F901	0.04	Unit shutdown, Q901 damaged, no hazards.
Q901 pin D-S ⁴⁾	s-c	264	5 min	F901	0.04	Unit shutdown, Q901 damaged, no hazards.
D901 ⁴⁾	s-c	264	5 min	F901	0.02	Unit shutdown, D901 damaged, no hazards.
R927	s-c	264	5 min	F901	0.02	Unit shutdown, no damage, no hazard.
R915	s-c	264	5 min	F901	0.02	Unit shutdown, no damage, no hazard.
R923	s-c	264	5 min	F901	0.02	Unit shutdown, no damage, no hazard.
L801	s-c	264	5 min	F901	0.02	Unit shutdown, no damage, no hazard.
Tested with power board 715GB018						
Ventilation openings	blocked	264	2h	F9901	0.37	Unit operated normally, no hazards, no damage. After temperature reached stable, max. measured temp. in T9101 coil = 73.2°C, T9101 core = 73.5°C, AC inlet = 39.6°C, Metal enclosure = 43.6°C, Plastic enclosure outside=32.3°C, Panel = 37.4°C, Button=32.4°C, Ambient = 20.2°

IEC 62368-1						
Clause	Requirement + Test			Result - Remark		Verdict
USB Fast charge	o-l	264	2h	F9901	0.481	Before shutdown USB port is loaded to 2.3A. No damage, no hazards. Max. measured temp. in T9101 coil = 72.2°C, T9101 core = 72.5°C, AC inlet = 35.7°C, Metal enclosure = 39.7°C, Plastic enclosure outside = 28.0°C, Panel = 31.2°C, Button = 28.8°C, Ambient = 20.1°C
+19V	o-l	264	2h	F9901	0.717	Before shutdown winding is loaded to 2.0A additional. No damage, no hazards. Max. measured temp. in T9101 coil = 92.0°C, T9101 core = 92.1°C, AC inlet = 40.2°C, Metal enclosure = 46.4°C, Plastic enclosure outside = 23.4°C, Panel = 34.2°C, Button = 30.3°C, Ambient = 23.2°C
BD9901 pin1-4	s-c	264	<1 sec	F9901	--	Fuse open immediately, no hazards.
BD9902 pin1-4	s-c	264	<1 sec	F9901	--	Fuse open immediately, no hazards.
C9814	s-c	264	<1 sec	F9901	--	Fuse open immediately, no hazards.
Q9101 pin G-S	s-c	264	5 min	F9901	0.09	EUT shut down, no damage, no hazards.
Q9101 pin G-D	s-c	264	<1 sec	F9901	--	Fuse F9901 opened instantly, Q9101, R9111 damaged, no hazard.
Q9101 pin D-S	s-c	264	<1 sec	F9901	--	Fuse F9901 opened instantly, Q9101, R9111 damaged, no hazard.
Q9801 pin G-S	s-c	264	5 min	F9901	0.37	Unit working as normally No damage No hazards
Q9801 pin G-D	s-c	264	<1 sec	F9901	--	Fuse F9901 opened instantly, Q9801, R9808 damaged, no hazard.
Q9801 pin D-S	s-c	264	<1 sec	F9901	--	Fuse F9901 opened instantly, Q9801, R9808 damaged, no hazard.

IEC 62368-1						
Clause	Requirement + Test			Result - Remark		Verdict
T9102 pin 1 to pin 3	s-c	264	5 min	F9901	0.09	EUT shut down, no damage, no hazards.
T9102 pin 5 to pin 6	s-c	264	5 min	F9901	0.09	EUT shut down, no damage, no hazards.
T9102 pin 7,8 to pin 11,12	s-c	264	5 min	F9901	0.09	EUT shut down, no damage, no hazards.
U9401 pin1-2	s-c	264	5 min	F9901	0.09	EUT shut down, no damage, no hazards.
U9401 pin3-4	s-c	264	5 min	F9901	0.06	EUT shut down, no damage, no hazards.
U9401 pin 1	o-c	264	5 min	F9901	0.06	EUT shut down, no damage, no hazards.
U9102 pin1-2	s-c	264	5 min	F9901	0.06	EUT shut down, no damage, no hazards.
U9102 pin3-4	s-c	264	5 min	F9901	0.06	EUT shut down, no damage, no hazards.
U9102 pin 1	o-c	264	5 min	F9901	0.06	EUT shut down, no damage, no hazards.
U9801 Pin 3-8	s-c	264	5 min	F9901	0.37	Unit working as normally No damage No hazards
U9801 Pin 2-8	s-c	264	5 min	F9901	0.37	Unit working as normally No damage No hazards
D9105	s-c	264	5 min	F9901	0.09	EUT shut down, no damage, no hazards.
D9106	s-c	264	5 min	F9901	0.09	EUT shut down, no damage, no hazards.
CN801 Pin 3,4-GND	s-c	264	5 min	F9901	0.06	EUT shut down, no damage, no hazards.
+19V output to earth	s-c	264	5 min	F9901	0.07	EUT shut down, no damage, no hazards.
Tested with power board 715GC031						
Ventilation openings	blocked	264	1.5h	F901	0.303	Unit operated normally, no hazards, no damage. After temperature reached stable, max. measured temp. in T901 coil = 80.3°C, T901 core = 80.4°C, AC inlet = 37.2°C, Metal enclosure = 44.5°C, Plastic enclosure outside near T901 = 30.5°C, Panel = 37.7°C, Button = 29.7°C, Ambient = 20.1°C

IEC 62368-1						
Clause	Requirement + Test			Result - Remark		Verdict
+19V	o-l	264	4h	F901	0.617	Before shutdown winding is loaded to 1.4A additional. No damage, no hazards. Max. measured temp. in T901 coil = 105.9°C, T901 core = 104.3°C, AC inlet = 38.4°C, Metal enclosure = 42.7°C, Plastic enclosure outside near T901 = 26.2°C, Panel = 32.7°C, Button = 23.5°C, Ambient = 20.8°C
BD901 pin1-3	s-c	264	<1 sec	F901	-	Fuse F901 open instantly, no hazard.
C902	s-c	264	<1 sec	F901	0.02	Unit shutdown, no damaged, no hazard.
U901 pin 3-8 ⁴⁾	s-c	264	< 1 sec	F901	0.04	U901 damaged, no hazards.
U901 pin 2-8 ⁴⁾	s-c	264	< 1 sec	F901	0.04	U901 damaged, no hazards.
U901 pin 6-8 ⁴⁾	s-c	264	< 1 sec	F901	0.04	U901 damaged, no hazards.
T901 pin 1 to pin 3	s-c	264	5 min	F901	0.02	Unit shutdown, no damaged, no hazard.
T901 pin 4 to pin 5	s-c	264	5 min	F901	0.02	Unit shutdown, no damaged, no hazard.
T901 pin 6 to pin 10	s-c	264	5 min	F901	0.02	Unit shutdown, no damaged, no hazard.
+19V output to earth	s-c	264	5 min	F901	0.02	Unit shutdown, no damaged, no hazard.
U902 pin 1 - 2	s-c	264	5 min	F901	0.02	Unit shutdown, no damaged, no hazard.
U902 pin 3 - 4	s-c	264	5 min	F901	0.02	Unit shutdown, no damaged, no hazard.
U902 pin 1	o-c	264	5 min	F901	0.02	Unit shutdown, no damaged, no hazard.
U903 Pin 1	o-c	240	10 min	F901	0.02	Unit shutdown, no damaged, no hazard.
U903 Pin 3	o-c	240	10 min	F901	0.02	Unit shutdown, no damaged, no hazard.
Q901 pin G-S	s-c	264	5 min	F901	0.02	Unit shutdown, no damaged, no hazard.
Q901 pin D-G	s-c	264	5 min	F901	0.04	Q901 damaged, no hazards.
Q901 pin D-S	s-c	264	5 min	F901	0.04	Q901 damaged, no hazards.
D901	s-c	264	5 min	F901	0.02	D901 damaged, no hazards.

IEC 62368-1			
Clause	Requirement + Test	Result - Remark	Verdict

R927	s-c	264	5 min	F901	0.02	Unit shutdown, no damaged, no hazard.
R915	s-c	264	5 min	F901	0.02	Unit shutdown, no damaged, no hazard.
R923	s-c	264	5 min	F901	0.02	Unit shutdown, no damaged, no hazard.
L801	s-c	264	5 min	F901	0.02	Unit shutdown, no damaged, no hazard.

Supplementary information:

- The unit passed 4000V hi-pot test between primary and accessible output connector after single fault test above.
- In fault column, where s-c=short-circuited, o-c=open-circuited, o-l = overload.
- For fuse opened conditions were tested with each source of fuse.
- For component damaged conditions have been repeated twice (three tests total) with same result.
- Temp. limit of transformer according to table G.3 is $175^{\circ}\text{C} - 10 - (40^{\circ}\text{C} - T_{amb})$ (worst case) for Class B.

M.3	TABLE: Protection circuits for batteries provided within the equipment						N/A
Is it possible to install the battery in a reverse polarity position?							—
Equipment Specification	Charging						
	Voltage (V)			Current (A)			
Manufacturer/type	Battery specification						
	Non-rechargeable batteries			Rechargeable batteries			
	Discharging current (A)	Unintentional charging current (A)	Charging		Discharging current (A)	Reverse charging current (A)	
			Voltage (V)	Current (A)			
Note: The tests of M.3.2 are applicable only when above appropriate data is not available.							
Specified battery temperature ($^{\circ}\text{C}$).....:							
Component No.	Fault condition	Charge/discharge mode	Test time	Temp. ($^{\circ}\text{C}$)	Current (A)	Voltage (V)	Observation
Supplementary information:							
Abbreviation: SC= short circuit; OC= open circuit NL= no chemical leakage; NS= no spillage of liquid; NE= no explosion; NF= no emission of flame or expulsion of molten metal.							

IEC 62368-1			
Clause	Requirement + Test	Result - Remark	Verdict

M.4.2	TABLE: Charging safeguards for equipment containing a secondary lithium battery			N/A	
Maximum specified charging voltage (V)	:			—	
Maximum specified charging current (A)	:			—	
Highest specified charging temperature (°C)	:				
Lowest specified charging temperature (°C)	:				
Battery manufacturer/type	Operating and fault condition	Measurement			Observation
		Charging voltage (V)	Charging current (A)	Temp. (°C)	
Supplementary information:					
Abbreviation: SC= short circuit; OC= open circuit; MSCV= maximum specified charging voltage; MSCC= maximum specified charging current; HSCT= highest specified charging temperature; LSCT= lowest specified charging temperature					

Q.1	TABLE: Circuits intended for interconnection with building wiring (LPS)						P
Output Circuit	Condition	U _{oc} (V)	Time (s)	I _{sc} (A)		S (VA)	
				Meas.	Limit	Meas.	Limit
Circuit output tested: Test on +19V output on power board 715G9611 ²⁾.							
See above	Normal condition	19.4	4.14	1000/U _{oc} =51.5	77.7	250	250
Circuit output tested: Test on +19V output on power board 715GB018 ²⁾.							
See above	Normal condition	19.1	5.0	1000/U _{oc} =52.4	90.6	250	250
Circuit output tested: Test on +19V output on power board 715GC031 ²⁾.							
See above	Normal condition	19.1	3.2	1000/U _{oc} =52.4	59.2	250	250
Supplementary Information:							
1) Input Voltage is 264Vac, 60Hz. SC=short circuit, OC=open circuit.							
2) +19V output of power boards protected by fuses that will break the circuit within 120s with a current equal to 210%. Current limit of table Q.2 reduced to breaking capacity of the fuse (40A).							

IEC 62368-1			
Clause	Requirement + Test	Result - Remark	Verdict

T.2, T.3, T.4, T.5	TABLE: Steady force test					P
Location/Part	Material	Thickness (mm)	Probe	Force (N)	Test Duration (s)	Observation
Internal components	--	--	Figure V.1	10	5	The clearance and creepage distances do not be reduced below the required values.
External plastic enclosure	See table 4.1.2	See table 4.1.2	Figure V.1	250	5	All safeguards remained effective.
Internal metal enclosure	See table 4.1.2	See table 4.1.2	Figure V.1	30	5	All safeguards remained effective.
Supplementary information:						

T.6, T.9	TABLE: Impact test				P
Location/Part	Material	Thickness (mm)	Height (mm)	Observation	
External plastic enclosure	See table 4.1.2	See table 4.1.2	1300	All safeguards remained effective.	
Supplementary information:					

T.7	TABLE: Drop test				N/A
Location/Part	Material	Thickness (mm)	Height (mm)	Observation	
Supplementary information:					

T.8	TABLE: Stress relief test				P
Location/Part	Material	Thickness (mm)	Oven Temperature (°C)	Duration (h)	Observation
Whole unit	See table 4.1.2	See table 4.1.2	70	7	All safeguards remained effective.

IEC 62368-1			
Clause	Requirement + Test	Result - Remark	Verdict

Supplementary information:

X	TABLE: Alternative method for determining minimum clearances distances			N/A
Clearance distanced between:	Peak of working voltage (V)	Required cl (mm)	Measured cl (mm)	
Supplementary information:				

IEC 62368-1			
Clause	Requirement + Test	Result - Remark	Verdict

4.1.2	TABLE: List of critical components					P
Object / part No.	Manufacturer/ trademark	Type / model	Technical data	Standard	Mark(s) of conformity ¹	
LCD Panel with LED backlight (for 23.6 inch model)	TPV	TPM236*** (*can be 0-9, A- Z or blank for marketing purpose).	23.6 inch TFT curved panel (power consumption: 27.1W; LED array voltage: 60V)	--	Tested in equipment	
Alt.)	TPV	TPM236*** (*can be 0-9, A- Z or blank for marketing purpose).	23.6 inch TFT flat panel (power consumption: 27.1W; LED array voltage: 60V)	--	Tested in equipment	
LCD Panel with LED backlight (for 23.8 inch models)	TPV	TPM238*** (*can be 0-9, A- Z or blank for marketing purpose).	23.8 inch TFT curved panel (power consumption: 16.5W; LED array voltage: 54V)	--	Tested in equipment	
Alt.)	TPV	TPM238*** (*can be 0-9, A- Z or blank for marketing purpose).	23.8 inch TFT flat panel (power consumption: 16.5W; LED array voltage: 54V)	--	Tested in equipment	
LCD Panel with LED backlight (for 27.0 inch model)	TPV	TPM270*** (*can be 0-9, A- Z or blank for marketing purpose).	27.0 inch TFT curved panel (power consumption: 29.49W; LED array voltage: 44.8V)	--	Tested in equipment	
Alt.)	TPV	TPM270*** (*can be 0-9, A- Z or blank for marketing purpose).	27.0 inch TFT flat panel (power consumption: 29.49W; LED array voltage: 44.8V)	--	Tested in equipment	

IEC 62368-1					
Clause	Requirement + Test	Result - Remark		Verdict	
Plastic Enclosure	LOTTE ADVANCED MATERIALS CO LTD (SAMSUNG SDI)	SD-0150(+), VH-0810(+), VE-0812(+), NH- 1000T(+)(&), GC-0700(+++) (RR28), GC-0700A(RR), GC- 0750(+) (RR70), GC- 1017(+) (RR30), VE-1890(+), BF-0675(+), BF-0670(+), NH-1017(p), NH-1017T, NH-1017SG(+), BF-0677(+), HS-7000(+), HG-0760(+), NE-1030(+), HR-1360(+), LX-0951(+), LX-0957(+), TH-1100(+), TN-1100(+), LS-1159(r), LS-1159SF, LS-1159F, NH-1036	HB or better, min. 1.6mm thickness	UL 94	UL (E115797)
Alt.)	GRAND PACIFIC PETROCHEMIC AL CORP	D-150, D-1000, D-1000A	HB or better, min. 1.6mm thickness	UL 94	UL (E88637)
Alt.)	CHI MEI CORPORATION	PA-757(+), PH-88, PA-756S	HB or better, min. 1.6mm thickness	UL 94	UL (E56070)
Alt.)	ALBIS PLASTIC GMBH	GP-35, GP-22, 495F	HB or better, min. 1.6mm thickness	UL 94	UL (E80168)
Alt.)	COVESTRO DEUTSCHLAND AG [PC RESINS]	FR3000 series, FR3005 series	HB or better, min. 1.6mm thickness	UL 94	UL (E41613)

IEC 62368-1					
Clause	Requirement + Test		Result - Remark		Verdict
Alt.)	LG CHEM LTD	HF350(#), HF380(m), HF380NS, HF380(#), HF-380(#), HF-380(m), HF-380, HF-380NS, HF380X, AF312T1, AF342T1, LUPOY GN- 5001TF(#), GN-5001RFD, LUPOY GN- 5008HF(#), LUPOY GP- 5008BF(#), SE750(#), XG568(#), XG569(#), GP-1000L, GP-1000F(#), GP-1000(m)(#), LUMILOY GP- 1000(#), SE750(#), LUPOY GN- 5001RF(T), SE885(#), HF388(#)	HB or better, min. 1.6mm thickness	UL 94	UL (E171666)
Alt.)	CHI LIN	GA-1535	HB or better, min. 1.6mm thickness	UL 94	UL (E177071)
Alt.)	PONTEX	AFE5000N, AFE5100N, 9004BK	HB or better, min. 1.6mm thickness	UL 94	UL (E205938)

IEC 62368-1					
Clause	Requirement + Test		Result - Remark		Verdict
Alt.)	KINGFA SCI & TECH CO LTD	4418, 5197, FRABS-518, HIPS-5197, HF-606, HF-626, FRABS-518, GAR-011C, JH960 6(M), FRHIPS-960, RS-900, RS-300, RS-400, GAR-011, GAR-011(L65), GAR-011(L85), GAR-011(HG6), CK-100, CK-900, CK-55111, JH960 6(M), FRHIPS-960, HIPS-4418, HIPS-3399, HIPS-CM(ee), HIPS-HG(ee), HIPS-510 (o), HIPS-550, CK-61(M) (##), RS-(hh)0, HP-126, ABS-660, ABS-122, GAR-322, GAR-332, GAR-220, H12, G360, CK-55(M) (##), CK-58(M) (##), GAR-011C, GAR-011(ww)	HB or better, min. 1.6mm thickness	UL 94	UL (E230779)
Alt.)	QINGDAO HAIER NEW MATERIAL R & D CO LTD	HRABS-RS, HRABS-HG, CR-3002	HB or better, min. 1.6mm thickness	UL 94	UL (E328304)
Alt.)	DONGGUAN HINGLONG PLASTIC TECHNOLOGY CO LTD	HL-ABS-PCR85, HL-ABS-PCR65, HL-ABS-PCR35	HB or better, min. 1.6mm thickness	UL 94	UL (E471190)

IEC 62368-1					
Clause	Requirement + Test	Result - Remark			Verdict
Alt.)	ORINKO (HEFEI) ADVANCED PLASTIC CO LTD	ABS-3070H, HIPS-2000	HB or better, min. 1.6mm thickness	UL 94	UL (E471190)
Alt.)	WISTRON ADVANCED MATERIALS (KUNSHAN) CO LTD	GA(M)(b)(c), GA35(a), NC30)	HB or better, min. 1.6mm thickness	UL 94	UL (E310240) (E359575)
Alt.)	UNIC TECHNOLOGY CORP	UR- 3006+(RXX), UR-200+	HB or better, min. 1.6mm thickness	UL 94	UL (E135175)
Alt.)	GUO HENG (DONGGUAN)	YOUHO(####)(Y)	HB or better, min. 1.6mm thickness	UL 94	UL (E471190)
Alt.)	HUIZHOU WOTE	2100	HB or better, min. 1.6mm thickness	UL 94	UL (E135175)
Alt.)	TEIJIN LIMITED RESIN AND PLASTIC	TN-7500(c), TN-7500F(#), MN-3600V(#), MN-3600H(#)	HB or better, min. 1.6mm thickness	UL 94	UL (E98529)
Alt.)	INEOS STYROLUTION GROUP GMBH	495F GR2, 495F KG2, 495F GR21, 495F KG21, PC2065	HB or better, min. 1.6mm thickness	UL 94	UL (E108538)
Alt.)	STYRON	STYRON A- TECH 1200	HB or better, min. 1.6mm thickness	UL 94	UL (E162447)
Alt.)	TOTAL PETROCHEMIC ALS SOUTH EAST ASIA PTE LTD	3441; 260-XX	HB or better, min. 1.6mm thickness	UL 94	UL (E314268)
Alt.)	DOOSAN CORPORATION ELECTRO- MATERIALS BG	DS-1107A; DS-1202G; DS-7106	HB or better, min. 1.6mm thickness	UL 94	UL (E103670)
Alt.)	SABIC JAPAN L L C	C6600(GG)(X)(VS) C6600E (VS)(X)	HB or better, min. 1.6mm thickness	UL 94	UL (E207780)
Alt.)	QING DAO GON TECHNOLOGY CO.,LTD.	ABS21(xx)G-A ABS2030A ABS20(xx)B	HB or better, min. 1.6mm thickness	UL 94	UL (E330547)

IEC 62368-1					
Clause	Requirement + Test			Result - Remark	Verdict
	Mylar sheet (between power board and panel plate; on metal enclosure inside; on metal enclosure for covering opening)	SUZHOU OMA Y OPTICAL MATERIALS CO LTD	SE42B, SE42B-F	min. 0.4mm thickness, min. V-0, 105°C	UL 94 UL E249605
Alt.)		SICHUAN LONGHUA FILM CO LTD	PC-770F, PC-770F-A, PC-770	min. 0.4mm thickness, min. V-0, 105°C	UL 94 UL E254551
Alt.)		SICHUAN DONGFANG INSULATING MATERIAL CO LTD	DFR700, DFR700F, DFR700-83, DFR700-83A, DFR700-83B	min. 0.4mm thickness, min. V-0, 105°C	UL 94 UL E199019
Alt.)		CHENGDU KANGLONGXIN PLASTICS CO LTD	KLX FRPC-1860B, KLX FRPC-1870B	min. 0.4mm thickness, min. V-0, 105°C	UL 94 UL E315185
Alt.)		CHENGDU KANGLONGXIN PLASTICS CO LTD	KLX FRPC-870B	min. 0.4mm thickness, min. V-0, 105°C	UL 94 UL E315185
Alt.)		CHENGDU KANGLONGXIN PLASTICS CO LTD	DFPET 6023	min. 0.4mm thickness, min. V-0, 105°C	UL 94 UL E199019
Alt.)		SICHUAN DONGFANG INSULATING MATERIAL CO LTD	DFR117ECOC, DFR117ECOB	min. 0.4mm thickness, min. V-0, 105°C	UL 94 UL E199019
Alt.)		SICHUAN DONGFANG INSULATING MATERIAL CO LTD	DFR117ECO	min. 0.4mm thickness, min. V-0, 105°C	UL 94 UL E199019
Alt.)		JINGMEN GORUN TECHNOLOGY CO LTD	HF70	min. 0.4mm thickness, min. V-0, 105°C	UL 94 UL E305163

IEC 62368-1					
Clause	Requirement + Test		Result - Remark		Verdict
Alt.)	SICHUAN DONGFANG INSULATING MATERIAL CO LTD	DFR3A(d)	min. 0.4mm thickness, min. V-0, 105°C	UL 94	UL E199019
Alt.)	CHENGDU KANGLONGXIN PLASTICS CO LTD	KLX PP BK-10	min. 0.4mm thickness, min. V-0, 105°C	UL 94	UL E315185
Alt.)	KUNSHAN DOBESTY OPTOELECTRONIC MATERIALS CO LTD	PC9842B, PC9821B, PC9832B	min. 0.4mm thickness, min. V-0, 105°C	UL 94	UL E339070
Alt.)	SHENZHEN TEESUN TECHNOLOGY CO LTD	FR370, FR370F, FE383	min. 0.4mm thickness, min. V-0, 105°C	UL 94	UL E329660
Adhesive for Mylar sheet	SYMBIO	DS50-A, DS50L	100°C, 0.05mm Thickness	--	Tested in equipment
Alt.)	3M	55236	100°C, 0.05mm Thickness	--	Tested in equipment
Alt.)	TESA SE	68646	100°C, 0.05mm Thickness	--	Tested in equipment
Alt.)	NITTO DENKO CORP	GA606	100°C, 0.05mm Thickness	--	Tested in equipment
Alt.)	XIAMEN LABAO OPTICS & ELECTRONIC CO LTD	TD-10	100°C, 0.05mm Thickness	--	Tested in equipment
Switching mode power supply board: 715G9611 by TPV					
AC-Inlet (CN901)	Solteam	ST-01, SC04	10A, 250Vac	IEC/ EN 60320-1 UL60320-1	VDE 40015691, UL E200241
Alt.)	Zhang Jia Gang-Hua Jie	SA-4S series, SA-4S-1, SA-4D, SA-4S 9, SA-4S 6	10A, 250Vac	IEC/ EN 60320-1 UL60320-1	VDE 40003610, UL E154342
Alt.)	Rong Feng	SS-120, SS-7B	10A, 250Vac	IEC/ EN 60320-1 UL60320-1	VDE 40028101, UL E102641
Alt.)	Inalways	0707-1, 0711-2, 0714	10A, 250Vac	IEC/ EN 60320-1 UL60320-1	Nemko (P03100418), UL (E94191)

IEC 62368-1					
Clause	Requirement + Test			Result - Remark	Verdict
Alt.)	DELIKANG	CDJ-3, CDJ-3-1, CDJ-7, CDJ-7 series	10A, 250Vac	IEC/ EN 60320-1 UL60320-1	VDE 40010513, UL E217394
Alt.)	TECX	TU-301 series	10A, 250Vac	IEC/ EN 60320-1 UL60320-1	VDE (40025582), UL (E220004)
Alt.)	Yueqing Hongchang	DB-14, DB-14-14-R, DB-14 Series, DB-14-05 DB-14-15	10A, 250Vac	IEC/ EN 60320-1 UL60320-1	VDE 40028645, UL E327347
Fuse (F901)	Littelfuse, Inc. Wickmann	382-series, 392	T4AL, 250Vac	IEC/ EN 60127- 1 IEC/ EN 60127- 3 UL 248-1	VDE (40018249, 126983), UL (E67006)
Alt.)	Littelfuse Phils. Inc.	TE5 400 series	T4AL, 250Vac	IEC/ EN 60127- 1 IEC/ EN 60127- 3 UL 248-1	VDE (40018249, 126983), UL (E67006)
Alt.)	Conquer	MET series MST series PTU	T4AL, 250Vac	IEC/ EN 60127- 1 IEC/ EN 60127- 3 UL 248-1	VDE (40017155, 40017118, 40001462), UL (E82636)
Alt.)	Cooper Bussmann	SR-5, SS-5	T4AL, 250Vac	IEC/ EN 60127- 1 IEC/ EN 60127- 3 UL 248-1	VDE (40020046, 40015513), UL (E19180)
Alt.)	Ever Island Electric Co., Ltd. & Walter Electric	2000, 2010 series	T4AL, 250Vac	IEC/ EN 60127- 1 IEC/ EN 60127- 3 UL 248-1	VDE (40018790, 40018781), UL (E220181)
Alt.)	Better	932	T4AL, 250Vac	IEC/ EN 60127- 1 IEC/ EN 60127- 3 UL 248-1	VDE (40033369), UL (E300003)
Fuse (F902 for L.P.S.)	Littelfuse, Inc. Wickmann	382-series, 392	T4AL, 250Vac	IEC/ EN 60127- 1 IEC/ EN 60127- 3 UL 248-1	VDE (40018249, 126983), UL (E67006)

IEC 62368-1					
Clause	Requirement + Test		Result - Remark		Verdict
Alt.)	Littelfuse Phils. Inc.	TE5 400 series	T4AL, 250Vac	IEC/ EN 60127-1 IEC/ EN 60127-3 UL 248-1	VDE (40018249, 126983), UL (E67006)
Alt.)	Conquer	MET series MST series PTU	T4AL, 250Vac	IEC/ EN 60127-1 IEC/ EN 60127-3 UL 248-1	VDE (40017155, 40017118, 40001462), UL (E82636)
Alt.)	Cooper Bussmann	SR-5, SS-5	T4AL, 250Vac	IEC/ EN 60127-1 IEC/ EN 60127-3 UL 248-1	VDE (40020046, 40015513), UL (E19180)
Alt.)	Ever Island Electric Co., Ltd. & Walter Electric	2000, 2010 series	T4AL, 250Vac	IEC/ EN 60127-1 IEC/ EN 60127-3 UL 248-1	VDE (40018790, 40018781), UL (E220181)
Alt.)	Better	932	T4AL, 250Vac	IEC/ EN 60127-1 IEC/ EN 60127-3 UL 248-1	VDE (40033369), UL (E300003)
Y- Capacitor (C920, C921) Y1 or Y2 type (optional)	Walsin	AC, AH	Max. 1000pF, 250Vac, 125°C	IEC/EN 60384-14 UL 60384-14	VDE 40001804, UL E146544
Alt.)	TDK	CS, CD	Max. 1000pF, 250Vac, 125°C	IEC/EN 60384-14 UL 60384-14	VDE 40029780, UL E37861
Alt.)	Murata	KH, KX	Max. 1000pF, 250Vac, 125°C	IEC/EN 60384-14 UL 60384-14	VDE 40002831, UL E37921
Alt.)	JYA-NAY	JY, JN	Max. 1000pF, 250Vac, 125°C	IEC/EN 60384-14 UL 60384-14	UL E201384
Alt.)	Hongming	F	Max. 1000pF, 250Vac, 125°C	IEC/EN 60384-14 UL 60384-14	VDE, UL E154899
Alt.)	Wansheng	CT7	Max. 1000pF, 250Vac, 125°C	IEC/EN 60384-14 UL 60384-14	VDE 40012143, UL E249006
Alt.)	Haohua	CT7	Max. 1000pF, 250Vac, 125°C	IEC/EN 60384-14 UL 60384-14	VDE 40003902, UL E233106

IEC 62368-1					
Clause	Requirement + Test		Result - Remark		Verdict
Alt.)	Samwha	SD	Max. 1000pF, 250Vac, 125°C	IEC/EN 60384-14 UL 60384-14	VDE, UL E97754
Alt.)	Success	SE	Max. 1000pF, 250Vac, 125°C	IEC/EN 60384-14 UL 60384-14	VDE 40037218, UL E114280
Alt.)	Success	SB	Max. 1000pF, 250Vac, 125°C	IEC/EN 60384-14 UL 60384-14	VDE 40037221, UL E114280
Alt.)	Yinan Don's	CT81	Max. 1000pF, 250Vac, 125°C	IEC/EN 60384-14 UL 60384-14	VDE 135256, UL E145038
Y- Capacitor (C900) Y1 type (optional)	Walsin	AH	Max. 3300pF, 250Vac, 125°C	IEC/EN 60384-14 UL 60384-14	VDE 40001804, UL E146544
Alt.)	TDK	CD	Max. 3300pF, 250Vac, 125°C	IEC/EN 60384-14 UL 60384-14	VDE 40029780, UL E37861
Alt.)	Murata	KX	Max. 3300pF, 250Vac, 125°C	IEC/EN 60384-14 UL 60384-14	VDE 40002831, UL E37921
Alt.)	JYA-NAY	JN	Max. 3300pF, 250Vac, 125°C	IEC/EN 60384-14 UL 60384-14	UL E201384
Alt.)	Hongming	F	Max. 3300pF, 250Vac, 125°C	IEC/EN 60384-14 UL 60384-14	VDE, UL E154899
Alt.)	Wansheng	CT7	Max. 3300pF, 250Vac, 125°C	IEC/EN 60384-14 UL 60384-14	VDE 40012143, UL E249006
Alt.)	Haohua	CT7	Max. 3300pF, 250Vac, 125°C	IEC/EN 60384-14 UL 60384-14	VDE, UL E233106
Alt.)	Samwha	SD	Max. 3300pF, 250Vac, 125°C	IEC/EN 60384-14 UL 60384-14	VDE, UL E97754
Alt.)	Success	SE	Max. 3300pF, 250Vac, 125°C	IEC/EN 60384-14 UL 60384-14	VDE 40037218, UL E114280
Alt.)	Success	SB	Max. 3300pF, 250Vac, 125°C	IEC/EN 60384-14 UL 60384-14	VDE 40037221, UL E114280
Alt.)	Yinan Don's	CT81	Max. 3300pF, 250Vac, 125°C	IEC/EN 60384-14 UL 60384-14	VDE 135256, UL E145038

IEC 62368-1					
Clause	Requirement + Test		Result - Remark		Verdict
Y- Capacitor (C944) Y1 type (optional)	Walsin	AH	Max. 1000pF, 250Vac, 125°C	IEC/EN 60384-14 UL 60384-14	VDE 40001804, UL E146544
Alt.)	TDK	CD	Max. 1000pF, 250Vac, 125°C	IEC/EN 60384-14 UL 60384-14	VDE 40029780, UL E37861
Alt.)	Murata	KX	Max. 1000pF, 250Vac, 125°C	IEC/EN 60384-14 UL 60384-14	VDE 40002831, UL E37921
Alt.)	JYA-NAY	JN	Max. 1000pF, 250Vac, 125°C	IEC/EN 60384-14 UL 60384-14	UL E201384
Alt.)	Hongming	F	Max. 1000pF, 250Vac, 125°C	IEC/EN 60384-14 UL 60384-14	VDE, UL E154899
Alt.)	Wansheng	CT7	Max. 1000pF, 250Vac, 125°C	IEC/EN 60384-14 UL 60384-14	VDE 40012143, UL E249006
Alt.)	Haohua	CT7	Max. 1000pF, 250Vac, 125°C	IEC/EN 60384-14 UL 60384-14	VDE, UL E233106
Alt.)	Samwha	SD	Max. 1000pF, 250Vac, 125°C	IEC/EN 60384-14 UL 60384-14	VDE, UL E97754
Alt.)	Success	SE	Max. 1000pF, 250Vac, 125°C	IEC/EN 60384-14 UL 60384-14	VDE 40037218, UL E114280
Alt.)	Success	SB	Max. 1000pF, 250Vac, 125°C	IEC/EN 60384-14 UL 60384-14	VDE 40037221, UL E114280
Alt.)	Yinan Don's	CT81	Max. 1000pF, 250Vac, 125°C	IEC/EN 60384-14 UL 60384-14	VDE 135256, UL E145038
X-Capacitor (X1 or X2 type) (C914) (optional)	Ultra Tech Xiphi	HQX	Max. 0.47μF, Min. 250Vac, 110°C	IEC/EN 60384-14 UL 60384-14	VDE 40024534, UL E183780
Alt.)	Faratronic	MKP62	Max. 0.47μF, Min. 250Vac, 110°C	IEC/EN 60384-14 UL 60384-14	VDE, UL E186600
Alt.)	Hua Jung	MKP	Max. 0.47μF, Min. 250Vac, 110°C	IEC/EN 60384-14 UL 60384-14	ENEC(Semko), UL E149075

IEC 62368-1					
Clause	Requirement + Test		Result - Remark		Verdict
Alt.)	Nanjing Tengen Rongguangda	MKP	Max. 0.47 μ F, Min. 250Vac, 110°C	IEC/EN 60384-14 UL 60384-14	VDE 40028680, UL E200596
Alt.)	Europtronic	MPX, MPX2	Max. 0.47 μ F, Min. 250Vac, 110°C	IEC/EN 60384-14 UL 60384-14	VDE 40025981, UL E211347
Alt.)	Liow Gu	GS-L	Max. 0.47 μ F, Min. 250Vac, 110°C	IEC/EN 60384-14 UL 60384-14	VDE 40023391, UL E186321
Alt.)	Arcotronics (KEMET)	R.46	Max. 0.47 μ F, Min. 250Vac, 110°C	IEC/EN 60384-14 UL 60384-14	ENEC DAT9700014 1, UL E97797
Alt.)	EPCOS	B3292#	Max. 0.47 μ F, Min. 250Vac, 110°C	IEC/EN 60384-14 UL 60384-14	VDE 40010694, UL E97863
Alt.)	ZhuHai Sung Ho Electronics Co., Ltd.	CMPP	Max. 0.47 μ F, Min. 250Vac, 110°C	IEC/EN 60384-14 UL 60384-14	VDE 40026078, UL E327138
Photo Coupler (U902)	Sharp	PC123	Di=0.7mm, ext. cr \geq 8.0mm, 5000Vac, 110°C	IEC 60747-5-5:2007 IEC 60747-5-5:2007/AMD1: 2013 DIN EN 60747-5-5, UL1577	VDE 40008087, UL E64380
Alt.)	Vishay Semiconductor	TCET1103	Di=0.6mm, ext. cr=8.4mm, 5000Vac, 100°C	IEC 60747-5-5:2007 IEC 60747-5-5:2007/AMD1: 2013 DIN EN 60747-5-5, UL1577	VDE 40028080, UL E76222
Alt.)	Everlight Electronics Co., Ltd.	EL817, EL817M	Di=0.5mm, ext. cr=7.7mm, 5000Vac, 100°C	IEC 60747-5-5:2007 IEC 60747-5-5:2007/AMD1: 2013 DIN EN 60747-5-5, UL1577	VDE 132249, UL E214129

IEC 62368-1					
Clause	Requirement + Test	Result - Remark			Verdict
Alt.)	Lite-on	LTV-817	Di=0.4mm, ext. cr ≥7.0mm, 5000Vac, 100°C	IEC 60747-5- 5:2007 IEC 60747-5- 5:2007/AMD1: 2013 DIN EN 60747- 5-5, UL1577	VDE 40015248, UL E113898
Alt.)	Everlight Electronics Co., Ltd.	EL1013	Di=0.4mm, int. cr=thermal cycling ³ ext. cr=8.0mm, 4000Vac, 100°C	IEC 60747-5- 5:2007 IEC 60747-5- 5:2007/AMD1: 2013 DIN EN 60747- 5-5, UL1577	UL E214129
Alt.)	Renesas	PS2561-1 PS2561L-1 PS2561L1-1 PS2561L2-1 PS2561DL1-1	Di=0.4mm, ext. cr=8.0mm, 5000Vac, 100°C	IEC 60747-5- 5:2007 IEC 60747-5- 5:2007/AMD1: 2013 DIN EN 60747- 5-5, UL1577	VDE 40008862, UL E72422
Alt.)	TOSHIBA	TLP781F TLP781	Di=0.4mm, ext. cr=8.0mm, 5000Vac, 100°C	IEC 60747-5- 5:2007 IEC 60747-5- 5:2007/AMD1: 2013 DIN EN 60747- 5-5, UL1577	VDE 40021173, UL E67349
Alt.)	TOSHIBA	TLP421F	Di=0.4mm, ext. cr=8.0mm, 5000Vac, 100°C	IEC 60747-5- 5:2007 IEC 60747-5- 5:2007/AMD1: 2013 DIN EN 60747- 5-5, UL1577	VDE 40010944, UL E67349
Bleeder Resistor (R916, R917, R918)	Guangdong Fenghua Advanced Technology Holding Co., Ltd.	RVS-06#xxxFT series	Max. 680KΩ, min. 1/4W	IEC 62368-1	CB issued by NEMKO (CB cert No. NO99692)

IEC 62368-1					
Clause	Requirement + Test			Result - Remark	Verdict
Alt.)	Guangdong Fenghua Advanced Technology Holding Co., Ltd.	RS-06#xxxFT series	Max. 680KΩ, min. 1/4W	IEC 62368-1	CB issued by NEMKO (CB report No. 337017)
Alt.)	Yageo Corporation	RV1206XX-0782K1L	Max. 680KΩ, min. 1/4W	IEC 62368-1	CB issued by UL (CB cert No. DK-64853-UL)
Alt.)	Yageo Corporation	RV1206 series	Max. 680KΩ, min. 1/4W	IEC 62368-1	CB issued by UL (CB report No. E491387-4787887815-1 Original)
Alt.)	Tzai Yuan Enterprise Co., Ltd.	HSMD*****, SMD*****	Max. 680KΩ, min. 1/4W	IEC 62368-1	CB issued by UL (CB cert No. DK-29431-A1-M1-UL)
Line Choke (L901) (Optional)	CHANNELON	373G0174577 H	105 °C	--	--
(Alternative)	LDFJ	373G0174577J	105 °C	--	--
(Alternative)	ASET	373G0174577X	105 °C	--	--
Transformer (T901)	Phoenix	380GL19P0170 P	Class B	Applicable parts of IEC 62368-1 and according to IEC 60085	Accepted by TÜV Rheinland
(Alternative)	LIANFENG DONGJJIN	380GL19P0170 J	Class B	Applicable parts of IEC 62368-1 and according to IEC 60085	Accepted by TÜV Rheinland
(Alternative)	TAICHANG	380GL19P0170 S	Class B	Applicable parts of IEC 62368-1 and according to IEC 60085	Accepted by TÜV Rheinland
(Alternative)	LITAI	380GL19P0170 L	Class B	Applicable parts of IEC 62368-1 and according to IEC 60085	Accepted by TÜV Rheinland
(Alternative)	YUVA	80GL19P-17-N	Class B	Applicable parts of IEC 62368-1 and according to IEC 60085	Accepted by TÜV Rheinland

IEC 62368-1					
Clause	Requirement + Test		Result - Remark		Verdict
-Bobbin	SUMITOMO BAKELITE CO LTD	PM-9820	V-0, 150°C, min. 0.45mm thick	UL94	UL E41429
(Alternative)	CHANG CHUN PLASTICS CO., LTD.	T200NA	V-0, 150°C, min. 0.45mm thick	UL94	UL E59481
-Triple insulation wire	SUZHOU VDE YUSHENG ELECTRONIC CO LTD	TIW-B	Reinforced insulation, 130°C	IEC/EN 60950- 1, UL 2353	VDE 40033527 UL E364920
(Alternative)	Cosmolink Co Ltd	TIW-M	Reinforced insulation, 130°C	IEC/EN 60950- 1, UL 2353	VDE 138053 UL E213764
-Insulation tape	JingJiang YaHua Pressure Sensitive Glue Co., Ltd	CT	PET film insulating tape, 130°C	UL510	UL E165111
(Alternative)	SYMBIO INC	35660Y*(%)	PET film insulating tape, 130°C	UL510	UL E50292
-Tube	GREAT HOLDING INDUSTRIAL CO., LTD.	TFL	PTFE, 200°C, VW-1	UL224	UL E156256
Switching mode power supply board: 715GB018 by TPV					
AC-Inlet (CN901)	Solteam	ST-01, SC04	10A, 250Vac, 15A, 250Vac, 70°C	IEC/ EN 60320-1 UL60320-1	VDE 40015691, UL E200241
Alt.)	Zhang Jia Gang- Hua Jie	SA-4S series	10A, 250Vac, 15A, 250Vac, 70°C	IEC/ EN 60320-1 UL60320-1	VDE 40003610, UL E154342
Alt.)	Rong Feng	SS-120, SS-7B	10A, 250Vac, 15A, 250Vac, 70°C	IEC/ EN 60320-1 UL60320-1	VDE 40028101, UL E102641
Alt.)	Shenzhen Delikang / Douling	CDJ-3, CDJ-3-1	10A, 250Vac, 70°C	IEC/ EN 60320-1 UL60320-1	VDE 40010513, UL E217394
Alt.)	Shenzhen Delikang / Douling	CDJ-7 1	10A, 250Vac, 70°C	IEC/ EN 60320-1 UL60320-1	ENEC SE/14029-5, UL E317189
Alt.)	Inalways	0707-1, 0711-2, 0714	10A, 250Vac, 70°C	IEC/ EN 60320-1 UL60320-1	Nemko (P03100418), UL (E94191)
Alt.)	TECX	TU-301 series	10A, 250Vac, 70°C	IEC/ EN 60320-1 UL60320-1	VDE (40025582) UL (E220004)

IEC 62368-1					
Clause	Requirement + Test		Result - Remark		Verdict
Alt.)	Yueqing Hongchang	DB-14 series	10A/250Vac, 15A, 250Vac, 70°C	IEC/ EN 60320-1 UL60320-1	VDE 40028645, UL E327347
Alt.)	Solteam	SC04	VDE: 10A/250Vac, UL: 10A/250Vac, 12A/250Vac. 70°C	IEC/ EN 60320-1 UL60320-1	VDE 40033517, UL E200241
Alt.)	Zhang Jia Gang-Hua Jie	SA-4D	10A, 250Vac, 15A, 250Vac, 70°C	IEC/ EN 60320-1 UL60320-1	TUV R 50274698 UL E154342
Alt.)	Yueqing Hongchang	DB-14-14-L	15A, 250Vac (UL); 10A, 250Vac (VDE)	IEC/ EN 60320-1 UL60320-1	VDE 40028645, UL E327347
Fuse (F9901 in primary)	Littelfuse Inc	382, 392 +	T5AL, 250Vac	IEC/EN 60127-1 IEC/EN 60127-3 ANSI/UL 248-1 ANSI/UL 248-14	VDE (40018249, 126983), UL (E67006)
Alt.)	Littelfuse Inc	TE5 808	T5AL, 250Vac	IEC/EN 60127-1 IEC/EN 60127-3 ANSI/UL 248-1 ANSI/UL 248-14	VDE (40018249, 126983), UL (E67006)
Alt.)	Conquer	MET MST PTU	T5AL, 250Vac	IEC/EN 60127-1 IEC/EN 60127-3 ANSI/UL 248-1 ANSI/UL 248-14	VDE (40017155, 40017118, 40001462), UL (E82636)
Alt.)	Walter	SR-5, SS-5	T5AL, 250Vac	IEC/EN 60127-1 IEC/EN 60127-3 ANSI/UL 248-1 ANSI/UL 248-14	VDE (40020046, 40015513), UL (E19180)
Alt.)	Ever Island Electric Co., Ltd. & Walter Electric	2000, 2010 series	T5AL, 250Vac	IEC/EN 60127-1 IEC/EN 60127-3 ANSI/UL 248-1 ANSI/UL 248-14	VDE (40018790, 40018781) UL (E220181)
Alt.)	Littelfuse Inc	877	T5AL, 250Vac	IEC/EN 60127-1 IEC/EN 60127-3 ANSI/UL 248-1 ANSI/UL 248-14	VDE (0023242), UL (E10480)
Alt.)	Better	932	T5AL, 250Vac	IEC/EN 60127-1 IEC/EN 60127-3 ANSI/UL 248-1 ANSI/UL 248-14	VDE (40033369), UL (E300003)
Fuse (F9902 and F9903 in secondary for L.P.S.)	Littelfuse Inc	382, 392 +	T5AL, 250Vac	IEC/EN 60127-1 IEC/EN 60127-3 ANSI/UL 248-1 ANSI/UL 248-14	VDE (40018249, 126983), UL(E67006)

IEC 62368-1					
Clause	Requirement + Test		Result - Remark		Verdict
Alt.)	Littelfuse Inc	TE5 808	T5AL, 250Vac	IEC/EN 60127-1 IEC/EN 60127-3 ANSI/UL 248-1 ANSI/UL 248-14	VDE (40018249, 126983), UL(E67006)
Alt.)	Conquer	MET MST PTU	T5AL, 250Vac	IEC/EN 60127-1 IEC/EN 60127-3 ANSI/UL 248-1 ANSI/UL 248-14	VDE (40017155, 40017118, 40001462), UL(E82636)
Alt.)	Walter	SR-5, SS-5	T5AL, 250Vac	IEC/EN 60127-1 IEC/EN 60127-3 ANSI/UL 248-1 ANSI/UL 248-14	VDE (40020046, 40015513), UL(E19180)
Alt.)	Ever Island Electric Co., Ltd. & Walter Electric	2000, 2010 series	T5AL, 250Vac	IEC/EN 60127-1 IEC/EN 60127-3 ANSI/UL 248-1 ANSI/UL 248-14	VDE (40018790, 40018781) UL (E220181)
Alt.)	Littelfuse Inc	877	T5AL, 250Vac	IEC/EN 60127-1 IEC/EN 60127-3 ANSI/UL 248-1 ANSI/UL 248-14	VDE (0023242), UL(E10480)
Alt.)	Better	932	T5AL, 250Vac	IEC/EN 60127-1 IEC/EN 60127-3 ANSI/UL 248-1 ANSI/UL 248-14	VDE (40033369), UL (E300003)
Fuse (F801 in secondary for L.P.S.)	Littelfuse Inc	382, 392 +	T3.15AL, 250Vac	IEC/EN 60127-1 IEC/EN 60127-3 ANSI/UL 248-1 ANSI/UL 248-14	VDE (40018249, 126983), UL(E67006)
Alt.)	Littelfuse Inc	TE5 808	T3.15AL, 250Vac	IEC/EN 60127-1 IEC/EN 60127-3 ANSI/UL 248-1 ANSI/UL 248-14	VDE (40018249, 126983), UL(E67006)
Alt.)	Conquer	MET MST PTU	T3.15AL, 250Vac	IEC/EN 60127-1 IEC/EN 60127-3 ANSI/UL 248-1 ANSI/UL 248-14	VDE (40017155, 40017118, 40001462), UL(E82636)
Alt.)	Walter	SR-5, SS-5	T3.15AL, 250Vac	IEC/EN 60127-1 IEC/EN 60127-3 ANSI/UL 248-1 ANSI/UL 248-14	VDE (40020046, 40015513), UL(E19180)
Alt.)	Ever Island Electric Co., Ltd. & Walter Electric	2000, 2010 series	T3.15AL, 250Vac	IEC/EN 60127-1 IEC/EN 60127-3 ANSI/UL 248-1 ANSI/UL 248-14	VDE (40018790, 40018781) UL (E220181)

IEC 62368-1					
Clause	Requirement + Test		Result - Remark		Verdict
Alt.)	Littelfuse Inc	877	T3.15AL, 250Vac	IEC/EN 60127-1 IEC/EN 60127-3 ANSI/UL 248-1 ANSI/UL 248-14	VDE (0023242), UL(E10480)
Alt.)	Better	932	T3.15AL, 250Vac	IEC/EN 60127-1 IEC/EN 60127-3 ANSI/UL 248-1 ANSI/UL 248-14	VDE (40033369), UL (E300003)
Y- Capacitor (C9901, C9902, C9909, C9910) Y1 or Y2 type (optional)	Walsin	AH, AC	Max. 680pF, 250Vac, 105°C	IEC/EN 60384- 14 UL 60384-14	VDE 40001804, UL E146544
Alt.)	TDK	CD, CS	Max. 680pF, 250Vac, 105°C	IEC/EN 60384- 14 UL 60384-14	VDE 40029780, UL E37861
Alt.)	Murata	KX, KH	Max. 680pF, 250Vac, 105°C	IEC/EN 60384- 14 UL 60384-14	VDE 40002831, UL E37921
Alt.)	JYA-NAY	JN, JY	Max. 680pF, 250Vac, 105°C	IEC/EN 60384- 14 UL 60384-14	UL E201384
Alt.)	Kunshan Wansheng	CT7	Max. 680pF, 250Vac, 105°C	IEC/EN 60384- 14 UL 60384-14	VDE 40012143, UL E249006
Alt.)	YINAN DON'S ELECTRONI C COMPONENT CO.,LTD	CT81	Max. 680pF, 250Vac, 105°C	IEC/EN 60384- 14 UL 60384-14	VDE 135256, UL E145038
Alt.)	SUCCESS	SE	Max. 680pF, 250Vac, 105°C	IEC/EN 60384- 14 UL 60384-14	VDE 40037218, UL E114280
Alt.)	SUCCESS	SB	Max. 680pF, 250Vac, 105°C	IEC/EN 60384- 14 UL 60384-14	VDE 40037221, UL E114280
Alt.)	SUCCESS	SL	Max. 680pF, 250Vac, 105°C	IEC/EN 60384- 14 UL 60384-14	VDE 40019465, UL E114280
Alt.)	Guangdong South Hongming Electronic Science and Technology Co., Ltd.	F	Max. 680pF, 250Vac, 105°C	IEC/EN 60384- 14 UL 60384-14	UL E154899

IEC 62368-1					
Clause	Requirement + Test		Result - Remark		Verdict
Y- Capacitor (C9911) Y1 type (optional)	Walsin Technology Corp.	AH	Max. 1000pF, 250Vac, 105°C	IEC/EN 60384-14 UL 60384-14	VDE 40001804, UL E146544
Alt.)	TDK Corporation	CD	Max. 2200pF, 250Vac, 105°C	IEC/EN 60384-14 UL 60384-14	VDE 40029780, UL E37861
Alt.)	Murata Mfg. Co., Ltd.	KX	Max. 2200pF, 250Vac, 105°C	IEC/EN 60384-14 UL 60384-14	VDE 40002831, UL E37921
Alt.)	Kunshan Wansheng Electronics Co., Ltd.	CT7	Max. 2200pF, 250Vac, 105°C	IEC/EN 60384-14 UL 60384-14	VDE 40012143, UL E249006
Alt.)	Haohua Electronic Co	CT7	Max. 2200pF, 250Vac, 105°C	IEC/EN 60384-14 UL 60384-14	VDE, UL E233106
Alt.)	Samwha Capacitor Co., Ltd.	SD	Max. 2200pF, 250Vac, 105°C	IEC/EN 60384-14 UL 60384-14	VDE, UL E97754
Alt.)	Success Electronics Co., Ltd.	SB, SE	Max. 2200pF, 250Vac, 105°C	IEC/EN 60384-14 UL 60384-14	VDE 40037221, UL E114280
Alt.)	Yinan Don's Electronic Component Co., Ltd.	CT81	Max. 2200pF, 250Vac, 105°C	IEC/EN 60384-14 UL 60384-14	VDE 135256, UL E145038
Alt.)	Guangdong South Hongming Electronic Science and Technology Co., Ltd.	F	Max. 2200pF, 250Vac, 105°C	IEC/EN 60384-14 UL 60384-14	UL E154899
X-Capacitor (X1 or X2 type) (C9905, C9906) (optional)	Ultra Tech Xiphi	HQX	Max. 0.33µF, Min. 250Vac, 100°C	IEC/EN 60384-14 UL 60384-14	VDE 40024534, UL E183780
Alt.)	Europtronic	MPX	Max. 0.33µF, Min. 250Vac, 100°C	IEC/EN 60384-14 UL 60384-14	VDE 40018238, UL E211347
Alt.)	Europtronic	MPX2	Max. 0.33µF, Min. 250Vac, 100°C	IEC/EN 60384-14 UL 60384-14	VDE 40025981, UL E211347
Alt.)	Liow Gu	GS-L	Max. 0.33µF, Min. 250Vac, 100°C	IEC/EN 60384-14 UL 60384-14	VDE 40023391, UL E186321

IEC 62368-1					
Clause	Requirement + Test		Result - Remark		Verdict
Alt.)	Arcotronics (KEMET)	R.46	Max. 0.33 μ F, Min. 250Vac, 100°C	IEC/EN 60384-14 UL 60384-14	ENEC DAT9700014 1, UL E97797
Alt.)	EPCOS	B3292#	Max. 0.33 μ F, Min. 250Vac, 100°C	IEC/EN 60384-14 UL 60384-14	VDE 40010694, UL E97863
Alt.)	Nanjing Tengen Rongguangda	MKP	Max. 0.33 μ F, Min. 250Vac, 100°C	IEC/EN 60384-14 UL 60384-14	VDE 40028680, UL E200596
Alt.)	ZhuHai Sung Ho Electronics Co., Ltd.	CMPP	Max. 0.33 μ F, Min. 250Vac, 100°C	IEC/EN 60384-14 UL 60384-14	VDE 40026078, UL E327138
Alt.)	NANJING TENGGEN RONG GUANG DA ELECTRONICS (GROUP) CO LTD	MKP	Max. 0.33 μ F, Min. 250Vac, 100°C	IEC/EN 60384-14 UL 60384-14	VDE 40028680, UL E200596
Discharge IC (U9104)	O2Micro Electronics, Inc.	OZ531TGN	240Vac	IEC 62368-1:2014 (Second Edition)	CB (CB cert No. JPTUV-078146)
Photo Coupler (U9102, U9401)	Sharp	PC123	Di=0.7mm, ext. cr \geq 8.0mm, 5000Vac, 110°C	IEC 60747-5-5:2007 IEC 60747-5-5:2007/AMD1: 2013 DIN EN 60747-5-5, UL1577	VDE 40008087, UL E64380
Alt.)	Vishay Semiconductor	TCET1103	Di=0.6mm, ext. cr=8.4mm, 5000Vac, 100°C	IEC 60747-5-5:2007 IEC 60747-5-5:2007/AMD1: 2013 DIN EN 60747-5-5, UL1577	VDE 40028080, UL E76222
Alt.)	Everlight Electronics Co., Ltd.	EL817, EL817M	Di=0.5mm, ext. cr=7.7mm, 5000Vac, 100°C	IEC 60747-5-5:2007 IEC 60747-5-5:2007/AMD1: 2013 DIN EN 60747-5-5, UL1577	VDE 132249, UL E214129

IEC 62368-1					
Clause	Requirement + Test	Result - Remark			Verdict
Alt.)	Lite-on	LTV-817	Di=0.4mm, ext. cr ≥7.0mm, 5000Vac, 100°C	IEC 60747-5- 5:2007 IEC 60747-5- 5:2007/AMD1: 2013 DIN EN 60747- 5-5, UL1577	VDE 40015248, UL E113898
Alt.)	Everlight Electronics Co., Ltd.	EL1013	Di=0.4mm, int. cr=thermal cycling ³ ext. cr=8.0mm, 4000Vac, 100°C	UL1577	UL E214129
Alt.)	Renesas	PS2561-1 PS2561L-1 PS2561L1-1 PS2561L2-1 PS2561DL1-1	Di=0.4mm, ext. cr=8.0mm, 5000Vac, 100°C	IEC 60747-5- 5:2007 IEC 60747-5- 5:2007/AMD1: 2013 DIN EN 60747- 5-5, UL1577	VDE 40008862, UL E72422
Alt.)	TOSHIBA	TLP781F TLP781	Di=0.4mm, ext. cr=8.0mm, 5000Vac, 100°C	IEC 60747-5- 5:2007 IEC 60747-5- 5:2007/AMD1: 2013 DIN EN 60747- 5-5, UL1577	VDE 40021173, UL E67349
Alt.)	TOSHIBA	TLP421F	Di=0.4mm, ext. cr=8.0mm, 5000Vac, 100°C	IEC 60747-5- 5:2007 IEC 60747-5- 5:2007/AMD1: 2013 DIN EN 60747- 5-5, UL1577	VDE 40010944, UL E67349
PFC choke (L9801) (Optional)	CHANNELON	373G0174528H	130°C	--	--
Alt.)	ASET	373G0174528X	130°C	--	--
Line Choke (L9901, L9902) (Optional)	CHANNELON	373G0174588H	130°C	--	--
Alt.)	LIANFENG DONGJIN	373G0174588J	130°C	--	--
Alt.)	Tai Chang	373G0174588S	130°C	--	--

IEC 62368-1					
Clause	Requirement + Test		Result - Remark		Verdict
Transformer (T9101) (Alt.)	LI TAI	380GL32P591L	Class 130 material (B)	Applicable parts of IEC 62368-1 and according to IEC 60085	Accepted by TÜV Rheinland
Bobbin	CHANG CHUN	T200HF	Phenolic, V-0, 150°C	UL 94	UL (E59481)
Triple insulation wire	Cosmolink	TIW-M	130°C	IEC/EN 62368-1, VDE0805 Teil1, UL 2353	UL E213764 VDE 138053
Teflon tube	GREAT HOLDING	TFL	200°C.	UL 224	UL E156256
Transformer (T9101) (Alt.)	PHOENIX	380GL32P591P	Class 130 material (B)	Applicable parts of IEC 62368-1 and according to IEC 60085	Accepted by TÜV Rheinland
Bobbin	Sumitomo	PM-9750	Phenolic, V-0, 150°C	UL 94	UL (E41429)
Triple insulation wire	YUSHENG	TIW-B	130°C	IEC/EN 62368-1, VDE0805 Teil1, UL 2353	UL E364920, VDE 40033527
Teflon tube	GREAT HOLDING	TFL	200°C.	UL 224	UL E156256
Switching mode power supply board: 715GC031 by TPV					
AC Inlet (CN901)	Solteam	ST-01, SC04	10A, 250Vac, 15A, 250Vac, 70°C	IEC/ EN 60320-1 UL60320-1	VDE 40015691, UL E200241
Alt.)	Zhang Jia Gang-Hua Jie	SA-4S series	10A, 250Vac, 15A, 250Vac, 70°C	IEC/ EN 60320-1 UL60320-1	VDE 40003610, UL E154342
Alt.)	Rong Feng	SS-120, SS-7B	10A, 250Vac, 15A, 250Vac, 70°C	IEC/ EN 60320-1 UL60320-1	VDE 40028101, UL E102641
Alt.)	Shenzhen Delikang / Douling	CDJ-3, CDJ-3-1	10A, 250Vac, 70°C	IEC/ EN 60320-1 UL60320-1	VDE 40010513, UL E217394
Alt.)	Shenzhen Delikang / Douling	CDJ-7 1	10A, 250Vac, 70°C	IEC/ EN 60320-1 UL60320-1	ENEC SE/14029-5, UL E317189
Alt.)	Inalways	0707-1, 0711-2, 0714	10A, 250Vac, 70°C	IEC/ EN 60320-1 UL60320-1	Nemko (P03100418) UL (E94191)

IEC 62368-1					
Clause	Requirement + Test		Result - Remark		Verdict
Alt.)	TECX	TU-301 series	10A, 250Vac, 70°C	IEC/ EN 60320-1 UL60320-1	VDE (40025582) UL (E220004)
Alt.)	Yueqing Hongchang	DB-14 series	10A/250Vac, 15A, 250Vac, 70°C	IEC/ EN 60320-1 UL60320-1	VDE 40028645, UL E327347
Alt.)	Solteam	SC04	VDE: 10A/250Vac, UL: 10A/250Vac, 12A/250Vac. 70°C	IEC/ EN 60320-1 UL60320-1	VDE 40033517, UL E200241
Alt.)	Zhang Jia Gang- Hua Jie	SA-4D	10A, 250Vac, 15A, 250Vac, 70°C	IEC/ EN 60320-1 UL60320-1	TUV R 50274698 UL E154342
Alt.)	Yueqing Hongchang	DB-14-14-L	15A, 250Vac (UL); 10A, 250Vac (VDE)	IEC/ EN 60320-1 UL60320-1	VDE 40028645, UL E327347
Fuse (F901 in primary)	Littelfuse Inc	382, 392 +	T4AL, 250Vac	IEC/EN 60127-1 IEC/EN 60127-3 ANSI/UL 248-1 ANSI/UL 248-14	VDE (40018249, 126983), UL (E67006)
Alt.)	Littelfuse Inc	TE5 808	T5AL, 250Vac	IEC/EN 60127-1 IEC/EN 60127-3 ANSI/UL 248-1 ANSI/UL 248-14	VDE (40018249, 126983), UL (E67006)
Alt.)	Conquer	MET MST PTU	T5AL, 250Vac	IEC/EN 60127-1 IEC/EN 60127-3 ANSI/UL 248-1 ANSI/UL 248-14	VDE (40017155, 40017118, 40001462), UL (E82636)
Alt.)	Walter	SR-5, SS-5	T5AL, 250Vac	IEC/EN 60127-1 IEC/EN 60127-3 ANSI/UL 248-1 ANSI/UL 248-14	VDE (40020046, 40015513), UL (E19180)
Alt.)	Ever Island Electric Co., Ltd. & Walter Electric	2000, 2010 series	T5AL, 250Vac	IEC/EN 60127-1 IEC/EN 60127-3 ANSI/UL 248-1 ANSI/UL 248-14	VDE (40018790, 40018781) UL (E220181)
Alt.)	Littelfuse Inc	877	T5AL, 250Vac	IEC/EN 60127-1 IEC/EN 60127-3 ANSI/UL 248-1 ANSI/UL 248-14	VDE (0023242), UL (E10480)
Alt.)	Better	932	T5AL, 250Vac	IEC/EN 60127-1 IEC/EN 60127-3 ANSI/UL 248-1 ANSI/UL 248-14	VDE (40033369), UL (E300003)

IEC 62368-1					
Clause	Requirement + Test		Result - Remark		Verdict
Fuse (F902, F903 in secondary for L.P.S.)	Littelfuse Inc	382, 392 +	T5AL, 250Vac	IEC/EN 60127-1 IEC/EN 60127-3 ANSI/UL 248-1 ANSI/UL 248-14	VDE (40018249, 126983), UL (E67006)
Alt.)	Littelfuse Inc	TE5 808	T5AL, 250Vac	IEC/EN 60127-1 IEC/EN 60127-3 ANSI/UL 248-1 ANSI/UL 248-14	VDE (40018249, 126983), UL (E67006)
Alt.)	Conquer	MET MST PTU	T5AL, 250Vac	IEC/EN 60127-1 IEC/EN 60127-3 ANSI/UL 248-1 ANSI/UL 248-14	VDE (40017155, 40017118, 40001462), UL (E82636)
Alt.)	Walter	SR-5, SS-5	T5AL, 250Vac	IEC/EN 60127-1 IEC/EN 60127-3 ANSI/UL 248-1 ANSI/UL 248-14	VDE (40020046, 40015513), UL (E19180)
Alt.)	Ever Island Electric Co., Ltd. & Walter Electric	2000, 2010 series	T5AL, 250Vac	IEC/EN 60127-1 IEC/EN 60127-3 ANSI/UL 248-1 ANSI/UL 248-14	VDE (40018790, 40018781) UL (E220181)
Alt.)	Littelfuse Inc	877	T5AL, 250Vac	IEC/EN 60127-1 IEC/EN 60127-3 ANSI/UL 248-1 ANSI/UL 248-14	VDE (0023242), UL (E10480)
Alt.)	Better	932	T5AL, 250Vac	IEC/EN 60127-1 IEC/EN 60127-3 ANSI/UL 248-1 ANSI/UL 248-14	VDE (40033369), UL (E300003)
Y- Capacitor (C920, C921) Y1 or Y2 type (optional)	Walsin	AH, AC	Max. 680pF, 250Vac, 105°C	IEC/EN 60384-14 UL 60384-14	VDE 40001804, UL E146544
Alt.)	TDK	CD, CS	Max. 680pF, 250Vac, 105°C	IEC/EN 60384-14 UL 60384-14	VDE 40029780, UL E37861
Alt.)	Murata	KX, KH	Max. 680pF, 250Vac, 105°C	IEC/EN 60384-14 UL 60384-14	VDE 40002831, UL E37921
Alt.)	JYA-NAY	JN, JY	Max. 680pF, 250Vac, 105°C	IEC/EN 60384-14 UL 60384-14	UL E201384
Alt.)	Kunshan Wansheng	CT7	Max. 680pF, 250Vac, 105°C	IEC/EN 60384-14 UL 60384-14	VDE 40012143, UL E249006

IEC 62368-1					
Clause	Requirement + Test		Result - Remark		Verdict
Alt.)	YINAN DON'S ELECTRONIC COMPONENT CO.,LTD	CT81	Max. 680pF, 250Vac, 105°C	IEC/EN 60384-14 UL 60384-14	VDE 135256, UL E145038
Alt.)	SUCCESS	SE	Max. 680pF, 250Vac, 105°C	IEC/EN 60384-14 UL 60384-14	VDE 40037218, UL E114280
Alt.)	SUCCESS	SB	Max. 680pF, 250Vac, 105°C	IEC/EN 60384-14 UL 60384-14	VDE 40037221, UL E114280
Alt.)	SUCCESS	SL	Max. 680pF, 250Vac, 105°C	IEC/EN 60384-14 UL 60384-14	VDE 40019465, UL E114280
Alt.)	Guangdong South Hongming Electronic Science and Technology Co., Ltd.	F	Max. 680pF, 250Vac, 105°C	IEC/EN 60384-14 UL 60384-14	UL E154899
Y- Capacitor (C900) Y1 type (optional)	Walsin	AH	Max. 3300pF, 250Vac, 105°C	IEC/EN 60384-14 UL 60384-14	VDE 40001804, UL E146544
Alt.)	TDK Corporation	CD	Max. 3300pF, 250Vac, 105°C	IEC/EN 60384-14 UL 60384-14	VDE 40029780, UL E37861
Alt.)	Murata Mfg. Co., Ltd.	KX	Max. 3300pF, 250Vac, 105°C	IEC/EN 60384-14 UL 60384-14	VDE 40002831, UL E37921
Alt.)	Kunshan Wansheng Electronics Co., Ltd.	CT7	Max. 3300pF, 250Vac, 105°C	IEC/EN 60384-14 UL 60384-14	VDE 40012143, UL E249006
Alt.)	Haohua Electronic Co	CT7	Max. 3300pF, 250Vac, 105°C	IEC/EN 60384-14 UL 60384-14	VDE, UL E233106
Alt.)	Samwha Capacitor Co., Ltd.	SD	Max. 3300pF, 250Vac, 105°C	IEC/EN 60384-14 UL 60384-14	VDE, UL E97754
Alt.)	Success Electronics Co., Ltd.	SB, SE	Max. 3300pF, 250Vac, 105°C	IEC/EN 60384-14 UL 60384-14	VDE 40037221, UL E114280
Alt.)	Yinan Don's Electronic Component Co., Ltd.	CT81	Max. 3300pF, 250Vac, 105°C	IEC/EN 60384-14 UL 60384-14	VDE 135256, UL E145038

IEC 62368-1					
Clause	Requirement + Test		Result - Remark		Verdict
Alt.)	Guangdong South Hongming Electronic Science and Technology Co., Ltd.	F	Max. 3300pF, 250Vac, 105°C	IEC/EN 60384-14 UL 60384-14	UL E154899
X-Capacitor (X1 or X2 type) (C914) (optional)	Ultra Tech Xiphi	HQX	Max. 0.47µF, Min. 250Vac, 100°C	IEC/EN 60384-14 UL 60384-14	VDE 40024534, UL E183780
Alt.)	Europtronic	MPX	Max. 0.47µF, Min. 250Vac, 100°C	IEC/EN 60384-14 UL 60384-14	VDE 40018238, UL E211347
Alt.)	Europtronic	MPX2	Max. 0.47µF, Min. 250Vac, 100°C	IEC/EN 60384-14 UL 60384-14	VDE 40025981, UL E211347
Alt.)	Liow Gu	GS-L	Max. 0.47µF, Min. 250Vac, 100°C	IEC/EN 60384-14 UL 60384-14	VDE 40023391, UL E186321
Alt.)	Arcotronics (KEMET)	R.46	Max. 0.47µF, Min. 250Vac, 100°C	IEC/EN 60384-14 UL 60384-14	ENEC DAT9700014 1, UL E97797
Alt.)	EPCOS	B3292#	Max. 0.47µF, Min. 250Vac, 100°C	IEC/EN 60384-14 UL 60384-14	VDE 40010694, UL E97863
Alt.)	Nanjing Tengen Rongguangda	MKP	Max. 0.47µF, Min. 250Vac, 100°C	IEC/EN 60384-14 UL 60384-14	VDE 40028680, UL E200596
Alt.)	ZhuHai Sung Ho Electronics Co., Ltd.	CMPP	Max. 0.47µF, Min. 250Vac, 100°C	IEC/EN 60384-14 UL 60384-14	VDE 40026078, UL E327138
Alt.)	NANJING TENGGEN RONG GUANG DA ELECTRONICS (GROUP) CO LTD	MKP	Max. 0.47µF, Min. 250Vac, 100°C	IEC/EN 60384-14 UL 60384-14	VDE 40028680, UL E200596
Photo Coupler (U902)	Sharp	PC123	Di=0.7mm, ext. cr ≥8.0mm, 5000Vac, 110°C	IEC 60747-5-5:2007 IEC 60747-5-5:2007/AMD1: 2013 DIN EN 60747-5-5, UL1577	VDE 40008087, UL E64380

IEC 62368-1					
Clause	Requirement + Test	Result - Remark			Verdict
Alt.)	Vishay Semiconductor	TCET1103	Di=0.6mm, ext. cr=8.4mm, 5000Vac, 100°C	IEC 60747-5-5:2007 IEC 60747-5-5:2007/AMD1: 2013 DIN EN 60747-5-5, UL1577	VDE 40028080, UL E76222
Alt.)	Everlight Electronics Co., Ltd.	EL817, EL817M	Di=0.5mm, ext. cr=7.7mm, 5000Vac, 100°C	IEC 60747-5-5:2007 IEC 60747-5-5:2007/AMD1: 2013 DIN EN 60747-5-5, UL1577	VDE 132249, UL E214129
Alt.)	Lite-on	LTV-817	Di=0.4mm, ext. cr ≥7.0mm, 5000Vac, 100°C	IEC 60747-5-5:2007 IEC 60747-5-5:2007/AMD1: 2013 DIN EN 60747-5-5, UL1577	VDE 40015248, UL E113898
Alt.)	Everlight Electronics Co., Ltd.	EL1013	Di=0.4mm, int. cr=thermal cycling ³ . ext. cr=8.0mm, 4000Vac, 100°C	UL1577	UL E214129
Alt.)	Renesas	PS2561-1 PS2561L-1 PS2561L1-1 PS2561L2-1 PS2561DL1-1	Di=0.4mm, ext. cr=8.0mm, 5000Vac, 100°C	IEC 60747-5-5:2007 IEC 60747-5-5:2007/AMD1: 2013 DIN EN 60747-5-5, UL1577	VDE 40008862, UL E72422
Alt.)	TOSHIBA	TLP781F TLP781	Di=0.4mm, ext. cr=8.0mm, 5000Vac, 100°C	IEC 60747-5-5:2007 IEC 60747-5-5:2007/AMD1: 2013 DIN EN 60747-5-5, UL1577	VDE 40021173, UL E67349

IEC 62368-1					
Clause	Requirement + Test			Result - Remark	Verdict
Alt.)	TOSHIBA	TLP421F	Di=0.4mm, ext. cr=8.0mm, 5000Vac, 100°C	IEC 60747-5- 5:2007 IEC 60747-5- 5:2007/AMD1: 2013 DIN EN 60747- 5-5, UL1577	VDE 40010944, UL E67349
Line Choke (L901A) (Optional)	CHANNELON	373G0174577 H	105 °C	--	--
(Alternative)	LDFJ	373G0174577J	105 °C	--	--
(Alternative)	ASET	373G0174577X	105 °C	--	--
Transformer (T901)	YUVA	80GL19P-17-N	Class B	Applicable parts of IEC 62368-1 and according to IEC 60085	Accepted by TÜV Rheinland
Alt.)	LITAI	80GL19P-17-L	Class B	Applicable parts of IEC 62368-1 and according to IEC 60085	Accepted by TÜV Rheinland
Alt.)	CHANNELON	80GL19P-17-H	Class B	Applicable parts of IEC 62368-1 and according to IEC 60085	Accepted by TÜV Rheinland
- Bobbin	Chang Chun	T200NA T200HF	Phenolic, V-0, 150°C	UL 94	UL (E59481)
Alt.)	Sumitomo Bakelite Co., Ltd.	PM-9820	Phenolic, V-0, 150°C	UL 94	UL (E41429)
- Insulation tape	SYMBIO INC	No.35660(a)	130°C	UL 510	UL E50292
Alt.)	JINGJIANG YAHUA	No.CT(c)	130°C	UL 510	UL E165111
- Triple insulation Wire	COSMOLINK CO.,LTD	TIW-M	130°C	IEC/EN 62368- 1, VDE0805 Teil1, UL 2353	UL E213764 VDE 138053
Alt.)	YUSHENG	TIW-B	130°C	IEC/EN 62368- 1, VDE0805 Teil1, UL 2353	UL E364920, VDE 40033527
Alt.)	GREAT LEOFLON	TRW(B)	130°C	IEC/EN 62368- 1, VDE0805 Teil1, UL 2353	UL E211989, VDE 136581

IEC 62368-1					
Clause	Requirement + Test			Result - Remark	Verdict
- Tube	GREAT HOLDING INDUSTRIAL CO.,LTD	TFL	200°C.	UL 224	UL E156256
Components listed below are not regarded critical components:					
Metal enclosure (under power board)	Interchangeable	Interchangeable	Metal thickness: min. 0.81mm	--	--
Metal enclosure (except fire enclosure bottom)	Interchangeable	Interchangeable	Metallic, min. 0.5mm thickness.	--	--
Base stand (optional)	Interchangeable	Interchangeable	HB or better	UL 94	UL
Internal Speaker (two sets) (optional)	Interchangeable	Interchangeable	Each rated 4Ω, 2.5W	--	Tested in equipment
P.C.B	Interchangeable	Interchangeable	V-1 or better Min. 130°C.	UL 796	UL
Rating information of components which are not critical components on power board 715G9611					
Bridging Diode (BD901, BD902) (optional)	Interchangeable	Interchangeable	Min.600V, min.2A	--	--
Ripple Capacitor (C902, C903)	Interchangeable	Interchangeable	47-180μF, max. 450V, 105°C	--	--
Thermistor (TH901)	Interchangeable	Interchangeable	Min. 3Ω at 25°C, min. 2A	--	--
Rating information of components which are not critical components on power board 715GB018					
Current sensor resistor (R9111)	Interchangeable	Interchangeable	Min. 0.22Ω, 2W	--	Tested in equipment
Thermistor (NR9901, NR9902)	Interchangeable	Interchangeable	Min. 2.5Ω, Min. 2A, 25°C	--	Tested in equipment
Bridging Diode (BD9901, BD9902)	Interchangeable	Interchangeable	Min. 2A, Max 800V.	--	Tested in equipment
Ripple Capacitor (C9814)	Interchangeable	Interchangeable	30-150uF, min. 450 V, min .105°C	--	Tested in equipment
Transistor (Q9101, Q9801)	Interchangeable	Interchangeable	Min. 5A, 500V min.	--	Tested in equipment
Rating information of components which are not critical components on power board 715GC031					
Bridging Diode (BD901, BD902)	Interchangeable	Interchangeable	Min.600V, min.2A	--	--

IEC 62368-1					
Clause	Requirement + Test		Result - Remark		Verdict
Ripple Capacitor (C902, C903)	Interchangeable	Interchangeable	47-180 μ F, max. 450V, 105°C	--	--
Thermistor (TH901)	Interchangeable	Interchangeable	Min. 3 Ω at 25°C, min. 2A	--	--
Current sensor resistor (R919)	Interchangeable	Interchangeable	Min. 0.33 Ω , 2W	--	Tested in equipment
Bleeder Resistor (R916, R917, R918, R938, R939 and R940)	Interchangeable	Interchangeable	Max. 1.3M Ω , min. 1/4W	--	Tested in equipment
Mains cord set (Saudi Arabia) (Optional)					
Plug	Voex	MP5004A, DLUK10S3, VNUK13A3, UK13A2, UK13A3, VPUK13A3	2.5A/250V	BS 1363 SASO 2203:2018	Intertek (ASTA)
Connector	Voex	VAC5S, DLC5CS3, VNC5S, DLC5E3, VAC5AR, VAC7S, SZC7S, VCC5S	2.5A/250V	BS 1363 SASO 2203:2018	Intertek (ASTA)
Cable	Voex	H03VV-F, H03VVH2-F, H03Z1Z1-F	3X0.75mm ²	BS 1363 SASO 2203:2018	Intertek (ASTA)
Plug	SLT	STD01, STD02	2.5A/250V	BS 1363 SASO 2203:2018	Intertek (ASTA)
Connector	SLT	STC5, STC7	2.5A/250V	BS 1363 SASO 2203:2018	Intertek (ASTA)
Cable	SLT	H03VV-F, H03VVH2-F	3X0.75mm ²	BS 1363 SASO 2203:2018	Intertek (ASTA)
Plug	HONGLIN	HL-044D, HL-044S	2.5A/250V	BS 1363 SASO 2203:2018	Intertek (ASTA)
Connector	HONGLIN	HL-052D, HL-052S	2.5A/250V	BS 1363 SASO 2203:2018	Intertek (ASTA)
Cable	HONGLIN	H03VV-F	3X0.75mm ²	BS 1363 SASO 2203:2018	Intertek (ASTA)

IEC 62368-1					
Clause	Requirement + Test		Result - Remark		Verdict
Plug	Longwell	LP-61LD, LP-61L, LP-61LH	2.5A/250V	BS 1363 SASO 2203:2018	Intertek (ASTA)
Connector	Longwell	LS-18F, LS-18N, LS-18(LH)	2.5A/250V	BS 1363 SASO 2203:2018	Intertek (ASTA)
Cable	Longwell	H03VV-F, H03Z1Z1-F	3X0.75mm ²	BS 1363 SASO 2203:2018	Intertek (ASTA)
Plug	FRSH	BS-01J	2.5A/250V	BS 1363 SASO 2203:2018	Intertek (ASTA)
Connector	FRSH	CE-608J	2.5A/250V	BS 1363 SASO 2203:2018	Intertek (ASTA)
Cable	FRSH	H03VV-F	3X0.75mm ²	BS 1363 SASO 2203:2018	Intertek (ASTA)
Plug	Interchangeable	Interchangeable	2.5A/250V	BS 1363 SASO 2203:2018	Intertek (ASTA)
Connector	Interchangeable	Interchangeable	2.5A/250V	BS 1363 SASO 2203:2018	Intertek (ASTA)
Cable	Interchangeable	Interchangeable	3X0.75mm ²	BS 1363 SASO 2203:2018	Intertek (ASTA)
Plug	Voletx	MP5004(5A), VPUK13A3	5.0A/250V	BS 1363 SASO 2203:2018	Intertek (ASTA)
Connector	Voletx	V1625, VCC13	5.0A/250V	BS 1363 SASO 2203:2018	Intertek (ASTA)
Cable	Voletx	H05VV-F, H05Z1Z1-F	3X0.75mm ²	BS 1363 SASO 2203:2018	Intertek (ASTA)
Plug	Interchangeable	Interchangeable	5.0A/250V	BS 1363 SASO 2203:2018	Intertek (ASTA)
Connector	Interchangeable	Interchangeable	5.0A/250V	BS 1363 SASO 2203:2018	Intertek (ASTA)

IEC 62368-1					
Clause	Requirement + Test			Result - Remark	Verdict
Cable	Interchangeable	Interchangeable	3X0.75mm ²	BS 1363 SASO 2203:2018	Intertek (ASTA)
Plug	Volex	VNUK13A3, MP5004(10A), MP5004(13A)	10.0A/250V	BS 1363 SASO 2203:2018	Intertek (ASTA)
Connector	Volex	VNC13S, V1625, V1625A	10.0A/250V	BS 1363 SASO 2203:2018	Intertek (ASTA)
Cable	Volex	H05VV-F	3X0.75mm ² 3X1.00mm ²	BS 1363 SASO 2203:2018	Intertek (ASTA)
Plug	SLT	STD01	10.0A/250V	BS 1363 SASO 2203:2018	Intertek (ASTA)
Connector	SLT	STC13	10.0A/250V	BS 1363 SASO 2203:2018	Intertek (ASTA)
Cable	SLT	H05VV-F	3X0.75mm ² 3X1.00mm ²	BS 1363 SASO 2203:2018	Intertek (ASTA)
Plug	HONGLIN	HL-044S	10.0A/250V	BS 1363 SASO 2203:2018	Intertek (ASTA)
Connector	HONGLIN	HL-026S	10.0A/250V	BS 1363 SASO 2203:2018	Intertek (ASTA)
Cable	HONGLIN	H05VV-F	3X0.75mm ² 3X1.00mm ²	BS 1363 SASO 2203:2018	Intertek (ASTA)
Plug	Longwell	LP-61L, LP-61LD, UK LP-61L	10.0A/250V	BS 1363 SASO 2203:2018	Intertek (ASTA)
Connector	Longwell	LS-13G, LS-18F, LS-60, LS-15, LS-13D	10.0A/250V	BS 1363 SASO 2203:2018	Intertek (ASTA)
Cable	Longwell	H05VV-F	3X0.75mm ² 3X1.00mm ²	BS 1363 SASO 2203:2018	Intertek (ASTA)
Plug	FRSH	BS-01J	10.0A/250V	BS 1363 SASO 2203:2018	Intertek (ASTA)

IEC 62368-1					
Clause	Requirement + Test			Result - Remark	Verdict
Connector	FRSH	CE-601J	10.0A/250V	BS 1363 SASO 2203:2018	Intertek (ASTA)
Cable	FRSH	H05VV-F	3X0.75mm ²	BS 1363 SASO 2203:2018	Intertek (ASTA)
Plug	Interchangeable	Interchangeable	10.0A/250V	BS 1363 SASO 2203:2018	Intertek (ASTA)
Connector	Interchangeable	Interchangeable	10.0A/250V	BS 1363 SASO 2203:2018	Intertek (ASTA)
Cable	Interchangeable	Interchangeable	3X0.75mm ² 3X1.00mm ²	BS 1363 SASO 2203:2018	Intertek (ASTA)
Plug	Voilex	MP5004	13.0A/250V	BS 1363 SASO 2203:2018	Intertek (ASTA)
Connector	Voilex	VSC19	13.0A/250V	BS 1363 SASO 2203:2018	Intertek (ASTA)
Cable	Voilex	H05VV-F	3X1.50mm ²	BS 1363 SASO 2203:2018	Intertek (ASTA)
Plug	Interchangeable	Interchangeable	13.0A/250V	BS 1363 SASO 2203:2018	Intertek (ASTA)
Connector	Interchangeable	Interchangeable	13.0A/250V	BS 1363 SASO 2203:2018	Intertek (ASTA)
Cable	Interchangeable	Interchangeable	3X1.50mm ²	BS 1363 SASO 2203:2018	Intertek (ASTA)
Plug	I-Sheng	SP62, SP65	5.0A/250V	BS 1363 SASO 2203:2018	Intertek (ASTA)
Connector	I-Sheng	IS-14	10A/250V	BS 1363 SASO 2203:2018	Intertek (ASTA)
Cable	I-Sheng	H05VV-F	3X0.75mm ²	BS 1363 SASO 2203:2018	Intertek (ASTA)

IEC 62368-1					
Clause	Requirement + Test			Result - Remark	Verdict

Plug	Xuexiang	DTII-3P-14, DTII-3P-22	5.0A/250V	BS 1363 SASO 2203:2018	Intertek (ASTA)
Connector	Xuexiang	DTII-3P-04	10A/250V	BS 1363 SASO 2203:2018	Intertek (ASTA)
Cable	Xuexiang	H05VV-F	3X0.75mm ²	BS 1363 SASO 2203:2018	Intertek (ASTA)
Plug	HongLin	HL-044	5.0A/250V	BS 1363 SASO 2203:2018	Intertek (ASTA)
Connector	HongLin	HL-026	10A/250V	BS 1363 SASO 2203:2018	Intertek (ASTA)
Cable	HongLin	H05VV-F	3X0.75mm ²	BS 1363 SASO 2203:2018	Intertek (ASTA)
Plug	Interchangeable	Interchangeable	5.0A/250V	BS 1363 SASO 2203:2018	Intertek (ASTA)
Connector	Interchangeable	Interchangeable	10A/250V	BS 1363 SASO 2203:2018	Intertek (ASTA)
Cable	Interchangeable	Interchangeable	3X0.75mm ²	BS 1363 SASO 2203:2018	Intertek (ASTA)

Supplementary information:

- 1) Provided evidence ensures the agreed level of compliance. See OD-CB2039.
- 2) In the technical data column of optocoupler, where "Dti" means distance through insulation, "Int. cr" means internal creepage distance, and "Ext. cr" means external creepage distance.

List of test equipment used:

A completed list of used test equipment shall be provided in the Test Reports when a Customer's Testing Facility according to CTF stage 1 or CTF stage 2 procedure has been used.

Note: This page may be removed when CTF stage 1 or CTF stage 2 are not used. See also clause 4.8 in OD 2020 for more details.

Clause	Measurement / testing	Testing / measuring equipment / material used, (Equipment ID)	Range used	Last Calibration date	Calibration due date

Statement of Measurement Uncertainty

The Test Report shall include a statement concerning the uncertainty of the measurement systems used for the tests conducted when it is required by the standard, client or other authorities.
In such cases, the table below is to be used for reporting U of M.

This page may be removed from the final Test Report when not required. See also clause 4.8 in OD 2020 for more details.

Clause #	Parameter/ Measurement / test method	Requirement % or k	Calculated U of M*

*Note: Calculations leading to the reported value are on file with the NCB

IEC 62368-1			
Clause	Requirement + Test	Result - Remark	Verdict
6.4.8.3.3, 6.4.8.3.4 & P.2.2	Table: enclosure openings		P
Location	Size (mm)	Comments	
Internal metal chassis Type A/Type C			
Top	1) Numerous circle openings: Ø 4.7mm. 2) One rectangle opening above power board: 20.8mm x 13.7mm. 3) One rectangle opening above power board: 21.8mm x22.4mm. 4) One rectangle opening above main board: 29.2mm x 16.3mm. 5) One rectangle opening above main board: 21.8mm x22.4mm.	1) Openings do not exceed 5mm in any dimension. No hazards. 2)-3) Openings are covered by V-0 Mylar sheet. No hazards. 4)-5) No opening was fall in Volume of PS3 component shown as Figure 41 & 42 of this standard. No hazards.	
Rear	1) One rectangle opening near power board: 29.3mm x 21.4mm. 2) Four circle openings near power board and main board: Ø3.8mm. 3) One rectangle opening near main board: 50.6mm x 31.4mm.	1) Openings are covered by V-0 Mylar sheet. No hazards. 2)-3) No opening was fall in Volume of PS3 component shown as Figure 41 & 42 of this standard. No hazards.	
Left	One rectangle opening above power board: 29.3mm x 13.9mm.	Openings are covered by V-0 Mylar sheet. No hazards.	
Right	One rectangle opening above main board for wire connected to panel: 50.6mm x 12.5mm.	No opening was fall in Volume of PS3 component shown as Figure 41 & 42 of this standard. No hazards.	
Bottom	Numerous circle openings: Ø 1.9mm under power board, spacing of holes centre to centre: 3.5mm, min. thickness of metal: 0.81mm.	Comply with bottom opening for fire enclosure. Main board is supplied by LPS, not required for fire enclosure.	
Internal metal chassis Type B			

IEC 62368-1			
Clause	Requirement + Test	Result - Remark	Verdict
Top/ Right	1) Numerous circle openings: 2.5mm 2) One oval opening: 49.8mm x 14.2mm	1) Openings do not exceed 3mm in any dimension. No hazards. 2) Opening is covered by V-0 Mylar sheet. No hazards.	
Rear	1) One rectangle opening above power bard: 38.0mm x 17.6mm 2) One rectangle opening above main board: 50.5mm x 30.8mm 3) One circle openings near main board: Ø3.8mm.	1)-3) Opening is covered by V-0 Mylar sheet. No hazards.	
Left/ Top	One rectangle opening above power bard: 38.0mm x 9.0mm	Opening is covered by V-0 Mylar sheet. No hazards.	
Right/ Bottom	1) One rectangle opening above main board: 18.3mm x 12.4mm 2) One rectangle opening above main board: 50.5mm x 20.7mm	1)-2) Opening is covered by V-0 Mylar sheet. No hazards.	
Bottom/ Right	Under power board side: Numerous Ø1.70mm holes; spacing of holes (centre to centre): 3.9mm; thickness of metal: min.0.81mm;	Comply with bottom opening for fire enclosure. Main board is supplied by LPS, not required for fire enclosure.	
Internal metal chassis Type C			
Top/ Right	1) Numerous circle openings: 2.5mm. 2) One rectangle opening above main board: 39.2mm x 14.2mm	1) Openings do not exceed 3mm in any dimension. No hazards. 2) Opening is covered by V-0 Mylar sheet. No hazards.	
Rear	1) Two circle openings near main board: Ø3.8mm. 2) One rectangle opening near power board: 50.8mm x 17.5mm. 3) One rectangle opening near main board: 66.3mm x 30.0mm.	1)-3) Opening is covered by V-0 Mylar sheet. No hazards.	

IEC 62368-1			
Clause	Requirement + Test	Result - Remark	Verdict
Left/ Top	One rectangle opening above power board: 50.8mm x 13.6mm	Opening is covered by V-0 Mylar sheet. No hazards.	
Right/ Bottom	One rectangle opening above main board for wire connected to panel: 66.3mm x 21.4mm	Opening is covered by V-0 Mylar sheet. No hazards.	
Bottom/ Right	Numerous circle openings: Ø 1.5mm under power board, spacing of holes centre to centre: 3.5mm, min. thickness of metal: 0.81mm.	Comply with bottom opening for fire enclosure.	

G.5.3.2	TABLE: transformers						P
Loc.	Tested insulation	Working voltage peak / V	Working voltage rms / V	Required electric strength	Required clearance / mm	Required creepage distance / mm	Required distance thr. insul.
T9102	Input terminal to output winding (RI)	575	330	AC 4000V	4.5	6.6	Min. 2 layers tape
T9102	Input terminal to output terminal (RI)	575	330	AC 4000V	4.5	6.6	Min. 2 layers tape
T9102	Input winding to output winding (RI)	575	330	AC 4000V	4.5	6.6	Min. 2 layers tape
T9102	Input winding to output terminal (RI)	575	330	AC 4000V	4.5	6.6	Min. 2 layers tape
T9102	Output winding to Core (RI)	575	330	AC 4000V	4.5	6.6	Min. 2 layers tape
T9102	Output terminal to Core (RI)	575	330	AC 4000V	4.5	6.6	Min. 2 layers tape
Loc.	Tested insulation			Test voltage / V	Measured clearance / mm	Measured creepage dist. / mm	Measured distance thr. insul. / mm; number of layers

IEC 62368-1					
Clause	Requirement + Test	Result - Remark			Verdict
T9102	Input terminal to output winding (RI)	AC 4000V	Triple insulation wire used on secondary windings	Triple insulation wire used on secondary windings	--
T9102	Input terminal to output terminal (RI)	AC 4000V	54.7	54.7	--
T9102	Input winding to output winding (RI)	AC 4000V	Triple insulation wire used on secondary windings	Triple insulation wire used on secondary windings	--
T9102	Input winding to output terminal (RI)	AC 4000V	8.4	8.4	--
T9102	Output winding to Core (RI)	AC 4000V	Triple insulation wire used on secondary windings	Triple insulation wire used on secondary windings	--
T9102	Output terminal to Core (RI)	AC 4000V	9.3	9.3	--
Supplementary information:					
1. The constructions of all sources of transformer are identical, only model designation, manufacturer, and the material of bobbin are different.					
2. The required clearances multiplied by 1.48 considering that EUT operates up to 5000m.					

IEC 62368-1			
Clause	Requirement + Test	Result - Remark	Verdict

G.5.3.2 **TABLE: transformers** **P**

Transformer:

3. Mechanical Characteristics

3.1 Dimensions

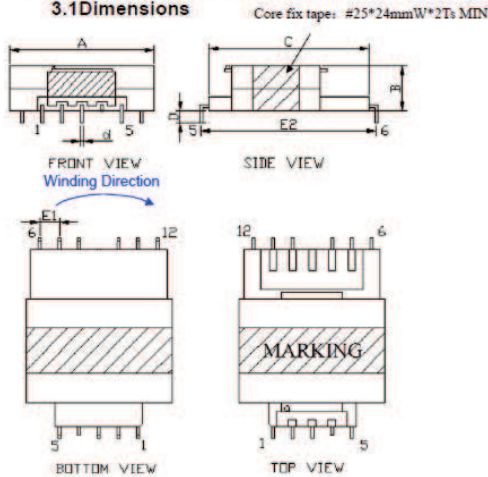

- NOTE: 1. Lead Wire Composition
 Steel 78%
 Cu 22%
2. Sn 99.99% (Thickness 0.12mm)
 Lead Free Solder
 Sn 98% Cu 2%
3. GAP COR TO TOP SIDE
 4. PDN Cut Off, PDN Cut Off 1/2 after soldering
 5. CORE 中柱點膠
 6. 引腳排 PIN 兩數
 配線 ALL PIN 1.0T MIN
 6. Weight: 61.5 ± 2g (1PC)
 EPOXY(軟膠)

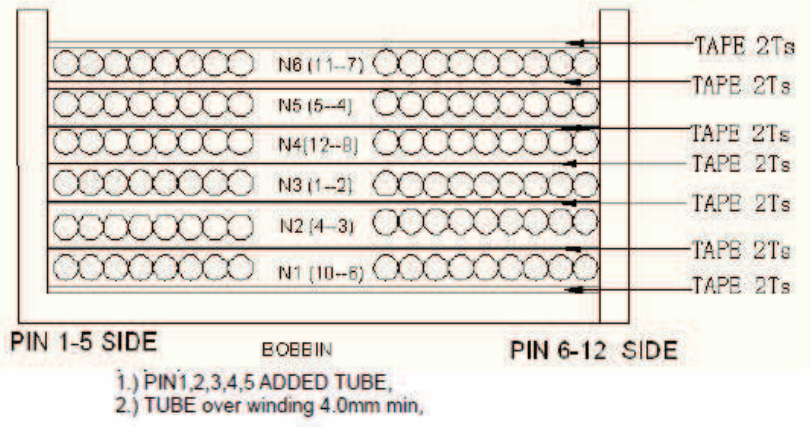
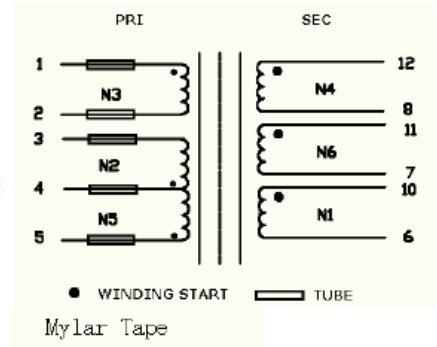

3.6 Winding mode:

NO.	Winding	Terminal	Wire	Turns	Remark	TAPE
						2Ts
1	N1	10-6	TIW-M φ0.50*2	5	CLOSED	2Ts
2	N2	4-3	UEW φ0.30	13	CLOSED	2Ts
3	N3	1-2	UEW φ0.20	4	CLOSED	2Ts
4	N4	12-8	TIW-M φ0.50*2	5	CLOSED	2Ts
5	N5	5-4	UEW φ0.30	13	CLOSED	2Ts
6	N6	11-7	TIW-M φ0.50*2	5	CLOSED	2Ts

Concentric windings on phenolic bobbin. Three layers of insulation tape are provided around outer winding and outer winding is primary. Three layers of insulation tape are provided between the primary windings and secondary windings. The core is considered as floating part. At least 4.2mm margin tape at both primary solder pin side and secondary solder pin side. All winding leads are covered by tube.

IEC 62368-1			
Clause	Requirement + Test	Result - Remark	Verdict

G.5.3.2	TABLE: transformers							P
Loc.	Tested insulation	Working voltage peak / V	Working voltage rms / V	Required electric strength	Required clearance / mm	Required creepage distance / mm	Required distance thr. insul.	
T901	Input terminal to output winding (RI)	556	290	AC 4000V	4.5	5.8	Min. 2 layers tape	
T901	Input terminal to output terminal (RI)	556	290	AC 4000V	4.5	5.8	Min. 2 layers tape	
T901	Input winding to output winding (RI)	556	290	AC 4000V	4.5	5.8	Min. 2 layers tape	
T901	Input winding to output terminal (RI)	556	290	AC 4000V	4.5	5.8	Min. 2 layers tape	
T901	Output winding to Core (RI)	556	290	AC 4000V	4.5	5.8	Min. 2 layers tape	
T901	Output terminal to Core (RI)	556	290	AC 4000V	4.5	5.8	Min. 2 layers tape	
Loc.	Tested insulation			Test voltage / V	Measured clearance / mm	Measured creepage dist. / mm	Measured distance thr. insul. / mm; number of layers	
T901	Input terminal to output winding (RI)			AC 4000V	Triple insulation wire used on secondary windings	Triple insulation wire used on secondary windings	--	
T901	Input terminal to output terminal (RI)			AC 4000V	37	37	--	
T901	Input winding to output winding (RI)			AC 4000V	Triple insulation wire used on secondary windings	Triple insulation wire used on secondary windings	--	
T901	Input winding to output terminal (RI)			AC 4000V	9.0	9.0	--	

IEC 62368-1					
Clause	Requirement + Test	Result - Remark		Verdict	

T901	Output winding to Core (RI)	AC 4000V	Triple insulation wire used on secondary windings	Triple insulation wire used on secondary windings	--
T901	Output terminal to Core (RI)	AC 4000V	8.3	8.3	--

Supplementary information:

1. All sources of transformer were checked with same construction.
2. The required clearances multiplied by 1.48 considering that EUT operates up to 5000m.

G.5.3.2	TABLE: transformers	P
Transformer:		
<p>N2 绕组需在此槽进出线，且 TUBE 需大於溝槽，以避免 2 線短路</p> <p>Tape: t0.025mm*13.0mmW*2Ts</p> <p>FRONT VIEW SIDE VIEW</p> <p>BOTTOM VIEW TOP VIEW</p> <p>Winding Direction</p> <p>MARKING</p> <p>NOTE: 1. Lead Wire Composition Steel 78% Cu 22% Sn 99.99% (Thickness $6^{+2}_{-1} \mu$) Lead Free Solder Sn 98% Cu 2%</p> <p>2. GAP CORE ON THE PIN SIDE 3. PIN2 cut off 2/3 after soldering 4. 引脚挂 PIN 圈数 配线 ALL PIN 1.0T MIN 6. CORE 中柱點膠. 7. Weight: 38.2±2g (1PC)</p>		

IEC 62368-1			
Clause	Requirement + Test	Result - Remark	Verdict

PIN	TUBE LENGTH
1,2	25mm MIN
4,5	22mm MIN
6,8	20mm MIN
9,10	20mm MIN
2,3	20mm MIN

NOTE:

1. EVERY LEAD WIRE MUST HAVE FIX TAPE.
2. ALL PINS ADD TUBE, THE TUBE MUST BE OVER MARGIN TAPE.

NO.	Winding	Terminal	Wire	Turns	Remark	MARGIN mm	TAPE 2Ts
1	N1	1-2	UEW $\varnothing 0.40 \times 1$	14	CLOSED	/	1T
2	N2	5-4	UEW $\varnothing 0.20 \times 2$	6	CLOSED	/	1T
3	N3	6-8	TIW-M $\varnothing 0.55 \times 2$	2	CLOSED	/	1T
4	N4	9-10	TIW-M $\varnothing 0.45 \times 2$	4	CLOSED	/	1T
6	N5	2-3	UEW $\varnothing 0.40 \times 1$	14	CLOSED	/	3T

Concentric windings on phenolic bobbin. Three layers of insulation tape are provided around outer winding and outer winding is primary. Triple insulated wire used for secondary, therefore core is considered as primary. All winding leads are covered by tube.

IEC62368_1E ATTACHMENT			
Clause	Requirement + Test	Result - Remark	Verdict

ATTACHMENT TO TEST REPORT
IEC 62368-1
EUROPEAN GROUP DIFFERENCES AND NATIONAL DIFFERENCES
 (Audio/video, information and communication technology equipment - Part 1: Safety requirements)

Differences according to : EN IEC 62368-1:2020+A11:2020

Attachment Form No. : EU_GD_IEC62368_1E

Attachment Originator..... : UL(Demko)

Master Attachment : 2021-02-04

Copyright © 2021 IEC System for Conformity Testing and Certification of Electrical Equipment (IECEE), Geneva, Switzerland. All rights reserved.

CENELEC COMMON MODIFICATIONS (EN)										
	<p>Clause numbers in the cells that are shaded light grey are clause references in EN IEC 62368-1:2020+A11:2020. All other clause numbers in that column, except for those in the paragraph below, refers to IEC 62368-1:2018.</p> <p>Clauses, subclauses, notes, tables, figures and annexes which are additional to those in IEC 62368-1:2018 are prefixed "Z".</p>	P								
	<p>Add the following annexes:</p> <table border="0"> <tr> <td>Annex ZA (normative)</td> <td>Normative references to international publications with their corresponding European publications</td> </tr> <tr> <td>Annex ZB (normative)</td> <td>Special national conditions</td> </tr> <tr> <td>Annex ZC (informative)</td> <td>A-deviations</td> </tr> <tr> <td>Annex ZD (informative)</td> <td>IEC and CENELEC code designations for flexible cords</td> </tr> </table>	Annex ZA (normative)	Normative references to international publications with their corresponding European publications	Annex ZB (normative)	Special national conditions	Annex ZC (informative)	A-deviations	Annex ZD (informative)	IEC and CENELEC code designations for flexible cords	P
Annex ZA (normative)	Normative references to international publications with their corresponding European publications									
Annex ZB (normative)	Special national conditions									
Annex ZC (informative)	A-deviations									
Annex ZD (informative)	IEC and CENELEC code designations for flexible cords									
1	Modification to Clause 3 .									
3.3.19	<p>Sound exposure</p> <p><i>Replace 3.3.19 of IEC 62368-1 with the following definitions:</i></p>	N/A								

IEC62368_1E ATTACHMENT			
Clause	Requirement + Test	Result - Remark	Verdict
3.3.19.1	<p>momentary exposure level, MEL</p> <p>metric for estimating 1 s sound exposure level from the HD 483-1 S2 test signal applied to both channels, based on EN 50332-1:2013, 4.2.</p> <p>Note 1 to entry: MEL is measured as A-weighted levels in dB. Note 2 to entry: See B.3 of EN 50332-3:2017 for additional information.</p>	Considered.	N/A
3.3.19.3	<p>sound exposure, E</p> <p>A-weighted sound pressure (p) squared and integrated over a stated period of time, T</p> <p>Note 1 to entry: The SI unit is Pa² s.</p> $E = \int_0^T p(t)^2 dt$		N/A
3.3.19.4	<p>sound exposure level, SEL</p> <p>logarithmic measure of sound exposure relative to a reference value, E_0, typically the 1 kHz threshold of hearing in humans.</p> <p>Note 1 to entry: SEL is measured as A-weighted levels in dB.</p> $SEL = 10 \lg \left(\frac{E}{E_0} \right) \text{ dB}$ <p>Note 2 to entry: See B.4 of EN 50332-3:2017 for additional information.</p>		N/A
3.3.19.5	<p>digital signal level relative to full scale, dBFS</p> <p>levels reported in dBFS are always r.m.s. Full scale level, 0 dBFS, is the level of a dc-free 997-Hz sine wave whose undithered positive peak value is positive digital full scale, leaving the code corresponding to negative digital full scale unused</p> <p>Note 1 to entry: It is invalid to use dBFS for non-r.m.s. levels. Because the definition of full scale is based on a sine wave, the level of signals with a crest factor lower than that of a sine wave may exceed 0 dBFS. In particular, square wave signals may reach +3,01 dBFS.</p>		N/A
2	Modification to Clause 10		
10.6	<p>Safeguards against acoustic energy sources</p> <p>Replace 10.6 of IEC 62368-1 with the following:</p>		N/A

IEC62368_1E ATTACHMENT			
Clause	Requirement + Test	Result - Remark	Verdict
10.6.1.1	<p>Introduction</p> <p>Safeguard requirements for protection against long-term exposure to excessive sound pressure levels from personal music players closely coupled to the ear are specified below. Requirements for earphones and headphones intended for use with personal music players are also covered. A personal music player is a portable equipment intended for use by an ordinary person, that:</p> <ul style="list-style-type: none"> – is designed to allow the user to listen to audio or audiovisual content / material; and – uses a listening device, such as headphones or earphones that can be worn in or on or around the ears; and – has a player that can be body worn (of a size suitable to be carried in a clothing pocket) and is intended for the user to walk around with while in continuous use (for example, on a street, in a subway, at an airport, etc.). <p>EXAMPLES Portable CD players, MP3 audio players, mobile phones with MP3 type features, PDAs or similar equipment.</p> <p>Personal music players shall comply with the requirements of either 10.6.2 or 10.6.3.</p> <p>NOTE 1 Protection against acoustic energy sources from telecom applications is referenced to ITU-T P.360.</p> <p>NOTE 2 It is the intention of the Committee to allow the alternative methods for now, but to only use the dose measurement method as given in 10.6.5 in future. Therefore, manufacturers are encouraged to implement 10.6.5 as soon as possible.</p> <p>Listening devices sold separately shall comply with the requirements of 10.6.6.</p> <p>These requirements are valid for music or video mode only.</p> <p>The requirements do not apply to:</p> <ul style="list-style-type: none"> – professional equipment; <p>NOTE 3 Professional equipment is equipment sold through special sales channels. All products sold through normal electronics stores are considered not to be professional equipment.</p> <ul style="list-style-type: none"> – hearing aid equipment and other devices for assistive listening; – the following type of analogue personal music 	No such consideration for the purpose of personal music players.	N/A

IEC62368_1E ATTACHMENT			
Clause	Requirement + Test	Result - Remark	Verdict
	<p>players:</p> <ul style="list-style-type: none"> • long distance radio receiver (for example, a multiband radio receiver or world band radio receiver, an AM radio receiver), and • cassette player/recorder; <p>NOTE 4 This exemption has been allowed because this technology is falling out of use and it is expected that within a few years it will no longer exist. This exemption will not be extended to other technologies.</p> <p>– a player while connected to an external amplifier that does not allow the user to walk around while in use.</p> <p>For equipment that is clearly designed or intended primarily for use by children, the limits of the relevant toy standards may apply.</p> <p>The relevant requirements are given in EN 71-1:2011, 4.20 and the related tests methods and measurement distances apply.</p>		
10.6.1.2	<p>Non-ionizing radiation from radio frequencies in the range 0 to 300 GHz</p> <p>The amount of non-ionizing radiation is regulated by European Council Recommendation 1999/519/EC of 12 July 1999 on the limitation of exposure of the general public to electromagnetic fields (0 Hz to 300 GHz).</p> <p>For intentional radiators, ICNIRP guidelines should be taken into account for Limiting Exposure to Time-Varying Electric, Magnetic, and Electromagnetic Fields (up to 300 GHz). For hand-held and body mounted devices, attention is drawn to EN 50360 and EN 50566.</p>		N/A
10.6.2	<p>Classification of devices without the capacity to estimate sound dose</p>		N/A
10.6.2.1	<p>General</p> <p>This standard is transitioning from short-term based (30 s) requirements to long-term based (40 hour) requirements. These clauses remain in effect only for devices that do not comply with sound dose estimation as stipulated in EN 50332-3.</p> <p>For classifying the acoustic output $L_{Aeq,T}$, measurements are based on the A-weighted equivalent sound pressure level over a 30 s period.</p> <p>For music where the average sound pressure (long term $L_{Aeq,T}$) measured over the duration of the</p>		N/A

IEC62368_1E ATTACHMENT			
Clause	Requirement + Test	Result - Remark	Verdict
	<p>song is lower than the average produced by the programme simulation noise, measurements may be done over the duration of the complete song. In this case, T becomes the duration of the song.</p> <p>NOTE Classical music, acoustic music and broadcast typically has an average sound pressure (long term $L_{Aeq,T}$) which is much lower than the average programme simulation noise. Therefore, if the player is capable to analyse the content and compare it with the programme simulation noise, the warning does not need to be given as long as the average sound pressure of the song does not exceed the required limit.</p> <p>For example, if the player is set with the programme simulation noise to 85 dB, but the average music level of the song is only 65 dB, there is no need to give a warning or ask an acknowledgement as long as the average sound level of the song is not above the basic limit of 85 dB.</p>		
10.6.2.2	<p>RS1 limits (to be superseded, see 10.6.3.2)</p> <p>RS1 is a class 1 acoustic energy source that does not exceed the following:</p> <ul style="list-style-type: none"> – for equipment provided as a package (player with its listening device), and with a proprietary connector between the player and its listening device, or where the combination of player and listening device is known by other means such as setting or automatic detection, the $L_{Aeq,T}$ acoustic output shall be ≤ 85 dB when playing the fixed “programme simulation noise” described in EN 50332-1. – for equipment provided with a standardized connector (for example, a 3,5 phone jack) that allows connection to a listening device for general use, the unweighted r.m.s. output voltage shall be ≤ 27 mV (analogue interface) or -25 dBFS (digital interface) when playing the fixed “programme simulation noise” described in EN 50332-1. – The RS1 limits will be updated for all devices as per 10.6.3.2. 		N/A
10.6.2.3	<p>RS2 limits (to be superseded, see 10.6.3.3)</p> <p>RS2 is a class 2 acoustic energy source that does not exceed the following:</p> <ul style="list-style-type: none"> – for equipment provided as a package (player with its listening device), and with a proprietary connector between the player and its listening device, or when the combination of player and listening device is known by other means such as setting or automatic 130 detection, the $L_{Aeq,T}$ acoustic output shall be ≤ 100 dB(A) when playing the fixed “programme simulation noise” as described in EN 50332-1. – for equipment provided with a standardized connector (for example, a 3,5 phone jack) that allows connection to a listening device for general 		N/A

IEC62368_1E ATTACHMENT			
Clause	Requirement + Test	Result - Remark	Verdict
	use, the unweighted r.m.s. output voltage shall be ≤ 150 mV (analogue interface) or -10 dBFS (digital interface) when playing the fixed "programme simulation noise" as described in EN 50332-1.		
10.6.2.4	RS3 limits RS3 is a class 3 acoustic energy source that exceeds RS2 limits.		N/A
10.6.3	Classification of devices (new)		N/A
10.6.3.1	General Previous limits (10.6.2) created abundant false negative and false positive PMP sound level warnings. New limits, compliant with The Commission Decision of 23 June 2009, are given below.		N/A
10.6.3.2	RS1 limits (new) RS1 is a class 1 acoustic energy source that does not exceed the following: – for equipment provided as a package (player with its listening device), and with a proprietary connector between the player and its listening device, or where the combination of player and listening device is known by other means such as setting or automatic detection, the $L_{Aeq,T}$ acoustic output shall be ≤ 80 dB when playing the fixed "programme simulation noise" described in EN 50332-1. – for equipment provided with a standardized connector (for example, a 3,5 phone jack) that allows connection to a listening device for general use, the unweighted r.m.s. output voltage shall be ≤ 15 mV (analogue interface) or -30 dBFS (digital interface) when playing the fixed "programme simulation noise" described in EN 50332-1.		N/A
10.6.3.3	RS2 limits (new) RS2 is a class 2 acoustic energy source that does not exceed the following: – for equipment provided as a package (player with its listening device), and with a proprietary connector between the player and its listening device, or where the combination of player and listening device is known by other means such as setting or automatic detection, the weekly sound exposure level, as described in EN 50332-3, shall be ≤ 80 dB when playing the fixed "programme simulation noise" described in EN 50332-1. – for equipment provided with a standardized connector (for example, a 3,5 phone jack) that		N/A

IEC62368_1E ATTACHMENT			
Clause	Requirement + Test	Result - Remark	Verdict
	allows connection to a listening device for general use, the unweighted r.m.s. output level, integrated over one week, as described in EN50332-3, shall be ≤ 15 mV (analogue interface) or -30 dBFS (digital interface) when playing the fixed “programme simulation noise” described in EN 50332-1.		
10.6.4	Requirements for maximum sound exposure		N/A
10.6.4.1	<p>Measurement methods</p> <p>All volume controls shall be turned to maximum during tests.</p> <p>Measurements shall be made in accordance with EN 50332-1 or EN 50332-2 as applicable.</p>		N/A
10.6.4.2	<p>Protection of persons</p> <p>Except as given below, protection requirements for parts accessible to ordinary persons, instructed persons and skilled persons are given in 4.3.</p> <p>NOTE 1 Volume control is not considered a safeguard.</p> <p>Between RS2 and an ordinary person, the basic safeguard may be replaced by an instructional safeguard in accordance with Clause F.5, except that the instructional safeguard shall be placed on the equipment, or on the packaging, or in the instruction manual.</p> <p>Alternatively, the instructional safeguard may be given through the equipment display during use.</p> <p>The elements of the instructional safeguard shall be as follows:</p> <p>– element 1a: the symbol  IEC 60417-6044 (2011-01)</p> <p>– element 2: “High sound pressure” or equivalent wording</p> <p>– element 3: “Hearing damage risk” or equivalent wording</p> <p>– element 4: “Do not listen at high volume levels for long periods.” or equivalent wording</p> <p>An equipment safeguard shall prevent exposure of an ordinary person to an RS2 source without intentional physical action from the ordinary person and shall automatically return to an output level not exceeding what is specified for an RS1 source when the power is switched off.</p>		N/A

IEC62368_1E ATTACHMENT			
Clause	Requirement + Test	Result - Remark	Verdict
	<p>The equipment shall provide a means to actively inform the user of the increased sound level when the equipment is operated with an output exceeding RS1. Any means used shall be acknowledged by the user before activating a mode of operation which allows for an output exceeding RS1. The acknowledgement does not need to be repeated more than once every 20 h of cumulative listening time.</p> <p>NOTE 2 Examples of means include visual or audible signals. Action from the user is always needed.</p> <p>NOTE 3 The 20 h listening time is the accumulative listening time, independent of how often and how long the personal music player has been switched off.</p> <p>A skilled person shall not be unintentionally exposed to RS3.</p>		
10.6.5	Requirements for dose-based systems		N/A
10.6.5.1	<p>General requirements</p> <p>Personal music players shall give the warnings as provided below when tested according to EN 50332-3, using the limits from this clause.</p> <p>The manufacturer may offer optional settings to allow the users to modify when and how they wish to receive the notifications and warnings to promote a better user experience without defeating the safeguards. This allows the users to be informed in a method that best meets their physical capabilities and device usage needs. If such optional settings are offered, an administrator (for example, parental restrictions, business/educational administrators, etc.) shall be able to lock any optional settings into a specific configuration.</p> <p>The personal music player shall be supplied with easy to understand explanation to the user of the dose management system, the risks involved, and how to use the system safely. The user shall be made aware that other sources may significantly contribute to their sound exposure, for example work, transportation, concerts, clubs, cinema, car races, etc.</p>		N/A
10.6.5.2	<p>Dose-based warning and requirements</p> <p>When a dose of 100 % <i>CSD</i> is reached, and at least at every 100 % further increase of <i>CSD</i>, the device shall warn the user and require an</p>		N/A

IEC62368_1E ATTACHMENT			
Clause	Requirement + Test	Result - Remark	Verdict
	<p>acknowledgement. In case the user does not acknowledge, the output level shall automatically decrease to compliance with class RS1.</p> <p>The warning shall at least clearly indicate that listening above 100 % CSD leads to the risk of hearing damage or loss.</p>		
10.6.5.3	<p>Exposure-based requirements</p> <p>With only dose-based requirements, cause and effect could be far separated in time, defying the purpose of educating users about safe listening practice. In addition to dose-based requirements, a PMP shall therefore also put a limit to the short-term sound level a user can listen at.</p> <p>The exposure-based limiter (EL) shall automatically reduce the sound level not to exceed 100 dB(A) or 150 mV integrated over the past 180 s, based on methodology defined in EN 50332-3.</p> <p>The EL settling time (time from starting level reduction to reaching target output) shall be 10 s or faster.</p> <p>Test of EL functionality is conducted according to EN 50332-3, using the limits from this clause. For equipment provided as a package (player with its listening device), the level integrated over 180 s shall be 100 dB or lower. For equipment provided with a standardized connector, the unweighted level integrated over 180 s shall be no more than 150 mV for an analogue interface and no more than -10 dBFS for a digital interface.</p> <p>NOTE In case the source is known not to be music (or test signal), the EL may be disabled.</p>		N/A

IEC62368_1E ATTACHMENT			
Clause	Requirement + Test	Result - Remark	Verdict
10.6.6	Requirements for listening devices (headphones, earphones, etc.)		N/A
10.6.6.1	<p>Corded listening devices with analogue input</p> <p>With 94 dB L_{Aeq} acoustic pressure output of the listening device, and with the volume and sound settings in the listening device (for example, built-in volume level control, additional sound features like equalization, etc.) set to the combination of positions that maximize the measured acoustic output, the input voltage of the listening device when playing the fixed “programme simulation noise” as described in EN 50332-1 shall be ≥ 75 mV.</p> <p>NOTE The values of 94 dB and 75 mV correspond with 85 dB and 27 mV or 100 dB and 150 mV.</p>		N/A
10.6.6.2	<p>Corded listening devices with digital input</p> <p>With any playing device playing the fixed “programme simulation noise” described in EN 50332-1, and with the volume and sound settings in the listening device (for example, built-in volume level control, additional sound features like equalization, etc.) set to the combination of positions that maximize the measured acoustic output, the $L_{Aeq,T}$ acoustic output of the listening device shall be ≤ 100 dB with an input signal of -10 dBFS.</p>		N/A
10.6.6.3	<p>Cordless listening devices</p> <p>In cordless mode,</p> <ul style="list-style-type: none"> – with any playing and transmitting device playing the fixed programme simulation noise described in EN 50332-1; and – respecting the cordless transmission standards, where an air interface standard exists that specifies the equivalent acoustic level; and – with volume and sound settings in the receiving device (for example, built-in volume level control, additional sound features like equalization, etc.) set to the combination of positions that maximize the measured acoustic output for the above mentioned programme simulation noise, the $L_{Aeq,T}$ acoustic output of the listening device shall be ≤ 100 dB with an input signal of -10 dBFS. 		N/A
10.6.6.4	<p>Measurement method</p> <p><i>Measurements shall be made in accordance with EN 50332-2 as applicable.</i></p>		
3	Modification to the whole document		

IEC62368_1E ATTACHMENT			
Clause	Requirement + Test	Result - Remark	Verdict

	<p>Delete all the “country” notes in the reference document according to the following list:</p> <table border="1" style="width:100%; border-collapse: collapse; margin-top: 10px;"> <tr> <td style="width: 15%;">0.2.1</td> <td style="width: 15%;">Note 1 and 2</td> <td style="width: 15%;">1</td> <td style="width: 15%;">Note 4 and 5</td> <td style="width: 15%;">3.3.8.1</td> <td style="width: 15%;">Note 2</td> </tr> <tr> <td>3.3.8.3</td> <td>Note 1</td> <td>4.1.15</td> <td>Note</td> <td>4.7.3</td> <td>Note 1 and 2</td> </tr> <tr> <td>5.2.2.2</td> <td>Note</td> <td>5.4.2.3.2.2 Table 12</td> <td>Note c</td> <td>5.4.2.3.2.4</td> <td>Note 1 and 3</td> </tr> <tr> <td>5.4.2.3.2.4 Table 13</td> <td>Note 2</td> <td>5.4.2.5</td> <td>Note 2</td> <td>5.4.5.1</td> <td>Note</td> </tr> <tr> <td>5.4.10.2.1</td> <td>Note</td> <td>5.4.10.2.2</td> <td>Note</td> <td>5.4.10.2.3</td> <td>Note</td> </tr> <tr> <td>5.5.2.1</td> <td>Note</td> <td>5.5.6</td> <td>Note</td> <td>5.6.4.2.1</td> <td>Note 2 and 3 and 4</td> </tr> <tr> <td>5.6.8</td> <td>Note 2</td> <td>5.7.6</td> <td>Note</td> <td>5.7.7.1</td> <td>Note 1 and Note 2</td> </tr> <tr> <td>8.5.4.2.3</td> <td>Note</td> <td>10.2.1 Table 39</td> <td>Note 3 and 4 and 5</td> <td>10.5.3</td> <td>Note 2</td> </tr> <tr> <td>10.6.1</td> <td>Note 3</td> <td>F.3.3.6</td> <td>Note 3</td> <td>Y.4.1</td> <td>Note</td> </tr> <tr> <td>Y.4.5</td> <td>Note</td> <td></td> <td></td> <td></td> <td></td> </tr> </table>	0.2.1	Note 1 and 2	1	Note 4 and 5	3.3.8.1	Note 2	3.3.8.3	Note 1	4.1.15	Note	4.7.3	Note 1 and 2	5.2.2.2	Note	5.4.2.3.2.2 Table 12	Note c	5.4.2.3.2.4	Note 1 and 3	5.4.2.3.2.4 Table 13	Note 2	5.4.2.5	Note 2	5.4.5.1	Note	5.4.10.2.1	Note	5.4.10.2.2	Note	5.4.10.2.3	Note	5.5.2.1	Note	5.5.6	Note	5.6.4.2.1	Note 2 and 3 and 4	5.6.8	Note 2	5.7.6	Note	5.7.7.1	Note 1 and Note 2	8.5.4.2.3	Note	10.2.1 Table 39	Note 3 and 4 and 5	10.5.3	Note 2	10.6.1	Note 3	F.3.3.6	Note 3	Y.4.1	Note	Y.4.5	Note						N/A
0.2.1	Note 1 and 2	1	Note 4 and 5	3.3.8.1	Note 2																																																										
3.3.8.3	Note 1	4.1.15	Note	4.7.3	Note 1 and 2																																																										
5.2.2.2	Note	5.4.2.3.2.2 Table 12	Note c	5.4.2.3.2.4	Note 1 and 3																																																										
5.4.2.3.2.4 Table 13	Note 2	5.4.2.5	Note 2	5.4.5.1	Note																																																										
5.4.10.2.1	Note	5.4.10.2.2	Note	5.4.10.2.3	Note																																																										
5.5.2.1	Note	5.5.6	Note	5.6.4.2.1	Note 2 and 3 and 4																																																										
5.6.8	Note 2	5.7.6	Note	5.7.7.1	Note 1 and Note 2																																																										
8.5.4.2.3	Note	10.2.1 Table 39	Note 3 and 4 and 5	10.5.3	Note 2																																																										
10.6.1	Note 3	F.3.3.6	Note 3	Y.4.1	Note																																																										
Y.4.5	Note																																																														
4	Modification to Clause 1																																																														
1	<p>Add the following note:</p> <p><i>NOTE Z1 The use of certain substances in electrical and electronic equipment is restricted within the EU: see Directive 2011/65/EU.</i></p>	Added.	P																																																												

IEC62368_1E ATTACHMENT			
Clause	Requirement + Test	Result - Remark	Verdict
5	Modification to 4.Z1		
4.Z1	<p>Add the following new subclause after 4.9:</p> <p>To protect against excessive current, short-circuits and earth faults in circuits connected to an a.c. mains, protective devices shall be included either as integral parts of the equipment or as parts of the building installation, subject to the following, a), b) and c):</p> <p>a) except as detailed in b) and c), protective devices necessary to comply with the requirements of B.3.1 and B.4 shall be included as parts of the equipment;</p> <p>b) for components in series with the mains input to the equipment such as the supply cord, appliance coupler, r.f.i. filter and switch, short-circuit and earth fault protection may be provided by protective devices in the building installation;</p> <p>c) it is permitted for pluggable equipment type B or permanently connected equipment, to rely on dedicated overcurrent and short-circuit protection in the building installation, provided that the means of protection, e.g. fuses or circuit breakers, is fully specified in the installation instructions.</p> <p>If reliance is placed on protection in the building installation, the installation instructions shall so state, except that for pluggable equipment type A the building installation shall be regarded as providing protection in accordance with the rating of the wall socket outlet.</p>	Replaced.	P
6	Modification to 5.4.2.3.2.4		
5.4.2.3.2.4	<p>Add the following to the end of this subclause:</p> <p>The requirement for interconnection with external circuit is in addition given in EN 50491-3:2009.</p>	Added.	N/A
7	Modification to 10.2.1		
10.2.1	<p>Add the following to ^{c)} and ^{d)} in table 39:</p> <p>For additional requirements, see 10.5.1.</p>	No such radiation from the equipment.	N/A

IEC62368_1E ATTACHMENT			
Clause	Requirement + Test	Result - Remark	Verdict
8	Modification to 10.5.1		
10.5.1	<p>Add the following after the first paragraph:</p> <p>For RS 1 compliance is checked by measurement under the following conditions:</p> <p>In addition to the normal operating conditions, all controls adjustable from the outside by hand, by any object such as a tool or a coin, and those internal adjustments or pre-sets which are not locked in a reliable manner, are adjusted so as to give maximum radiation whilst maintaining an intelligible picture for 1 h, at the end of which the measurement is made.</p> <p>NOTE Z1 Soldered joints and paint lockings are examples of adequate locking.</p> <p>The dose-rate is determined by means of a radiation monitor with an effective area of 10 cm², at any point 10 cm from the outer surface of the apparatus.</p> <p>Moreover, the measurement shall be made under fault conditions causing an increase of the high voltage, provided an intelligible picture is maintained for 1 h, at the end of which the measurement is made.</p> <p>For RS1, the dose-rate shall not exceed 1 μSv/h taking account of the background level.</p> <p>NOTE Z2 These values appear in Directive 96/29/Euratom of 13 May 1996.</p>	LED indicator used.	N/A
9	Modification to G.7.1		
G.7.1	<p>Add the following note:</p> <p>NOTE Z1 The harmonized code designations corresponding to the IEC cord types are given in Annex ZD.</p>		P

IEC62368_1E ATTACHMENT			
Clause	Requirement + Test	Result - Remark	Verdict
10	Modification to Bibliography		
	<p>Add the following notes for the standards indicated:</p> <p>IEC 60130-9 NOTE Harmonized as EN 60130-9. IEC 60269-2 NOTE Harmonized as HD 60269-2. IEC 60309-1 NOTE Harmonized as EN 60309-1. IEC 60364 NOTE some parts harmonized in HD 384/HD 60364 series. IEC 60601-2-4 NOTE Harmonized as EN 60601-2-4. IEC 60664-5 NOTE Harmonized as EN 60664-5. IEC 61032:1997 NOTE Harmonized as EN 61032:1998 (not modified). IEC 61508-1 NOTE Harmonized as EN 61508-1. IEC 61558-2-1 NOTE Harmonized as EN 61558-2-1. IEC 61558-2-4 NOTE Harmonized as EN 61558-2-4. IEC 61558-2-6 NOTE Harmonized as EN 61558-2-6. IEC 61643-1 NOTE Harmonized as EN 61643-1. IEC 61643-21 NOTE Harmonized as EN 61643-21. IEC 61643-311 NOTE Harmonized as EN 61643-311. IEC 61643-321 NOTE Harmonized as EN 61643-321. IEC 61643-331 NOTE Harmonized as EN 61643-331.</p>		P
11	ADDITION OF ANNEXES		
ZB	ANNEX ZB, SPECIAL NATIONAL CONDITIONS (EN)		
4.1.15	<p>Denmark, Finland, Norway and Sweden</p> <p>To the end of the subclause the following is added:</p> <p>Class I pluggable equipment type A intended for connection to other equipment or a network shall, if safety relies on connection to reliable earthing or if surge suppressors are connected between the network terminals and accessible parts, have a marking stating that the equipment shall be connected to an earthed mains socket-outlet.</p> <p>The marking text in the applicable countries shall be as follows:</p> <p>In Denmark: "Apparatets stikprop skal tilsluttes en stikkontakt med jord som giver forbindelse til stikproppens jord." In Finland: "Laitte on liitettävä suojakoskettimilla varustettuun pistorasiaan" In Norway: "Apparatet må tilkoples jordet stikkontakt" In Sweden: "Apparaten skall anslutas till jordat uttag"</p>	<p>The equipment is Class I equipment. The marking text must be provided when marketed in applicable countries.</p>	P

IEC62368_1E ATTACHMENT			
Clause	Requirement + Test	Result - Remark	Verdict
4.7.3	<p>United Kingdom</p> <p>To the end of the subclause the following is added:</p> <p>The torque test is performed using a socket-outlet complying with BS 1363, and the plug part shall be assessed to the relevant clauses of BS 1363. Also see Annex G.4.2 of this annex</p>	The equipment is not direct plug-in equipment.	N/A
5.2.2.2	<p>Denmark</p> <p>After the 2nd paragraph add the following:</p> <p>A warning (marking safeguard) for high touch current is required if the touch current exceeds the limits of 3,5 mA a.c. or 10 mA d.c.</p>	No high touch current.	N/A
5.4.11.1 and Annex G	<p>Finland and Sweden</p> <p>To the end of the subclause the following is added:</p> <p>For separation of the telecommunication network from earth the following is applicable:</p> <p>If this insulation is solid, including insulation forming part of a component, it shall at least consist of either</p> <ul style="list-style-type: none"> • two layers of thin sheet material, each of which shall pass the electric strength test below, or • one layer having a distance through insulation of at least 0,4 mm, which shall pass the electric strength test below. <p>If this insulation forms part of a semiconductor component (e.g. an optocoupler), there is no distance through insulation requirement for the insulation consisting of an insulating compound completely filling the casing, so that clearances and creepage distances do not exist, if the component passes the electric strength test in accordance with the compliance clause below and in addition</p> <ul style="list-style-type: none"> • passes the tests and inspection criteria of 5.4.8 with an electric strength test of 1,5 kV multiplied by 1,6 (the electric strength test of 5.4.9 shall be performed using 1,5 kV), <p>and</p> <ul style="list-style-type: none"> • is subject to routine testing for electric strength 	No TNV circuits.	N/A

IEC62368_1E ATTACHMENT			
Clause	Requirement + Test	Result - Remark	Verdict
	<p>during manufacturing, using a test voltage of 1,5 kV.</p> <p>It is permitted to bridge this insulation with a capacitor complying with EN 60384-14:2005, subclass Y2.</p> <p>A capacitor classified Y3 according to EN 60384-14:2005, may bridge this insulation under the following conditions:</p> <ul style="list-style-type: none"> the insulation requirements are satisfied by having a capacitor classified Y3 as defined by EN 60384-14, which in addition to the Y3 testing, is tested with an impulse test of 2,5 kV defined in 5.4.11; the additional testing shall be performed on all the test specimens as described in EN 60384-14; <p>the impulse test of 2,5 kV is to be performed before the endurance test in EN 60384-14, in the sequence of tests as described in EN 60384-14.</p>		
5.5.2.1	<p>Norway</p> <p>After the 3rd paragraph the following is added:</p> <p>Due to the IT power system used, capacitors are required to be rated for the applicable line-to-line voltage (230 V).</p>	Considered.	P
5.5.6	<p>Finland, Norway and Sweden</p> <p>To the end of the subclause the following is added:</p> <p>Resistors used as basic safeguard or bridging basic insulation in class I pluggable equipment type A shall comply with G.10.1 and the test of G.10.2.</p>	No such resistors.	N/A

IEC62368_1E ATTACHMENT			
Clause	Requirement + Test	Result - Remark	Verdict
5.6.1	<p>Denmark</p> <p>Add to the end of the subclause Due to many existing installations where the socket-outlets can be protected with fuses with higher rating than the rating of the socket-outlets the protection for pluggable equipment type A shall be an integral part of the equipment. <i>Justification:</i> In Denmark an existing 13 A socket outlet can be protected by a 20 A fuse.</p>	Considered.	P
5.6.4.2.1	<p>Ireland and United Kingdom</p> <p>After the indent for pluggable equipment type A, the following is added: – the protective current rating is taken to be 13 A, this being the largest rating of fuse used in the mains plug.</p>	Considered.	P
5.6.4.2.1	<p>France</p> <p>After the indent for pluggable equipment type A, the following is added: – in certain cases, the protective current rating of the circuit supplied from the mains is taken as 20 A instead of 16 A.</p>	Considered.	P
5.6.5.1	<p>To the second paragraph the following is added: The range of conductor sizes of flexible cords to be accepted by terminals for equipment with a rated current over 10 A and up to and including 13 A is: 1,25 mm² to 1,5 mm² in cross-sectional area.</p>	See above.	N/A
5.6.8	<p>Norway</p> <p>To the end of the subclause the following is added: Equipment connected with an earthed mains plug is classified as class I equipment. See the Norway marking requirement in 4.1.15. The symbol IEC 60417-6092, as specified in F.3.6.2, is accepted.</p>	Considered.	P
5.7.6	<p>Denmark</p> <p>To the end of the subclause the following is added: The installation instruction shall be affixed to the equipment if the protective conductor current exceeds the limits of 3,5 mA a.c. or 10 mA d.c.</p>	No high protective conductor current.	N/A

IEC62368_1E ATTACHMENT			
Clause	Requirement + Test	Result - Remark	Verdict
5.7.6.2	<p>Denmark</p> <p>To the end of the subclause the following is added: The warning (marking safeguard) for high touch current is required if the touch current or the protective current exceed the limits of 3,5 mA .</p>	No external circuits.	N/A
5.7.7.1	<p>Norway and Sweden</p> <p>To the end of the subclause the following is added: The screen of the television distribution system is normally not earthed at the entrance of the building and there is normally no equipotential bonding system within the building. Therefore the protective earthing of the building installation needs to be isolated from the screen of a cable distribution system.</p> <p>It is however accepted to provide the insulation external to the equipment by an adapter or an interconnection cable with galvanic isolator, which may be provided by a retailer, for example.</p> <p>The user manual shall then have the following or similar information in Norwegian and Swedish language respectively, depending on in what country the equipment is intended to be used in:</p> <p>“Apparatus connected to the protective earthing of the building installation through the mains connection or through other apparatus with a connection to protective earthing – and to a television distribution system using coaxial cable, may in some circumstances create a fire hazard. Connection to a television distribution system therefore has to be provided through a device providing electrical isolation below a certain frequency range (galvanic isolator, see EN 60728-11)”</p> <p>NOTE In Norway, due to regulation for CATV-installations, and in Sweden, a galvanic isolator shall provide electrical insulation below 5 MHz. The insulation shall withstand a dielectric strength of 1,5 kV r.m.s., 50 Hz or 60 Hz, for 1 min.</p> <p>Translation to Norwegian (the Swedish text will also be accepted in Norway):</p> <p>“Apparater som er koplet til beskyttelsesjord via nettplugg og/eller via annet jordtilkoplede utstyr – og er tilkoplede et koaksialbasert kabel-TV nett, kan forårsake brannfare.</p>	Not such system.	N/A

IEC62368_1E ATTACHMENT			
Clause	Requirement + Test	Result - Remark	Verdict
	<p>For å unngå dette skal det ved tilkopling av apparater til kabel-TV nett installeres en galvanisk isolator mellom apparatet og kabel-TV nettet.”</p> <p>Translation to Swedish: ”Apparater som är kopplad till skyddsjord via jordat vägguttag och/eller via annan utrustning och samtidigt är kopplad till kabel-TV nät kan i vissa fall medföra risk för brand. För att undvika detta skall vid anslutning av apparaten till kabel-TV nät galvanisk isolator finnas mellan apparaten och kabel-TV nätet.”</p>		
8.5.4.2.3	<p>United Kingdom</p> <p>Add the following after the 2nd dash bullet in 3rd paragraph:</p> <p>An emergency stop system complying with the requirements of IEC 60204-1 and ISO 13850 is required where there is a risk of personal injury.</p>		N/A
B.3.1 and B.4	<p>Ireland and United Kingdom</p> <p>The following is applicable:</p> <p>To protect against excessive currents and short-circuits in the primary circuit of direct plug-in equipment, tests according to Annexes B.3.1 and B.4 shall be conducted using an external miniature circuit breaker complying with EN 60898-1, Type B, rated 32A. If the equipment does not pass these tests, suitable protective devices shall be included as an integral part of the direct plug-in equipment, until the requirements of Annexes B.3.1 and B.4 are met</p>	The equipment is not direct plug-in equipment.	N/A

IEC62368_1E ATTACHMENT			
Clause	Requirement + Test	Result - Remark	Verdict
G.4.2	<p>Denmark</p> <p>To the end of the subclause the following is added:</p> <p>Supply cords of single phase appliances having a rated current not exceeding 13 A shall be provided with a plug according to DS 60884-2-D1:2011.</p> <p>CLASS I EQUIPMENT provided with socket-outlets with earth contacts or which are intended to be used in locations where protection against indirect contact is required according to the wiring rules shall be provided with a plug in accordance with standard sheet DK 2-1a or DK 2-5a.</p> <p>If a single-phase equipment having a RATED CURRENT exceeding 13 A or if a polyphase equipment is provided with a supply cord with a plug, this plug shall be in accordance with the standard sheets DK 6-1a in DS 60884-2-D1 or EN 60309-2.</p> <p>Mains socket outlets intended for providing power to Class II apparatus with a rated current of 2,5 A shall be in accordance DS 60884-2-D1:2011 standard sheet DKA 1-4a.</p> <p>Other current rating socket outlets shall be in compliance with Standard Sheet DKA 1-3a or DKA 1-1c.</p> <p>Mains socket-outlets with earth shall be in compliance with DS 60884-2-D1:2011 Standard Sheet DK 1-3a, DK 1-1c, DK1-1d, DK 1-5a or DK 1-7a</p> <p><i>Justification:</i> Heavy Current Regulations, Section 6c</p>	No power supply cord is provided.	N/A
G.4.2	<p>United Kingdom</p> <p>To the end of the subclause the following is added:</p> <p>The plug part of direct plug-in equipment shall be assessed to BS 1363: Part 1, 12.1, 12.2, 12.3, 12.9, 12.11, 12.12, 12.13, 12.16, and 12.17, except that the test of 12.17 is performed at not less than 125 °C. Where the metal earth pin is replaced by an Insulated Shutter Opening Device (ISOD), the requirements of clauses 22.2 and 23 also apply.</p>	The equipment is not direct plug-in equipment.	N/A

IEC62368_1E ATTACHMENT			
Clause	Requirement + Test	Result - Remark	Verdict
G.7.1	<p>United Kingdom</p> <p>To the first paragraph the following is added:</p> <p>Equipment which is fitted with a flexible cable or cord and is designed to be connected to a mains socket conforming to BS 1363 by means of that flexible cable or cord shall be fitted with a 'standard plug' in accordance with the Plugs and Sockets etc. (Safety) Regulations 1994, Statutory Instrument 1994 No. 1768, unless exempted by those regulations.</p> <p>NOTE "Standard plug" is defined in SI 1768:1994 and essentially means an approved plug conforming to BS 1363 or an approved conversion plug.</p>	No power supply cord is provided.	N/A
G.7.1	<p>Ireland</p> <p>To the first paragraph the following is added:</p> <p>Apparatus which is fitted with a flexible cable or cord shall be provided with a plug in accordance with Statutory Instrument 525: 1997, "13 A Plugs and Conversion Adapters for Domestic Use Regulations: 1997. S.I. 525 provides for the recognition of a standard of another Member State which is equivalent to the relevant Irish Standard</p>	No power supply cord is provided.	N/A
G.7.2	<p>Ireland and United Kingdom</p> <p>To the first paragraph the following is added:</p> <p>A power supply cord with a conductor of 1,25 mm² is allowed for equipment which is rated over 10 A and up to and including 13 A.</p>	No power supply cord is provided.	N/A

IEC62368_1E ATTACHMENT			
Clause	Requirement + Test	Result - Remark	Verdict
ZC	ANNEX ZC, NATIONAL DEVIATIONS (EN)		
10.5.2	<p>Germany</p> <p>The following requirement applies:</p> <p>For the operation of any cathode ray tube intended for the display of visual images operating at an acceleration voltage exceeding 40 kV, authorization is required, or application of type approval (Bauartzulassung) and marking.</p> <p><i>Justification:</i></p> <p>German ministerial decree against ionizing radiation (Röntgenverordnung), in force since 2002-07-01, implementing the European Directive 96/29/EURATOM.</p> <p>NOTE Contact address: Physikalisch-Technische Bundesanstalt, Bundesallee 100, D-38116 Braunschweig, Tel.: Int+49-531-592-6320, Internet: http://www.ptb.de</p>	No CRT within the equipment.	N/A

IEC62368_1E ATTACHMENT

Clause	Requirement + Test	Result - Remark	Verdict
--------	--------------------	-----------------	---------

ZD	IEC and CENELEC CODE DESIGNATIONS FOR FLEXIBLE CORDS (EN)								
	<table border="1"> <thead> <tr> <th data-bbox="395 398 957 459">Type of flexible cord</th> <th colspan="2" data-bbox="957 398 1401 459">Code designations</th> </tr> <tr> <td data-bbox="395 459 957 526"></td> <th data-bbox="957 459 1189 526">IEC</th> <th data-bbox="1189 459 1401 526">CENELEC</th> </tr> </thead> </table>	Type of flexible cord	Code designations			IEC	CENELEC		N/A
Type of flexible cord	Code designations								
	IEC	CENELEC							
PVC insulated cords									
Flat twin tinsel cord	60227 IEC 41	H03VH-Y							
Light polyvinyl chloride sheathed flexible cord	60227 IEC 52	H03VV-F H03VVH2-F							
Ordinary polyvinyl chloride sheathed flexible cord	60227 IEC 53	H05VV-F H05VVH2-F							
Rubber insulated cords									
Braided cord	60245 IEC 51	H03RT-F							
Ordinary tough rubber sheathed flexible cord	60245 IEC 53	H05RR-F							
Ordinary polychloroprene sheathed flexible cord	60245 IEC 57	H05RN-F							
Heavy polychloroprene sheathed flexible cord	60245 IEC 66	H07RN-F							
Cords having high flexibility									
Rubber insulated and sheathed cord	60245 IEC 86	H03RR-H							
Rubber insulated, crosslinked PVC sheathed cord	60245 IEC 87	H03RV4-H							
Crosslinked PVC insulated and sheathed cord	60245 IEC 88	H03V4V4-H							
Cords insulated and sheathed with halogen-free thermoplastic compounds									
Light halogen-free thermoplastic insulated and sheathed flexible cords		H03Z1Z1-F H03Z1Z1H2-F							
Ordinary halogen-free thermoplastic insulated and sheathed flexible cords		H05Z1Z1-F H05Z1Z1H2-F							

IEC62368_1E ATTACHMENT			
Clause	Requirement + Test	Result - Remark	Verdict

ATTACHMENT TO TEST REPORT IEC 62368-1 U.S.A. AND CANADA NATIONAL DIFFERENCES (Audio/video, information and communication technology equipment – Part 1: Safety requirements)			
Differences according to.....: CSA/UL 62368-1:2019			
TRF template used:: IECEE OD-2020-F3, Ed. 1.1			
Attachment Form No.....: US_CA_ND_IEC62368_1E			
Attachment Originator: UL(US)			
Master Attachment.....: Dated 2021-02-04			

Copyright © 2021 IEC System for Conformity Testing and Certification of Electrical Equipment (IECEE), Geneva, Switzerland. All rights reserved.

IEC 62368-1 - US and Canadian National Differences Special National Conditions based on Regulations and Other National Differences			
1 (1DV.1) (1.3)	All equipment is to be designed to allow installation in accordance with the National Electrical Code (NEC), ANSI/NFPA 70, the Canadian Electrical Code (CEC), Part 1, CAN/CSA C22.1, and when applicable, the National Electrical Safety Code, IEEE C2. Also, for such equipment marked or otherwise identified, installation is allowed per the Standard for the Protection of Information Technology Equipment, ANSI/NFPA 75.	In accordance with the National Electrical Code (NEC) and the Canadian Electrical Code (CEC) part 1 CAN/CSA C22.1, ANSI/NFPA 70, and unless marked or otherwise identified, the Standard for Electronic Computer/Data-Processing Equipment, ANSI/NFPA 75.	P
1 (1DV.2.1)	This standard includes additional requirements for equipment used for entertainment purposes intended for installation in general patient care areas of health care facilities. See Annex DVB.	Not such application.	N/A
1 (1DV.2.2)	This standard includes additional requirements for equipment intended for mounting under cabinets. See Annex DVC.	Not such application.	N/A
1 (1DV.2.3)	IEC 62368-3 clause 5 for DC power transfer at ES1 or ES2 voltage levels is considered informative. IEC 62368-3 clause 6 for remote power feeding telecommunication (RFT) circuits is considered normative (see ITU K.50). Alternatively, equipment with RFT circuits are given in either UL 2391 or CSA/UL 60950-21. RFT-C circuits are not permitted unless the RFT-C circuit complies with RFT-V limits ($\leq 200V$ per conductor to earth).	Not such application.	N/A
1 (1DV.3)	For protection against direct lightning strikes, reference is made to NFPA 780 and CAN/CSA-B72 for additional requirements.	Not such application.	N/A

IEC62368_1E ATTACHMENT			
Clause	Requirement + Test	Result - Remark	Verdict
1 (DV.5)	Additional requirements apply to some forms of power distribution equipment, including sub-assemblies.	Considered.	P
4.1 (4.1.17)	For lengths exceeding 3.05 m, external interconnecting cable assemblies are required to be a suitable cable type (e.g., DP, CL2) specified in the NEC.	Not exceeding 3.05 m.	N/A
	For lengths 3.05 m or less, external interconnecting cable assemblies that are not types specified in the NEC generally are required to have special construction features and identification markings.	Overall acceptance has to be evaluated during the national approval process.	N/A
4.6 (4.6.2)	Wire-wrap terminals have special construction and performance requirements.	No such parts.	N/A
4.8 (4.8.3, 4.8.4.5, 4.8.5)	Coin / button cell batteries have modified special construction and performance requirements.	No such parts.	N/A
5.4.2.3.2 (5.4.2.3.2.1)	Surge Arrestors and Transient Voltage Surge Suppressors installed external to the equipment are required to comply with the appropriate NEC and CEC requirements.	No such parts.	N/A
5.5.9	Receptacles, rated 125-V, single phase, 15- or 20-A accessible to either ordinary, instructed, or skilled persons are required to be provided with GFCI Protection for Personnel if the equipment containing the receptacles is installed outdoors. The protection devices are required to comply with UL 943, and CAN/CSA C22.2 No.144.	No outdoor equipment.	N/A
5.6.3	Protective earthing conductors comply with the minimum conductor sizes in Table G.7, except as required by Table G.7ADV.1 for cord connected equipment, or Annex DVH for permanently connected equipment.	An appliance inlet provided that is connected by an approved appliance coupler serves as main protective earthing terminal. No power supply cord is provided.	N/A
5.7.8 (5.7.8.1)	Equipment intended to receive telecommunication ringing signals is required to comply with a special touch current measurement tests.	No TNV circuits within the equipment.	N/A
6.5.1	PS3 wiring outside a fire enclosure is required to comply with single fault testing in B.4, or be current limited per one of the permitted methods.	No such parts.	N/A
Annex F (F.3.3.9)	Output terminals provided for supply of other equipment, except mains supply, are required to be marked with a maximum rating or reference to equipment permitted to be connected.	No DC output connector is provided.	N/A

IEC62368_1E ATTACHMENT			
Clause	Requirement + Test	Result - Remark	Verdict
Annex F (F.3.7)	Outdoor Enclosures are required to be classified and marked in accordance with UL 50 or 50E, or CAN/CSA C22.2 No. 94.1 or 94.2.	No outdoor equipment.	N/A
Annex G (G.7)	Permanent connection of equipment to the mains supply by a power supply cord is not permitted, except for certain equipment, such as ATMs.	The equipment is not permanent connection equipment.	N/A
	Power supply cords are required to have attachment plugs rated not less than 125 percent of the rated current of the equipment.	No power supply cord is provided.	N/A
	Flexible power supply cords are required to be compatible with Article 400 of the NEC, and Tables 11 and 12 of the CEC.	See above.	N/A
	Minimum cord length is required to be 1.5 m, with certain constructions such as external power supplies allowed to consider both input and output cord lengths into the requirement. Power supply cords are required to be no longer than 4.5 m in length if used in ITE Rooms.	See above.	N/A
	Power supply cords for outdoor equipment are required to be suitable outdoor use type as required by Section 400.4 of the NEC and Rule 4-012 of the CEC, i.e., marked "W."	No outdoor equipment.	N/A
Annex H.2	Continuous ringing signals under normal operating conditions up to 16 mA only are permitted if the equipment is subjected to special installation and performance restrictions.	No TNV circuits within the equipment.	N/A
Annex H.4	For circuits with other than ringing signals and with voltages exceeding 42.4 V _{peak} or 60 V _{d.c.} , the maximum acceptable current through a 2000 ohm resistor (or greater) connected across the voltage source with other loads disconnected is 7.1 mA peak or 30 mA d.c. under normal operating conditions.	No TNV circuits within the equipment.	N/A
Annex Q (Q.3)	Equipment with paired conductor and/or coax communications cables/wiring connected to building wiring are required to have special voltage, current, power and marking requirements.	The equipment not intended to be used within such environments.	N/A
Annex DVA (1)	Equipment that is designed such that it may be powered from a separate electrical service, is required to meet applicable requirements for service equipment for control and protection of services and their installation and complies with Article 230 of the National Electrical Code (NEC), NFPA 70 and Section 6 of the Canadian Electrical Code, Part I, CSA C22.1.	The equipment not intended to be used within such environments.	N/A
	Equipment intended for use in spaces used for environmental air (plenums) are subjected to special flammability requirements for heat and visible smoke release.	The equipment not intended to be used within such environments.	N/A

IEC62368_1E ATTACHMENT			
Clause	Requirement + Test	Result - Remark	Verdict
	For ITE room applications, automated information storage systems with combustible media greater than 0.76 m ³ (27 cu ft) are required to have a provision for connection of either automatic sprinklers or a gaseous agent extinguishing system with an extended discharge.	Not such equipment.	N/A
	Consumer products designed or intended primarily for children 12 years of age or younger are subject to additional requirements in accordance with U.S. and Canadian Regulations.	The equipment is not for children used.	N/A
	Baby monitors are required to additionally comply with ASTM F2951, Consumer Safety Specification for Baby Monitors.	Not a baby monitors.	N/A
	Storage batteries and battery management equipment, other than associated with lead-acid batteries, and including battery backup systems that are not an integral part of stationary AV and ICT equipment, such as provided in separate cabinets, are required to be certified (listed) to the appropriate standard(s) for such storage batteries and equipment.	Not such equipment.	N/A
Annex DVA (5.6)	For Pluggable Equipment Type A, the protection in the installation is assumed to be 20A.	Considered.	P
Annex DVA (6.3)	The maximum quantity of flammable liquid stored in equipment is required to comply with NFPA 30.	No flammable liquids within the equipment.	N/A
Annex DVA (6.4.8)	For ITE room applications, enclosures with combustible material measuring greater than 0.9 m ² (10 sq ft) or a single dimension greater than 1.8 m (6 ft) are required to have a flame spread rating of 50 or less. For equipment with the same dimensions for other applications, an external surface that is not a fire enclosure requires a minimum flammability classification of V-1.	No such application.	N/A
Annex DVA (10.3)	Equipment with lasers is required to meet the U.S. Code of Federal Regulations 21 CFR 1040 (and the Canadian Radiation Emitting Devices Act, REDR C1370).	No such parts.	N/A
Annex DVA (10.5)	Equipment that produces ionizing radiation is required to comply with the U.S. Code of Federal Regulations, 21 CFR 1020 (and the Canadian Radiation Emitting Devices Act, REDR C1370).	No such parts.	N/A

IEC62368_1E ATTACHMENT			
Clause	Requirement + Test	Result - Remark	Verdict
Annex DVA (F.3.3.4)	Equipment for use on a.c. mains supply systems with a neutral and more than one phase conductor (e.g. 120/240 V, 3-wire) require a special marking format for electrical ratings. Additional considerations apply for voltage ratings that exceed the attachment cap rating or that are lower than the "Normal Operating Condition" in Table 2 of CAN/CSA C22.2 No. 235."	Single phase only.	N/A
Annex DVA (F.3.3.6)	Equipment identified for ITE (computer) room installation is required to be marked with the rated current.	Not such application.	N/A
Annex DVA (G.1)	Vertically-mounted disconnect switches and circuit breakers are required to have the "on" position indicated by the handle in the up position.	No such parts.	N/A
Annex DVA (G.3.4)	Suitable NEC/CEC branch circuit protection rated at the maximum circuit rating is required for all standard supply outlets and receptacles (such as supplied in power distribution units) if the supply branch circuit protection is not suitable.	No standard supply outlets, receptacles, medium-base or smaller lampholders are provided.	N/A
	Where a fuse is used to provide Class 2 or Class 3 current limiting, it is not operator-accessible unless it is non- interchangeable.	No such parts.	N/A
Annex DVA (G.4.2)	Equipment with isolated ground (earthing) receptacles is required to comply with NEC 250.146(D) and CEC 10-400 and 10-612.	No such parts.	N/A
Annex DVA (G.4.3)	Interconnection of units by conductors supplied by a limited power source, or a Class 2 circuit defined in the NEC/CEC may have field wiring connections other than specified in DVH.3, such as wire-wrap and crimp-on types, if the limited power source and Class 2 circuits are separated from all other circuits by barriers, routing or fixing.	No such parts.	N/A
Annex DVA (G.5.3)	Power distribution transformers distributing power at 100 volts or more, and rated 10 kVA or more, require special transformer overcurrent protection.	No such parts.	N/A
Annex DVA (G.5.4)	Motor control devices are required for cord-connected equipment with a mains-connected motor if the equipment is rated more than 12 A, or if the equipment has a nominal voltage rating greater than 120 V, or if the motor is rated more than 1/3 hp (locked rotor current over 43 A).	No such parts.	N/A
Annex DVA (G.7)	Flexible cords used outdoors are required to have the suffix "W" marked on the flexible cord.	No such parts.	N/A

IEC62368_1E ATTACHMENT			
Clause	Requirement + Test	Result - Remark	Verdict
Annex DVA (M)	For ITE room applications, equipment with battery systems capable of supplying 750 VA for five minutes are required to have a battery disconnect means that may be connected to the ITE room remote power-off circuit.	Not such application.	N/A
Annex DVA (Q)	If applicable per NEC 725.121(C), some limited power sources supplied from AV/ICT equipment are required to have a label indicating the maximum voltage and maximum current, or maximum voltage and nominal current output for each connection point. Where multiple connection points have the same rating, a single label is permitted to be used.	Not applicable for the equipment.	N/A
	Wiring terminals intended to supply Class 2 outputs in accordance with the NEC or CEC Part 1 are required to be marked with the voltage rating and "Class 2" or equivalent. The marking is located adjacent to the terminals and visible during wiring.	Not applicable for the equipment.	N/A
	Applicable parts of Chapter 8 of the NEC, and Rules 54 and 60 of the CEC, may be applicable to ITE installed outdoors with connections to communication systems.	No outdoor equipment.	N/A
Annex DVB (1)	Additional requirements apply for equipment used for entertainment purposes intended for installation in general patient care areas of health care facilities.	Not such application.	N/A
Annex DVC (1)	Additional requirements apply for equipment intended for mounting under kitchen cabinets.	Not such application.	N/A
Annex DVE (4.1.1)	Some equipment, components, sub-assemblies and materials associated with the risk of fire, electric shock, or personal injury are required to have component or material ratings in accordance with the applicable national (U.S. and Canadian) component or material requirements. These equipment and components include: appliance couplers, attachment plugs, battery backup systems, circuit breakers, communication circuit accessories, connectors (used for current interruption of non-LPS circuits), direct plug-in equipment, electrochemical capacitor modules (energy storage modules with ultracapacitors), enclosures (outdoor), flexible cords and cables, fuses (branch circuit), ground-fault current interrupters, interconnecting cables, modular data centers, power supply cords, some power distribution equipment, printed wiring, protectors for communications circuits, receptacles, surge protective devices, vehicle battery adapters, wire connectors, and wire and cables.	UL approved components are used. Refer to table 4.1.2 of IEC 62368-1 test report for details.	P

IEC62368_1E ATTACHMENT

Clause	Requirement + Test	Result - Remark	Verdict
Annex DVH	Equipment for permanent connection to the mains supply is subjected to additional requirements.	The equipment is not permanently connected equipment.	N/A
Annex DVH (DVH.1)	Wiring methods (terminals, leads, etc.) used for the connection of the equipment to the mains are required to be in accordance with the NEC/CEC.	The equipment is pluggable equipment type A.	N/A
Annex DVH (DVH.3.2)	Terminals for permanent wiring, including protective earthing terminals, are required to be suitable for U.S./Canadian wire gauge sizes, rated 125 percent of the equipment rating, and be specially marked when specified.	No terminals for permanent wiring.	N/A
	Wire binding screws are not permitted to attach conductors larger than 10 AWG (5.3 mm ²).	No wire binding screws.	N/A
Annex DVH (DVH.4)	Permanently connected equipment is required to have a suitable wiring compartment and wire bending space.	The equipment is not permanently connected equipment.	N/A
Annex DVH (DVH 5.5)	Equipment connected to a centralized d.c. power system, and having one pole of the DC mains input terminal connected to the main protective earthing terminal in the equipment, is required to comply with special earthing, wiring, marking and installation instruction requirements.	The equipment not connected to a centralized d.c. power system.	N/A
Annex DVI (6.7)	Equipment intended for connection to telecommunication network outside plant cable is required to be protected against overvoltage from power line crosses.	No TNV circuits within the equipment.	N/A
Annex DVJ (10.6.1)	Equipment connected to a telecommunication and cable distribution networks and supplied with an earphone intended to be held against, or in the ear is required to comply with special acoustic pressure requirements.	No TNV circuits within the equipment.	N/A

Product: LCD MONITOR (LED backlight)

Type Designation: See Page 2 of report No. 60436687 001 for model list



Figure 1. Front view of horizon position for 23.6 inch models



Figure 2. Rear view of horizon position for 23.6 inch models

Product: LCD MONITOR (LED backlight)

Type Designation: See Page 2 of report No. 60436687 001 for model list

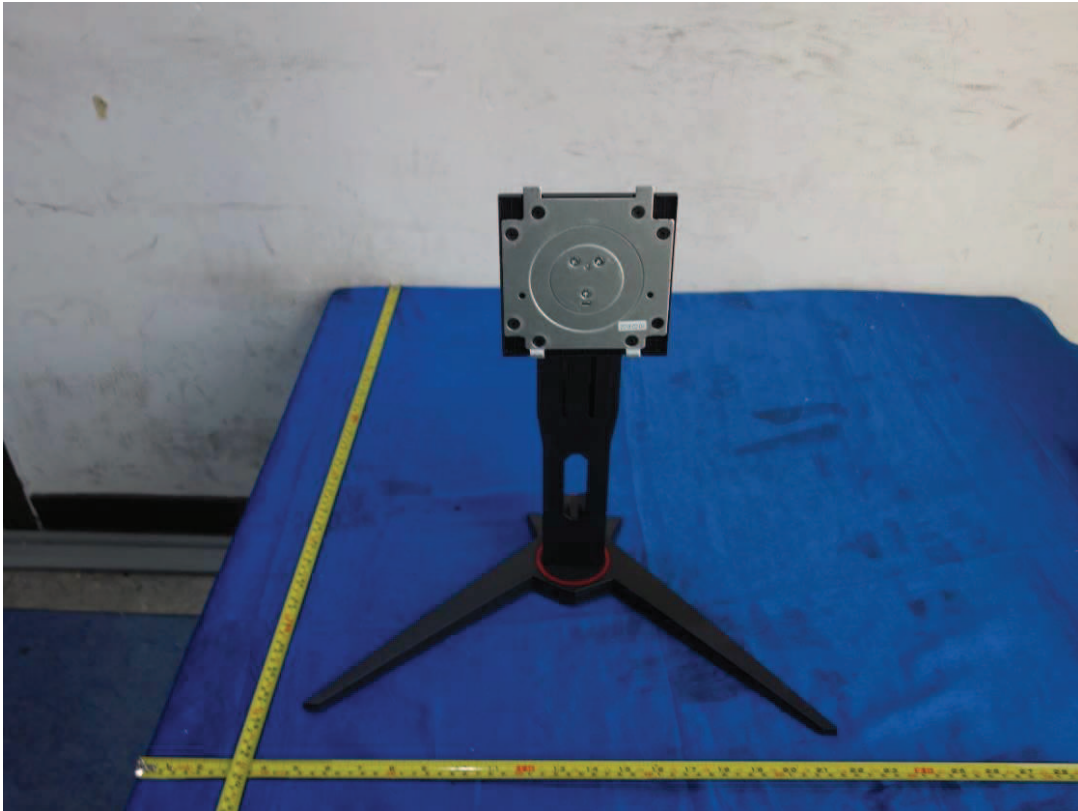

Figure 3. Stand base



Figure 4. Plastic enclosure without base stand

Product: LCD MONITOR (LED backlight)

Type Designation: See Page 2 of report No. 60436687 001 for model list



Figure 5. Internal view



Figure 6. Internal view of metal enclosure A

Product: LCD MONITOR (LED backlight)

Type Designation: See Page 2 of report No. 60436687 001 for model list



Figure 7. Internal view of metal enclosure A

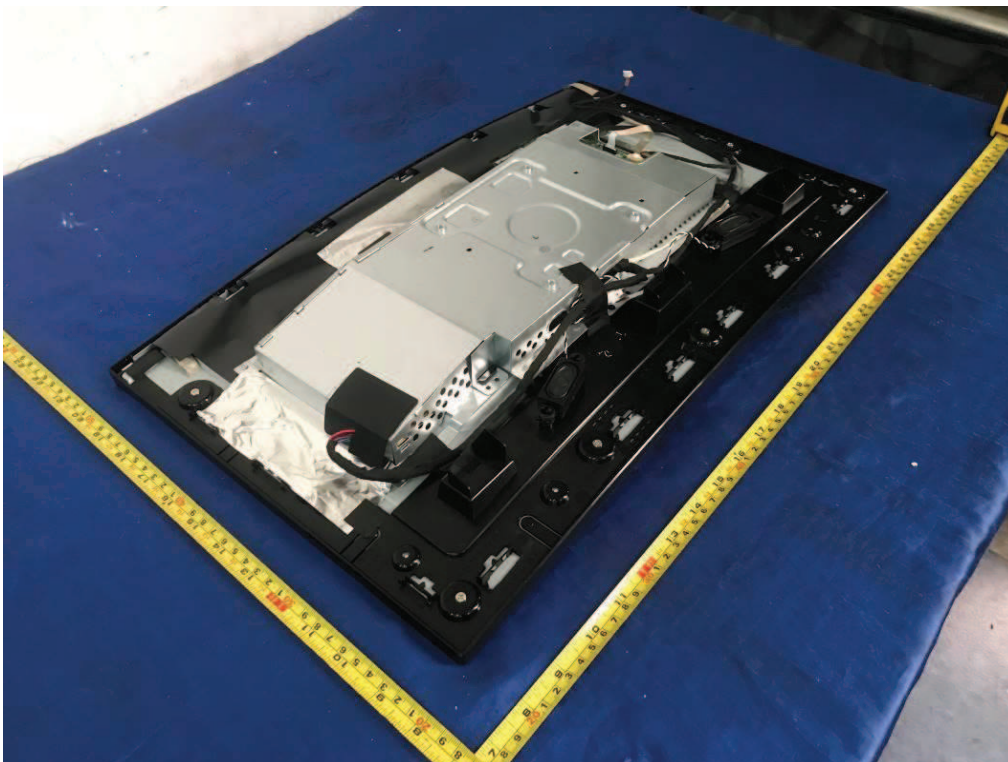

Figure 8. Internal view of metal enclosure A

Product: LCD MONITOR (LED backlight)

Type Designation: See Page 2 of report No. 60436687 001 for model list



Figure 9. Output connector

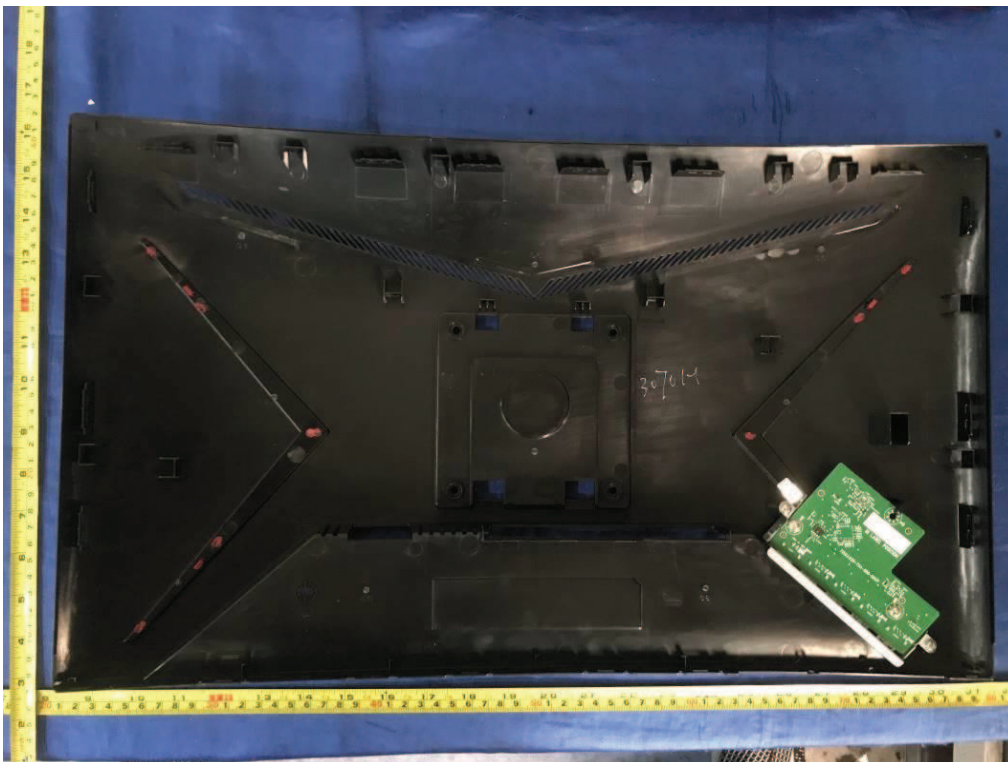

Figure 10. Internal view

Product: LCD MONITOR (LED backlight)

Type Designation: See Page 2 of report No. 60436687 001 for model list

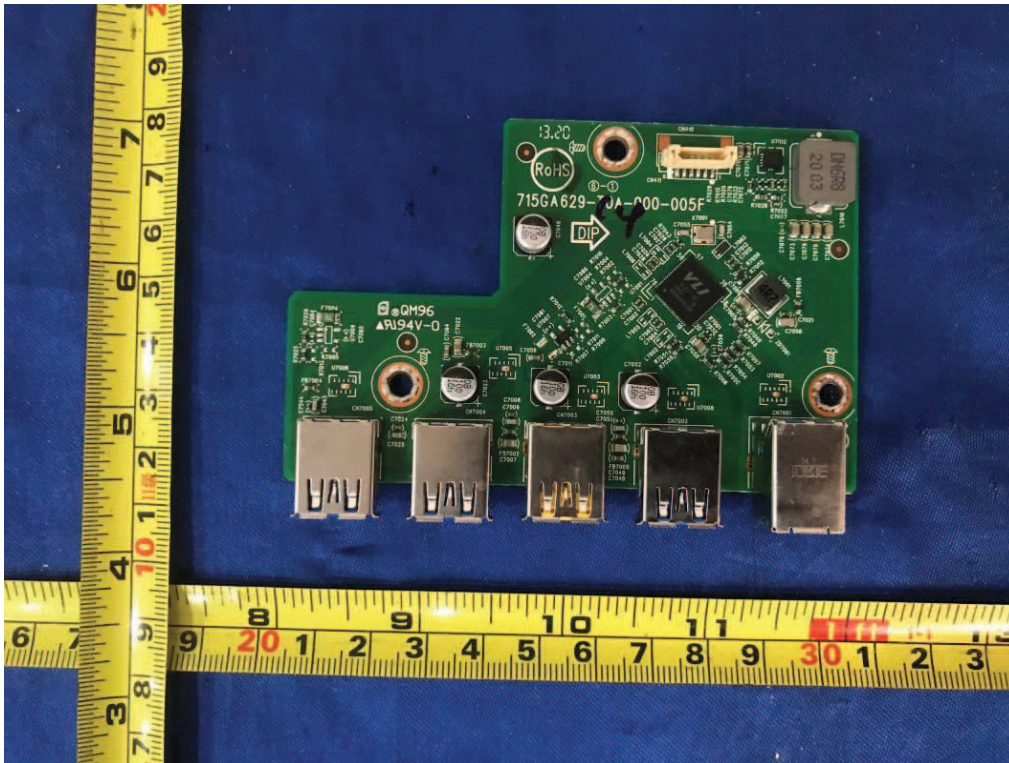

Figure 11. USB board 715GA629

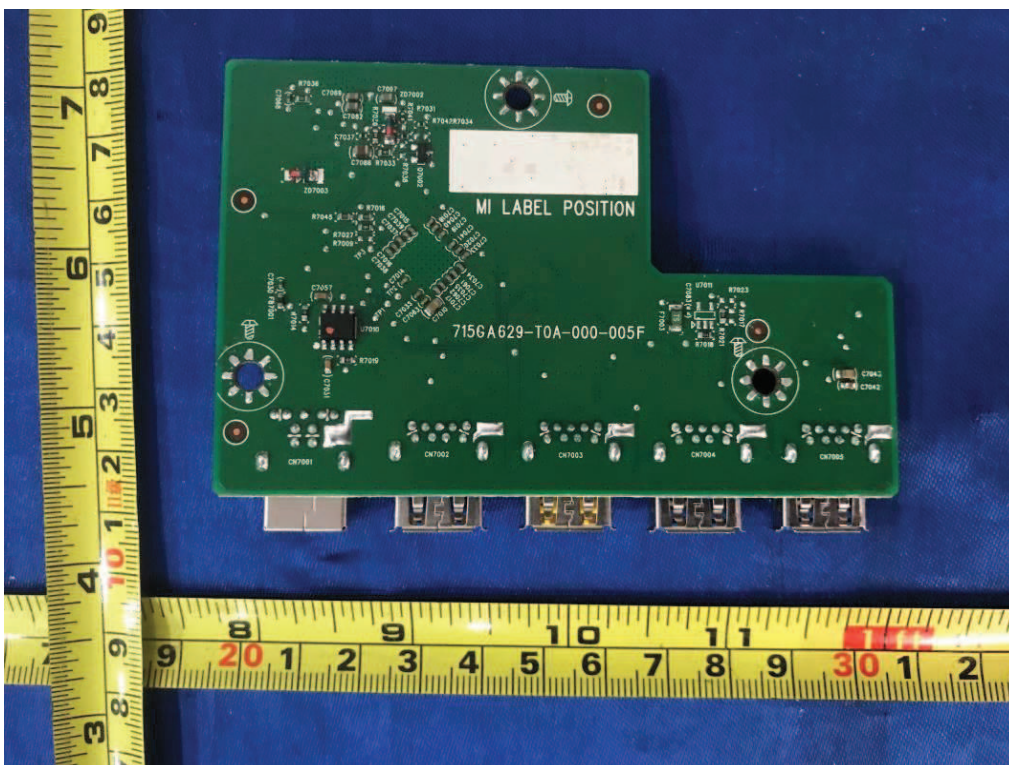

Figure 12. USB board 715GA629

Product: LCD MONITOR (LED backlight)

Type Designation: See Page 2 of report No. 60436687 001 for model list

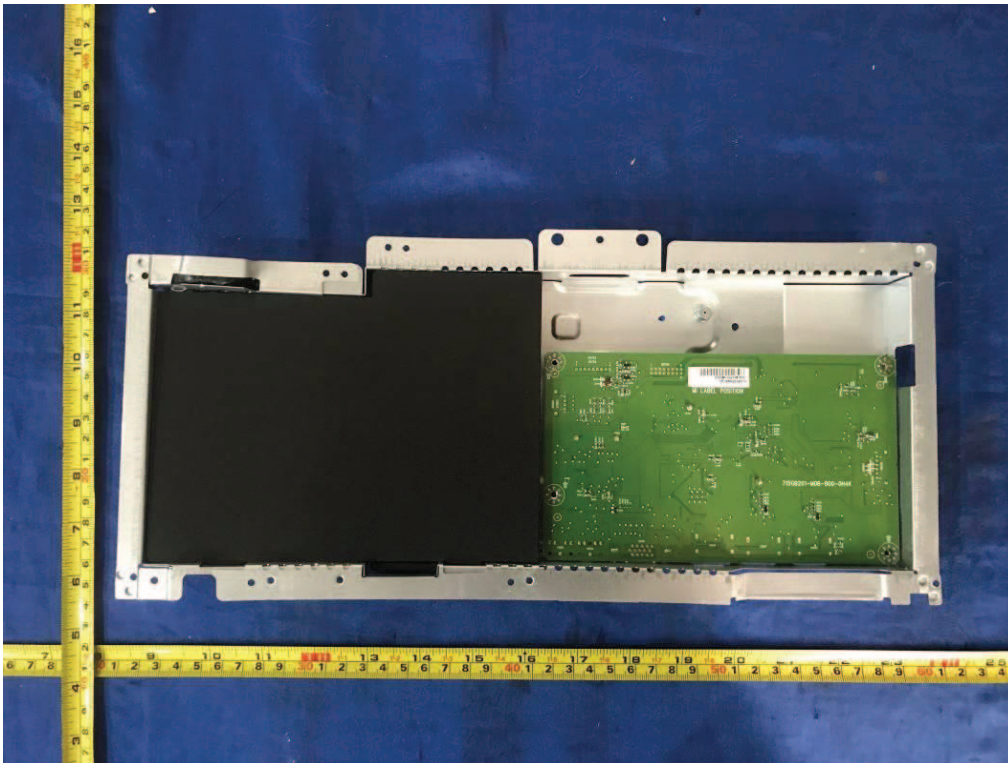

Figure 13. Internal view of metal enclosure A

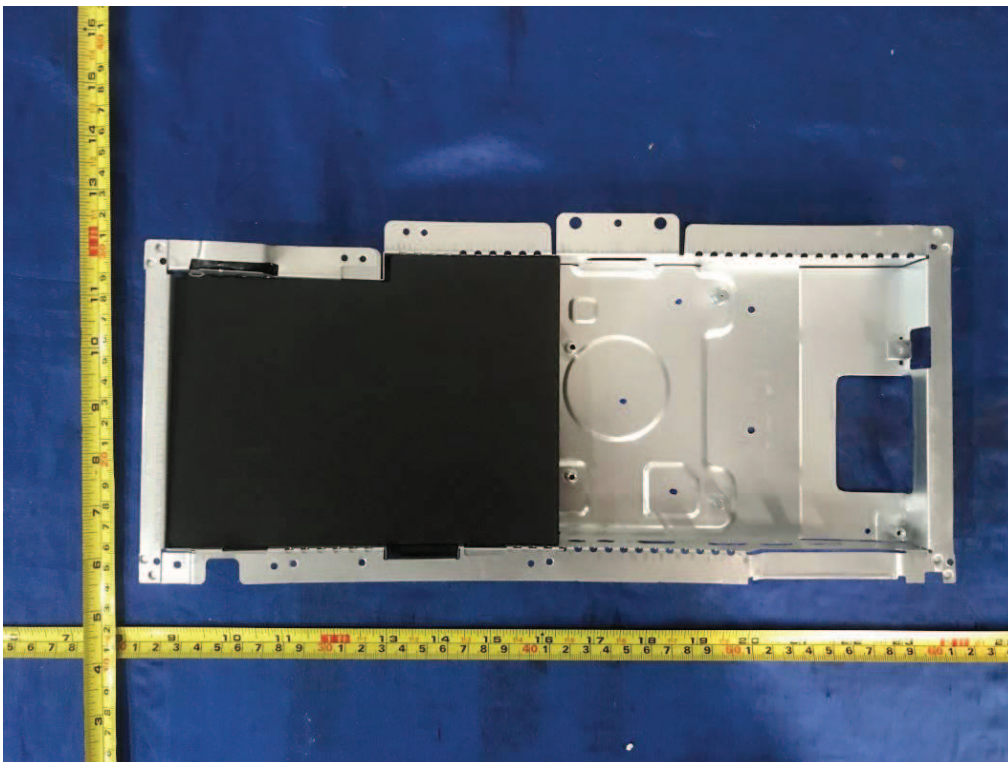

Figure 14. Internal view of metal enclosure A

Product: LCD MONITOR (LED backlight)

Type Designation: See Page 2 of report No. 60436687 001 for model list

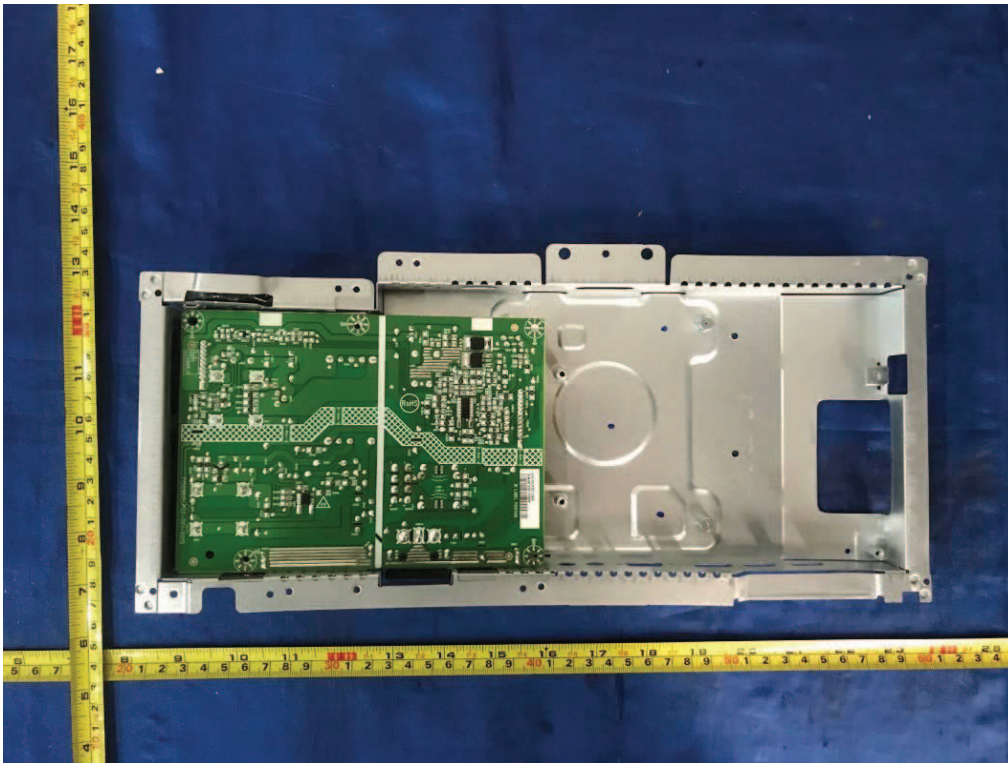

Figure 15. Internal view of metal enclosure A

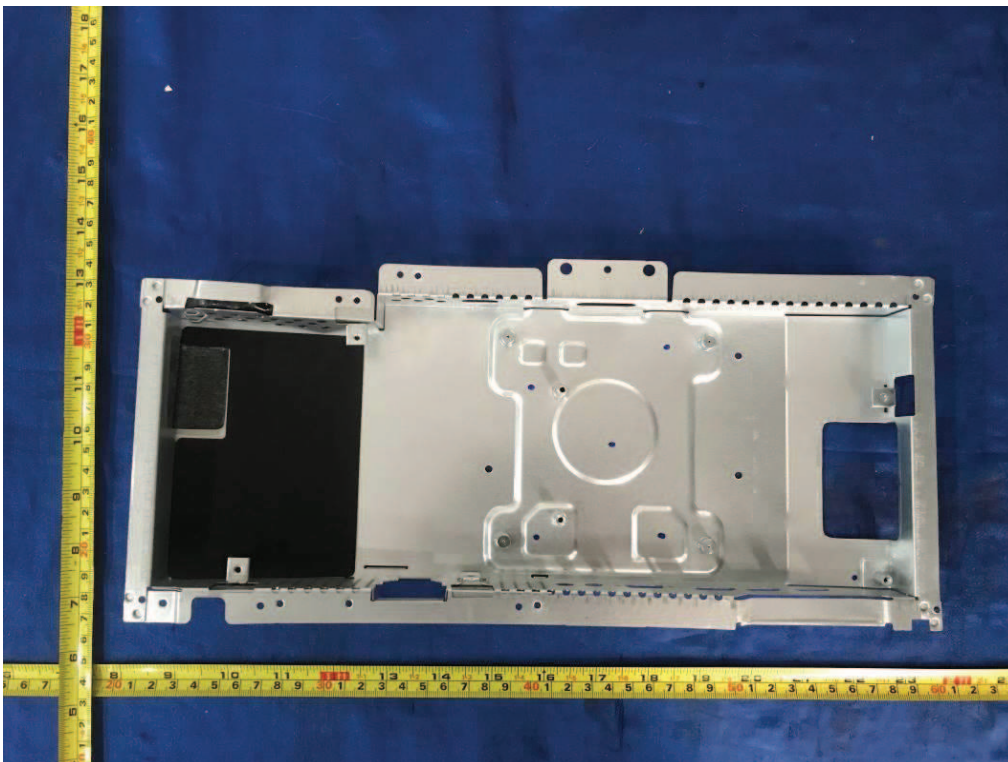

Figure 16. Internal view of metal enclosure A

Product: LCD MONITOR (LED backlight)

Type Designation: See Page 2 of report No. 60436687 001 for model list

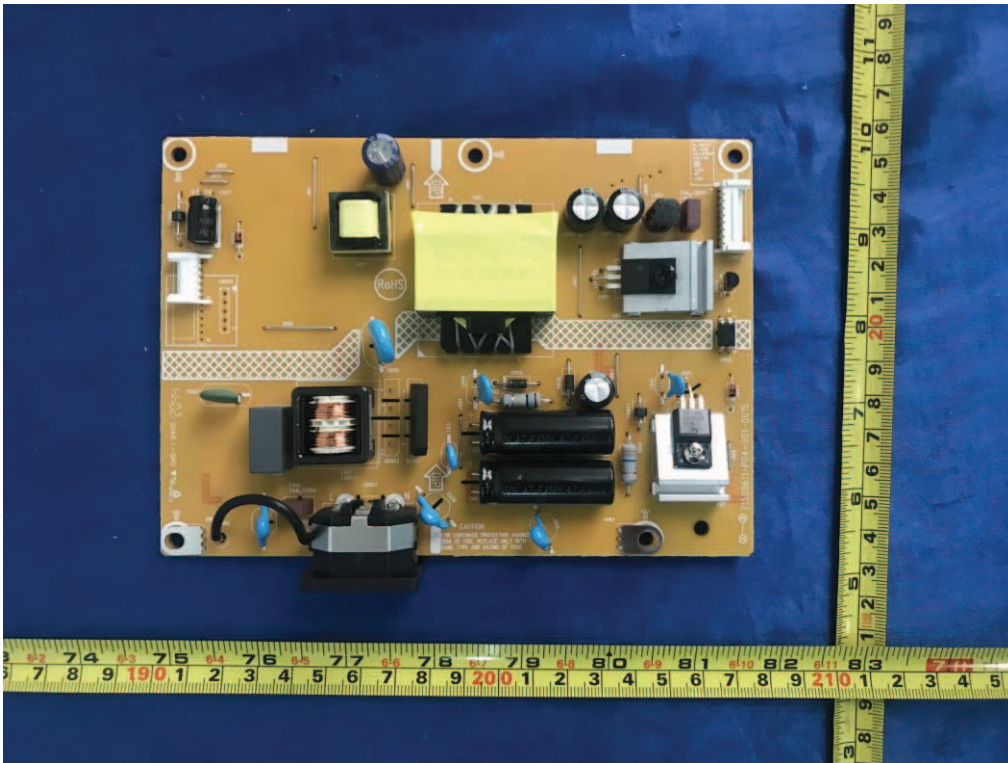

Figure 17. Power board 715G9611

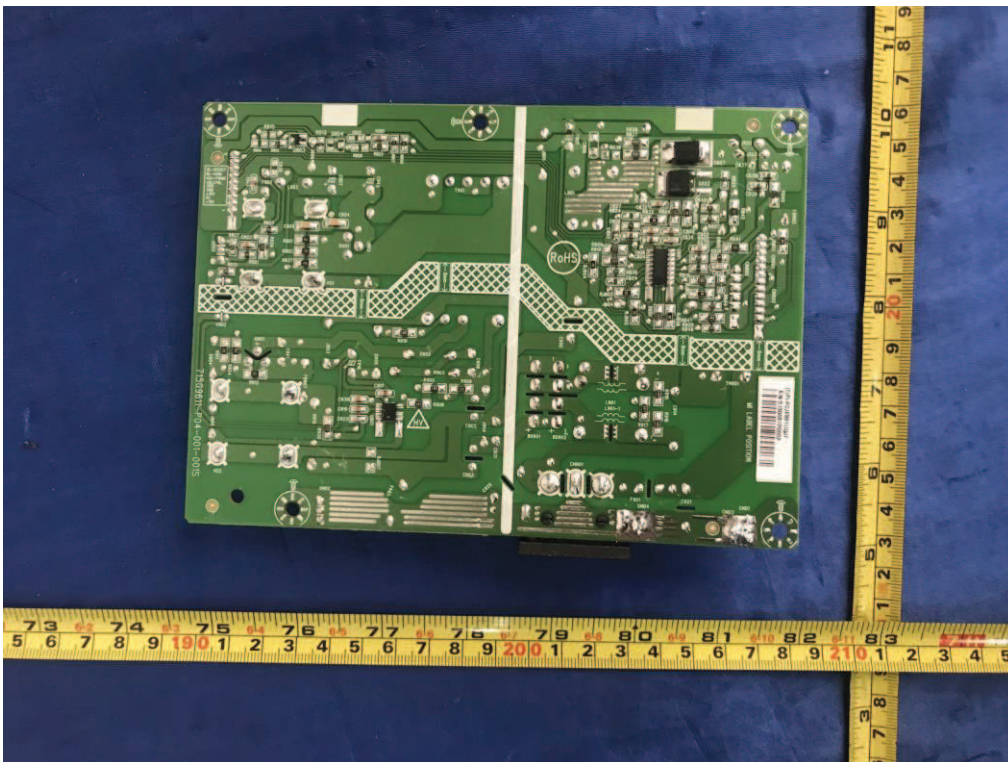

Figure 18. Power board 715G9611

Product: LCD MONITOR (LED backlight)

Type Designation: See Page 2 of report No. 60436687 001 for model list

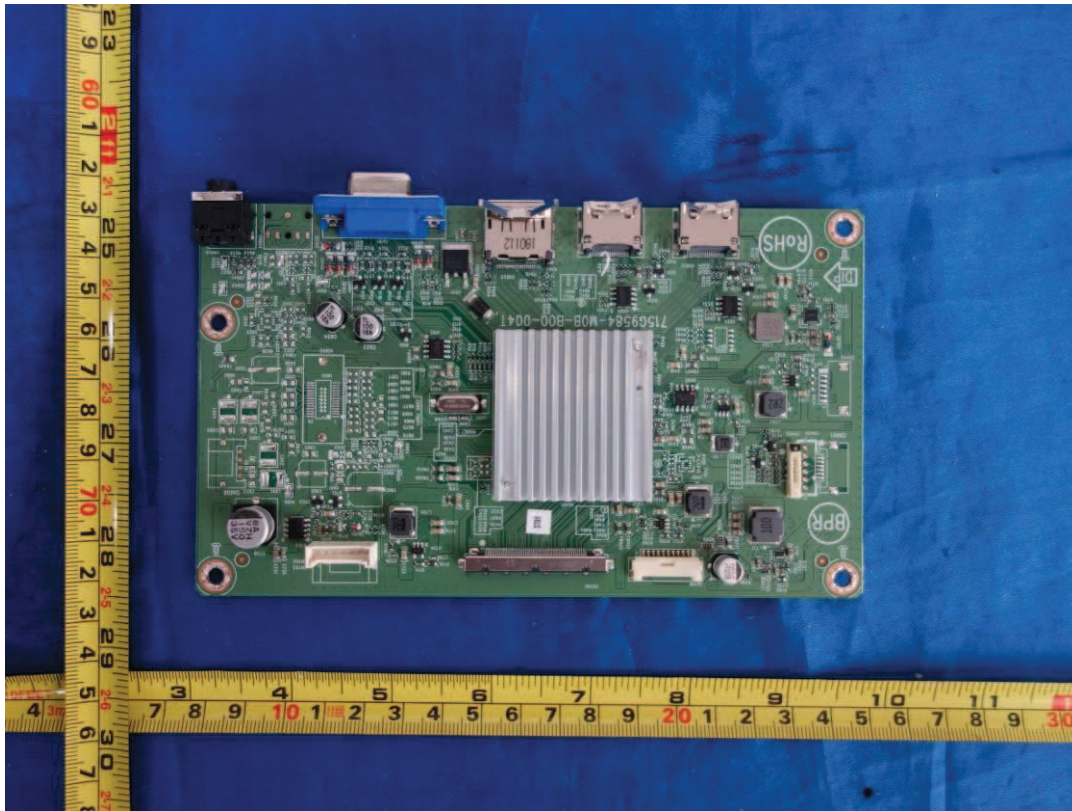

Figure 19. Main board 715G9584

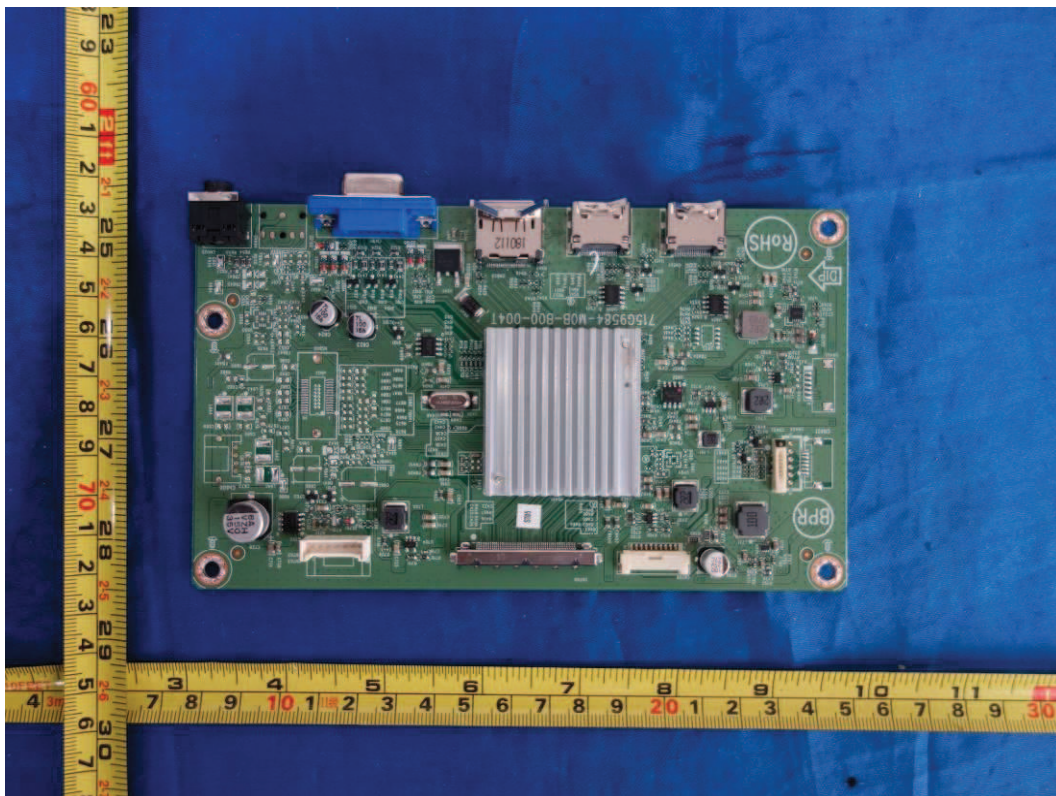

Figure 20. Main board 715G9584

Product: LCD MONITOR (LED backlight)

Type Designation: See Page 2 of report No. 60436687 001 for model list

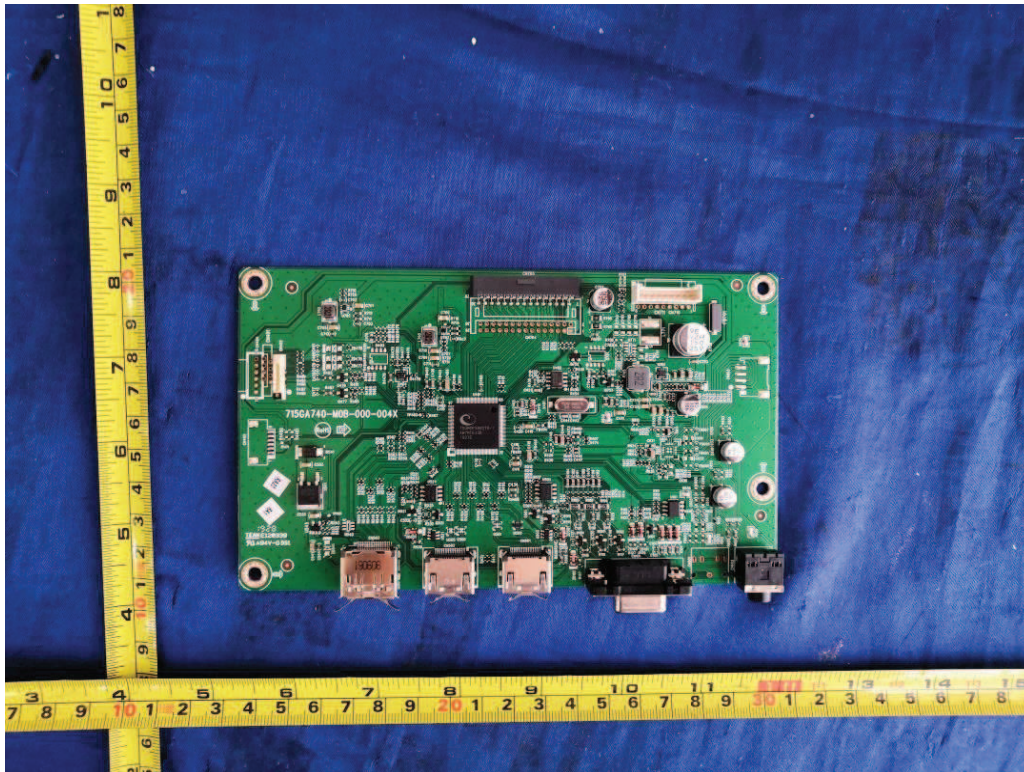

Figure 21. Main board 715GA740

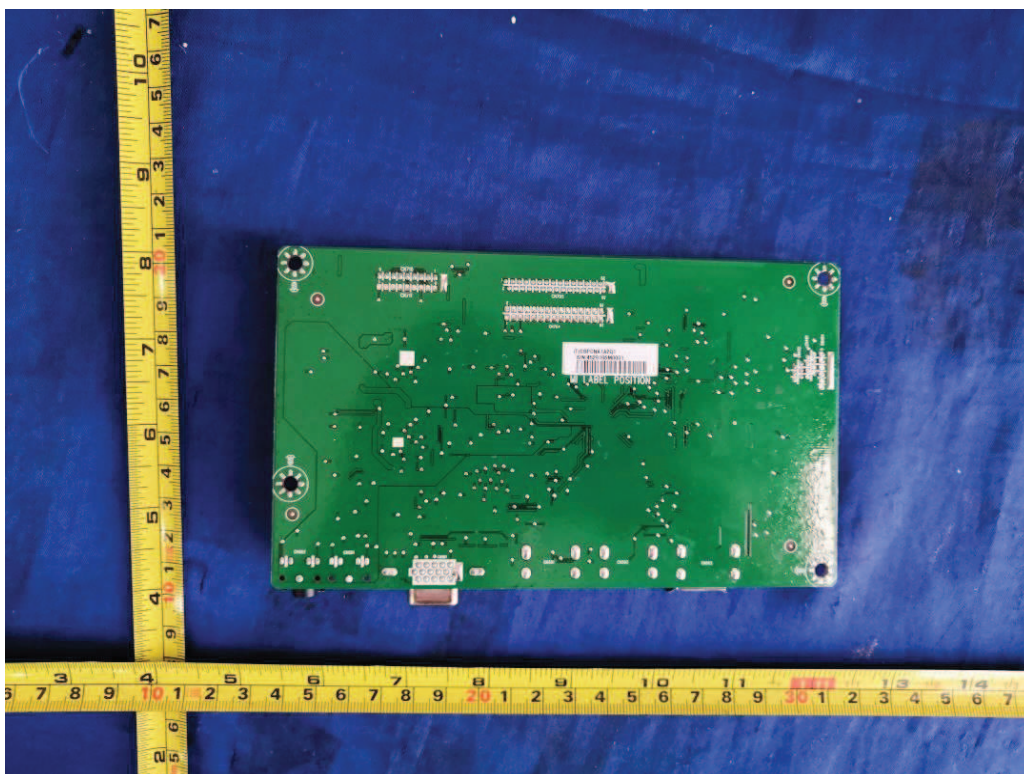

Figure 22. Main board 715GA740

Product: LCD MONITOR (LED backlight)

Type Designation: See Page 2 of report No. 60436687 001 for model list

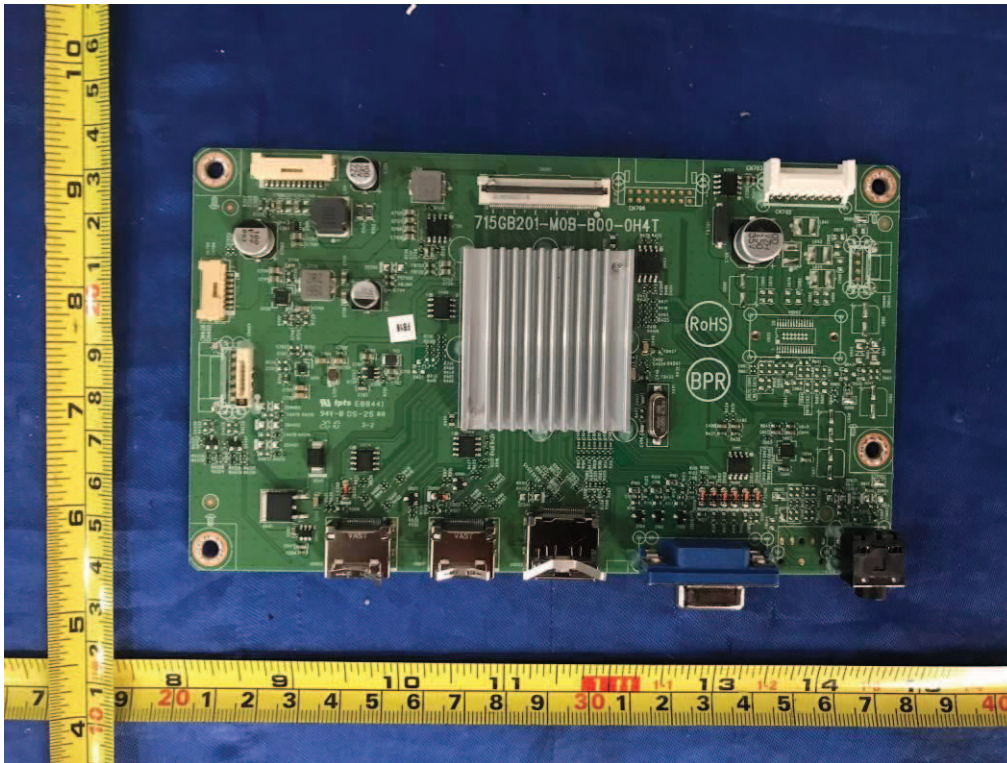

Figure 23. Main board 715GB201 without AUDIO port and without USB board port

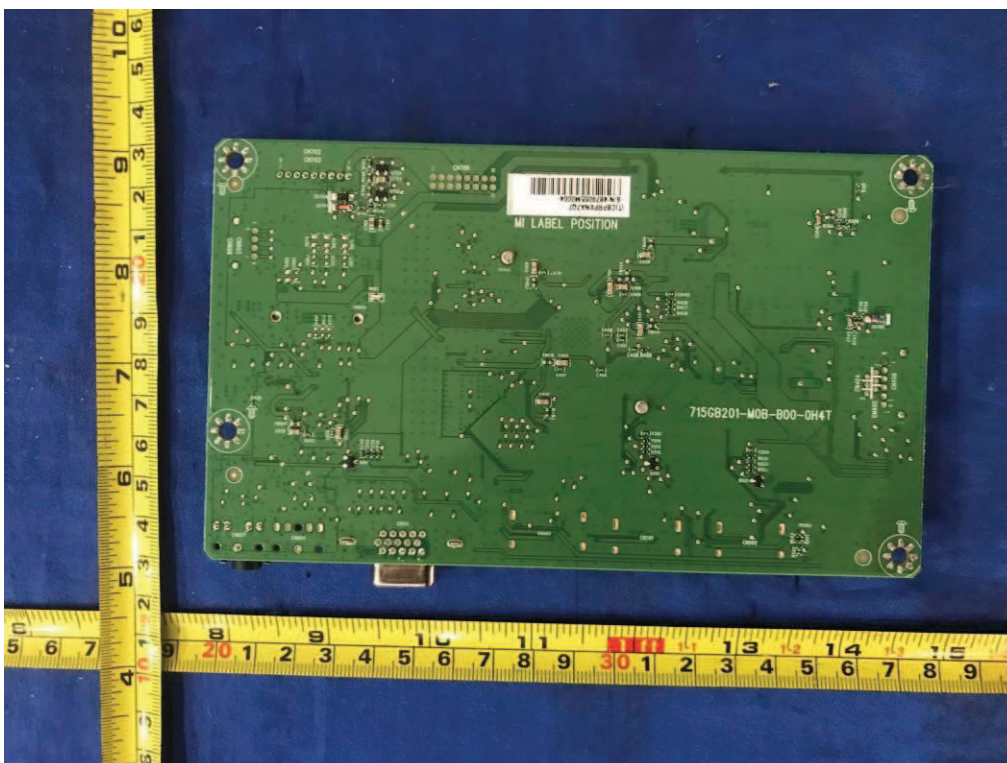

Figure 24. Main board 715GB201 without AUDIO port and without USB board port

Product: LCD MONITOR (LED backlight)

Type Designation: See Page 2 of report No. 60436687 001 for model list

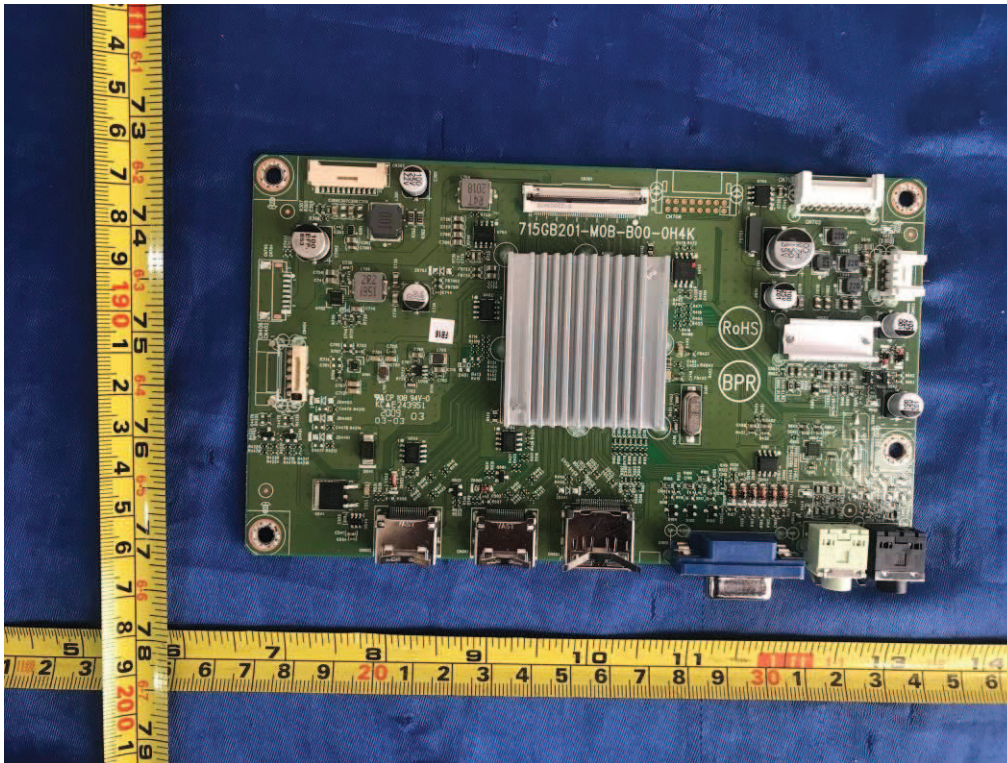

Figure 25. Main board 715GB201 with AUDIO port and with USB board port

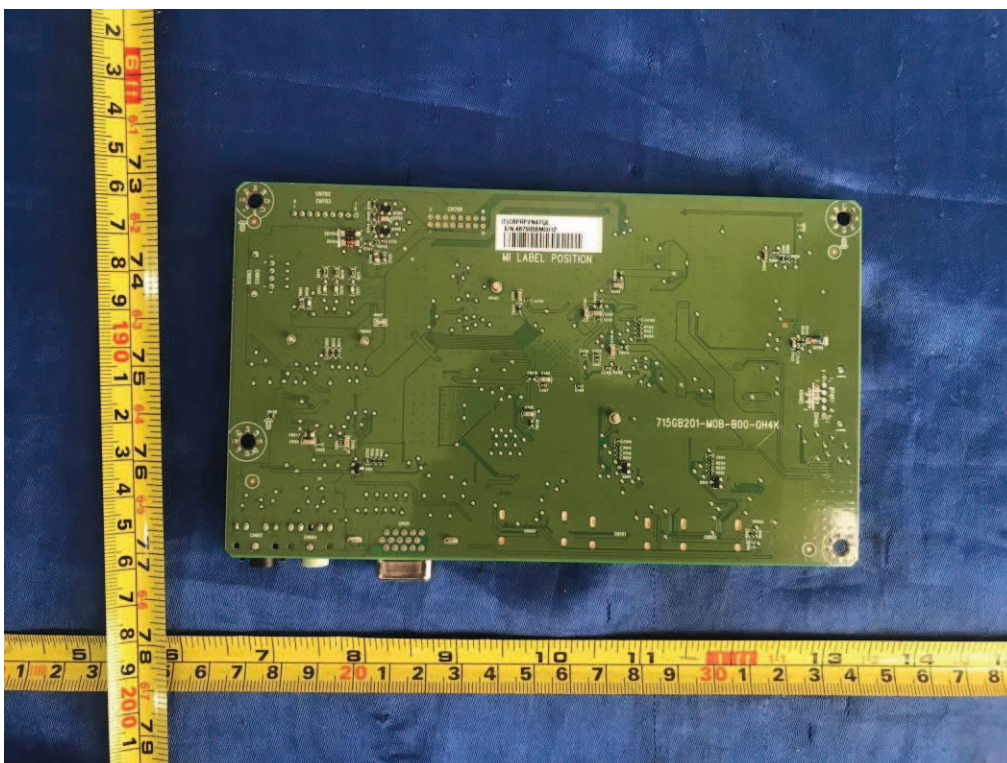

Figure 26. Main board 715GB201 with AUDIO port and with USB board port

Product: LCD MONITOR (LED backlight)

Type Designation: See Page 2 of report No. 60436687 001 for model list



Figure 27. Front view of horizon position for 27.0 inch models



Figure 28. Front view of horizon position for 27.0 inch models

Product: LCD MONITOR (LED backlight)

Type Designation: See Page 2 of report No. 60436687 001 for model list



Figure 29. Main board 715G9500 used for 27.0 inch models

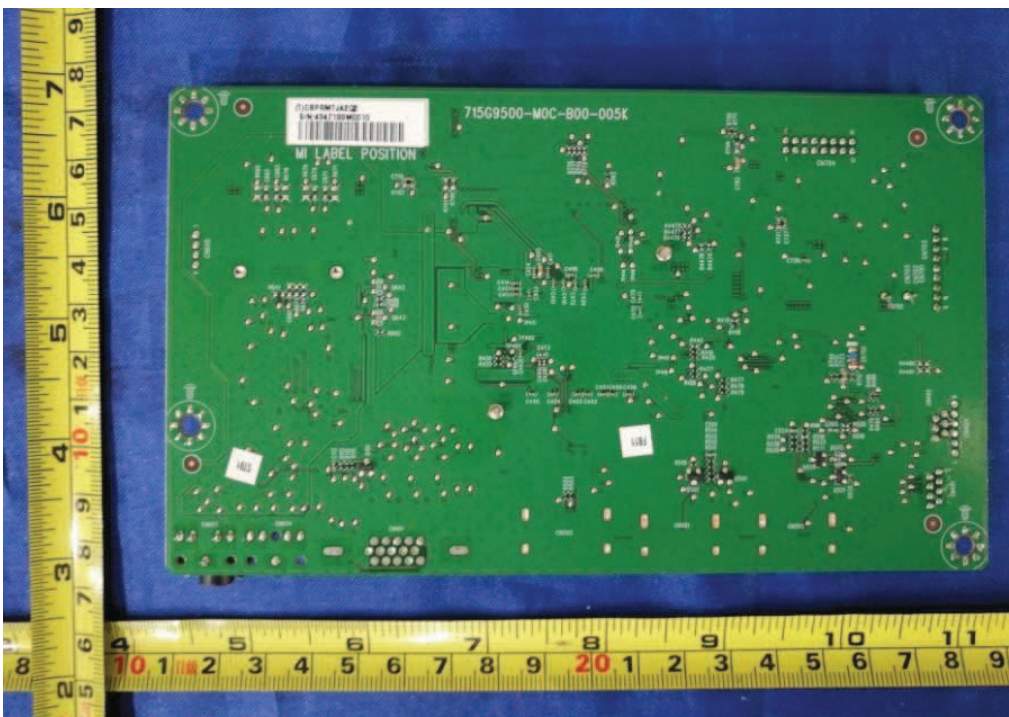

Figure 30. Main board 715G9500 used for 27.0 inch models

Product: LCD MONITOR (LED backlight)

Type Designation: See Page 2 of report No. 60436687 001 for model list



Figure 31. Main board 715GA531 used for 27.0 inch models

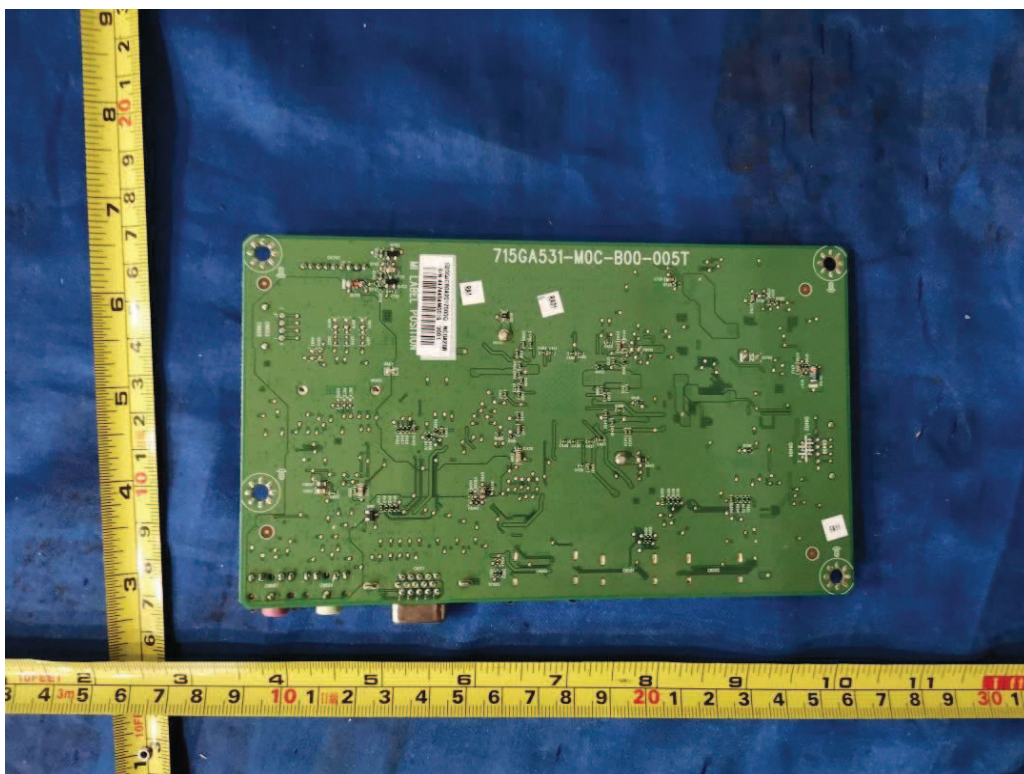

Figure 32. Main board 715GA531 used for 27.0 inch models

Product: LCD MONITOR (LED backlight)

Type Designation: See Page 2 of report No. 60436687 001 for model list



Figure 33. Front view of 27 inch model with flat LCD panel



Figure 34. Front view of 27 inch model with flat LCD panel

Product: LCD MONITOR (LED backlight)

Type Designation: See Page 2 of report No. 60436687 001 for model list

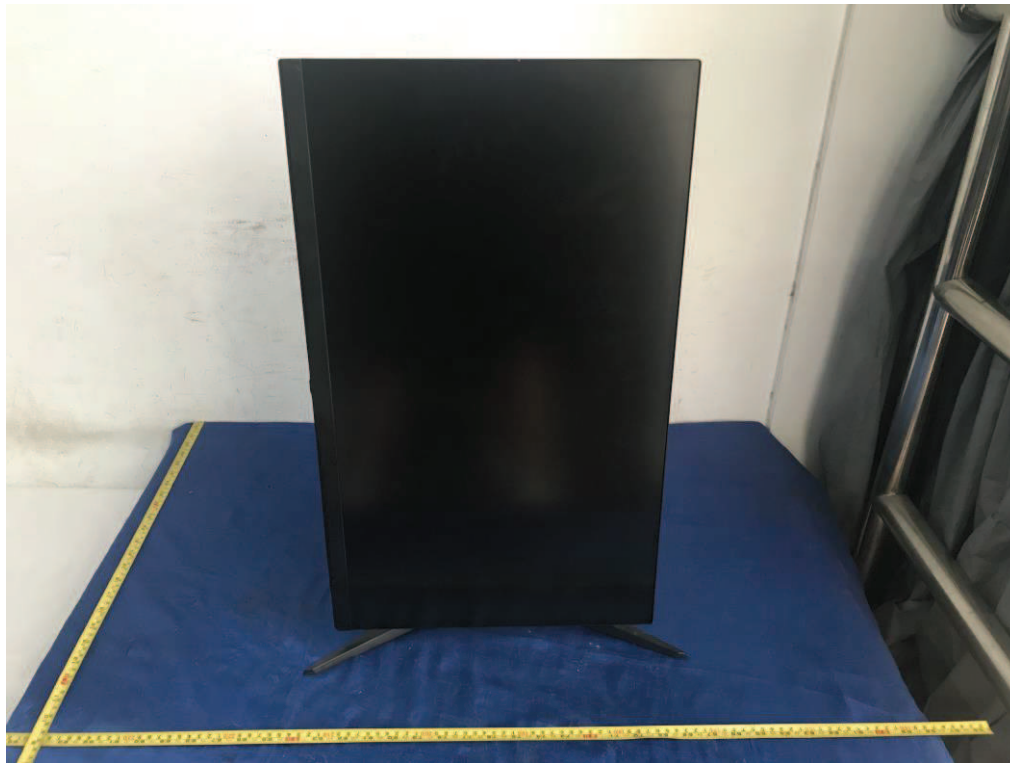

Figure 35. Front view of 27 inch model with flat LCD panel (vertical position)



Figure 36. Front view of 27 inch model with flat LCD panel (vertical position)

Product: LCD MONITOR (LED backlight)

Type Designation: See Page 2 of report No. 60436687 001 for model list



Figure 37. Metal enclosure Type B



Figure 38. Metal enclosure Type B

Product: LCD MONITOR (LED backlight)

Type Designation: See Page 2 of report No. 60436687 001 for model list

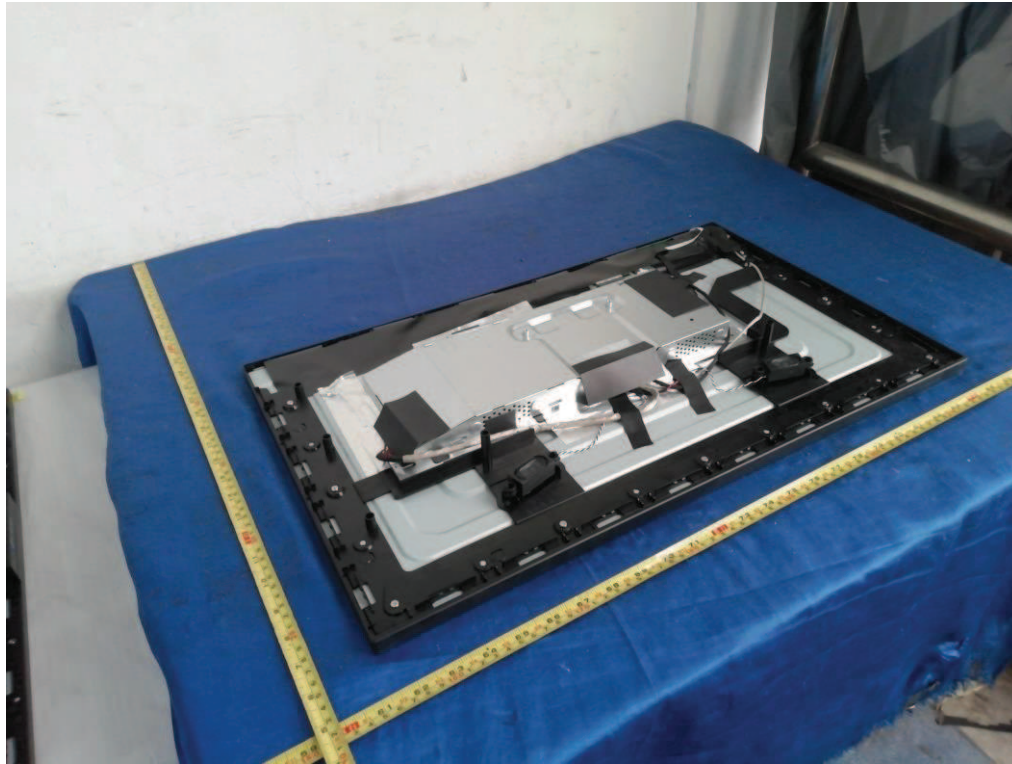

Figure 39. Metal enclosure Type B



Figure 40. Internal view of metal enclosure Type B

Product: LCD MONITOR (LED backlight)

Type Designation: See Page 2 of report No. 60436687 001 for model list

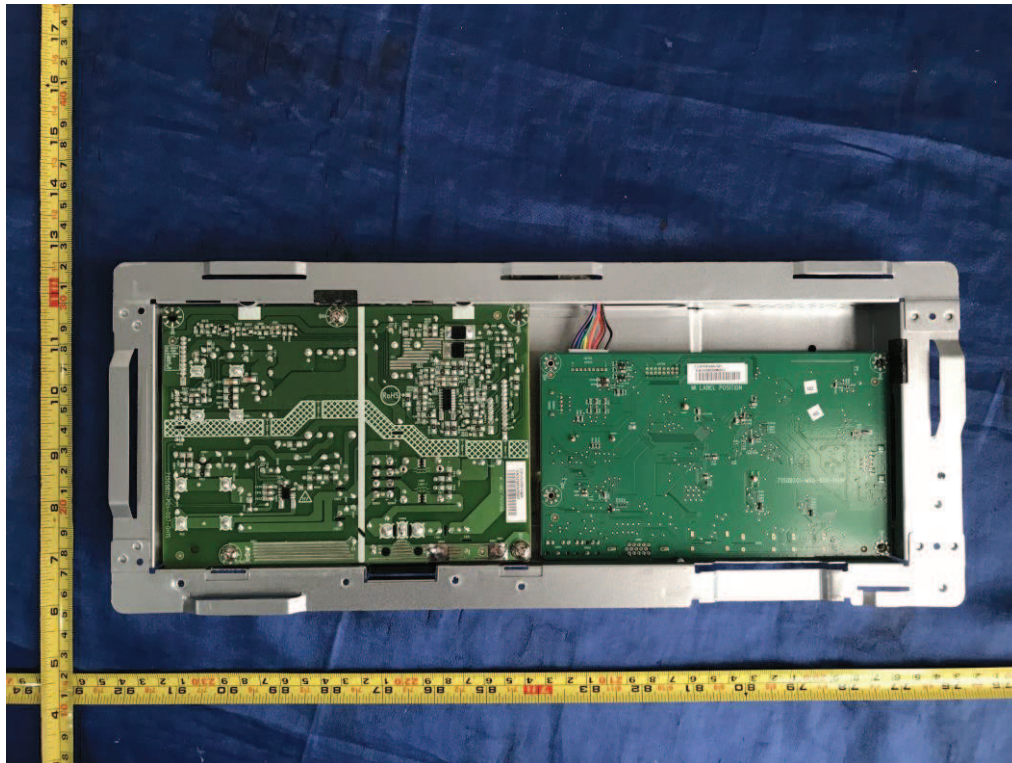

Figure 41. Internal view of metal enclosure Type B

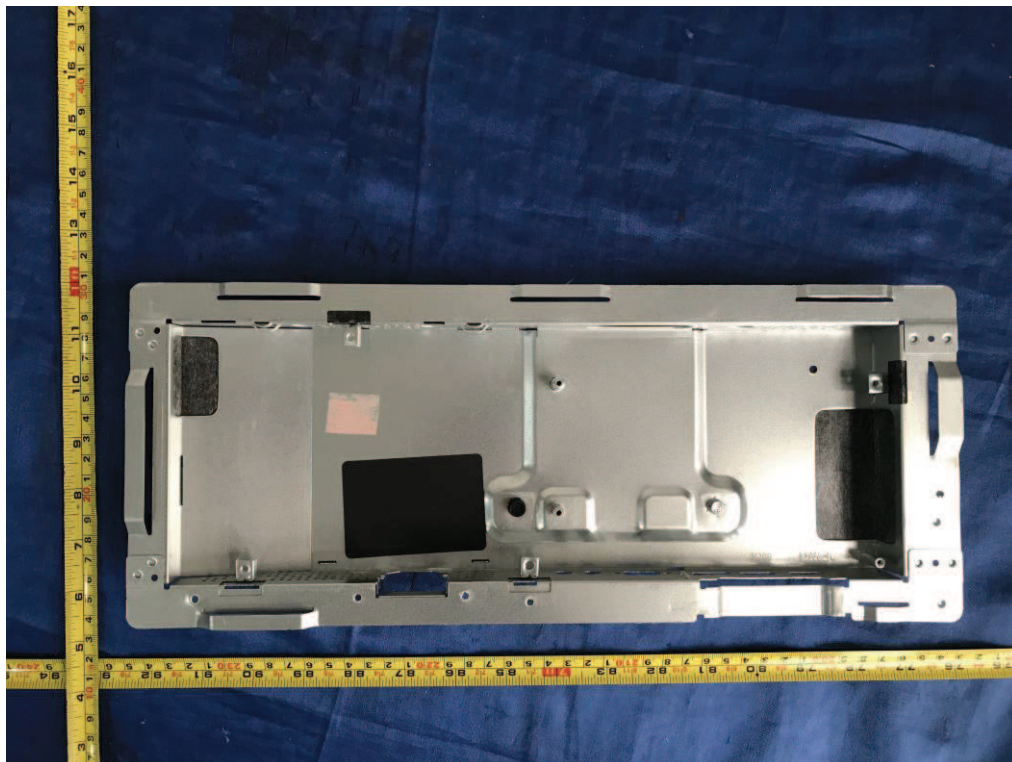

Figure 42. Internal view of metal enclosure Type B

Product: LCD MONITOR (LED backlight)

Type Designation: See Page 2 of report No. 60436687 001 for model list

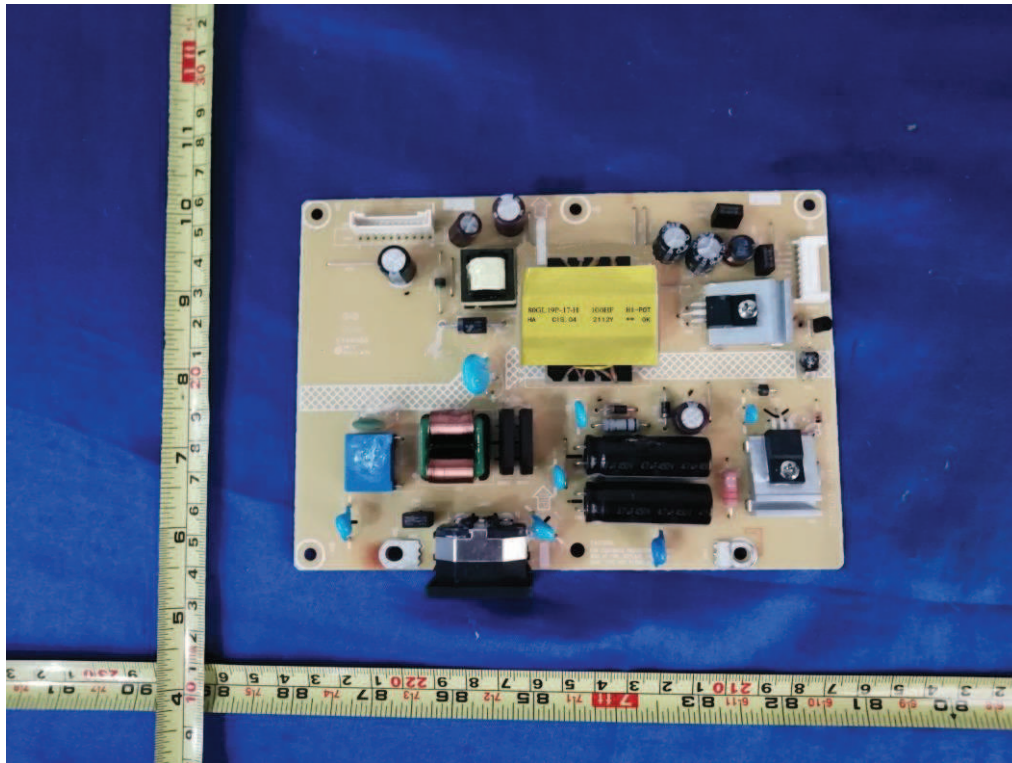

Figure 43. Power board 715GC031

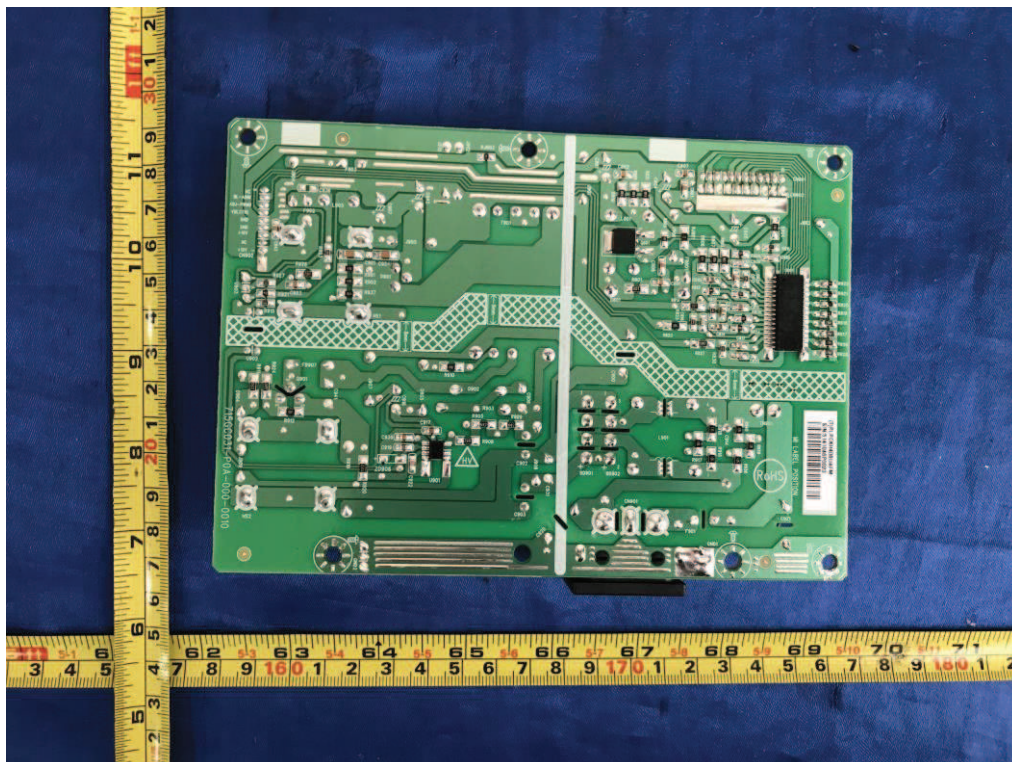

Figure 44. Power board 715GC031

Product: LCD MONITOR (LED backlight)

Type Designation: See Page 2 of report No. 60436687 001 for model list

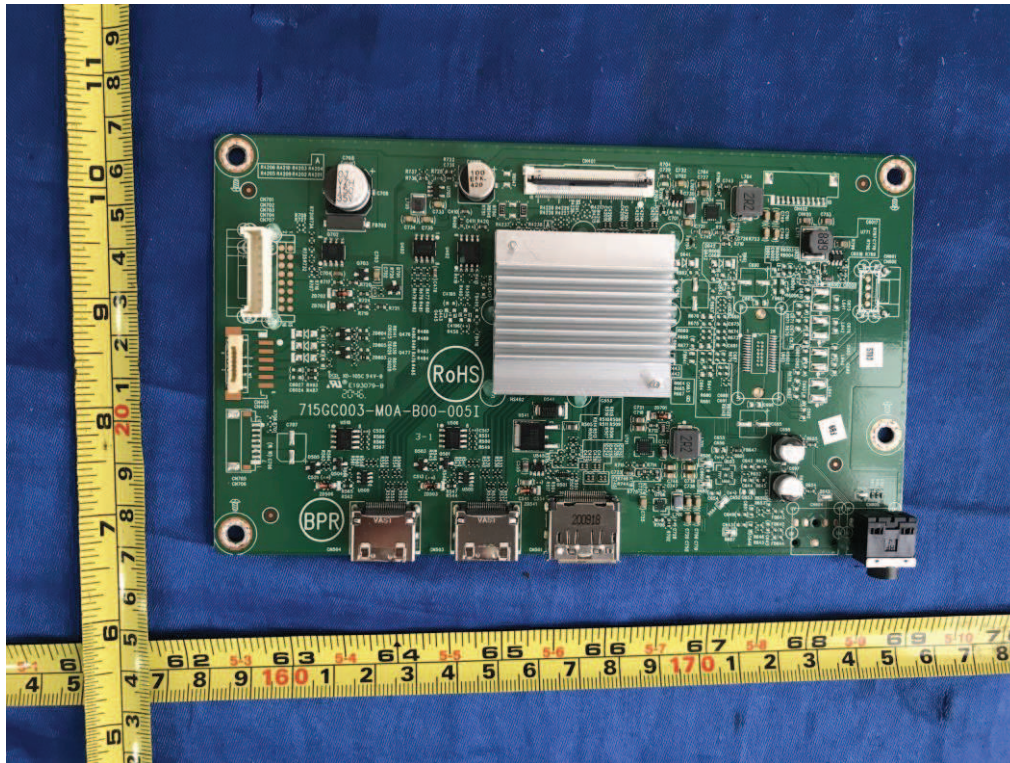

Figure 45. Main board 715GC003

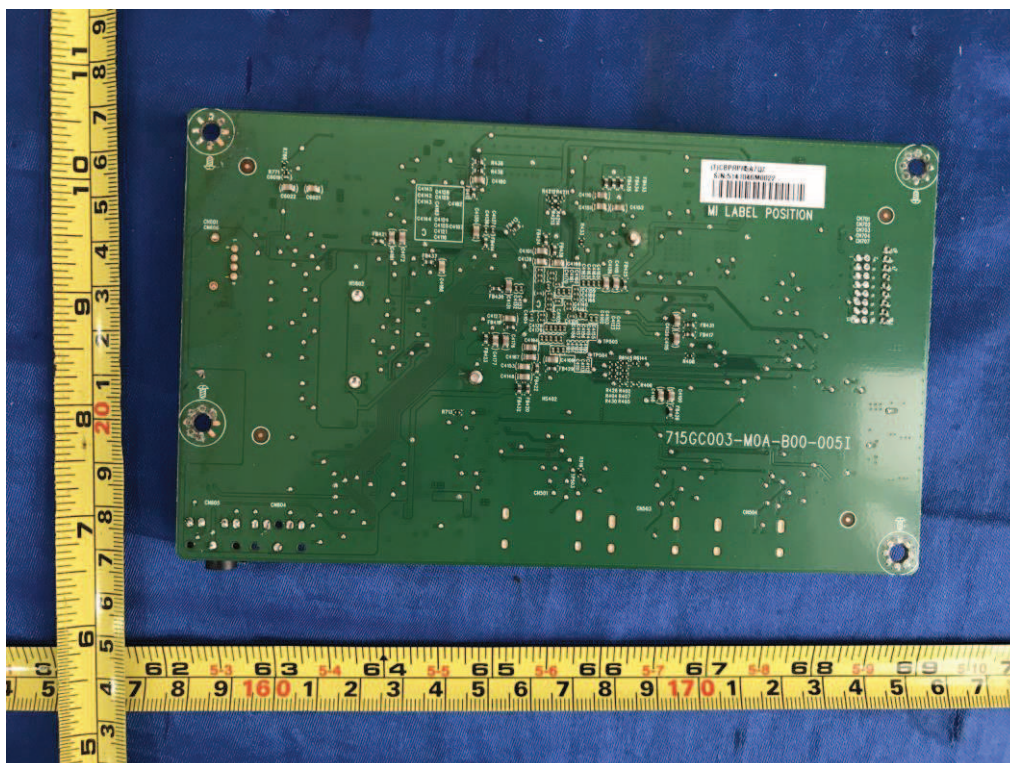

Figure 46. Main board 715GC003

Product: LCD MONITOR (LED backlight)

Type Designation: See Page 2 of report No. 60436687 001 for model list

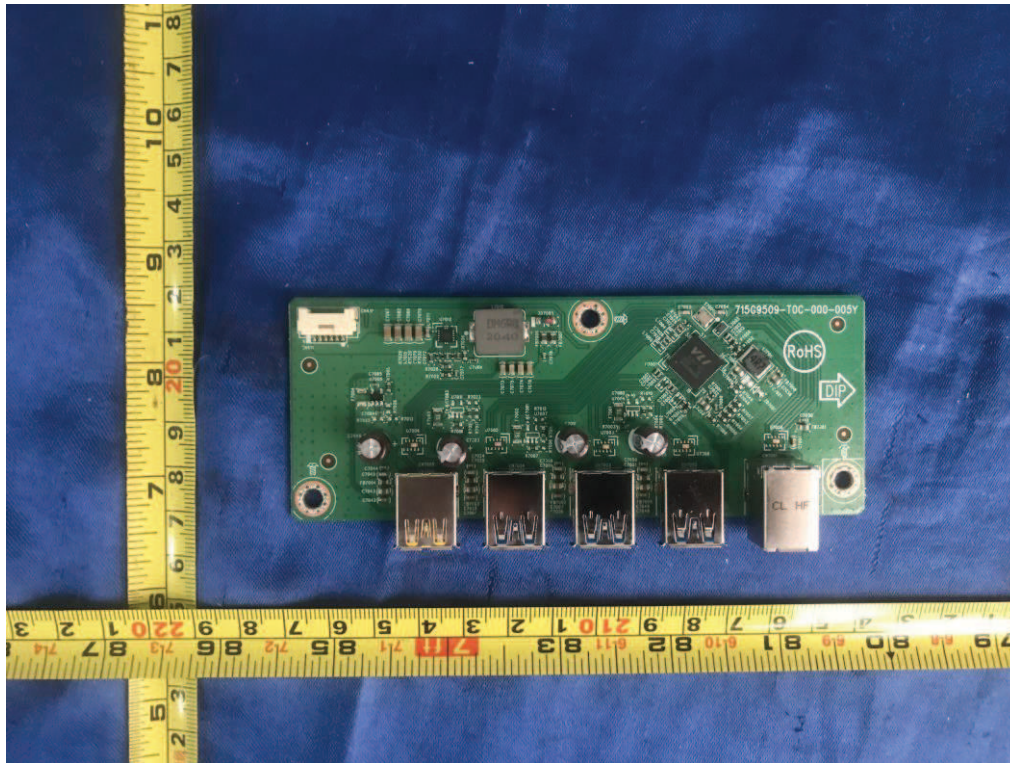

Figure 47. USB board 715G9509

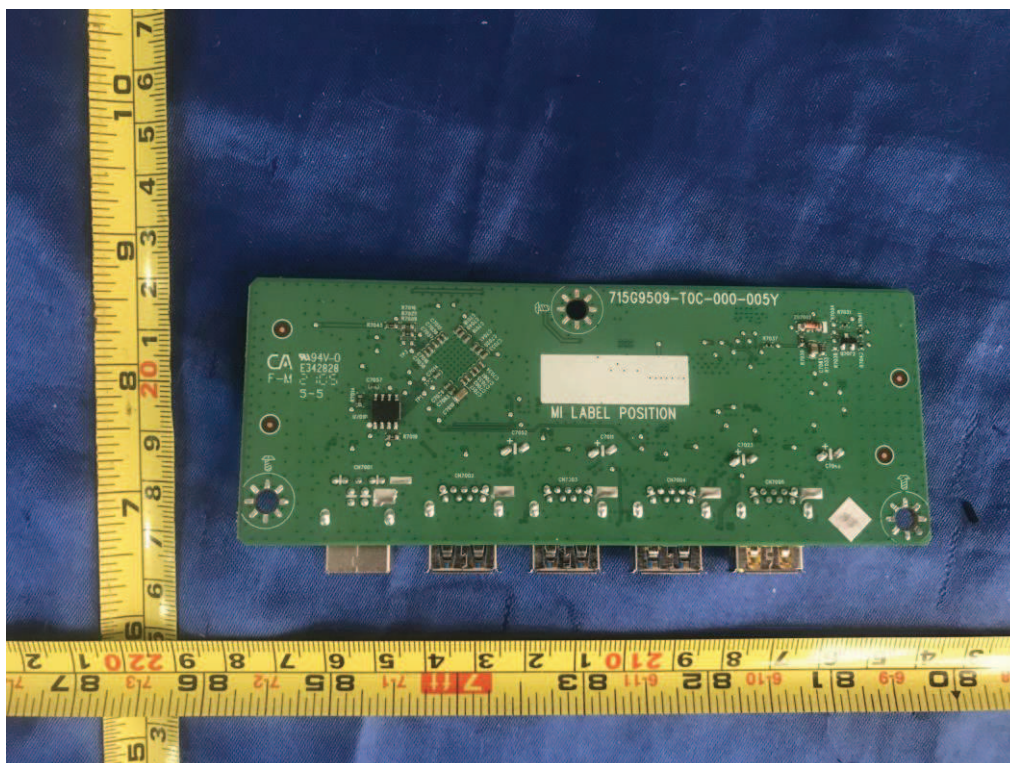

Figure 48. USB board 715G9509

Product: LCD MONITOR (LED backlight)

Type Designation: See Page 2 of report No. 60436687 001 for model list



Figure 49. Front view of 24 inch model with flat LCD panel



Figure 50. Front view of 24 inch model with flat LCD panel

Product: LCD MONITOR (LED backlight)

Type Designation: See Page 2 of report No. 60436687 001 for model list



Figure 51. Front view of 24 inch model with flat LCD panel (vertical position)



Figure 52. Front view of 27 inch model with flat LCD panel (vertical position)

Product: LCD MONITOR (LED backlight)

Type Designation: See Page 2 of report No. 60436687 001 for model list

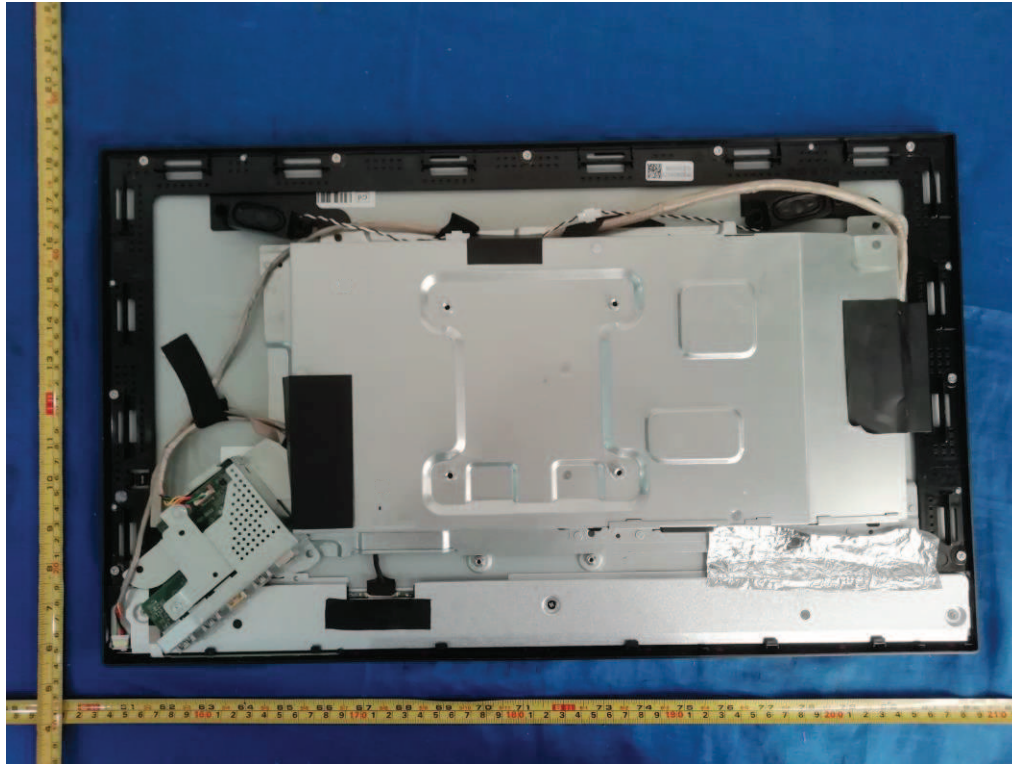

Figure 53. Metal enclosure Type C

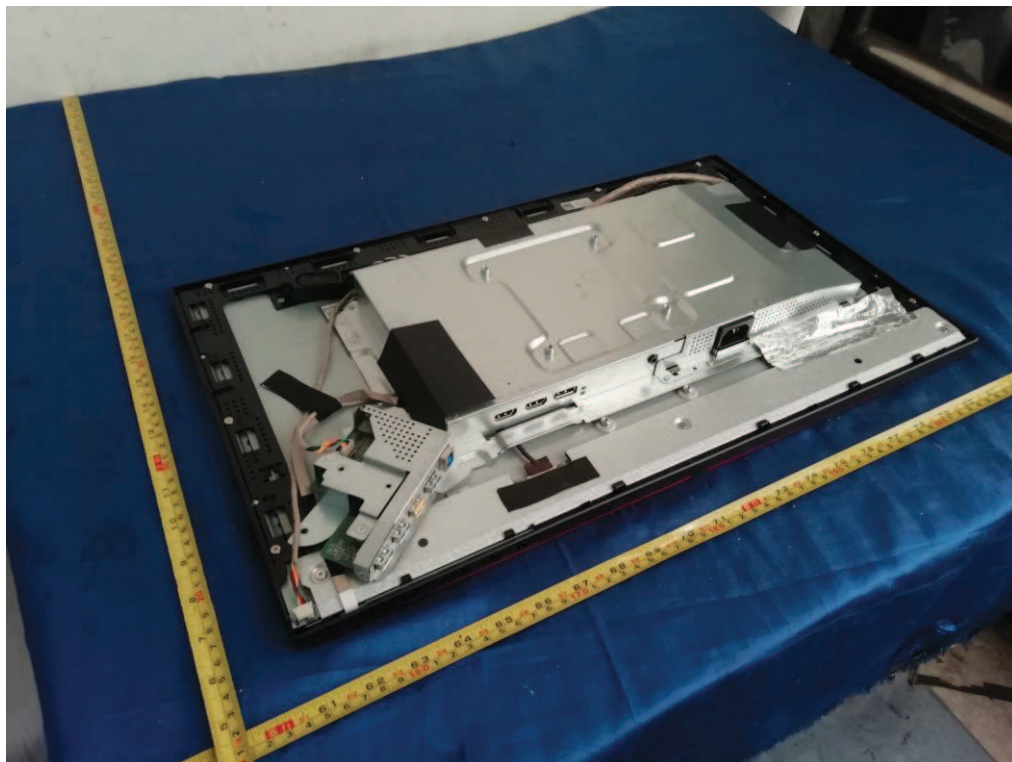

Figure 54. Metal enclosure Type C

Product: LCD MONITOR (LED backlight)

Type Designation: See Page 2 of report No. 60436687 001 for model list



Figure 55. Metal enclosure Type C



Figure 56. Internal view of metal enclosure Type C

Product: LCD MONITOR (LED backlight)

Type Designation: See Page 2 of report No. 60436687 001 for model list

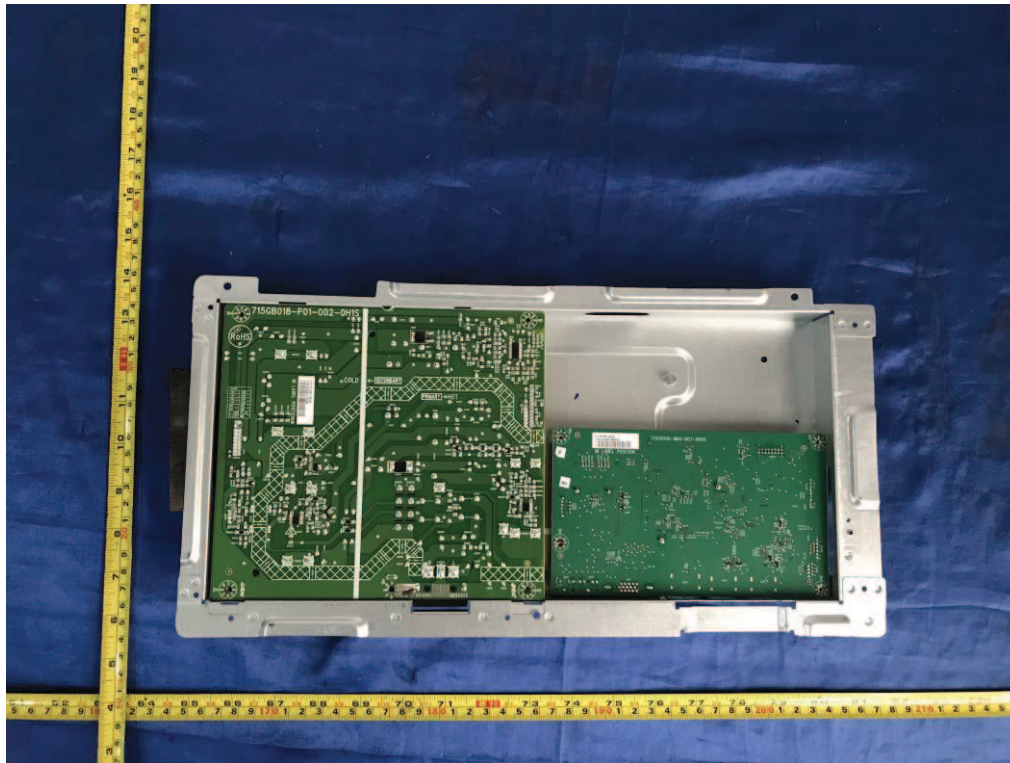

Figure 57. Internal view of metal enclosure Type C

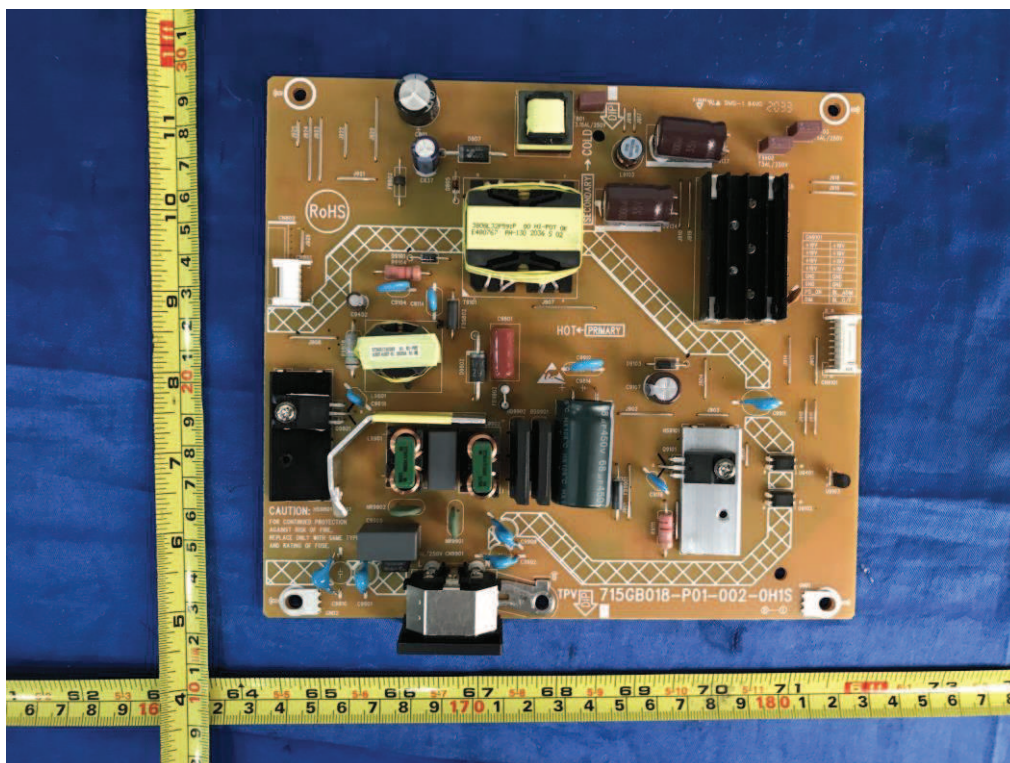

Figure 58. Power board 715GB018

Product: LCD MONITOR (LED backlight)

Type Designation: See Page 2 of report No. 60436687 001 for model list

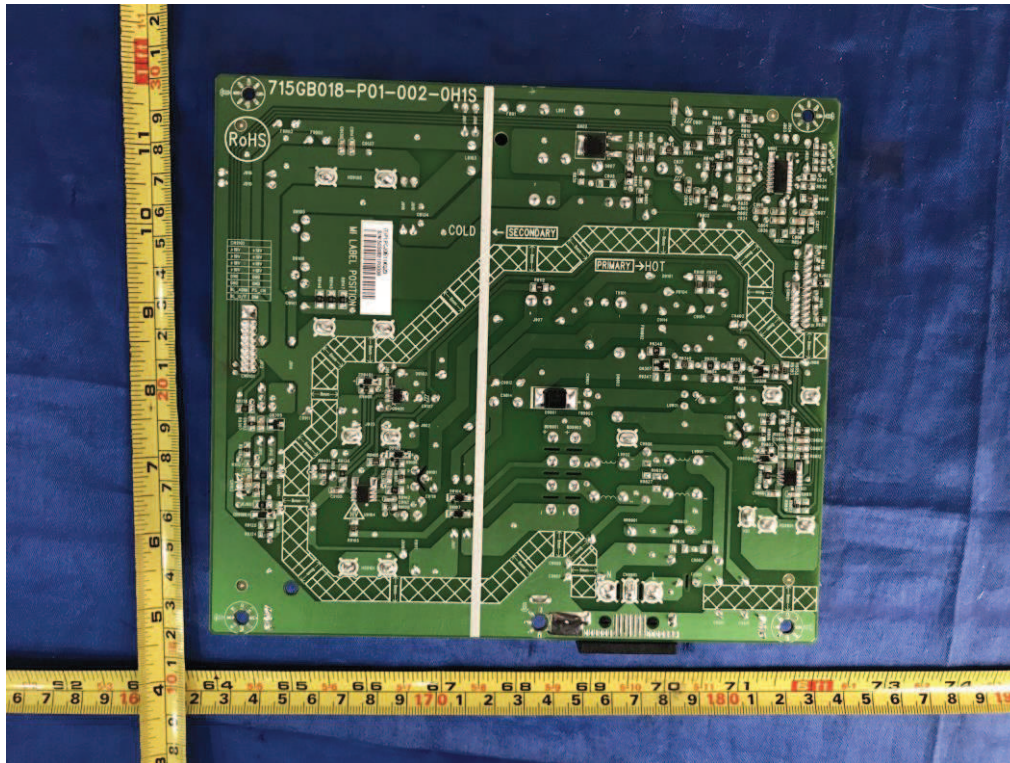

Figure 59. Power board 715GB018