

ATTESTATION OF CONFORMITY



Date of Issue: 2015/05/18
Attestation Number: 1505028

Product: LCD Monitor

Model No.: 270LM00009, G2770***

(The "*" could be any alphanumeric character including blank for marketing differentiation.)

Applicant: TPV Electronics (Fujian) Co., Ltd.

Address: Rongqiao Economic and Technological Development Zone,
Fuqing City, Fujian Province, P.R. China

And, in accordance to the following Applicable Directives

Applicable to ANSI C63.4 – 2009

(The Information Technology Equipment)

That this product has been assessed against the following Applicable Standards

CISPR PUB. 22, FCC Part 15 Subpart B, Canada ICES-003 issue 5

CERPASS hereby acknowledges that:

The measurements shown in this test report may issue a DECLARATION of CONFORMITY and apply the FCC mark in accordance to European Union Rules.

Attestation by:

A handwritten signature in blue ink that reads "Hill Chen".

Hill Chen / Manager

2015/05/18

Date



FCC DOC TEST REPORT

Applicant : TPV Electronics (Fujian) Co., Ltd.
Address : Rongqiao Economic and Technological
Development Zone, Fuqing City, Fujian Province,
P.R. China
Equipment : LCD Monitor
Model No. : 270LM00009, G2770***

I HEREBY CERTIFY THAT :

The sample was received on May 12, 2015 and the testing was carried out on May 14, 2015 at CerpPASS Technology Corp. The test result refers exclusively to the test presented test model / sample. Without written approval of CerpPASS Technology Corp., the test report shall not be reproduced except in full.

Approved by:

Hill Chen / Manager

Laboratory Accreditation:

CerpPASS Technology Corporation Test Laboratory





Contents

1. Summary of Test Procedure and Test Result.....	4
1.1. Applicable Standards	4
2. Test Configuration of Equipment under Test	5
2.1. Feature of Equipment under Test.....	5
2.2. Test Manner	5
2.3. Description of Test System.....	6
2.4. General Information of Test.....	7
2.5. Measurement Uncertainty	7
3. Test of Conducted Emission.....	8
3.1. Test Limit	8
3.2. Test Procedures	8
3.3. Typical test Setup.....	9
3.4. Measurement Equipment.....	9
3.5. Test Result and Data.....	10
3.6. Test Photographs	12
4. Test of Radiated Emission	13
4.1. Test Limit	13
4.2. Test Procedures	13
4.3. Typical test Setup.....	14
4.4. Measurement Equipment.....	15
4.5. Test Result and Data (30MHz~1GHz).....	16
4.6. Test Result and Data (1GHz ~ 15GHz).....	18
4.7. Test Photographs (30MHz ~ 1GHz).....	20
4.8. Test Photographs (1GHz ~ 18GHz)	21
5. Photographs of EUT	22



History of this test report

ORIGINAL.

Additional attachment as following record:

Attachment No.	Issue Date	Description



1. Summary of Test Procedure and Test Result

1.1. Applicable Standards

The measurements shown in this test report were made in accordance with the procedures given in ANSI C63.4 – 2009 and the energy emitted by this equipment was passed Part 2, Part 15, CISPR PUB. 22 and Canada ICES-003 Issue 5.

The energy emitted by this equipment was passed both Radiated and Conducted Emissions Class B limits.

Test Item	Normative References	Test Result	Remarks
Conducted Emission	ANSI C63.4-2009 FCC Part 15 Subpart B ICES-003 Issue 5	PASS	Meets Class B Limit Minimum passing margin(QP) is -14.14 dB at 27.6660 MHz
Radiated Emission	ANSI C63.4-2009 FCC Part 15 Subpart B ICES-003 Issue 5	PASS	Meets Class B Limit Minimum passing margin(QP) is -4.11 dB at 500.53 MHz



2. Test Configuration of Equipment under Test

2.1. Feature of Equipment under Test

LCD Monitor	Model No :	270LM00020, G2770*** (The "***" could be any alphanumeric character including blank for marketing differentiation.)
Please refer to the user's manual.		

2.2. Test Manner

- a. During testing, the interface cables and equipment positions were varied according to ANSI C63.4.
- b. The complete test system included PC, Keyboard, Mouse, Printer, iPod, Earphone, USB 3.0 HDD and EUT for EMI test.
- c. The test modes of EMI test as follow:
 - Test Mode 1. VGA: 1920 x 1080@60Hz
 - Test Mode 2. DVI: 1920 x 1080@144Hz
 - Test Mode 3. HDMI: 1920 x 1080@144Hz
 - Test Mode 4. DP: 1920 x 1080@144Hz
 - Test Mode 5. HDMI: 1280 x 1080@75Hz
 - Test Mode 6. HDMI: 640 x 480@60Hzcaused "Test Mode 3" generated the worst case, it was reported as the final data.
- d. Two executive programs, "BURNIN.EXE" & "MYWINH" under WIN 7, which generates a complete line of continuously repeating "H" pattern was used as the test software.
The programs were executed as follows:
 1. Turn on the power of all equipment.
 2. The PC reads the test program from the hard disk drive and runs it.
 3. The PC sends "H" messages to the EUT, and the EUT displays "H" patterns on the screen.
 4. The PC sends "H" messages to the internal Hard Disk, and the Hard Disk reads and writes the message.
 5. The PC sends "H" messages to the printer, then the printer prints them on the paper.
 6. Repeat the steps from 2 to 5.
- e. An executive program, "COLORBAR.EXE" was executed to play 1kHz signals.
- f. The maximum operating frequency is above 108MHz, the test frequency range is from 30MHz to 18GHz.



2.3. Description of Test System

Device	Manufacturer	Model No.	Description
PC	DELL	XPS8500	Power Cable, Non-Shielded, 1.8m
Keyboard	DELL	SK-8175	Data Cable, USB Shielding 1.85m
Mouse	DELL	MS111-P	Data Cable, USB Shielding 1.85m
Printer	HP	P1102w	Power Cable, Non-Shielded 1.8m Data Cable, USB Shielding 1.6m
iPod	APPLE	A1320	Data Cable, USB Shielding 1.0m
USB 3.0 HDD*4	WD	WD1600BEVT/P	Data Cable, USB Shielding 1.0m
Earphone	INTOPIC	JAZZ-269	Data Cable, Audio Shielding 1.35m

Use Cable:

Cable	Quantity	Description
VGA	1	Shielding, 1.8m & 1.5m, with two ferrite cores bonded
DVI	1	Shielding, 1.8m & 1.5m, with two ferrite cores bonded
HDMI	1	Shielding, 1.8m & 1.5m
DP	1	Shielding, 1.8m & 1.5m
Audio	1	Unshielding, 1.8m
USB A to B	1	Shielding, 1.8m



2.4. General Information of Test

Test Site :	CerpPASS Technology Corporation Test Laboratory Address: No.10, Ln. 2, Lianfu St., Luzhu Dist., Taoyuan City 33848, Taiwan (R.O.C.) Tel:+886-3-3226-888 Fax:+886-3-3226-881 Address: No.68-1, Shihbachongsi, Shihding Township, New Taipei City 223, Taiwan, R.O.C. Tel: +886-2-2663-8582
FCC Registration Number :	TW1079, TW1061,390316, 228391, 641184
IC Registration Number :	4934B-1, 4934E-1, 4934E-2
VCCI	T-2205 for Telecommunication Test C-4663 for Conducted emission test R-3428, R-4218 for Radiated emission test G-812, G-813 for radiated disturbance above 1GHz
Frequency Range Investigated :	Conducted Emission Test: from 150 kHz to 30 MHz Radiated Emission Test: from 30 MHz to 18,000 MHz
Test Distance :	The test distance of radiated emission below 1GHz from antenna to EUT is 10 M. The test distance of radiated emission above 1GHz from antenna to EUT is 3 M.

2.5. Measurement Uncertainty

Measurement Item	Measurement Frequency	Polarization	Uncertainty
Conducted Emission	9 kHz ~ 30 MHz	LINE / NEUTRAL	±3.25 dB
Radiated Emission	30 MHz ~ 1,000 MHz	Vertical / Horizontal	±3.93 dB
	1,000 MHz ~ 18,000 MHz	Vertical / Horizontal	±5.18 dB

The measurement uncertainty will be considered, when test result margin to the limit.



3. Test of Conducted Emission

3.1. Test Limit

Conducted Emissions were measured from 150 kHz to 30 MHz with a bandwidth of 9 KHz on the 120 VAC power and return leads of the EUT according to the methods defined in ANSI C63.4-2009 Section 3.1. The EUT was placed on a nonmetallic stand in a shielded room 0.8 meters above the ground plane as shown in section 2.2. The interface cables and equipment positioning were varied within limits of reasonable applications to determine the position produced maximum conducted emissions.

Conducted Emission Limits:

Frequency (MHz)	Quasi Peak (dB μ V)	Average (dB μ V)
0.15 – 0.5	66-56*	56-46*
0.5 – 5.0	56	46
5.0 – 30.0	60	50

3.2. Test Procedures

- The EUT was placed 0.4 meter from the conducting wall of the shielding room was kept at least 80 centimeters from any other grounded conducting surface.
- Connect EUT to the power mains through a line impedance stabilization network (LISN).
- All the support units are connecting to the other LISN.
- The LISN provides 50 ohm coupling impedance for the measuring instrument.
- The FCC states that a 50 ohm, 50 micro-Henry LISN should be used.
- Both sides of AC line were checked for maximum conducted interference.
- The frequency range from 150 kHz to 30 MHz was searched.
- Set the test-receiver system to Peak Detect Function and Specified Bandwidth with Maximum Hold Mode.

3.3. Typical test Setup

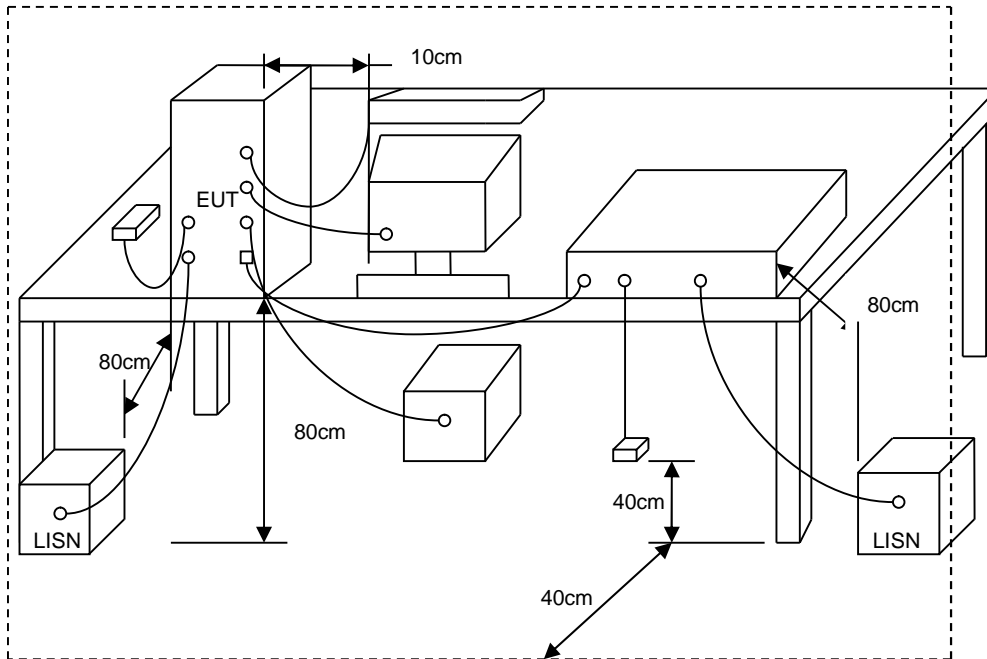

3.4. Measurement Equipment

Instrument	Manufacturer	Model No.	Serial No.	Calibration Date	Valid Date
EMI Receiver	R&S	ESCI 3	101423	2014/06/05	2015/06/04
LISN	Schwarzbeck	NSLK 8127	8127-740	2014/08/14	2015/08/13
LISN	Schwarzbeck	NSLK 8127	8127-516	2015/03/09	2016/03/08
Pulse Limiter	R&S	ESH3-Z2	101933	2014/08/12	2015/08/11
Software	Farad	Ez-EMC	ver.ct3a1	N/A	N/A



3.5. Test Result and Data

Power	: AC 120V	Pol/Phase	: LINE
Test Mode 3	: HDMI: 1920 x 1080@60Hz	Temperature	: 26 °C
Test Date	: May 14, 2015	Humidity	: 48 %
Model No.	: 270LM00020	Atmospheric Pressure	: 1008 hpa

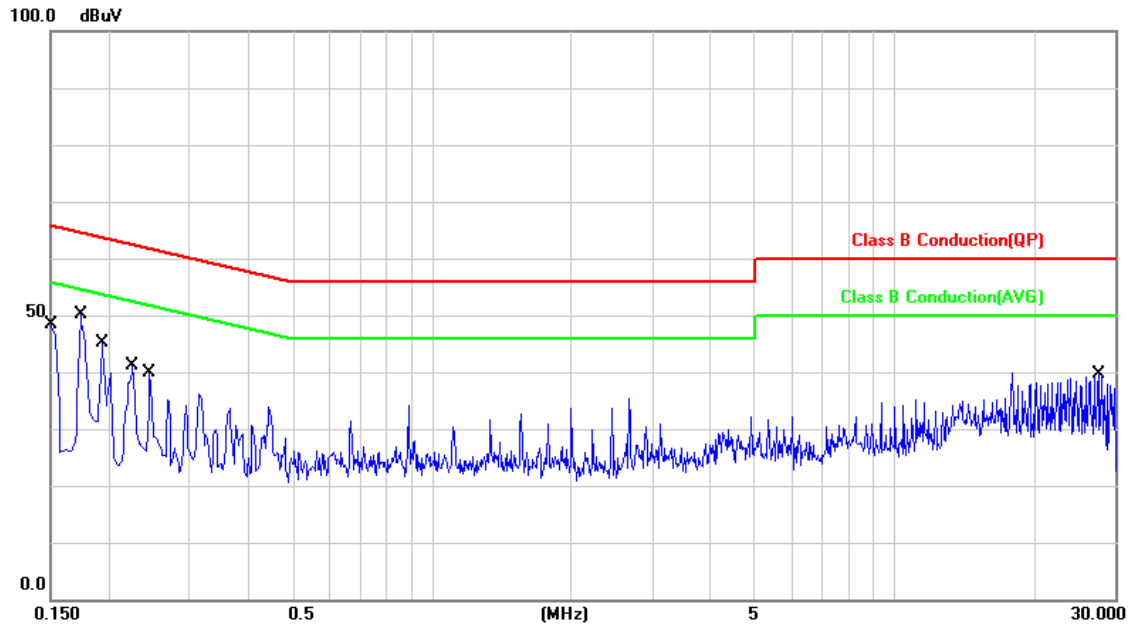

No.	Frequency (MHz)	Factor (dB)	Reading (dBuV)	Level (dBuV)	Limit (dBuV)	Margin (dB)	Detector	P/F
1	0.1500	9.92	31.00	40.92	65.99	-25.07	QP	P
2	0.1500	9.92	12.34	22.26	55.99	-33.73	AVG	P
3	0.1740	9.92	30.59	40.51	64.76	-24.25	QP	P
4	0.1740	9.92	12.43	22.35	54.76	-32.41	AVG	P
5	0.1940	9.91	35.52	45.43	63.86	-18.43	QP	P
6	0.1940	9.91	19.97	29.88	53.86	-23.98	AVG	P
7	0.2260	9.91	23.81	33.72	62.59	-28.87	QP	P
8	0.2260	9.91	22.74	32.65	52.59	-19.94	AVG	P
9	0.2460	9.91	27.03	36.94	61.89	-24.95	QP	P
10	0.2460	9.91	15.00	24.91	51.89	-26.98	AVG	P
11	27.6660	10.33	26.78	37.11	60.00	-22.89	QP	P
12	27.6660	10.33	25.53	35.86	50.00	-14.14	AVG	P

Note: Level = Reading + Factor
 Margin = Level – Limit
 Factor = (LISN, ISN, PLC or Current Probe) Factor + Cable Loss + Attenuator



Power	: AC 120V	Pol/Phase	: NEUTRAL
Test Mode 3	: HDMI: 1920 x 1080@60Hz	Temperature	: 26 °C
Test Date	: May 14, 2015	Humidity	: 48 %
Model No.	: 270LM00020	Atmospheric Pressure	: 1008 hpa

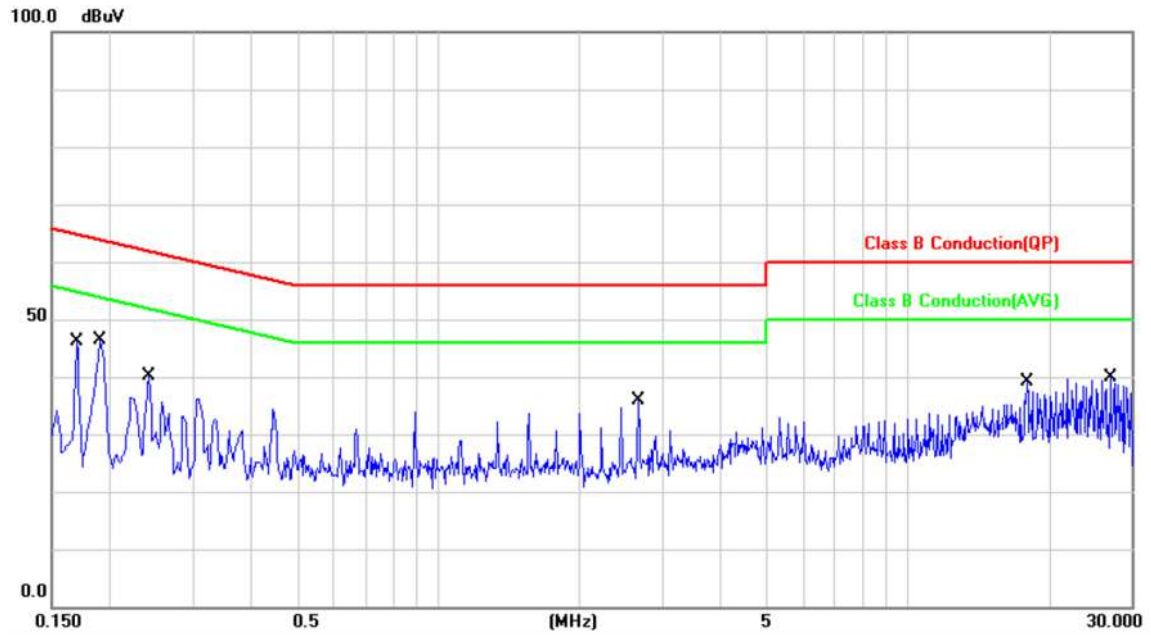

No.	Frequency (MHz)	Factor (dB)	Reading (dBuV)	Level (dBuV)	Limit (dBuV)	Margin (dB)	Detector	P/F
1	0.1700	9.92	27.55	37.47	64.96	-27.49	QP	P
2	0.1700	9.92	11.64	21.56	54.96	-33.40	AVG	P
3	0.1900	9.91	36.12	46.03	64.03	-18.00	QP	P
4	0.1900	9.91	22.16	32.07	54.03	-21.96	AVG	P
5	0.2420	9.91	26.81	36.72	62.02	-25.30	QP	P
6	0.2420	9.91	14.04	23.95	52.02	-28.07	AVG	P
7	2.6780	9.88	24.27	34.15	56.00	-21.85	QP	P
8	2.6780	9.88	23.84	33.72	46.00	-12.28	AVG	P
9	18.0140	10.12	26.76	36.88	60.00	-23.12	QP	P
10	18.0140	10.12	25.19	35.31	50.00	-14.69	AVG	P
11	26.9980	10.32	26.16	36.48	60.00	-23.52	QP	P
12	26.9980	10.32	23.84	34.16	50.00	-15.84	AVG	P

Note: Level = Reading + Factor
 Margin = Level – Limit
 Factor = (LISN, ISN, PLC or Current Probe) Factor + Cable Loss + Attenuator

Test engineer: Wade



3.6. Test Photographs

Front View



Rear View





4. Test of Radiated Emission

4.1. Test Limit

Radiated emissions from 30 MHz to 18,000 MHz were measured with a bandwidth of 120 kHz according to the methods defines in ANSI C63.4-2009. The EUT was placed on a nonmetallic stand in the open-field site, 0.8 meter above the ground plane, as shown in section 3.2. The interface cables and equipment positions were varied within limits of reasonable applications to determine the positions producing maximum radiated emissions.

For unintentional device, according to § 15.109(a), except for Class A digital devices, the field strength of radiated emissions from unintentional radiators at a distance of 3 meters shall not exceed the following values:

Frequency (MHz)	Distance Meters	Radiated (μ V / M)	Radiated (dB μ V/ M)
30-88	3	100	40.0
88-216	3	150	43.5
216-960	3	200	46.0
Above 960	3	500	54.0

For unintentional device, according to CISPR PUB.22, for Class B digital devices, the general requirement of field strength of radiated emissions from intentional radiators at a distance of 10 meters shall not exceed the below table.

Frequency (MHz)	Distance Meters	Radiated (dB μ V/ M)
30-230	10	30
230-1000	10	37

4.2. Test Procedures

- The EUT was placed on a Rota table top 0.8 meter above ground.
- The EUT was set 3/10 meters from the interference receiving antenna which was mounted on the top of a variable height antenna tower.
- The table was rotated 360 degrees to determine the position of the highest radiation.
- The antenna is a half wave dipole and its height is varied between one meter and four meters above ground to find the maximum value of the field strength both horizontal polarization and vertical polarization of the antenna are set to make the measurement.
- For each suspected emission the EUT was arranged to its worst case and then tune the antenna tower (from 1 M to 4 M) and turn table (from 0 degree to 360 degrees) to find the maximum reading.
- Set the test-receiver system to Peak Detect Function and specified bandwidth with Maximum Hold Mode.
- If the emission level of the EUT in peak mode was 6 dB lower than the limit specified, then testing will be stopped and peak values of EUT will be reported, otherwise, the emissions which do not have 6 dB margin will be repeated one by one using the quasi-peak method and reported.



4.3. Typical test Setup

Below 1GHz Test Setup

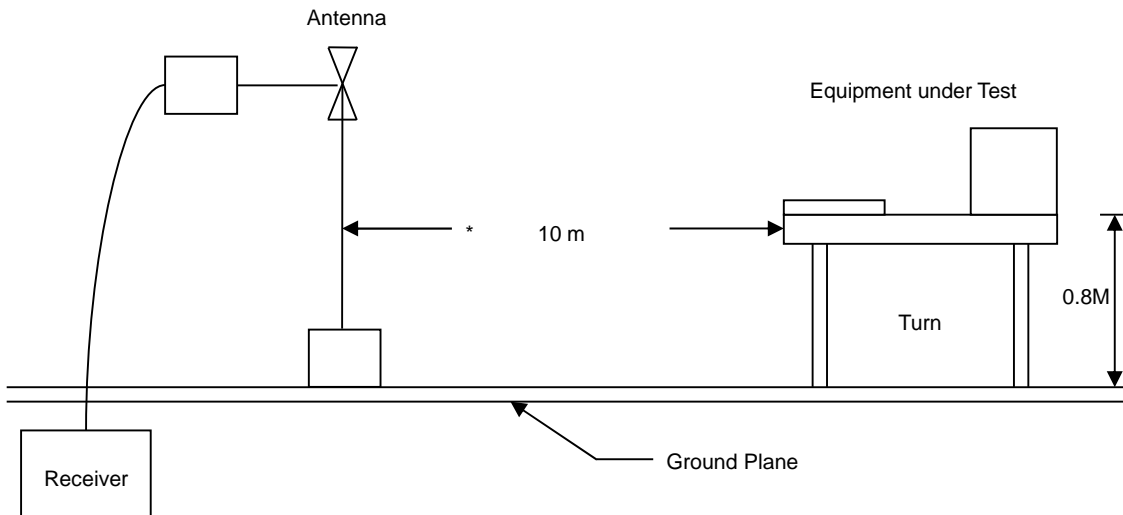

Above 1GHz Test Setup

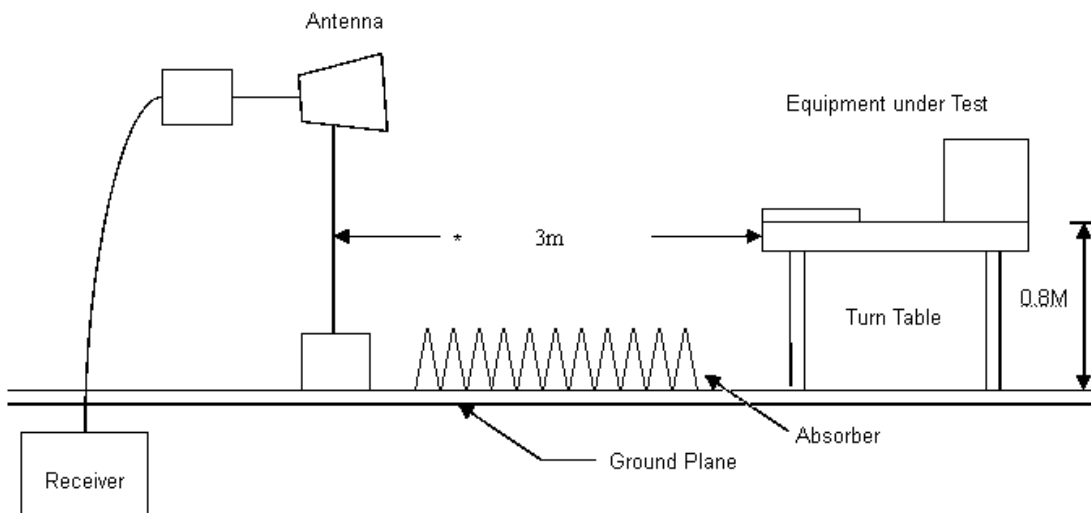



4.4. Measurement Equipment

Instrument	Manufacturer	Model No.	Serial No.	Calibration Date	Valid Date
EMI Receiver	R&S	ESCI 3	101402	2015/02/06	2016/02/05
EMI Receiver	R&S	ESCI 7	100963	2015/02/24	2016/02/23
Bilog Antenna	Sciences Corporation	JB1	A020514-1	2015/02/25	2016/02/24
Bilog Antenna	Sciences Corporation	JB1	A020514-2	2015/03/13	2016/03/12
Amplifier	EM Electronics	EM330	060610	2015/02/24	2016/02/23
Amplifier	EM Electronics	EM330	060611	2015/02/04	2016/02/03
SPECTRUM ANALYZER	R&S	FSP40	100219	2014/09/03	2015/09/02
HORN ANTENNA	EMCO	3115	31589	2015/03/09	2016/03/08
PREAMPLIFIER	AGILENT	8449B	3008A01954	2015/03/05	2016/03/04
Software	Farad	Ez-EMC	ver.ct3a1	N/A	N/A



4.5. Test Result and Data (30MHz~1GHz)

Power	: AC 120V	Pol/Phase	: VERTICAL
Test Mode 3	: HDMI: 1920 x 1080@60Hz	Temperature	: 20 °C
Test Date	: May 13, 2015	Humidity	: 40 %
Model No.	: 270LM00020	Atmospheric Pressure	: 1010 hpa

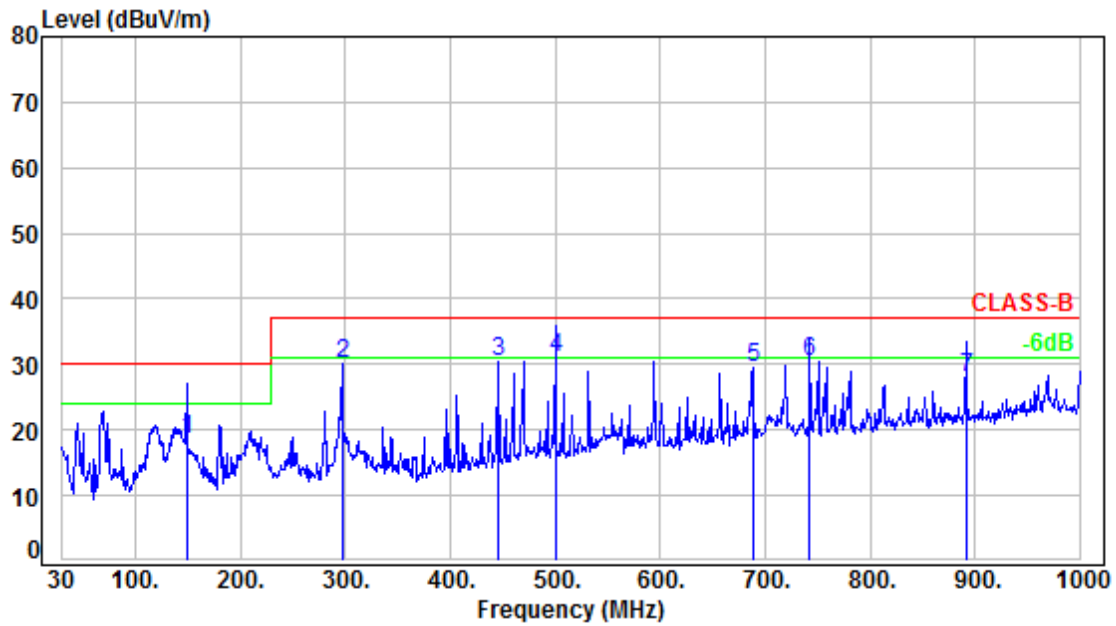

No.	Frequency (MHz)	Factor (dB/m)	Reading (dBuV)	Level (dBuV/m)	Limit (dBuV/m)	Margin (dB)	Detector	Height (cm)	Azimuth (°)	P/F
1	148.52	-16.4	34.95	18.55	30	-11.45	QP	100	0	P
2	296.75	-14.59	44.7	30.11	37	-6.89	Peak	100	45	P
3	445.16	-10.34	40.66	30.32	37	-6.68	Peak	100	170	P
4	500.45	-9.03	40.11	31.08	37	-5.92	QP	100	200	P
5	688.63	-5.95	35.39	29.44	37	-7.56	Peak	300	71	P
6	742.5	-5.24	35.56	30.32	37	-6.68	QP	300	184	P
7	891.36	-2.74	30.84	28.1	37	-8.9	QP	200	0	P

Note: Level = Reading + Factor
 Margin = Level – Limit
 Factor = (LISN, ISN, PLC or Current Probe) Factor + Cable Loss + Attenuator



Power	: AC 120V	Pol/Phase	: HORIZONTAL
Test Mode 3	: HDMI: 1920 x 1080@60Hz	Temperature	: 20 °C
Test Date	: May 13, 2015	Humidity	: 40 %
Model No.	: 270LM00020	Atmospheric Pressure	: 1010 hpa

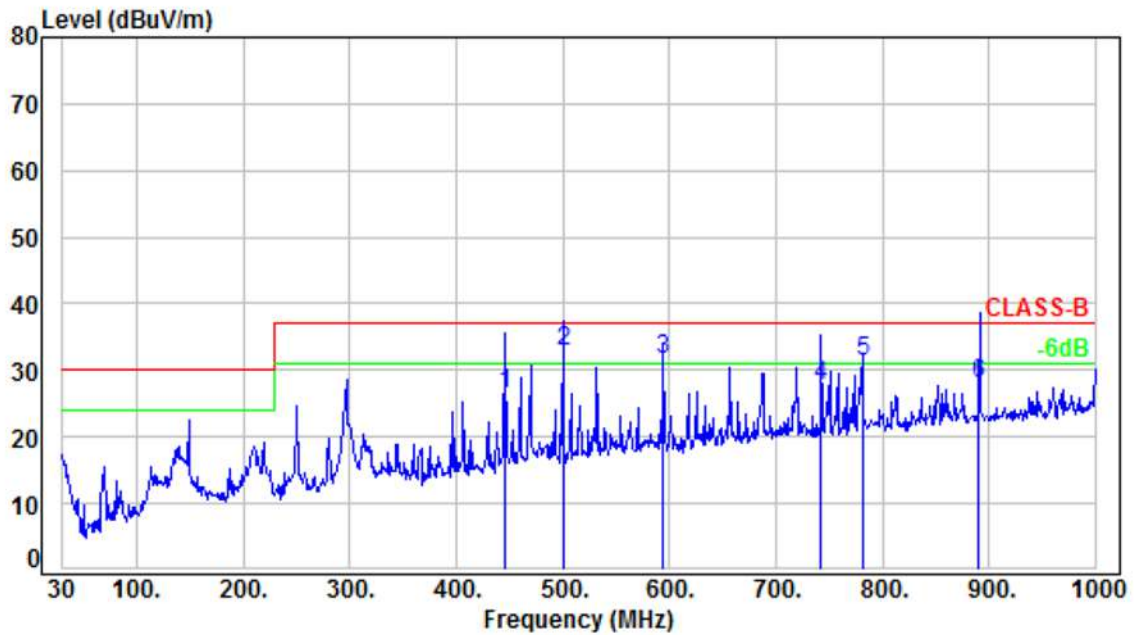

No.	Frequency (MHz)	Factor (dB/m)	Reading (dBuV)	Level (dBuV/m)	Limit (dBuV/m)	Margin (dB)	Detector	Height (cm)	Azimuth (°)	P/F
1	445.5	-9.87	36.41	26.54	37	-10.46	QP	231	100	P
2	500.53	-8.61	41.5	32.89	37	-4.11	QP	100	165	P
3	594	-7.35	38.9	31.55	37	-5.45	QP	183	153	P
4	742.95	-4.71	32.41	27.7	37	-9.3	QP	253	20	P
5	781.17	-4.02	35.29	31.27	37	-5.73	QP	100	73	P
6	891.01	-2.28	30.35	28.07	37	-8.93	QP	100	360	P

Note: Level = Reading + Factor
Margin = Level – Limit
Factor = (LISN, ISN, PLC or Current Probe) Factor + Cable Loss + Attenuator

Test engineer: Tom



4.6. Test Result and Data (1GHz ~ 15GHz)

Power	: AC 120V	Pol/Phase	: VERTICAL
Test Mode 3	: HDMI: 1920 x 1080@60Hz	Temperature	: 23 °C
Test Date	: May 12, 2015	Humidity	: 48 %
Model No.	: 270LM00020	Atmospheric Pressure	: 1010 hpa

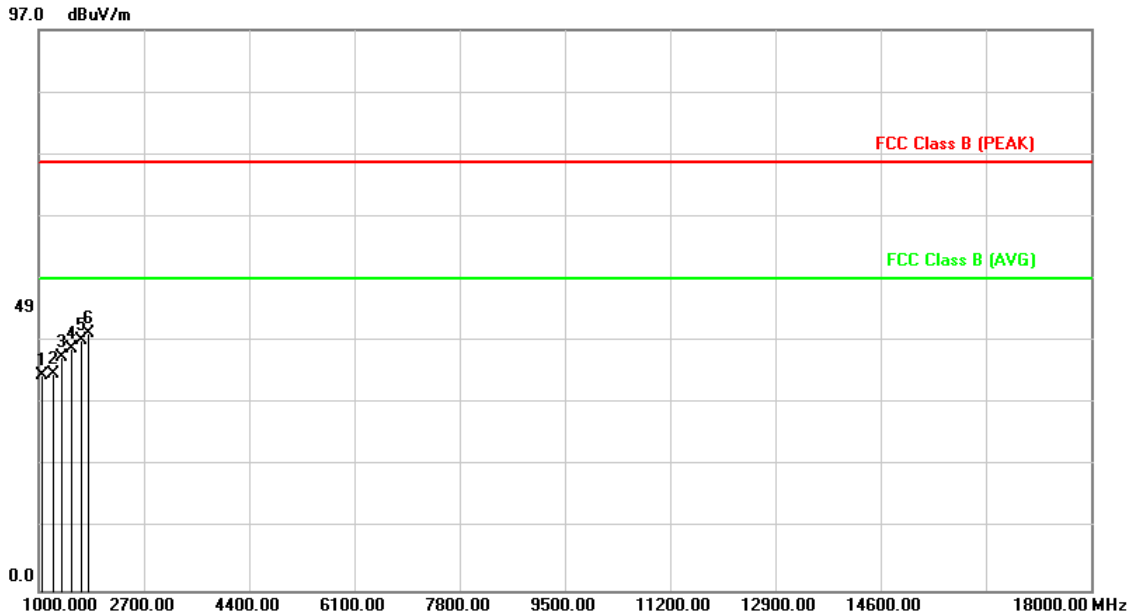

No.	Frequency (MHz)	Factor (dB/m)	Reading (dBuV)	Level (dBuV/m)	Limit (dBuV/m)	Margin (dB)	Detector	Height (cm)	Azimuth (°)	P/F
1	1051.000	-8.61	45.78	37.17	74.00	-36.83	peak	100	0	P
2	1238.000	-7.50	45.07	37.57	74.00	-36.43	peak	100	0	P
3	1374.000	-6.71	46.99	40.28	74.00	-33.72	peak	100	0	P
4	1527.000	-5.79	47.66	41.87	74.00	-32.13	peak	100	0	P
5	1697.000	-4.66	47.84	43.18	74.00	-30.82	peak	100	0	P
6	1799.000	-3.98	48.36	44.38	74.00	-29.62	peak	100	0	P

Note: Level = Reading + Factor
 Margin = Level – Limit
 Factor = (LISN, ISN, PLC or Current Probe) Factor + Cable Loss + Attenuator



Power	: AC 120V	Pol/Phase	: HORIZONTAL
Test Mode 3	: HDMI: 1920 x 1080@60Hz	Temperature	: 23 °C
Test Date	: May 12, 2015	Humidity	: 48 %
Model No.	: 270LM00020	Atmospheric Pressure	: 1010 hpa

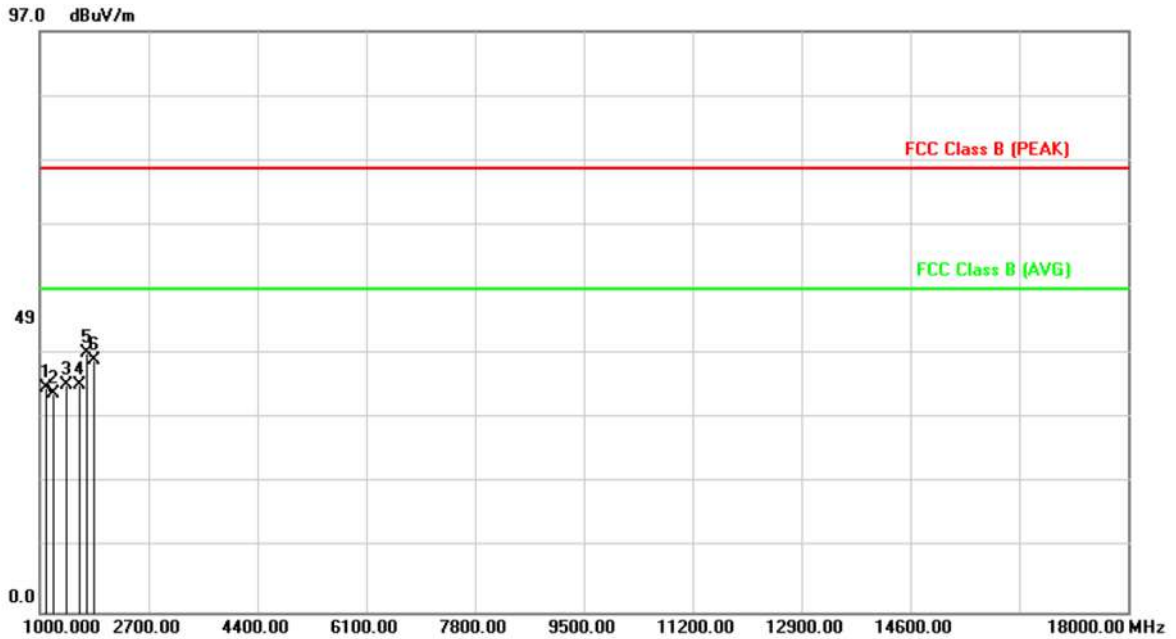

No.	Frequency (MHz)	Factor (dB/m)	Reading (dBuV)	Level (dBuV/m)	Limit (dBuV/m)	Margin (dB)	Detector	Height (cm)	Azimuth (°)	P/F
1	1102.000	-8.32	45.67	37.35	74.00	-36.65	peak	200	0	P
2	1221.000	-7.61	44.10	36.49	74.00	-37.51	peak	200	0	P
3	1425.000	-6.41	44.35	37.94	74.00	-36.06	peak	200	0	P
4	1629.000	-5.12	42.98	37.86	74.00	-36.14	peak	200	0	P
5	1731.000	-4.45	47.69	43.24	74.00	-30.76	peak	200	0	P
6	1850.000	-3.65	45.76	42.11	74.00	-31.89	peak	200	0	P

Note: Level = Reading + Factor
Margin = Level – Limit
Factor = (LISN, ISN, PLC or Current Probe) Factor + Cable Loss + Attenuator

Test engineer: Benson



4.7. Test Photographs (30MHz ~ 1GHz)

Front View



Rear View





4.8. Test Photographs (1GHz ~ 18GHz)

Front View



Rear View

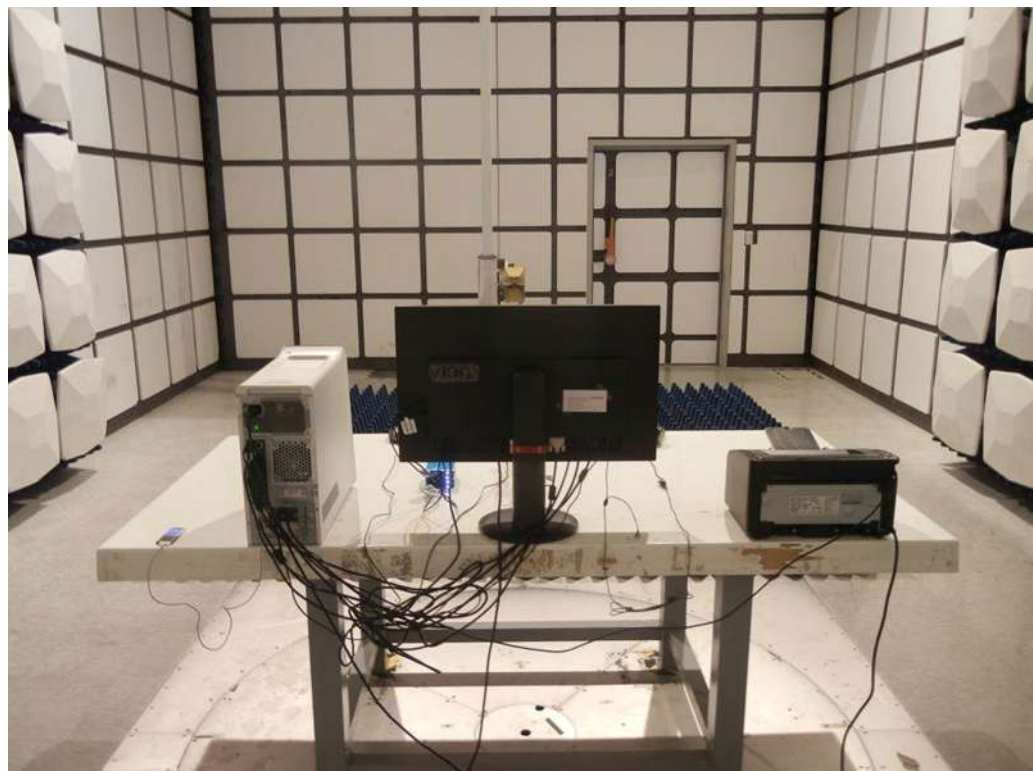



5. Photographs of EUT





