



LCD Monitor User Manual

E2770SD/E2770SD6/E2770SHE/E2770PQU/E2770SH

Q2770PQU/ E2770SHE/NA

G2770PQU/G2770PF

M2770V/M2870V/M2870VHE/M2870VQ

I2770V/I2770VHE/I2770PQ

(LED Backlight)

Safety.....	4
National Conventions.....	4
Power	5
Installation.....	6
Cleaning.....	7
Other.....	8
Setup	9
Content of the Box	9
Setup Stand	10
Adjusting Viewing Angle.....	11
Connecting the Monitor.....	12
Wall Mounting	15
AOC Anti-Blue Light Feature Description (Optional)	17
Adjusting	18
Setting Optimal Resolution	18
Hotkeys.....	24
Using "MHL(Mobile High-Definition Link)" (Optional)	26
OSD Setting.....	27
Luminance	28
Image Setup	30
Color Setup.....	31
Picture Boost	32
OSD Setup	33
Extra	34
Exit.....	35
LED Indicator.....	36
Driver	37
Monitor Driver	37
i-Menu.....	49
e-Saver	50
Screen+	51
Troubleshoot.....	52
Specification.....	54
General Specification.....	54
Preset Display Modes	60
Pin Assignments	63
Plug and Play.....	65
Regulation.....	66
FCC Notice	66
WEEE Declaration (Optional)	67
WEEE Declaration for India (Optional)	67
EPA Energy Star	68
EPEAT Declaration	68
EPEAT Declaration	69
TCO DOCUMENT	70

Service	71
Warranty Statement for Europe	71
Warranty Statement for Middle East and Africa (MEA)	73
AOC Pixel Policy ISO 9241-307 Class 1	75
Warranty Statement for North & South America (excluding Brazil)	76

Safety

National Conventions

The following subsections describe notational conventions used in this document.

Notes, Cautions, and Warnings

Throughout this guide, blocks of text may be accompanied by an icon and printed in bold type or in italic type. These blocks are notes, cautions, and warnings, and they are used as follows:



NOTE: A NOTE indicates important information that helps you make better use of your computer system.





CAUTION: A CAUTION indicates either potential damage to hardware or loss of data and tells you how to avoid the problem.





WARNING: A WARNING indicates the potential for bodily harm and tells you how to avoid the problem. Some warnings may appear in alternate formats and may be unaccompanied by an icon. In such cases, the specific presentation of the warning is mandated by regulatory authority.

Power

 The monitor should be operated only from the type of power source indicated on the label. If you are not sure of the type of power supplied to your home, consult your dealer or local power company.

 The monitor is equipped with a three-pronged grounded plug, a plug with a third (grounding) pin. This plug will fit only into a grounded power outlet as a safety feature. If your outlet does not accommodate the three-wire plug, have an electrician install the correct outlet, or use an adapter to ground the appliance safely. Do not defeat the safety purpose of the grounded plug.

 Unplug the unit during a lightning storm or when it will not be used for long periods of time. This will protect the monitor from damage due to power surges.

 Do not overload power strips and extension cords. Overloading can result in fire or electric shock.

 The wall socket shall be installed near the equipment and shall be easily accessible.

Installation

! Do not place the monitor on an unstable cart, stand, tripod, bracket, or table. If the monitor falls, it can injure a person and cause serious damage to this product. Use only a cart, stand, tripod, bracket, or table recommended by the manufacturer or sold with this product. Follow the manufacturer's instructions when installing the product and use mounting accessories recommended by the manufacturer. A product and cart combination should be moved with care.

! Never push any object into the slot on the monitor cabinet. It could damage circuit parts causing a fire or electric shock. Never spill liquids on the monitor.

! Do not place the front of the product on the floor.

! If you mount the monitor on a wall or shelf, use a mounting kit approved by the manufacturer and follow the kit instructions.

! Leave some space around the monitor as shown below. Otherwise, air-circulation may be inadequate hence overheating may cause a fire or damage to the monitor.

See below the recommended ventilation areas around the monitor when the monitor is installed on the wall or on the stand:

Installed on the wall

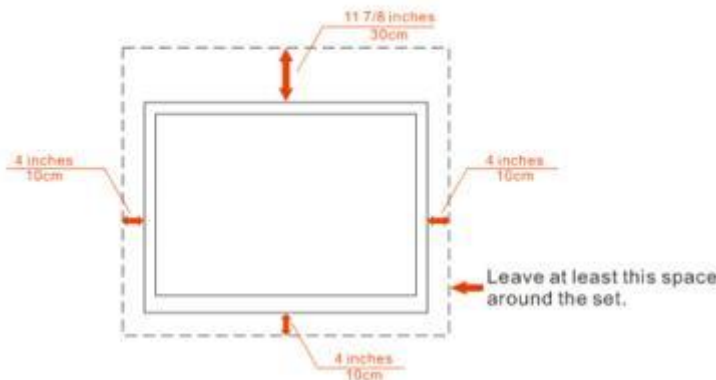

Installed with stand

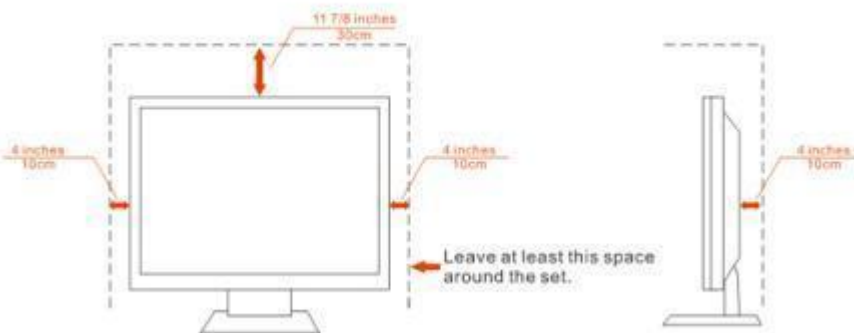

Cleaning

⚠ Clean the cabinet regularly with cloth. You can use soft-detergent to wipe out the stain, instead of strong-detergent which will cauterize the product cabinet.

⚠ When cleaning, make sure no detergent is leaked into the product. The cleaning cloth should not be too rough as it will scratch the screen surface.

⚠ Please disconnect the power cord before cleaning the product.



Other

 If the product is emitting a strange smell, sound or smoke, disconnect the power plug IMMEDIATELY and contact a Service Center.

 Make sure that the ventilating openings are not blocked by a table or curtain.

 Do not engage the LCD monitor in severe vibration or high impact conditions during operation.

 Do not knock or drop the monitor during operation or transportation.

 For display with glossy bezel the user should consider the placement of the display as the bezel may cause disturbing reflections from surrounding light and bright surfaces.

Setup

Content of the Box

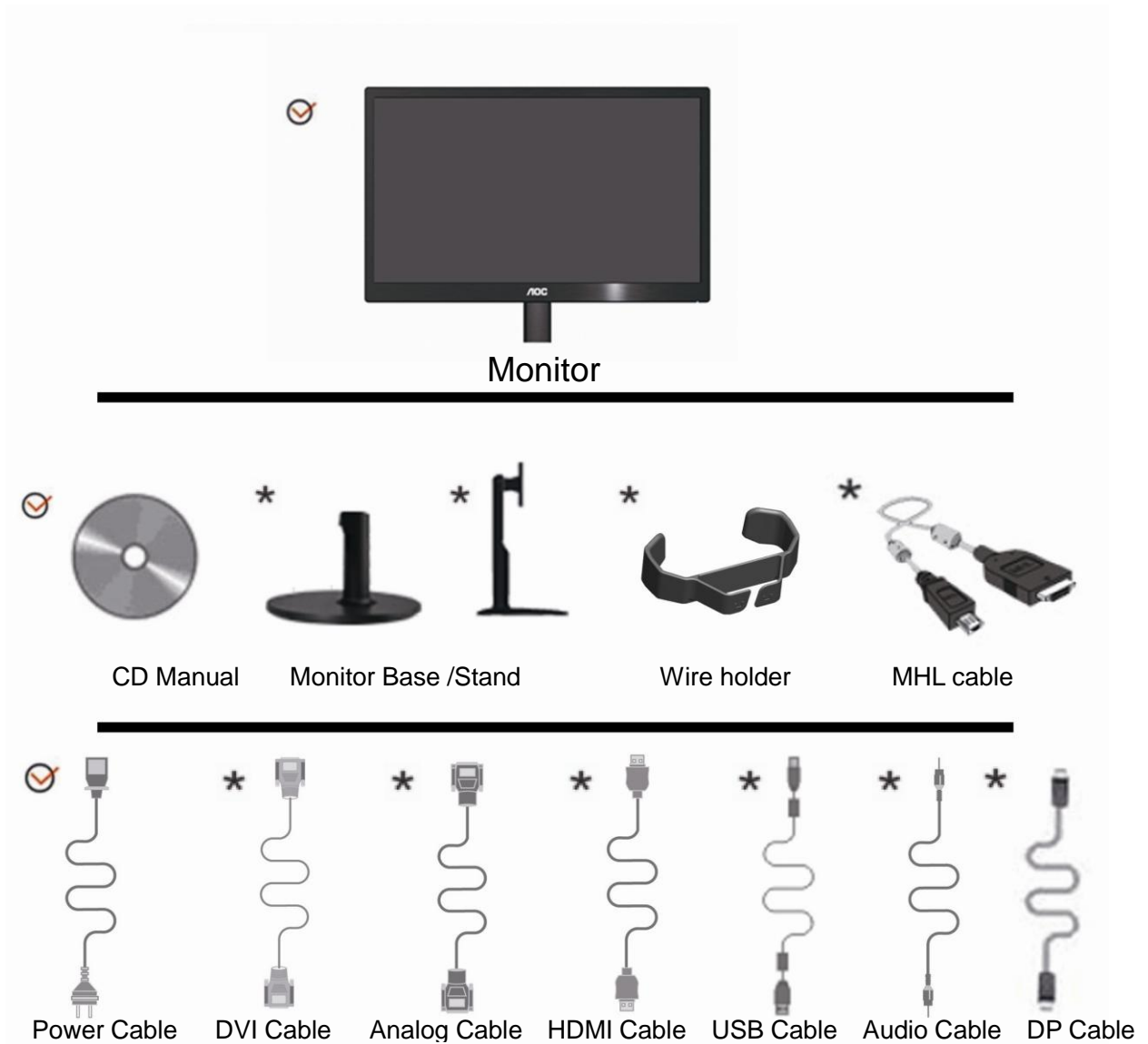

*Not all signal cables (Analog , Audio, DVI, USB, DP, MHL and HDMI cables) will be provided for all countries and regions. Please check with the local dealer or AOC branch office for confirmation.

Setup Stand

Please setup or remove the Stand following the steps as below.

70S/70V

Setup

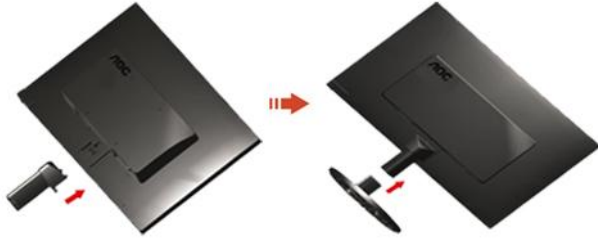

Remove:



70P

Setup:



Remove:



Adjusting Viewing Angle

For optimal viewing it is recommended to look at the full face of the monitor, then adjust the monitor's angle to your own preference.

Hold the stand so you will not topple the monitor when you change the monitor's angle.

You are able to adjust the monitor's angle from -5° to 25° .

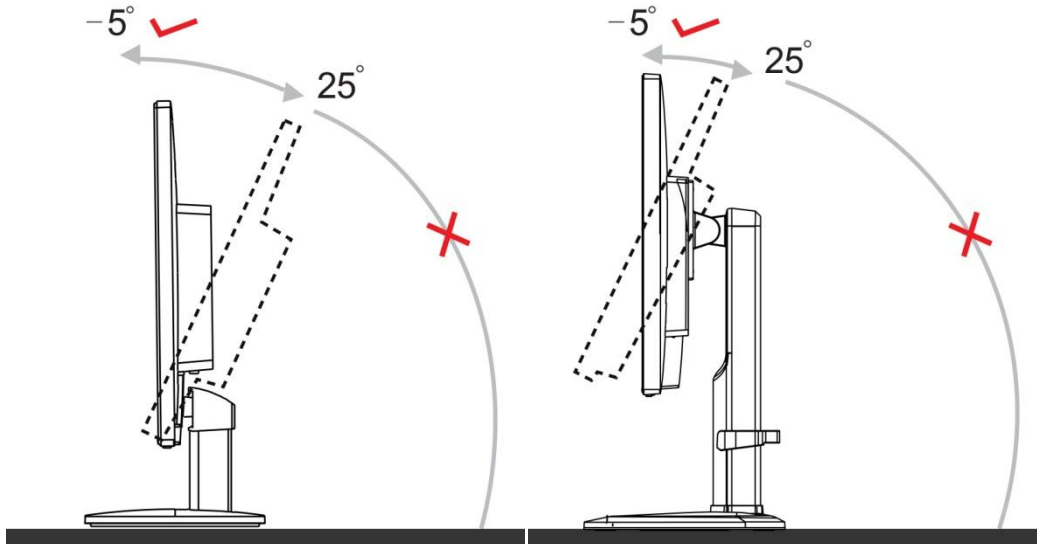

NOTE: Do not adjust the viewing angle over 25 degrees in order to avoid damage.



NOTE:

Do not touch the LCD screen when you change the angle. It may cause damage or break the LCD screen.

Do not put your hand close to the gap between the monitor and the base to avoid the injury when adjusting the viewing angle.

Connecting the Monitor

Cable Connections In Back of Monitor and Computer:

1. E2770SD/ E2770SD6/M2770V/M2870V/I2770V

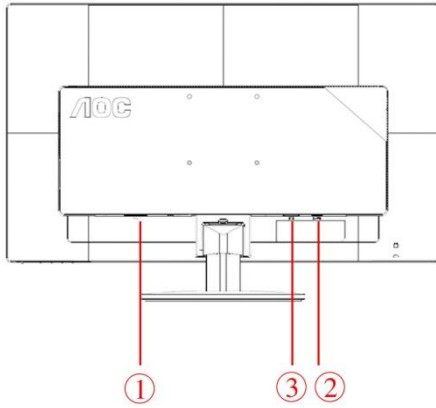

2. E2770SHE/ E2770SHE/NA

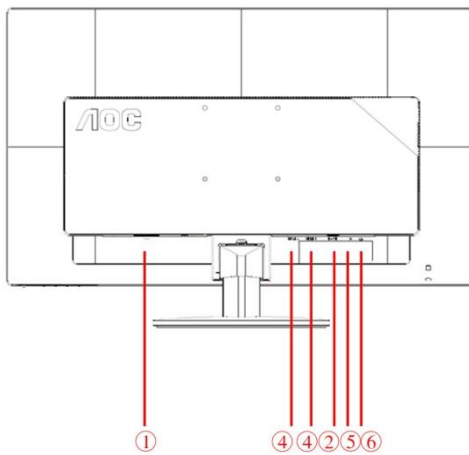

3 .E2770PQU

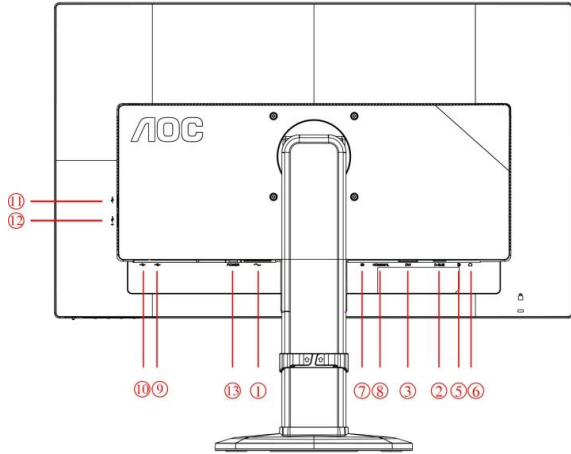

4 .Q2770PQU/G2770PQU

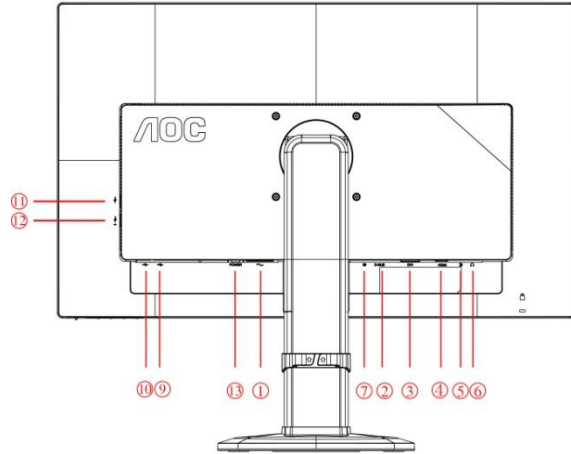

5. M2870VHE / I2770VHE/E2770SH

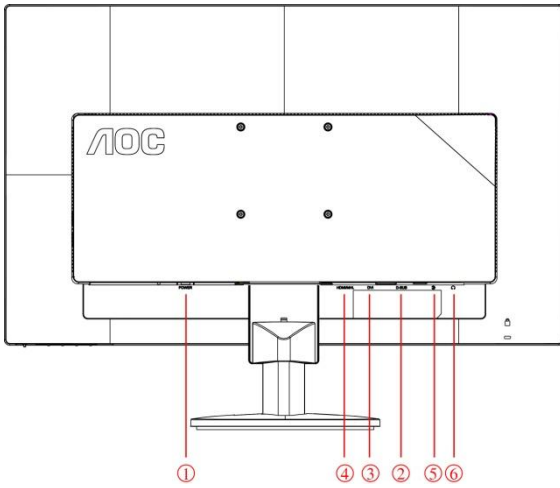

6. M2870VQ

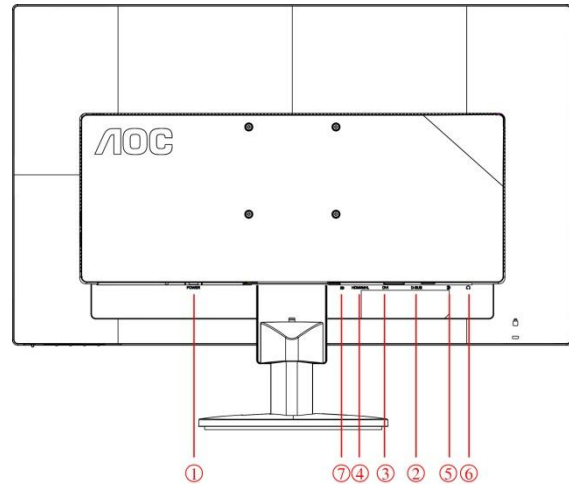

7. I2770PQ

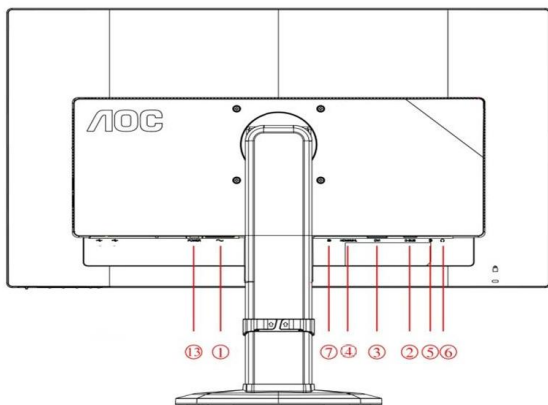

8.G2770PF

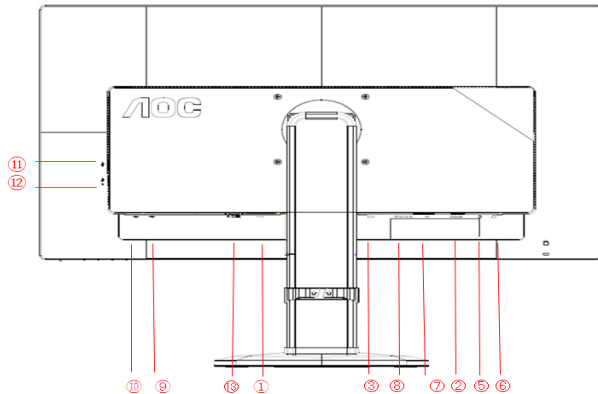

1. Power
2. Analog (D-Sub 15-Pin VGA cable)
3. DVI
4. HDMI
5. Audio in
6. Earphone out
7. Display port
8. HDMI/MHL
9. USB input
10. USB 2.0x2
11. USB 3.0
12. USB 3.0+ fast charging
13. AC power switch

To protect equipment, always turn off the PC and LCD monitor before connecting.

1. Connect the power cable to the AC port on the back of the monitor.
2. Connect one end of the 15-pin D-Sub cable to the back of the monitor and connect the other end to the computer's D-Sub port.
3. (Optional – Requires a video card with DVI port) Connect one end of the DVI cable to the back of the monitor and connect the other end to the computer's DVI port.
4. (Optional – Requires a video card with HDMI port) - Connect one end of the HDMI cable to the back of the monitor and connect the other end to the computer's HDMI port.
5. (Optional – Requires a video card with DP port) - Connect one end of the DP cable to the back of the monitor and connect the other end to the computer's DP port.
6. (Optional – Requires a video card with MHL port) - Connect one end of the MHL cable to the back of the monitor and connect the other end to the computer's MHL port.
7. (Optional) Connect the audio cable to audio in port on the back of the monitor
8. Turn on your monitor and computer.

If your monitor displays an image, installation is complete. If it does not display an image, please refer Troubleshooting.

System requirement: refer to G2770PF

FreeSync function:

1. FreeSync function is working with DisplayPort.

2. Compatible Graphics Card: Recommend list is as the below, also could be checked by visiting www.AMD.com

- AMD Radeon R9 295X2
- AMD Radeon R9 290X
- AMD Radeon R9 290
- AMD Radeon R9 285
- AMD Radeon R7 260X
- AMD Radeon R7 260

Wall Mounting

Preparing to Install An Optional Wall Mounting Arm.

70S/70V



70P



This monitor can be attached to a wall mounting arm you purchase separately. Disconnect power before this procedure. Follow these steps:

1. Remove the base.
2. Follow the manufacturer's instructions to assemble the wall mounting arm.
3. Place the wall mounting arm onto the back of the monitor. Line up the holes of the arm with the holes in the back of the monitor.

4. Insert the 4 screws into the holes and tighten.
5. Reconnect the cables. Refer to the user's manual that came with the optional wall mounting arm for instructions on attaching it to the wall.

Noted : VESA mounting screw holes are not available for all models, please check with the dealer or official department of AOC.

AOC Anti-Blue Light Feature Description (Optional)

Studies have shown that just as ultra-violet rays can cause eye damage, blue light rays from LED displays can cause damage to different parts of the eye and affect vision over time. AOC Anti-Blue Light feature uses a smart technology to reduce the harmful blue light waves without affecting the color or image of the display.

Adjusting Setting Optimal Resolution

Windows 10

For Windows 10:

- Right click **START**.
- Click "**CONTROL PANEL**".

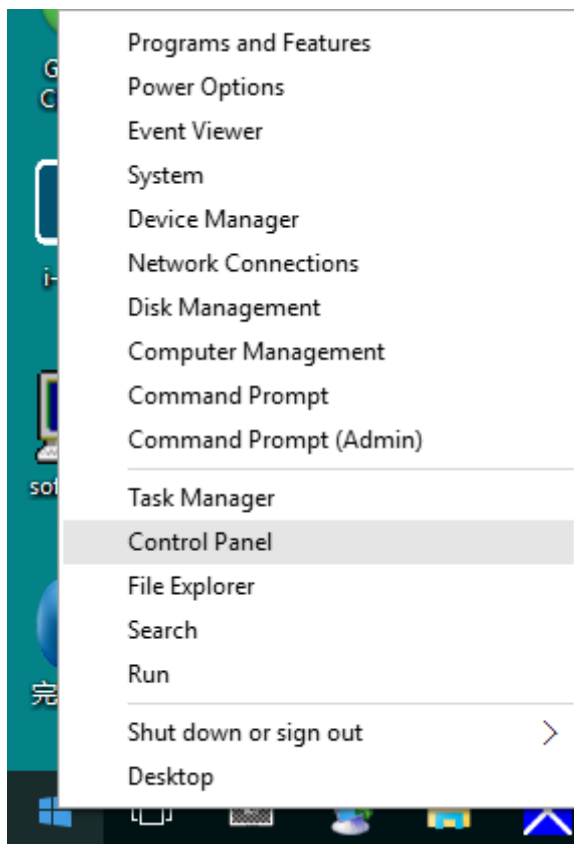

- Click "**DISPLAY**".

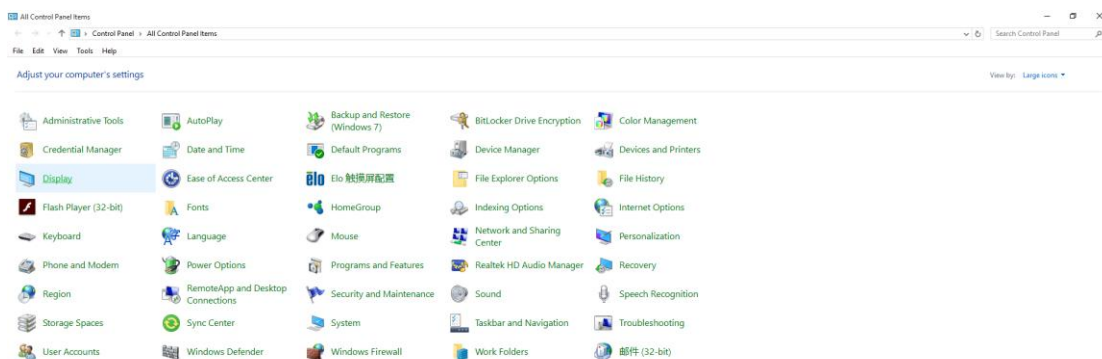

- Click on the "**Change display settings**" button.

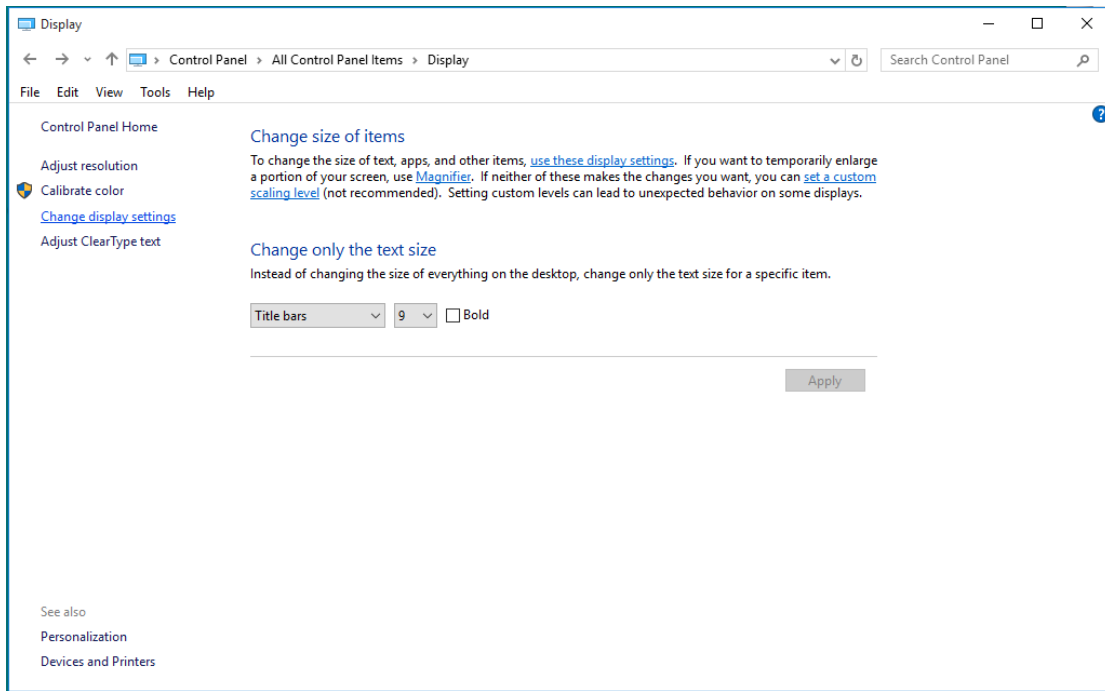

- Set the resolution **SLIDE-BAR** to Optimal preset resolution.

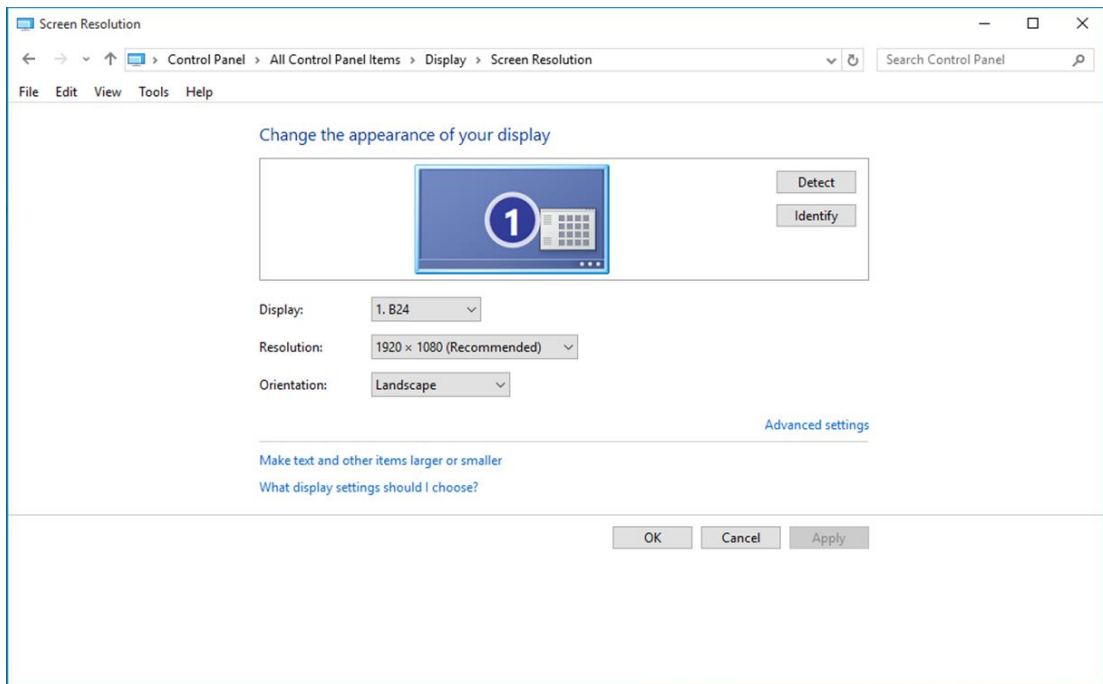

Windows 8

For Windows 8:

- Right click and click **All apps** at the bottom-right of the screen.

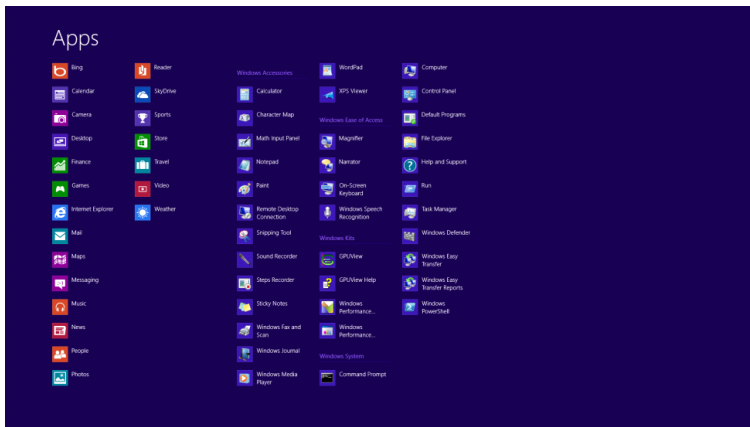
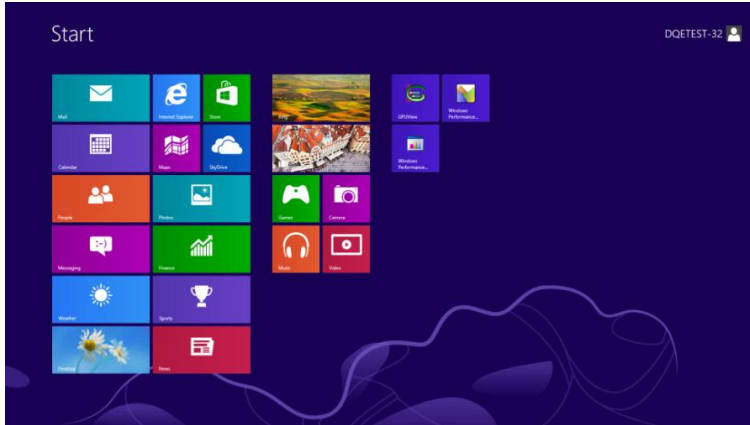

- Set the "View by" to "Category".
- Click "Appearance and Personalization".

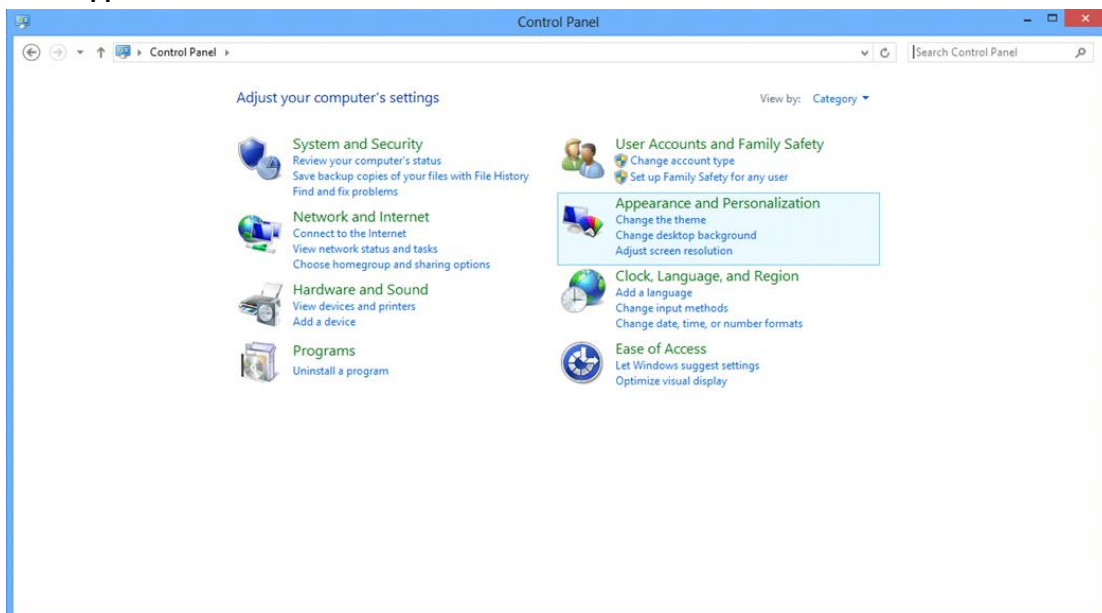

- Click "DISPLAY".

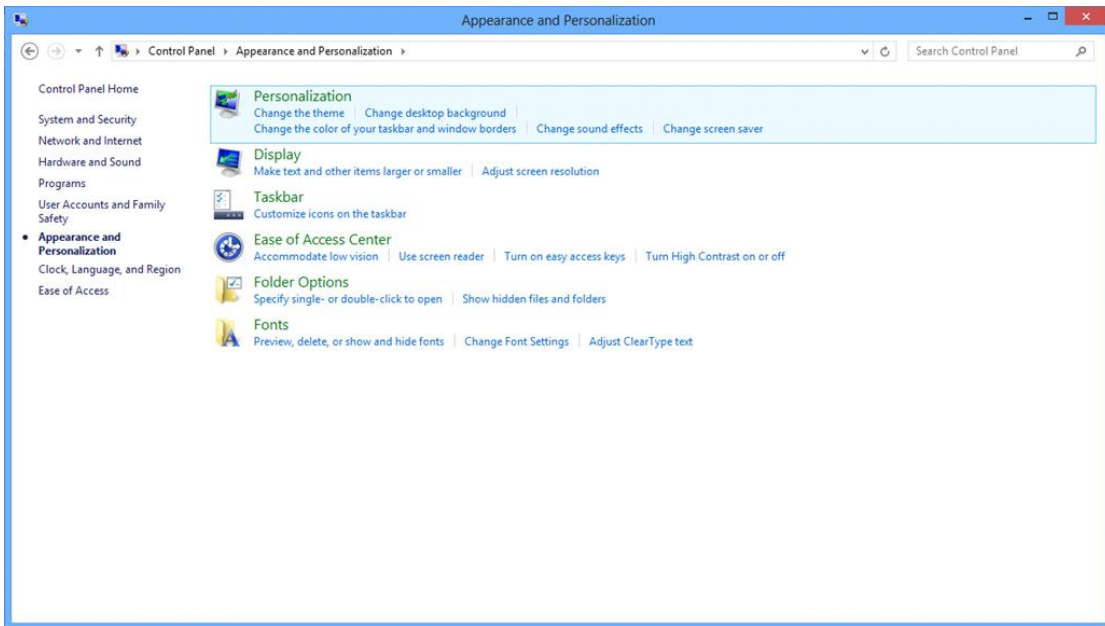

- Set the resolution **SLIDE-BAR** to Optimal preset resolution

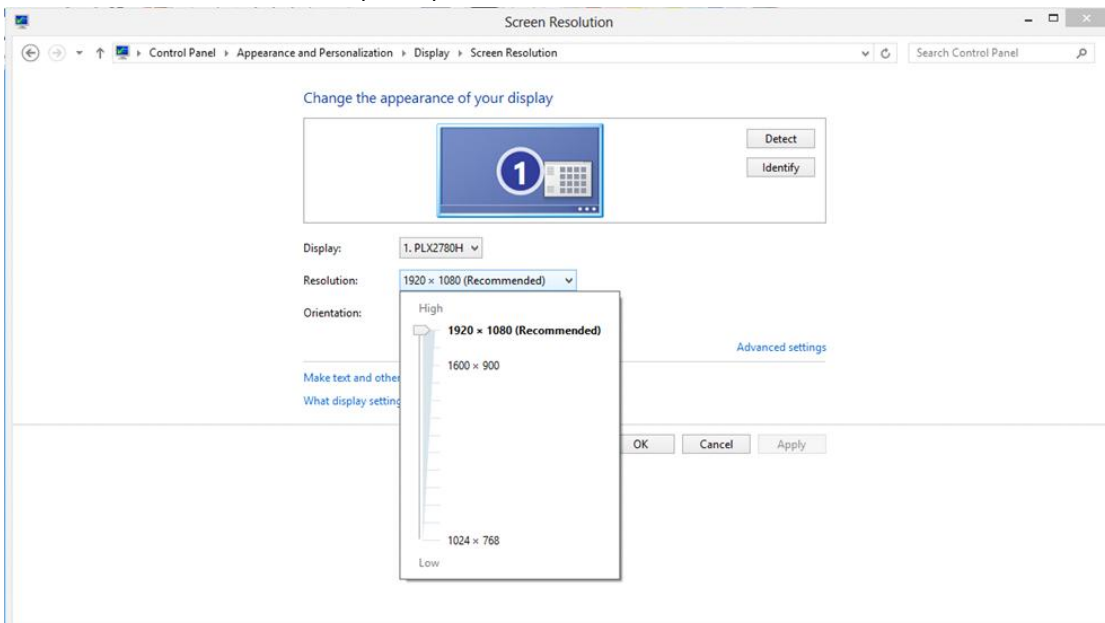

Windows 7

For Windows 7:

- Click **START**.
- Click **"CONTROL PANEL"**.

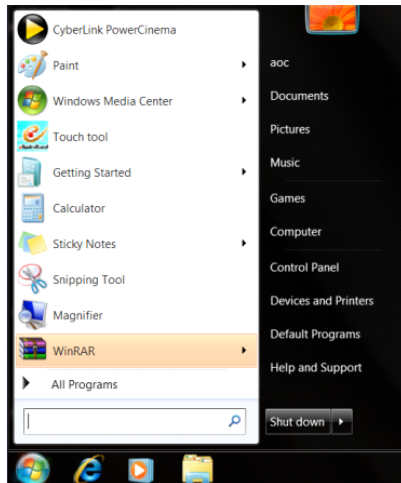

- Click **"Appearance"**.

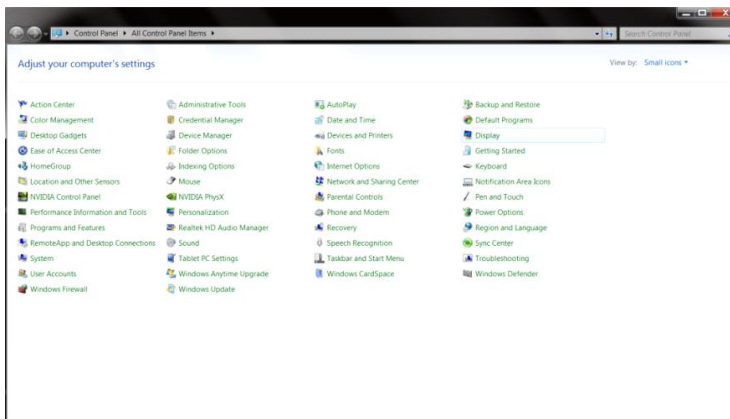

- Click **"DISPLAY"**.

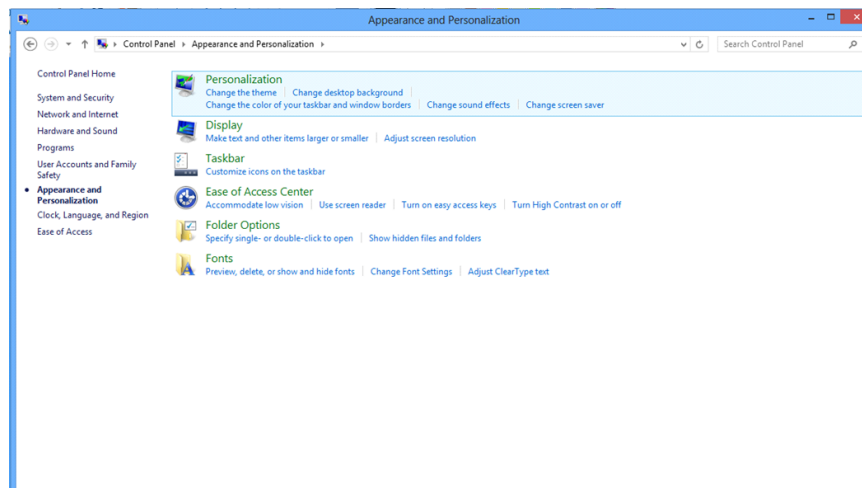

- Click on the "**Change display settings**" button.

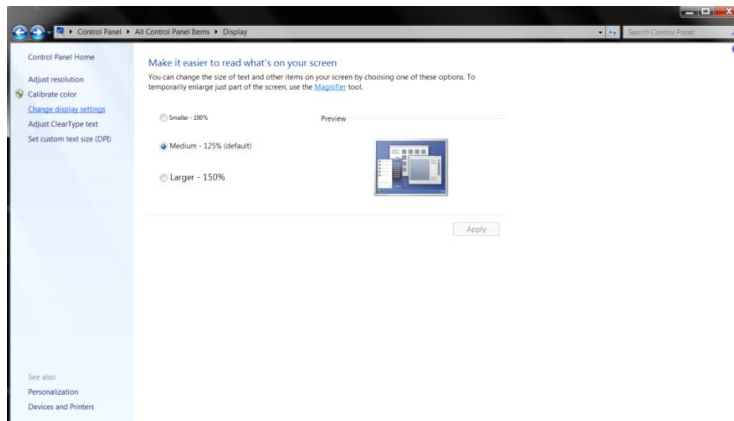

- Set the resolution **SLIDE-BAR** to Optimal preset resolution

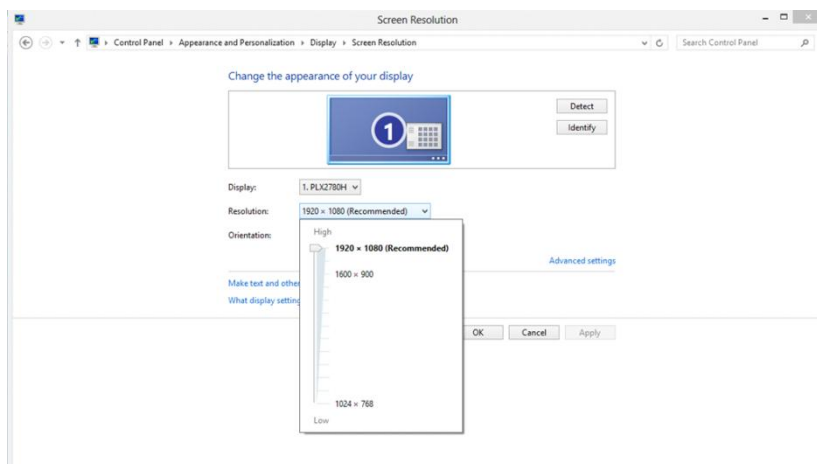

Hotkeys

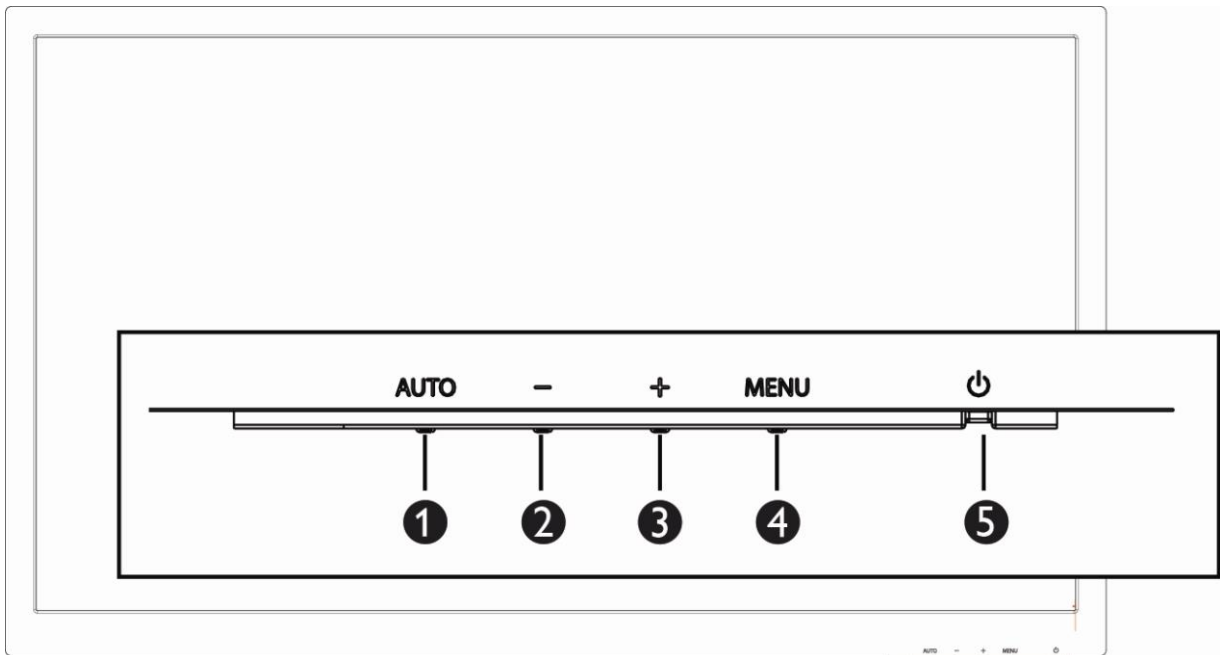

E2770SD/M2770V/M2870V/I2770V/E2770SD6

1	Source/Auto/Exit
2	Clear Vision/-
3	4:3 or Wide/+
4	Menu/Enter
5	Power

E2770SHE/E2770PQU/Q2770PQU/G2770PQU/M2870VQ/M2870VHE/I2770VHE/I2770PQ/E2770SH/ E2770SHE/NA

1	Source/Auto/Exit
2	Clear Vision/-
3	Volume/+
4	Menu/Enter
5	Power

G2770PF

1	Source/Auto/Exit
2	Game Mode/-
3	Volume /+
4	Menu/Enter
5	Power

Clear Vision

1. When there is no OSD, Press the “-” button to activate Clear Vision.
2. Use the “-” or “+” buttons to select between weak, medium, strong, or off settings. Default setting is always “off”.

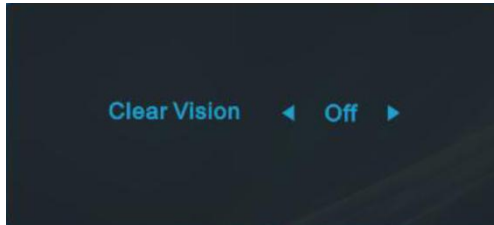

3. Press and hold “-” button for 5 seconds to activate the Clear Vision Demo, and a message of “Clear Vision Demo: on” will be display on the screen for a duration of 5 seconds. Press Menu or Exit button, the message will disappear. Press and hold “-” button for 5 seconds again, Clear Vision Demo will be off.

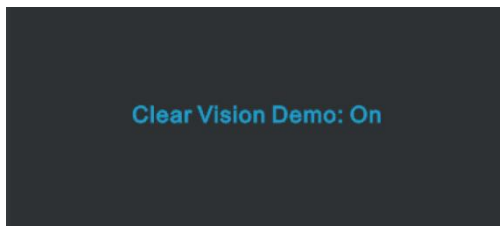

Clear Vision function provides the best image viewing experience by converting low resolution and blurry images into clear and vivid images.

Using "MHL(Mobile High-Definition Link)" (Optional)

1."MHL" (Mobile High-Definition Link)

This feature allows you to enjoy videos and photos (imported from a connected mobile device that supports MHL) on the screen of the product.

- To use the MHL function, you need an MHL-certified mobile device. You can check if your mobile device is MHL certified on the device manufacturer's website. To find a list of MHL-certified devices, visit the official MHL website (<http://www.mhlconsortium.org>).
- To use the MHL function, the latest version of software must be installed on the mobile device.
- On some mobile devices, the MHL function may not be available depending on the device's performance or functionality.
- Since the display size of the product is larger than those of mobile devices, the picture quality may degrade.
- This product is officially MHL-certified. If you encounter any problem when using the MHL function, please contact the manufacturer of the mobile device.
- The picture quality may degrade when content (imported from the mobile device) with a low Resolution is played on the product.

Using "MHL"

1. Connect the micro USB port on the mobile device to the [HDMI / MHL] port on the product using the MHL cable.

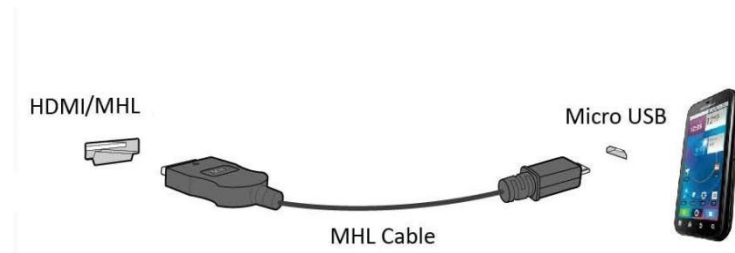

- When the MHL cable is used, [HDMI / MHL] is the only port on this monitor that supports the MHL function.
 - Mobile device must be purchased separately.
2. Press the source button and switch to HDMI /MHL to activate MHL mode.
 3. After about 3 seconds, the MHL screen will be displayed if MHL mode is active.

Remark: The indicated time "3 sec later" may vary depending on the mobile device.

When the mobile device is not connected or does not support MHL

- If MHL mode is not activated, check the connection of the mobile device.
- If MHL mode is not activated, check if the mobile device supports MHL.
- If MHL mode is not activated even though the mobile device supports MHL, update the firmware of the mobile device to the latest version.
- If MHL mode is not activated even though the mobile device supports MHL, check if mobile device MHL port is MHL standard port otherwise an additional MHL-enabled adapter is required.

OSD Setting

Basic and simple instruction on the control keys.



1. Press the **MENU-button** to activate the OSD window.
2. Press - or + to navigate through the functions. Once the desired function is highlighted, press the **MENU-button** to activate. Press - or + to navigate through the sub-menu. Once the desired function is highlighted, press **MENU-button** to activate.
3. Press - or + to change the settings of the selected function. Press **AUTO** to exit. If you want to adjust any other function, repeat steps 2-3.
4. OSD Lock Function: To lock the OSD, press and hold the **MENU-button** while the monitor is off and then press **power-button** to turn the monitor on. To un-lock the OSD, press and hold the **MENU-button** while the monitor is off and then press **power-button** to turn the monitor on.







Notes:

1. If the product has only one signal input, the item of "Input Select" is disabled.
2. If the product screen size is 4:3 or input signal resolution is wide format, the item of "Image Ratio" is disabled.
3. One of Clear vision, DCR, Color Boost, and Picture Boost functions is activated; the other three functions are turned off accordingly.

Luminance



- 1 Press **MENU** (Menu) to display menu.
- 2 Press - or + to select  (Luminance), and press **MENU** to enter.
- 3 Press - or + to select submenu, and press **MENU** to enter.
- 4 Press - or + to adjust.
- 5 Press **AUTO** to exit.

	Brightness	0-100		Backlight Adjustment.
	Contrast	0-100		Contrast from Digital-register.
	Eco mode	Standard	<input checked="" type="checkbox"/>	Standard Mode.
		Text		Text Mode.
		Internet		Internet Mode.
		Game		Game Mode.
		Movie		Movie Mode.
		Sports		Sports Mode.
	Gamma	Gamma1		Adjust to Gamma 1.
		Gamma2		Adjust to Gamma 2.
		Gamma3		Adjust to Gamma 3.
	DCR	Off		Disable dynamic contrast ratio.
		On		Enable dynamic contrast ratio.
	Overdrive	Weak		Adjust the response time (only for E2770PQU/Q2770PQU /I2770VHE/M2870VHE/M2870VQ/I277 0PQ/G2770PF/E2770SH/G2770PQU/ E2770SHE/NA)
		Light(only for G2770PF/G2770PQU)		
Medium				
Strong				
Off				

	Game mode	FPS	For playing FPS(first Person Shppters) games.Improves dark theme black level details.
		RTS	For playing RTS(Real Time Strategy, improve respnse time and brightness for presenting smooth pictures.
		Racing	For playing Racing games,Provides fastest response time and high color saturation.
		Gamer 1	User's preference settings saved as Gamer 1.
		Gamer 2	User's preference settings saved as Gamer 2.
		off	No optimization by Smartimage game
	Shadow Control	0-100	Shadow Control Default is 50, then end-user can adjust from 50 to 100 or 0 to increase contrast for clear picture. 1. If picture is too dark to be saw the detail clearly, adjusting from 50 to 100 for clear picture. 2. If picture is too white to be saw the detail clearly, adjusting from 50 to 0 for clear picture
	DPS	On	(only for E2770SHE/E2770SH)
		Off	

Image Setup

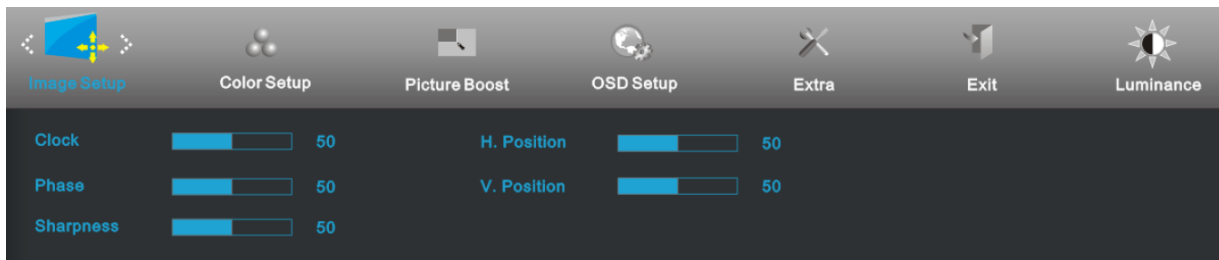



- 1 Press **MENU** (Menu) to display menu.
- 2 Press - or + to select  (Image Setup), and press **MENU** to enter.
- 3 Press - or + to select submenu, and press **MENU** to enter.
- 4 Press - or + to adjust.
- 5 Press **AUTO** to exit.

	Clock	0-100	Adjust picture Clock to reduce Vertical-Line noise.
	Phase	0-100	Adjust Picture Phase to reduce Horizontal-Line noise.
	Sharpness	0-100	Adjust picture sharpness.
	H.Position	0-100	Adjust the horizontal position of the picture.
	V.Position	0-100	Adjust the vertical position of the picture.

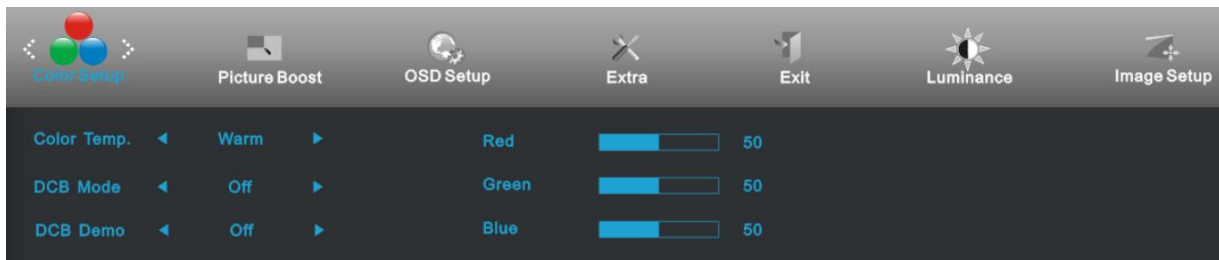
Color Setup



- 1 Press **MENU** (Menu) to display menu.
- 2 Press - or + to select  (Color Setup), and press **MENU** to enter.
- 3 Press - or + to select submenu, and press **MENU** to enter.
- 4 Press - or + to adjust.
- 5 Press **AUTO** to exit.

	Color Temp.	Warm		Recall Warm Color Temperature from EEPROM.
		Normal		Recall Normal Color Temperature from EEPROM.
		Cool		Recall Cool Color Temperature from EEPROM.
		sRGB		Recall SRGB Color Temperature from EEPROM.
		User	Red	
	Green			Green Gain Digital-register.
	Blue			Blue Gain from Digital-register.
	DCB Mode	Full Enhance	on or off	Disable or Enable Full Enhance Mode.
		Nature Skin	on or off	Disable or Enable Nature Skin Mode.
		Green Field	on or off	Disable or Enable Green Field Mode.
		Sky-blue	on or off	Disable or Enable Sky-blue Mode.
		AutoDetect	on or off	Disable or Enable AutoDetect Mode.
	DCB Demo		on or off	Disable or Enable Demo.

Picture Boost

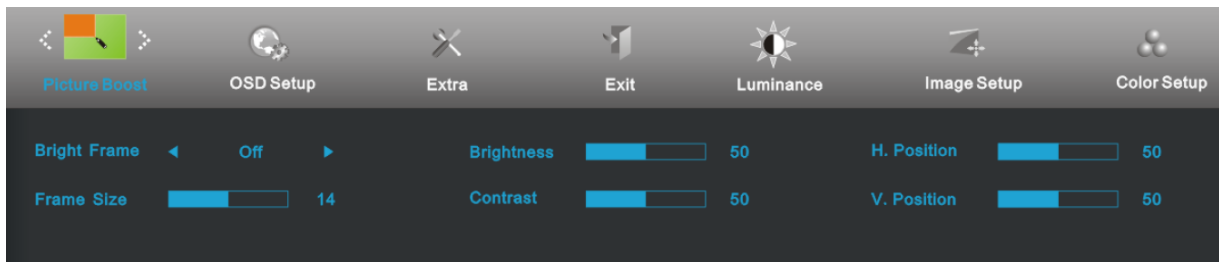



- 1 Press **MENU** (Menu) to display menu.
- 2 Press - or + to select  (Picture Boost), and press **MENU** to enter.
- 3 Press - or + to select submenu, and press **MENU** to enter.
- 4 Press - or + to adjust.
- 5 Press **AUTO** to exit.

	Frame Size	14-100	Adjust Frame Size.
	Brightness	0-100	Adjust Frame Brightness.
	Contrast	0-100	Adjust Frame Contrast.
	H. position	0-100	Adjust Frame horizontal position.
	V. position	0-100	Adjust Frame vertical position.
	Bright Frame	on or off	Disable or Enable Bright Frame.

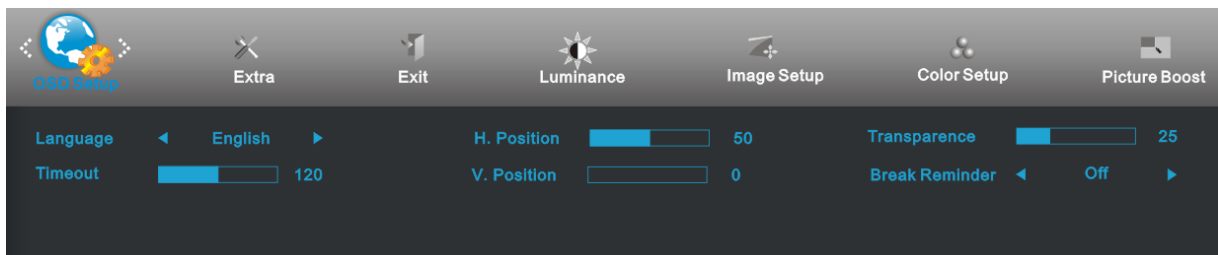
OSD Setup





- 1 Press **MENU** (Menu) to display menu.
- 2 Press - or + to select  (OSD Setup), and press **MENU** to enter.
- 3 Press - or + to select submenu, and press **MENU** to enter.
- 4 Press - or + to adjust.
- 5 Press **AUTO** to exit.

	H. Position	0-100	Adjust the horizontal position of OSD.
	V. Position	0-100	Adjust the vertical position of OSD.
	Timeout	5-120	Adjust the OSD Timeout.
	Transparence	0-100	Adjust the transparence of OSD.
	Language		Select the OSD language.
	Break Reminder	on or off	Disable or Enable (1 hour of work, break ?) / (2 hours of work, break ?)
	DP Capaciliby	1.1/1.2	please be noted that only DP1.2 support free sync function

Extra



- 1 Press **MENU** (Menu) to display menu.
- 2 Press - or + to select  (Extra), and press **MENU** to enter.
- 3 Press - or + to select submenu, and press **MENU** to enter.
- 4 Press - or + to adjust.
- 5 Press **AUTO** to exit.

	Input Select	Auto / D-SUB / DVI / HDMI/MHL /DP	Select input signal source. (E2770PQU/G2770PF)
	Input Select	Auto / Analog / HDMI1/ HDMI2	Select input signal source. (E2770SHE/ E2770SHE/NA)
	Input Select	Auto / Analog / DVI/HDMI	Select input signal source.(I2770VHE/M2870VHE/E2770SH)
	Input Select	Auto / Analog / DVI	Select input signal source. (E2770SD/M2770V/M2870V/I2770V/E2770SD6)
	Input Select	Auto / Analog / DVI / HDMI /DP	Select input signal source. (Q2770PQU/G2770PQU/M2870VQ/I2770PQ)
	Auto Config	Yes or No	Auto adjust the picture to default.
	Off timer	0-24hrs	Select DC off time.
	Image Ratio	wide or 4:3	Select wide or 4:3 format for display.
		wide / 4:3 / 1:1 / 17"(4:3) / 19"(4:3) /19"w(16:10) / 21.5"w(16:9) / 22"w(16:10) / 23"w(16:9) / 23.6"w(16:9) / 24"w(16:9) / 24"w(16:10)	Select image ratio for display.(G2770PQU)
		Full / Square / 1:1 / 17"(4:3) / 19"(4:3) /19"(5:4)/19"W(16:10) / 21.5"W(16:9) / 22"W(16:10) / 23"W(16:9) / 23.6"W(16:9) / 24"W(16:9)	Select image ratio for display.G2770PF
	DDC-CI	Yes or No	Turn ON/OFF DDC-CI Support.
Reset	Yes or No	Reset the menu to default.	
Information		Show the information of the main image and sub-image source.	

Exit

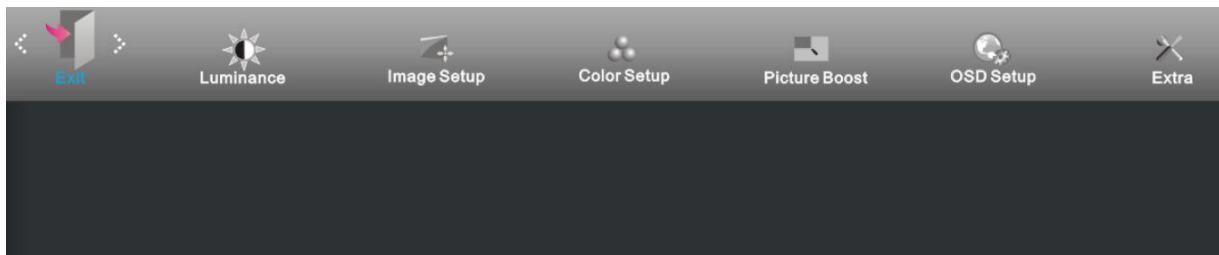



1 Press **MENU** (Menu) to display menu.

2 Press - or + to select  (Exit), and press **MENU** to enter.

3 Press **AUTO** to exit.

	Exit		Exit the main OSD.
---	------	--	--------------------

LED Indicator

Status	LED Color	
Full Power Mode	Green or Blue	
Active-off Mode	Orange or red	

Driver

Monitor Driver

Windows 10

- Start Windows® 10
- Right click **START**.
- Click "**Control Panel**".

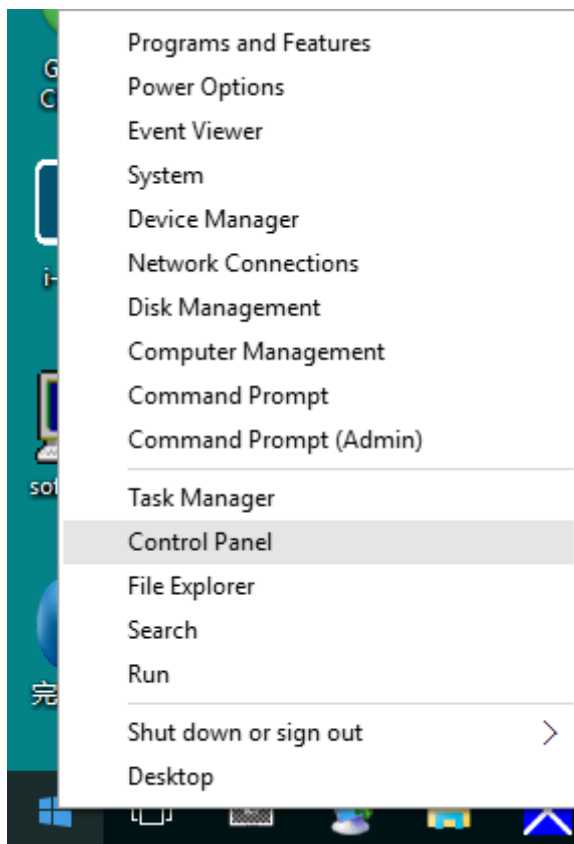

- Click on the "**Display**" icon.

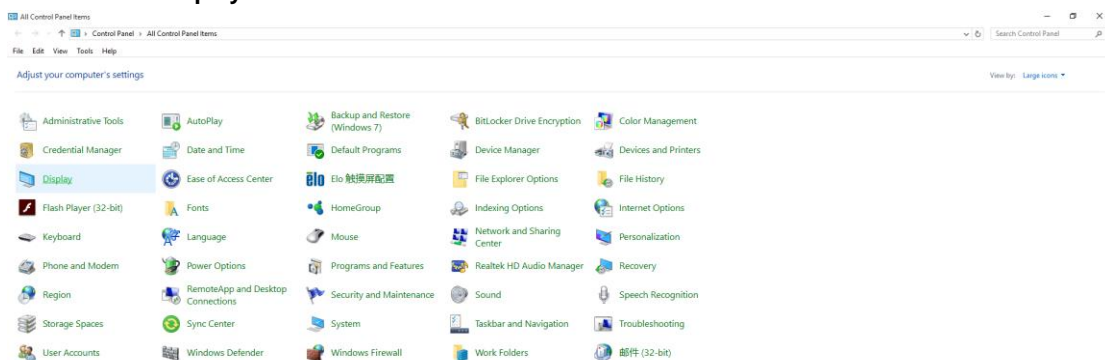

- Click on the **"Change display settings"** button

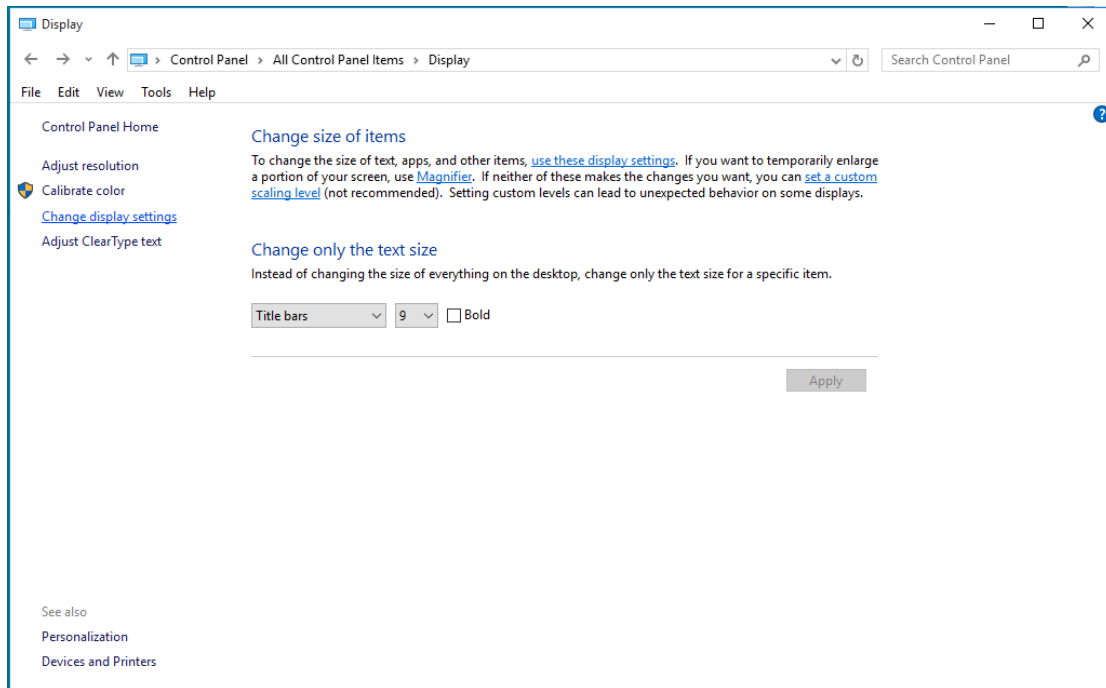

- Click the **"Advanced Settings"** button.

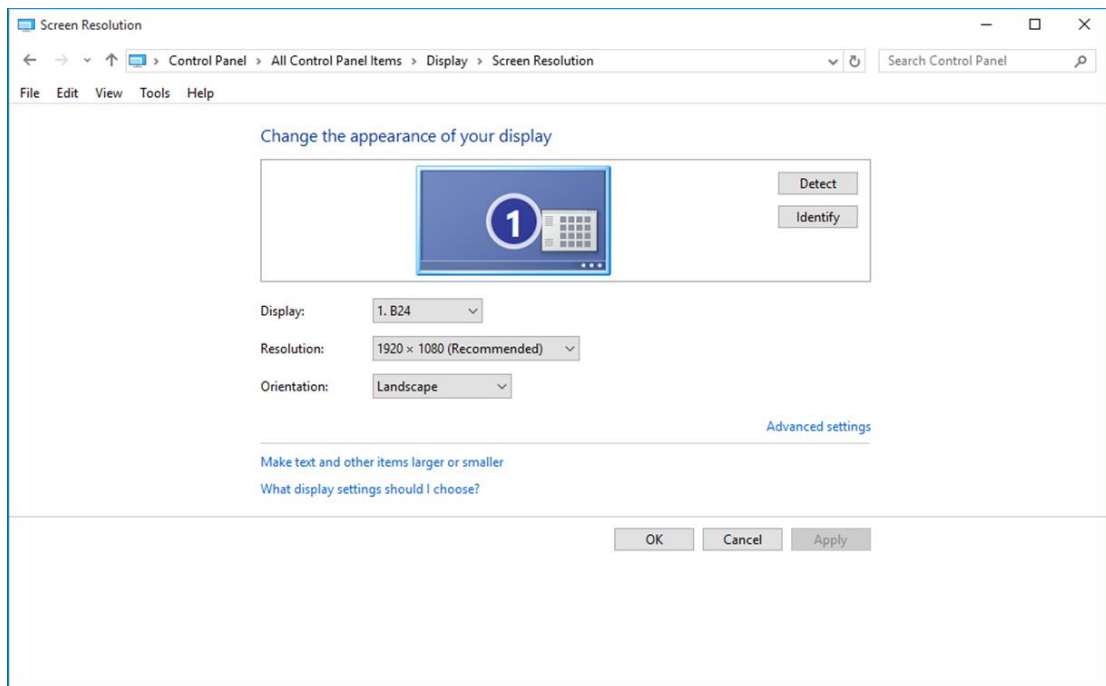

- Click the **"Monitor"** tab and then click the **"Properties"** button.

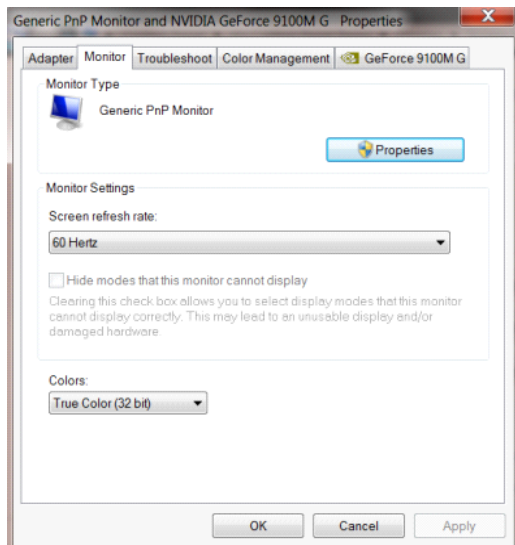

- Click the **"Driver"** tab.

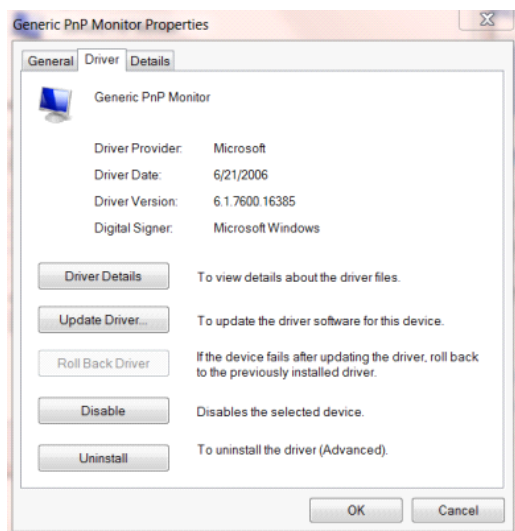

- Open the "Update Driver Software-Generic PnP Monitor" window by clicking on **"Update Driver..."** "and then click the **"Browse my computer for driver software"** button.

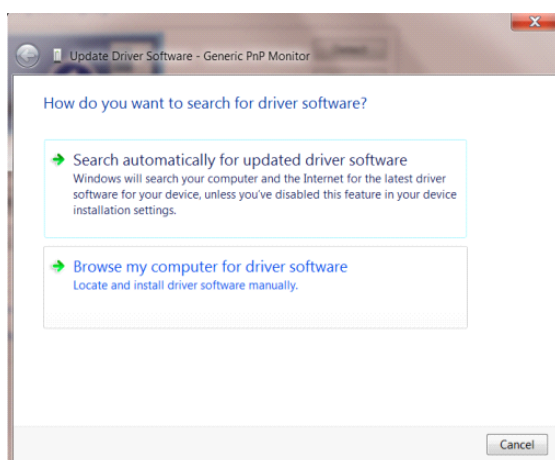

- Select **"Let me pick from a list of device drivers on my computer"**.

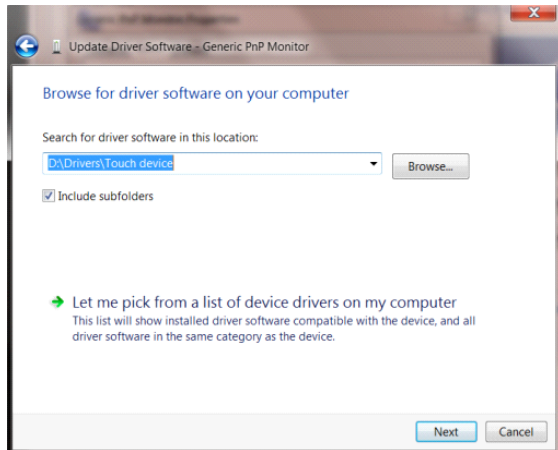

- Click the **"Have Disk"** button. Click on the **"Browse"** button and navigate to the following directory:
X:\Driver\module name(where X is the drive letter designator for the CD-ROM drive).

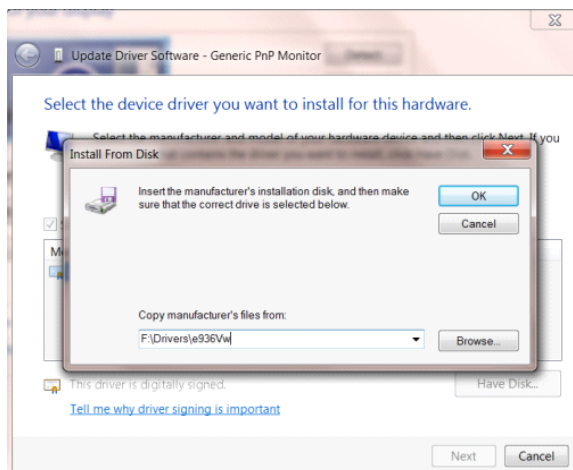

- Select the **"xxx.inf"** file and click the **"Open"** button. Click the **"OK"** button.
- Select your monitor model and click the **"Next"** button. The files will be copied from the CD to your hard disk drive.
- Close all open windows and remove the CD.
- Restart the system. The system will automatically select the maximum refresh rate and corresponding Color Matching Profiles.

Windows 8

- Start Windows® 8
- Right click and click **All apps** at the bottom-right of the screen.

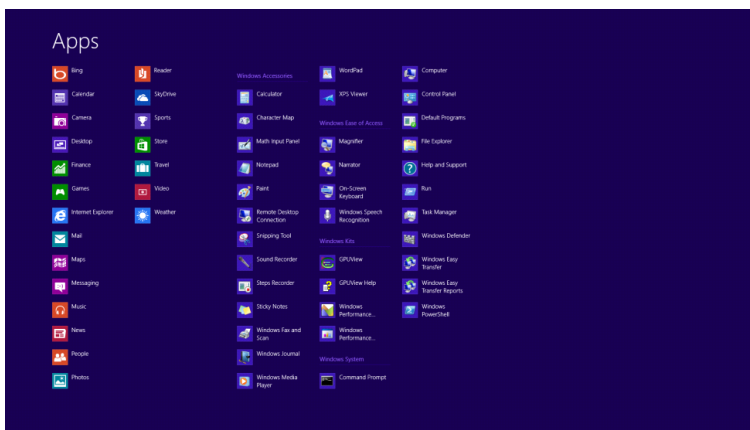
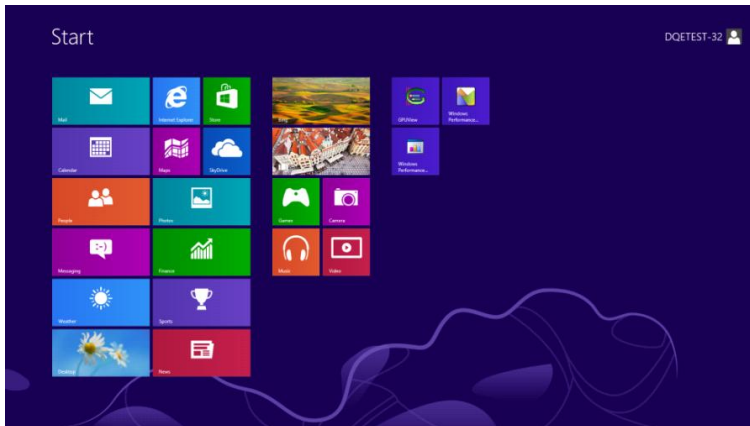

- Click on the "**Control Panel**" icon
- Set the "**View by**" to "**Large icons**" or "**Small icons**".

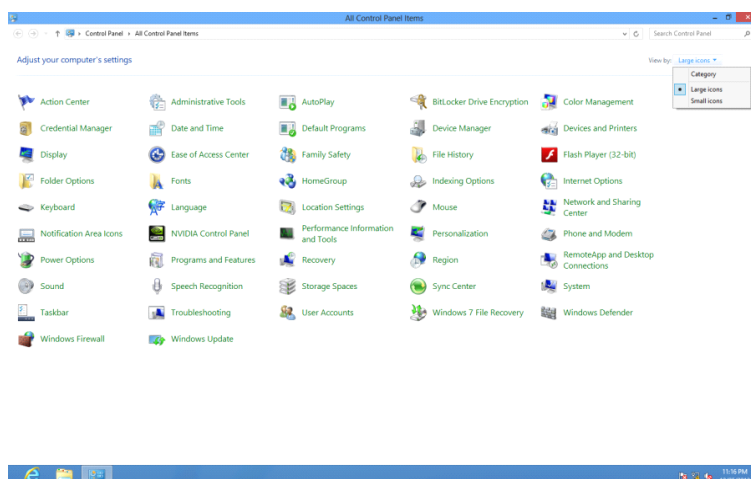

- Click on the "**Display**" icon.

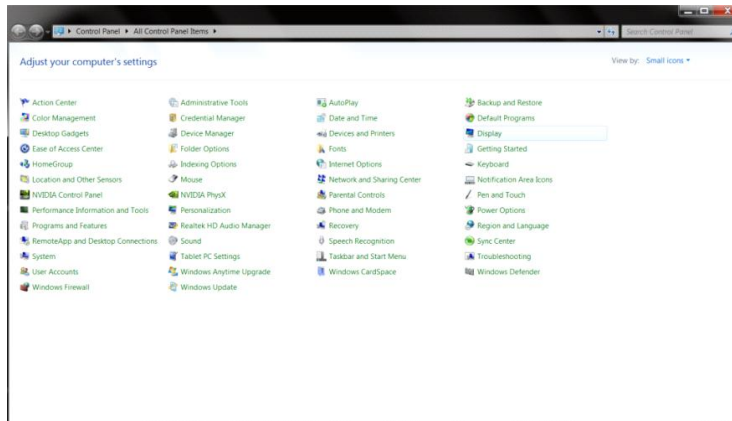

- Click on the "**Change display settings**" button.

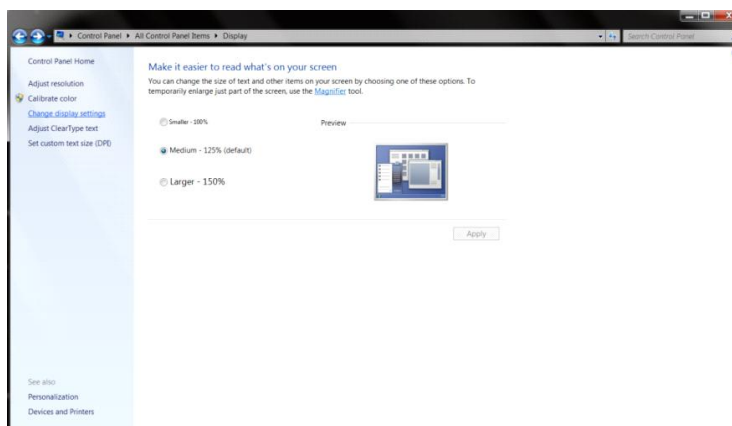

- Click the "**Advanced Settings**" button.

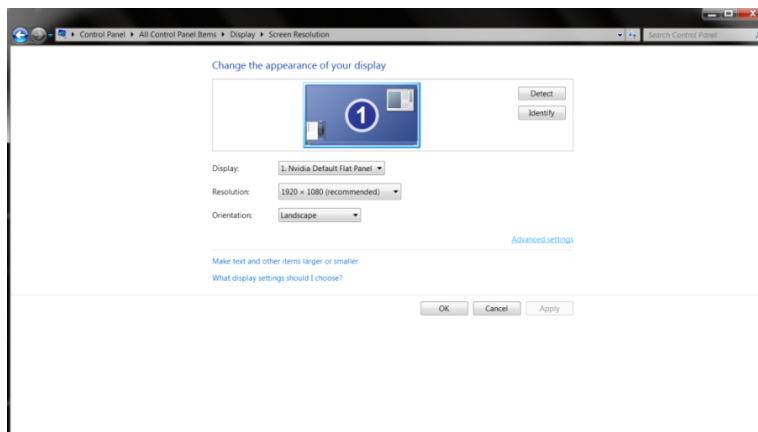

- Click the **"Monitor"** tab and then click the **"Properties"** button.

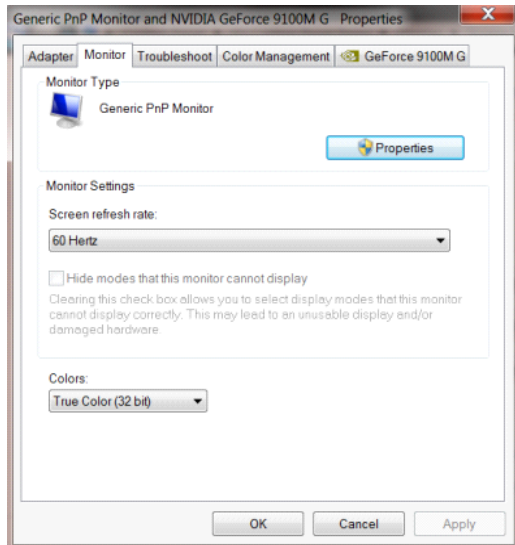

- Click the **"Driver"** tab.

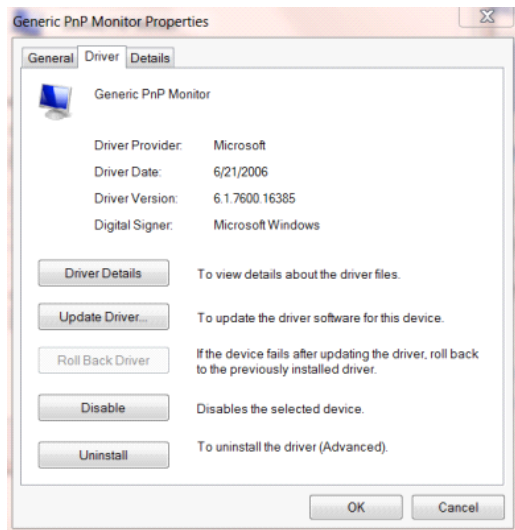

- Open the **"Update Driver Software-Generic PnP Monitor"** window by clicking on **"Update Driver..."** and then click the **"Browse my computer for driver software"** button.

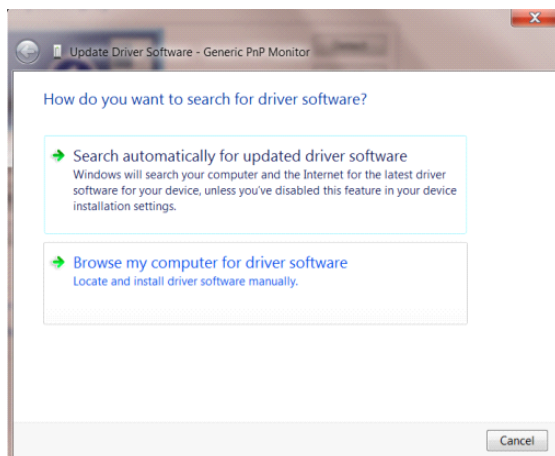

- Select **"Let me pick from a list of device drivers on my computer"**.

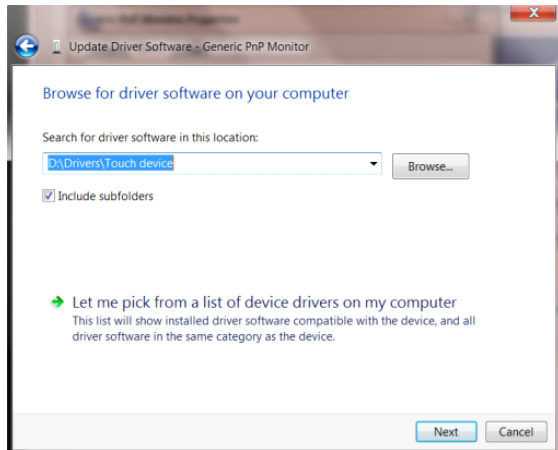

- Click the **"Have Disk"** button. Click on the **"Browse"** button and navigate to the following directory:
X:\Driver\module name (where X is the drive letter designator for the CD-ROM drive).

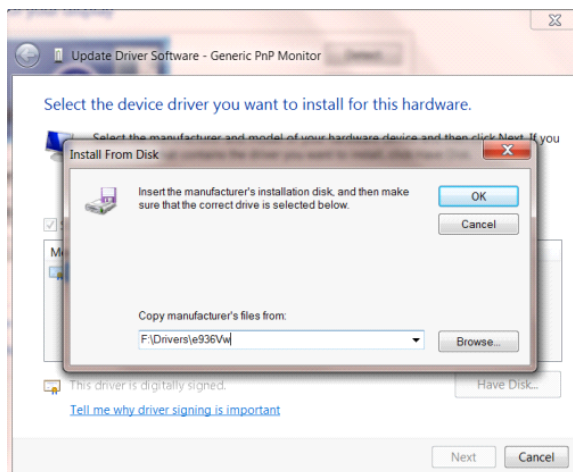

- Select the **"xxx.inf"** file and click the **"Open"** button. Click the **"OK"** button.
- Select your monitor model and click the **"Next"** button. The files will be copied from the CD to your hard disk drive.
- Close all open windows and remove the CD.
- Restart the system. The system will automatically select the maximum refresh rate and corresponding Color Matching Profiles.

Windows 7

- Start Windows® 7
- Click on the **"Start"** button and then click on **"Control Panel"**.

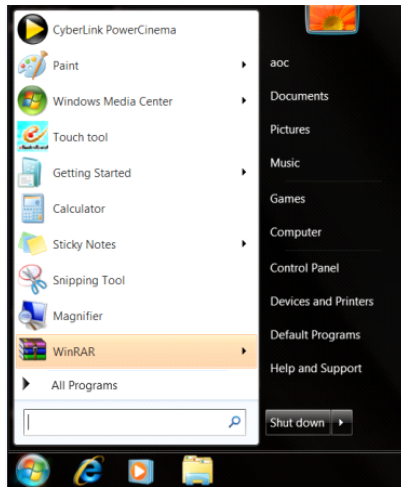

- Click on the **"Display"** icon.

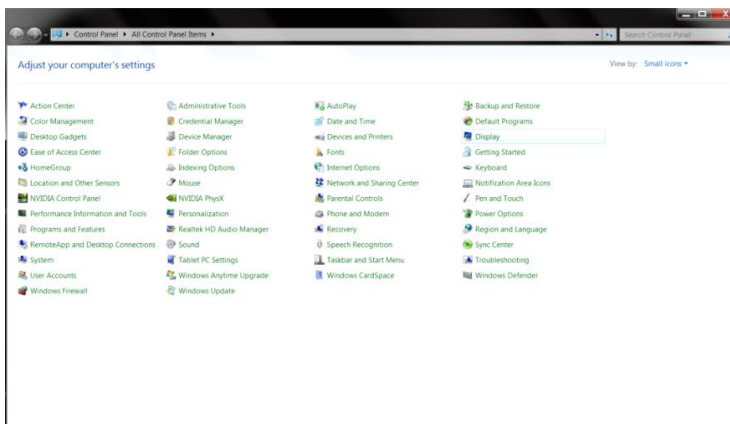

- Click on the **"Change display settings"** button.

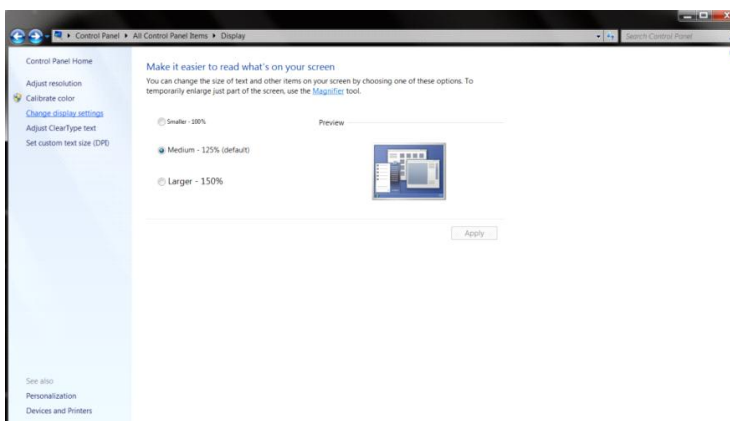

- Click the **"Advanced Settings"** button.

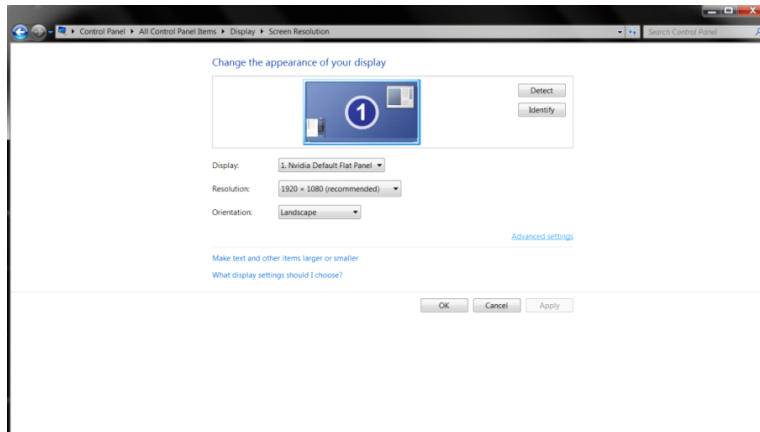

- Click the **"Monitor"** tab and then click the **"Properties"** button.

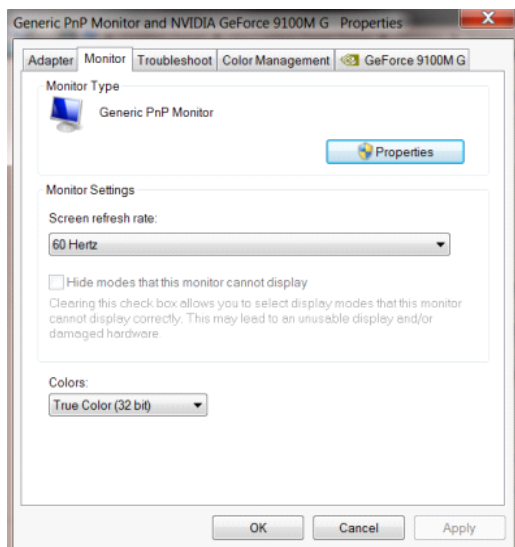

- Click the **"Driver"** tab.

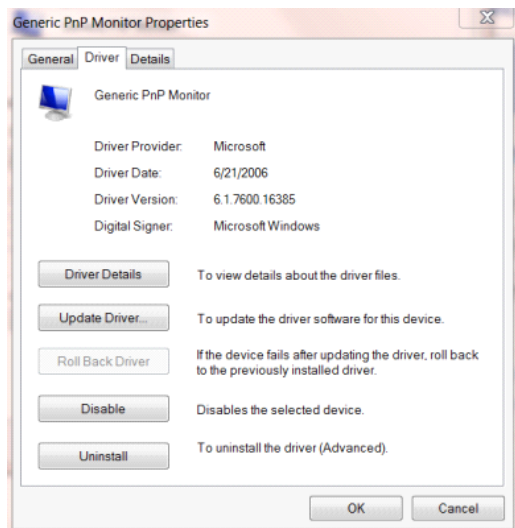

- Open the "Update Driver Software-Generic PnP Monitor" window by clicking on "Update Driver..." and then click the "Browse my computer for driver software" button.

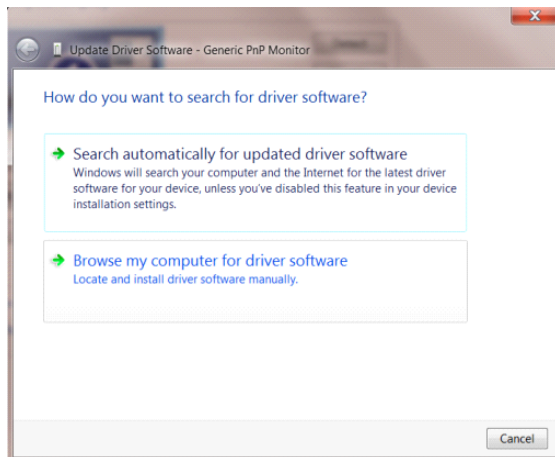

- Select "Let me pick from a list of device drivers on my computer".

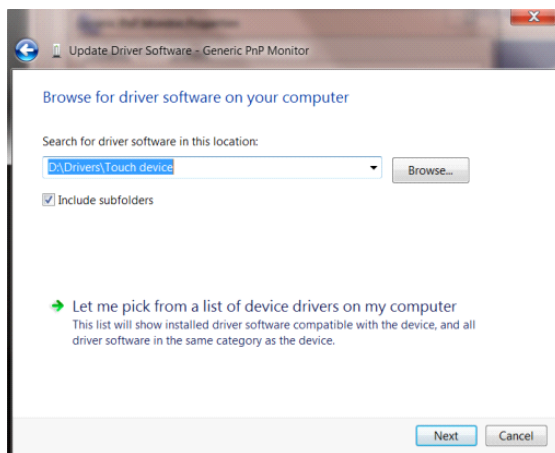

- Click the "Have Disk" button. Click on the "Browse" button and navigate to the following directory: X:\Driver\module name(where X is the drive letter designator for the CD-ROM drive).

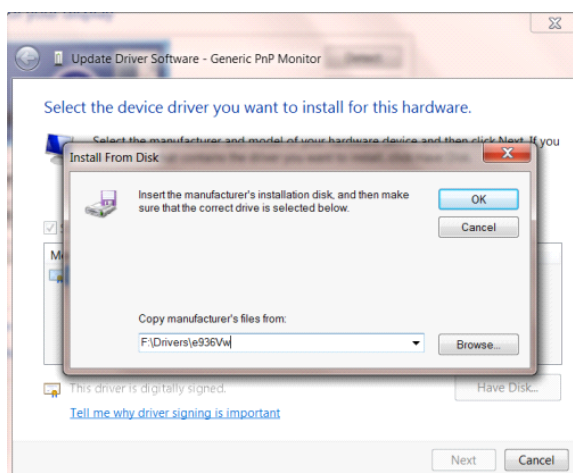

- Select the "**xxx.inf**" file and click the "**Open**" button. Click the "**OK**" button.
- Select your monitor model and click the "**Next**" button. The files will be copied from the CD to your hard disk drive.
- Close all open windows and remove the CD.
- Restart the system. The system will automatically select the maximum refresh rate and corresponding Color Matching Profiles.

i-Menu



Welcome to "i-Menu" software by AOC. i-Menu makes it easy to adjust your monitor display setting by using on screen menus instead of the OSD button on the monitor. To complete installation, please follow the installation guide.



e-Saver



Welcome to use AOC e-Saver monitor power management software! The AOC e-Saver features Smart Shutdown functions for your monitors, allows your monitor to timely shutdown when PC unit is at any status (On, Off, Sleep or Screen Saver); the actual shutdown time depends on your preferences (see example below).

Please click on "driver/e-Saver/setup.exe" to start installing the e-Saver software, follow the install wizard to complete software installation.

Under each of the four PC status, you may choose from the pull-down menu the desired time (in minutes) for your monitor to automatically shutdown. The example above illustrated:

- 1) The monitor will never shutdown when the PC is powered on.
- 2) The monitor will automatically shutdown 5 minutes after the PC is powered off.
- 3) The monitor will automatically shutdown 10 minutes after the PC is in sleep/stand-by mode.
- 4) The monitor will automatically shutdown 20 minutes after the screen saver appears.

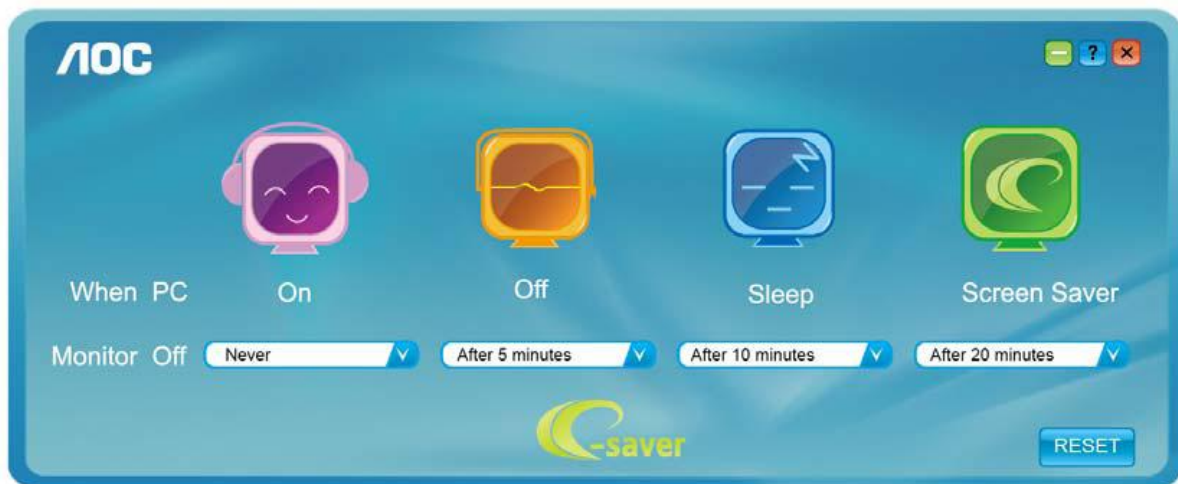

You can click "RESET" to set the e-Saver to its default settings like below.

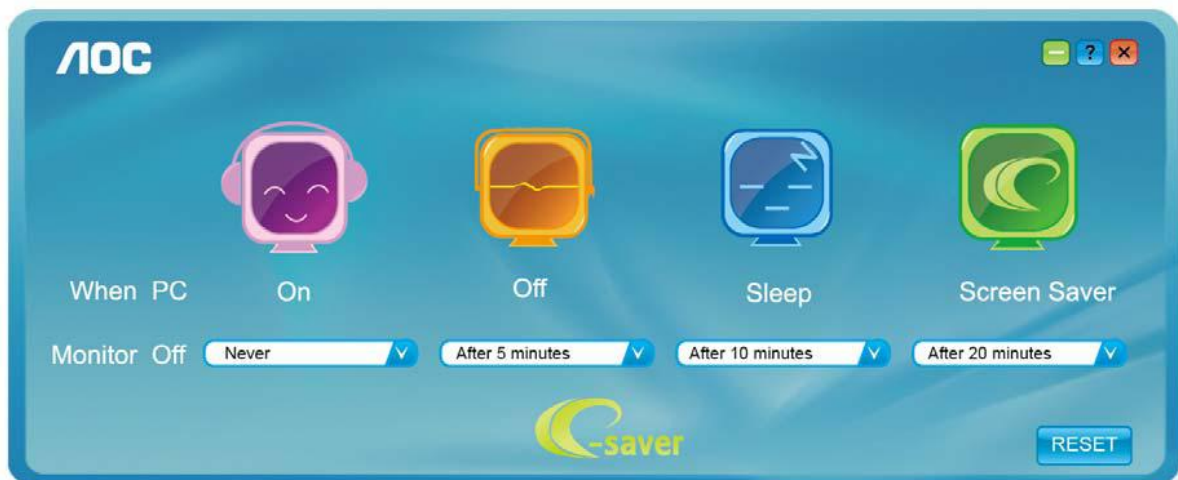

Screen+



Welcome to "Screen+" software by AOC, Screen+ software is a desktop screen splitting tool, it splits the desktop into different panes, each pane displays a different window. You only need to drag the window to a corresponding pane, when you want to access it. It supports multiple monitor display to make your task easier. Please follow the installation software to install it.

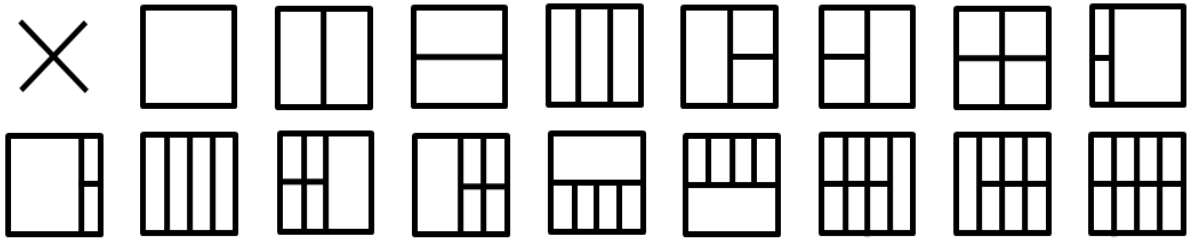

Troubleshoot

Problem & Question	Possible Solutions
Power LED Is Not ON	Make sure the power button is ON and the Power Cord is properly connected to a grounded power outlet and to the monitor.
No images on the screen	<ul style="list-style-type: none"> • Is the power cord connected properly? Check the power cord connection and power supply. • Is the signal cable connected correctly? (Connected using the signal cable) Check the signal cable connection. • If the power is on, reboot the computer to see the initial screen (the login screen), which can be seen. If the initial screen (the login screen) appears, boot the computer in the applicable mode (the safe mode for Windows ME/XP/2000) and then change the frequency of the video card. (Refer to the Setting the Optimal Resolution) If the initial screen (the login screen) does not appear, contact the Service Center or your dealer. • Can you see "Input Not Supported" on the screen? You can see this message when the signal from the video card exceeds the maximum resolution and frequency that the monitor can handle properly. Adjust the maximum resolution and frequency that the monitor can handle properly. • Make sure the AOC Monitor Drivers are installed.
Picture Is Fuzzy & Has Ghosting Shadowing Problem	<p>Adjust the Contrast and Brightness Controls. Press to auto adjust.</p> <p>Make sure you are not using an extension cable or switch box. We recommend plugging the monitor directly to the video card output connector on the back .</p>
Picture Bounces, Flickers Or Wave Pattern Appears In The Picture	<p>Move electrical devices that may cause electrical interference as far away from the monitor as possible.</p> <p>Use the maximum refresh rate your monitor is capable of at the resolution your are using.</p>

<p>Monitor Is Stuck In Active Off-Mode"</p>	<p>The Computer Power Switch should be in the ON position. The Computer Video Card should be snugly fitted in its slot. Make sure the monitor's video cable is properly connected to the computer. Inspect the monitor's video cable and make sure no pin is bent. Make sure your computer is operational by hitting the CAPS LOCK key on the keyboard while observing the CAPS LOCK LED. The LED should either turn ON or OFF after hitting the CAPS LOCK key.</p>
<p>Missing one of the primary colors (RED, GREEN, or BLUE)</p>	<p>Inspect the monitor's video cable and make sure that no pin is damaged. Make sure the monitor's video cable is properly connected to the computer.</p>
<p>Screen image is not centered or sized properly</p>	<p>Adjust H-Position and V-Position or press hot-key (Power/AUTO).</p>
<p>Picture has color defects (white does not look white)</p>	<p>Adjust RGB color or select desired color temperature.</p>
<p>Horizontal or vertical disturbances on the screen</p>	<p>Use Windows 95/98/2000/ME/XP shut-down mode Adjust CLOCK and FOCUS. Press to auto-adjust.</p>
<p>Display not on whole screen in default resolution ration</p>	<p>Use I-menu software from CD(or download from AOC official website), select "reset" option to adjust.</p>

Specification

General Specification

E2770SD /E2770SHE/M2770V/I2770V/I2770VHE/E2770SD6/E2770SH/ E2770SHE/NA

Panel	Product name	E2770SD/E2770SD6/E2770SHE/M2770V/I2770V/I2770VHE/E2770SH/ E2770SHE/NA	
	Driving system	TFT Color LCD	
	Viewable Image Size	68.6cm diagonal	
	Pixel pitch	0.3114mm(H)X0.3114mm(V)	
	Video	R, G, B Analog Interface & Digital Interface	
	Separate Sync.	H/V TTL	
	Display Color	16.7M Colors	
	Dot Clock	148.5MHz	
Resolution	Horizontal scan range	30 kHz - 83 kHz	
	Horizontal scan Size(Maximum)	597.89mm	
	Vertical scan range	50 Hz - 76 Hz	
	Vertical scan Size(Maximum)	336.31mm	
	Optimal preset resolution	1920x 1080 @60 Hz	
	Plug & Play	VESA DDC2B/CI	
	Input Connector	E2770SD/ E2770SD6/M2770V/I2770V:	D-Sub 15pin; DVI 24pin
		E2770SHE, E2770SHE/NA :	D-Sub 15pin;HDMI
		I2770VHE/E2770SH:	D-Sub 15pin; DVI 24pin; HDMI;
	Input Video Signal	Analog: 0.7Vp-p(standard), 75 OHM, TMDS	
	Power Source	100-240V~, 50/60Hz	
	Typical power consumption	E2770SD /E2770SD6/I2770V: 30W E2770SHE/I2770VHE/ E2770SHE/NA: 32W M2770V/E2770SH:38W (Test condition: set Contrast = 50, Brightness = 90)	
	Power Consumption	E2770SD /E2770SD6/I2770V: 32W E2770SHE/I2770VHE/ E2770SHE/NA: 40W M2770V/E2770SH:44W (Test condition: Set Brightness and Contrast to maximum)	
	Power consumption @power-saving	≅0.5W	
Off timer	0-24 hrs		
Speakers	2WX2(E2770SH)		
Physical	Connector Type	E2770SD/M2770V/I2770V /E2770SD6:D-Sub ; DVI-D	

Characteristics		E2770SHE/ E2770SHE/NA:D-Sub ; HDMI	
		I2770VHE/E2770SH: D-Sub ; DVI-D;HDMI;	
	Signal Cable Type	Detachable	
Environmental	Temperature:	Operating	0° to 40°
		Non-Operating	-25°to 55°
	Humidity:	Operating	10% to 85% (non-condensing)
		Non-Operating	5% to 93% (non-condensing)
	Altitude:	Operating	0~ 3658m (0~ 12000 ft)
		Non-Operating	0~ 12192m (0~ 40000 ft)

E2770PQU/I2770PQ

Panel	Product name	E2770PQU/I2770PQ	
	Driving system	TFT Color LCD	
	Viewable Image Size	68.6cm diagonal	
	Pixel pitch	0.3114mm(H)X0.3114mm(V)	
	Video	R, G, B Analog Interface & Digital Interface	
	Separate Sync.	H/V TTL	
	Display Color	16.7M Colors	
	Dot Clock	148.5MHz	
Resolution	Horizontal scan range	30 kHz - 83 kHz	
	Horizontal scan Size(Maximum)	597.89mm	
	Vertical scan range	50 Hz - 76 Hz	
	Vertical scan Size(Maximum)	336.31mm	
	Optimal preset resolution	1920x 1080 @60 Hz	
	Plug & Play	VESA DDC2B/CI	
	Input Connector	E2770PQU:D-Sub 15pin; DVI 24pin; HDMI(MHL) ;DP	
		I2770PQ:D-Sub 15pin; DVI 24pin; HDMI ;DP	
	Input Video Signal	Analog: 0.7Vp-p(standard), 75 OHM, TMDS	
	Power Source	100-240V~, 50/60Hz	
	Typical power consumption	E2770PQU: 32W I2770PQ:31W (Test condition: set Contrast = 50, Brightness = 90)	
	Power Consumption	E2770PQU: 40W I2770PQ:39W (Test condition: Set Brightness and Contrast to maximum)	
	Power consumption @power-saving	≅ 0.5W	
Off timer	0-24 hrs		
Speakers	2WX2		
Physical Characteristics	Connector Type	15-pin D-Sub DVI-D HDMI DP	
	Signal Cable Type	Detachable	
Environmental	Temperature:	Operating	0° to 40°
		Non-Operating	-25°to 55°
	Humidity:	Operating	10% to 85% (non-condensing)
		Non-Operating	5% to 93% (non-condensing)
	Altitude:	Operating	0~ 3658m (0~ 12000 ft)
		Non-Operating	0~ 12192m (0~ 40000 ft)

Q2770PQU

Panel	Model name	Q2770PQU
	Driving system	TFT Color LCD
	Viewable Image Size	68.6cm diagonal
	Pixel pitch	0.233mm(H)X0.233mm(V)
	Video	R, G, B Analog Interface & Digital Interface
	Separate Sync.	H/V TTL
	Display Color	16.7M Colors
	Dot Clock	241.5MHz
Resolution	Horizontal scan range	30 kHz - 83 kHz for D-Sub
	Horizontal scan range	30 kHz - 99 kHz for DVI (dual link) ; HDMI ; DP
	Horizontal scan Size(Maximum)	596.74mm
	Vertical scan range	50 Hz - 76 Hz
	Vertical scan Size(Maximum)	335.66mm
	Optimal preset resolution	1920x 1080 @60 Hz for D-Sub
	Optimal preset resolution	2560x 1440 @60 Hz for DVI (dual link) ; HDMI ; DP only
	Plug & Play	VESA DDC2B/CI
	Input Connector	D-Sub 15pin; DVI 24pin; HDMI;DP
	Input Video Signal	Analog: 0.7Vp-p(standard), 75 OHM, TMDS
	Power Source	100-240V~, 50/60Hz
	Typical power consumption	45W(Test condition: set Contrast = 50, Brightness = 90)
	Power Consumption	50W(Test condition: Set Brightness and Contrast to maximum)
	Power consumption @power-saving	≦ 0.5W
	Off timer	0-24 hrs
Speakers	2WX2	
Physical Characteristics	Connector Type	15-pin D-Sub DVI-D HDMI DP
	Signal Cable Type	Detachable
Environmental	Temperature:	
	Operating	0° to 40°
	Non-Operating	-25° to 55°
	Humidity:	
	Operating	10% to 85% (non-condensing)
	Non-Operating	5% to 93% (non-condensing)
	Altitude:	
	Operating	0~ 3658m (0~ 12000 ft)
Non-Operating	0~ 12192m (0~ 40000 ft)	

G2770PQU/G2770PF

Panel	Model name	G2770PQU/G2770PF
	Driving system	TFT Color LCD
	Viewable Image Size	68.6cm diagonal
	Pixel pitch	0.311mm(H)X0.311mm(V)
	Video	R, G, B Analog Interface & Digital Interface
	Separate Sync.	H/V TTL
	Display Color	16.7M Colors
	Dot Clock	330MHz
Resolution	Horizontal scan range	30 kHz - 83 kHz
	Horizontal scan range	30 kHz - 160 kHz for DVI (dual link) ; DP only
	Horizontal scan range G2770PF	160 kHz - 160 kHz for DP only
	Horizontal scan Size(Maximum)	597.6mm
	Vertical scan range	50 Hz - 76 Hz
	Vertical scan range	50Hz~146Hz for DVI (dual link) ; DP only
	Vertical scan range G2770PF	35Hz~146Hz for DP only
	Vertical scan Size(Maximum)	336.15mm
	Optimal preset resolution	1920x 1080 @60 Hz
	Optimal preset resolution	1920x 1080 @144 Hz for DVI (dual link) ; DP only
	Plug & Play	VESA DDC2B/CI
	Input Connector	D-Sub 15pin; DVI 24pin; HDMI;DP
	Input Connector G2770PF	D-Sub 15pin; DVI 24pin; HDMI/ MHL;DP;
	Input Video Signal	Analog: 0.7Vp-p(standard), 75 OHM, TMDS
	Power Source	100-240V~, 50/60Hz
	Typical power consumption	45W(Test condition: set Contrast = 50, Brightness = 90)
	Typical power consumption G2770PQU	37W(Test condition: set Contrast = 50, Brightness = 90)
	Power Consumption	55W(Test condition: Set Brightness and Contrast to maximum)
	Power consumption @power-saving	≦0.5W
	Off timer	0-24 hrs
Speakers	2WX2	
Physical Characteristics	Connector Type	15-pin D-Sub DVI-D HDMI DP
	Connector Type G2770PF	15-pin D-Sub DVI-D HDMI/ MHL DP
	Signal Cable Type	Detachable
Environmental	Temperature:	
	Operating	0° to 40°
	Non-Operating	-25° to 55°
	Humidity:	
	Operating	10% to 85% (non-condensing)
	Non-Operating	5% to 93% (non-condensing)
	Altitude:	
	Operating	0~ 3658m (0~ 12000 ft)
	Non-Operating	0~ 12192m (0~ 40000 ft)

M2870V/ M2870VQ/M2870VHE

Panel	Model name	M2870V/ M2870VQ/M2870VHE
	Driving system	TFT Color LCD
	Viewable Image Size	71.1cm diagonal
	Pixel pitch	0.32mm(H)X0.32mm(V)
	Video	R, G, B Analog Interface & Digital Interface
	Separate Sync.	H/V TTL
	Display Color	16.7M Colors
	Dot Clock	148.5MHz
Resolution	Horizontal scan range	30 kHz - 83 kHz
	Horizontal scan Size(Maximum)	620.9mm
	Vertical scan range	50 Hz - 76 Hz
	Vertical scan Size(Maximum)	341.2mm
	Optimal preset resolution	1920x 1080 @60 Hz
	Plug & Play	VESA DDC2B/CI
	Input Connector	(M2870V)D-Sub 15pin; DVI 24pin
		(M2870VHE)D-Sub 15pin; DVI 24pin; HDMI;
		(M2870VQ)D-Sub 15pin; DVI 24pin; HDMI;DP
	Input Video Signal	Analog: 0.7Vp-p(standard), 75 OHM, TMDS
	Power Source	100-240V~, 50/60Hz
	Typical power consumption	41W(Test condition: set Contrast = 50, Brightness = 90)
	Power Consumption	49W(Test condition: Set Brightness and Contrast to maximum)
	Power consumption @power-saving	≤ 0.5W
Off timer	0-24 hrs	
Speakers	2WX2 (M2870VQ)	
Physical Characteristics	Connector Type	M2870V:D-Sub ; DVI-D
		M2870VHE:D-Sub ; DVI-D,HDMI
		M2870VQ:D-Sub ; DVI-D,HDMI;DP
Signal Cable Type	Detachable	
Environmental	Temperature:	
	Operating	0° to 40°
	Non-Operating	-25° to 55°
	Humidity:	
	Operating	10% to 85% (non-condensing)
	Non-Operating	5% to 93% (non-condensing)
	Altitude:	
	Operating	0~ 3658m (0~ 12000 ft)
Non-Operating	0~ 12192m (0~ 40000 ft)	

Preset Display Modes

E2770SD/E2770SD6/E2770SHE/E2770PQU/M2770V/M2870V/I2770V/I2770VHE/M2870VHE/
M2870VQ/I2770PQ/E2770SH/ E2770SHE/NA

Standard	Resolution	H. Frequency (kHz)	V. Frequency (Hz)
VGA	640 X 480@60Hz	31.469	59.94
MAC MODE	640 X 480@67Hz	35	66.667
VGA	640 X 480@72Hz	37.861	72.809
VGA	640 X 480@75Hz	37.5	75
IBM MODE	720 X 400@70Hz	31.469	70.087
SVGA	800 X 600@56Hz	35.156	56.25
	800 X 600@60Hz	37.879	60.317
	800 X 600@72Hz	48.077	72.188
	800 X 600@75Hz	46.875	75
MAC MODE	832 X 624@75Hz	49.725	74.551
XGA	1024 X 768@60Hz	48.363	60.004
	1024 X 768@70Hz	56.476	70.069
	1024 X 768@75Hz	60.023	75.029
***	1280 X 960@60Hz	60	60
SXGA	1280 X 1024@60Hz	63.981	60.02
	1280 X 1024@75Hz	79.976	75.025
***	1280X 720@60Hz	44.772	59.855
WXGA+	1440 X 900@60Hz	55.935	59.876
WSXGA+	1680 X 1050@60Hz	65.29	59.95
FHD	1920 X 1080@60Hz	67.5	60

Q2770PQU

Standard	Resolution	H. Frequency (kHz)	V. Frequency (Hz)
VGA	640 X 480@60Hz	31.469	59.94
MAC MODE	640 X 480@67Hz	35	66.667
VGA	640 X 480@72Hz	37.861	72.809
VGA	640 X 480@75Hz	37.5	75
IBM MODE	720 X 400@70Hz	31.469	70.087
SVGA	800 X 600@56Hz	35.156	56.25
	800 X 600@60Hz	37.879	60.317
	800 X 600@72Hz	48.077	72.188
	800 X 600@75Hz	46.875	75
MAC MODE	832 X 624@75Hz	49.725	74.551
XGA	1024 X 768@60Hz	48.363	60.004
	1024 X 768@70Hz	56.476	70.069
	1024 X 768@75Hz	60.023	75.029
***	1280 X 960@60Hz	60	60
SXGA	1280 X 1024@60Hz	63.981	60.02
	1280 X 1024@75Hz	79.976	75.025
***	1280X 720@60Hz	44.772	59.855
WXGA+	1440 X 900@60Hz	55.935	59.876
WSXGA+	1680 X 1050@60Hz	65.29	59.95
FHD	1920 X 1080@60Hz	67.5	60
WQHD	2560 X 1440@60Hz	88.787	60

WQHD Mode(2560x1440) for Q2770PQU model DVI(dual link), Display Port only; For HDMI, the highest supporting screen resolution is also 2560 x 1440, but it always depends on your capability of graphics card and BluRay/video players.

G2770PQU/G2770PF

Standard	Resolution	H. Frequency (kHz)	V. Frequency (Hz)
VGA	640x480@60Hz	31.469	59.94
	640x480@72Hz	37.861	72.809
	640x480@75Hz	37.5	75
SVGA	800x600@56Hz	35.156	56.25
	800x600@60Hz	37.879	60.317
	800x600@72Hz	48.077	72.188
	800x600@75Hz	46.875	75
	800x600@100Hz	46.875	75
XGA	1024x768@60Hz	48.363	60.004
	1024x768@70Hz	56.476	70.069
SXGA	1280x1024@60Hz	63.981	60.02
WXGA (DVI/HDMI/DP)	1440x900@60Hz	55.935	59.887
WSXGA (DVI/HDMI/DP)	1680x1050@60Hz	65.29	59.954
HD	1920x1080@60Hz	67.5	60
*** (DVI/HDMI/DP)	1280x720@60Hz	45	60
IBM MODES DOS	720x400@70Hz	31.469	70.087
MAC MODES VGA	640x480@67Hz	35	66.667
MAC MODES SVGA	832x624@75Hz	49.725	74.551
HD(only DVI/DP)	1920x1080@100Hz	113.3	100
	1920x1080@120Hz	137.2	120
	1920x1080@144Hz	158.1	144

**HDMI/DP Timing(E2770SHE/E2770PQU/Q2770PQU/G2770PQU /I2770VHE/M2870VQ/M2870VHE/
E2770SH/G2770PF/ E2770SHE/NA)**

Format	Resolution	Vertical frequency
480P	640 X 480	60Hz
480P	720 X 480	60Hz
576P	720 X 576	50Hz
720P	1280 X 720	50Hz,60Hz
1080P	1920 X 1080	50Hz,60Hz

MHL Timing(E2770PQU/ G2770PF)

Format	Resolution	Type	Vertical frequency
480P	640 X 480	SD	60Hz
480P	720 X 480	SD	60Hz
576P	720 X 576	SD	50Hz
720P	1280 X 720	HD	50Hz,60Hz
1080P	1920 X 1080	HD	30Hz,50Hz,60Hz

Pin Assignments

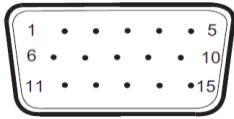

15-Pin Color Display Signal Cable

Pin No.	Signal Name	Pin No.	Signal Name
1	Video-Red	9	+5V
2	Video-Green	10	Ground
3	Video-Blue	11	N.C.
4	N.C.	12	DDC-Serial data
5	Detect Cable	13	H-sync
6	GND-R	14	V-sync
7	GND-G	15	DDC-Serial clock
8	GND-B		

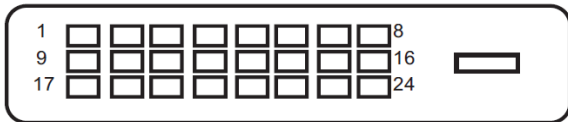

24-Pin Color Display Signal Cable

Pin Number	24-Pin Color Display Signal Cable	Pin Number	24-Pin Color Display Signal Cable
1	TMDS data 2-	13	TMDS data 3+
2	TMDS data 2+	14	+5V Power
3	TMDS data 2/4 Shield	15	Ground (for+5V)
4	TMDS data 4-	16	Hot Plug Detect
5	TMDS data 4+	17	TMDS data 0-
6	DDC Clock	18	TMDS data 0+
7	DDC Data	19	TMDS data 0/5 Shield
8	N.C.	20	TMDS data 5-
9	TMDS data 1-	21	TMDS data 5+
10	TMDS data 1+	22	TMDS Clock Shield
11	TMDS data 1/3 Shield	23	TMDS Clock +
12	TMDS data 3-	24	TMDS Clock -



19-Pin Color Display Signal Cable

Pin No.	Signal Name	Pin No.	Signal Name	Pin No.	Signal Name
1	TMDS Data 2+	9	TMDS Data 0	17	DDC/CEC Ground
2	TMDS Data 2 Shield	10	TMDS Clock +	18	+5V Power
3	TMDS Data 2	11	TMDS Clock Shield	19	Hot Plug Detect
4	TMDS Data 1+	12	TMDS Clock		
5	TMDS Data 1Shield	13	CEC		
6	TMDS Data 1	14	Reserved (N.C. on device)		
7	TMDS Data 0+	15	SCL		
8	TMDS Data 0 Shield	16	SDA		

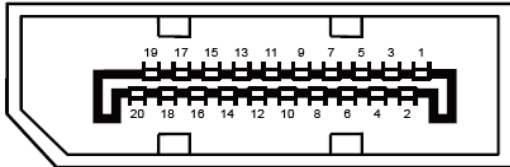

20-Pin Color Display Signal Cable

Pin No.	Signal Name	Pin No.	Signal Name
1	ML_Lane 3 (n)	11	GND
2	GND	12	ML_Lane 0 (p)
3	ML_Lane 3 (p)	13	CONFIG1
4	ML_Lane 2 (n)	14	CONFIG2
5	GND	15	AUX_CH(p)
6	ML_Lane 2 (p)	16	GND
7	ML_Lane 1 (n)	17	AUX_CH(n)
8	GND	18	Hot Plug Detect
9	ML_Lane 1 (p)	19	Return DP_PWR
10	ML_Lane 0 (n)	20	DP_PWR

Plug and Play

Plug & Play DDC2B Feature

This monitor is equipped with VESA DDC2B capabilities according to the VESA DDC STANDARD. It allows the monitor to inform the host system of its identity and, depending on the level of DDC used, communicate additional information about its display capabilities.

The DDC2B is a bi-directional data channel based on the I2C protocol. The host can request EDID information over the DDC2B channel.

Regulation

FCC Notice

FCC Class B Radio Frequency Interference Statement WARNING: (FOR FCC CERTIFIED MODELS)

NOTE: This equipment has been tested and found to comply with the limits for a Class B digital device, pursuant to Part 15 of the FCC Rules. These limits are designed to provide reasonable protection against harmful interference in a residential installation. This equipment generates, uses and can radiate radio frequency energy, and if not installed and used in accordance with the instructions, may cause harmful interference to radio communications. However, there is no guarantee that interference will not occur in a particular installation. If this equipment does cause harmful interference to radio or television reception, which can be determined by turning the equipment off and on, the user is encouraged to try to correct the interference by one or more of the following measures:

Reorient or relocate the receiving antenna.

Increase the separation between the equipment and receiver.

Connect the equipment into an outlet on a circuit different from that to which the receiver is connected.

Consult the dealer or an experienced radio/TV technician for help.

NOTICE :

The changes or modifications not expressly approved by the party responsible for compliance could void the user's authority to operate the equipment.

Shielded interface cables and AC power cord, if any, must be used in order to comply with the emission limits.

The manufacturer is not responsible for any radio or TV interference caused by unauthorized modification to this equipment. It is the responsibilities of the user to correct such interference. It is the responsibility of the user to correct such interference.

WEEE Declaration (Optional)

Disposal of Waste Equipment by Users in Private Household in the European Union.



This symbol on the product or on its packaging indicates that this product must not be disposed of with your other household waste. Instead, it is your responsibility to dispose of your waste equipment by handing it over to a designated collection point for the recycling of waste electrical and electronic equipment. The separate collection and recycling of your waste equipment at the time of disposal will help to conserve natural resources and ensure that it is recycled in a manner that protects human health and the environment. For more information about where you can drop off your waste equipment for recycling, please contact your local city office, your household waste disposal service or the shop where you purchased the product .

WEEE Declaration for India (Optional)



This symbol on the product or on its packaging indicates that this product must not be disposed of with your other household waste. Instead it is your responsibility to dispose of your waste equipment by handing it over to a designated collection point for the recycling of waste electrical and electronic equipment. The separate collection and recycling of your waste equipment at the time of disposal will help to conserve natural resources and ensure that it is recycled in a manner that protects human health and the environment.

For more information about where you can drop off your waste equipment for recycling in India please visit the below web link.

www.aocindia.com/ewaste.php.

This product complies with all implemented RoHS type regulations worldwide, including but not limited to, EU, Korea, Japan, US States (e.g. California), Ukraine, Serbia, Turkey, Vietnam and India.

We continue to monitor, influence and develop our processes to comply with upcoming proposed RoHS type regulations, including but not limited to, Brazil, Argentina, Canada.

Restriction on Hazardous Substances statement (India)

This product complies with the "India E-waste Rule" and prohibits use of lead, mercury, hexavalent chromium, polybrominated biphenyls or polybrominated diphenyl ethers in concentrations exceeding 0.1 weight % and 0.01 weight % for cadmium, except for the exemptions set in Schedule 2 of the Rule.

EPA Energy Star



ENERGY STAR® is a U.S. registered mark. As an ENERGY STAR® Partner, AOC International (Europe) BV and Envision Peripherals, Inc. have determined that this product meets the ENERGY STAR® guidelines for energy efficiency.

(FOR EPA CERTIFIED MODELS)

EPEAT Declaration



EPEAT is a system to help purchasers in the public and private sectors evaluate, compare and select desktop computers, notebooks and monitors based on their environmental attributes. EPEAT also provides a clear and consistent set of performance criteria for the design of products, and provides an opportunity for manufacturers to secure market recognition for efforts to reduce the environmental impact of its products.

AOC believes in protecting the environment.

With a key concern for the conservation of natural resources, as well as landfill protection, AOC announces the launch of AOC monitor's packaging recycling program. This program is designed to help you discard of your monitor carton and filler materials properly. If a local recycling center is not available, AOC will recycle the packaging material for you, including foam filler and carton. AOC Display solution will only recycle AOC monitor packaging. Please refer to the following website address:

For North America:

<http://us.aoc.com/aoc-corporation/?page=environmental-impact>

For Germany:

<http://aoc-europe.com/de/content/environment>

For Brazil:

<http://www.aoc.com.br/pg/embalagem-verde>

(FOR EPEAT Silver CERTIFIED MODELS)

EPEAT Declaration



EPEAT is a system to help purchasers in the public and private sectors evaluate, compare and select desktop computers, notebooks and monitors based on their environmental attributes. EPEAT also provides a clear and consistent set of performance criteria for the design of products, and provides an opportunity for manufacturers to secure market recognition for efforts to reduce the environmental impact of its products.

AOC believes in protecting the environment.

With a key concern for the conservation of natural resources, as well as landfill protection, AOC announces the launch of AOC monitor's packaging recycling program. This program is designed to help you discard of your monitor carton and filler materials properly. If a local recycling center is not available, AOC will recycle the packaging material for you, including foam filler and carton. AOC Display solution will only recycle AOC monitor packaging. Please refer to the following website address:

For North America:

<http://us.aoc.com/aoc-corporation/?page=environmental-impact>

For Germany:

<http://aoc-europe.com/de/content/environment>

For Brazil:

<http://www.aoc.com.br/pg/embalagem-verde>

(FOR EPEAT GOLD CERTIFIED MODELS)

TCO DOCUMENT



Congratulations!

This product is TCO Certified – for Sustainable IT



TCO Certified is an international third party sustainability certification for IT products. TCO Certified ensures that the manufacture, use and recycling of IT products reflect environmental, social and economic responsibility. Every TCO Certified product model is verified by an accredited independent test laboratory.

This product has been verified to meet all the criteria in TCO Certified, including:

Corporate Social Responsibility

Socially responsible production - working conditions and labor law in manufacturing country

Energy Efficiency

Energy efficiency of product and power supply. Energy Star compliant, where applicable

Environmental Management System

Manufacturer must be certified according to either ISO 14001 or EMAS

Minimization of Hazardous Substances

Limits on cadmium, mercury, lead & hexavalent chromium including requirements for mercury-free products, halogenated substances and hazardous flame retardants

Design for Recycling

Coding of plastics for easy recycling. Limit on the number of different plastics used.

Product Lifetime, Product Take Back

Minimum one-year product warranty. Minimum three-year availability of spare parts. Product takeback

Packaging

Limits on hazardous substances in product packaging. Packaging prepared for recycling

Ergonomic, User-centered design

Visual ergonomics in products with a display. Adjustability for user comfort (displays, headsets)

Acoustic performance – protection against sound spikes (headsets) and fan noise (projectors, computers)

Ergonomically designed keyboard (notebooks)

Electrical Safety, minimal electro-magnetic Emissions

Third Party Testing

All certified product models have been tested in an independent, accredited laboratory.

A detailed criteria set is available for download at www.tcodevelopment.com, where you can also find a searchable database of all TCO Certified IT products.

TCO Development, the organization behind TCO Certified, has been an international driver in the field of Sustainable IT for 20 years. Criteria in TCO Certified are developed in collaboration with scientists, experts, users and manufacturers. Organizations around the world rely on TCO Certified as a tool to help them reach their sustainable IT goals. We are owned by TCO, a non-profit organization representing office workers. TCO Development is headquartered in Stockholm, Sweden, with regional presence in North America and Asia.

For more information, please visit
www.tcodevelopment.com

(FOR TCO CERTIFIED MODELS)

Service

Warranty Statement for Europe

LIMITED THREE-YEAR WARRANTY*

For AOC LCD Monitors sold within Europe, AOC International (Europe) B.V. warrants this product to be free from defects in material and workmanship for a period of Three (3) years after the original date of consumer purchase. During this period, AOC International (Europe) B.V. will, at its option, either repair the defective product with new or rebuilt parts, or replace it with a new or rebuilt product at no charge except as *stated below. In the absence of the proof of purchase, the warranty will start 3 months after the date of manufacturing indicated on the product.

If the product appears to be defective, please contact your local dealer or refer to the service and support section on www.aoc-europe.com for the warranty instructions in your country. The freight cost for the warranty is pre-paid by AOC for the delivery and return. Please ensure you provide a dated proof of purchase along with the product and deliver to the AOC Certified or Authorized Service Center under the following condition:

- Make sure the LCD Monitor is packed in a proper carton box (AOC prefers the original carton box to protect your monitor well enough during transport).
- Put the RMA number on the address label
- Put the RMA number on the shipping carton

AOC International (Europe) B.V. will pay the return shipping charges within one of the countries specified within this warranty statement. AOC International (Europe) B.V. is not responsible for any costs associated with the transportation of product across international borders. This includes the international border within the European Union. If the LCD Monitor is not available for collection when the carrier attends, you will be charged a collection fee.

*** This limited warranty does not cover any losses or damages that occur as a result of:**

- Damages during transport due to improper packaging
- Improper installation or maintenance other than in accordance with AOC's user manual
- Misuse
- Neglect
- Any cause other than ordinary commercial or industrial application
- Adjustment by non-authorized source
- Repair, modification, or installation of options or parts by anyone other than an AOC Certified or Authorized Service Center
- Improper environments like humidity, water damage and dusts
- Damaged by violence, earthquake and terrorist attacks
- Excessive or inadequate heating or air conditioning or electrical power failures, surges, or other irregularities

This limited warranty does not cover any of the product firmware or hardware that you or any third party have modified or altered; you bear the sole responsibility and liability for any such modifications or alteration.

All AOC LCD Monitors are produced according to the ISO 9241-307 Class 1 pixel policy standards.

If your warranty has expired, you still have access to all available service options, but you will be responsible for the cost of service, including parts, labor, shipping (if any) and applicable taxes. AOC Certified or Authorized Service Center will provide you with an estimate of service costs before receiving your authorization to perform service.

ALL EXPRESS AND IMPLIED WARRANTIES FOR THIS PRODUCT (INCLUDING THE WARRANTIES OF MERCHANTABILITY AND FITNESS FOR A PARTICULAR PURPOSE) ARE LIMITED IN DURATION TO A PERIOD OF THREE (3) YEARS FOR PARTS AND LABOR FROM THE ORIGINAL DATE OF CONSUMER PURCHASE. NO WARRANTIES (EITHER EXPRESSED OR IMPLIED) APPLY AFTER THIS PERIOD. AOC INTERNATIONAL (EUROPE) B.V. OBLIGATIONS AND YOUR REMEDIES HEREUNDER ARE SOLELY AND EXCLUSIVELY AS STATED HERE. AOC INTERNATIONAL (EUROPE) B.V. LIABILITY, WHETHER BASED ON CONTRACT, TORT, WARRANTY, STRICT LIABILITY, OR OTHER THEORY, SHALL NOT EXCEED THE PRICE OF THE INDIVIDUAL UNIT WHOSE DEFECT OR DAMAGE IS THE BASIS OF THE CLAIM. IN NO EVENT SHALL AOC INTERNATIONAL (EUROPE) B.V. BE LIABLE FOR ANY LOSS OF PROFITS, LOSS OF USE OR FACILITIES OR EQUIPMENT, OR OTHER INDIRECT, INCIDENTAL, OR CONSEQUENTIAL DAMAGE. SOME STATES DO NOT ALLOW THE EXCLUSION OR LIMITATION OF INCIDENTAL OR CONSEQUENTIAL DAMAGES, SO THE ABOVE LIMITATION MAY NOT APPLY TO YOU. ALTHOUGH THIS LIMITED WARRANTY GIVES YOU SPECIFIC LEGAL RIGHTS, YOU MAY HAVE OTHER RIGHTS, WHICH MAY VARY FROM COUNTRY TO COUNTRY. THIS LIMITED WARRANTY IS ONLY VALID FOR PRODUCTS PURCHASED IN THE MEMBER COUNTRIES OF THE EUROPEAN UNION.

Information in this document is subject to change without notice. For more information, please visit:

<http://www.aoc-europe.com>

Warranty Statement for Middle East and Africa (MEA)

And

The Commonwealth of Independent States (CIS)

LIMITED ONE to THREE YEARS WARRANTY*

For AOC LCD Monitors sold within the Middle East and Africa (MEA) and the Commonwealth of Independent States (CIS), AOC International (Europe) B.V. warrants this product to be free from defects in material and workmanship for a period of One (1) to Three (3) years from the manufacture date depending on sale country. During this period, AOC International (Europe) B.V. offers a Carry-In (return to Service Center) Warranty Support at an AOC's Authorized Service Center or Dealer and at its option, either repair the defective product with new or rebuilt parts, or replace it with a new or rebuilt product at no charge except as *stated below. As a Standard Policy, the warranty will be calculated from the manufacture date identified from the product ID serial number, but the total warranty will be Fifteen (15) months to Thirty Nine (39) months from MFD (manufacture date) depending on sale country. Warranty will be considered for exceptional cases that are out of warranty as per the product ID serial number and for such exceptional cases; Original Invoice/Proof Of Purchase Receipt is mandatory.

If the product appears to be defective, please contact your AOC authorized dealer or refer to the service and support section on AOC's website for the warranty instructions in your country:

- Egypt: http://aocmonitorap.com/egypt_eng
- CIS Central Asia: <http://aocmonitorap.com/ciscentral>
- Middle East: <http://aocmonitorap.com/middleeast>
- South Africa: <http://aocmonitorap.com/southafrica>
- Saudi Arabia: <http://aocmonitorap.com/saudiarabia>

Please ensure you provide a dated proof of purchase along with the product and deliver to the AOC Authorized Service Center or Dealer under the following condition:

- Make sure the LCD Monitor is packed in a proper carton box (AOC prefers the original carton box to protect your monitor well enough during transport).
- Put the RMA number on the address label
- Put the RMA number on the shipping carton

*** This limited warranty does not cover any losses or damages that occur as a result of:**

- Damages during transport due to improper packaging
- Improper installation or maintenance other than in accordance with AOC's user manual
- Misuse
- Neglect
- Any cause other than ordinary commercial or industrial application
- Adjustment by non-authorized source

- Repair, modification, or installation of options or parts by anyone other than an AOC Certified or Authorized Service Center
- Improper environments like humidity, water damage and dusts
- Damaged by violence, earthquakes and terrorist attacks
- Excessive or inadequate heating or air conditioning or electrical powers failures, surges, or other irregularities

This limited warranty does not cover any of the product firmware or hardware that you or any third party have modified or altered; you bear the sole responsibility and liability for any such modifications or alteration.

All AOC LCD Monitors are produced according to the ISO 9241-307 Class 1 pixel policy standards.

If your warranty has expired, you still have access to all available service options, but you will be responsible for the cost of service, including parts, labor, shipping (if any) and applicable taxes. AOC Certified, Authorized Service Center or dealer will provide you with an estimate of service costs before receiving your authorization to perform service.

ALL EXPRESS AND IMPLIED WARRANTIES FOR THIS PRODUCT (INCLUDING THE WARRANTIES OF MERCHANTABILITY AND FITNESS FOR A PARTICULAR PURPOSE) ARE LIMITED IN DURATION TO A PERIOD OF ONE (1) to THREE (3) YEARS FOR PARTS AND LABOR FROM THE ORIGINAL DATE OF CONSUMER PURCHASE. NO WARRANTIES (EITHER EXPRESSED OR IMPLIED) APPLY AFTER THIS PERIOD. AOC INTERNATIONAL (EUROPE) B.V. OBLIGATIONS AND YOUR REMEDIES HEREUNDER ARE SOLELY AND EXCLUSIVELY AS STATED HERE. AOC INTERNATIONAL (EUROPE) B.V. LIABILITY, WHETHER BASED ON CONTRACT, TORT, WARRANTY, STRICT LIABILITY, OR OTHER THEORY, SHALL NOT EXCEED THE PRICE OF THE INDIVIDUAL UNIT WHOSE DEFECT OR DAMAGE IS THE BASIS OF THE CLAIM. IN NO EVENT SHALL AOC INTERNATIONAL (EUROPE) B.V. BE LIABLE FOR ANY LOSS OF PROFITS, LOSS OF USE OR FACILITIES OR EQUIPMENT, OR OTHER INDIRECT, INCIDENTAL, OR CONSEQUENTIAL DAMAGE. SOME STATES DO NOT ALLOW THE EXCLUSION OR LIMITATION OF INCIDENTAL OR CONSEQUENTIAL DAMAGES, SO THE ABOVE LIMITATION MAY NOT APPLY TO YOU. ALTHOUGH THIS LIMITED WARRANTY GIVES YOU SPECIFIC LEGAL RIGHTS, YOU MAY HAVE OTHER RIGHTS, WHICH MAY VARY FROM COUNTRY TO COUNTRY. THIS LIMITED WARRANTY IS ONLY VALID FOR PRODUCTS PURCHASED IN THE MEMBER COUNTRIES OF THE EUROPEAN UNION.

Information in this document is subject to change without notice. For more information, please visit:

<http://www.aocmonitorap.com>

AOC Pixel Policy ISO 9241-307 Class 1



AOC International (Europe) B.V.
 Prins Bernhardplein 200 / 6th floor, Amsterdam, The Netherlands
 Tel: +31 (0)20 504 6962 • Fax: +31 (0)20 5046933

AOC Pixel Policy ISO 9241-307 Class 1

July 25th, 2013

AOC strives to deliver the highest quality products. We use some of the industry's most advanced manufacturing processes and practice stringent quality control. However, pixel or sub pixel defects on the TFT monitor panels used in flat panel monitors are sometimes unavoidable. No manufacturer can guarantee that all panels will be free from pixel defects, but AOC guarantees that any monitor with an unacceptable number of defects will be repaired or replaced under warranty. This Pixel Policy explains the different types of pixel defects and defines acceptable defect levels for each type. In order to qualify for repair or replacement under warranty, the number of pixel defects on a TFT monitor panel must exceed these acceptable levels.

Pixels and Sub Pixel Definition

A pixel, or picture element, is composed of three sub pixels in the primary colors of red, green and blue. When all sub pixels of pixel are lit, the three colored sub pixel together appear as a single white pixel. When all are dark, the three colored sub pixels together appear as a single black pixel.

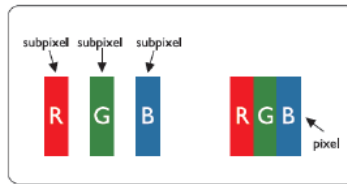

Types of Pixel Defects

- Bright Dot Defects: the monitor displays a dark pattern, sub pixels or pixels are always lit or “on”
- Black Dot Defects: the monitor displays a light pattern, sub pixels or pixels are always dark or “off”

ISO 9241-307 Pixel Defect Class	Defect Type 1 Bright Pixel	Defect Type 2 Black Pixel	Defect Type 3 Bright Sub pixel	Defect Type 4 Black Sub pixel
Class 1	1	1	2 1 0	+ + 5

AOC International (Europe) B.V.

Warranty Statement for North & South America (excluding Brazil)

WARRANTY STATEMENT

for AOC Color Monitors

Including those Sold within North America as Specified

Envision Peripherals, Inc. warrants this product to be free from defects in material and workmanship for a period of three (3) years for parts & labor and one (1) year for CRT Tube or LCD Panel after the original date of consumer purchase. During this period, EPI (EPI is the abbreviation of Envision Peripherals, Inc.) will, at its option, either repair the defective product with new or rebuilt parts, or replace it with a new or rebuilt product at no charge except as *stated below. The parts or product that are replaced become the property of EPI.

In the USA to obtain service under this limited warranty, call EPI for the name of the Authorized Service Center closest to your area. Deliver the product freight pre-paid, along with the dated proof of purchase, to the EPI Authorized Service Center. If you cannot deliver the product in person:

- Pack it in its original shipping container (or equivalent)
- Put the RMA number on the address label
- Put the RMA number on the shipping carton
- Insure it (or assume the risk of loss/damage during shipment)
- Pay all shipping charges

EPI is not responsible for damage to inbound product that was not properly packaged.

EPI will pay the return shipment charges within one of the countries specified within this warranty statement. EPI is not responsible for any costs associated with the transportation of product across international borders. This includes the international borders of the countries within this warranty statements.

In the United States and Canada contact your Dealer or EPI Customer Service, RMA Department at the toll free number (888) 662-9888. Or you can request an RMA Number online at www.aoc.com/na-warranty.

* This limited warranty does not cover any losses or damages that occur as a result of:

- Shipping or improper installation or maintenance
- Misuse
- Neglect
- Any cause other than ordinary commercial or industrial application
- Adjustment by non-authorized source
- Repair, modification, or installation of options or parts by anyone other than an EPI Authorized Service Center
- Improper environment
- Excessive or inadequate heating or air conditioning or electrical power failures, surges, or other irregularities

This three-year limited warranty does not cover any of the product's firmware or hardware that you or any third party have modified or altered; you bear the sole responsibility and liability for any such modification or alteration.

ALL EXPRESS AND IMPLIED WARRANTIES FOR THIS PRODUCT (INCLUDING THE WARRANTIES OF MERCHANTABILITY AND FITNESS FOR A PARTICULAR PURPOSE) ARE LIMITED IN DURATION TO A PERIOD OF THREE (3) YEARS FOR PARTS AND LABOR AND ONE (1) YEAR FOR CRT TUBE OR LCD PANEL FROM THE ORIGINAL DATE OF CONSUMER PURCHASE. NO WARRANTIES (EITHER EXPRESSED OR IMPLIED) APPLY AFTER THIS PERIOD. IN THE UNITED STATES OF AMERICA, SOME STATES DO NOT ALLOW LIMITATIONS ON HOW LONG AN IMPLIED WARRANTY LASTS, SO THE ABOVE LIMITATIONS MAY NOT APPLY TO YOU.

EPI OBLIGATIONS AND YOUR REMEDIES HEREUNDER ARE SOLELY AND EXCLUSIVELY AS STATED HERE. EPI' LIABILITY, WHETHER BASED ON CONTRACT, TORT, WARRANTY, STRICT LIABILITY, OR OTHER THEORY, SHALL NOT EXCEED THE PRICE OF THE INDIVIDUAL UNIT WHOSE DEFECT OR DAMAGE IS THE BASIS OF THE CLAIM. IN NO EVENT SHALL ENVISION PERIPHERALS, INC. BE LIABLE FOR ANY LOSS OF PROFITS, LOSS OF USE OR FACILITIES OR EQUIPMENT OR OTHER INDIRECT, INCIDENTAL, OR CONSEQUENTIAL DAMAGE. IN THE UNITED STATES OF AMERICA, SOME STATES DO NOT ALLOW THE EXCLUSION OR LIMITATION OF INCIDENTAL OR CONSEQUENTIAL DAMAGES. SO THE ABOVE LIMITATION MAY NOT APPLY TO YOU. ALTHOUGH THIS LIMITED WARRANTY GIVES YOU SPECIFIC LEGAL RIGHTS. YOU MAY HAVE OTHER RIGHTS WHICH MAY VARY FROM STATE TO STATE.

In the United States of America, this limited warranty is only valid for Products purchased in the Continental United States, Alaska, and Hawaii.

Outside the United States of America, this limited warranty is only valid for Products purchased in Canada.

Information in this document is subject to change without notice.

For more details, please visit:

USA: <http://us.aoc.com/support/warranty>

ARGENTINA: <http://ar.aoc.com/support/warranty>

BOLIVIA: <http://bo.aoc.com/support/warranty>

CHILE: <http://cl.aoc.com/support/warranty>

COLOMBIA: <http://co.aoc.com/warranty>

COSTA RICA: <http://cr.aoc.com/support/warranty>

DOCAN REPUBLIC: <http://do.aoc.com/support/warranty>

ECUADOR: <http://ec.aoc.com/support/warranty>

EL SALVADOR: <http://sv.aoc.com/support/warranty>

GUATEMALA: <http://gt.aoc.com/support/warranty>

HONDURAS: <http://hn.aoc.com/support/warranty>

NICARAGUA: <http://ni.aoc.com/support/warranty>

PANAMA: <http://pa.aoc.com/support/warranty>

PARAGUAY: <http://py.aoc.com/support/warranty>

PERU: <http://pe.aoc.com/support/warranty>

URUGUAY: <http://pe.aoc.com/warranty>

VENEZUELA: <http://ve.aoc.com/support/warranty>

IF COUNTRY NOT LISTED: <http://latin.aoc.com/warranty>