

AOC

AGON PRO



LCD Monitor
User Manual
AG274QXM

www.aoc.com

©2021 AOC.All Rights Reserved

HDMI™

Safety	1
National Conventions	1
Power	2
Installation	3
Cleaning	4
Other	5
Setup	6
Contents in Box	6
Setup Stand & Base	7
Adjusting the monitor	8
Connecting the Monitor	9
Wall Mounting	10
Adaptive-Sync function (Available for selective models)	11
AMD FreeSync Premium function (Available for selective models)	11
HDR	12
Adjusting	13
Hotkeys	13
Quick Switch	14
OSD Key Guide (Menu)	15
OSD Setting	17
Game Setting	18
Luminance	19
Image Setup	20
Color Setup	21
Audio	22
Light FX	23
Extra	24
OSD Setup	25
LED Indicator	26
Troubleshoot	27
Specification	28
General Specification	28
Preset Display Modes	29
Pin Assignments	30
Plug and Play	31

Safety

National Conventions

The following subsections describe notational conventions used in this document.

Notes, Cautions, and Warnings

Throughout this guide, blocks of text may be accompanied by an icon and printed in bold type or in italic type. These blocks are notes, cautions, and warnings, and they are used as follows:



NOTE: A NOTE indicates important information that helps you make better use of your computer system.



CAUTION: A CAUTION indicates either potential damage to hardware or loss of data and tells you how to avoid the problem.





WARNING: A WARNING indicates the potential for bodily harm and tells you how to avoid the problem. Some warnings may appear in alternate formats and may be unaccompanied by an icon. In such cases, the specific presentation of the warning is mandated by regulatory authority.

Power

 The monitor should be operated only from the type of power source indicated on the label. If you are not sure of the type of power supplied to your home, consult your dealer or local power company.

 The monitor is equipped with a three-pronged grounded plug, a plug with a third (grounding) pin. This plug will fit only into a grounded power outlet as a safety feature. If your outlet does not accommodate the three-wire plug, have an electrician install the correct outlet, or use an adapter to ground the appliance safely. Do not defeat the safety purpose of the grounded plug.

 Unplug the unit during a lightning storm or when it will not be used for long periods of time. This will protect the monitor from damage due to power surges.

 Do not overload power strips and extension cords. Overloading can result in fire or electric shock.

 To ensure satisfactory operation, use the monitor only with UL listed computers which have appropriate configured receptacles marked between 100-240V AC, Min. 5A.

 The wall socket shall be installed near the equipment and shall be easily accessible.

 For use only with the attached power adapter
Manufacturers: DELTA ELECTRONICS INC.
Model: ADP-330CB B

Installation

! Do not place the monitor on an unstable cart, stand, tripod, bracket, or table. If the monitor falls, it can injure a person and cause serious damage to this product. Use only a cart, stand, tripod, bracket, or table recommended by the manufacturer or sold with this product. Follow the manufacturer's instructions when installing the product and use mounting accessories recommended by the manufacturer. A product and cart combination should be moved with care.

! Never push any object into the slot on the monitor cabinet. It could damage circuit parts causing a fire or electric shock. Never spill liquids on the monitor.

! Do not place the front of the product on the floor.

! If you mount the monitor on a wall or shelf, use a mounting kit approved by the manufacturer and follow the kit instructions.

! Leave some space around the monitor as shown below. Otherwise, air-circulation may be inadequate hence overheating may cause a fire or damage to the monitor.

! To avoid potential damage, for example the panel peeling from the bezel, ensure that the monitor does not tilt downward by more than -5 degrees. If the -5 degree downward tilt angle maximum is exceeded, the monitor damage will not be covered under warranty.

See below the recommended ventilation areas around the monitor when the monitor is installed on the wall or on the stand:

Installed with stand

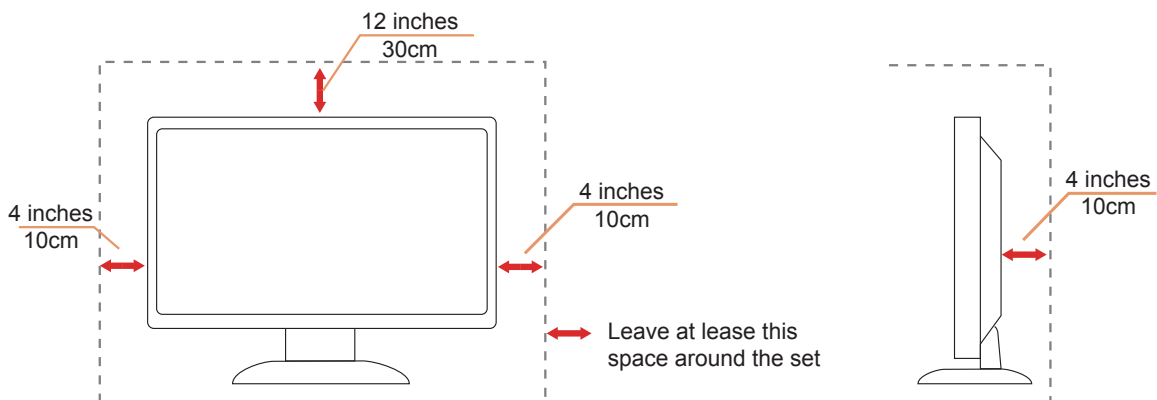

Cleaning

⚠ Clean the cabinet regularly with cloth. You can use soft-detergent to wipe out the stain, instead of strong-detergent which will cauterize the product cabinet.

⚠ When cleaning, make sure no detergent is leaked into the product. The cleaning cloth should not be too rough as it will scratch the screen surface.

⚠ Please disconnect the power cord before cleaning the product.



Other

 If the product is emitting a strange smell, sound or smoke, disconnect the power plug IMMEDIATELY and contact a Service Center.

 Make sure that the ventilating openings are not blocked by a table or curtain.

 Do not engage the LCD monitor in severe vibration or high impact conditions during operation.

 Do not knock or drop the monitor during operation or transportation.

Setup

Contents in Box

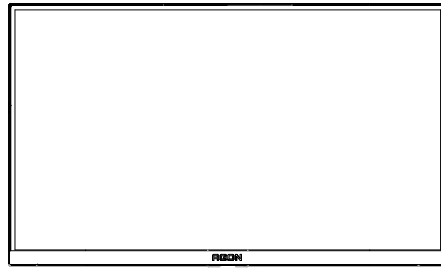

★

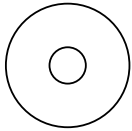

CD Manual

★

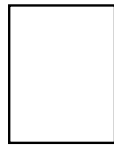

Warranty card

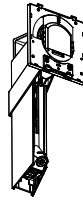

Stand



Screwdriver

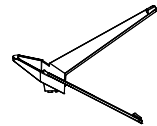

Base

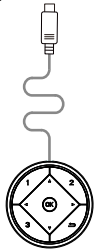

Quick Switch Keypad



Power Cable



Adaptor

★



DP Cable

★



HDMI Cable

★



USB Cable

★



Micphone Cable

★ Not all signal cables will be provided for all countries and regions. Please check with the local dealer or AOC branch office for confirmation.

Setup Stand & Base

Please setup or remove the base following the steps as below.

Setup:

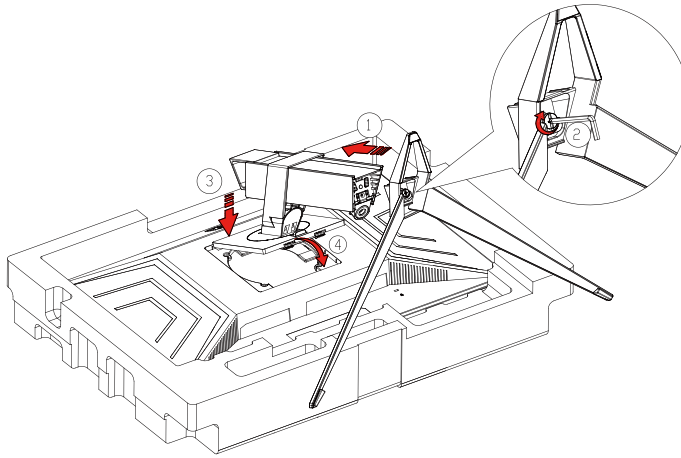

Remove:

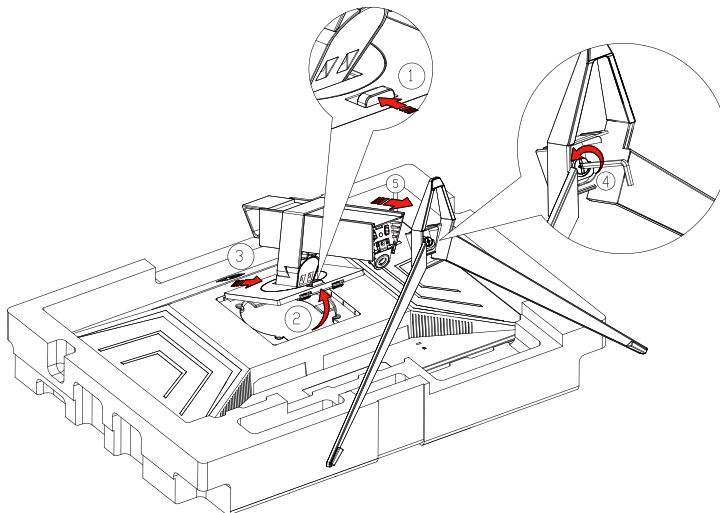

Adjusting the monitor

For optimal viewing it is recommended to look at the full face of the monitor, then adjust the monitor's angle to your own preference.

Hold the stand so you will not topple the monitor when you change the monitor's angle.

You are able to adjust the monitor as below:

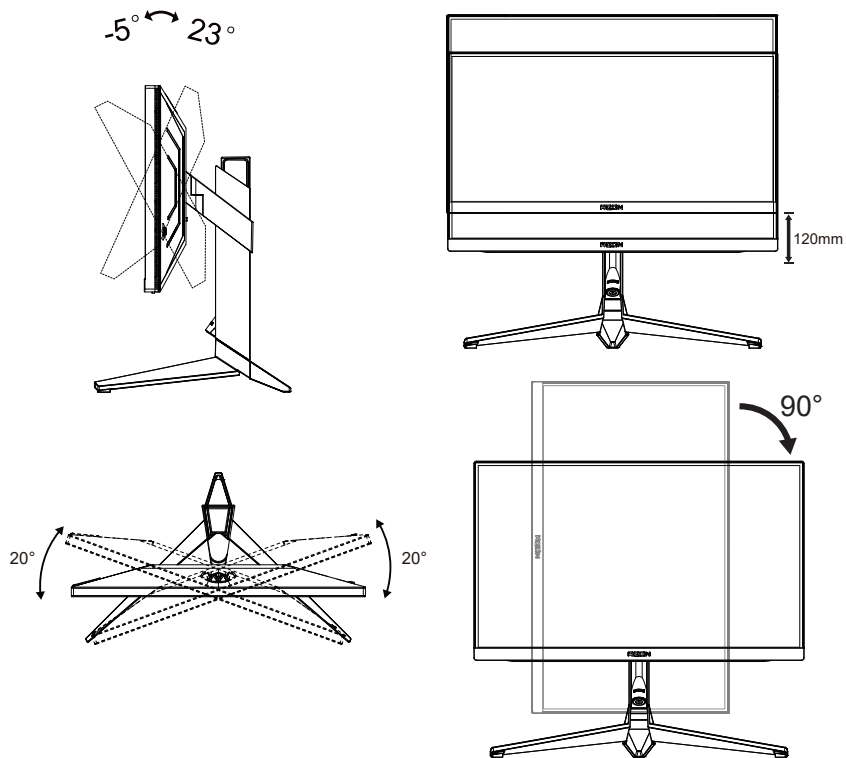

 **NOTE:**

Do not touch the LCD screen when you change the angle. It may cause damage or break the LCD screen.

Warning :

1. To avoid potential screen damage, such as panel peeling, ensure that the monitor does not tilt downward by more than -5 degrees.
2. Do not press the screen while adjusting the angle of the monitor. Grasp only the bezel.

Connecting the Monitor

Cable Connections In Back of Monitor and Computer:

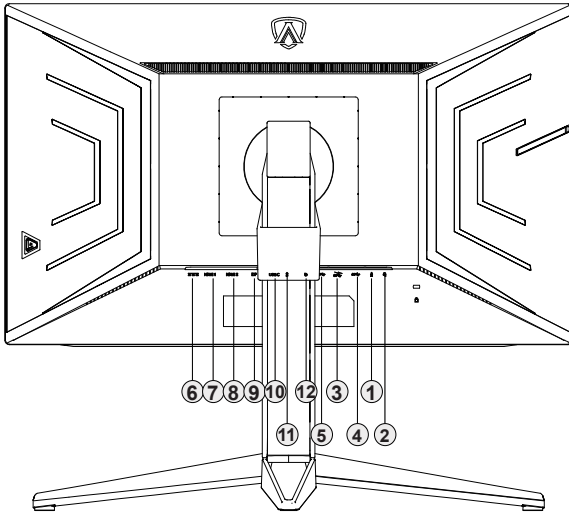

1. Microphone in
2. Earphone (Combined with Microphone)
3. USB3.2 Gen1 downstream + fast charging
4. USB3.2 Gen1 downstream
5. USB3.2 Gen1 upstream
6. Power
7. HDMI1
8. HDMI2
9. DP
10. USB C
11. Microphone out (Connect to PC)
12. Quick Switch port

Connect to PC

1. Connect the power cord to the back of the display firmly.
2. Turn off your computer and unplug its power cable.
3. Connect the display signal cable to the video connector on the back of your computer.
4. Plug the power cord of your computer and your display into a nearby outlet.
5. Turn on your computer and display.

If your monitor displays an image, installation is complete. If it does not display an image, please refer Troubleshooting.

To protect equipment, always turn off the PC and LCD monitor before connecting.

Wall Mounting

Preparing to Install An Optional Wall Mounting Arm.

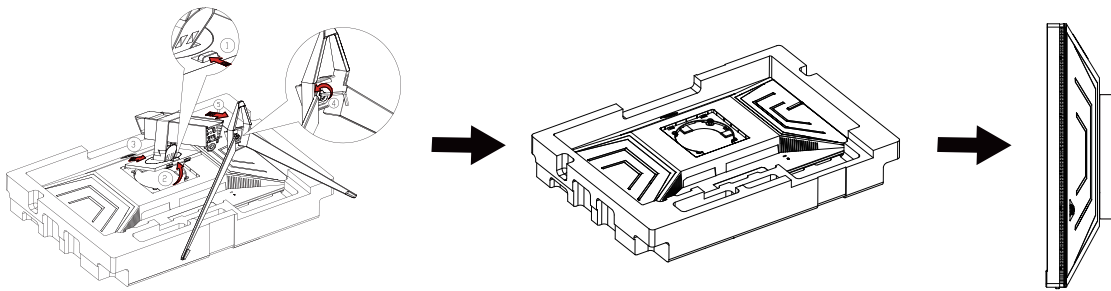

This monitor can be attached to a wall mounting arm you purchase separately. Disconnect power before this procedure. Follow these steps:

1. Remove the base.
2. Follow the manufacturer's instructions to assemble the wall mounting arm.
3. Place the wall mounting arm onto the back of the monitor. Line up the holes of the arm with the holes in the back of the monitor.
4. Reconnect the cables. Refer to the user's manual that came with the optional wall mounting arm for instructions on attaching it to the wall.

Noted: VESA mounting screw holes are not available for all models, please check with the dealer or official department of AOC.

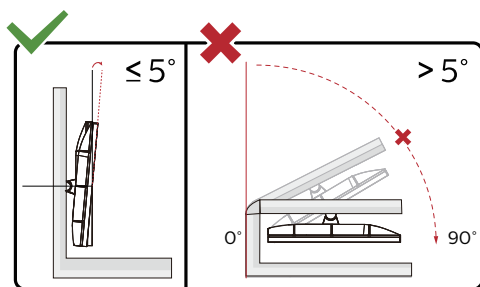

* Display design may differ from those illustrated.

Warning:

1. To avoid potential screen damage, such as panel peeling, ensure that the monitor does not tilt downward by more than -5 degrees.
2. Do not press the screen while adjusting the angle of the monitor. Grasp only the bezel.

Adaptive-Sync function (Available for selective models)

1. Adaptive-Sync function is working with DP/HDMI
2. Compatible Graphics Card: Recommend list is as the below, also could be checked by visiting www.AMD.com
 - Radeon™ RX Vega series
 - Radeon™ RX 500 series
 - Radeon™ RX 400 series
 - Radeon™ R9/R7 300 series (R9 370/X, R7 370/X, R7 265 except)
 - Radeon™ Pro Duo (2016)
 - Radeon™ R9 Nano series
 - Radeon™ R9 Fury series
 - Radeon™ R9/R7 200 series (R9 270/X, R9 280/X except)

AMD FreeSync Premium function (Available for selective models)

1. AMD FreeSync premium function is working with DP/HDMI
2. Compatible Graphics Card: Recommend list is as the below, also could be checked by visiting www.AMD.com
 - Radeon™ RX Vega series
 - Radeon™ RX 500 series
 - Radeon™ RX 400 series
 - Radeon™ R9/R7 300 series (R9 370/X, R7 370/X, R7 265 except)
 - Radeon™ Pro Duo (2016)
 - Radeon™ R9 Nano series
 - Radeon™ R9 Fury series
 - Radeon™ R9/R7 200 series (R9 270/X, R9 280/X except)

HDR

It is compatible with input signals in HDR10 format.

The display may automatically activate the HDR function if the player and content are compatible. Please contact the device manufacturer and the content provider for information on the compatibility of your device and content. Please select "OFF" for the HDR function when you have no need for automatical activation function.

Note:

1. No special setting is needed for the DisplayPort/HDMI interface in WIN10 versions lower (older) than V1703.
2. Only the HDMI interface is available and the DisplayPort interface cannot function in WIN10 version V1703.
3. 3840x2160 @50Hz /60Hz not suggestion used in PC device only for UHD player or Xbox-ones / PS4-Pro.
 - a. The display resolution is set to 2560*1440, and HDR is preset to ON. Under these conditions, the screen may slightly dim, indicating HDR has been activated.
 - b. After entering an application, the best HDR effect can be achieved when the resolution is changed to 2560*1440 (if available).

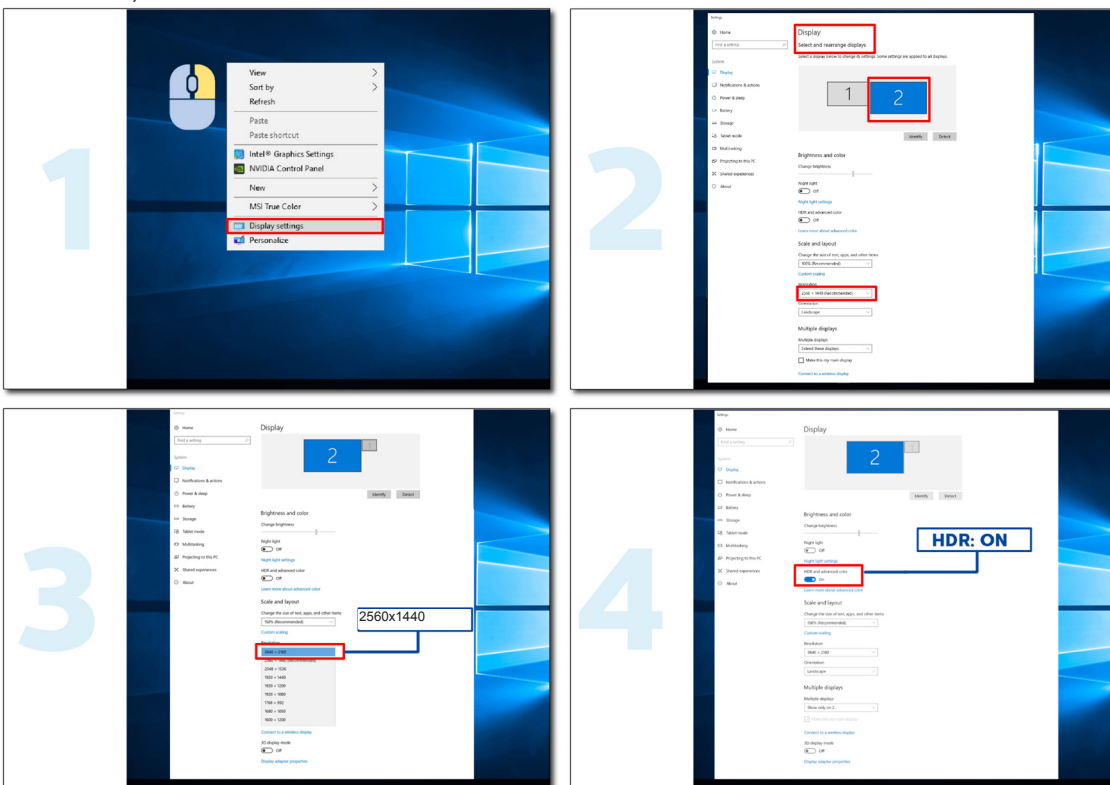

Adjusting

Hotkeys

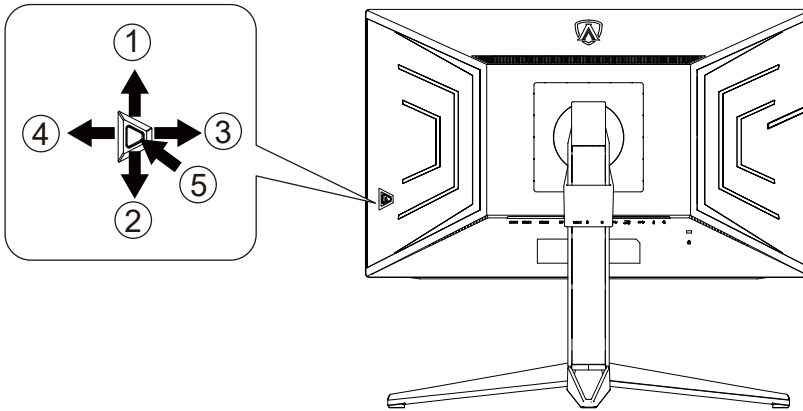

1	Source/Up
2	Dial Point/Down
3	Game Mode/Left
4	Light FX /Right
5	Power/ Menu/Enter

Power/Menu/Enter

Press the Power button to turn on the monitor.

When there is no OSD, Press to display the OSD or confirm the selection. Press about 2 seconds to turn off the monitor.

Dial Point/Down

When there is no OSD, press Dial Point button to show / hide Dial Point.

Game Mode/Left

When there is no OSD, press "Left" key to open game mode function, then press "Left" or "Right" key to select game mode (FPS, RTS, Racing, Gamer 1, Gamer 2 or Gamer 3) basing on the different game types.

Light FX/Right

When there is no OSD, press "Right" key to active Light FX function.

Source/Up

When the OSD is closed, press Source/Auto/Up button will be Source hot key function.

Quick Switch

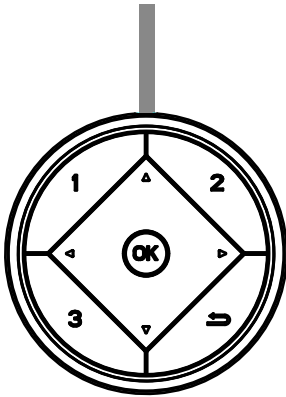

◀:

When there is no OSD, press the ◀ button to open game mode function, then press ◀ or ▶ key to select game mode (FPS, RTS, Racing, Gamer 1, Gamer 2 or Gamer 3) basing on the different game types.

▶:

When there is no OSD, press "Right" key to active Light FX function.

Menu/OK:

When there is no OSD, Press to display the OSD or confirm the selection.

▲:

When the OSD is closed, press ▲ button will be Source hot key function.

▼:

When there is no OSD, press Dial Point button to show / hide Dial Point.

1:

Press the 1 button to select Gamer 1 mode

2:

Press the 2 button to select Gamer 2 mode

3:

Press the 3 button to select Gamer 3 mode



Press to exit OSD.

OSD Key Guide (Menu)



Enter : Use Enter key to enter the next OSD level
Move : Use Left / Up / Down key to move OSD selection
Exit : Use Right key to exit OSD

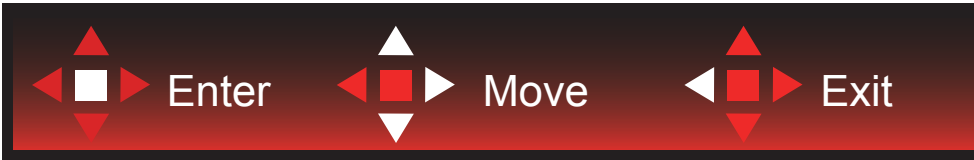

Enter : Use Enter key to enter the next OSD level
Move : Use Right / Up / Down key to move OSD selection
Exit : Use Left key to exit OSD



Enter : Use Enter key to enter the next OSD level
Move : Use Up / Down key to move OSD selection
Exit : Use Left key to exit OSD

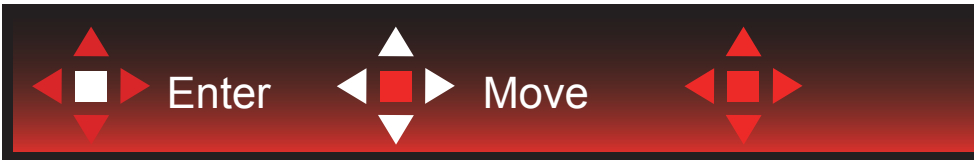

Move : Use Left / Right / Up / Down Key to move OSD selection



Exit : Use Left key to exit OSD to previous OSD level
Enter : Use Right key to enter next OSD level
Select : Use Up / Down key to move OSD selection



Enter : Use Enter key to apply the OSD setting and back to previous OSD level
Select : Use Down key to adjust OSD setting



Select : Use Up / Down key to adjust OSD setting



Enter : Use Enter key to exit OSD to previous OSD level

Select : Use Left / Right key to adjust OSD setting

OSD Setting

Basic and simple instruction on the control keys.

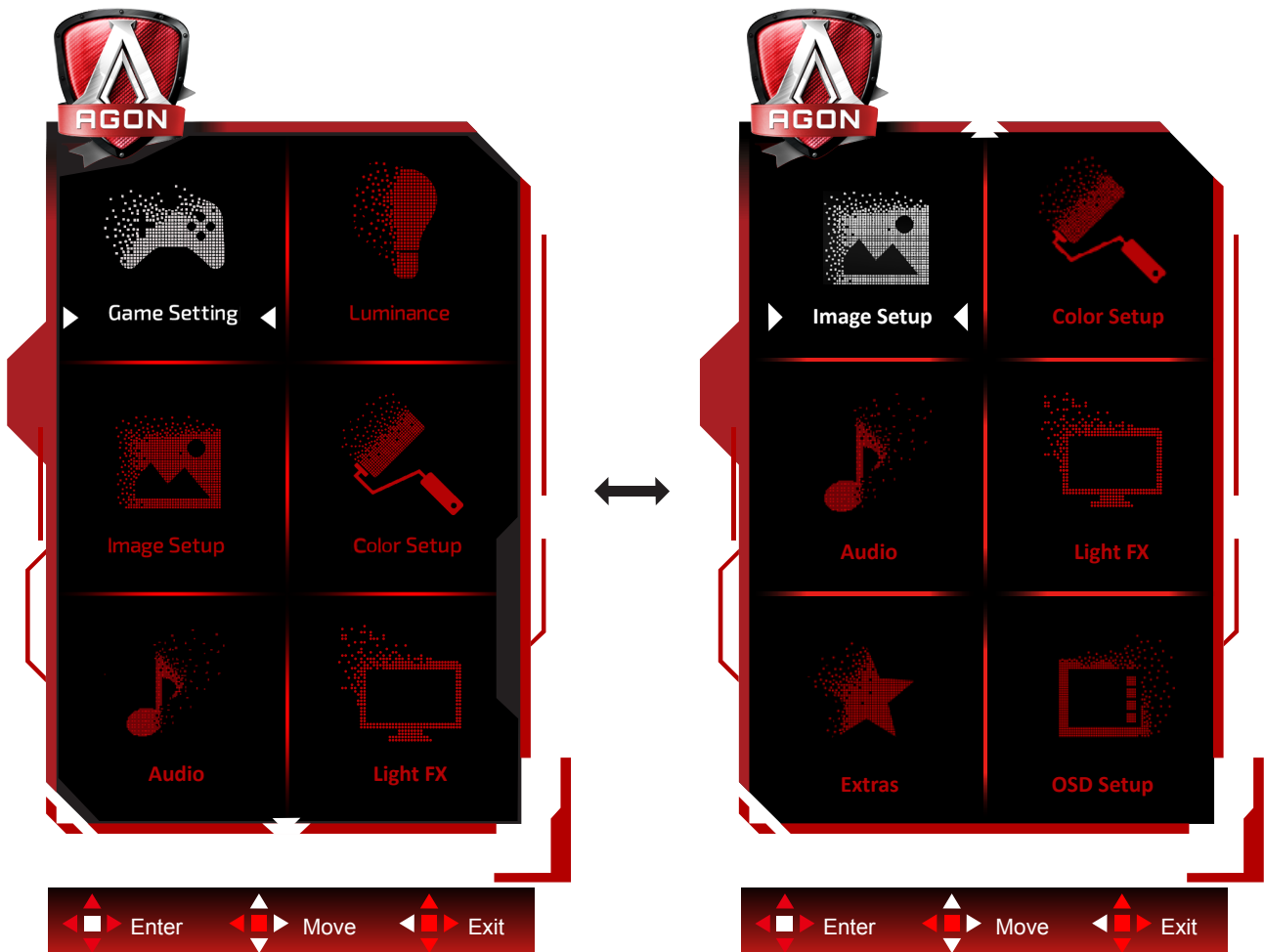

- 1). Press the MENU-button to activate the OSD window.
- 2). Follow Key Guide to move or select (adjust) OSD settings
- 3). OSD Lock/Unlock Function: To lock or unlock the OSD, press and hold the Down-button for 10s while OSD function is not active.

Notes:

- 1). If the product has only one signal input, the item of "Input Select" is disable to adjust.
- 2). ECO modes (except Standard mode), DCR and DCB mode, for these three states that only one state can exist.

Game Setting



	Game Mode	FPS	For playing FPS (first Person Shooters) games. Improves dark theme black level details.
		RTS	For playing RTS (Real Time Strategy). Improves the image quality.
		Racing	For playing Racing games, Provides fastest response time and high color saturation.
		Gamer 1	User's preference settings saved as Gamer 1.
		Gamer 2	User's preference settings saved as Gamer 2.
		Gamer 3	User's preference settings saved as Gamer 3.
		off	No optimization by Smart image game
	Shadow Control	0-100	Shadow Control Default is 50, then end-user can adjust from 50 to 100 or 0 to increase contrast for clear picture. 1. If picture is too dark to be saw the detail clearly, adjusting from 50 to 100 for clear picture. 2. If picture is too white to be saw the detail clearly, adjusting from 50 to 0 for clear picture
	Game Color	0-20	Game Color will provide 0-20 level for adjusting saturation to get better picture.
	Adaptive-Sync/ AMD FreeSync (Available for selective models)	On / Off	Disable or Enable Adaptive-Sync/AMD FreeSync Premium..
Overdrive	Weak/Medium/ Strong/Off	Adjust the response time.	
Low Input lag	On / Off	Turn off frame buffer to decrease input lag	
QuickSwitch LED	On / Off	Disable or Enable QuickSwitch LED	
Frame Counter	Off / Right-Up / Right-Down / Left- Down / Left-Up	Display V frequency on the corner selected (Frame counter feature only works with AMD graphic card.)	

Note:

1. When "HDR Mode" under "Image Setup" is set to non-off, "Game Mode", "Shadow Control" and "Game Color" can't be adjusted.

2. When “HDR” under “Image Setup” is set to non-off, “Game Mode”, “Shadow Control”, “Game Color”, “MBR” and “Boost” under “Overdrive” can’t be adjusted or selected.

Luminance

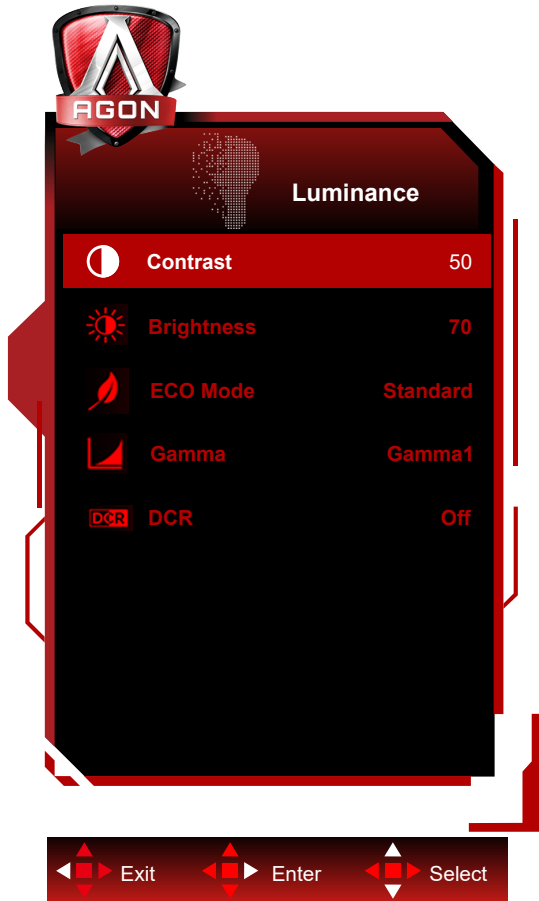

	Contrast	0-100	Contrast from Digital-register.	
	Brightness	0-100	Backlight Adjustment	
	Eco mode	Standard		Standard Mode
		Text		Text Mode
		Internet		Internet Mode
		Game		Game Mode
		Movie		Movie Mode
		Sports		Sports Mode
		Reading		Reading Mode
	Gamma	Gamma1		Adjust to Gamma 1
		Gamma2		Adjust to Gamma 2
Gamma3			Adjust to Gamma 3	
DCR	Off/On		Disable/ Enable dynamic contrast ratio	

Note:

1. When “HDR Mode” under “Image Setup” is set to non-off, “Contrast”, “Eco Mode” and “Gamma” can’t be adjusted.
2. When “HDR” under “Image Setup” is set to non-off, all items under “Luminance” can’t be adjusted.

Image Setup

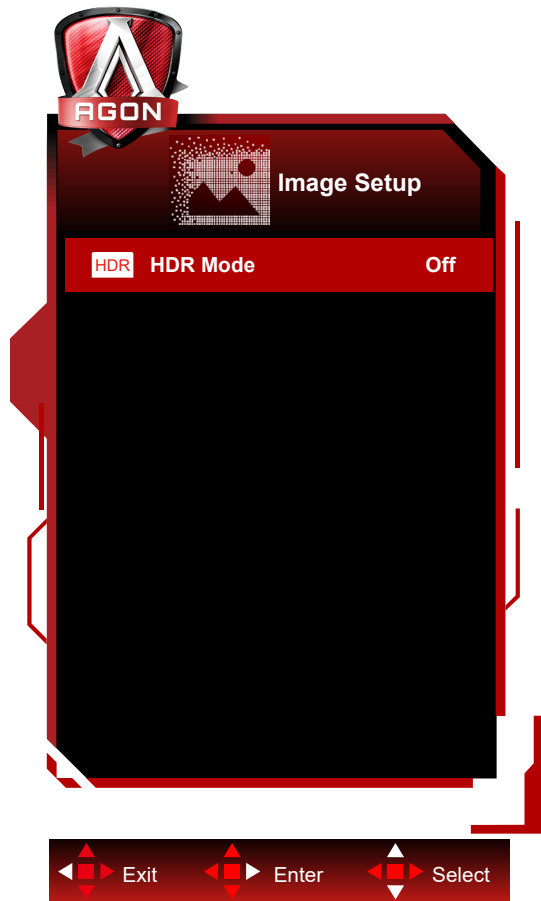

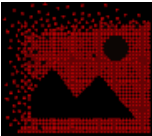
	HDR	Off / DisplayHDR / HDR Picture / HDR Movie / HDR Game	Set the HDR profile according to your usage requirements. Note: When HDR content is detected, the HDR option will be displayed for adjustment.
	HDR Mode	Off / HDR Picture / HDR Movie / HDR Game	Optimized for the color and contrast of the picture, which simulates HDR effect. Note: When HDR content is not detected, the HDR mode option will be displayed for adjustment.

Note:

When HDR is detected, the HDR option is displayed for adjustment; when HDR is not detected, the HDR Mode option is displayed for adjustment.

Color Setup



	LowBlue Mode	Off / Multimedia / Internet / Office / Reading		Decrease blue light wave by controlling color temperature.
	Color Temp.	Warm		Recall Warm Color Temperature from EEPROM.
		Normal		Recall Normal Color Temperature from EEPROM.
		Cool		Recall Cool Color Temperature from EEPROM.
		sRGB		Recall SRGB Color Temperature from EEPROM.
	User	Red		Red Gain from Digital-register
		Green		Green Gain Digital-register.
		Blue		Blue Gain from Digital-register
	DCB Mode	Full Enhance	on or off	Disable or Enable Full Enhance Mode
		Nature Skin	on or off	Disable or Enable Nature Skin Mode
		Green Field	on or off	Disable or Enable Green Field Mode
		Sky-blue	on or off	Disable or Enable Sky-blue Mode
		AutoDetect	on or off	Disable or Enable AutoDetect Mode
	DCB Demo		on or off	Disable or Enable Demo
Red		0-100	Red gain from Digital-register.	
Green		0-100	Green gain from Digital-register.	
Blue		0-100	Blue gain from Digital-register.	

Note:

When “HDR Mode” or “HDR” under “Image Setup” is set to non-off, all items under “Color Setup” can’t be adjusted.

Audio

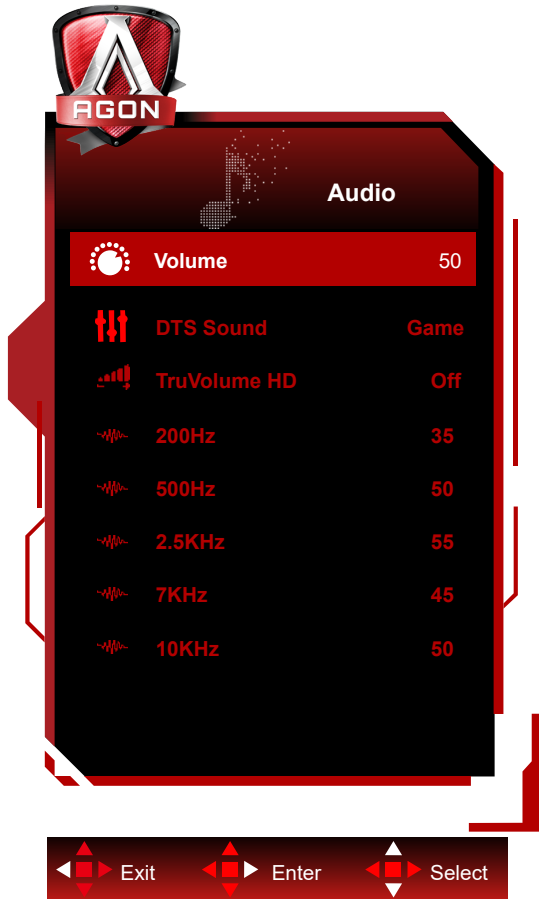

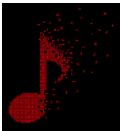
	Volume	0-100	Adjust volume setting
	DTS Sound	Game / Rock / Classical / Live / Theater / Off	Select DTS Sound mode. Note: It may take up to 2 seconds to switch modes.
	TruVolume HD	On / Off	Disable or Enable TruVolume HD.
	200Hz	0-100	Low frequency base audio, also the root audio frequency of the chord in the tone.
	500Hz	0-100	Mainly used to express vocals (eg. singing, reading), Strengthen the thickness and strength of vocals.
	2.5KHz	0-100	This frequency has a strong penetrating power and can be improved to improve the brightness and clarity of the sound.
	7KHz	0-100	Enhance the clarity of vocals.
	10KHz	0-100	The high-pitched area of music is most sensitive to the high-frequency performance of the sound.

Light FX

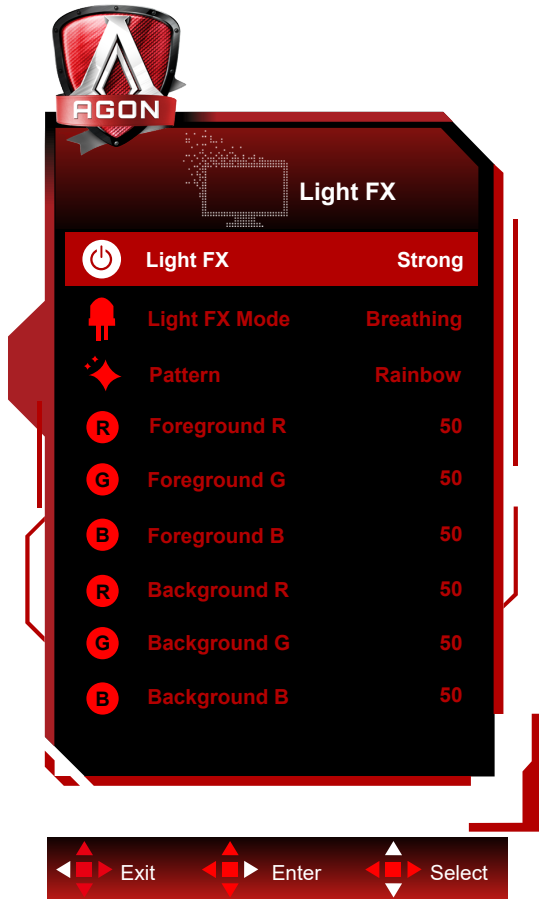

	Light FX	Off / Low / Medium / Strong	Select the intensity of Light FX.
	Light FX Mode	Audio1 / Audio2 / Static / Dark Point Sweep / Gradient Shift / Spread Fill / Drip Fill / Spreading Drip Fill / Breathing / Light Point Sweep / Zoom / Rainbow / Water Wave / Flashing / Demo	Select Light FX Mode
	Pattern	Red / Green / Blue / Rainbow / User Define	Select Light FX Pattern
	Foreground R	0-100	User can adjust Light FX foreground color, when Pattern setting to user define
	Foreground G		
	Foreground B		
	Background R	0-100	User can adjust Light FX background color, when Pattern setting to user define
	Background G		
Background B			

Extra

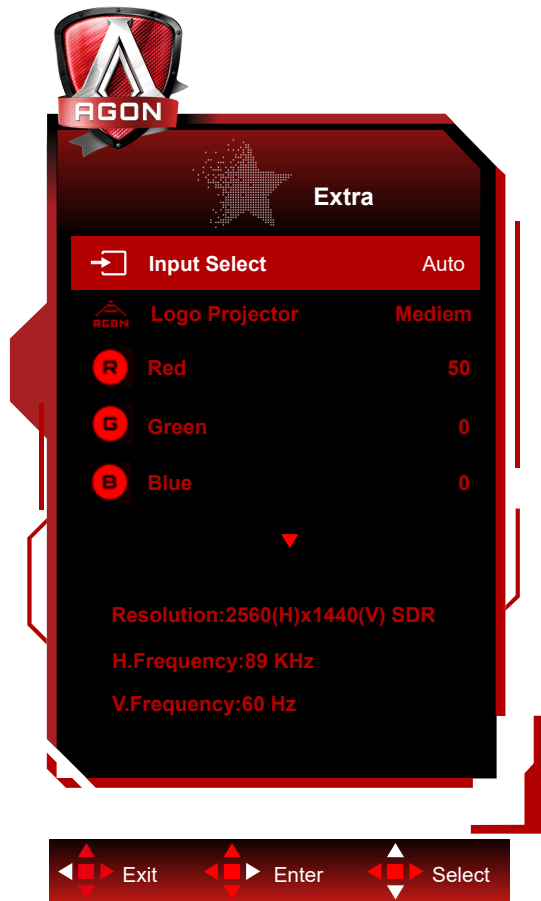

	Input Select	AUTO/HDMI1/HDMI2/DP/USB C	Select Input Signal Source
	Logo Projector	Off/Low/Medium/Strong	It's projection logo function.
	Red	0 ~ 100	Red gain from Digital-register.
	Green	0 ~ 100	Green gain from Digital-register.
	Blue	0 ~ 100	Blue gain from Digital-register.
	Off timer	0-24hrs	Select DC off time
	Image Ratio	Wide / 4:3 / 1:1 / 17"(4:3) / 19"(4:3) / 19"(5:4) / 19"W(16:10) / 21.5"W(16:9) / 22"W(16:10) / 23"W(16:9) / 23.6"W(16:9) / 24"W(16:9) / 27"W(16:9)	Select image ratio for display.
	DDC/CI	Yes or No	Turn ON/OFF DDC/CI Support
Reset	Yes or No	Reset the menu to default	

OSD Setup

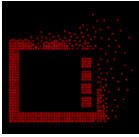

	Language		Select the OSD language
	Timeout	5-120	Adjust the OSD Timeout
	DP Capability	1.1/1.2/1.4	please be noted that only DP1.2/DP1.4 support Adaptive-Sync/AMD FreeSync Premium function
	H. Position	0-100	Adjust the horizontal position of OSD
	V. Position	0-100	Adjust the vertical position of OSD
	Transparence	0-100	Adjust the transparence of OSD
	Break Reminder	on /off	Break reminder if the user continuously work for more than 1hrs
	USB	3.2Gen1 / 2.0 / Off	Turn off the USB function or select a USB version
	USB Selection	Auto / USB C / USB up	Select the path for USB Uplink Data

Note:

If the DP video content supports DP1.2/DP1.4, please select DP1.2/DP1.4 for DP Capability; otherwise, please select DP1.1

LED Indicator

Status	LED Color
Full Power Mode	White
Active-off Mode	Orange

Troubleshoot

Problem & Question	Possible Solutions
Power LED Is Not ON	Make sure the power button is ON and the Power Cord is properly connected to a grounded power outlet and to the monitor.
No images on the screen	<ul style="list-style-type: none"> ● Is the power cord connected properly? Check the power cord connection and power supply. ● Is the cable connected correctly? (Connected using the D-SUB cable) Check the D-SUB cable connection. (Connected using the HDMI cable) Check the HDMI cable connection. (Connected using the DP cable) Check the DP cable connection. *D-SUB/HDMI/DP input is not available on every model. ● If the power is on, reboot the computer to see the initial screen (the login screen), which can be seen. If the initial screen (the login screen) appears, boot the computer in the applicable mode (the safe mode for Windows 7/8/10) and then change the frequency of the video card. (Refer to the Setting the Optimal Resolution) If the initial screen (the login screen) does not appear, contact the Service Center or your dealer. ● Can you see “Input Not Supported” on the screen? You can see this message when the signal from the video card exceeds the maximum resolution and frequency that the monitor can handle properly. Adjust the maximum resolution and frequency that the monitor can handle properly. ● Make sure the AOC Monitor Drivers are installed.
Picture Is Fuzzy & Has Ghosting Shadowing Problem	Adjust the Contrast and Brightness Controls. Press to auto adjust. Make sure you are not using an extension cable or switch box. We recommend plugging the monitor directly to the video card output connector on the back.
Picture Bounces, Flickers Or Wave Pattern Appears In The Picture	Move electrical devices that may cause electrical interference as far away from the monitor as possible. Use the maximum refresh rate your monitor is capable of at the resolution you are using.
Monitor Is Stuck In Active Off-Mode”	The Computer Power Switch should be in the ON position. The Computer Video Card should be snugly fitted in its slot. Make sure the monitor’s video cable is properly connected to the computer. Inspect the monitor’s video cable and make sure no pin is bent. Make sure your computer is operational by hitting the CAPS LOCK key on the keyboard while observing the CAPS LOCK LED. The LED should either turn ON or OFF after hitting the CAPS LOCK key.
Missing one of the primary colors (RED, GREEN, or BLUE)	Inspect the monitor’s video cable and make sure that no pin is damaged. Make sure the monitor’s video cable is properly connected to the computer.
Screen image is not centered or sized properly	Adjust H-Position and V-Position or press hot-key (AUTO).
Picture has color defects (white does not look white)	Adjust RGB color or select desired color temperature.
Horizontal or vertical disturbances on the screen	Use Windows 7/8/10 shut-down mode to adjust CLOCK and FOCUS. Press to auto-adjust.

Specification

General Specification

Panel	Model name	AG274QXM		
	Driving system	TFT Color LCD		
	Viewable Image Size	68.5 cm diagonal		
	Pixel pitch	0.2331mm(H) x 0.2331mm(V)		
	Display Color	1.07B Colors		
Others	Horizontal scan range	30~230kHz (HDMI、 USB C) 30~255kHz (DP)		
	Horizontal scan Size(Maximum)	596.736 mm		
	Vertical scan range	48~144Hz (HDMI、 USB C) 48~170Hz (DP)		
	Vertical Scan Size(Maximum)	335.664 mm		
	Optimal preset resolution	2560 x 1440@60Hz		
	Max resolution	2560 x 1440@144Hz (HDMI、 USB C) 2560 x 1440@170Hz* (DP)		
	Plug & Play	VESA DDC2B/CI		
	Power Source	19.5Vdc, 16.9A		
	Power Consumption	Typical (default brightness and contrast)	65W	
		Max. (Brightness = 100, contrast =100)	≤250W	
Standby mode		≤0.5W		
Physical Characteristics	Connector Type	HDMI/ DP/ USB/ USB C/ Earphone out/ Microphone In		
	Signal Cable Type	Detachable		
Environmental	Temperature	Operating	0°~ 40°	
		Non-Operating	-25°~ 55°	
	Humidity	Operating	10% ~ 85% (non-condensing)	
		Non-Operating	5% ~ 93% (non-condensing)	
	Altitude	Operating	0~ 5000 m (0~ 16404ft)	
		Non-Operating	0~ 12192m (0~ 40000ft)	

*Overclocking is achieved when resolution is at 2560x1440@170Hz. If any display error occurs during overclocking, please adjust the refresh rate to 165Hz.

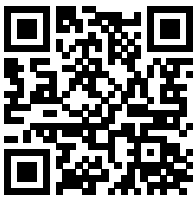

Preset Display Modes

STANDARD	RESOLUTION	HORIZONTAL FREQUENCY(kHz)	VERTICAL FREQUENCY(Hz)
VGA	640x480@60Hz	31.469	59.94
VGA	640x480@67Hz	35	66.667
VGA	640x480@72Hz	37.861	72.809
VGA	640x480@75Hz	37.5	75
VGA	640x480@100Hz	51.08	99.769
VGA	640x480@120Hz	61.91	119.518
DOS MODE	720x400@70Hz	31.469	70.087
DOS MODE	720x480@60Hz	29.855	59.710
SD	720x576@50Hz	31.25	50
SVGA	800x600@56Hz	35.156	56.25
SVGA	800x600@60Hz	37.879	60.317
SVGA	800x600@72Hz	48.077	72.188
SVGA	800x600@75Hz	46.875	75
SVGA	800x600@100Hz	63.684	99.662
SVGA	800x600@120Hz	76.302	119.97
SVGA	832x624@75Hz	49.725	74.551
XGA	1024x768@60Hz	48.363	60.004
XGA	1024x768@70Hz	56.476	70.069
XGA	1024x768@75Hz	60.023	75.029
XGA	1024x768@100Hz	81.577	99.972
XGA	1024x768@120Hz	97.551	119.989
SXGA	1280x1024@60Hz	63.981	60.02
SXGA	1280x1024@75Hz	79.975	75.025
Full HD	1920x1080@60Hz	67.5	60
Full HD	1920x1080@120Hz	135	120
QHD	2560x1440@60Hz	88.787	59.951
QHD	2560x1440@120Hz	182.996	119.998
QHD	2560x1440@144Hz	222.056	143.912
QHD (for DP)	2560x1440@165Hz	242.551	165
QHD (for DP)	2560x1440@170Hz	249.901	170.001

Pin Assignments



19-Pin Color Display Signal Cable

Pin No.	Signal Name	Pin No.	Signal Name	Pin No.	Signal Name
1.	TMDS Data 2+	9.	TMDS Data 0-	17.	DDC/CEC Ground
2.	TMDS Data 2 Shield	10.	TMDS Clock +	18.	+5V Power
3.	TMDS Data 2-	11.	TMDS Clock Shield	19.	Hot Plug Detect
4.	TMDS Data 1+	12.	TMDS Clock-		
5.	TMDS Data 1Shield	13.	CEC		
6.	TMDS Data 1-	14.	Reserved (N.C. on device)		
7.	TMDS Data 0+	15.	SCL		
8.	TMDS Data 0 Shield	16.	SDA		

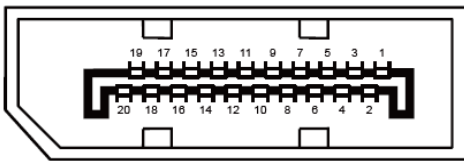

20-Pin Color Display Signal Cable

Pin No.	Signal Name	Pin No.	Signal Name
1	ML_Lane 3 (n)	11	GND
2	GND	12	ML_Lane 0 (p)
3	ML_Lane 3 (p)	13	CONFIG1
4	ML_Lane 2 (n)	14	CONFIG2
5	GND	15	AUX_CH(p)
6	ML_Lane 2 (p)	16	GND
7	ML_Lane 1 (n)	17	AUX_CH(n)
8	GND	18	Hot Plug Detect
9	ML_Lane 1 (p)	19	Return DP_PWR
10	ML_Lane 0 (n)	20	DP_PWR

Plug and Play

Plug & Play DDC2B Feature

This monitor is equipped with VESA DDC2B capabilities according to the VESA DDC STANDARD. It allows the monitor to inform the host system of its identity and, depending on the level of DDC used, communicate additional information about its display capabilities.

The DDC2B is a bi-directional data channel based on the I2C protocol. The host can request EDID information over the DDC2B channel.



For DTS patents, see <http://patents.dts.com>. Manufactured under license from DTS Licensing Limited. DTS, the Symbol, & DTS and the Symbol together are registered trademarks, and DTS Sound is a trademark of DTS, Inc. © DTS, Inc. All Rights Reserved.