



# EMC TEST REPORT

Authorized under Declaration of Conformity

According to

- |                        |                                      |
|------------------------|--------------------------------------|
| EN 55032: 2012+AC 2013 | EN 55024 : 2010                      |
| EN 61000-3-2 : 2014    | IEC 61000-4-2 : 2008                 |
| EN 61000-3-3 : 2013    | IEC 61000-4-3 : 2006+A1:2007+A2:2010 |
| CISPR 32 : 2012        | IEC 61000-4-4 : 2012                 |
| AS/NZS CISPR 32 : 2013 | IEC 61000-4-5 : 2014                 |
|                        | IEC 61000-4-6 : 2013                 |
|                        | IEC 61000-4-8 : 2009                 |
|                        | IEC 61000-4-11 : 2004                |

Applicant : TPV Electronics (Fujian) Co., Ltd.  
Address : Rongqiao Economic and Technological  
Development Zone, Fuqing City, Fujian Province,  
P.R. China  
Equipment : LCD Monitor  
250LM00005,\*\*251\*\*\*\*\*  
Model No. : (The “\*” could be any alphanumeric character  
including blank for marketing differentiation.)

## I HEREBY CERTIFY THAT :

The sample was received on Sep 10, 2016 and the testing was carried out on Sep 19 2016 at CerpPASS Technology Corp. The test result refers exclusively to the test presented test model / sample. Without written approval of CerpPASS Technology Corp., the test report shall not be reproduced except in full.



# EMC TEST REPORT

Issued by:

**CerpPASS Technology (Suzhou) Co.,Ltd**

**No.66,Tangzhuang Road, Suzhou Industrial Park, Jiangsu 215006, China**

**Tel:86-512-6917-5888**

**Fax:86-512-6917-5666**

The test record, data evaluation & Equipment Under Test configurations represented herein are true and accurate accounts of the measurements of the samples EMC characteristics under the conditions specified in this report.

The above equipment was tested by CerpPASS Technology Corp. for compliance with the requirements of technical standards specified above under the EMC Directive. The results of testing in this report apply only to the product/system, which was tested. Other similar equipment will not necessarily produce the same results due to production tolerance and measurement uncertainties

Approved by:

Miro Chueh  
EMC/RF B.U. Manager

### Laboratory Accreditation:

CerpPASS Technology Corporation Test Laboratory

<b>NVLAP LAB Code:</b>	<b>200954-0</b>
<b>TAF LAB Code:</b>	<b>1439</b>

CerpPASS Technology(SuZhou) Co., Ltd.

<b>NVLAP LAB Code:</b>	<b>200814-0</b>
<b>CNAS LAB Code:</b>	<b>L5515</b>



## Contents

<b>1. Summary of Test Procedure and Test Results.....</b>	<b>6</b>
<b>2. Immunity Testing Performance Criteria Definition .....</b>	<b>7</b>
<b>3. Test Configuration of Equipment under Test .....</b>	<b>8</b>
3.1. Feature of Equipment under Test.....	8
3.2. Test Manner .....	9
3.3. Description of Support Unit .....	12
3.4. General Information of Test.....	13
3.5. Measurement Uncertainty .....	14
<b>4. Test of Conducted Emission.....</b>	<b>16</b>
4.1. Test Limit .....	16
4.2. Test Procedures .....	19
4.3. Typical Test Setup .....	19
4.4. Measurement Equipment.....	20
4.5. Test Result and Data.....	21
4.6. Test Photographs of Power Port .....	42
<b>5. Test of Radiated Emission .....</b>	<b>43</b>
5.1. Test Limit.....	43
5.2. Test Procedures .....	46
5.3. Typical Test Setup .....	46
5.4. Measurement Equipment.....	47
5.5. Test Result and Data (30MHz ~ 1GHz).....	48
5.6. Test Result and Data (1GHz ~ 6GHz).....	68
5.7. Test Photographs (30MHz~1GHz).....	88
5.8. Test Photographs (1GHz~6GHz) .....	89
<b>6. Harmonics Test .....</b>	<b>90</b>
6.1. Limits of Harmonics Current Measurement .....	90
6.2. Measurement Equipment.....	91
6.3. Test Result and Data.....	92
6.4. Test Photographs .....	94
<b>7. Voltage Fluctuations Test .....</b>	<b>95</b>
7.1. Test Procedure .....	95
7.2. Measurement Equipment.....	95
7.3. Test Result and Data.....	96
7.4. Test Photographs .....	98
<b>8. Electrostatic Discharge Immunity Test.....</b>	<b>99</b>
8.1. Test Procedure .....	99
8.2. Test Setup for Tests Performed in Laboratory.....	100
8.3. Test Severity Levels .....	101
8.4. Measurement Equipment.....	101
8.5. Test Result and Data.....	102
8.6. Test Photographs .....	103
<b>9. Radio Frequency electromagnetic field immunity test .....</b>	<b>104</b>



- 9.1. Test Procedure ..... 104
- 9.2. Test Severity Levels ..... 104
- 9.3. TEST SETUP ..... 105
- 9.4. Measurement Equipment..... 106
- 9.5. Test Result and Data..... 107
- 9.6. Test Photographs ..... 108
- 10. Electrical Fast Transient/ Burst Immunity Test..... 109**
  - 10.1. Test Procedure ..... 109
  - 10.2. Test Severity Levels ..... 109
  - 10.3. TEST SETUP ..... 110
  - 10.4. Measurement Equipment..... 110
  - 10.5. Test Result and Data..... 111
  - 10.6. Test Photographs ..... 112
- 11. Surge Immunity Test..... 113**
  - 11.1. Test Procedure ..... 113
  - 11.2. Test Severity Level ..... 113
  - 11.3. TEST SETUP ..... 114
  - 11.4. Measurement Equipment..... 114
  - 11.5. Test Result and Data..... 115
  - 11.6. Test Photographs ..... 116
- 12. Conduction Disturbances induced by Radio-Frequency Fields ..... 117**
  - 12.1. Test Procedure ..... 117
  - 12.2. Test Severity Levels ..... 117
  - 12.3. TEST SETUP ..... 118
  - 12.4. Measurement Equipment..... 118
  - 12.5. Test Result and Data..... 119
  - 12.6. Test Photographs ..... 120
- 13. Power Frequency Magnetic Field Immunity Test..... 121**
  - 13.1. Test Setup ..... 121
  - 13.2. Test Severity Levels ..... 121
  - 13.3. Measurement Equipment..... 121
  - 13.4. Test Result and Data..... 122
  - 13.5. Test Photographs ..... 123
- 14. Voltage Dips and Voltage Interruptions Immunity Test Setup ..... 124**
  - 14.1. Test Conditions..... 124
  - 14.2. TEST SETUP ..... 124
  - 14.3. Measurement Equipment..... 124
  - 14.4. Test Result and Data..... 125
  - 14.5. Test Photographs ..... 126
- 15. Photographs of EUT ..... 127**



### History of this test report

ORIGINAL.

Additional attachment as following record:

Report No	Version	Date	Description
SECE1609030	Rev 01	Sep 22, 2016	Initial Issue



## 1. Summary of Test Procedure and Test Results

EMISSION [EN55032 ]			
Standard	Item	Result	Remarks
EN55032: 2012+AC 2013 AS/NZS CISPR 32 : 2013 CISPR 32 : 2012	Conducted (Power Port)	PASS	Meet Class B Limit Minimum passing margin(AV) is -12.77 dB at 1.8740MHz
	Conducted (Telecom port)	N/A	N/A
	Radiated	PASS	Meets Class B Limit Minimum passing margin(Peak) is -4.01dB at 162.8899MHz
EN 61000-3-2: 2014	Harmonic current emissions	PASS	Meet Class D Limit
EN61000-3-3:2013	Voltage fluctuations & flicker	PASS	Meets the requirements

IMMUNITY [EN 55024:2010]			
Standard	Item	Result	Remarks
IEC 61000-4-2: 2008	ESD	PASS	Meets the requirements of Performance Criterion A
IEC 61000-4-3: 2006+A1:2007+A2:2010	RS	PASS	Meets the requirements of Performance Criterion A
IEC 61000-4-4: 2012	EFT	PASS	Meets the requirements of Performance Criterion A
IEC 61000-4-5:2014	Surge	PASS	Meets the requirements of Performance Criterion A
IEC 61000-4-6:2013	CS	PASS	Meets the requirements of Performance Criterion A
IEC 61000-4-8:2009	PFMF	PASS	Meets the requirements of Performance Criterion A
IEC 61000-4-11:2004	Voltage dips & voltage variations	PASS	Meets the requirements of Voltage Dips: 1) >95% reduction Performance Criterion B 2) 30% reduction Performance Criterion B  Voltage Interruptions: 1) >95% reduction Performance Criterion C



## 2. Immunity Testing Performance Criteria Definition

<b>Criteria A:</b>	The apparatus shall continue to operate as intended without operator intervention. No degradation of performance or loss of function is allowed below a performance level specified by the manufacturer, when the apparatus is used as intended. The performance level may be replaced by a permissible loss of performance. If the manufacturer does not specify the minimum performance level or the permissible performance loss, then either of these may be derived from the product description and documentation, and by what the user may reasonably expect from the equipment if used as intended.
<b>Criteria B:</b>	After test, the apparatus shall continue to operate as intended without operator intervention. No degradation of performance or loss of function is allowed, after the application of the phenomenon below a performance level specified by the manufacturer, when the apparatus is used as intended. The performance level may be replaced by a permissible loss of performance.  During the test, degradation of performance is however allowed. However, no change of operating state if stored data is allowed to persist after the test. If the manufacturer does not specify the minimum performance level or the permissible performance loss, then either of these may be derived from the product description and documentation, and by what the user may reasonably expect from the equipment if used as intended.
<b>Criteria C:</b>	Temporary loss of function is allowed, provided the functions is self-recoverable or can be restored by the operation of controls by the user in accordance with the manufacturer instructions.  Functions, and/or information stored in non-volatile memory, or protected by a battery backup, shall not be lost.



### 3. Test Configuration of Equipment under Test

#### 3.1. Feature of Equipment under Test

<b>Product Name:</b>	LCD Monitor	
<b>Model Name:</b>	250LM00005,**251***** (The "*" could be any alphanumeric character including blank for marketing differentiation.)	
<b>Housing material:</b>	Plastic case	
<b>EUT Highest Frequency:</b>	571MHz	
<b>Adapter:</b>	Model No.:	ADPC2090
	Input Rating:	100-240V~ 1.3A 50-60Hz
	Output Rating:	20V  4.5A
<b>AC Power Cord Type:</b>	Non-shielded, 1.2m&1.5m&1.8m	

Note: Please refer to user manual.

#### I/O PORT:

I/O PORT TYPE	Quantity
1). VGA Port	1
2). DVI Port	1
3). HDMI Port	2
4). Display Port	1
5). Audio Port	4
6). USB Port	6
7). DC Power Port	1





### 3.2. Test Manner

- a. During testing, the interface cables and equipment positions were varied according to Europe Standard EN55032 Class B.
- b. An executive program, “MyHwin” under Win 7, which generates a complete line of continuously repeating “H” pattern was used as the test software.

The program was executed as follows:

- 1. Turn on the power of all equipment.
- 2. The EUT reads the test program from the hard disk drive and runs it.
- 3. PC sends “H” messages to the EUT, and the monitor displays “H” patterns on the screen.
- 4. Repeat the steps from 2 to 3.

- c. The complete test system included PC, USB Keyboard, USB Mouse, Earphone, DVD, HDD and EUT for EMI&EMS test.

- d. The test modes for CE/RE as follow

- Test Mode 1 Full system (VGA mode 1920\*1080@240Hz) for Horizontal (110V/60Hz)
- Test Mode 2 Full system (VGA mode 1280\*1024@75Hz) for Horizontal (110V/60Hz)
- Test Mode 3 Full system (VGA mode 640\*480@60Hz) for Horizontal (110V/60Hz)
- Test Mode 4 Full system (VGA mode 1920\*1080@240Hz) for Vertical (110V/60Hz)
- Test Mode 5 Full system (Display mode 1920\*1080@240Hz) for Horizontal (110V/60Hz)
- Test Mode 6 Full system (Display mode 1280\*1024@75Hz) for Horizontal (110V/60Hz)
- Test Mode 7 Full system (Display mode 640\*480@60Hz) for Horizontal (110V/60Hz)
- Test Mode 8 Full system (Display mode 1920\*1080@240Hz) for Vertical (110V/60Hz)
- Test Mode 9 Full system (DVI mode 1920\*1080@240Hz) for Horizontal (110V/60Hz)
- Test Mode 10 Full system (DVI mode 1280\*1024@75Hz) for Horizontal (110V/60Hz)
- Test Mode 11 Full system (DVI mode 640\*480@60Hz) for Horizontal (110V/60Hz)
- Test Mode 12 Full system (DVI mode 1920\*1080@240Hz) for Vertical (110V/60Hz)
- Test Mode 13 Full system (HDMI 1 mode 1920\*1080@240Hz) for Horizontal (110V/60Hz)
- Test Mode 14 Full system (HDMI 1 mode 1280\*1024@75Hz) for Horizontal (110V/60Hz)
- Test Mode 15 Full system (HDMI 1 mode 640\*480@60Hz) for Horizontal (110V/60Hz)
- Test Mode 16 Full system (HDMI 1 mode 1920\*1080@240Hz)for Vertical (110V/60Hz)
- Test Mode 17 Full system (HDMI 2 mode 1920\*1080@240Hz) for Horizontal (110V/60Hz)
- Test Mode 18 Full system (HDMI 2 mode 1280\*1024@75Hz) for Horizontal (110V/60Hz)
- Test Mode 19 Full system (HDMI 2 mode 640\*480@60Hz) for Horizontal (110V/60Hz)
- Test Mode 20 Full system (HDMI 2-MHL mode 1920\*1080@60Hz) for Horizontal (110V/60Hz)
- Test Mode 21 Full system (HDMI 2 mode 1920\*1080@240Hz) for Vertical (110V/60Hz)
- Test Mode 22 Full system (1080P from DVD mode) for Horizontal (110V/60Hz)



- Test Mode 23 Full system (VGA mode 1920\*1080@240Hz) for Horizontal (230V/50Hz)
- Test Mode 24 Full system (VGA mode 1280\*1024@75Hz) for Horizontal (230V/50Hz)
- Test Mode 25 Full system (VGA mode 640\*480@60Hz) for Horizontal (230V/50Hz)
- Test Mode 26 Full system (VGA mode 1920\*1080@240Hz) for Vertical (230V/50Hz)
- Test Mode 27 Full system (Display mode 1920\*1080@240Hz) for Horizontal (230V/50Hz)
- Test Mode 28 Full system (Display mode 1280\*1024@75Hz) for Horizontal (230V/50Hz)
- Test Mode 29 Full system (Display mode 640\*480@60Hz) for Horizontal (230V/50Hz)
- Test Mode 30 Full system (Display mode 1920\*1080@240Hz) for Vertical (230V/50Hz)
- Test Mode 31 Full system (DVI mode 1920\*1080@240Hz) for Horizontal (230V/50Hz)
- Test Mode 32 Full system (DVI mode 1280\*1024@75Hz) for Horizontal (230V/50Hz)
- Test Mode 33 Full system (DVI mode 640\*480@60Hz) for Horizontal (230V/50Hz)
- Test Mode 34 Full system (DVI mode 1920\*1080@240Hz) for Vertical (230V/50Hz)
- Test Mode 35 Full system (HDMI 1 mode 1920\*1080@240Hz) for Horizontal (230V/50Hz)
- Test Mode 36 Full system (HDMI 1 mode 1280\*1024@75Hz) for Horizontal (230V/50Hz)
- Test Mode 37 Full system (HDMI 1 mode 640\*480@60Hz) for Horizontal (230V/50Hz)
- Test Mode 38 Full system (HDMI 1 mode 1920\*1080@240Hz)for Vertical (230V/50Hz)
- Test Mode 39 Full system (HDMI 2 mode 1920\*1080@240Hz) for Horizontal (230V/50Hz)
- Test Mode 40 Full system (HDMI 2 mode 1280\*1024@75Hz) for Horizontal (230V/50Hz)
- Test Mode 41 Full system (HDMI 2 mode 640\*480@60Hz) for Horizontal (230V/50Hz)
- Test Mode 42 Full system (HDMI 2-MHL mode 1920\*1080@60Hz) for Horizontal (230V/50Hz)
- Test Mode 43 Full system (HDMI 2 mode 1920\*1080@240Hz) for Vertical (230V/50Hz)
- Test Mode 44 Full system (1080P from DVD mode) for Horizontal (230V/50Hz)

“Test mode 1,5,9,13,17, 23, 27, 31, 35, 39” were reported as final data.

e. The test modes for H&F/EMS as follow

- Test Mode 1 Full system (VGA mode 1920\*1080@240Hz) for Horizontal
- Test Mode 2 Full system (VGA mode 1280\*1024@75Hz) for Horizontal
- Test Mode 3 Full system (VGA mode 640\*480@60Hz) for Horizontal
- Test Mode 4 Full system (VGA mode 1920\*1080@240Hz) for Vertical
- Test Mode 5 Full system (Display mode 1920\*1080@240Hz) for Horizontal
- Test Mode 6 Full system (Display mode 1280\*1024@75Hz) for Horizontal
- Test Mode 7 Full system (Display mode 640\*480@60Hz) for Horizontal
- Test Mode 8 Full system (Display mode 1920\*1080@240Hz) for Vertical
- Test Mode 9 Full system (DVI mode 1920\*1080@240Hz) for Horizontal
- Test Mode 10 Full system (DVI mode 1280\*1024@75Hz) for Horizontal



- Test Mode 11 Full system (DVI mode 640\*480@60Hz) for Horizontal
- Test Mode 12 Full system (DVI mode 1920\*1080@240Hz) for Vertical
- Test Mode 13 Full system (HDMI 1 mode 1920\*1080@240Hz) for Horizontal
- Test Mode 14 Full system (HDMI 1 mode 1280\*1024@75Hz) for Horizontal
- Test Mode 15 Full system (HDMI 1 mode 640\*480@60Hz) for Horizontal
- Test Mode 16 Full system (HDMI 1 mode 1920\*1080@240Hz)for Vertical
- Test Mode 17 Full system (HDMI 2 mode 1920\*1080@240Hz) for Horizontal
- Test Mode 18 Full system (HDMI 2 mode 1280\*1024@75Hz) for Horizontal
- Test Mode 19 Full system (HDMI 2 mode 640\*480@60Hz) for Horizontal
- Test Mode 20 Full system (HDMI 2-MHL mode 1920\*1080@60Hz) for Horizontal
- Test Mode 21 Full system (HDMI 2 mode 1920\*1080@240Hz) for Vertical
- Test Mode 22 Full system (1080P from DVD mode) for Horizontal

“Test mode 1,5,9,13,17” were reported as final data.

- f. The maximum operating frequency is above 108MHz, the test frequency range is from 1GHz to 6GHz.



### 3.3. Description of Support Unit

No.	Device	Manufacturer	Model No.	Description
1	PC1	HP	HP Compaq Elite 8200 MTPC	Non-Shielded ,1.8m(R33001)
2	USB Keyboard	DELL	SK-8115	T3A002
3	USB Mouse	DELL	G0K02XYK	R41108
4	Earphone	EDIFIER	N/A	N/A
5	Earphone	EDIFIER	N/A	N/A
6	DVD	PIONEER	DV-600AV-S	N/A
7	HDD	WD	WDBPCK5000ABK-01	N/A
8	HDD	WD	WDBPCK5000ABK-02	N/A
9	HDD	WD	WDBPCK5000ABK-03	N/A
10	HDD	WD	WDBPCK5000ABK-04	N/A

No.	Cable	Quantity	Description
A	HDMI Cable	1	Shielded, 1.2m&1.5m&1.8m
B	Display Cable	1	Shielded, 1.2m&1.5m&1.8m
C	DVI Cable	1	Shielded, 1.2m&1.5m&1.8m, with two ferrite core bonded
D	VGA Cable	1	Shielded, 1.2m&1.5m&1.8m, with two ferrite core bonded
E	USB Cable	1	Shielded, 1.8m
F	HDMI Cable	1	Shielded, 1.2m&1.5m&1.8m
G	USB Cable	1	Shielded, 0.8m
H	USB Cable	1	No-Shielded, 0.6m
I	USB Cable	1	No-Shielded, 0.6m
J	USB Cable	1	No-Shielded, 0.6m
K	Audio Cable	1	No-Shielded, 1.8m
L	Audio Cable	1	No-Shielded, 1.8m
M	USB Cable	1	No-Shielded, 0.6m
N	USB Cable	1	Shielded, 1.5m,
O	USB Cable	1	Shielded, 1.8m, with one ferrite core bonded

**3.4. General Information of Test**

<input type="checkbox"/>	Test Site	<b>Cerpass Technology Corporation Test Laboratory</b> Address: No.10, Ln. 2, Lianfu St., Luzhu Dist., Taoyuan City 33848, Taiwan (R.O.C.) Tel:+886-3-3226-888 Fax:+886-3-3226-881 Address: No.68-1, Shihbachongsi, Shihding Township, New Taipei City 223, Taiwan, R.O.C. Tel: +886-2-2663-8582
	FCC	TW1079, TW1061,390316, 228391, 641184
	IC	4934B-1, 4934E-1, 4934E-2
	VCCI	T-2205 for Telecommunication Test C-4663 for Conducted emission test R-3428, R-4218 for Radiated emission test G-812, G-813 for radiated disturbance above 1GHz
<input checked="" type="checkbox"/>	Test Site	<b>Cerpass Technology (Suzhou) Co.,Ltd</b> Address: No.66,Tangzhuang Road, Suzhou Industrial Park, Jiangsu 215006, China Tel: +86-512-6917-5888 Fax: +86-512-6917-5666
	FCC	331395
	IC	7290A-1, 7290A-2
	VCCI	T-1945 for Telecommunication Test C-2919 for Conducted emission test R-2670 for Radiated emission test G-227 for radiated disturbance above 1GHz
Frequency Range Investigated:		Conducted: from 150kHz to 30 MHz Radiation: from 30 MHz to 6000MHz
Test Distance :		The test distance of radiated emission below 1GHz from antenna to EUT is 10 M. The test distance of radiated emission above 1GHz from antenna to EUT is 3 M.



### 3.5. Measurement Uncertainty

Where relevant, the following measurement uncertainty levels have been estimated for tests performed on the EUT as specified in CISPR 16-4-2:

Measurement	Frequency	Uncertainty
Conducted emissions(LINE)	9KHz-30MHz	+/- 0.7738 dB
Conducted emissions(NEUTRAL)	9KHz-30MHz	+/- 0.7886 dB

Measurement	Polarity	Frequency	Uncertainty
Radiated emissions (below 1GHz)	H	30MHz ~ 200MHz	+/- 3.8909dB
		200MHz ~1000MHz	+/- 3.6555dB
	V	30MHz ~ 200MHz	+/- 3.8948dB
		200MHz ~1000MHz	+/- 3.6538dB
Radiated emissions (above 1GHz)	H	1000MHz ~18000MHz	+/- 3.8948 dB
		18000MHz ~40000MHz	+/-3.8844dB
	V	1000MHz ~18000MHz	+/- 3.8906dB
		18000MHz ~40000MHz	+/- 3.8744dB

Measurement	Uncertainty
ESD—Rise time tr	10%
ESD—Peak current Ip	6%
ESD—Current at 30 ns	6%
ESD—Current at 60 ns	6%
ESD- Charging voltage	1%
RS above 1GHz	±2.37dB
RS under 1GHz	±3.83dB
EFT—Rise time tr	4%
EFT—Peak current Ip	4%
EFT—Current	4%
Surge—Rise time tr	4%
Surge—Peak current Ip	4%



Surge—Current	4%
CS-CND	±0.80dB
CS-Clamp	±1.06dB

This uncertainty represents an expanded uncertainty expressed at approximately the 95% confidence level using a coverage factor of k=2.

Consistent with industry standard (e.g. CISPR 22: 2008, clause 11, Measurement Uncertainty) determining compliance with the limits shall be base on the results of the compliance measurement. Consequently the measure emissions being less than the maximum allowed emission result in this be a compliant test or passing test.



## 4. Test of Conducted Emission

### 4.1. Test Limit

Conducted Emissions were measured from 150 kHz to 30 MHz with a bandwidth of 9 kHz and return leads of the EUT according to the methods defined in European Standard EN 55032.

**Table A.8 – Requirements for conducted emissions from the AC mains power ports of Class A equipment**

Applicable to				
1. AC mains power ports (3.1.1)				
Table clause	Frequency range MHz	Coupling device (see Table A.7)	Detector type / bandwidth	Class A limits dB( $\mu$ V)
A8.1	0,15 – 0,5	AMN	Quasi Peak / 9 kHz	79
	0,5 – 30			73
A8.2	0,15 – 0,5	AMN	Average / 9 kHz	66
	0,5 – 30			60

NOTE Apply A8.1 and A8.2 across the entire frequency range.

**Table A.9 – Requirements for conducted emissions from the AC mains power ports of Class B equipment**

Applicable to				
1. AC mains power ports (3.1.1)				
Table clause	Frequency range MHz	Coupling device (see Table A.7)	Detector type / bandwidth	Class B limits dB( $\mu$ V)
A9.1	0,15 – 0,5	AMN	Quasi Peak / 9 kHz	66 – 56
	0,5 – 5			56
	5 – 30			60
A9.2	0,15 – 0,5	AMN	Average / 9 kHz	56 – 46
	0,5 – 5			46
	5 – 30			50

NOTE Apply A9.1 and A9.2 across the entire frequency range.





**Table A.10 – Requirements for asymmetric mode conducted emissions from Class A equipment**

<b>Applicable to</b>					
1. wired network ports (3.1.30) 2. optical fibre ports (3.1.24) with metallic shield or tension members 3. antenna ports (3.1.3)					
<b>Table clause</b>	<b>Frequency range MHz</b>	<b>Coupling device (see Table A.7)</b>	<b>Detector type / bandwidth</b>	<b>Class A voltage limits dB(μV)</b>	<b>Class A current limits dB(μA)</b>
A10.1	0,15 – 0,5	AAN	Quasi Peak / 9 kHz	97 – 87	n/a
	0,5 – 30			87	
	0,15 – 0,5	AAN	Average / 9 kHz	84 – 74	
	0,5 – 30			74	
A10.2	0,15 – 0,5	CVP and current probe	Quasi Peak / 9 kHz	97 – 87	53 – 43
	0,5 – 30			87	43
	0,15 – 0,5	CVP and current probe	Average / 9 kHz	84 – 74	40 – 30
	0,5 – 30			74	30
A10.3	0,15 – 0,5	Current Probe	Quasi Peak / 9 kHz	n/a	53 – 43
	0,5 – 30				43
	0,15 – 0,5	Current Probe	Average / 9 kHz		40 – 30
	0,5 – 30				30
NOTE 1 The choice of coupling device and measurement procedure is defined in Annex C.					
NOTE 2 AC mains power ports shall meet the limits given in Table A.8.					
NOTE 3 The test shall cover the entire frequency range.					
NOTE 4 The application of the voltage and/or current limits is dependent on the measurement procedure used. Refer to Table C.1 for applicability.					
NOTE 5 Testing is required at only one EUT supply voltage and frequency.					
NOTE 6 Applicable to ports listed above and intended to connect to cables longer than 3 m.					



**Table A.11 – Requirements for asymmetric mode conducted emissions from Class B equipment**

<b>Applicable to</b>					
1. wired network ports (3.1.30) 2. optical fibre ports (3.1.24) with metallic shield or tension members 3. broadcast receiver tuner ports (3.1.8) 4. antenna ports (3.1.3)					
<b>Table clause</b>	<b>Frequency range MHz</b>	<b>Coupling device (see Table A.7)</b>	<b>Detector type / bandwidth</b>	<b>Class B voltage limits dB(μV)</b>	<b>Class B current limits dB(μA)</b>
A11.1	0,15 – 0,5	AAN	Quasi Peak / 9 kHz	84 – 74	n/a
	0,5 – 30			74	
	0,15 – 0,5	AAN	Average / 9 kHz	74 – 64	
	0,5 – 30			64	
A11.2	0,15 – 0,5	CVP and current probe	Quasi Peak / 9 kHz	84 – 74	40 – 30
	0,5 – 30			74	30
	0,15 – 0,5	CVP and current probe	Average / 9 kHz	74 – 64	30 – 20
	0,5 – 30			64	20
A11.3	0,15 – 0,5	Current Probe	Quasi Peak / 9 kHz	n/a	40 – 30
	0,5 – 30				30
	0,15 – 0,5	Current Probe	Average / 9 kHz		30 – 20
	0,5 – 30				20
NOTE 1 The choice of coupling device and measurement procedure is defined in Annex C. NOTE 2 Screened ports including TV broadcast receiver tuner ports are tested with a common-mode impedance of 150 Ω. This is typically accomplished with the screen terminated by 150 Ω to earth. NOTE 3 AC mains power ports shall meet the limits given in Table A.9. NOTE 4 The test shall cover the entire frequency range. NOTE 5 The application of the voltage and/or current limits is dependent on the measurement procedure used. Refer to Table C.1 for applicability. NOTE 6 Testing is required at only one EUT supply voltage and frequency. NOTE 7 Applicable to ports listed above and intended to connect to cables longer than 3 m.					

## 4.2. Test Procedures

- The EUT was placed on a desk 0.8 meters height from the metal ground plane and 0.4 meter from the conducting wall of the shielding room and it was kept at least 0.8 meters from any other grounded conducting surface.
- Connect EUT to the power mains through a line impedance stabilization network (LISN).
- All the support units are connecting to the other LISN.
- The LISN provides 50 ohm coupling impedance for the measuring instrument.
- The CISPR states that a 50 ohm, 50 micro-Henry LISN should be used.
- Both sides of AC line were checked for maximum conducted interference.
- The frequency range from 150 kHz to 30 MHz was searched
- Set the test-receiver system to Peak Detect Function and Specified Bandwidth with Maximum Hold Mode.

## 4.3. Typical Test Setup

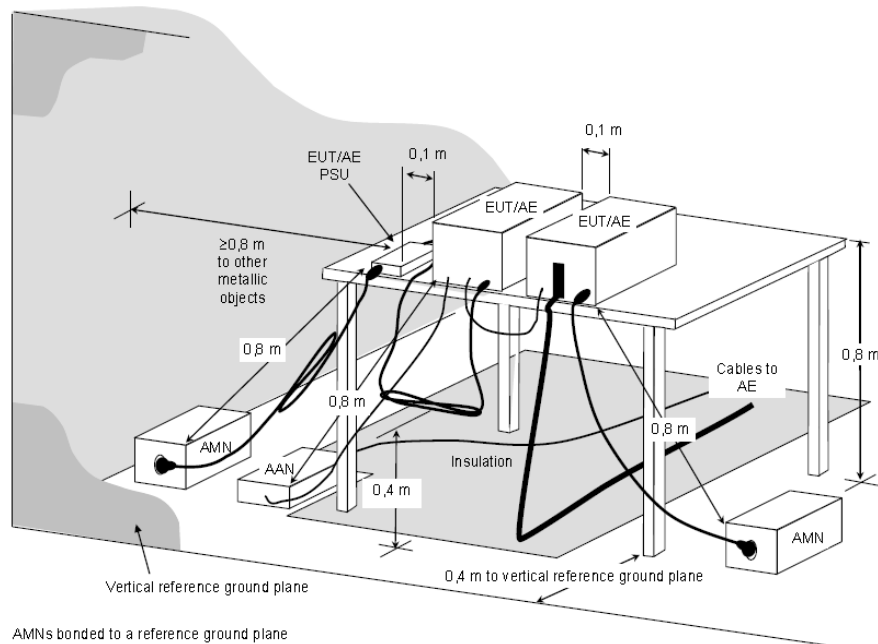

NOTE The 0,8 m distance specified between EUT/AE/PSU and AMN/AAN, is applicable only to the EUT being measured. If the device is AE then it shall be  $\geq 0,8$  m.

**Figure D.2 – Example measurement arrangement for table-top EUT  
(Conducted emission measurement – alternative 1)**



#### 4.4. Measurement Equipment

Instrument/Ancillary	Manufacturer	Model No.	Serial No.	Calibration Date	Valid Date.
Test Receiver	R&S	ESCI	100565	2016.07.07	2017.07.06
AMN	R&S	ESH2-Z5	100182	2016.08.31	2017.08.30
Two-Line V-Network	R&S	ENV216	100325	/	/
ISN	FCC	FCC-TLISN-T2-02	20379	2016.03.26	2017.03.25
ISN	FCC	FCC-TLISN-T4-02	20380	2016.06.24	2017.06.24
ISN	FCC	FCC-TLISN-T8-02	20381	2016.03.26	2017.03.25
ISN	TESEQ	ISN ST08	30175	2016.03.26	2017.03.25
Current Probe	R&S	EZ-17	100303	2016.03.26	2017.03.25
Passive Voltage Probe	R&S	ESH2-Z3	100026	2016.03.26	2017.03.25
Pulse Limiter	R&S	ESH3-Z2	100529	2016.03.26	2017.03.25
Temperature/ Humidity Meter	Zhicheng	ZC1-11	CEP-TH-004	2016.03.29	2017.03.28
EZ-EMC	Fala	Ver CT3A1	N/A	N/A	N/A



### 4.5. Test Result and Data

#### 4.5.1 Conducted Emission for Power Port Test Data

Test Mode :	Mode 1: Full system (VGA mode 1920*1080@240Hz) for Horizontal (110V/60Hz)		
AC Power :	AC 110V/60Hz	Phase :	LINE
Equipment :	LCD Monitor	Model No :	250LM00005
Temperature :	26°C	Humidity :	53%
Pressure(mbar) :	1001	Date:	2016/09/14

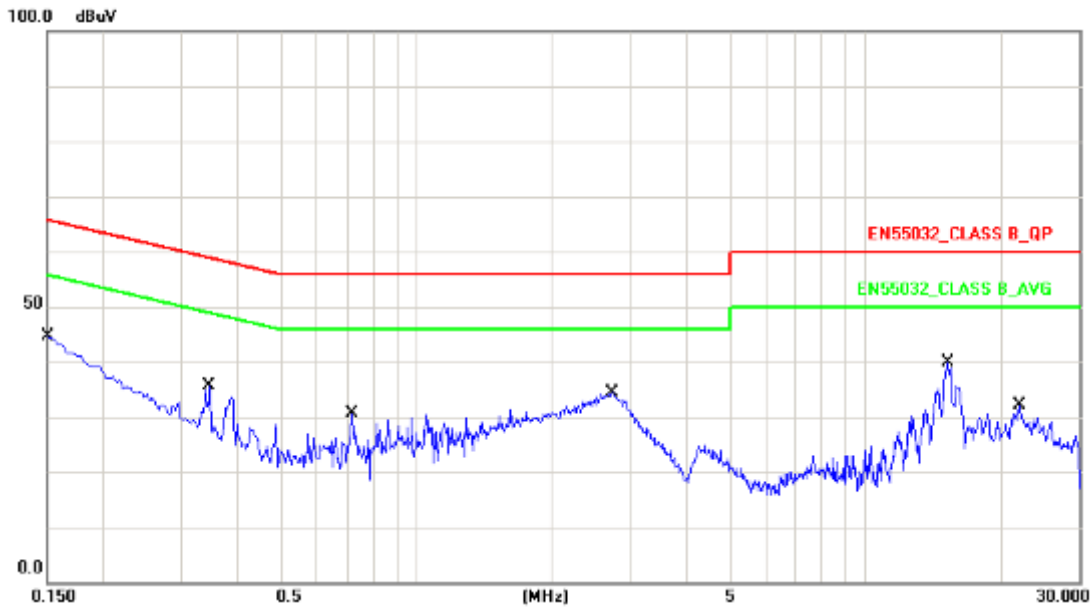

No.	Frequency (MHz)	Factor (dB)	Reading (dBuV)	Level (dBuV)	Limit (dBuV)	Margin (dB)	Detector
1	0.1500	10.13	27.41	37.54	65.99	-28.45	QP
2	0.1500	10.13	4.64	14.77	55.99	-41.22	AVG
3	0.3460	10.14	18.77	28.91	59.06	-30.15	QP
4	0.3460	10.14	6.82	16.96	49.06	-32.10	AVG
5	0.7180	10.15	14.75	24.90	56.00	-31.10	QP
6	0.7180	10.15	5.64	15.79	46.00	-30.21	AVG
7	2.7300	10.18	21.32	31.50	56.00	-24.50	QP
8	2.7300	10.18	11.81	21.99	46.00	-24.01	AVG
9	15.3580	10.51	27.76	38.27	60.00	-21.73	QP
10	15.3580	10.51	22.10	32.61	50.00	-17.39	AVG
11	22.0740	10.37	15.54	25.91	60.00	-34.09	QP
12	22.0740	10.37	10.75	21.12	50.00	-28.88	AVG

Note: Measurement Level = Reading Level + Correct Factor



Test Mode :	Mode 1: Full system (VGA mode 1920*1080@240Hz) for Horizontal (110V/60Hz)		
AC Power :	AC 110V/60Hz	Phase :	NEUTRAL
Equipment :	LCD Monitor	Model No :	250LM00005
Temperature :	26°C	Humidity :	53%
Pressure(mbar) :	1001	Date:	2016/09/14

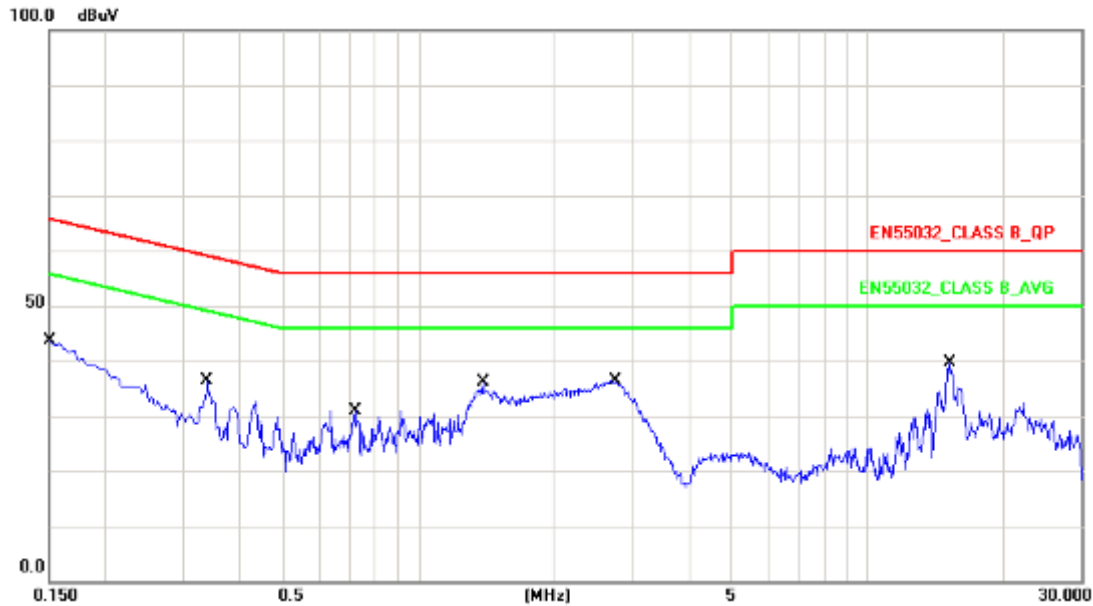

No.	Frequency (MHz)	Factor (dB)	Reading (dBuV)	Level (dBuV)	Limit (dBuV)	Margin (dB)	Detector
1	0.1500	10.13	27.24	37.37	65.99	-28.62	QP
2	0.1500	10.13	6.90	17.03	55.99	-38.96	AVG
3	0.3379	10.14	22.18	32.32	59.25	-26.93	QP
4	0.3379	10.14	17.40	27.54	49.25	-21.71	AVG
5	0.7220	10.16	16.20	26.36	56.00	-29.64	QP
6	0.7220	10.16	7.11	17.27	46.00	-28.73	AVG
7	1.3940	10.18	22.17	32.35	56.00	-23.65	QP
8	1.3940	10.18	11.21	21.39	46.00	-24.61	AVG
9	2.7540	10.20	23.91	34.11	56.00	-21.89	QP
10	2.7540	10.20	11.71	21.91	46.00	-24.09	AVG
11	15.3580	10.52	27.67	38.19	60.00	-21.81	QP
12	15.3580	10.52	22.06	32.58	50.00	-17.42	AVG

Note: Measurement Level = Reading Level + Correct Factor



Test Mode :	Mode 5: Full system (Display mode 1920*1080@240Hz) for Horizontal (110V/60Hz)		
AC Power :	AC 110V/60Hz	Phase :	LINE
Equipment :	LCD Monitor	Model No :	250LM00005
Temperature :	26°C	Humidity :	53%
Pressure(mbar) :	1001	Date:	2016/09/14

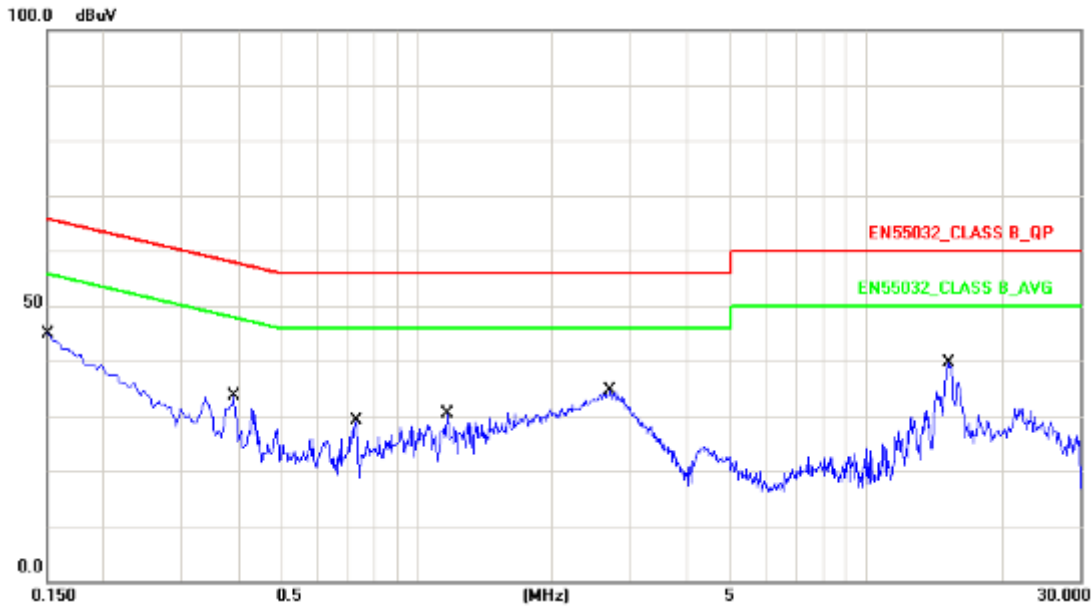

No.	Frequency (MHz)	Factor (dB)	Reading (dBuV)	Level (dBuV)	Limit (dBuV)	Margin (dB)	Detector
1	0.1516	10.13	27.45	37.58	65.91	-28.33	QP
2	0.1516	10.13	3.35	13.48	55.91	-42.43	AVG
3	0.3899	10.15	18.14	28.29	58.06	-29.77	QP
4	0.3899	10.15	10.26	20.41	48.06	-27.65	AVG
5	0.7340	10.15	14.20	24.35	56.00	-31.65	QP
6	0.7340	10.15	3.02	13.17	46.00	-32.83	AVG
7	1.1660	10.16	12.45	22.61	56.00	-33.39	QP
8	1.1660	10.16	4.05	14.21	46.00	-31.79	AVG
9	2.7060	10.18	22.09	32.27	56.00	-23.73	QP
10	2.7060	10.18	9.79	19.97	46.00	-26.03	AVG
11	15.3580	10.51	27.56	38.07	60.00	-21.93	QP
12	15.3580	10.51	22.04	32.55	50.00	-17.45	AVG

Note: Measurement Level = Reading Level + Correct Factor



Test Mode :	Mode 5: Full system (Display mode 1920*1080@240Hz) for Horizontal (110V/60Hz)		
AC Power :	AC 110V/60Hz	Phase :	NEUTRAL
Equipment :	LCD Monitor	Model No :	250LM00005
Temperature :	26°C	Humidity :	53%
Pressure(mbar) :	1001	Date:	2016/09/14

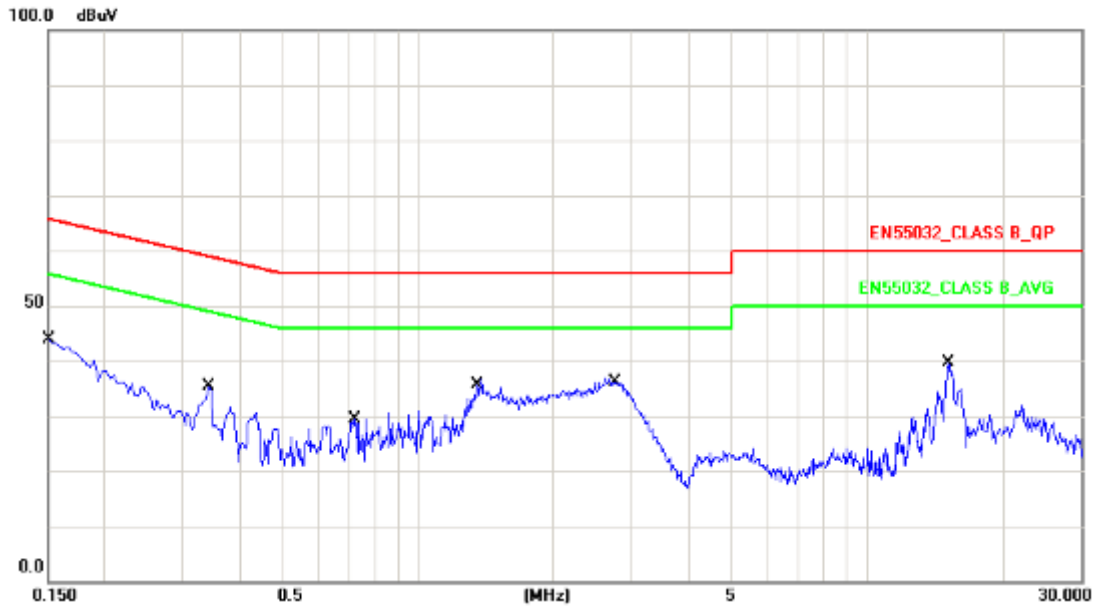

No.	Frequency (MHz)	Factor (dB)	Reading (dBuV)	Level (dBuV)	Limit (dBuV)	Margin (dB)	Detector
1	0.1524	10.13	27.40	37.53	65.86	-28.33	QP
2	0.1524	10.13	4.48	14.61	55.86	-41.25	AVG
3	0.3420	10.14	22.08	32.22	59.15	-26.93	QP
4	0.3420	10.14	13.58	23.72	49.15	-25.43	AVG
5	0.7220	10.16	15.09	25.25	56.00	-30.75	QP
6	0.7220	10.16	4.28	14.44	46.00	-31.56	AVG
7	1.3540	10.18	21.39	31.57	56.00	-24.43	QP
8	1.3540	10.18	11.19	21.37	46.00	-24.63	AVG
9	2.7380	10.19	23.49	33.68	56.00	-22.32	QP
10	2.7380	10.19	12.64	22.83	46.00	-23.17	AVG
11	15.2260	10.52	27.84	38.36	60.00	-21.64	QP
12	15.2260	10.52	22.00	32.52	50.00	-17.48	AVG

Note: Measurement Level = Reading Level + Correct Factor





Test Mode :	Mode 9: Full system (DVI mode 1920*1080@240Hz) for Horizontal (110V/60Hz)		
AC Power :	AC 110V/60Hz	Phase :	LINE
Equipment :	LCD Monitor	Model No :	250LM00005
Temperature :	26°C	Humidity :	53%
Pressure(mbar) :	1001	Date:	2016/09/14

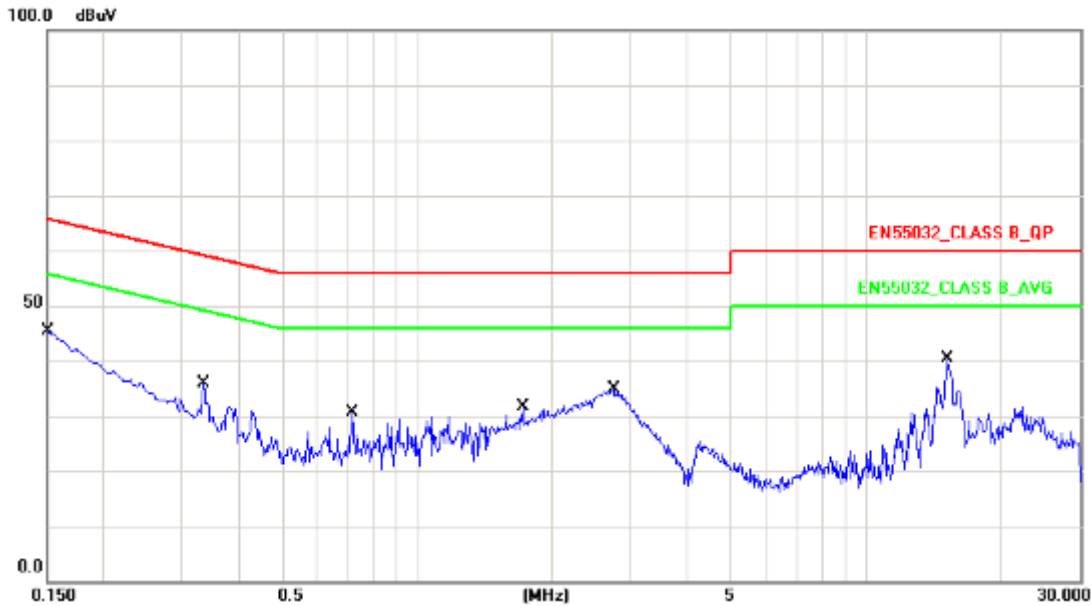

No.	Frequency (MHz)	Factor (dB)	Reading (dBuV)	Level (dBuV)	Limit (dBuV)	Margin (dB)	Detector
1	0.1500	10.13	28.23	38.36	65.99	-27.63	QP
2	0.1500	10.13	5.00	15.13	55.99	-40.86	AVG
3	0.3339	10.14	20.13	30.27	59.35	-29.08	QP
4	0.3339	10.14	15.53	25.67	49.35	-23.68	AVG
5	0.7180	10.15	13.21	23.36	56.00	-32.64	QP
6	0.7180	10.15	3.93	14.08	46.00	-31.92	AVG
7	1.7180	10.17	16.70	26.87	56.00	-29.13	QP
8	1.7180	10.17	6.34	16.51	46.00	-29.49	AVG
9	2.7420	10.18	21.07	31.25	56.00	-24.75	QP
10	2.7420	10.18	9.33	19.51	46.00	-26.49	AVG
11	15.2260	10.52	27.54	38.06	60.00	-21.94	QP
12	15.2260	10.52	21.96	32.48	50.00	-17.52	AVG

Note: Measurement Level = Reading Level + Correct Factor



Test Mode :	Mode 9: Full system (DVI mode 1920*1080@240Hz) for Horizontal (110V/60Hz)		
AC Power :	AC 110V/60Hz	Phase :	NEUTRAL
Equipment :	LCD Monitor	Model No :	250LM00005
Temperature :	26°C	Humidity :	53%
Pressure(mbar) :	1001	Date:	2016/09/14

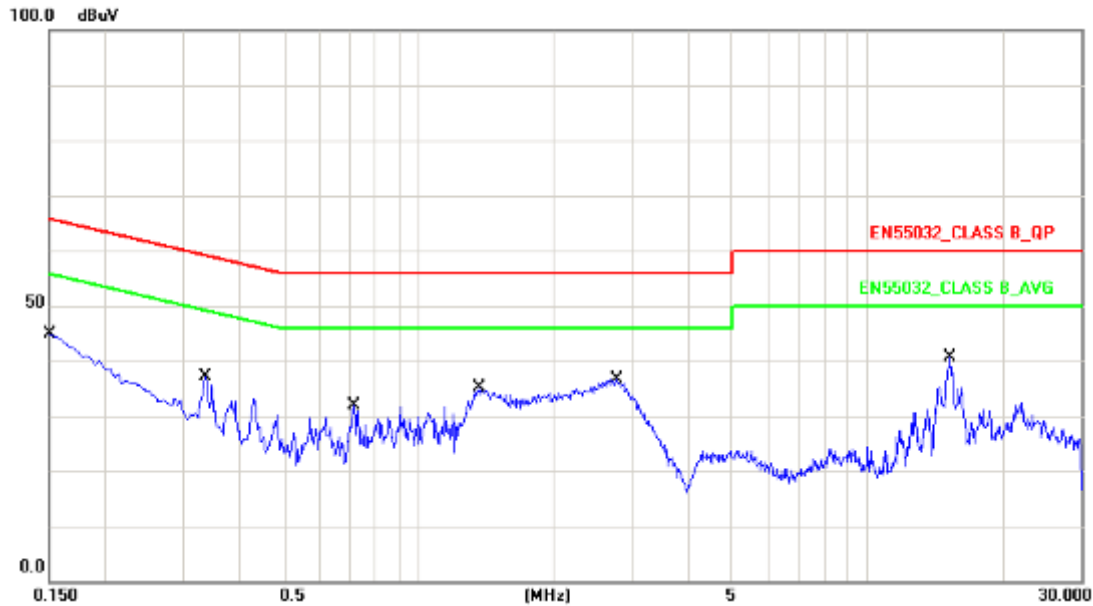

No.	Frequency (MHz)	Factor (dB)	Reading (dBuV)	Level (dBuV)	Limit (dBuV)	Margin (dB)	Detector
1	0.1500	10.13	28.22	38.35	65.99	-27.64	QP
2	0.1500	10.13	6.70	16.83	55.99	-39.16	AVG
3	0.3339	10.14	22.35	32.49	59.35	-26.86	QP
4	0.3339	10.14	17.35	27.49	49.35	-21.86	AVG
5	0.7180	10.16	16.29	26.45	56.00	-29.55	QP
6	0.7180	10.16	5.95	16.11	46.00	-29.89	AVG
7	1.3619	10.18	22.36	32.54	56.00	-23.46	QP
8	1.3619	10.18	15.39	25.57	46.00	-20.43	AVG
9	2.7740	10.20	23.03	33.23	56.00	-22.77	QP
10	2.7740	10.20	13.83	24.03	46.00	-21.97	AVG
11	15.3580	10.52	27.49	38.01	60.00	-21.99	QP
12	15.3580	10.52	21.81	32.33	50.00	-17.67	AVG

Note: Measurement Level = Reading Level + Correct Factor



Test Mode :	Mode 13: Full system (HDMI 1 mode 1920*1080@240Hz) for Horizontal (110V/60Hz)		
AC Power :	AC 110V/60Hz	Phase :	LINE
Equipment :	LCD Monitor	Model No :	250LM00005
Temperature :	26°C	Humidity :	53%
Pressure(mbar) :	1001	Date:	2016/09/14

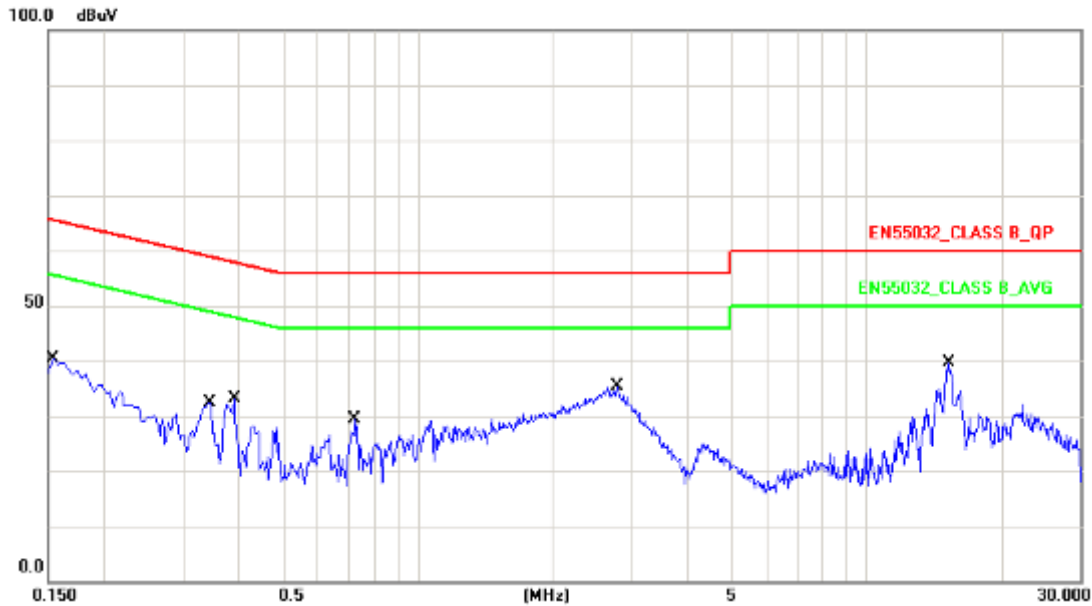

No.	Frequency (MHz)	Factor (dB)	Reading (dBuV)	Level (dBuV)	Limit (dBuV)	Margin (dB)	Detector
1	0.1539	10.13	22.66	32.79	65.78	-32.99	QP
2	0.1539	10.13	0.87	11.00	55.78	-44.78	AVG
3	0.3460	10.14	18.72	28.86	59.06	-30.20	QP
4	0.3460	10.14	5.97	16.11	49.06	-32.95	AVG
5	0.3899	10.15	18.67	28.82	58.06	-29.24	QP
6	0.3899	10.15	10.16	20.31	48.06	-27.75	AVG
7	0.7260	10.15	13.40	23.55	56.00	-32.45	QP
8	0.7260	10.15	4.01	14.16	46.00	-31.84	AVG
9	2.7820	10.18	21.73	31.91	56.00	-24.09	QP
10	2.7820	10.18	13.22	23.40	46.00	-22.60	AVG
11	15.3580	10.51	27.57	38.08	60.00	-21.92	QP
12	15.3580	10.51	21.85	32.36	50.00	-17.64	AVG

Note: Measurement Level = Reading Level + Correct Factor



Test Mode :	Mode 13: Full system (HDMI 1 mode 1920*1080@240Hz) for Horizontal (110V/60Hz)		
AC Power :	AC 110V/60Hz	Phase :	NEUTRAL
Equipment :	LCD Monitor	Model No :	250LM00005
Temperature :	26°C	Humidity :	53%
Pressure(mbar) :	1001	Date:	2016/09/14

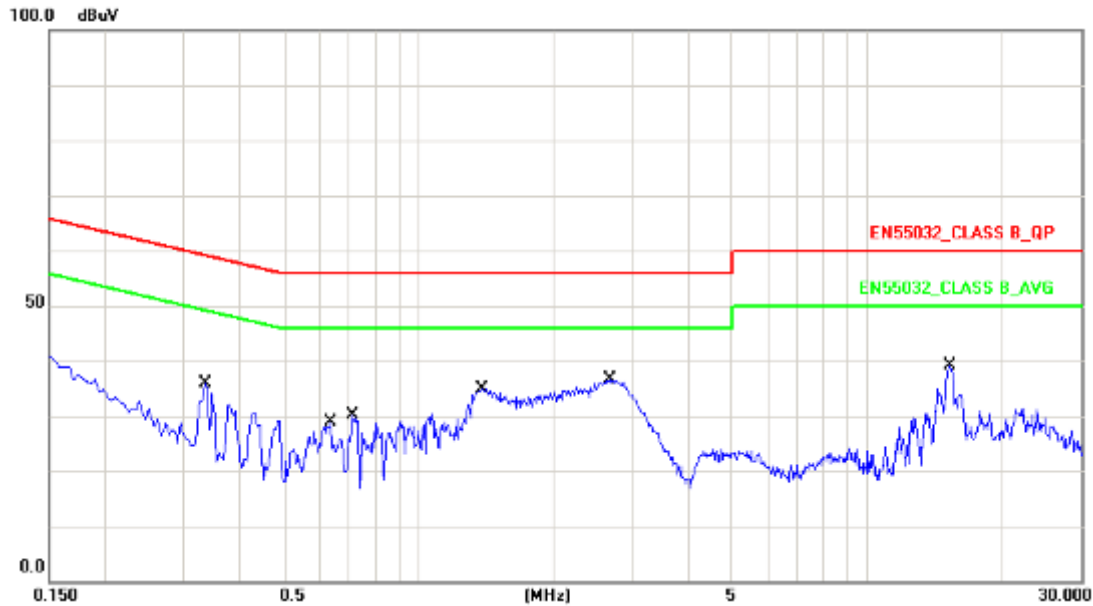

No.	Frequency (MHz)	Factor (dB)	Reading (dBuV)	Level (dBuV)	Limit (dBuV)	Margin (dB)	Detector
1	0.3339	10.14	22.29	32.43	59.35	-26.92	QP
2	0.3339	10.14	16.97	27.11	49.35	-22.24	AVG
3	0.6380	10.16	11.92	22.08	56.00	-33.92	QP
4	0.6380	10.16	2.87	13.03	46.00	-32.97	AVG
5	0.7140	10.16	17.30	27.46	56.00	-28.54	QP
6	0.7140	10.16	7.29	17.45	46.00	-28.55	AVG
7	1.3820	10.18	22.52	32.70	56.00	-23.30	QP
8	1.3820	10.18	10.91	21.09	46.00	-24.91	AVG
9	2.6660	10.19	24.59	34.78	56.00	-21.22	QP
10	2.6660	10.19	13.13	23.32	46.00	-22.68	AVG
11	15.3580	10.52	27.40	37.92	60.00	-22.08	QP
12	15.3580	10.52	21.75	32.27	50.00	-17.73	AVG

Note: Measurement Level = Reading Level + Correct Factor



Test Mode :	Mode 17: Full system (HDMI 2 mode 1920*1080@240Hz) for Horizontal (110V/60Hz)		
AC Power :	AC 110V/60Hz	Phase :	LINE
Equipment :	LCD Monitor	Model No :	250LM00005
Temperature :	26°C	Humidity :	53%
Pressure(mbar) :	1001	Date:	2016/09/14

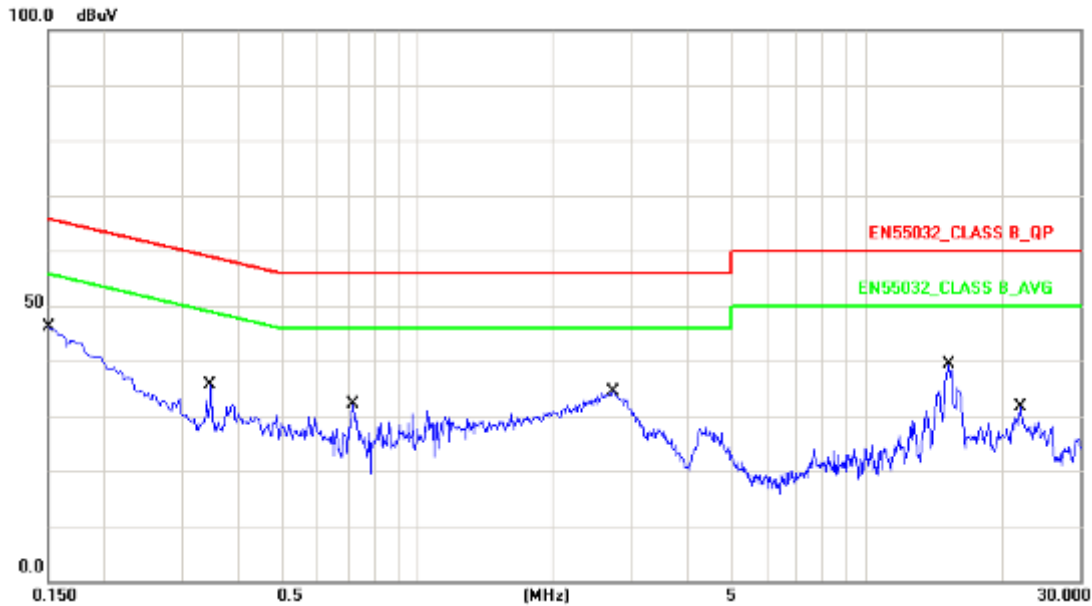

No.	Frequency (MHz)	Factor (dB)	Reading (dBuV)	Level (dBuV)	Limit (dBuV)	Margin (dB)	Detector
1	0.1500	10.13	28.60	38.73	65.99	-27.26	QP
2	0.1500	10.13	6.89	17.02	55.99	-38.97	AVG
3	0.3460	10.14	19.32	29.46	59.06	-29.60	QP
4	0.3460	10.14	7.54	17.68	49.06	-31.38	AVG
5	0.7180	10.15	15.20	25.35	56.00	-30.65	QP
6	0.7180	10.15	6.98	17.13	46.00	-28.87	AVG
7	2.7300	10.18	23.68	33.86	56.00	-22.14	QP
8	2.7300	10.18	12.59	22.77	46.00	-23.23	AVG
9	15.3580	10.51	28.74	39.25	60.00	-20.75	QP
10	15.3580	10.51	23.06	33.57	50.00	-16.43	AVG
11	22.0740	10.37	16.32	26.69	60.00	-33.31	QP
12	22.0740	10.37	11.26	21.63	50.00	-28.37	AVG

Note: Measurement Level = Reading Level + Correct Factor



Test Mode :	Mode 17: Full system (HDMI 2 mode 1920*1080@240Hz) for Horizontal (110V/60Hz)		
AC Power :	AC 110V/60Hz	Phase :	NEUTRAL
Equipment :	LCD Monitor	Model No :	250LM00005
Temperature :	26°C	Humidity :	53%
Pressure(mbar) :	1001	Date:	2016/09/14

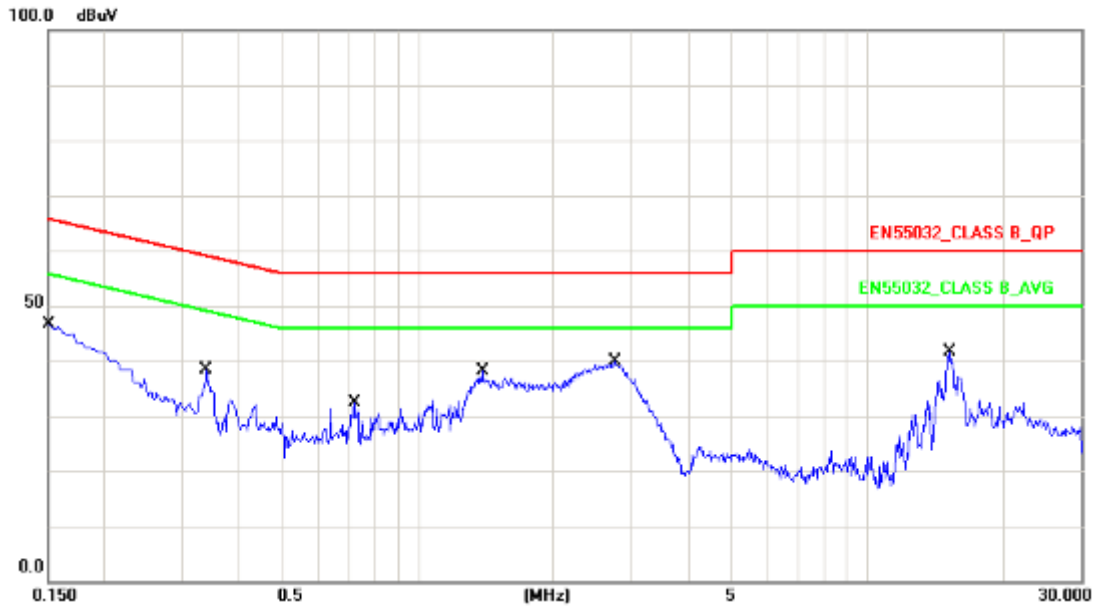

No.	Frequency (MHz)	Factor (dB)	Reading (dBuV)	Level (dBuV)	Limit (dBuV)	Margin (dB)	Detector
1	0.1500	10.13	28.36	38.49	65.99	-27.50	QP
2	0.1500	10.13	9.41	19.54	55.99	-36.45	AVG
3	0.3379	10.14	23.50	33.64	59.25	-25.61	QP
4	0.3379	10.14	18.46	28.60	49.25	-20.65	AVG
5	0.7220	10.16	17.51	27.67	56.00	-28.33	QP
6	0.7220	10.16	9.32	19.48	46.00	-26.52	AVG
7	1.3940	10.18	23.66	33.84	56.00	-22.16	QP
8	1.3940	10.18	12.58	22.76	46.00	-23.24	AVG
9	2.7540	10.20	24.75	34.95	56.00	-21.05	QP
10	2.7540	10.20	13.68	23.88	46.00	-22.12	AVG
11	15.3580	10.52	28.12	38.64	60.00	-21.36	QP
12	15.3580	10.52	23.41	33.93	50.00	-16.07	AVG

Note: Measurement Level = Reading Level + Correct Factor



Test Mode :	Mode 23: Full system (VGA mode 1920*1080@240Hz) for Horizontal (230V/50Hz)		
AC Power :	AC 230V/50Hz	Phase :	LINE
Equipment :	LCD Monitor	Model No :	250LM00005
Temperature :	26°C	Humidity :	53%
Pressure(mbar) :	1001	Date:	2016/09/14

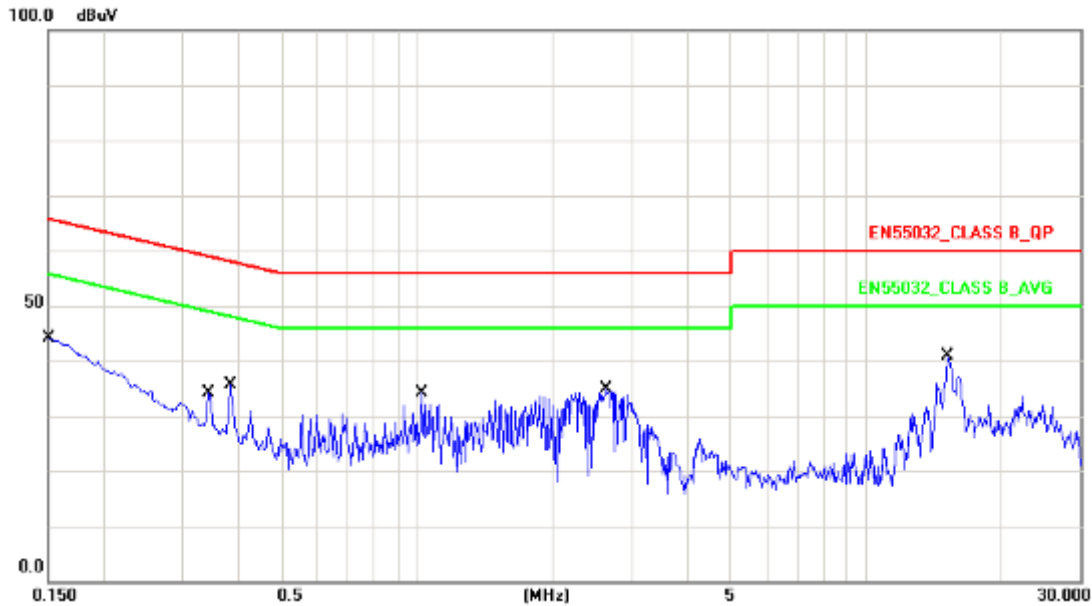

No.	Frequency (MHz)	Factor (dB)	Reading (dBuV)	Level (dBuV)	Limit (dBuV)	Margin (dB)	Detector
1	0.1500	10.13	28.11	38.24	65.99	-27.75	QP
2	0.1500	10.13	5.21	15.34	55.99	-40.65	AVG
3	0.3420	10.14	17.81	27.95	59.15	-31.20	QP
4	0.3420	10.14	16.62	26.76	49.15	-22.39	AVG
5	0.3820	10.15	21.84	31.99	58.23	-26.24	QP
6	0.3820	10.15	21.38	31.53	48.23	-16.70	AVG
7	1.0220	10.16	18.26	28.42	56.00	-27.58	QP
8	1.0220	10.16	13.91	24.07	46.00	-21.93	AVG
9	2.6380	10.18	22.74	32.92	56.00	-23.08	QP
10	2.6380	10.18	15.46	25.64	46.00	-20.36	AVG
11	15.2260	10.52	28.36	38.88	60.00	-21.12	QP
12	15.2260	10.52	22.48	33.00	50.00	-17.00	AVG

Note: Measurement Level = Reading Level + Correct Factor



Test Mode :	Mode 23: Full system (VGA mode 1920*1080@240Hz) for Horizontal (230V/50Hz)		
AC Power :	AC 230V/50Hz	Phase :	NEUTRAL
Equipment :	LCD Monitor	Model No :	250LM00005
Temperature :	26°C	Humidity :	53%
Pressure(mbar) :	1001	Date:	2016/09/14

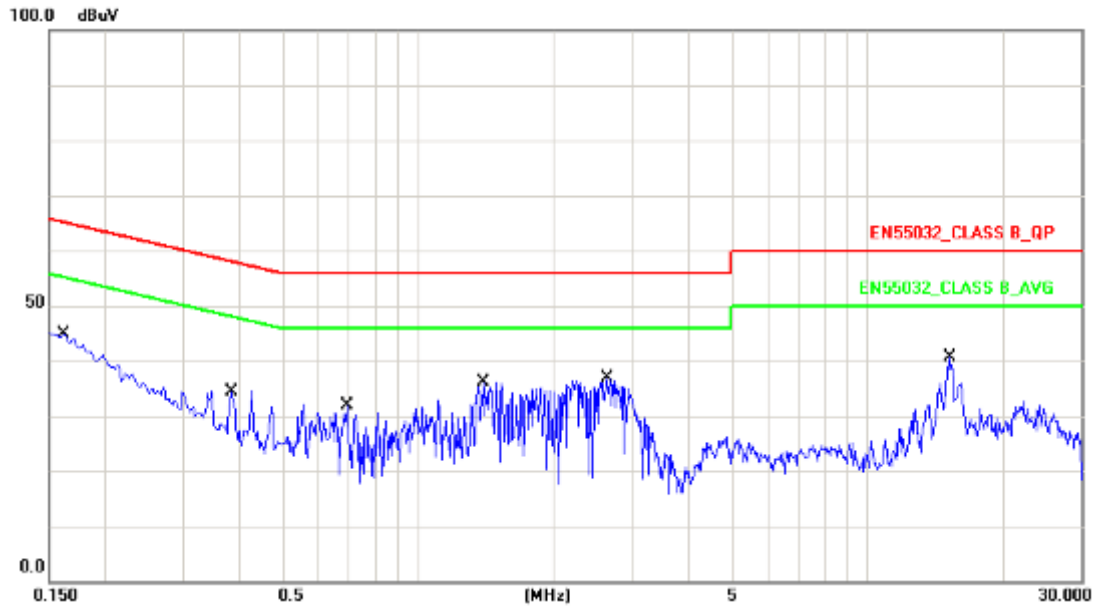

No.	Frequency (MHz)	Factor (dB)	Reading (dBuV)	Level (dBuV)	Limit (dBuV)	Margin (dB)	Detector
1	0.1620	10.13	27.35	37.48	65.36	-27.88	QP
2	0.1620	10.13	6.08	16.21	55.36	-39.15	AVG
3	0.3820	10.15	20.58	30.73	58.23	-27.50	QP
4	0.3820	10.15	19.98	30.13	48.23	-18.10	AVG
5	0.6900	10.16	17.90	28.06	56.00	-27.94	QP
6	0.6900	10.16	10.94	21.10	46.00	-24.90	AVG
7	1.4020	10.18	24.15	34.33	56.00	-21.67	QP
8	1.4020	10.18	20.17	30.35	46.00	-15.65	AVG
9	2.6300	10.19	24.38	34.57	56.00	-21.43	QP
10	2.6300	10.19	17.13	27.32	46.00	-18.68	AVG
11	15.3580	10.52	28.20	38.72	60.00	-21.28	QP
12	15.3580	10.52	22.63	33.15	50.00	-16.85	AVG

Note: Measurement Level = Reading Level + Correct Factor





Test Mode :	Mode 27: Full system (Display mode 1920*1080@240Hz) for Horizontal (230V/50Hz)		
AC Power :	AC 230V/50Hz	Phase :	LINE
Equipment :	LCD Monitor	Model No :	250LM00005
Temperature :	26°C	Humidity :	53%
Pressure(mbar) :	1001	Date:	2016/09/14

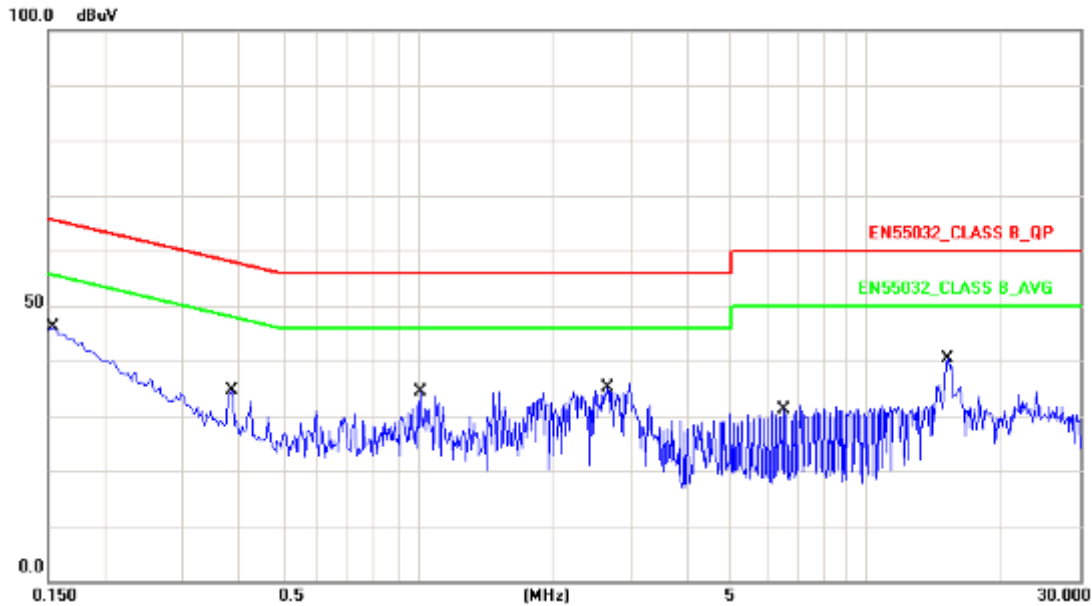

No.	Frequency (MHz)	Factor (dB)	Reading (dBuV)	Level (dBuV)	Limit (dBuV)	Margin (dB)	Detector
1	0.1539	10.13	28.54	38.67	65.78	-27.11	QP
2	0.1539	10.13	6.54	16.67	55.78	-39.11	AVG
3	0.3860	10.15	17.91	28.06	58.15	-30.09	QP
4	0.3860	10.15	14.83	24.98	48.15	-23.17	AVG
5	1.0140	10.16	19.00	29.16	56.00	-26.84	QP
6	1.0140	10.16	15.06	25.22	46.00	-20.78	AVG
7	2.6540	10.18	22.44	32.62	56.00	-23.38	QP
8	2.6540	10.18	12.33	22.51	46.00	-23.49	AVG
9	6.5300	10.26	3.54	13.80	60.00	-46.20	QP
10	6.5300	10.26	-3.15	7.11	50.00	-42.89	AVG
11	15.2260	10.52	27.72	38.24	60.00	-21.76	QP
12	15.2260	10.52	22.23	32.75	50.00	-17.25	AVG

Note: Measurement Level = Reading Level + Correct Factor



Test Mode :	Mode 27: Full system (Display mode 1920*1080@240Hz) for Horizontal (230V/50Hz)		
AC Power :	AC 230V/50Hz	Phase :	NEUTRAL
Equipment :	LCD Monitor	Model No :	250LM00005
Temperature :	26°C	Humidity :	53%
Pressure(mbar) :	1001	Date:	2016/09/14

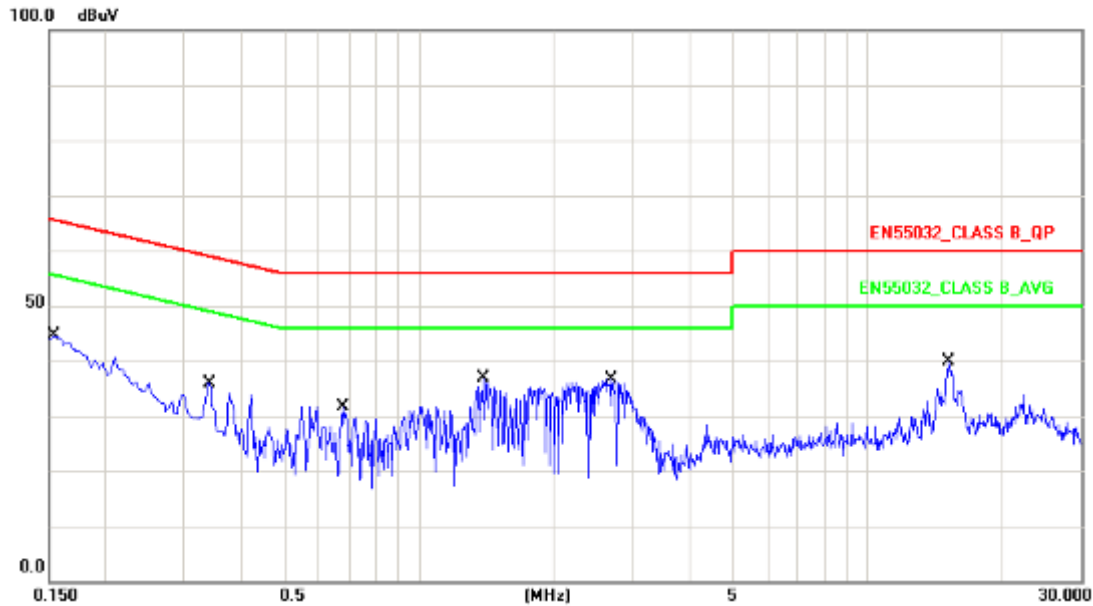

No.	Frequency (MHz)	Factor (dB)	Reading (dBuV)	Level (dBuV)	Limit (dBuV)	Margin (dB)	Detector
1	0.1539	10.13	26.48	36.61	65.78	-29.17	QP
2	0.1539	10.13	8.78	18.91	55.78	-36.87	AVG
3	0.3420	10.14	20.48	30.62	59.15	-28.53	QP
4	0.3420	10.14	18.40	28.54	49.15	-20.61	AVG
5	0.6780	10.16	18.12	28.28	56.00	-27.72	QP
6	0.6780	10.16	14.67	24.83	46.00	-21.17	AVG
7	1.3940	10.18	24.01	34.19	56.00	-21.81	QP
8	1.3940	10.18	19.96	30.14	46.00	-15.86	AVG
9	2.7020	10.19	23.67	33.86	56.00	-22.14	QP
10	2.7020	10.19	15.30	25.49	46.00	-20.51	AVG
11	15.2260	10.52	27.57	38.09	60.00	-21.91	QP
12	15.2260	10.52	22.14	32.66	50.00	-17.34	AVG

Note: Measurement Level = Reading Level + Correct Factor



Test Mode :	Mode 31: Full system (DVI mode 1920*1080@240Hz) for Horizontal (230V/50Hz)		
AC Power :	AC 230V/50Hz	Phase :	LINE
Equipment :	LCD Monitor	Model No :	250LM00005
Temperature :	26°C	Humidity :	53%
Pressure(mbar) :	1001	Date:	2016/09/14

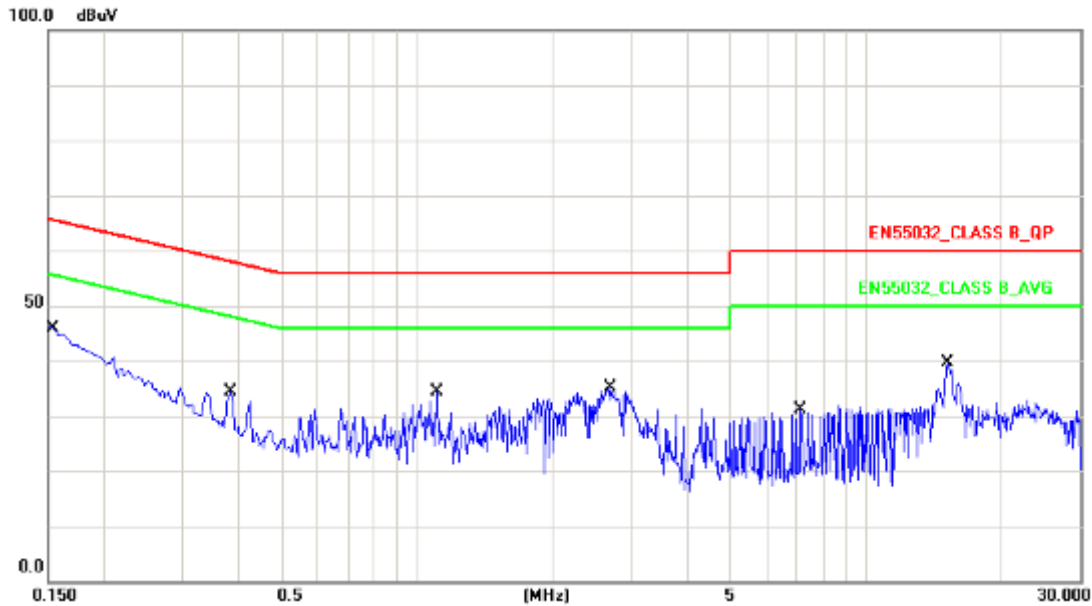

No.	Frequency (MHz)	Factor (dB)	Reading (dBuV)	Level (dBuV)	Limit (dBuV)	Margin (dB)	Detector
1	0.1556	10.13	28.57	38.70	65.69	-26.99	QP
2	0.1556	10.13	6.12	16.25	55.69	-39.44	AVG
3	0.3820	10.15	22.33	32.48	58.23	-25.75	QP
4	0.3820	10.15	21.40	31.55	48.23	-16.68	AVG
5	1.1100	10.16	17.05	27.21	56.00	-28.79	QP
6	1.1100	10.16	9.20	19.36	46.00	-26.64	AVG
7	2.7020	10.18	22.52	32.70	56.00	-23.30	QP
8	2.7020	10.18	13.62	23.80	46.00	-22.20	AVG
9	7.1620	10.26	5.74	16.00	60.00	-44.00	QP
10	7.1620	10.26	-0.88	9.38	50.00	-40.62	AVG
11	15.2260	10.52	27.70	38.22	60.00	-21.78	QP
12	15.2260	10.52	22.23	32.75	50.00	-17.25	AVG

Note: Measurement Level = Reading Level + Correct Factor



Test Mode :	Mode 31: Full system (DVI mode 1920*1080@240Hz) for Horizontal (230V/50Hz)		
AC Power :	AC 230V/50Hz	Phase :	NEUTRAL
Equipment :	LCD Monitor	Model No :	250LM00005
Temperature :	26°C	Humidity :	53%
Pressure(mbar) :	1001	Date:	2016/09/14

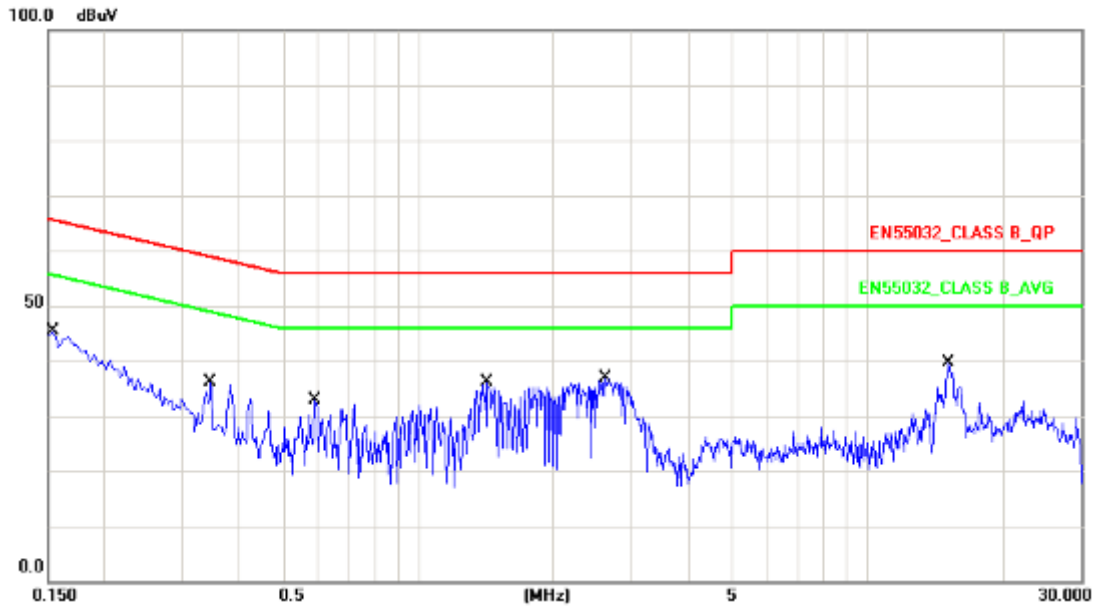

No.	Frequency (MHz)	Factor (dB)	Reading (dBuV)	Level (dBuV)	Limit (dBuV)	Margin (dB)	Detector
1	0.1539	10.13	27.13	37.26	65.78	-28.52	QP
2	0.1539	10.13	8.72	18.85	55.78	-36.93	AVG
3	0.3460	10.14	18.71	28.85	59.06	-30.21	QP
4	0.3460	10.14	11.98	22.12	49.06	-26.94	AVG
5	0.5899	10.15	19.48	29.63	56.00	-26.37	QP
6	0.5899	10.15	16.25	26.40	46.00	-19.60	AVG
7	1.4299	10.18	24.22	34.40	56.00	-21.60	QP
8	1.4299	10.18	16.53	26.71	46.00	-19.29	AVG
9	2.6099	10.19	24.55	34.74	56.00	-21.26	QP
10	2.6099	10.19	14.98	25.17	46.00	-20.83	AVG
11	15.2260	10.52	27.56	38.08	60.00	-21.92	QP
12	15.2260	10.52	21.98	32.50	50.00	-17.50	AVG

Note: Measurement Level = Reading Level + Correct Factor



Test Mode :	Mode 35: Full system (HDMI 1 mode 1920*1080@240Hz) for Horizontal (230V/50Hz)		
AC Power :	AC 230V/50Hz	Phase :	LINE
Equipment :	LCD Monitor	Model No :	250LM00005
Temperature :	26°C	Humidity :	53%
Pressure(mbar) :	1001	Date:	2016/09/14

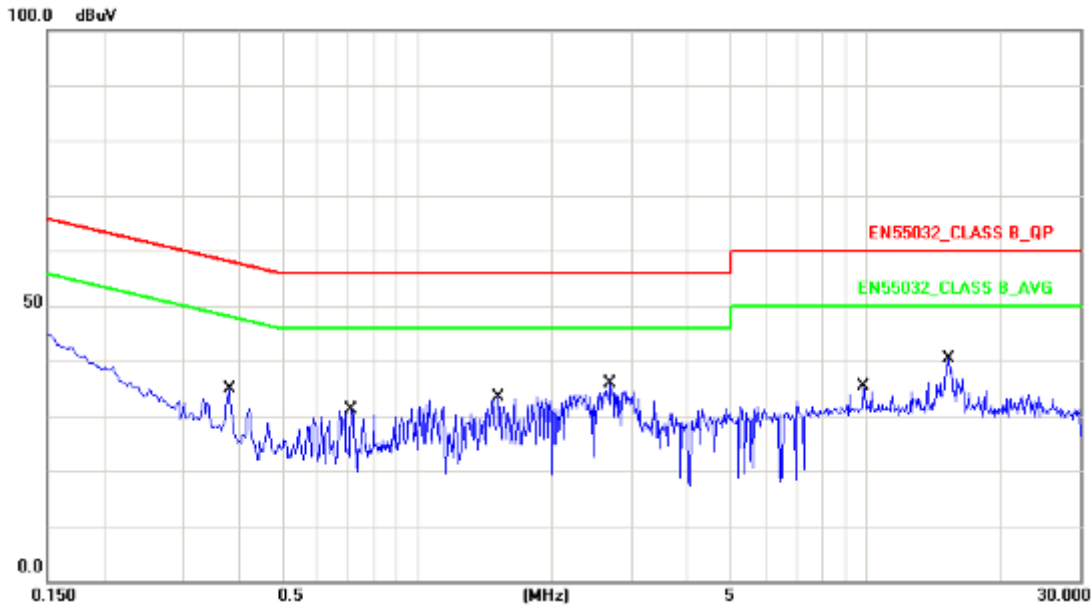

No.	Frequency (MHz)	Factor (dB)	Reading (dBuV)	Level (dBuV)	Limit (dBuV)	Margin (dB)	Detector
1	0.3820	10.15	22.22	32.37	58.23	-25.86	QP
2	0.3820	10.15	21.11	31.26	48.23	-16.97	AVG
3	0.7140	10.15	15.53	25.68	56.00	-30.32	QP
4	0.7140	10.15	10.86	21.01	46.00	-24.99	AVG
5	1.5180	10.17	19.50	29.67	56.00	-26.33	QP
6	1.5180	10.17	14.31	24.48	46.00	-21.52	AVG
7	2.6980	10.18	22.47	32.65	56.00	-23.35	QP
8	2.6980	10.18	12.90	23.08	46.00	-22.92	AVG
9	9.8860	10.25	7.82	18.07	60.00	-41.93	QP
10	9.8860	10.25	-3.75	6.50	50.00	-43.50	AVG
11	15.3580	10.51	27.62	38.13	60.00	-21.87	QP
12	15.3580	10.51	22.02	32.53	50.00	-17.47	AVG

Note: Measurement Level = Reading Level + Correct Factor



Test Mode :	Mode 35: Full system (HDMI 1 mode 1920*1080@240Hz) for Horizontal (230V/50Hz)		
AC Power :	AC 230V/50Hz	Phase :	NEUTRAL
Equipment :	LCD Monitor	Model No :	250LM00005
Temperature :	26°C	Humidity :	53%
Pressure(mbar) :	1001	Date:	2016/09/14

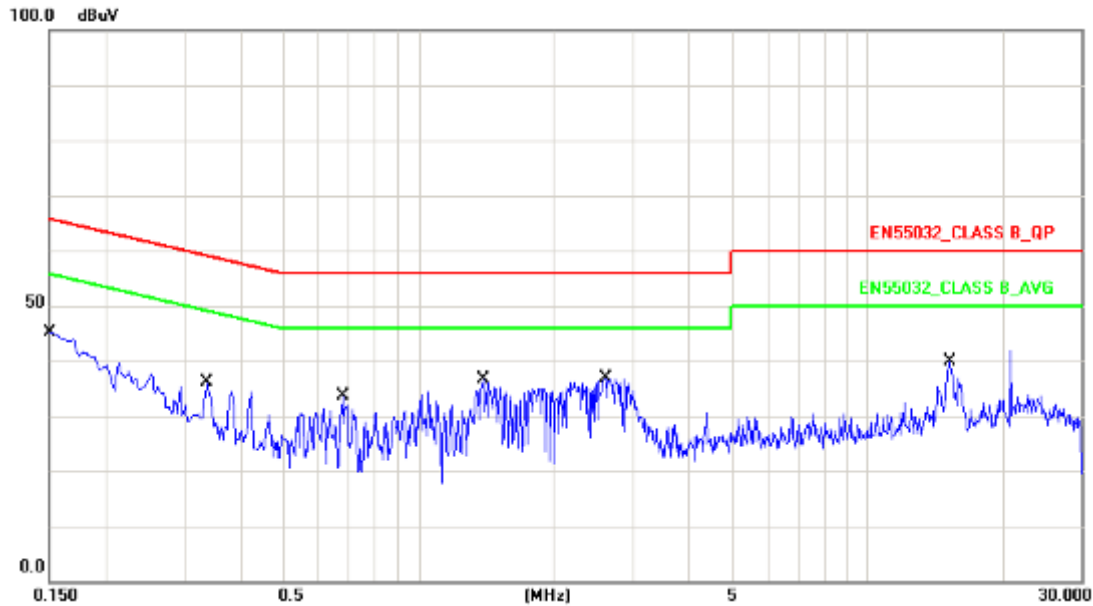

No.	Frequency (MHz)	Factor (dB)	Reading (dBuV)	Level (dBuV)	Limit (dBuV)	Margin (dB)	Detector
1	0.1500	10.13	27.51	37.64	65.99	-28.35	QP
2	0.1500	10.13	7.96	18.09	55.99	-37.90	AVG
3	0.3379	10.14	21.34	31.48	59.25	-27.77	QP
4	0.3379	10.14	19.26	29.40	49.25	-19.85	AVG
5	0.6780	10.16	17.61	27.77	56.00	-28.23	QP
6	0.6780	10.16	13.74	23.90	46.00	-22.10	AVG
7	1.3940	10.18	23.34	33.52	56.00	-22.48	QP
8	1.3940	10.18	18.32	28.50	46.00	-17.50	AVG
9	2.6180	10.19	23.66	33.85	56.00	-22.15	QP
10	2.6180	10.19	15.02	25.21	46.00	-20.79	AVG
11	15.3580	10.52	27.40	37.92	60.00	-22.08	QP
12	15.3580	10.52	21.75	32.27	50.00	-17.73	AVG

Note: Measurement Level = Reading Level + Correct Factor



Test Mode :	Mode 39: Full system (HDMI 2 mode 1920*1080@240Hz) for Horizontal (230V/50Hz)		
AC Power :	AC 230V/50Hz	Phase :	LINE
Equipment :	LCD Monitor	Model No :	250LM00005
Temperature :	26°C	Humidity :	53%
Pressure(mbar) :	1001	Date:	2016/09/14

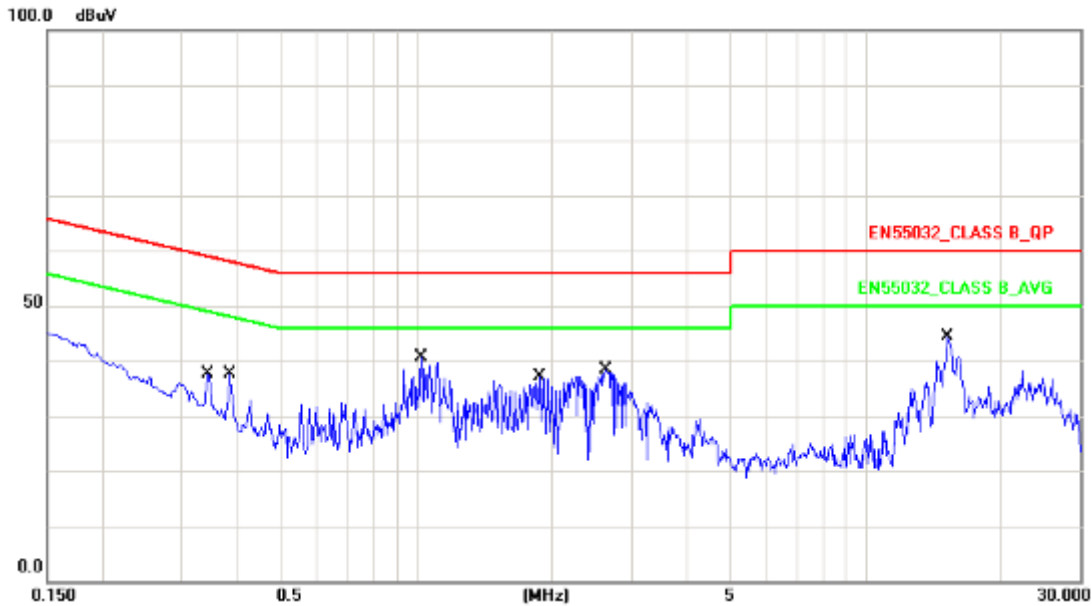

No.	Frequency (MHz)	Factor (dB)	Reading (dBuV)	Level (dBuV)	Limit (dBuV)	Margin (dB)	Detector
1	0.3420	10.14	17.81	27.95	59.15	-31.20	QP
2	0.3420	10.14	16.62	26.76	49.15	-22.39	AVG
3	0.3820	10.15	21.84	31.99	58.23	-26.24	QP
4	0.3820	10.15	21.38	31.53	48.23	-16.70	AVG
5	1.0220	10.16	18.26	28.42	56.00	-27.58	QP
6	1.0220	10.16	13.91	24.07	46.00	-21.93	AVG
7	1.8740	10.17	29.68	39.85	56.00	-16.15	QP
8	1.8740	10.17	23.06	33.23	46.00	-12.77	AVG
9	2.6380	10.18	22.74	32.92	56.00	-23.08	QP
10	2.6380	10.18	15.46	25.64	46.00	-20.36	AVG
11	15.2260	10.52	28.36	38.88	60.00	-21.12	QP
12	15.2260	10.52	22.48	33.00	50.00	-17.00	AVG

Note: Measurement Level = Reading Level + Correct Factor



Test Mode :	Mode 39: Full system (HDMI 2 mode 1920*1080@240Hz) for Horizontal (230V/50Hz)		
AC Power :	AC 230V/50Hz	Phase :	NEUTRAL
Equipment :	LCD Monitor	Model No :	250LM00005
Temperature :	26°C	Humidity :	53%
Pressure(mbar) :	1001	Date:	2016/09/14

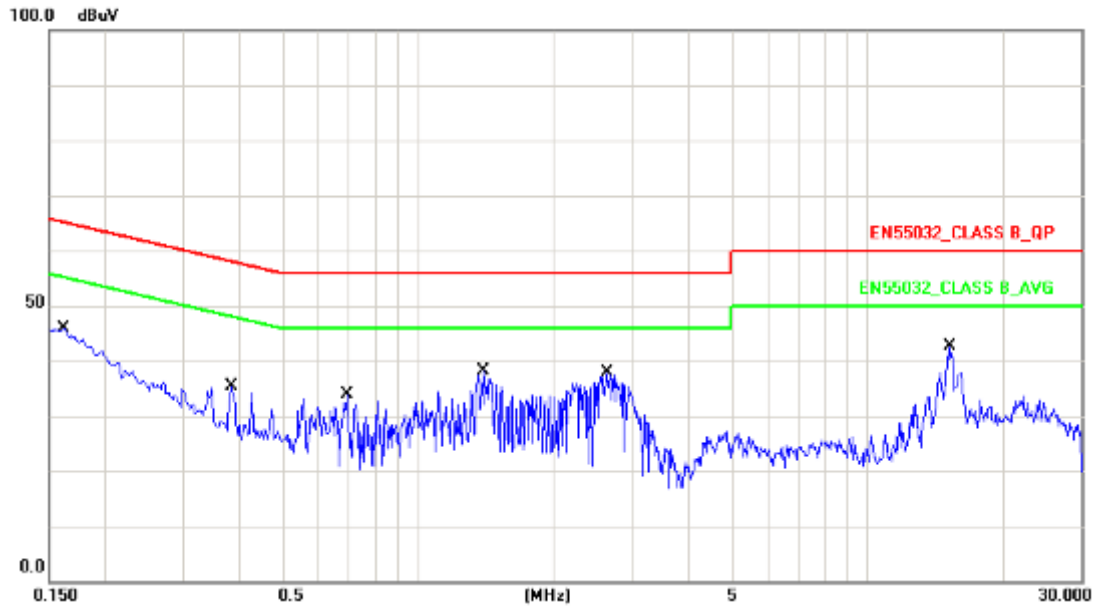

No.	Frequency (MHz)	Factor (dB)	Reading (dBuV)	Level (dBuV)	Limit (dBuV)	Margin (dB)	Detector
1	0.1620	10.13	26.98	37.11	65.36	-28.25	QP
2	0.1620	10.13	8.41	18.54	55.36	-36.82	AVG
3	0.3820	10.15	22.06	32.21	58.23	-26.02	QP
4	0.3820	10.15	18.35	28.50	48.23	-19.73	AVG
5	0.6900	10.16	18.42	28.58	56.00	-27.42	QP
6	0.6900	10.16	11.06	21.22	46.00	-24.78	AVG
7	1.4020	10.18	23.58	33.76	56.00	-22.24	QP
8	1.4020	10.18	21.54	31.72	46.00	-14.28	AVG
9	2.6300	10.19	23.60	33.79	56.00	-22.21	QP
10	2.6300	10.19	18.95	29.14	46.00	-16.86	AVG
11	15.3580	10.52	28.41	38.93	60.00	-21.07	QP
12	15.3580	10.52	23.60	34.12	50.00	-15.88	AVG

Note: Measurement Level = Reading Level + Correct Factor

Test engineer: *Sun Zhang*





#### **4.5.2 Conducted Emission for Telecommunication Port Test Data**

Note: The EUT doesn't have the telecommunication port.



#### 4.6. Test Photographs of Power Port

Front View



Rear View





## 5. Test of Radiated Emission

### 5.1. Test Limit

The EUT shall meet the limits of below Table when measured at the measuring distance R in accordance with the methods described in European Standard EN 55032. If the reading on the measuring receiver shows fluctuations close to the limit, the reading shall be observed for at least 15 s at each measurement frequency; the highest reading shall be recorded, with the exception of any brief isolated high reading, which shall be ignored.

**Table 1 – Required highest frequency for radiated measurement**

Highest internal frequency ( $F_x$ )	Highest measured frequency
$F_x \leq 108$ MHz	1 GHz
$108$ MHz $< F_x \leq 500$ MHz	2 GHz
$500$ MHz $< F_x \leq 1$ GHz	5 GHz
$F_x > 1$ GHz	$5 \times F_x$ up to a maximum of 6 GHz

NOTE 1 For FM and TV broadcast receivers,  $F_x$  is determined from the highest frequency generated or used excluding the local oscillator and tuned frequencies.

NOTE 2  $F_x$  is defined in 3.1.19.

Where the  $F_x$  is unknown, the radiated emission measurements shall be performed up to 6 GHz.

**Table A.2 – Requirements for radiated emissions at frequencies up to 1 GHz for Class A equipment**

Table clause	Frequency range MHz	Measurement		Class A limits dB( $\mu$ V/m)
		Distance m	Detector type/ bandwidth	OATS/SAC (see Table A.1)
A2.1	30 – 230	10	Quasi Peak / 120 kHz	40
	230 – 1 000			47
A2.2	30 – 230	3		50
	230 – 1 000			57

NOTE Apply only A2.1 or A2.2 across the entire frequency range.

**Table A.3 – Requirements for radiated emissions at frequencies above 1 GHz for Class A equipment**

Table clause	Frequency range MHz	Measurement		Class A limits dB( $\mu$ V/m)
		Distance m	Detector type/ bandwidth	FSOATS (see Table A.1)
A3.1	1 000 – 3 000	3	Average / 1 MHz	56
	3 000 – 6 000			60
A3.2	1 000 – 3 000		Peak / 1 MHz	76
	3 000 – 6 000			80

NOTE Apply A3.1 and A3.2 across the frequency range from 1 000 MHz to the highest required frequency of measurement derived from Table 1.



**Table A.4 – Requirements for radiated emissions at frequencies up to 1 GHz for Class B equipment**

Table clause	Frequency range MHz	Measurement		Class B limits dB(μV/m)	
		Distance m	Detector type/ bandwidth	OATS/SAC (see Table A.1)	
A4.1	30 – 230	10	Quasi Peak / 120 kHz	30	
	230 – 1 000			37	
A4.2	30 – 230	3		40	
	230 – 1 000			47	

NOTE Apply only table clause A4.1 or A4.2 across the entire frequency range.

**Table A.5 – Requirements for radiated emissions at frequencies above 1 GHz for Class B equipment**

Table clause	Frequency range MHz	Measurement		Class B limits dB(μV/m)	
		Distance m	Detector type/ bandwidth	FSOATS (see Table A.1)	
A5.1	1 000 – 3 000	3	Average/ 1 MHz	50	
	3 000 – 6 000			54	
A5.2	1 000 – 3 000		Peak/ 1 MHz	70	
	3 000 – 6 000			74	

NOTE Apply A5.1 and A5.2 across the frequency range from 1 000 MHz to the highest required frequency of measurement derived from Table 1.

**Table A.6 – Requirements for radiated emissions from FM receivers**

Table clause	Frequency range MHz	Measurement		Class B limit dB(μV/m)	
		Distance m	Detector type/ bandwidth	Fundamental	Harmonics
				OATS/SAC (see Table A.1)	OATS/SAC (see Table A.1)
A6.1	30 – 230	10	Quasi peak/ 120 kHz	50	42
	230 – 300				42
	300 – 1 000				46
A6.2	30 – 230	3		60	52
	230 – 300				52
	300 – 1 000				56

NOTE 1 Apply only A.6.1 or A.6.2 across the entire frequency range.

NOTE 2 These relaxed limits apply only to emissions at the fundamental and harmonic frequencies of the local oscillator. Signals at all other frequencies shall be compliant with the limits given in Table A.4.



**Table A.12 – Requirements for conducted differential voltage emissions from Class B equipment**

<b>Applicable to</b>						
1. TV broadcast receiver tuner ports (3.1.8) with an accessible connector						
2. RF modulator output ports (3.1.27)						
3. FM broadcast receiver tuner ports (3.1.8) with an accessible connector						
Table clause	Frequency range MHz	Detector type/ bandwidth	Class B limits dB(µV) 75 Ω			Applicability
			Other	Local Oscillator Fundamental	Local Oscillator Harmonics	
A12.1	30 – 950	For frequencies ≤1 GHz	46	46	46	See NOTE 1
	950 – 2 150		46	54	54	
A12.2	950 – 2 150		46	54	54	See NOTE 2
A12.3	30 – 300		Quasi Peak/ 120 kHz	46	54	50
	300 – 1 000	52				
A12.4	30 – 300	For frequencies ≥1 GHz	46	66	59	See NOTE 4
	300 – 1 000				52	
A12.5	30 – 950	Peak/ 1 MHz	46	76	46	See NOTE 5
	950 – 2 150			n/a	54	

NOTE 1 Television receivers (analogue or digital), video recorders and PC TV broadcast receiver tuner cards working in channels between 30 MHz and 1 GHz, and digital audio receivers.

NOTE 2 Tuner units (not the LNB) for satellite signal reception.

NOTE 3 Frequency modulation audio receivers and PC tuner cards.

NOTE 4 Frequency modulation car radios.

NOTE 5 Applicable to EUTs with RF modulator output ports (for example DVD equipment, video recorders, camcorders and decoders etc.) designed to connect to TV broadcast receiver tuner ports.

NOTE 6 Testing is required at only one EUT supply voltage and frequency.

NOTE 7 The term 'other' refers to all emissions other than the fundamental and the harmonics of the local oscillator.

NOTE 8 The test shall be performed with the device operating at each reception channel.

NOTE 9 The test shall cover the entire frequency range.

## 5.2. Test Procedures

- a. The EUT was placed on a rotatable table top 0.8 meter above ground.
- b. The EUT was set 3/10 meters from the interference receiving antenna which was mounted on the top of a variable height antenna tower.
- c. The table was rotated 360 degrees to determine the position of the highest radiation.
- d. The antenna is a half wave dipole and its height is varied between one meter and four meters above ground to find the maximum value of the field strength both horizontal polarization and vertical polarization of the antenna are set to make the measurement.
- e. For each suspected emission the EUT was arranged to its worst case and then tune the antenna tower (from 1 M to 4 M) and turn table (from 0 degree to 360 degrees) to find the maximum reading.
- f. Set the test-receiver system to Peak Detect Function and specified bandwidth with Maximum Hold Mode.
- g. If the emission level of the EUT in peak mode was 3 dB lower than the limit specified, then testing will be stopped and peak values of EUT will be reported, otherwise, the emissions which do not have 3 dB margin will be repeated one by one using the quasi-peak method and reported.

## 5.3. Typical Test Setup

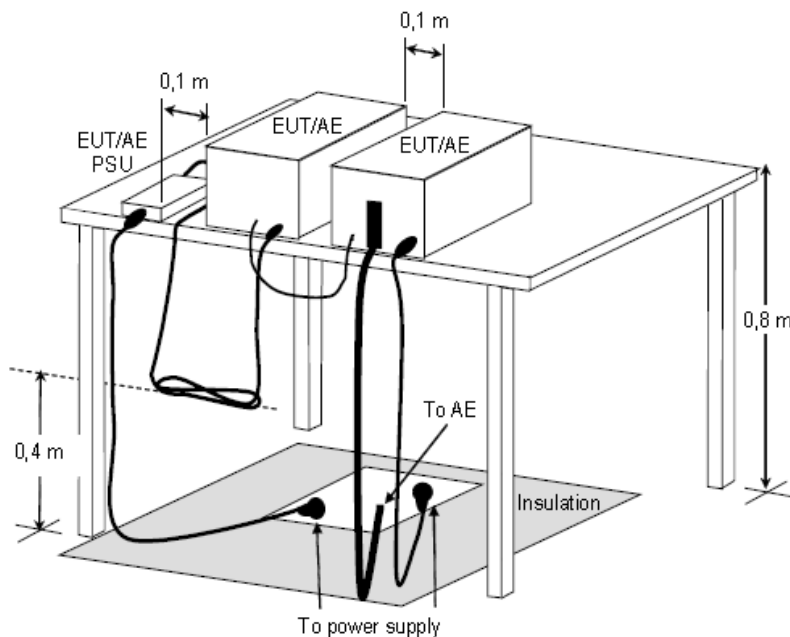

Figure D.8 – Example measurement arrangement for table-top EUT  
(Radiated emission measurement)



#### 5.4. Measurement Equipment

Instrument/Ancillary	Manufacturer	Model No.	Serial No.	Calibration Date	Valid Date.
EMI Test Receiver	R&S	ESC17	100968	2016.03.26	2017.03.25
Preamplifier	Agilent	87405B	My39500554	2016.03.26	2017.03.25
Preamplifier	Agilent	8449B	3008A02342	2016.03.26	2017.03.25
Bilog Antenna	Sunol Science	JB1	A072414-1	2016.04.16	2017.04.15
Broad-Band Horn Antenna	Schwarzbeck	BBHA9120D	9120D-618	2016.04.16	2017.04.15
Spectrum Analyzer	R&S	FSP40	100324	2016.03.26	2017.03.25
Temperature/ Humidity Meter	Zhicheng	ZC1-11	CEP-TH-001	2016.03.29	2017.03.28
EZ-EMC	Fala	Ver CT3A1	N/A	N/A	N/A



5.5. Test Result and Data (30MHz ~ 1GHz)

Test Mode :	Mode 1: Full system (VGA mode 1920*1080@240Hz) for Horizontal (110V/60Hz)		
AC Power :	AC 110V/60Hz	Ant. Polarization:	Horizontal
Equipment :	LCD Monitor	Model No :	250LM00005
Temperature :	26°C	Humidity :	56%
Pressure(mbar) :	1001	Date:	2016/09/11

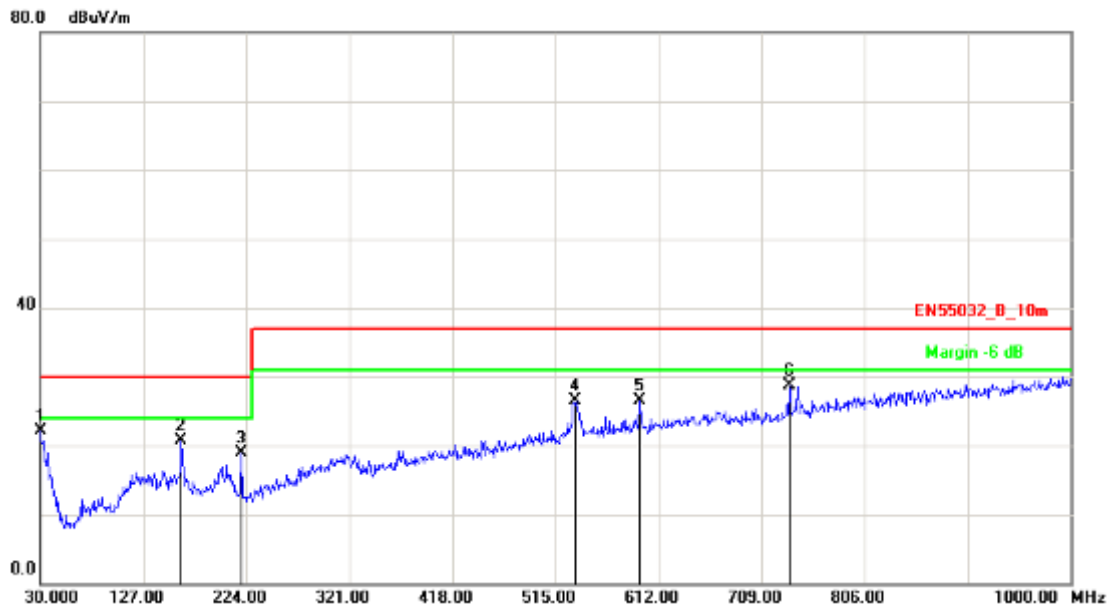

No.	Frequency (MHz)	Factor (dB/m)	Reading (dBuV)	Level (dBuV/m)	Limit (dBuV/m)	Margin (dB)	Det.	Height (cm)	Azimuth (deg)
1	30.0000	-3.26	25.31	22.05	30.00	-7.95	peak	100	17
2	162.8899	-10.95	31.59	20.64	30.00	-9.36	peak	400	68
3	219.1500	-11.84	30.79	18.95	30.00	-11.05	peak	400	114
4	534.3999	-2.33	28.78	26.45	37.00	-10.55	peak	100	152
5	594.5399	-1.32	27.73	26.41	37.00	-10.59	peak	100	188
6	736.1599	0.75	28.03	28.78	37.00	-8.22	peak	100	156

Note: Measurement Level = Reading Level + Correct Factor





Test Mode :	Mode 1: Full system (VGA mode 1920*1080@240Hz) for Horizontal (110V/60Hz)		
AC Power :	AC 110V/60Hz	Ant. Polarization:	Vertical
Equipment :	LCD Monitor	Model No :	250LM00005
Temperature :	26°C	Humidity :	56%
Pressure(mbar) :	1001	Date:	2016/09/11

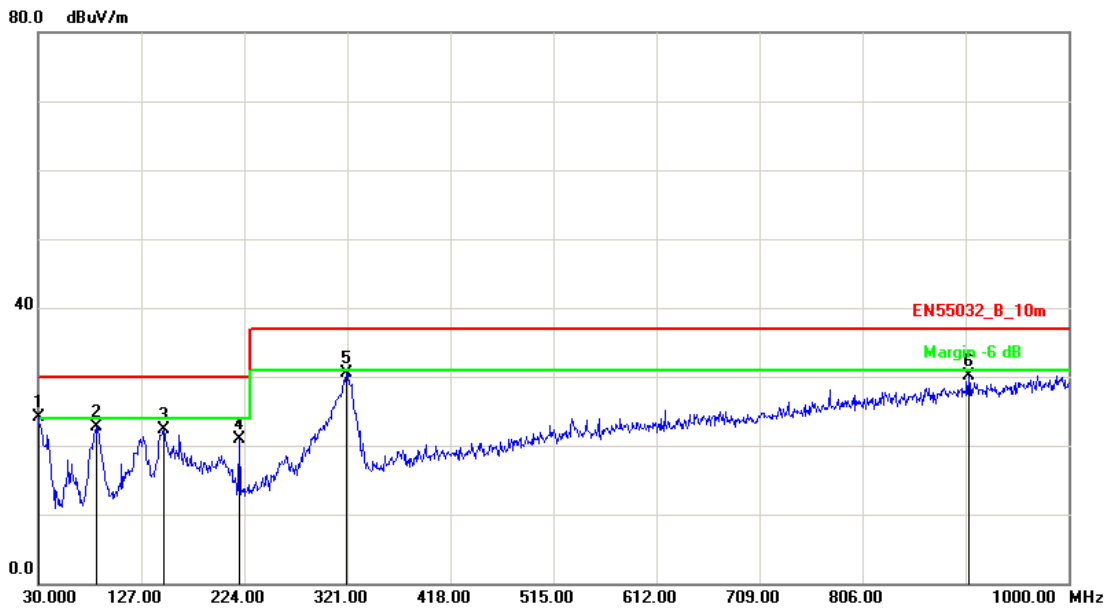

No.	Frequency (MHz)	Factor (dB/m)	Reading (dBuV)	Level (dBuV/m)	Limit (dBuV/m)	Margin (dB)	Det.	Height (cm)	Azimuth (deg)
1	30.0000	-3.26	27.27	24.01	30.00	-5.99	peak	100	125
2	84.3200	-16.27	39.05	22.78	30.00	-7.22	peak	100	292
3	148.3400	-10.60	32.82	22.22	30.00	-7.78	peak	100	64
4	219.1500	-11.84	32.75	20.91	30.00	-9.09	peak	100	1
5	320.0300	-8.02	38.46	30.44	37.00	-6.56	peak	100	197
6	905.9100	3.57	26.52	30.09	37.00	-6.91	peak	400	323

Note: Measurement Level = Reading Level + Correct Factor



Test Mode :	Mode 5: Full system (Display mode 1920*1080@240Hz) for Horizontal (110V/60Hz)		
AC Power :	AC 110V/60Hz	Ant. Polarization:	Horizontal
Equipment :	LCD Monitor	Model No :	250LM00005
Temperature :	26°C	Humidity :	56%
Pressure(mbar) :	1001	Date:	2016/09/11

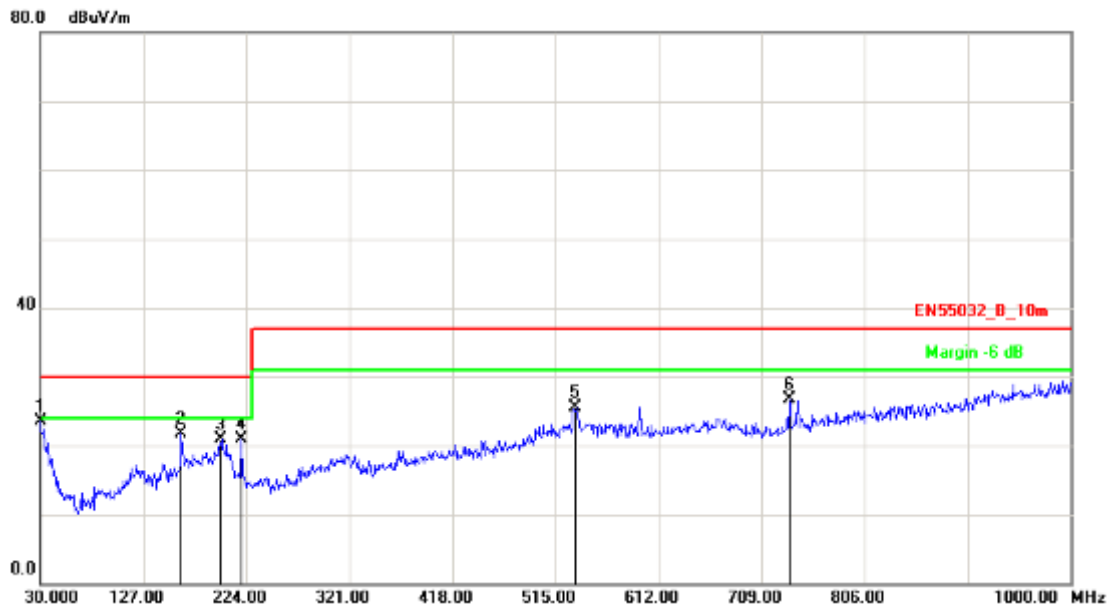

No.	Frequency (MHz)	Factor (dB/m)	Reading (dBuV)	Level (dBuV/m)	Limit (dBuV/m)	Margin (dB)	Det.	Height (cm)	Azimuth (deg)
1	30.0000	-3.26	26.81	23.55	30.00	-6.45	peak	100	118
2	162.8899	-10.95	32.59	21.64	30.00	-8.36	peak	400	263
3	200.7198	-9.99	30.95	20.96	30.00	-9.04	peak	400	55
4	219.1500	-11.84	32.79	20.95	30.00	-9.05	peak	100	20
5	534.3999	-2.33	27.78	25.45	37.00	-11.55	peak	400	79
6	736.1598	0.75	26.03	26.78	37.00	-10.22	peak	100	326

Note: Measurement Level = Reading Level + Correct Factor



Test Mode :	Mode 5: Full system (Display mode 1920*1080@240Hz) for Horizontal (110V/60Hz)		
AC Power :	AC 110V/60Hz	Ant. Polarization:	Vertical
Equipment :	LCD Monitor	Model No :	250LM00005
Temperature :	26°C	Humidity :	56%
Pressure(mbar) :	1001	Date:	2016/09/11

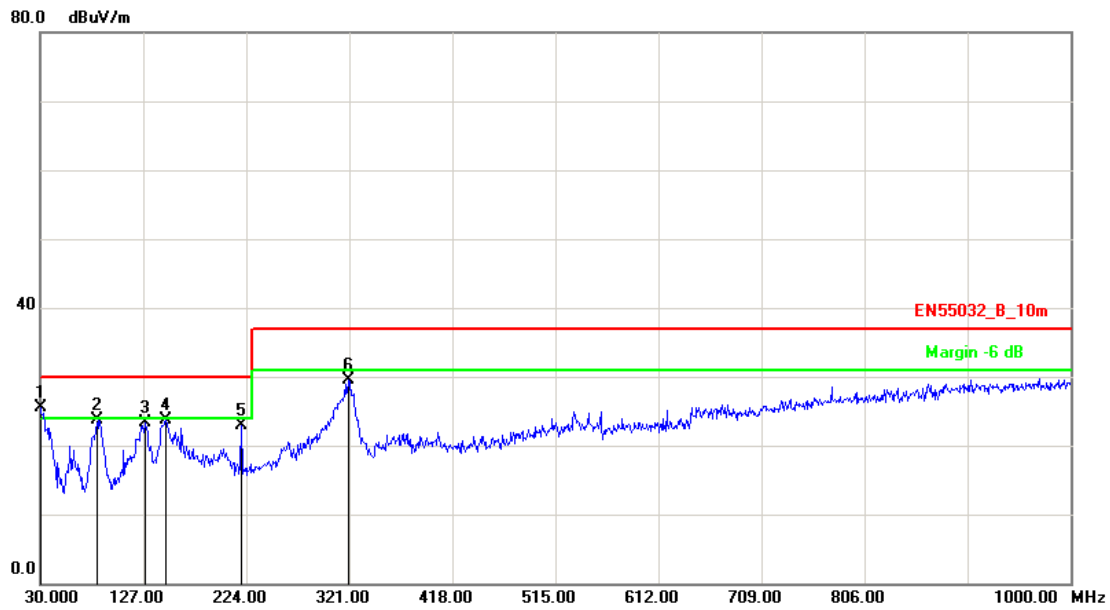

No.	Frequency (MHz)	Factor (dB/m)	Reading (dBuV)	Level (dBuV/m)	Limit (dBuV/m)	Margin (dB)	Det.	Height (cm)	Azimuth (deg)
1	30.0000	-3.26	28.77	25.51	30.00	-4.49	peak	100	152
2	84.3198	-16.27	40.05	23.78	30.00	-6.22	peak	100	263
3	128.9398	-9.94	33.27	23.33	30.00	-6.67	peak	100	11
4	148.3400	-10.60	34.32	23.72	30.00	-6.28	peak	100	7
5	219.1500	-11.84	34.75	22.91	30.00	-7.09	peak	400	325
6	320.0298	-8.02	37.46	29.44	37.00	-7.56	peak	400	99

Note: Measurement Level = Reading Level + Correct Factor



Test Mode :	Mode 9: Full system (DVI mode 1920*1080@240Hz) for Horizontal (110V/60Hz)		
AC Power :	AC 110V/60Hz	Ant. Polarization:	Horizontal
Equipment :	LCD Monitor	Model No :	250LM00005
Temperature :	26°C	Humidity :	56%
Pressure(mbar) :	1001	Date:	2016/09/11

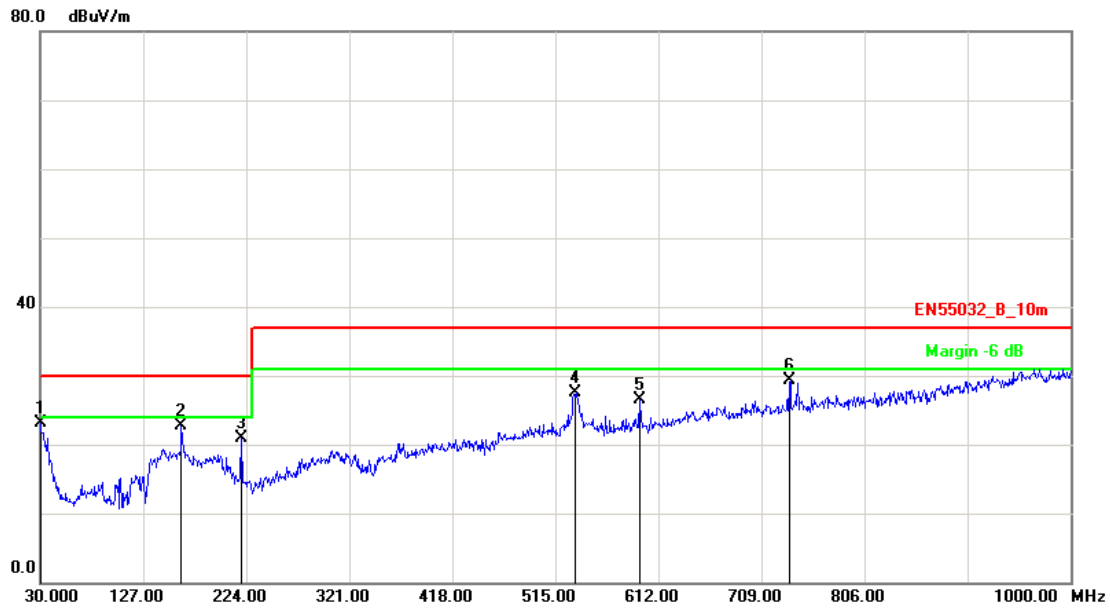

No.	Frequency (MHz)	Factor (dB/m)	Reading (dBuV)	Level (dBuV/m)	Limit (dBuV/m)	Margin (dB)	Det.	Height (cm)	Azimuth (deg)
1	30.0000	-3.26	26.31	23.05	30.00	-6.95	peak	100	29
2	162.8899	-10.95	33.59	22.64	30.00	-7.36	peak	400	254
3	219.1500	-11.84	32.79	20.95	30.00	-9.05	peak	400	187
4	534.3999	-2.33	29.78	27.45	37.00	-9.55	peak	400	64
5	594.5398	-1.32	27.73	26.41	37.00	-10.59	peak	100	32
6	736.1598	0.75	28.53	29.28	37.00	-7.72	peak	200	0

Note: Measurement Level = Reading Level + Correct Factor



Test Mode :	Mode 9: Full system (DVI mode 1920*1080@240Hz) for Horizontal (110V/60Hz)		
AC Power :	AC 110V/60Hz	Ant. Polarization:	Vertical
Equipment :	LCD Monitor	Model No :	250LM00005
Temperature :	26°C	Humidity :	56%
Pressure(mbar) :	1001	Date:	2016/09/11

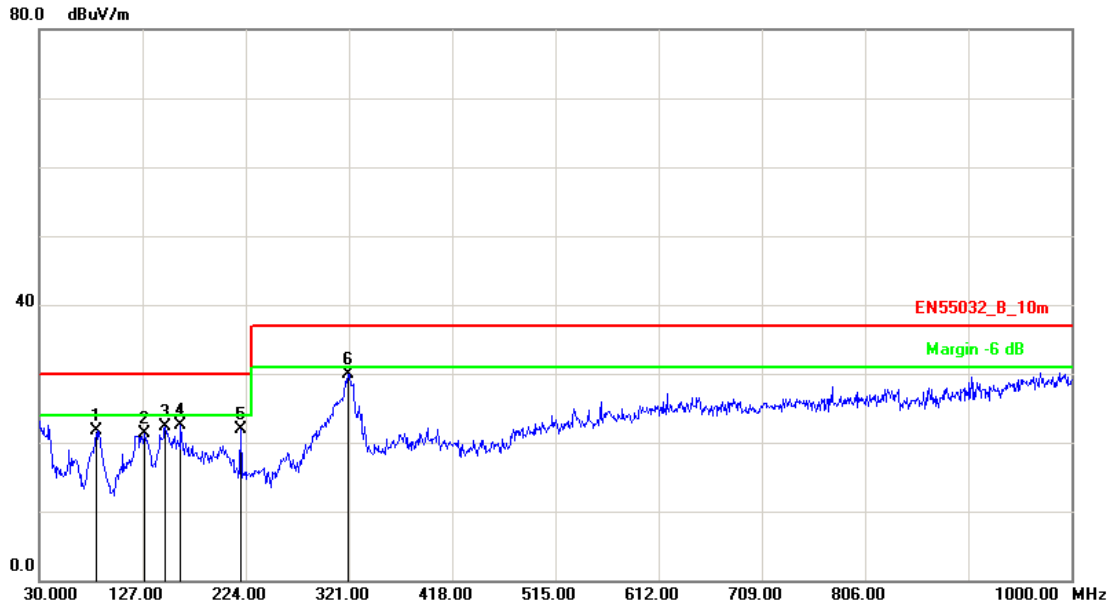

No.	Frequency (MHz)	Factor (dB/m)	Reading (dBuV)	Level (dBuV/m)	Limit (dBuV/m)	Margin (dB)	Det.	Height (cm)	Azimuth (deg)
1	84.3198	-16.27	38.05	21.78	30.00	-8.22	peak	100	96
2	128.9398	-9.94	31.27	21.33	30.00	-8.67	peak	200	48
3	148.3400	-10.60	32.82	22.22	30.00	-7.78	peak	400	0
4	162.8899	-10.95	33.48	22.53	30.00	-7.47	peak	100	227
5	219.1500	-11.84	33.75	21.91	30.00	-8.09	peak	100	269
6	320.0298	-8.02	37.96	29.94	37.00	-7.06	peak	100	15

Note: Measurement Level = Reading Level + Correct Factor



Test Mode :	Mode 13: Full system (HDMI 1 mode 1920*1080@240Hz) for Horizontal (110V/60Hz)		
AC Power :	AC 110V/60Hz	Ant. Polarization:	Horizontal
Equipment :	LCD Monitor	Model No :	250LM00005
Temperature :	26°C	Humidity :	56%
Pressure(mbar) :	1001	Date:	2016/09/11

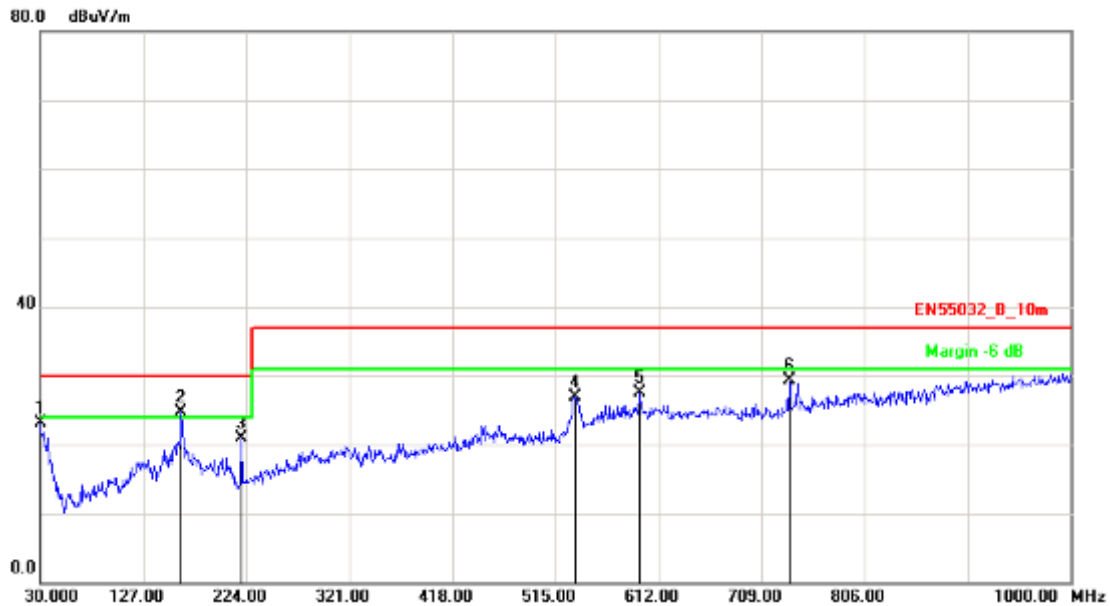

No.	Frequency (MHz)	Factor (dB/m)	Reading (dBuV)	Level (dBuV/m)	Limit (dBuV/m)	Margin (dB)	Det.	Height (cm)	Azimuth (deg)
1	30.0000	-3.26	26.31	23.05	30.00	-6.95	peak	100	84
2	162.8899	-10.95	35.59	24.64	30.00	-5.36	peak	100	255
3	219.1500	-11.84	32.79	20.95	30.00	-9.05	peak	400	315
4	534.3999	-2.33	29.28	26.95	37.00	-10.05	peak	100	9
5	594.5398	-1.32	28.73	27.41	37.00	-9.59	peak	400	267
6	736.1598	0.75	28.53	29.28	37.00	-7.72	peak	100	14

Note: Measurement Level = Reading Level + Correct Factor



Test Mode :	Mode 13: Full system (HDMI 1 mode 1920*1080@240Hz) for Horizontal (110V/60Hz)		
AC Power :	AC 110V/60Hz	Ant. Polarization:	Vertical
Equipment :	LCD Monitor	Model No :	250LM00005
Temperature :	26°C	Humidity :	56%
Pressure(mbar) :	1001	Date:	2016/09/11

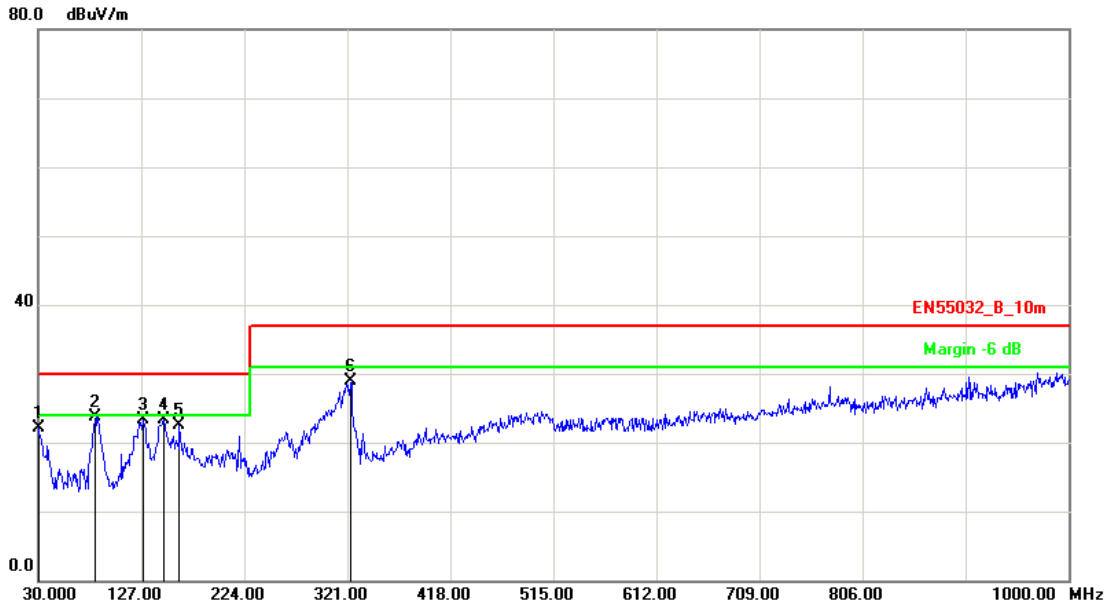

No.	Frequency (MHz)	Factor (dB/m)	Reading (dBuV)	Level (dBuV/m)	Limit (dBuV/m)	Margin (dB)	Det.	Height (cm)	Azimuth (deg)
1	30.0000	-3.26	25.27	22.01	30.00	-7.99	peak	200	360
2	84.3198	-16.27	40.05	23.78	30.00	-6.22	peak	200	360
3	128.9398	-9.94	33.27	23.33	30.00	-6.67	peak	100	215
4	148.3400	-10.60	33.82	23.22	30.00	-6.78	peak	400	48
5	162.8899	-10.95	33.48	22.53	30.00	-7.47	peak	100	189
6	324.8798	-7.97	36.89	28.92	37.00	-8.08	peak	400	0

Note: Measurement Level = Reading Level + Correct Factor



Test Mode :	Mode 17: Full system (HDMI 2 mode 1920*1080@240Hz) for Horizontal (110V/60Hz)		
AC Power :	AC 110V/60Hz	Ant. Polarization:	Horizontal
Equipment :	LCD Monitor	Model No :	250LM00005
Temperature :	26°C	Humidity :	56%
Pressure(mbar) :	1001	Date:	2016/09/11

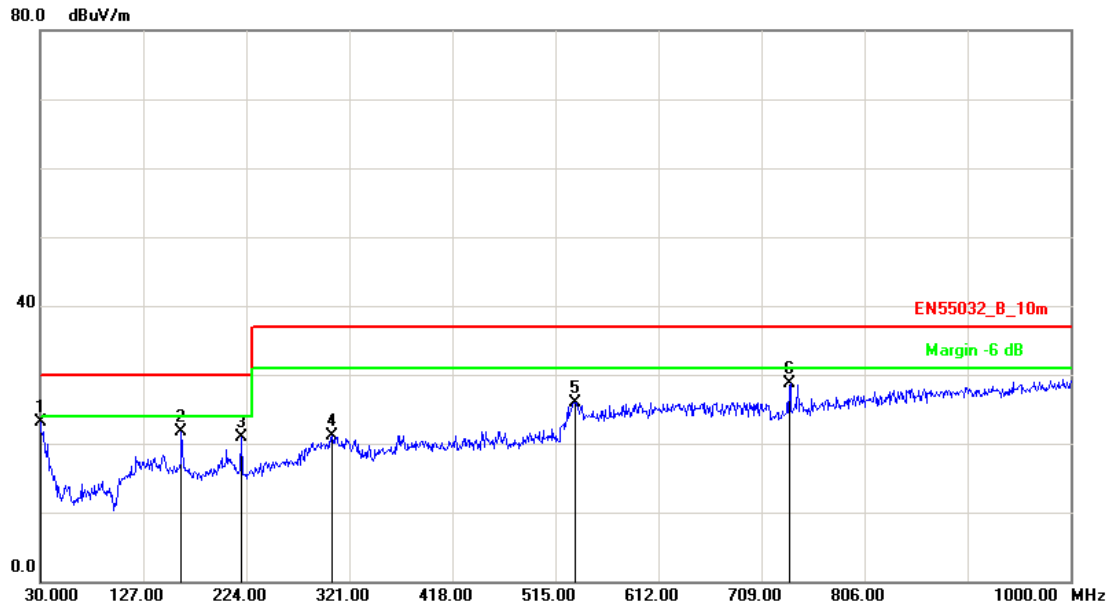

No.	Frequency (MHz)	Factor (dB/m)	Reading (dBuV)	Level (dBuV/m)	Limit (dBuV/m)	Margin (dB)	Det.	Height (cm)	Azimuth (deg)
1	30.0000	-3.26	26.31	23.05	30.00	-6.95	peak	400	130
2	162.8899	-10.95	32.59	21.64	30.00	-8.36	peak	100	37
3	219.1500	-11.84	32.79	20.95	30.00	-9.05	peak	400	48
4	304.5099	-8.59	29.60	21.01	37.00	-15.99	peak	100	62
5	533.4298	-2.35	28.35	26.00	37.00	-11.00	peak	100	0
6	736.1598	0.75	28.03	28.78	37.00	-8.22	peak	400	294

Note: Measurement Level = Reading Level + Correct Factor





Test Mode :	Mode 17: Full system (HDMI 2 mode 1920*1080@240Hz) for Horizontal (110V/60Hz)		
AC Power :	AC 110V/60Hz	Ant. Polarization:	Vertical
Equipment :	LCD Monitor	Model No :	250LM00005
Temperature :	26°C	Humidity :	56%
Pressure(mbar) :	1001	Date:	2016/09/11

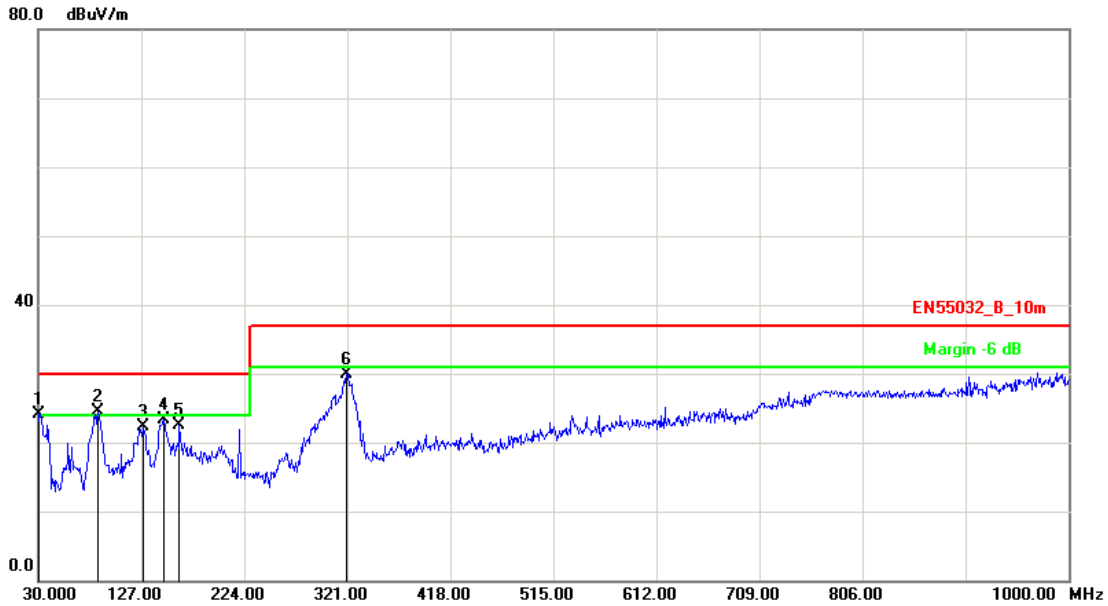

No.	Frequency (MHz)	Factor (dB/m)	Reading (dBuV)	Level (dBuV/m)	Limit (dBuV/m)	Margin (dB)	Det.	Height (cm)	Azimuth (deg)
1	30.9699	-3.96	28.13	24.17	30.00	-5.83	peak	100	252
2	86.2600	-16.28	40.82	24.54	30.00	-5.46	peak	100	116
3	128.9398	-9.94	32.27	22.33	30.00	-7.67	peak	100	164
4	148.3400	-10.60	33.82	23.22	30.00	-6.78	peak	100	29
5	162.8899	-10.95	33.48	22.53	30.00	-7.47	peak	100	0
6	320.0298	-8.02	37.96	29.94	37.00	-7.06	peak	400	48

Note: Measurement Level = Reading Level + Correct Factor



Test Mode :	Mode 23: Full system (VGA mode 1920*1080@240Hz) for Horizontal (230V/50Hz)		
AC Power :	AC 230V/50Hz	Ant. Polarization:	Horizontal
Equipment :	LCD Monitor	Model No :	250LM00005
Temperature :	26°C	Humidity :	56%
Pressure(mbar) :	1001	Date:	2016/09/11

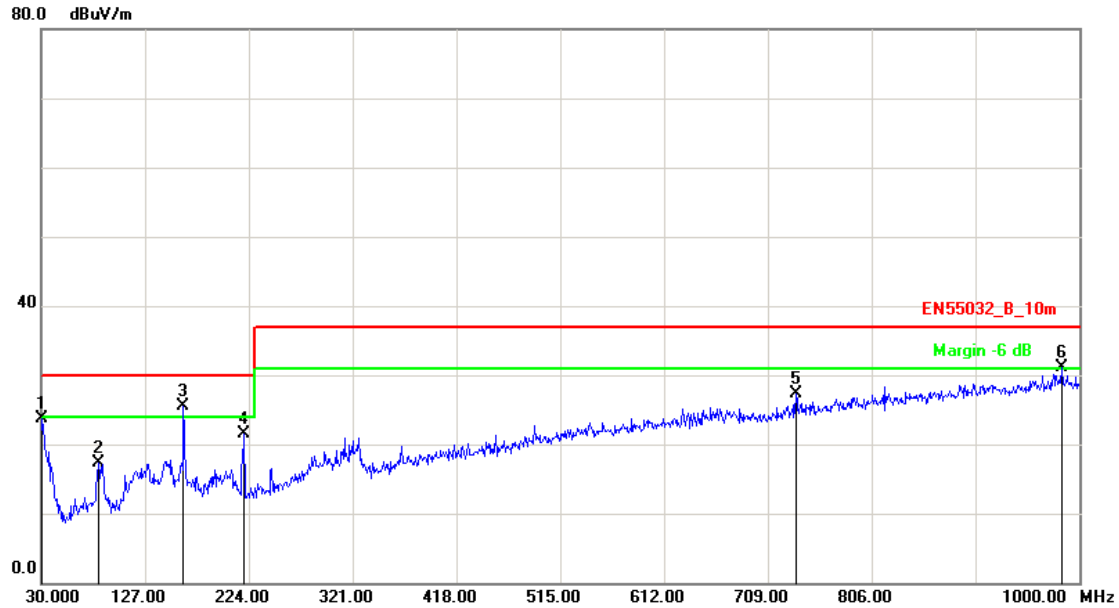

No.	Frequency (MHz)	Factor (dB/m)	Reading (dBuV)	Level (dBuV/m)	Limit (dBuV/m)	Margin (dB)	Det.	Height (cm)	Azimuth (deg)
1	30.9699	-3.96	27.63	23.67	30.00	-6.33	peak	100	0
2	83.3499	-16.26	33.57	17.31	30.00	-12.69	peak	100	0
3	162.8899	-10.95	38.05	27.10	30.00	-4.01	peak	400	113
4	219.1500	-11.84	33.32	21.48	30.00	-8.52	peak	400	302
5	735.1900	0.73	26.61	27.34	37.00	-9.66	peak	100	202
6	983.5099	4.78	26.32	31.10	37.00	-5.90	peak	100	131

Note: Measurement Level = Reading Level + Correct Factor



Test Mode :	Mode 23: Full system (VGA mode 1920*1080@240Hz) for Horizontal (230V/50Hz)		
AC Power :	AC 230V/50Hz	Ant. Polarization:	Vertical
Equipment :	LCD Monitor	Model No :	250LM00005
Temperature :	26°C	Humidity :	56%
Pressure(mbar) :	1001	Date:	2016/09/11

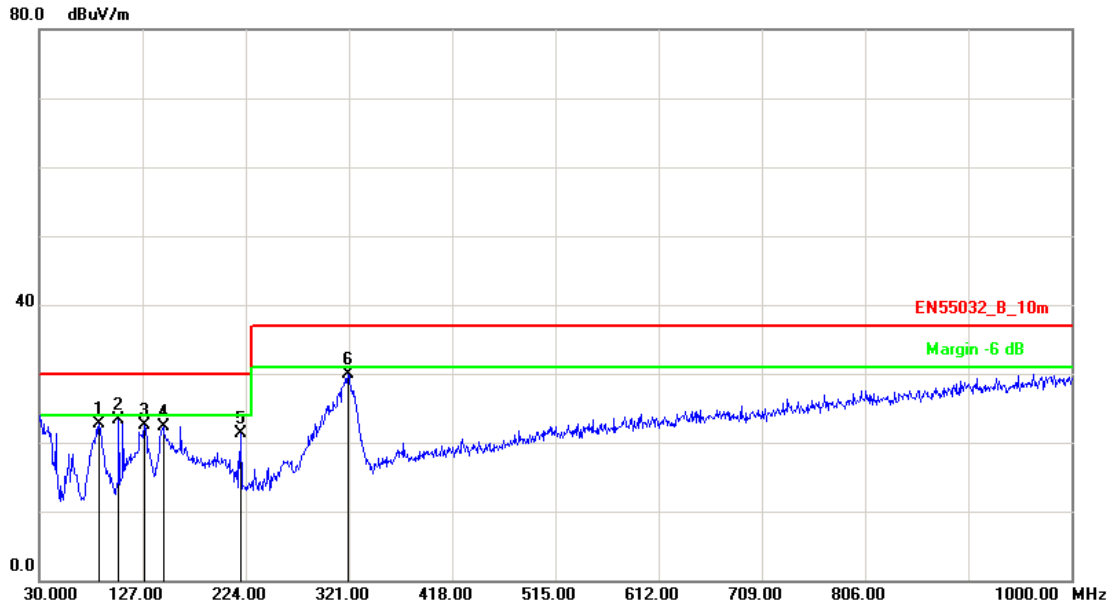

No.	Frequency (MHz)	Factor (dB/m)	Reading (dBuV)	Level (dBuV/m)	Limit (dBuV/m)	Margin (dB)	Det.	Height (cm)	Azimuth (deg)
1	86.2600	-16.28	38.90	22.62	30.00	-7.38	peak	100	0
2	104.6900	-12.80	36.17	23.37	30.00	-6.63	peak	400	274
3	128.9399	-9.94	32.37	22.43	30.00	-7.57	peak	100	326
4	146.4000	-10.56	32.85	22.29	30.00	-7.71	peak	400	315
5	219.1500	-11.84	33.12	21.28	30.00	-8.72	peak	100	136
6	320.0300	-8.02	37.93	29.91	37.00	-7.09	peak	100	189

Note: Measurement Level = Reading Level + Correct Factor



Test Mode :	Mode 27: Full system (Display mode 1920*1080@240Hz) for Horizontal (230V/50Hz)		
AC Power :	AC 230V/50Hz	Ant. Polarization:	Horizontal
Equipment :	LCD Monitor	Model No :	250LM00005
Temperature :	26°C	Humidity :	56%
Pressure(mbar) :	1001	Date:	2016/09/11

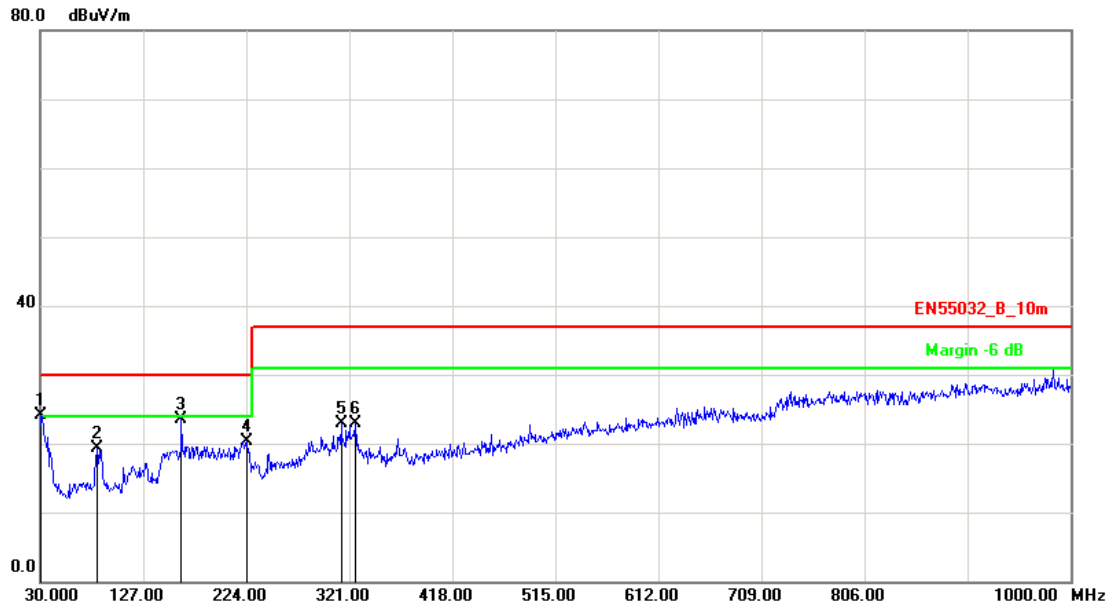

No.	Frequency (MHz)	Factor (dB/m)	Reading (dBuV)	Level (dBuV/m)	Limit (dBuV/m)	Margin (dB)	Det.	Height (cm)	Azimuth (deg)
1	30.9699	-3.96	28.13	24.17	30.00	-5.83	peak	400	0
2	83.3499	-16.26	35.57	19.31	30.00	-10.69	peak	200	0
3	162.8899	-10.95	34.55	23.60	30.00	-6.40	peak	100	157
4	224.0000	-11.71	32.03	20.32	30.00	-9.68	peak	100	21
5	313.2400	-8.27	31.20	22.93	37.00	-14.07	peak	100	58
6	326.8199	-7.94	30.90	22.96	37.00	-14.04	peak	100	236

Note: Measurement Level = Reading Level + Correct Factor



Test Mode :	Mode 27: Full system (Display mode 1920*1080@240Hz) for Horizontal (230V/50Hz)		
AC Power :	AC 230V/50Hz	Ant. Polarization:	Vertical
Equipment :	LCD Monitor	Model No :	250LM00005
Temperature :	26°C	Humidity :	56%
Pressure(mbar) :	1001	Date:	2016/09/11

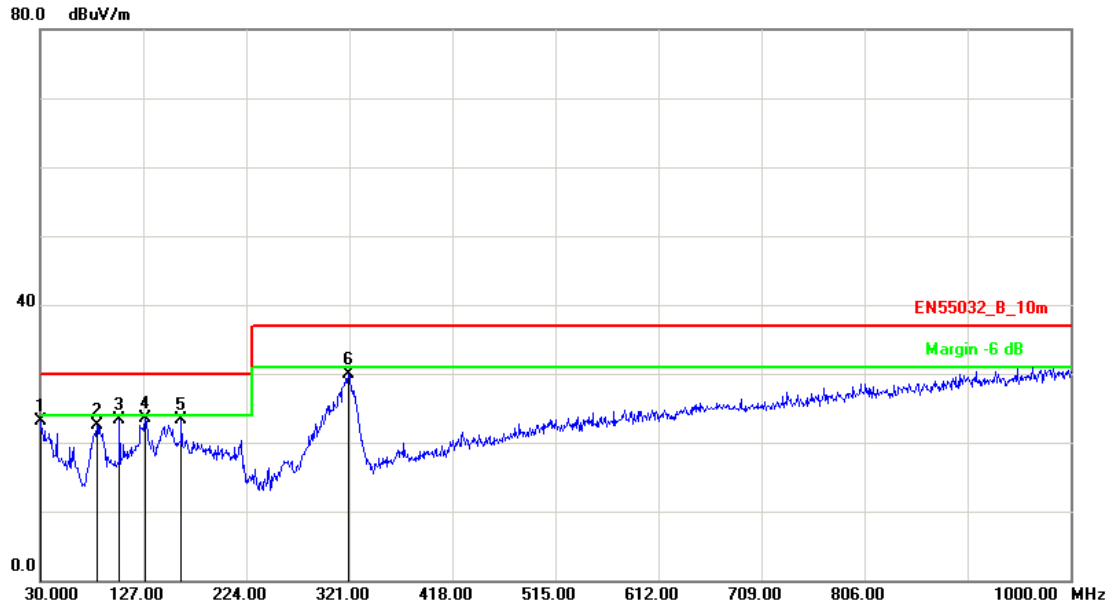

No.	Frequency (MHz)	Factor (dB/m)	Reading (dBuV)	Level (dBuV/m)	Limit (dBuV/m)	Margin (dB)	Det.	Height (cm)	Azimuth (deg)
1	30.0000	-3.26	26.28	23.02	30.00	-6.98	peak	400	162
2	83.3499	-16.26	38.80	22.54	30.00	-7.46	peak	400	7
3	104.6899	-12.80	36.17	23.37	30.00	-6.63	peak	100	294
4	128.9398	-9.94	33.37	23.43	30.00	-6.57	peak	100	360
5	162.8899	-10.95	34.24	23.29	30.00	-6.71	peak	100	182
6	320.0298	-8.02	37.93	29.91	37.00	-7.09	peak	100	33

Note: Measurement Level = Reading Level + Correct Factor



Test Mode :	Mode 31: Full system (DVI mode 1920*1080@240Hz) for Horizontal (230V/50Hz)		
AC Power :	AC 230V/50Hz	Ant. Polarization:	Horizontal
Equipment :	LCD Monitor	Model No :	250LM00005
Temperature :	26°C	Humidity :	56%
Pressure(mbar) :	1001	Date:	2016/09/11

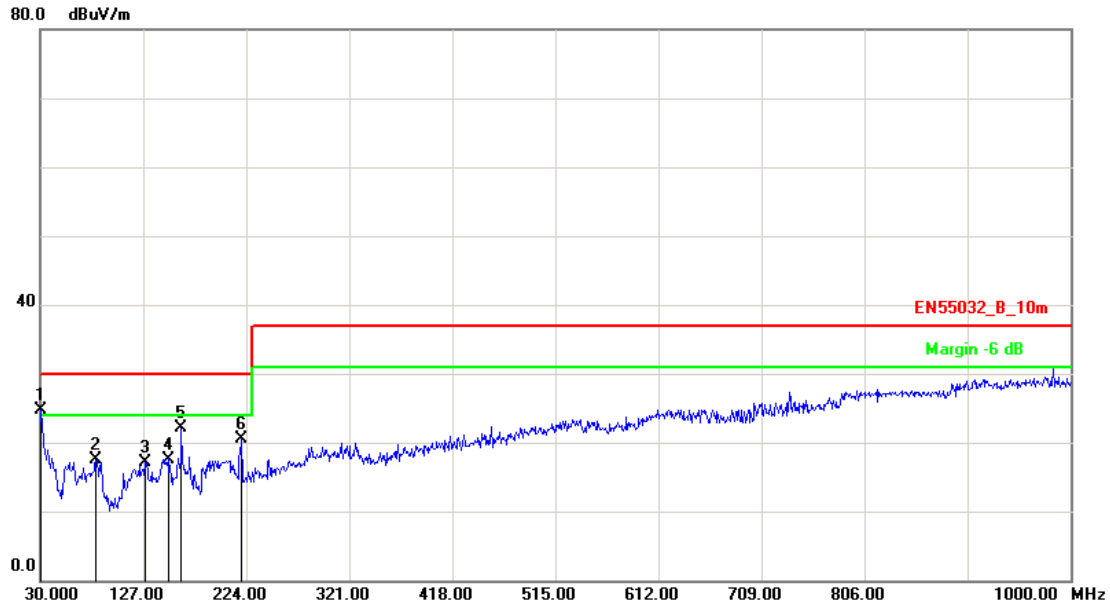

No.	Frequency (MHz)	Factor (dB/m)	Reading (dBuV)	Level (dBuV/m)	Limit (dBuV/m)	Margin (dB)	Det.	Height (cm)	Azimuth (deg)
1	30.9699	-3.96	28.63	24.67	30.00	-5.33	peak	100	118
2	82.3799	-16.26	33.79	17.53	30.00	-12.47	peak	400	29
3	128.9398	-9.94	27.07	17.13	30.00	-12.87	peak	100	62
4	150.2800	-10.65	28.25	17.60	30.00	-12.40	peak	400	41
5	162.8899	-10.95	33.05	22.10	30.00	-7.90	peak	100	326
6	219.1500	-11.84	32.32	20.48	30.00	-9.52	peak	100	0

Note: Measurement Level = Reading Level + Correct Factor



Test Mode :	Mode 31: Full system (DVI mode 1920*1080@240Hz) for Horizontal (230V/50Hz)		
AC Power :	AC 230V/50Hz	Ant. Polarization:	Vertical
Equipment :	LCD Monitor	Model No :	250LM00005
Temperature :	26°C	Humidity :	56%
Pressure(mbar) :	1001	Date:	2016/09/11

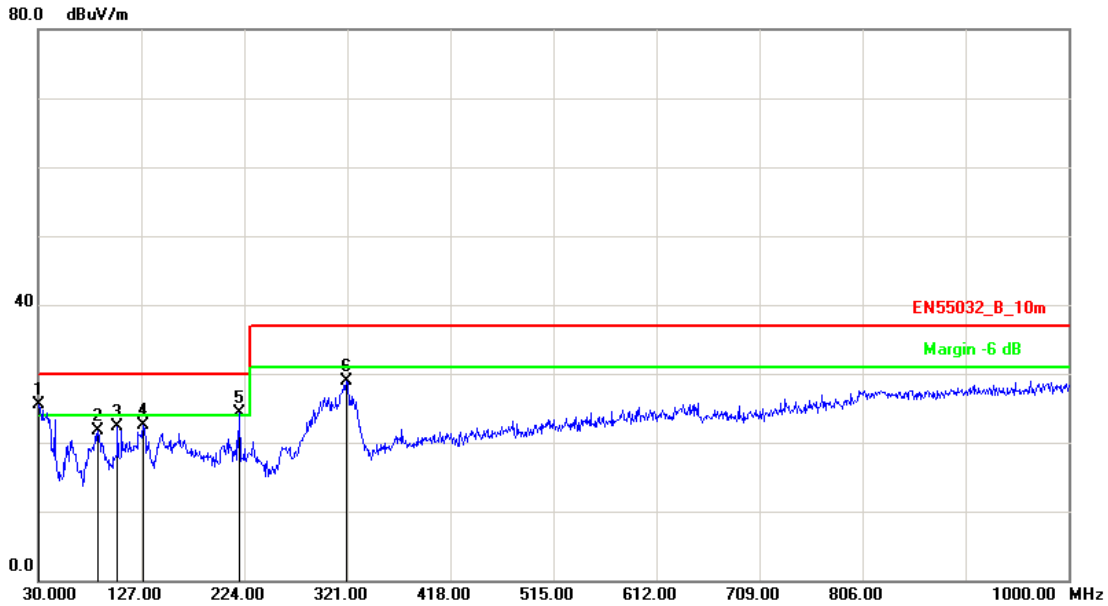

No.	Frequency (MHz)	Factor (dB/m)	Reading (dBuV)	Level (dBuV/m)	Limit (dBuV/m)	Margin (dB)	Det.	Height (cm)	Azimuth (deg)
1	30.9699	-3.96	29.45	25.49	30.00	-4.51	peak	400	216
2	86.2600	-16.28	37.90	21.62	30.00	-8.38	peak	400	29
3	104.6899	-12.80	35.17	22.37	30.00	-7.63	peak	400	0
4	128.9398	-9.94	32.37	22.43	30.00	-7.57	peak	100	148
5	219.1500	-11.84	36.12	24.28	30.00	-5.72	peak	100	211
6	320.0298	-8.02	36.93	28.91	37.00	-8.09	peak	100	326

Note: Measurement Level = Reading Level + Correct Factor



Test Mode :	Mode 35: Full system (HDMI 1 mode 1920*1080@240Hz) for Horizontal (230V/50Hz)		
AC Power :	AC 230V/50Hz	Ant. Polarization:	Horizontal
Equipment :	LCD Monitor	Model No :	250LM00005
Temperature :	26°C	Humidity :	56%
Pressure(mbar) :	1001	Date:	2016/09/11

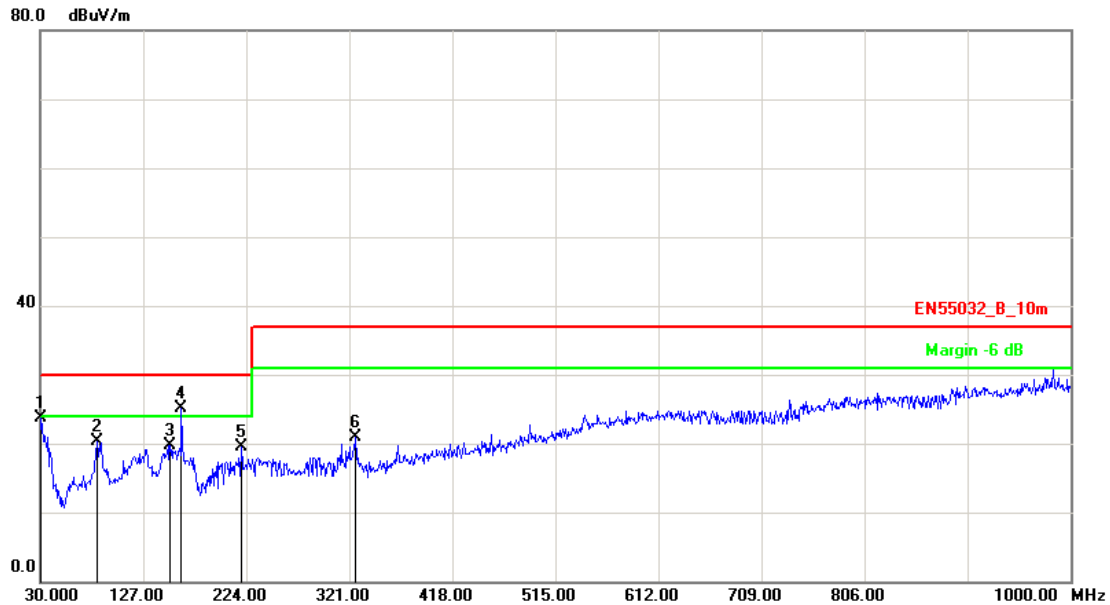

No.	Frequency (MHz)	Factor (dB/m)	Reading (dBuV)	Level (dBuV/m)	Limit (dBuV/m)	Margin (dB)	Det.	Height (cm)	Azimuth (deg)
1	30.9699	-3.96	27.63	23.67	30.00	-6.33	peak	100	316
2	83.3499	-16.26	36.57	20.31	30.00	-9.69	peak	100	341
3	152.2198	-10.69	30.43	19.74	30.00	-10.26	peak	400	187
4	162.8899	-10.95	36.05	25.10	30.00	-4.90	peak	400	0
5	219.1500	-11.84	31.32	19.48	30.00	-10.52	peak	100	26
6	326.8199	-7.94	28.90	20.96	37.00	-16.04	peak	400	115

Note: Measurement Level = Reading Level + Correct Factor





Test Mode :	Mode 35: Full system (HDMI 1 mode 1920*1080@240Hz) for Horizontal (230V/50Hz)		
AC Power :	AC 230V/50Hz	Ant. Polarization:	Vertical
Equipment :	LCD Monitor	Model No :	250LM00005
Temperature :	26°C	Humidity :	56%
Pressure(mbar) :	1001	Date:	2016/09/11

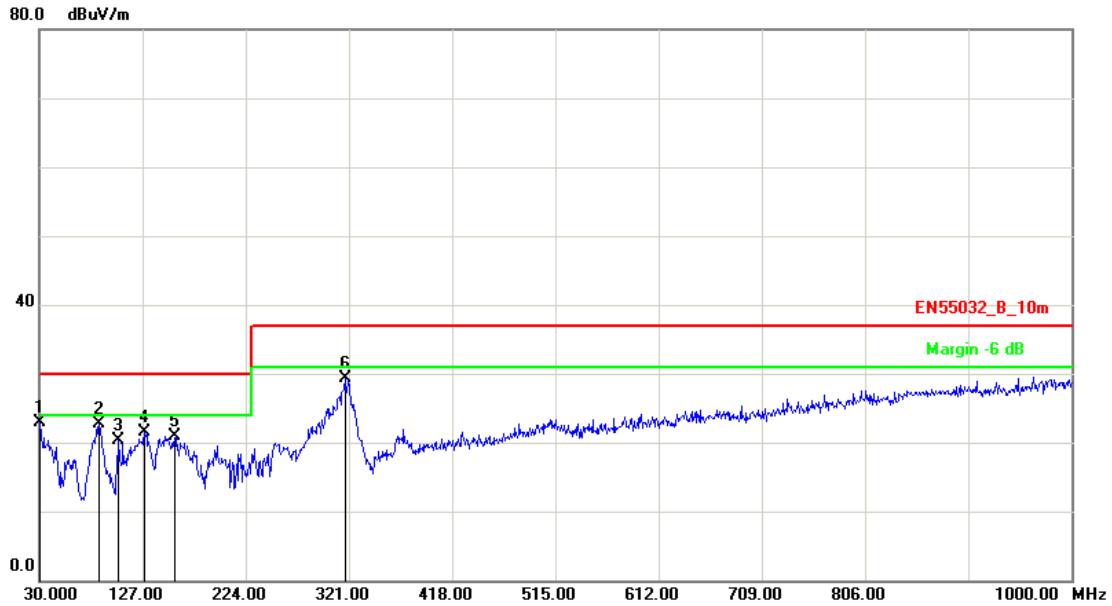

No.	Frequency (MHz)	Factor (dB/m)	Reading (dBuV)	Level (dBuV/m)	Limit (dBuV/m)	Margin (dB)	Det.	Height (cm)	Azimuth (deg)
1	30.9699	-3.96	26.95	22.99	30.00	-7.01	peak	100	49
2	86.2600	-16.28	38.90	22.62	30.00	-7.38	peak	100	30
3	104.6899	-12.80	33.17	20.37	30.00	-9.63	peak	400	87
4	128.9398	-9.94	31.37	21.43	30.00	-8.57	peak	100	218
5	158.0399	-10.82	31.74	20.92	30.00	-9.08	peak	400	217
6	317.1200	-8.13	37.36	29.23	37.00	-7.77	peak	200	6

Note: Measurement Level = Reading Level + Correct Factor



Test Mode :	Mode 39: Full system (HDMI 2 mode 1920*1080@240Hz) for Horizontal (230V/50Hz)		
AC Power :	AC 230V/50Hz	Ant. Polarization:	Horizontal
Equipment :	LCD Monitor	Model No :	250LM00005
Temperature :	26°C	Humidity :	56%
Pressure(mbar) :	1001	Date:	2016/09/11

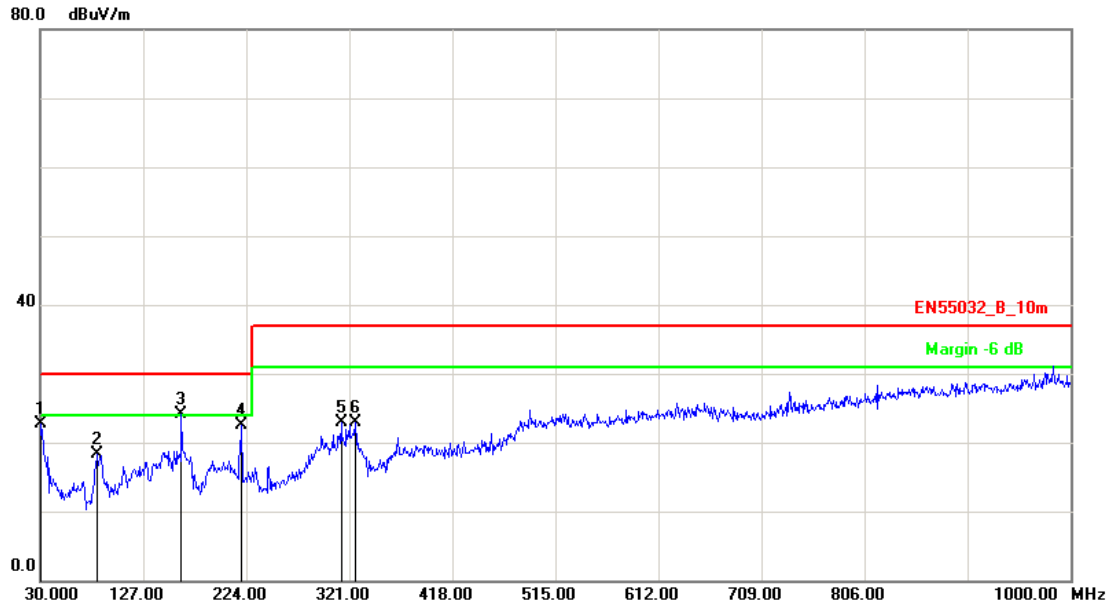

No.	Frequency (MHz)	Factor (dB/m)	Reading (dBuV)	Level (dBuV/m)	Limit (dBuV/m)	Margin (dB)	Det.	Height (cm)	Azimuth (deg)
1	30.9699	-3.96	26.63	22.67	30.00	-7.33	peak	100	74
2	83.3499	-16.26	34.57	18.31	30.00	-11.69	peak	400	89
3	162.8899	-10.95	35.05	24.10	30.00	-5.90	peak	400	115
4	219.1500	-11.84	34.32	22.48	30.00	-7.52	peak	400	24
5	313.2400	-8.27	31.20	22.93	37.00	-14.07	peak	100	306
6	326.8199	-7.94	30.90	22.96	37.00	-14.04	peak	100	1

Note: Measurement Level = Reading Level + Correct Factor



Test Mode :	Mode 39: Full system (HDMI 2 mode 1920*1080@240Hz) for Horizontal (230V/50Hz)		
AC Power :	AC 230V/50Hz	Ant. Polarization:	Vertical
Equipment :	LCD Monitor	Model No :	250LM00005
Temperature :	26°C	Humidity :	56%
Pressure(mbar) :	1001	Date:	2016/09/11

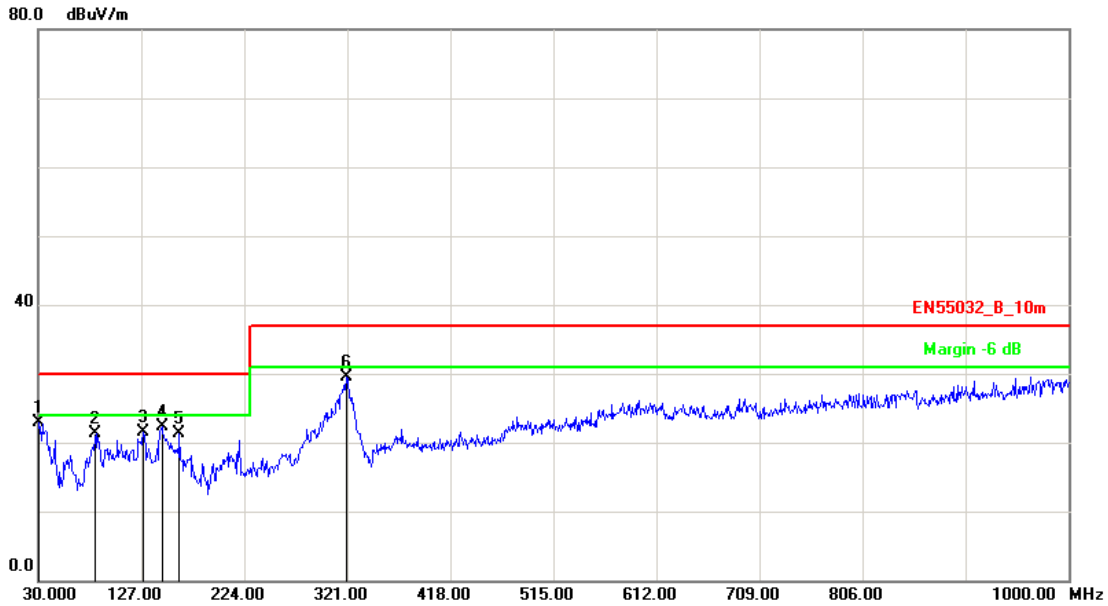

No.	Frequency (MHz)	Factor (dB/m)	Reading (dBuV)	Level (dBuV/m)	Limit (dBuV/m)	Margin (dB)	Det.	Height (cm)	Azimuth (deg)
1	30.9699	-3.96	26.95	22.99	30.00	-7.01	peak	400	229
2	84.3198	-16.27	37.57	21.30	30.00	-8.70	peak	400	314
3	128.9398	-9.94	31.37	21.43	30.00	-8.57	peak	100	51
4	146.4000	-10.56	32.85	22.29	30.00	-7.71	peak	100	15
5	162.8899	-10.95	32.24	21.29	30.00	-8.71	peak	100	268
6	320.0298	-8.02	37.43	29.41	37.00	-7.59	peak	100	0

Note: Measurement Level = Reading Level + Correct Factor



5.6. Test Result and Data (1GHz ~ 6GHz)

Test Mode :	Mode 1: Full system (VGA mode 1920*1080@240Hz) for Horizontal (110V/60Hz)		
AC Power :	AC 110V/60Hz	Ant. Polarization:	Horizontal
Equipment :	LCD Monitor	Model No :	250LM00005
Temperature :	26°C	Humidity :	56%
Pressure(mbar) :	1001	Date:	2016/09/11

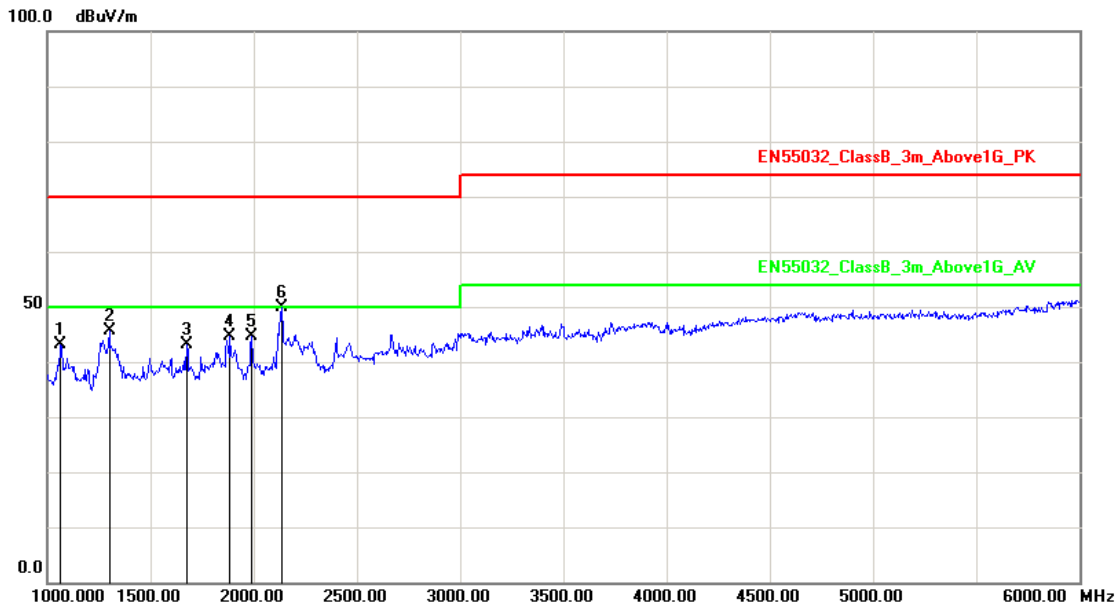

No.	Frequency (MHz)	Factor (dB/m)	Reading (dBuV)	Level (dBuV/m)	Limit (dBuV/m)	Margin (dB)	Det.	Height (cm)	Azimuth (deg)
1	1065.000	-5.55	48.61	43.06	70.00	-26.94	peak	200	21
2	1300.000	-3.98	49.68	45.70	70.00	-24.30	peak	200	268
3	1675.000	-2.14	45.24	43.10	70.00	-26.90	peak	100	0
4	1885.000	-1.53	46.14	44.61	70.00	-25.39	peak	200	112
5	1990.000	-1.23	45.95	44.72	70.00	-25.28	peak	200	9
6	2135.000	-0.51	50.41	49.90	70.00	-20.10	peak	100	341

Note: Measurement Level = Reading Level + Correct Factor



Test Mode :	Mode 1: Full system (VGA mode 1920*1080@240Hz) for Horizontal (110V/60Hz)		
AC Power :	AC 110V/60Hz	Ant. Polarization:	Vertical
Equipment :	LCD Monitor	Model No :	250LM00005
Temperature :	26°C	Humidity :	56%
Pressure(mbar) :	1001	Date:	2016/09/11

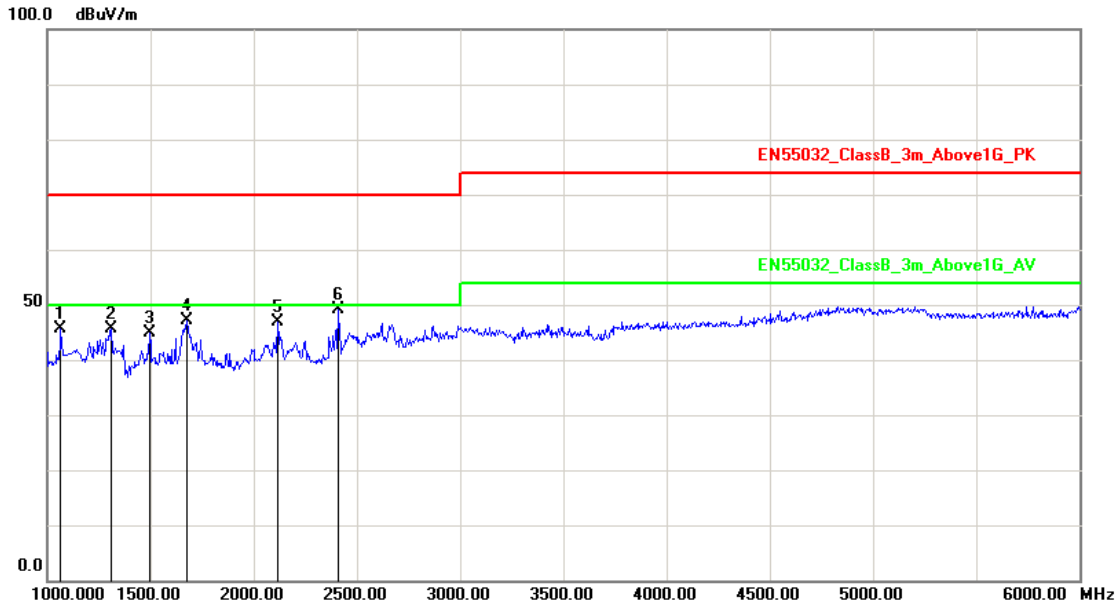

No.	Frequency (MHz)	Factor (dB/m)	Reading (dBuV)	Level (dBuV/m)	Limit (dBuV/m)	Margin (dB)	Det.	Height (cm)	Azimuth (deg)
1	1065.000	-5.55	51.24	45.69	70.00	-24.31	peak	200	226
2	1310.000	-3.91	49.47	45.56	70.00	-24.44	peak	100	32
3	1495.000	-2.67	47.61	44.94	70.00	-25.06	peak	100	316
4	1675.000	-2.14	49.32	47.18	70.00	-22.82	peak	100	71
5	2115.000	-0.61	47.54	46.93	70.00	-23.07	peak	200	41
6	2410.000	0.89	48.26	49.15	70.00	-20.85	peak	100	63

Note: Measurement Level = Reading Level + Correct Factor



Test Mode :	Mode 5: Full system (Display mode 1920*1080@240Hz) for Horizontal (110V/60Hz)		
AC Power :	AC 110V/60Hz	Ant. Polarization:	Horizontal
Equipment :	LCD Monitor	Model No :	250LM00005
Temperature :	26°C	Humidity :	56%
Pressure(mbar) :	1001	Date:	2016/09/11

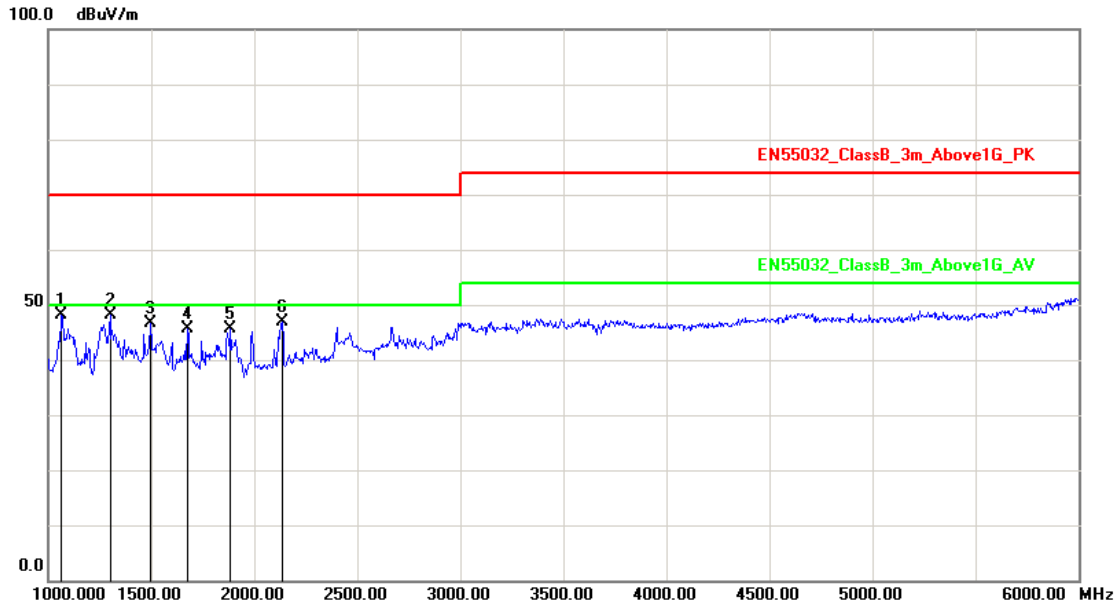

No.	Frequency (MHz)	Factor (dB/m)	Reading (dBuV)	Level (dBuV/m)	Limit (dBuV/m)	Margin (dB)	Det.	Height (cm)	Azimuth (deg)
1	1065.000	-5.55	53.61	48.06	70.00	-21.94	peak	200	162
2	1300.000	-3.98	52.18	48.20	70.00	-21.80	peak	200	354
3	1495.000	-2.67	49.29	46.62	70.00	-23.38	peak	100	9
4	1675.000	-2.14	47.74	45.60	70.00	-24.40	peak	200	4
5	1885.000	-1.53	47.14	45.61	70.00	-24.39	peak	100	336
6	2135.000	-0.51	47.41	46.90	70.00	-23.10	peak	200	210

Note: Measurement Level = Reading Level + Correct Factor



Test Mode :	Mode 5: Full system (Display mode 1920*1080@240Hz) for Horizontal (110V/60Hz)		
AC Power :	AC 110V/60Hz	Ant. Polarization:	Vertical
Equipment :	LCD Monitor	Model No :	250LM00005
Temperature :	26°C	Humidity :	56%
Pressure(mbar) :	1001	Date:	2016/09/11

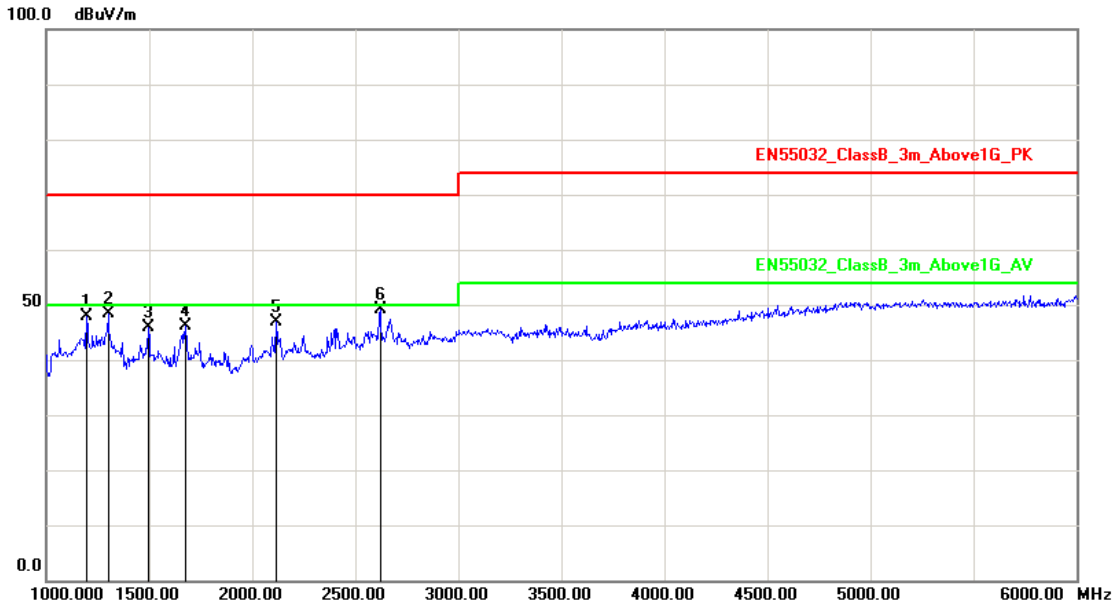

No.	Frequency (MHz)	Factor (dB/m)	Reading (dBuV)	Level (dBuV/m)	Limit (dBuV/m)	Margin (dB)	Det.	Height (cm)	Azimuth (deg)
1	1195.000	-4.68	52.65	47.97	70.00	-22.03	peak	200	0
2	1300.000	-3.98	52.38	48.40	70.00	-21.60	peak	100	0
3	1495.000	-2.67	48.61	45.94	70.00	-24.06	peak	200	351
4	1675.000	-2.14	48.32	46.18	70.00	-23.82	peak	200	48
5	2115.000	-0.61	47.54	46.93	70.00	-23.07	peak	100	351
6	2620.000	2.01	47.13	49.14	70.00	-20.86	peak	100	62

Note: Measurement Level = Reading Level + Correct Factor



Test Mode :	Mode 9: Full system (DVI mode 1920*1080@240Hz) for Horizontal (110V/60Hz)		
AC Power :	AC 110V/60Hz	Ant. Polarization:	Horizontal
Equipment :	LCD Monitor	Model No :	250LM00005
Temperature :	26°C	Humidity :	56%
Pressure(mbar) :	1001	Date:	2016/09/11

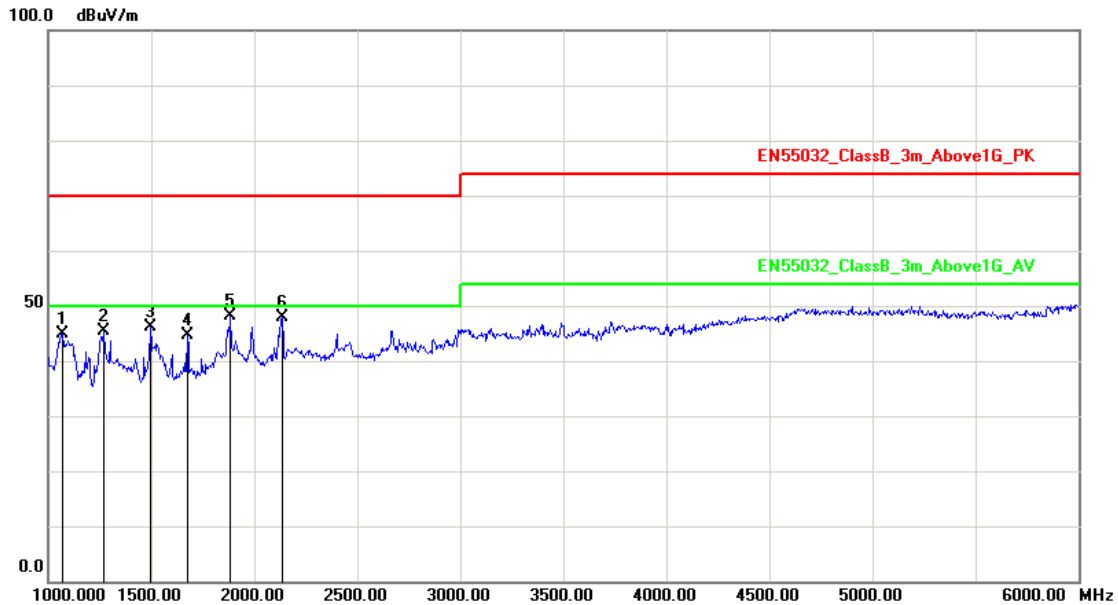

No.	Frequency (MHz)	Factor (dB/m)	Reading (dBuV)	Level (dBuV/m)	Limit (dBuV/m)	Margin (dB)	Det.	Height (cm)	Azimuth (deg)
1	1070.000	-5.51	50.46	44.95	70.00	-25.05	peak	100	125
2	1270.000	-4.18	49.45	45.27	70.00	-24.73	peak	200	8
3	1495.000	-2.67	48.79	46.12	70.00	-23.88	peak	100	226
4	1675.000	-2.14	46.74	44.60	70.00	-25.40	peak	200	354
5	1885.000	-1.53	49.64	48.11	70.00	-21.89	peak	200	41
6	2135.000	-0.51	48.41	47.90	70.00	-22.10	peak	100	321

Note: Measurement Level = Reading Level + Correct Factor





Test Mode :	Mode 9: Full system (DVI mode 1920*1080@240Hz) for Horizontal (110V/60Hz)		
AC Power :	AC 110V/60Hz	Ant. Polarization:	Vertical
Equipment :	LCD Monitor	Model No :	250LM00005
Temperature :	26°C	Humidity :	56%
Pressure(mbar) :	1001	Date:	2016/09/11

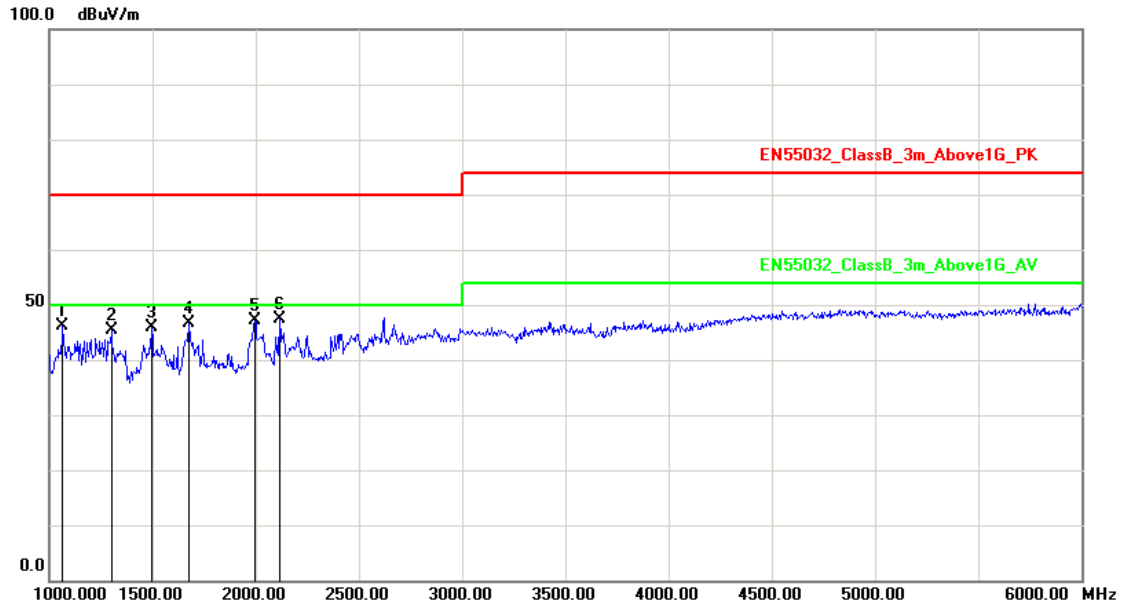

No.	Frequency (MHz)	Factor (dB/m)	Reading (dBuV)	Level (dBuV/m)	Limit (dBuV/m)	Margin (dB)	Det.	Height (cm)	Azimuth (deg)
1	1065.000	-5.55	51.74	46.19	70.00	-23.81	peak	100	21
2	1300.000	-3.98	49.38	45.40	70.00	-24.60	peak	200	158
3	1495.000	-2.67	48.61	45.94	70.00	-24.06	peak	100	112
4	1675.000	-2.14	48.82	46.68	70.00	-23.32	peak	100	54
5	1995.000	-1.21	48.40	47.19	70.00	-22.81	peak	200	263
6	2115.000	-0.61	48.04	47.43	70.00	-22.57	peak	200	360

Note: Measurement Level = Reading Level + Correct Factor



Test Mode :	Mode 13: Full system (HDMI 1 mode 1920*1080@240Hz) for Horizontal (110V/60Hz)		
AC Power :	AC 110V/60Hz	Ant. Polarization:	Horizontal
Equipment :	LCD Monitor	Model No :	250LM00005
Temperature :	26°C	Humidity :	56%
Pressure(mbar) :	1001	Date:	2016/09/11

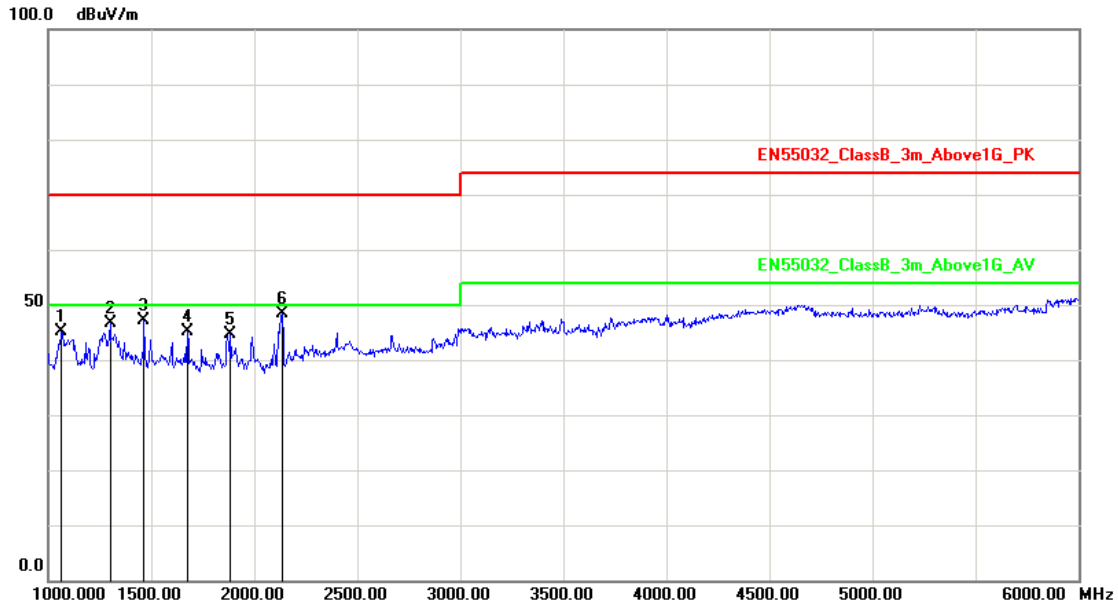

No.	Frequency (MHz)	Factor (dB/m)	Reading (dBuV)	Level (dBuV/m)	Limit (dBuV/m)	Margin (dB)	Det.	Height (cm)	Azimuth (deg)
1	1065.000	-5.55	50.61	45.06	70.00	-24.94	peak	100	114
2	1300.000	-3.98	50.68	46.70	70.00	-23.30	peak	200	62
3	1465.000	-2.87	50.10	47.23	70.00	-22.77	peak	100	57
4	1675.000	-2.14	47.24	45.10	70.00	-24.90	peak	100	16
5	1885.000	-1.53	46.14	44.61	70.00	-25.39	peak	100	286
6	2135.000	-0.51	48.91	48.40	70.00	-21.60	peak	100	328

Note: Measurement Level = Reading Level + Correct Factor



Test Mode :	Mode 13: Full system (HDMI 1 mode 1920*1080@240Hz) for Horizontal (110V/60Hz)		
AC Power :	AC 110V/60Hz	Ant. Polarization:	Vertical
Equipment :	LCD Monitor	Model No :	250LM00005
Temperature :	26°C	Humidity :	56%
Pressure(mbar) :	1001	Date:	2016/09/11

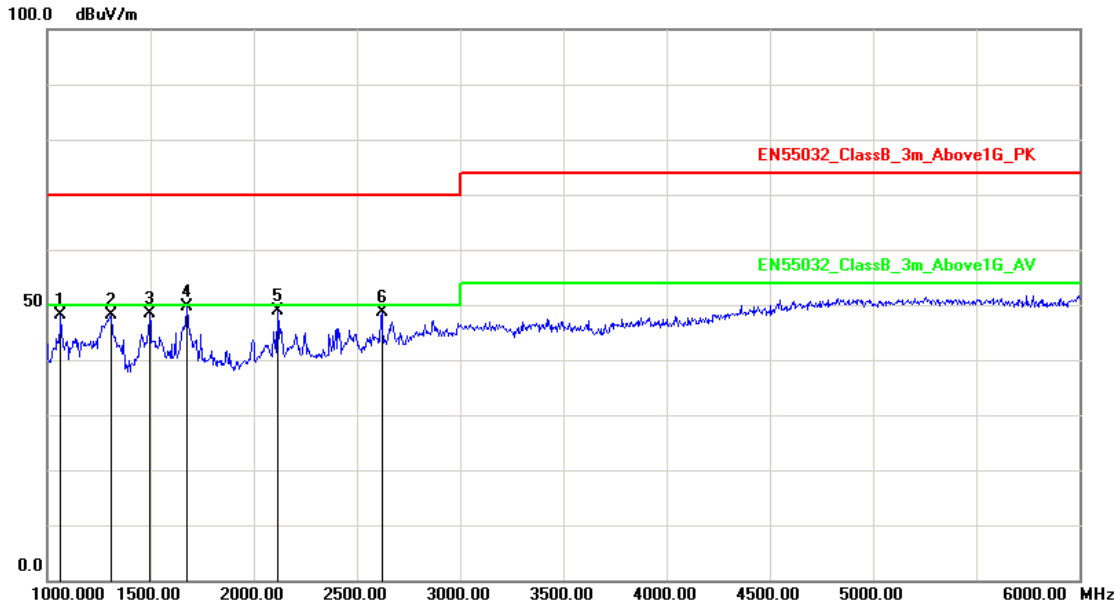

No.	Frequency (MHz)	Factor (dB/m)	Reading (dBuV)	Level (dBuV/m)	Limit (dBuV/m)	Margin (dB)	Det.	Height (cm)	Azimuth (deg)
1	1065.000	-5.55	53.74	48.19	70.00	-21.81	peak	100	87
2	1310.000	-3.91	51.97	48.06	70.00	-21.94	peak	200	263
3	1495.000	-2.67	51.11	48.44	70.00	-21.56	peak	100	115
4	1675.000	-2.14	51.82	49.68	70.00	-20.32	peak	100	241
5	2115.000	-0.61	49.54	48.93	70.00	-21.07	peak	100	44
6	2620.000	2.01	46.63	48.64	70.00	-21.36	peak	200	352

Note: Measurement Level = Reading Level + Correct Factor



Test Mode :	Mode 17: Full system (HDMI 2 mode 1920*1080@240Hz) for Horizontal (110V/60Hz)		
AC Power :	AC 110V/60Hz	Ant. Polarization:	Horizontal
Equipment :	LCD Monitor	Model No :	250LM00005
Temperature :	26°C	Humidity :	56%
Pressure(mbar) :	1001	Date:	2016/09/11

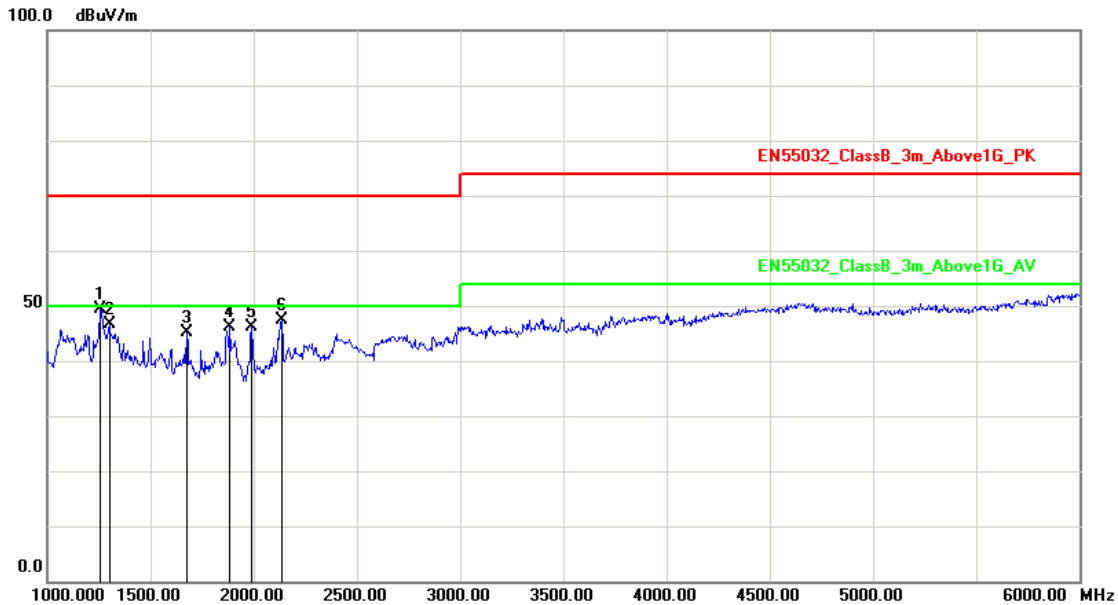

No.	Frequency (MHz)	Factor (dB/m)	Reading (dBuV)	Level (dBuV/m)	Limit (dBuV/m)	Margin (dB)	Det.	Height (cm)	Azimuth (deg)
1	1255.000	-4.28	53.61	49.33	70.00	-20.67	peak	100	302
2	1300.000	-3.98	50.68	46.70	70.00	-23.30	peak	200	196
3	1675.000	-2.14	47.24	45.10	70.00	-24.90	peak	100	87
4	1885.000	-1.53	47.64	46.11	70.00	-23.89	peak	100	241
5	1990.000	-1.23	47.45	46.22	70.00	-23.78	peak	100	35
6	2135.000	-0.51	47.91	47.40	70.00	-22.60	peak	200	116

Note: Measurement Level = Reading Level + Correct Factor



Test Mode :	Mode 17: Full system (HDMI 2 mode 1920*1080@240Hz) for Horizontal (110V/60Hz)		
AC Power :	AC 110V/60Hz	Ant. Polarization:	Vertical
Equipment :	LCD Monitor	Model No :	250LM00005
Temperature :	26°C	Humidity :	56%
Pressure(mbar) :	1001	Date:	2016/09/11

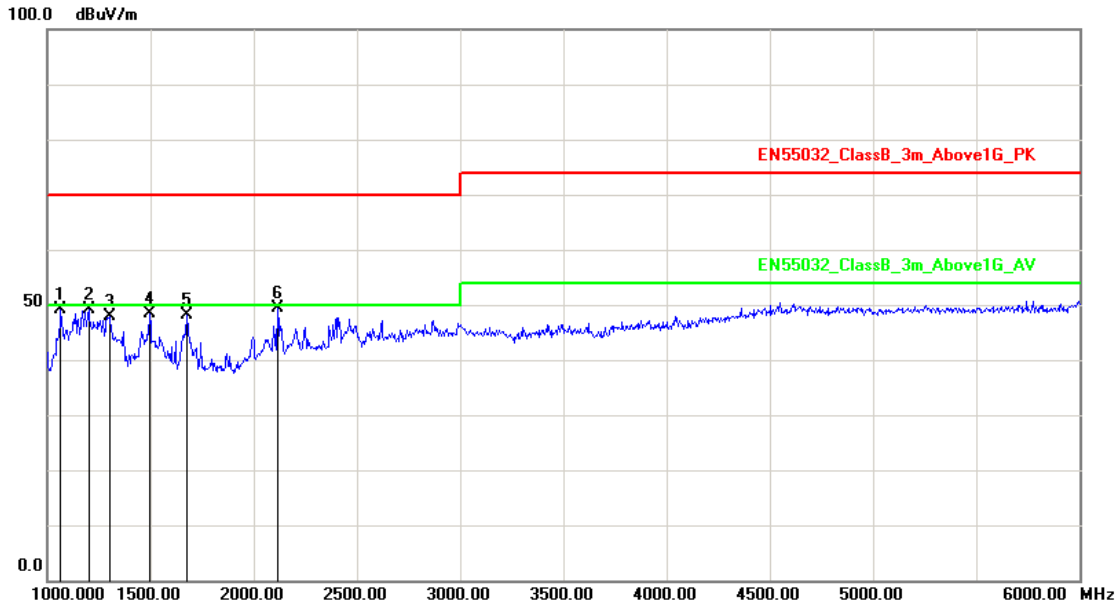

No.	Frequency (MHz)	Factor (dB/m)	Reading (dBuV)	Level (dBuV/m)	Limit (dBuV/m)	Margin (dB)	Det.	Height (cm)	Azimuth (deg)
1	1065.000	-5.55	54.74	49.19	70.00	-20.81	peak	200	332
2	1200.000	-4.64	53.86	49.22	70.00	-20.78	peak	100	216
3	1300.000	-3.98	51.88	47.90	70.00	-22.10	peak	200	2
4	1495.000	-2.67	51.11	48.44	70.00	-21.56	peak	100	201
5	1675.000	-2.14	50.32	48.18	70.00	-21.82	peak	200	154
6	2115.000	-0.61	50.04	49.43	70.00	-20.57	peak	100	39

Note: Measurement Level = Reading Level + Correct Factor



Test Mode :	Mode 23: Full system (VGA mode 1920*1080@240Hz) for Horizontal (230V/50Hz)		
AC Power :	AC 230V/50Hz	Ant. Polarization:	Horizontal
Equipment :	LCD Monitor	Model No :	250LM00005
Temperature :	26°C	Humidity :	56%
Pressure(mbar) :	1001	Date:	2016/09/11

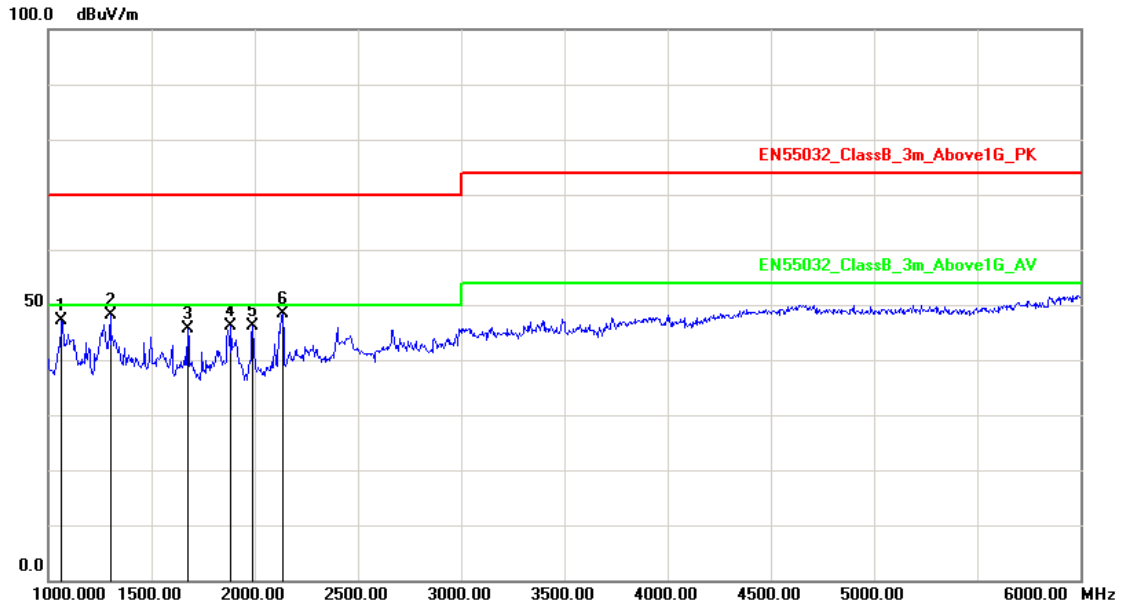

No.	Frequency (MHz)	Factor (dB/m)	Reading (dBuV)	Level (dBuV/m)	Limit (dBuV/m)	Margin (dB)	Det.	Height (cm)	Azimuth (deg)
1	1065.000	-5.55	52.61	47.06	70.00	-22.94	peak	200	112
2	1300.000	-3.98	52.18	48.20	70.00	-21.80	peak	200	329
3	1675.000	-2.14	47.74	45.60	70.00	-24.40	peak	100	0
4	1885.000	-1.53	47.64	46.11	70.00	-23.89	peak	100	54
5	1990.000	-1.23	47.45	46.22	70.00	-23.78	peak	200	35
6	2135.000	-0.51	48.91	48.40	70.00	-21.60	peak	200	61

Note: Measurement Level = Reading Level + Correct Factor



Test Mode :	Mode 23: Full system (VGA mode 1920*1080@240Hz) for Horizontal (230V/50Hz)		
AC Power :	AC 230V/50Hz	Ant. Polarization:	Vertical
Equipment :	LCD Monitor	Model No :	250LM00005
Temperature :	26°C	Humidity :	56%
Pressure(mbar) :	1001	Date:	2016/09/11

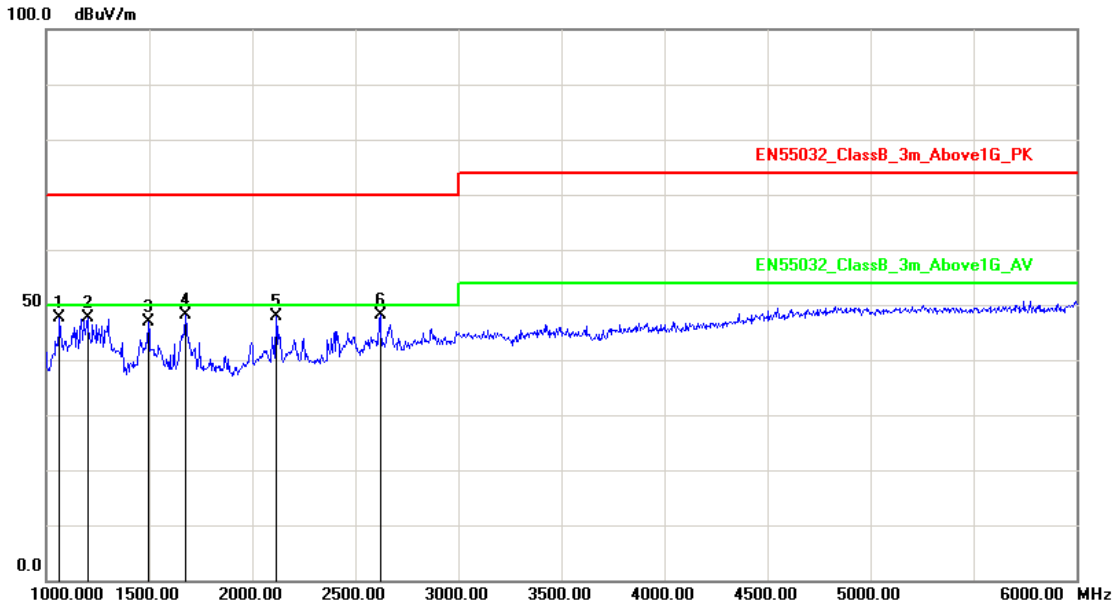

No.	Frequency (MHz)	Factor (dB/m)	Reading (dBuV)	Level (dBuV/m)	Limit (dBuV/m)	Margin (dB)	Det.	Height (cm)	Azimuth (deg)
1	1065.000	-5.55	53.24	47.69	70.00	-22.31	peak	200	26
2	1200.000	-4.64	52.36	47.72	70.00	-22.28	peak	100	41
3	1495.000	-2.67	49.61	46.94	70.00	-23.06	peak	100	338
4	1675.000	-2.14	50.32	48.18	70.00	-21.82	peak	100	216
5	2115.000	-0.61	48.54	47.93	70.00	-22.07	peak	200	35
6	2620.000	2.01	46.13	48.14	70.00	-21.86	peak	100	297

Note: Measurement Level = Reading Level + Correct Factor



Test Mode :	Mode 27: Full system (Display mode 1920*1080@240Hz) for Horizontal (230V/50Hz)		
AC Power :	AC 230V/50Hz	Ant. Polarization:	Horizontal
Equipment :	LCD Monitor	Model No :	250LM00005
Temperature :	26°C	Humidity :	56%
Pressure(mbar) :	1001	Date:	2016/09/11

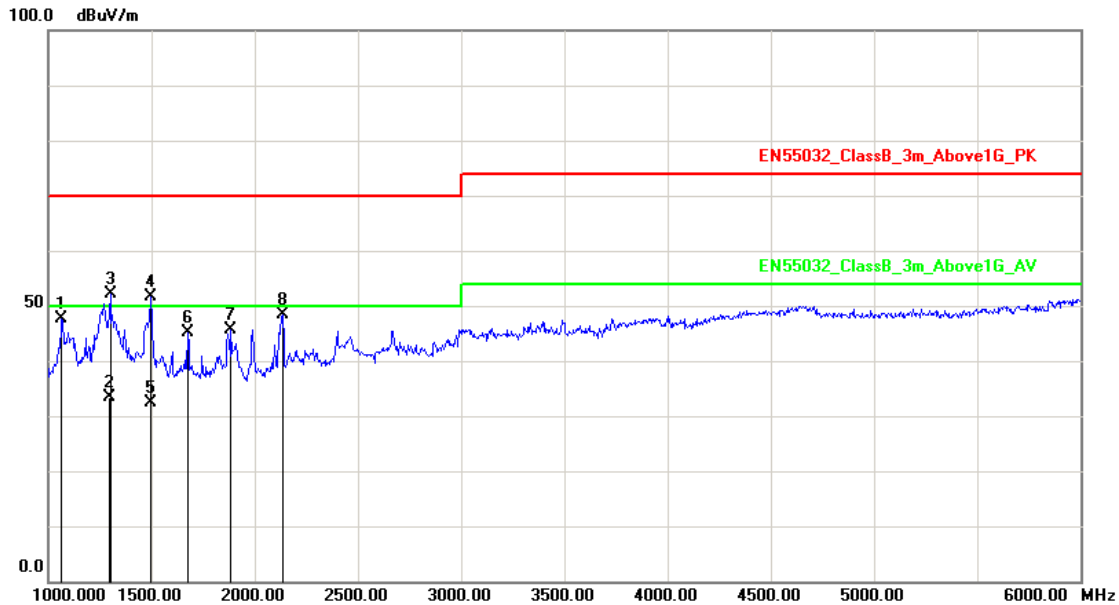

No.	Frequency (MHz)	Factor (dB/m)	Reading (dBuV)	Level (dBuV/m)	Limit (dBuV/m)	Margin (dB)	Det.	Height (cm)	Azimuth (deg)
1	1065.000	-5.55	53.11	47.56	70.00	-22.44	peak	200	327
2	1298.000	-3.99	37.26	33.27	50.00	-16.73	AVG	100	156
3	1300.000	-3.98	56.18	52.20	70.00	-17.80	peak	100	156
4	1495.000	-2.67	54.29	51.62	70.00	-18.38	peak	200	9
5	1496.000	-2.67	35.02	32.35	50.00	-17.65	AVG	200	9
6	1675.000	-2.14	47.24	45.10	70.00	-24.90	peak	100	241
7	1885.000	-1.53	47.14	45.61	70.00	-24.39	peak	200	241
8	2135.000	-0.51	48.91	48.40	70.00	-21.60	peak	200	48

Note: Measurement Level = Reading Level + Correct Factor





Test Mode :	Mode 27: Full system (Display mode 1920*1080@240Hz) for Horizontal (230V/50Hz)		
AC Power :	AC 230V/50Hz	Ant. Polarization:	Vertical
Equipment :	LCD Monitor	Model No :	250LM00005
Temperature :	26°C	Humidity :	56%
Pressure(mbar) :	1001	Date:	2016/09/11

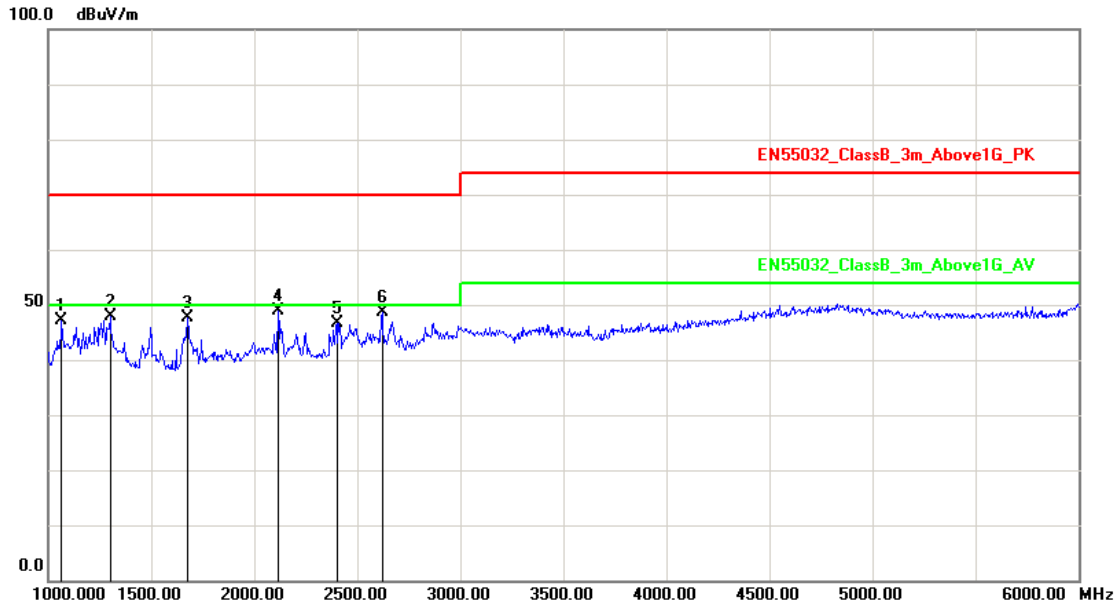

No.	Frequency (MHz)	Factor (dB/m)	Reading (dBuV)	Level (dBuV/m)	Limit (dBuV/m)	Margin (dB)	Det.	Height (cm)	Azimuth (deg)
1	1065.000	-5.55	52.74	47.19	70.00	-22.81	peak	100	92
2	1300.000	-3.98	51.88	47.90	70.00	-22.10	peak	200	354
3	1675.000	-2.14	49.82	47.68	70.00	-22.32	peak	200	216
4	2115.000	-0.61	49.54	48.93	70.00	-21.07	peak	200	38
5	2400.000	0.84	45.89	46.73	70.00	-23.27	peak	200	0
6	2620.000	2.01	46.63	48.64	70.00	-21.36	peak	200	47

Note: Measurement Level = Reading Level + Correct Factor



Test Mode :	Mode 31: Full system (DVI mode 1920*1080@240Hz) for Horizontal (230V/50Hz)		
AC Power :	AC 230V/50Hz	Ant. Polarization:	Horizontal
Equipment :	LCD Monitor	Model No :	250LM00005
Temperature :	26°C	Humidity :	56%
Pressure(mbar) :	1001	Date:	2016/09/11

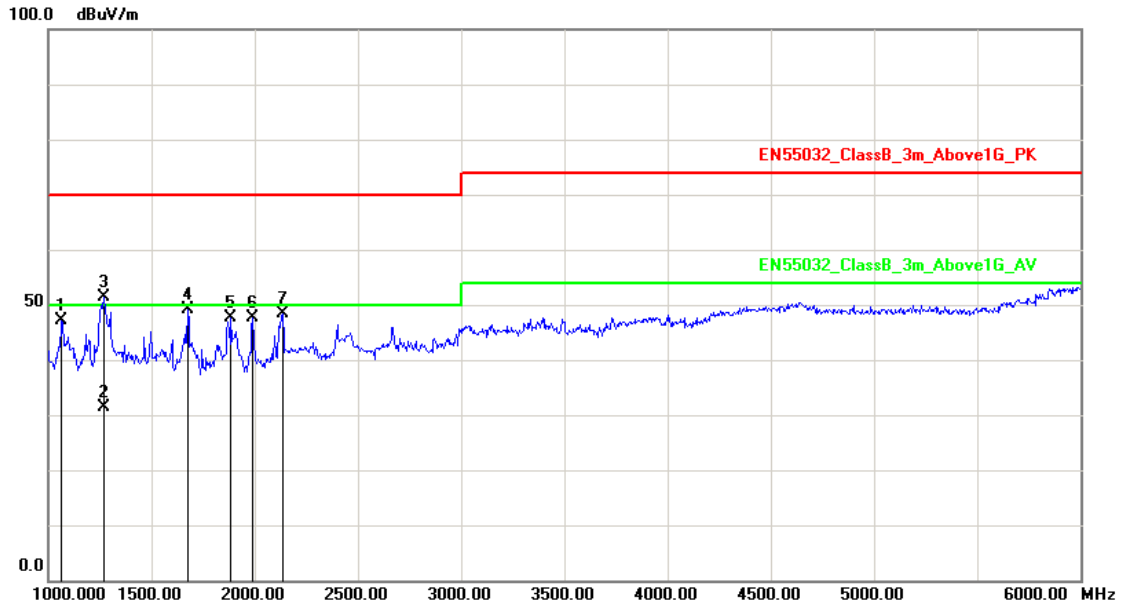

No.	Frequency (MHz)	Factor (dB/m)	Reading (dBuV)	Level (dBuV/m)	Limit (dBuV/m)	Margin (dB)	Det.	Height (cm)	Azimuth (deg)
1	1065.000	-5.55	52.61	47.06	70.00	-22.94	peak	100	9
2	1269.000	-4.18	35.58	31.40	50.00	-18.60	AVG	100	65
3	1270.000	-4.18	55.45	51.27	70.00	-18.73	peak	100	65
4	1675.000	-2.14	51.24	49.10	70.00	-20.90	peak	200	34
5	1885.000	-1.53	49.14	47.61	70.00	-22.39	peak	200	287
6	1990.000	-1.23	48.95	47.72	70.00	-22.28	peak	100	153
7	2135.000	-0.51	48.91	48.40	70.00	-21.60	peak	200	34

Note: Measurement Level = Reading Level + Correct Factor



Test Mode :	Mode 31: Full system (DVI mode 1920*1080@240Hz) for Horizontal (230V/50Hz)		
AC Power :	AC 230V/50Hz	Ant. Polarization:	Vertical
Equipment :	LCD Monitor	Model No :	250LM00005
Temperature :	26°C	Humidity :	56%
Pressure(mbar) :	1001	Date:	2016/09/11

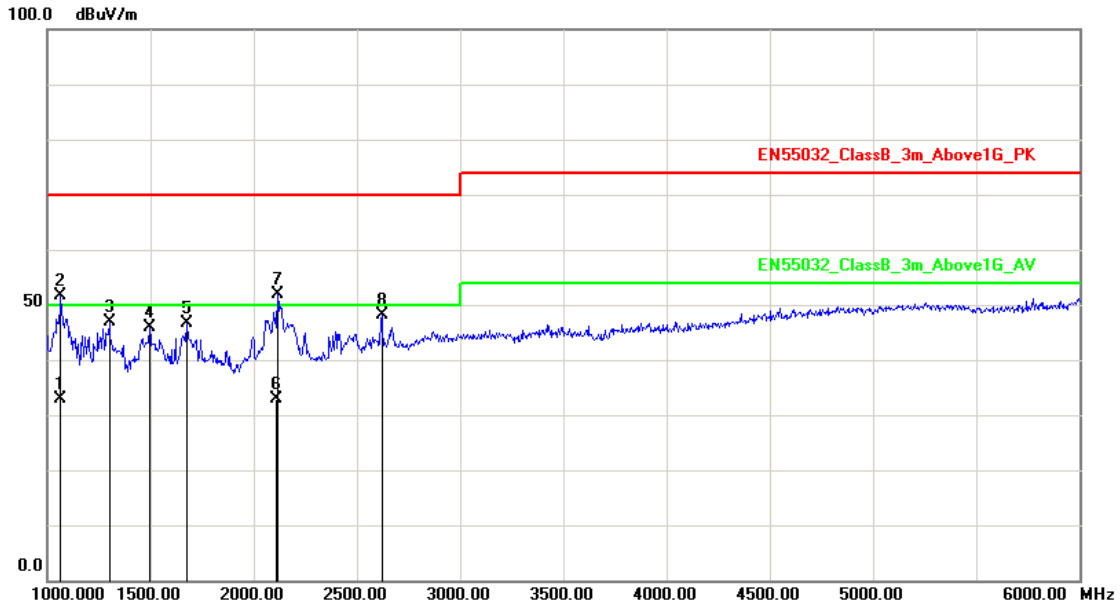

No.	Frequency (MHz)	Factor (dB/m)	Reading (dBuV)	Level (dBuV/m)	Limit (dBuV/m)	Margin (dB)	Det.	Height (cm)	Azimuth (deg)
1	1064.000	-5.55	38.47	32.92	50.00	-17.08	AVG	200	35
2	1065.000	-5.55	57.24	51.69	70.00	-18.31	peak	200	35
3	1300.000	-3.98	50.88	46.90	70.00	-23.10	peak	100	126
4	1495.000	-2.67	48.61	45.94	70.00	-24.06	peak	100	126
5	1675.000	-2.14	48.82	46.68	70.00	-23.32	peak	200	29
6	2113.000	-0.62	33.50	32.88	50.00	-17.12	AVG	100	341
7	2115.000	-0.61	52.54	51.93	70.00	-18.07	peak	100	341
8	2620.000	2.01	46.13	48.14	70.00	-21.86	peak	100	27

Note: Measurement Level = Reading Level + Correct Factor



Test Mode :	Mode 35: Full system (HDMI 1 mode 1920*1080@240Hz) for Horizontal (230V/50Hz)		
AC Power :	AC 230V/50Hz	Ant. Polarization:	Horizontal
Equipment :	LCD Monitor	Model No :	250LM00005
Temperature :	26°C	Humidity :	56%
Pressure(mbar) :	1001	Date:	2016/09/11

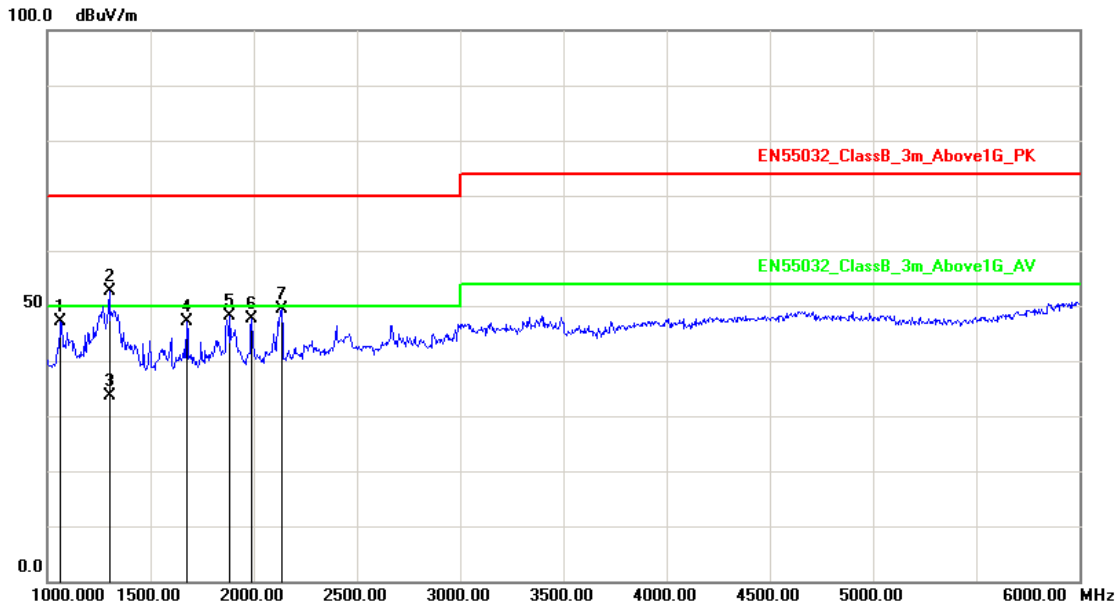

No.	Frequency (MHz)	Factor (dB/m)	Reading (dBuV)	Level (dBuV/m)	Limit (dBuV/m)	Margin (dB)	Det.	Height (cm)	Azimuth (deg)
1	1065.000	-5.55	52.61	47.06	70.00	-22.94	peak	100	357
2	1300.000	-3.98	56.68	52.70	70.00	-17.30	peak	200	51
3	1301.000	-3.97	37.54	33.57	50.00	-16.43	AVG	200	51
4	1675.000	-2.14	49.24	47.10	70.00	-22.90	peak	100	264
5	1885.000	-1.53	49.64	48.11	70.00	-21.89	peak	200	221
6	1990.000	-1.23	48.95	47.72	70.00	-22.28	peak	200	32
7	2135.000	-0.51	49.91	49.40	70.00	-20.60	peak	100	0

Note: Measurement Level = Reading Level + Correct Factor



Test Mode :	Mode 35: Full system (HDMI 1 mode 1920*1080@240Hz) for Horizontal (230V/50Hz)		
AC Power :	AC 230V/50Hz	Ant. Polarization:	Vertical
Equipment :	LCD Monitor	Model No :	250LM00005
Temperature :	26°C	Humidity :	56%
Pressure(mbar) :	1001	Date:	2016/09/11

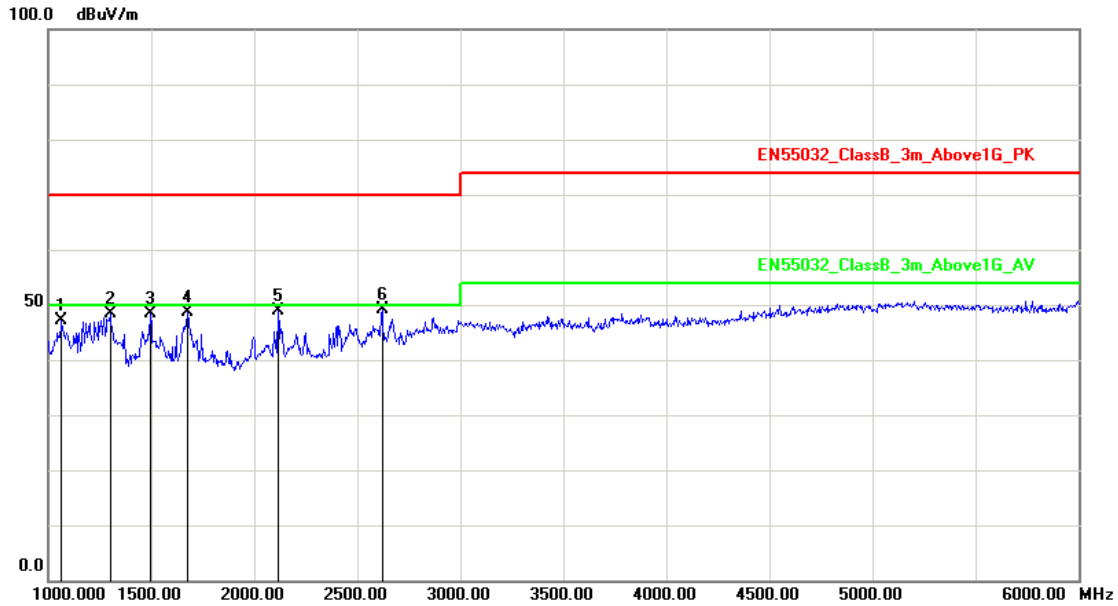

No.	Frequency (MHz)	Factor (dB/m)	Reading (dBuV)	Level (dBuV/m)	Limit (dBuV/m)	Margin (dB)	Det.	Height (cm)	Azimuth (deg)
1	1065.000	-5.55	52.74	47.19	70.00	-22.81	peak	100	114
2	1300.000	-3.98	52.38	48.40	70.00	-21.60	peak	200	38
3	1495.000	-2.67	51.11	48.44	70.00	-21.56	peak	200	6
4	1675.000	-2.14	50.82	48.68	70.00	-21.32	peak	200	219
5	2115.000	-0.61	49.54	48.93	70.00	-21.07	peak	100	32
6	2620.000	2.01	47.13	49.14	70.00	-20.86	peak	200	0

Note: Measurement Level = Reading Level + Correct Factor



Test Mode :	Mode 39: Full system (HDMI 2 mode 1920*1080@240Hz) for Horizontal (230V/50Hz)		
AC Power :	AC 230V/50Hz	Ant. Polarization:	Horizontal
Equipment :	LCD Monitor	Model No :	250LM00005
Temperature :	26°C	Humidity :	56%
Pressure(mbar) :	1001	Date:	2016/09/11

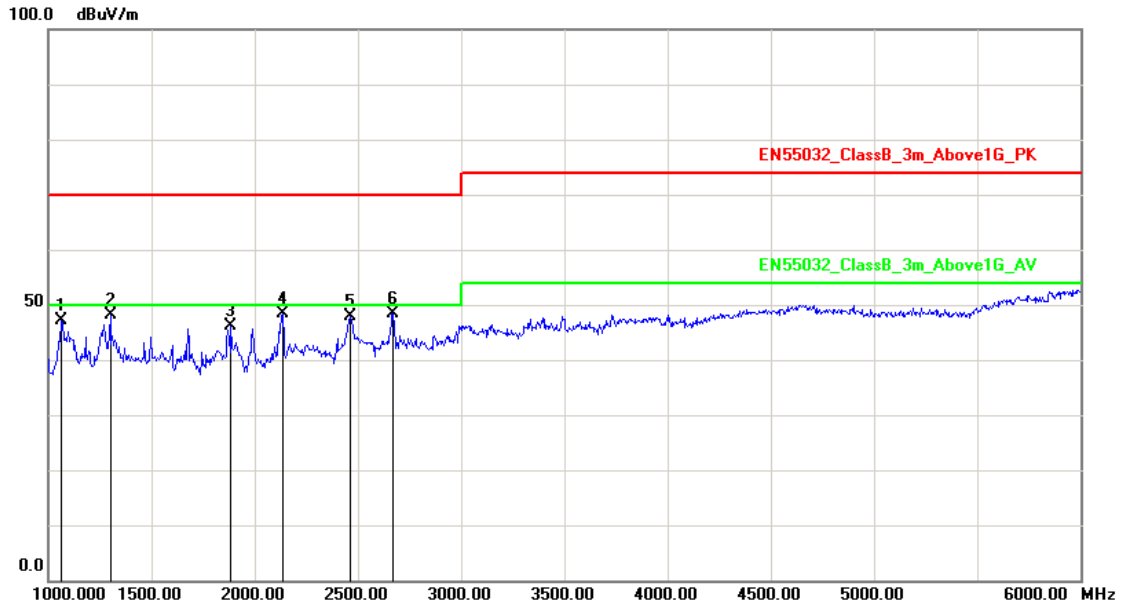

No.	Frequency (MHz)	Factor (dB/m)	Reading (dBuV)	Level (dBuV/m)	Limit (dBuV/m)	Margin (dB)	Det.	Height (cm)	Azimuth (deg)
1	1065.000	-5.55	52.61	47.06	70.00	-22.94	peak	100	0
2	1300.000	-3.98	52.18	48.20	70.00	-21.80	peak	100	21
3	1885.000	-1.53	47.64	46.11	70.00	-23.89	peak	200	126
4	2135.000	-0.51	48.91	48.40	70.00	-21.60	peak	200	19
5	2465.000	1.17	46.81	47.98	70.00	-22.02	peak	100	351
6	2670.000	2.29	46.11	48.40	70.00	-21.60	peak	100	247

Note: Measurement Level = Reading Level + Correct Factor



Test Mode :	Mode 39: Full system (HDMI 2 mode 1920*1080@240Hz) for Horizontal (230V/50Hz)		
AC Power :	AC 230V/50Hz	Ant. Polarization:	Vertical
Equipment :	LCD Monitor	Model No :	250LM00005
Temperature :	26°C	Humidity :	56%
Pressure(mbar) :	1001	Date:	2016/09/11

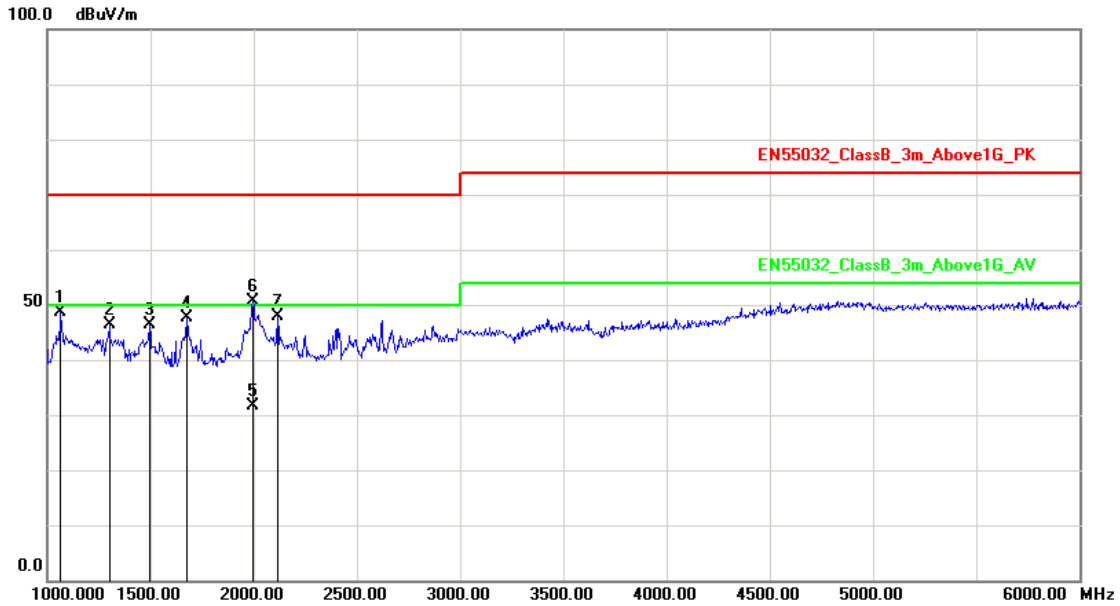

No.	Frequency (MHz)	Factor (dB/m)	Reading (dBuV)	Level (dBuV/m)	Limit (dBuV/m)	Margin (dB)	Det.	Height (cm)	Azimuth (deg)
1	1065.000	-5.55	54.24	48.69	70.00	-21.31	peak	100	15
2	1300.000	-3.98	50.38	46.40	70.00	-23.60	peak	100	321
3	1495.000	-2.67	49.11	46.44	70.00	-23.56	peak	100	241
4	1675.000	-2.14	49.82	47.68	70.00	-22.32	peak	200	4
5	1994.000	-1.22	32.78	31.56	50.00	-18.44	AVG	100	296
6	1995.000	-1.21	51.90	50.69	70.00	-19.31	peak	100	296
7	2115.000	-0.61	48.54	47.93	70.00	-22.07	peak	200	0

Note: Measurement Level = Reading Level + Correct Factor

Test engineer: Sun. Zhang



### 5.7. Test Photographs (30MHz~1GHz)

Front View

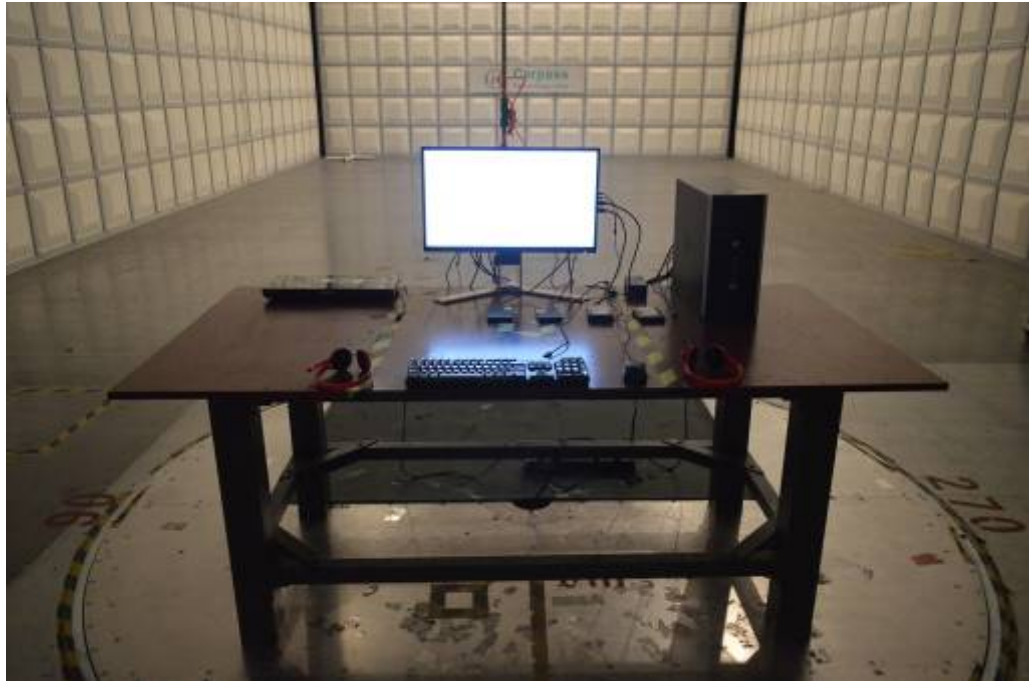

Rear View

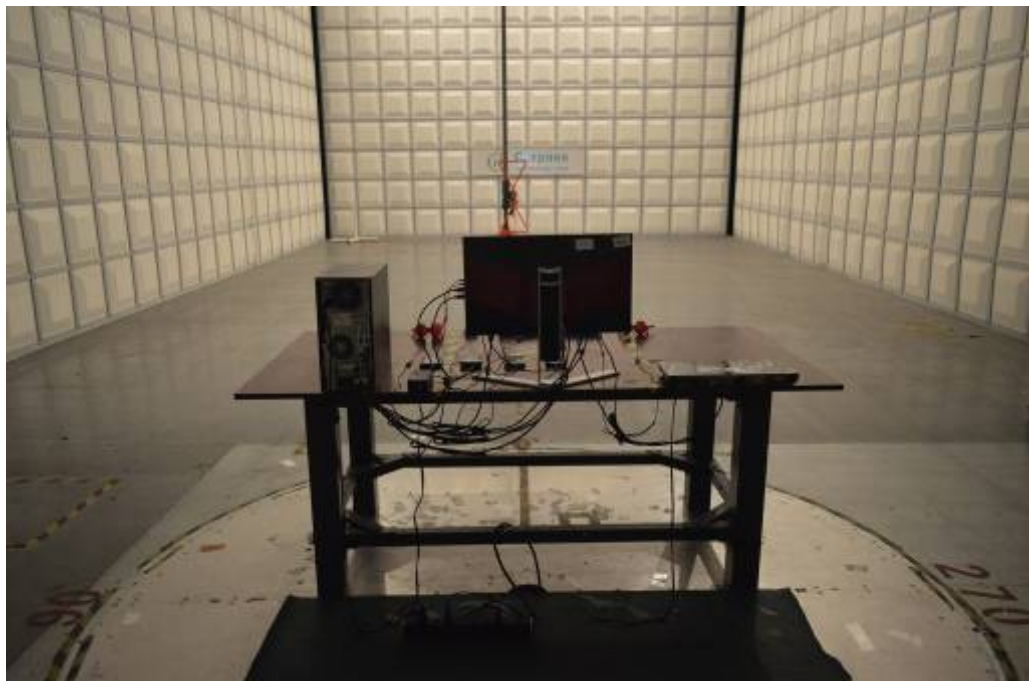





### 5.8. Test Photographs (1GHz~6GHz)

Front View



Rear View

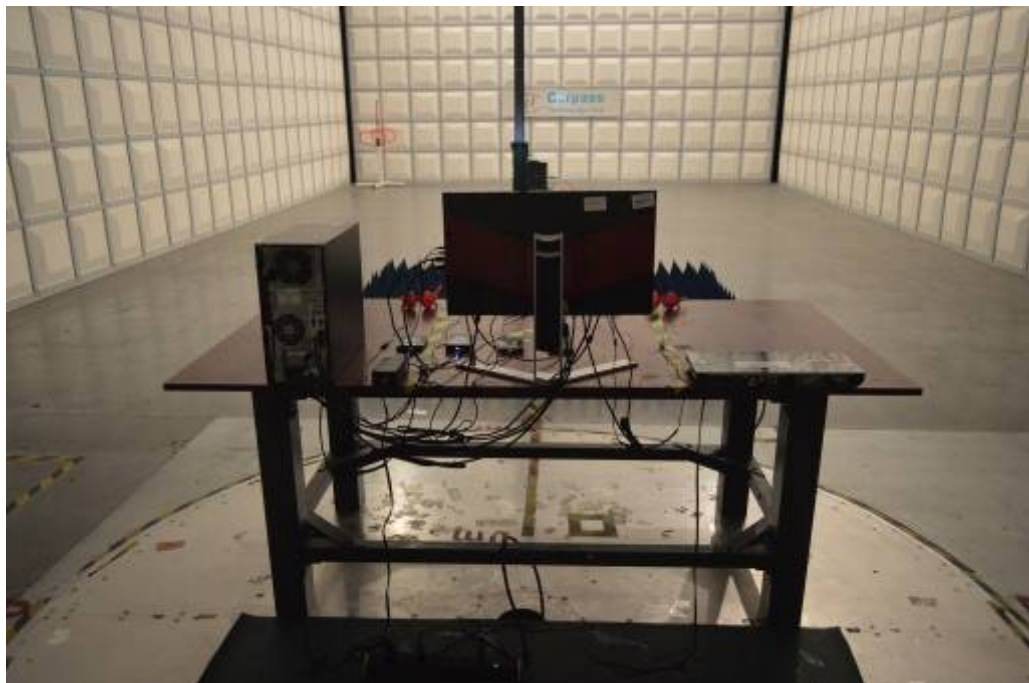



## 6. Harmonics Test

### 6.1. Limits of Harmonics Current Measurement

#### Limits for Class A equipment

Harmonics Order n	Max. permissible harmonics current A	Harmonics Order n	Max. permissible harmonics current A
Odd harmonics		Even harmonics	
3	2.30	2	1.08
5	1.14	4	0.43
7	0.77	6	0.30
9	0.40	8 ≤ n ≤ 40	0.23x8/n
11	0.33		
13	0.21		
15 ≤ n ≤ 39	0.15x15/n		

#### (b) Limits for Class B equipment

For Class B equipment, the harmonics of the input current shall not exceed the values given in Table that is the limit of Class A multiplied by a factor of 1,5.

#### (c) Limits for Class C equipment

Harmonics Order n	Maximum permissible harmonic current expressed as a percentage of the input current at the fundamental frequency %
2	2
3	$30 \cdot \lambda^*$
5	10
7	7
9	5
11 < n < 39 (odd harmonics only)	3

\*  $\lambda$  is the circuit power factor

#### (d) Limits for Class D equipment

Harmonics Order n	Maximum permissible harmonic current per watt mA/W	Maximum permissible harmonic current A
3	3.4	2.30
5	1.9	1.14
7	1.0	0.77
9	0.5	0.40
11	0.35	0.33
11 < n < 39 (odd harmonics only)	3.85/n	See limit of Class A

**NOTE:** According to section 7 of EN 61000-3-2, the above limits for all equipment except for lighting equipment having an active input power > 75 W and no limits apply for equipment with an active input power up to and including 75 W.



### 6.2. Measurement Equipment

Instrument/Ancillary	Manufacturer	Model No.	Serial No.	Calibration Date	Valid Date.
EMC Emission Tester	EMCPARTNER	Harmonics-1000	159	2016.03.26	2017.03.25
Temperature/ Humidity Meter	Zhicheng	ZC1-11	CEP-TH-004	2016.03.29	2017.03.28
HARCS	EMC Partner AG	Ver 4.18	N/A	N/A	N/A



6.3. Test Result and Data

Basic Standard	:	EN 61000-3-2
Final Test Result	:	PASS
Test Mode	:	Mode 1,5,9,13,17
Model No.	:	250LM00005
Temperature	:	22°C
Humidity	:	52%
Atmospheric Pressure	:	100 kPa
Test Date	:	Sep 20. 2016

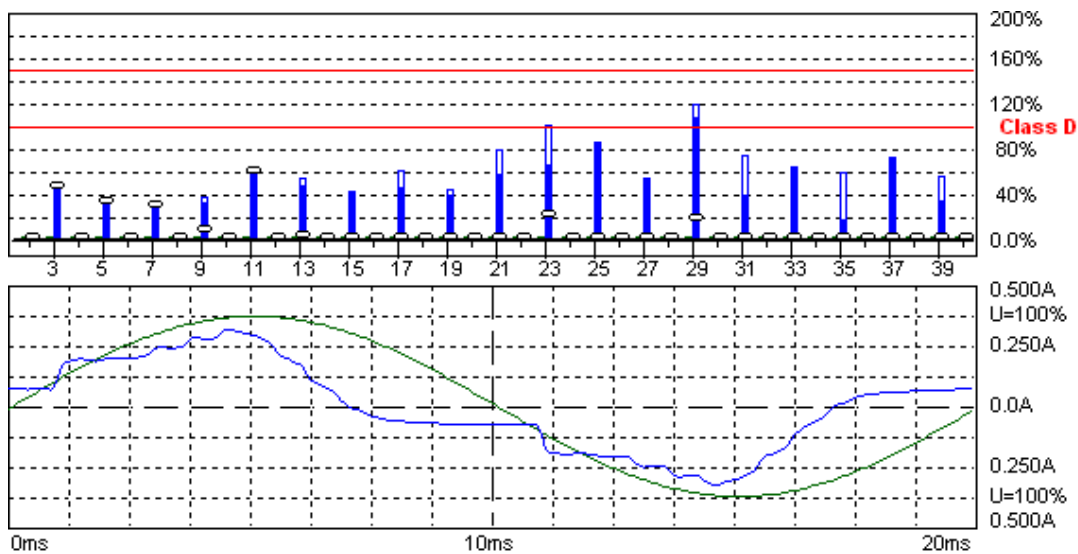

Harmonic Emission - IEC 61000-3-2, EN 61000-3-2, (EN60555-2)

2016-9-20 13:54:57 harmonic.hsu

Urms = 229.9 V    P = 32.64 W    THC = 0.058 A    Range: 0.5 A  
 Irms = 0.179 A    pf = 0.793    Pmax = 32.77 W    V-nom: 230 V  
 TestTime: 15 min (100%)

Test completed, Result: PASSED

HAR-1000 EMC-Partner

Full Bar : Actual Values  
 Empty Bar : Maximum Values  
 Blue : Current , Green : Voltage , Red : Failed

Urms = 229.9V    Freq = 50.000    Range: 0.5 A  
 Irms = 0.179A    Ipk = 0.330A    cf = 1.844  
 P = 32.64W    S = 41.14VA    pf = 0.793  
 THDi = 32.6 %    THDu = 0.20 %    Class D  
 Test - Time : 15min ( 100 %)  
 Limit Reference: Pmax = 32.770W  
 Test completed, Result: PASSED



Order	Freq. [Hz]	Irms [A]	Irms%L [%]	I <sub>max</sub> [A]	I <sub>max</sub> %L [%]	Limit [A]
1	50	0.1696		0.1701		
2	100	0.0007		0.0007		
3	150	0.0521	46.727	0.0521	46.727	0.1114
4	200	0.0004		0.0006		
5	250	0.0200	32.104	0.0202	32.398	0.0623
6	300	0.0004		0.0005		
7	350	0.0096	29.335	0.0102	31.104	0.0328
8	400	0.0004		0.0004		
9	450	0.0049	29.614	0.0057	34.643	0.0164
10	500	0.0003		0.0005		
11	550	0.0071	61.729	0.0072	62.527	0.0115
12	600	0.0004		0.0005		
13	650	0.0044	45.595	0.0051	52.199	0.0097
14	700	0.0004		0.0005		
15	750	0.0034	40.274	0.0034	40.999	0.0084
16	800	0.0003		0.0004		
17	850	0.0032	43.176	0.0044	59.213	0.0074
18	900	0.0003		0.0004		
19	950	0.0024	36.766	0.0028	42.741	0.0066
20	1000	0.0004		0.0005		
21	1050	0.0033	54.859	0.0046	77.209	0.0060
22	1100	0.0004		0.0005		
23	1150	0.0034	62.866	0.0054	99.027	0.0055
24	1200	0.0004		0.0005		
25	1250	0.0042	82.241	0.0042	83.450	0.0050
26	1300	0.0004		0.0005		
27	1350	0.0023	50.288	0.0024	51.594	0.0047
28	1400	0.0004		0.0004		
29	1450	0.0046	105.92	0.0051	117.14	0.0044
30	1500	0.0004		0.0004		
31	1550	0.0015	36.742	0.0029	71.985	0.0041
32	1600	0.0003		0.0004		
33	1650	0.0023	60.665	0.0024	62.261	0.0038
34	1700	0.0003		0.0004		
35	1750	0.0005	14.392	0.0021	57.568	0.0036
36	1800	0.0004		0.0004		
37	1850	0.0023	68.913	0.0024	70.703	0.0034
38	1900	0.0004		0.0004		
39	1950	0.0010	31.131	0.0017	53.771	0.0032
40	2000	0.0004		0.0004		

EUT is PASSED if:

- all Average values of the Individual Harmonic Currents (I<sub>avg</sub>) are below 100% of the Individual Limits.
- all Maximum values of the Individual Harmonic Currents (I<sub>max</sub>) are below 150% of the Individual Limits.

Test engineer: Sun. Zhang



### 6.4. Test Photographs





## 7. Voltage Fluctuations Test

### 7.1. Test Procedure

The equipment shall be tested under the conditions of **Clause 5**.

The total impedance of the test circuit, excluding the appliance under test, but including the internal impedance of the supply source, shall be equal to the reference impedance.

The stability and tolerance of the reference impedance shall be adequate to ensure that the overall accuracy of  $\pm 8\%$  is achieved during the whole assessment procedure.

### 7.2. Measurement Equipment

Instrument/Ancillary	Manufacturer	Model No.	Serial No.	Calibration Date	Valid Date.
EMC Emission Tester	EMCPARTNER	Harmonics-1000	159	2016.03.26	2017.03.25
Temperature/ Humidity Meter	Zhicheng	ZC1-11	CEP-TH-004	2016.03.29	2017.03.28
HARCS	EMC Partner AG	Ver 4.18	N/A	N/A	N/A



### 7.3. Test Result and Data

Basic Standard	:	EN 61000-3-3
Final Test Result	:	PASS
Test Mode	:	Mode 1,5,9,13,17
Model No.	:	250LM00005
Temperature	:	22°C
Humidity	:	52%
Atmospheric Pressure	:	100 kPa
Test Date	:	Sep 20.2016

Flickermeter 1000-4-15 for 230V/50Hz

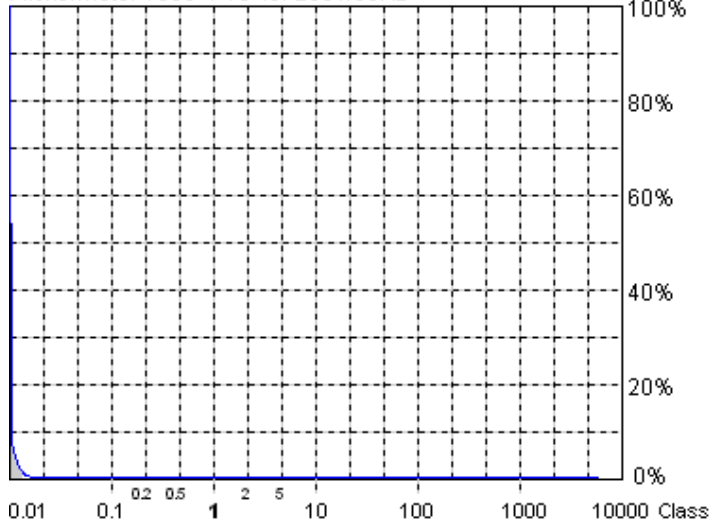

**Actual Flicker (Fli): 0.01**  
**Short-term Flicker (Pst): 0.07**  
 Limit (Pst): 1.00  
**Long-term Flicker (Plt): 0.07**  
 Limit (Plt): 0.65  
**Maximum Relative Volt. Change (dmax): 0.00%**  
 Limit (dmax): 4.00%  
**Relative Steady-state Voltage Change (dc): 0.07%**  
 Limit (dc): 3.30%  
**Maximum Interval exceeding 3.30% (dt): 0.00ms**  
 Limit (dt>Lim): 500ms

**Flicker Emission - IEC 61000-3-3 , EN 61000-3-3 , (EN60555-3)**

Urms = 229.9 V P = 32.58 W  
 Irms = 0.179 A pf = 0.792

2016-9-20 14:06:35 harmonic.hsu

Range: 0.5 A  
 V-nom: 230 V  
 TestTime: 10 min (100%)

**Test completed, Result: PASSED**

HAR-1000 EMC-Partner

- Full Bar : Actual Values
- Empty Bar : Maximum Values
- Circles : Average Values
- Blue : Current , Green : Voltage , Red : Failed





Urms = 229.9V Freq = 50.000 Range: 0.5 A  
Irms = 0.179A Ipk = 0.329A cf = 1.839  
P = 32.58W S = 41.14VA pf = 0.792

Test - Time : 1 x 10min = 10min ( 100 %)

LIN (Line Impedance Network) : No LIN

Limits : Plt : 0.65 Pst : 1.00  
dmax : 4.00 % dc : 3.30 %  
dtLim: 3.30 % dt>Lim: 500ms

Test completed, Result: PASSED

Test engineer: Sun. Zhang



### 7.4. Test Photographs





## 8. Electrostatic Discharge Immunity Test

### 8.1. Test Procedure

- a. In the case of air discharge testing the climatic conditions shall be within the following ranges:
  - ambient temperature: 15°C to 35°C;
  - relative humidity : 30% to 60%;
  - atmospheric pressure : 86 KPa (860 mbar) to 106 KPa (1060 mbar).
- b. Test programs and software shall be chosen so as to exercise all normal modes of operation of the EUT. The use of special exercising software is encouraged, but permitted only where it can be shown that the EUT is being comprehensively exercised.
- c. The test voltage shall be increased from the minimum to the selected test severity level, in order to determine any threshold of failure. The final severity level should not exceed the product specification value in order to avoid damage to the equipment.
- d. The test shall be performed with both air discharge and contact discharge. On reselected points at least 10 single discharges (in the most sensitive polarity) shall be applied on air discharge. On reselected points at least 25 single discharges (in the most sensitive polarity) shall be applied on contact discharge.
- e. For the time interval between successive single discharges an initial value of one second is recommended. Longer intervals may be necessary to determine whether a system failure has occurred.
- f. In the case of contact discharges, the tip of the discharge electrode shall touch the EUT before the discharge switch is operated.
- g. In the case of painted surface covering a conducting substrate, the following procedure shall be adopted :
  - If the coating is not declared to be an insulating coating by the equipment manufacturer, then the pointed tip of the generator shall penetrate the coating so as to make contact with the conducting substrate.
  - Coating declared as insulating by the manufacturer shall only be submitted to the air discharge.
  - The contact discharge test shall not be applied to such surfaces.
- h. In the case of air discharges, the round discharge tip of the discharge electrode shall be approached as fast as possible (without causing mechanical damage) to touch the EUT . After each discharge, the ESD generator (discharge electrode) shall be removed from the EUT. The generator is then retriggered for a new single discharge. This procedure shall be repeated until the discharges are completed. In the case of an air discharge test, the discharge switch, which is used for contact discharge, shall be closed.

## 8.2. Test Setup for Tests Performed in Laboratory

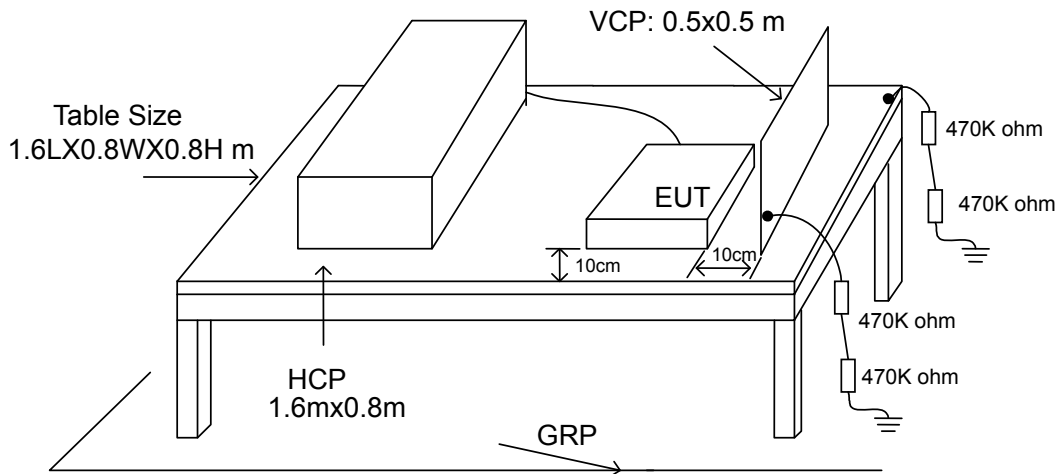

The test setup consists of the test generator, EUT and auxiliary instrumentation necessary to perform DIRECT and INDIRECT application of discharges to the EUT as applicable, in the follow manner :

- a. Contact Discharge to the conductive surfaces and to coupling plane;
- b. Air Discharge at insulating surfaces.

The preferred test method is that of type tests performed in laboratories and the only accepted method of demonstrating conformance with this standard. The EUT was arranged as closely as possible to arrangement in final installed conditions.

A ground reference plane was provided on the floor of the test site. It was a metallic sheet (copper or aluminum) of 0.25 mm, minimum thickness; other metallic may be used but they shall have at least 0.65 mm thickness. In the CerpPASS Technology Corp., we provided 1 mm thickness stainless steel ground reference plane. The minimum size of the ground reference plane is 2.5 m x 2.5 m, the exact size depending on the dimensions of the EUT. It was connected to the protective grounding system.

The EUT was arranged and connected according to its functional requirements. A distance of 1m minimum was provided between the EUT and the wall of the lab. and any other metallic structure. In cases where this length exceeds the length necessary to apply the discharges to the selected points, the excess length shall, where possible, be placed non-inductively off the ground reference plane and shall not come closer than 0.2m to other conductive parts in the test setup.

Where the EUT is installed on a metal table, the table was connected to the reference plane via a cable with a 470k ohm resistor located at each end, to prevent a build-up of charge. The test setup was consist a wooden table, 0.8m high, standing on the ground reference plane. A HCP, 1.6 m x 0.8 m, was placed on the table. The EUT and cables was isolated from the HCP by an insulating support 0.5 mm thick. The VCP size, 0.5 m x 0.5 m.



### 8.3. Test Severity Levels

Contact Discharge		Air Discharge	
Level	Test Voltage (KV) of Contact discharge	Level	Test Voltage (KV) of Air Discharge
1	±2	1	±2
2	±4	2	±4
3	±6	3	±8
4	±8	4	±15
X	Specified	X	Specified

Remark: "X" is an open level.

### 8.4. Measurement Equipment

Instrument/Ancillary	Manufacturer	Model No.	Serial No.	Calibration Date	Valid Date.
ESD Simulator	EM Test	dito	V0714102399	2016.04.21	2017.04.20
Tonometer	shanghaifengyun	DYM3	3251	2015.12.21	2016.12.20
Dehumidifier	ZEDO	ZD-220LB	CEP-TH-01	N/A	N/A
Humidifier	YADU	YZ-DS251C	CEP-TH-02	N/A	N/A
Temperature/ Humidity Meter	feiyang	N/A	102	2016.03.29	2017.03.28



8.5. Test Result and Data

Final Test Result : **PASS**  
 Pass performance criteria : B  
 Basic Standard : IEC 61000-4-2  
 Model No. : 250LM00005  
 Test Voltage : ±2 / ±4 / ±8 KV for air discharge,  
 ±2 / ±4 KV for contact discharge  
 Temperature : 22°C  
 Relative Humidity : 49 %  
 Atmospheric Pressure : 100 kPa  
 Test Date : Sep 19, 2016

Test Mode : Mode 1,5,9,13,17

	Contact Discharge								Air Discharge							
	25 times / each								10 times / each							
Voltage	2 kV		4 kV		6 kV		8 kV		2 kV		4 kV		8 kV		10 kV	
Point\Polarity	+	-	+	-	+	-	+	-	+	-	+	-	+	-	+	-
HCP	A	A	A	A	---	---	---	---	---	---	---	---	---	---	---	---
VCP	A	A	A	A	---	---	---	---	---	---	---	---	---	---	---	---
Screw	A	A	A	A	---	---	---	---	---	---	---	---	---	---	---	---
Case	---	---	---	---	---	---	---	---	A	A	A	A	A	A	---	---
Panel	---	---	---	---	---	---	---	---	A	A	A	A	A	A	---	---
HDMI Port	A	A	A	A	---	---	---	---	A	A	A	A	A	A	---	---
HDMI-MHL Port	A	A	A	A	---	---	---	---	A	A	A	A	A	A	---	---
DP Port	A	A	A	A	---	---	---	---	A	A	A	A	A	A	---	---
VGA Port	A	A	A	A	---	---	---	---	A	A	A	A	A	A	---	---
Audio Port	---	---	---	---	---	---	---	---	A	A	A	A	A	A	---	---
USB Port	A	A	A	A	---	---	---	---	---	---	---	---	---	---	---	---
Power Port	---	---	---	---	---	---	---	---	A	A	A	A	A	A	---	---
Button	---	---	---	---	---	---	---	---	A	A	A	A	A	A	---	---
LED Light	---	---	---	---	---	---	---	---	A	A	A	A	A	A	---	---
DVI Port	A	A	A	A	---	---	---	---	A	A	A	A	A	A	---	---

Test engineer: Sun. Zhang



### 8.6. Test Photographs





## 9. Radio Frequency electromagnetic field immunity test

### 9.1. Test Procedure

- a. The equipment to be tested is placed in the center of the enclosure on a wooden table. The equipment is then connected to power and signal leads according to pertinent installation instructions.
- b. The antenna which is enabling the complete frequency range of 80-1000 MHz is placed 3m away from the equipment. The required field strength is determined by placing the field strength meter(s) on top of or directly alongside the equipment under test and monitoring the field strength meter via a remote field strength indicator outside the enclosure while adjusting the continuous-wave to the applicable antennae.
- c. The test is normally performed with the antenna facing the most sensitive side of the EUT. The polarization of the field generated by the bucolical antenna necessitates testing each position twice, once with the antenna positioned vertically and again with the antenna positioned horizontally. The circular polarization of the field from the log-spiral antenna makes a change of position of the antenna unnecessary.
- d. At each of the above conditions, the frequency range is swept 80-1000 MHz, pausing to adjust the R.F. signal level or to switch oscillators and antenna. The rate of sweep is in the order of  $1.5 \times 10^{-3}$  decades/s. The sensitive frequencies or frequencies of dominant interest may be discretely analyzed.

### 9.2. Test Severity Levels

Frequency Band : 80-1000 MHz	
Level	Test field strength (V/m)
1	1
2	3
3	10
X	Specified
Remark: "X" is an open class.	



### 9.3. TEST SETUP

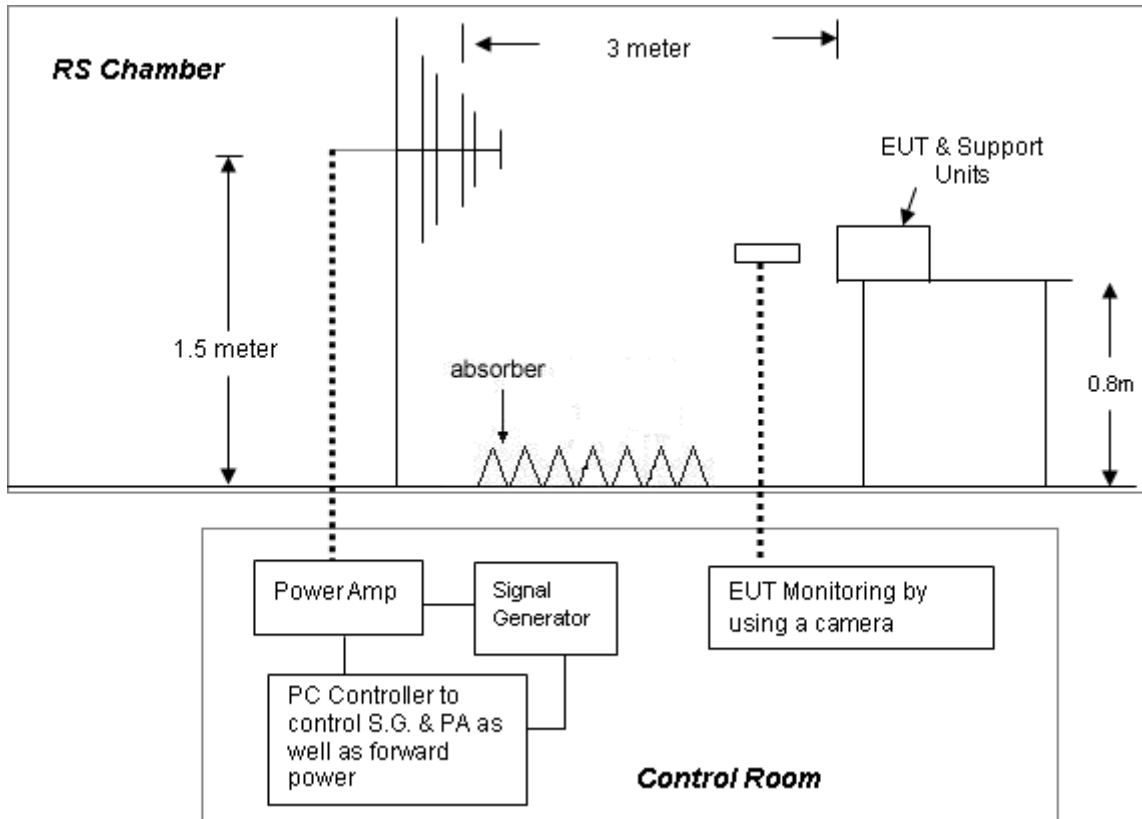

- For the actual test configuration, please refer to the related item – Photographs of the Test Configuration.

**NOTE:**

**TABLETOP EQUIPMENT**

The EUT installed in a representative system as described in section 7 of IEC 61000-4-3 was placed on a non-conductive table 0.8 meters in height. The system under test was connected to the power and signal wire according to relevant installation instructions.

**FLOOR STANDING EQUIPMENT**

The EUT installed in a representative system as described in section 7 of IEC 61000-4-3 was placed on a non-conductive wood support 0.1 meters in height. The system under test was connected to the power and signal wire according to relevant installation instructions.



#### 9.4. Measurement Equipment

Instrument/Ancillary	Manufacturer	Model No.	Serial No.	Calibration Date	Valid Date.
Signal Generator	R&S	SML03	103287	2016.03.26	2017.03.25
Power Sensor	R&S	NR P-Z91	100383	2016.03.26	2017.03.25
Power Sensor	R&S	NRP-Z91	100384	2016.03.26	2017.03.25
Power Meter	R&S	NRP	101206	2016.03.26	2017.03.25
Power Amplifier	BONN	BLWA0830-16 0/100/40D	076659	2016.03.26	2017.03.25
Istropic Electric Field Probe	EST.LINDGRE N	HI-6105	137445	2015.11.20	2016.11.19
EMS Antenna	R&S	HL046E	100028	N/A	N/A
Temperature/ Humidity Meter	feiyang	N/A	101	2016.03.29	2017.03.28
EMC-32	Rohde&Schwa rz	Ver 6.10.0	N/A	N/A	N/A



9.5. Test Result and Data

Final Test Result : **PASS**  
 Pass performance criteria : A  
 Basic Standard : IEC 61000-4-3  
 Model No. : 250LM00005  
 Frequency Range : 80~1000 MHz  
 Temperature : 22°C  
 Relative Humidity : 53%  
 Atmospheric Pressure : 100 kPa  
 Test Date : Sep 19, 2016

Test Mode: Mode 1,5,9,13,17

Modulation : AM 80% , 1KHz sine wave , Dwell time: 3.0 S				
Frequency Step Size : 1 % of preceding frequency value				
Frequency (MHz)	Antenna Polarization	face	Field strength (V/m)	Result
80~1000	Vertical	Front	3 V/m	A
80~1000	Vertical	Rear	3 V/m	A
80~1000	Vertical	Left	3 V/m	A
80~1000	Vertical	Right	3 V/m	A
80~1000	Horizontal	Front	3 V/m	A
80~1000	Horizontal	Rear	3 V/m	A
80~1000	Horizontal	Left	3 V/m	A
80~1000	Horizontal	Right	3 V/m	A

Test engineer: Sun. Zhang



### 9.6. Test Photographs

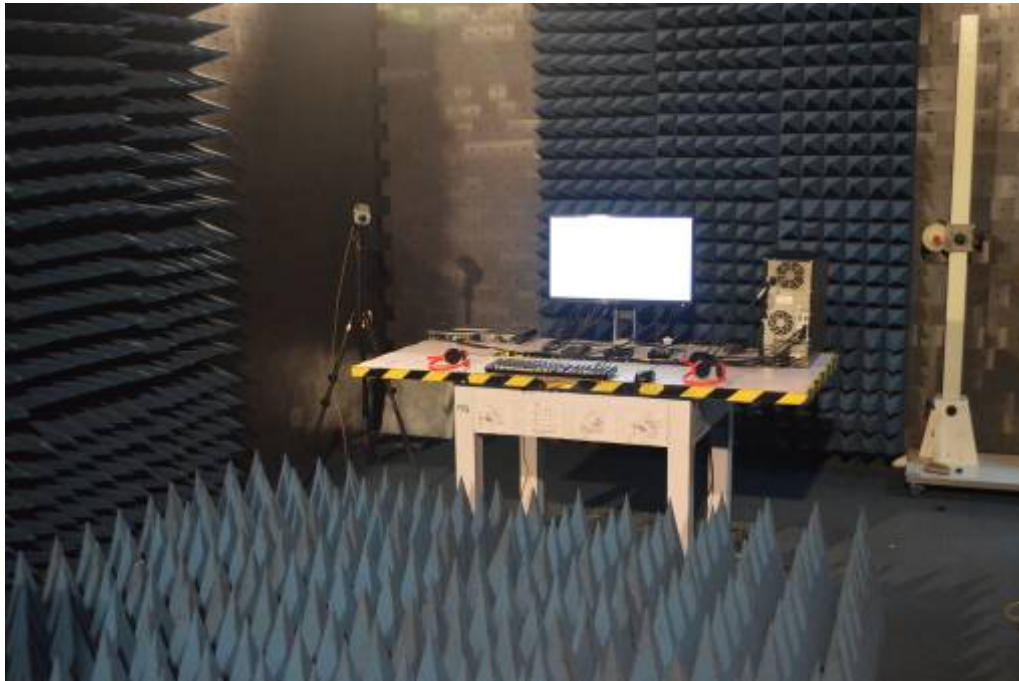



## 10. Electrical Fast Transient/ Burst Immunity Test

### 10.1. Test Procedure

- a. In order to minimize the effect of environmental parameters on test results, the climatic conditions when test is carrying out shall comply with the following requirements:
  - ambient temperature: 15°C to 35°C;
  - relative humidity : 45% to 75%;
  - Atmospheric pressure: 86 Kpa (860 mbar) to 106 Kpa (1060 mbar).
- b. In order to minimize the effect of environmental parameters on test results, the electromagnetic environment of the laboratory shall not influence the test results.
- c. The variety and diversity of equipment and systems to be tested make it difficult to establish general criteria for the evaluation of the effects of fast transients/bursts on equipment and systems.
- d. Test on Power Line:
  - The EFT/B-generator was located on the GRP.  
For floor standing equipment 1,0 m  
For table top equipment 0,5 m
  - The EFT/B-generator provides the ability to apply the test voltage in a non-symmetrical condition to the power supply input terminals of the EUT.
- e. Test on Communication Lines
  - The coupling clamp is composed of a clamp unit for housing the cable (length more than 3 m), and was placed on the GRP.
  - The coupling clamp provides the ability of coupling the fast transient/bursts to the cable under test.
- f. The test results may be classified on the basic of the operating conditions and the functional specification of the equipment under test, according to the following performance criteria :
  - Normal performance within the specification limits.
  - Temporary degradation or loss of function or performance which is self-recoverable.
  - Temporary degradation or loss of function or performance which requires operator intervention or system reset.
  - Degradation or loss of function which is not recoverable due to damage of equipment (components).

### 10.2. Test Severity Levels

The following test severity levels are recommended for the fast transient/burst test :

Open circuit output test voltage $\pm 10\%$		
Level	On Power Supply	On I/O signal, data and control line
1	0.5 KV	0.25 KV
2	1.0 KV	0.50 KV
3	2.0 KV	1.00 KV
4	4.0 KV	2.00 KV
X	Specified	Specified

Remark : “ X ” is an open level. The level is subject to negotiation between the user and manufacturer or is specified by the manufacturer.

### 10.3. TEST SETUP

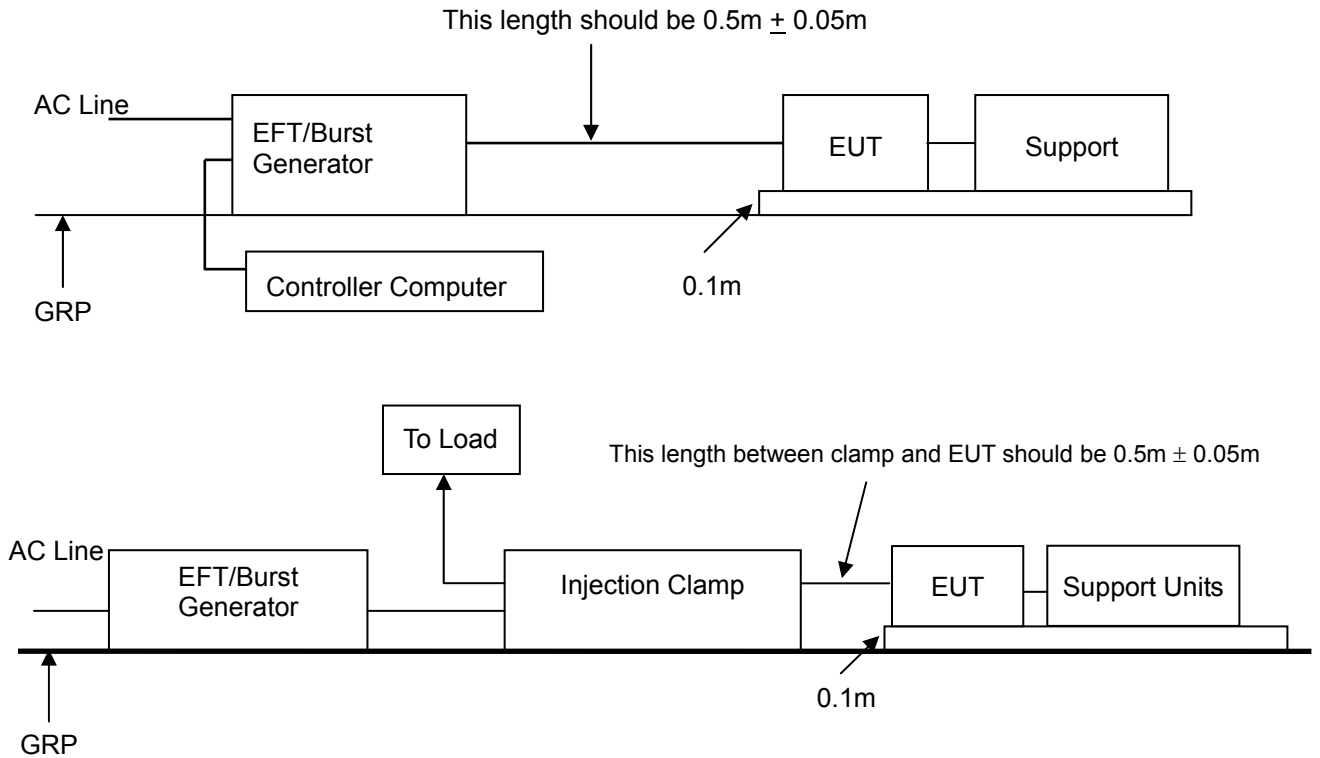

- For the actual test configuration, please refer to the related item – Photographs of the Test Configuration.

**NOTE:**

**TABLETOP EQUIPMENT**

The configuration consisted of a wooden table (0.1m high) standing on the Ground Reference Plane. The GRP consisted of a sheet of aluminum (at least 0.25mm thick and 2.5m square) connected to the protective grounding system. A minimum distance of 0.5m was provided between the EUT and the walls of the laboratory or any other metallic structure.

**FLOOR STANDING EQUIPMENT**

The EUT installed in a representative system as described in section 7 of IEC 61000-4-4 and its cables, were isolated from the Ground Reference Plane by an insulating support that is 0.1-meter thick. The GRP consisted of a sheet of aluminum (at least 0.25mm thick and 2.5m square) connected to the protective grounding system.

### 10.4. Measurement Equipment

Instrument/Ancillary	Manufacturer	Model No.	Serial No.	Calibration Date	Valid Date.
TRANSIENT	EMCPARTNER	TRA2000IN6	901	2016.03.26	2017.03.25
CDN	EMCPARTNER	CDN2000-06-32	121	2016.03.26	2017.03.25
Coupling clamp	EMCPARTNER	CN-EFT1000	547	2016.03.26	2017.03.25
Temperature/ Humidity Meter	Zhicheng	ZC1-11	CEP-TH-005	2016.04.02	2017.04.01



**10.5. Test Result and Data**

Final Test Result : **PASS**  
 Pass performance criteria : B  
 Basic Standard : IEC 61000-4-4  
 Model No. : 250LM00005  
 Test Voltage : On Power Supply -- ±1.0 kV  
                   : On I/O signal, data and control line -- ±0.5 kV  
 Temperature : 22°C  
 Relative Humidity : 54 %  
 Atmospheric Pressure : 100 kPa  
 Test Date : Sep 19, 2016

Test Mode: Mode1,5,9,13,17

Pulse : 5/50 ns		Repetition Rate: <u>5 kHz</u>			
Burst : 15m/300ms					
Test time : 1 min/each condition					
Voltage/ Mode/ Polarity/ Result/ Phase		<u>0.5 kV</u>		<u>1.0 kV</u>	
		+	—	+	—
Power Line	L	---	---	A	A
	N	---	---	A	A
	L-N	---	---	A	A
	PE	---	---	A	A
	L-PE	---	---	A	A
	N-PE	---	---	A	A
	L-N-PE	---	---	A	A

Test engineer: Sun. Zhang



### 10.6. Test Photographs







## 11. Surge Immunity Test

### 11.1. Test Procedure

- a. Climatic conditions  
The climatic conditions shall comply with the following requirements :
  - ambient temperature : 15 °C to 35 °C
  - relative humidity : 10 % to 75 %
  - atmospheric pressure : 86 kPa to 106 kPa ( 860 mbar to 1060 mbar )
- b. Electromagnetic conditions  
the electromagnetic environment of the laboratory shall not influence the test results.
- c. The test shall be performed according the test plan that shall specify the test set-up with
  - generator and other equipment utilized;
  - test level ( voltage/current );
  - generator source impedance;
  - internal or external generator trigger;
  - number of tests : at least five positive and five negative at the selected points;
  - repetition rate : maximum 1/min.
  - inputs and outputs to be tested;
  - representative operating conditions of the EUT;
  - sequence of application of the surge to the circuit;
  - phase angle in the case of AC. power supply;
  - actual installation conditions, for example :
    - AC : neutral earthed,
    - DC : ( + ) or ( - ) earthed to simulated the actual earthing conditions.
- d. If not otherwise specified the surges have to be applied synchronized to the voltage phase at the zero-crossing and the peak value of the AC. voltage wave ( positive and negative ).
- e. The surges have to be applied line to line and line(s) and earth. When testing line to earth, the test voltage has to be applied successively between each of the lines and earth, if there is no other specification.
- f. The test procedure shall also consider the non-linear current-voltage characteristics of the equipment under test. Therefore the test voltage has to be increased by steps up to the test level specified in the product standard or test plan.
- g. All lower levels including the selected test level shall be satisfied. For testing the secondary protection, the output voltage of the generator shall be increased up to the worst-case voltage breakdown level ( let-through level ) of the primary protection.
- h. If the actual operating signal sources are not available, that may be simulated. Under no circumstances may the test level exceed the product specification. The test shall be carried out according to a test plan.
- i. To find all critical points of the duty cycle of the equipment, a sufficient number of positive and negative test pulses shall be applied. For acceptance test previously unstressed equipment shall be used to the protection devices shall be replaced.

### 11.2. Test Severity Level

Level	Open-circuit test voltage, ± 10%, KV
1	0.5
2	1.0
3	2.0
4	4.0
X	Specified
NOTE: "X" is an open class. This level can be specified in the product specification.	



### 11.3. TEST SETUP

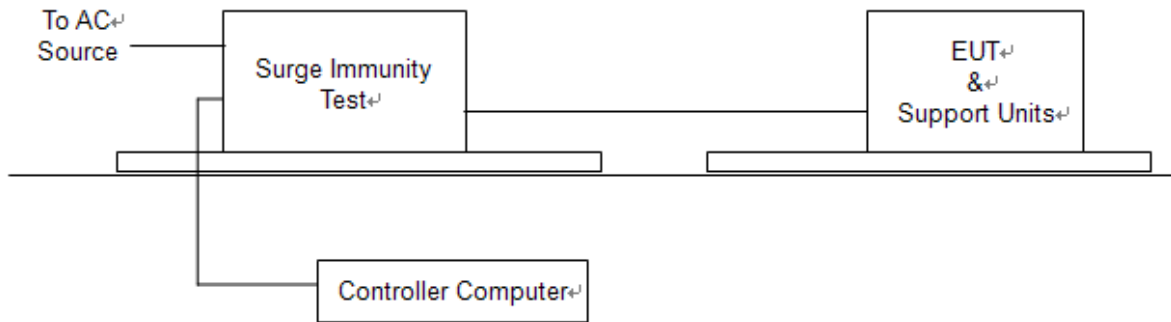

For the actual test configuration, please refer to the related item – Photographs of the Test Configuration.

### 11.4. Measurement Equipment

Instrument/Ancillary	Manufacturer	Model No.	Serial No.	Calibration Date	Valid Date.
TRANSIENT	EMCPARTNER	TRA2000IN6	901	2016.03.26	2017.03.25
CDN	EMCPARTNER	CDN-UTP8	021	2016.03.26	2017.03.25
CDN	EMCPARTNER	CDN2000-06-32	121	2016.03.26	2017.03.25
Temperature/ Humidity Meter	Zhicheng	ZC1-11	CEP-TH-005	2016.04.02	2017.04.01





### 11.6. Test Photographs





## 12. Conduction Disturbances induced by Radio-Frequency Fields

### 12.1. Test Procedure

- a. The EUT shall be operated within its intended climatic conditions. The temperature and relative humidity should be recorded.
- b. This test method test can be performed without using a sell shielded enclosure. This is because the disturbance levels applied and the geometry of the setups are not likely to radiated a high amount of energy, especially at the lower frequencies. If under certain circumstances the radiated energy is too high, a shielded enclosure has to be used.
- c. The test shall be performed with the test generator connected to each of the coupling and decoupling devices in turn while the other non-excited RF-input ports of the coupling devices are terminated by a 50 ohm load resistor.
- d. The frequency range is swept from 150 KHz to 80 MHz, using the signal levels established during the setting process, and with the disturbance signal 80% amplitude modulated with a 1KHz sign wave, pausing to adjust the RF-signal level or to switch coupling devices as necessary. The rate of sweep shall no exceed  $1.5 \times 10^{-3}$  decades/s. Where the frequency is swept incrementally, the step size shall no exceed 1% of the start and thereafter 1% of the preceding frequency value.
- e. The dwell time at each frequency shall not be less than the time necessary for the EUT to be exercised, and able to respond. Sensitive frequencies e.g. clock frequency (ies) and harmonics or frequencies of dominant interest shall be analyzed separately.
- f. An alternative test procedure may be adopted, wherein the frequency range is swept incrementally, with a step size not exceeding 4% of the start ad thereafter 4% of the preceding frequency value. The test level should be at least twice the value of the specified test level.
- g. In cases of dispute, the test procedure using a step size not exceeding 1% of the start and thereafter 1% of preceding frequency value shall take precedence.
- h. Attempts should be made to fully exercise the EUT during testing, and to fully interrogate all exercise modes selected for susceptibility.
- i. The use of special exercising programs is recommended.
- j. Testing shall be performed according to a Test Plan, which shall be included in the test report.
- k. It may be necessary to carry out some investigatory testing in order to establish some aspects of the test plan.

### 12.2. Test Severity Levels

Level	Voltage Level ( e.m.f. )
1	1 V
2	3 V
3	10 V
x	Specified
NOTE - x is an open class. This level can be specified in the product specification.	

### 12.3. TEST SETUP

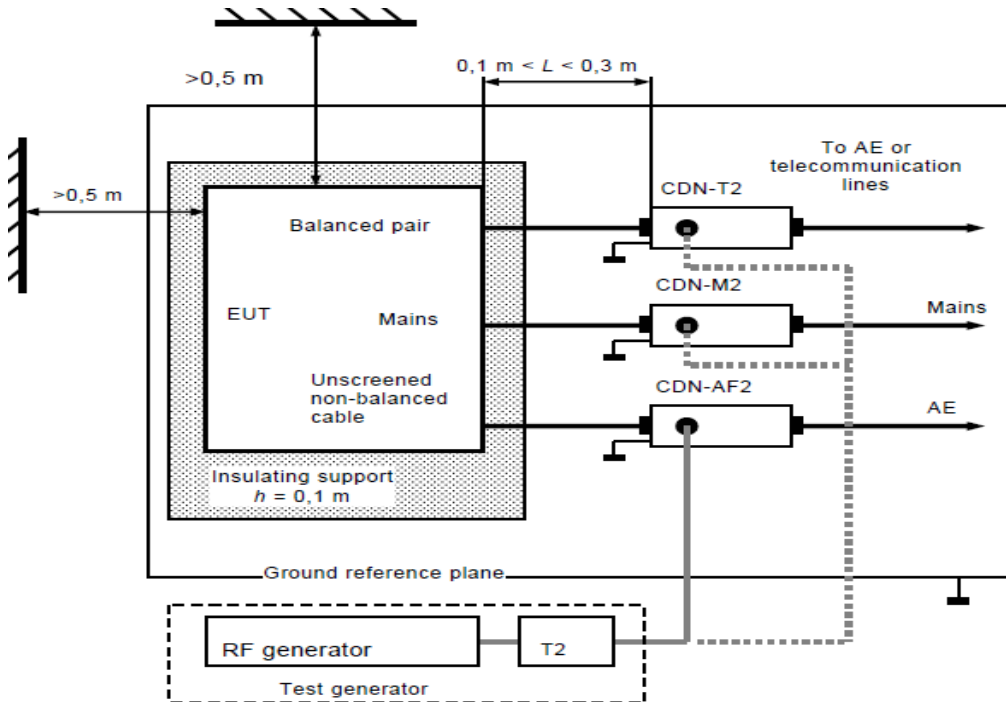

- Note:**
1. The EUT is setup 0.1m above Ground Reference Plane
  2. The CDNs and / or EM clamp used for real test depends on ports and cables configuration of EUT.
  3. For the actual test configuration, please refer to the related item – Photographs of the Test Configuration.

### 12.4. Measurement Equipment

Instrument/Ancillary	Manufacturer	Model No.	Serial No.	Calibration Date	Valid Date.
Conducted immunity test system	FRANKONIA	CIT-10/75	102D1294	2016.03.26	2017.03.25
EM Injection clamp	FCC	F-203I-23MM	536	2016.03.26	2017.03.25
CDN	FRANKONIA	CDN-T2	A3010029	2016.03.26	2017.03.25
CDN	FRANKONIA	CDN-T4	A3015017	2016.03.26	2017.03.25
CDN	FRANKONIA	CDN-T8	A3022010	2016.03.26	2017.03.25
CDN	FRANKONIA	CDN-M2	A3002037	2016.03.26	2017.03.25
CDN	FRANKONIA	CDN-M2+M3	A3011102	2016.03.26	2017.03.25
CDN	FCC	CDN-M5/32	A3013024	2016.03.26	2017.03.25
6 dB Attenuator	FRANKONIA	N/A	N/A	2016.03.26	2017.03.25
Temperature/ Humidity Meter	Zhicheng	ZC1-11	CEP-TH-005	2016.04.02	2017.04.01
EN61000-4-6	Hubert GmbH	Ver 2.21	N/A	N/A	N/A



12.5. Test Result and Data

Final Test Result : **PASS**  
Pass performance criteria : A  
Basic Standard : IEC 61000-4-6  
Model No. : 250LM00005  
Coupling mode : CDN-(M2+M3) for AC power ports  
Coupling mode : CDN-T4 for signal ports  
Coupling mode : EM-Clamp for signal ports  
Temperature : 22°C  
Relative Humidity : 54 %  
Atmospheric Pressure : 100 kPa  
Test Date : Sep 19, 2016

Test Mode : Mode 1,5,9,13,17

Frequency : 0.15~80MHz, Modulation : AM 80%,1KHz sine wave, Dwell time:3.0s Frequency Step Size : 1 % of preceding frequency value			
Frequency	Test mode	Voltage(V)	Result
0.15 ~ 80MHz	Power(M3)	3	A

Test engineer: Sun. Zhang



## 12.6. Test Photographs





### 13. Power Frequency Magnetic Field Immunity Test

#### 13.1. Test Setup

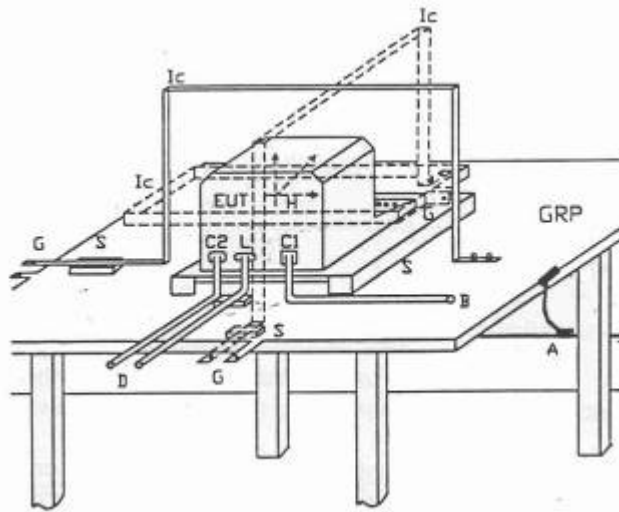

- |     |                        |    |                               |
|-----|------------------------|----|-------------------------------|
| GPR | : Ground plane         | C1 | : Power supply circuit        |
| A   | : Safety earth         | C2 | : Signal circuit              |
| S   | : Insulating support   | L  | : Communication line          |
| EUT | : Equipment under test | B  | : To power supply source      |
| Lc  | : Induction coil       | D  | : To signal source, simulator |
| E   | : Earth terminal       | G  | : To the test generator       |

#### 13.2. Test Severity Levels

Level	Magnetic field strength (A/m)
1	1
2	3
3	10
4	30
5	100
X <sup>1)</sup>	special

NOTE 1 "X" is an open level. This level can be given in the product specification.

#### 13.3. Measurement Equipment

Instrument/Ancillary	Manufacturer	Model No.	Serial No.	Calibration Date	Valid Date.
TRANSIENT	EMCPARTNER	TRA2000IN6	901	2016.03.26	2017.03.25
H-Filed-Loop	EMCPARTNER	MF1000-1	144	2016.03.26	2017.03.25
Temperature/ Humidity Meter	Zhicheng	ZC1-11	CEP-TH-005	2016.04.02	2017.04.01



13.4. Test Result and Data

Final Test Result : **PASS**  
 Pass performance criteria : A  
 Basic Standard : IEC 61000-4-8  
 Model No. : 250LM00005  
 Temperature : 22°C  
 Relative Humidity : 54 %  
 Atmospheric Pressure : 100 kPa  
 Test Date : Sep 19, 2016

Test Mode: Mode 1,5,9,13,17

Power Frequency Magnetic Field : <u>50</u> Hz, <u>1</u> A/m		
Coil Orientation	Testing duration	Results
X-axis	1.0 Min	A
Y-axis	1.0 Min	A
Z-axis	1.0 Min	A
Power Frequency Magnetic Field : <u>60</u> Hz, <u>1</u> A/m		
Coil Orientation	Testing duration	Results
X-axis	1.0 Min	A
Y-axis	1.0 Min	A
Z-axis	1.0 Min	A

Test engineer: Sun. Zhang



### 13.5. Test Photographs



## 14. Voltage Dips and Voltage Interruptions Immunity Test Setup

### 14.1. Test Conditions

1. Source voltage and frequency : AC 100/230/240V / 50Hz, Single phase.
2. Test of interval : 10 sec.
3. Level and duration : Sequence of 3 dips/interrupts.
4. Voltage rise (and fall) time : 1 ~ 5  $\mu$ s.
5. Test severity :

Voltage dips and Interrupt reduction (%)	Test Duration (period)
>95%	250
30%	25
>95%	0.5

### 14.2. TEST SETUP

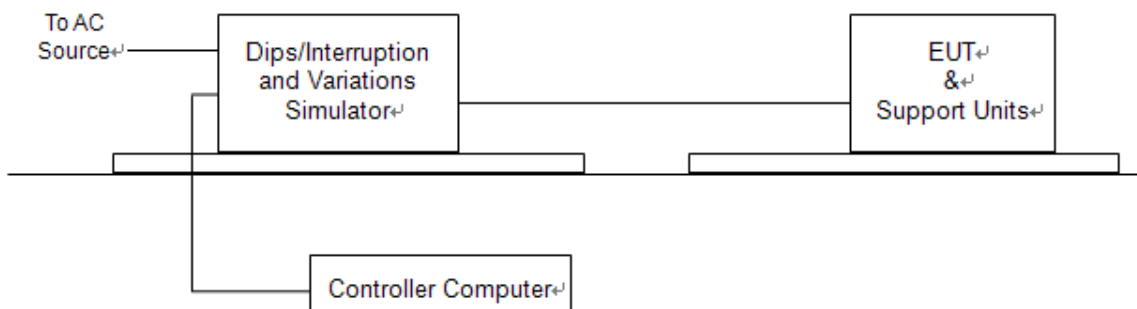

For the actual test configuration, please refer to the related item – Photographs of the Test Configuration.

### 14.3. Measurement Equipment

Instrument/Ancillary	Manufacturer	Model No.	Serial No.	Calibration Date	Valid Date.
TRANSIENT	EMCPARTNER	TRA2000IN6	901	2016.03.26	2017.03.25
Temperature/ Humidity Meter	Zhicheng	ZC1-11	CEP-TH-005	2016.04.02	2017.04.01



14.4. Test Result and Data

Final Test Result : **PASS**  
 Pass performance Criteria : C for voltage interruption, B for voltage dips  
 Basic Standard : IEC 61000-4-11  
 Model No. : 250LM00005  
 Temperature : 22°C  
 Relative Humidity : 54 %  
 Atmospheric Pressure : 100 kPa  
 Test Date : Sep 19, 2016

Test Mode: Mode 1,5,9,13,17

Voltage(UT): AC 230 V/240V 50 Hz Interval(s) : 10s Times : 3										
Test mod	Test level UT %	Durations (period / ms )	Phase / Result							
			0	45	90	135	180	225	270	315
Voltage interruptions	>95%	250	C	C	C	C	C	C	C	C
Voltage dips	30%	25	B	B	B	B	B	B	B	B
	>95%	0.5	B	B	B	B	B	B	B	B

Test Mode: Mode 1,5,9,13,17

Voltage(UT): AC 100 V 50 Hz Interval(s) : 10s Times : 3										
Test mod	Test level UT %	Durations (period / ms )	Phase / Result							
			0	45	90	135	180	225	270	315
Voltage interruptions	>95%	250	C	C	C	C	C	C	C	C
Voltage dips	30%	25	B	B	B	B	B	B	B	B
	>95%	0.5	B	B	B	B	B	B	B	B

Test engineer: Sun. Zhang



### 14.5. Test Photographs





## 15. Photographs of EUT

### 1) EUT Photo



### 2) EUT Photo

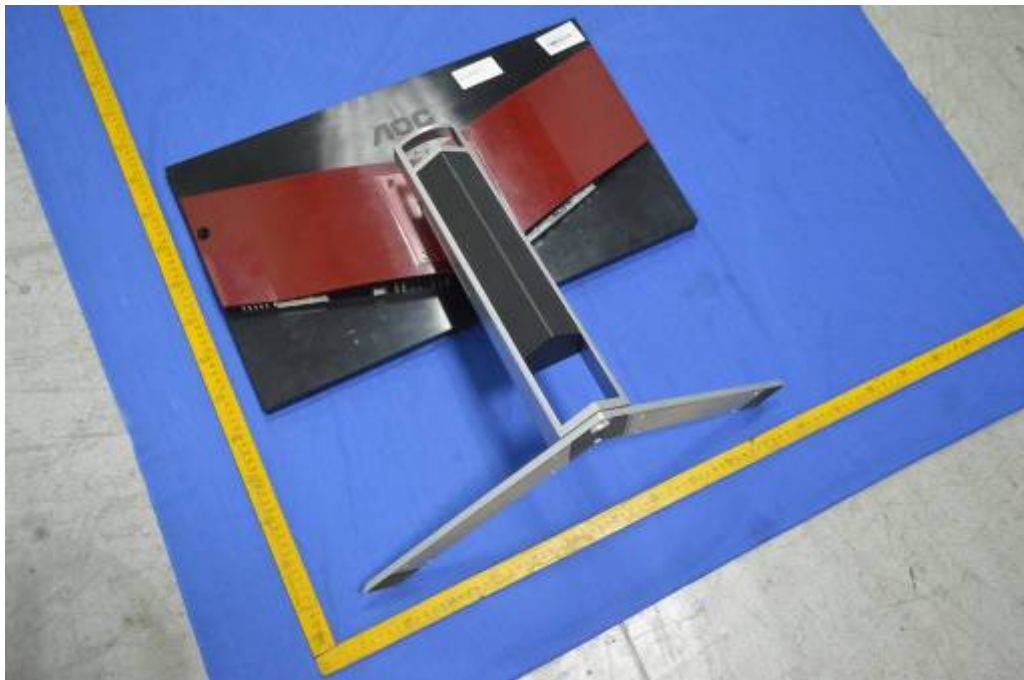



3) EUT Photo



4) EUT Photo

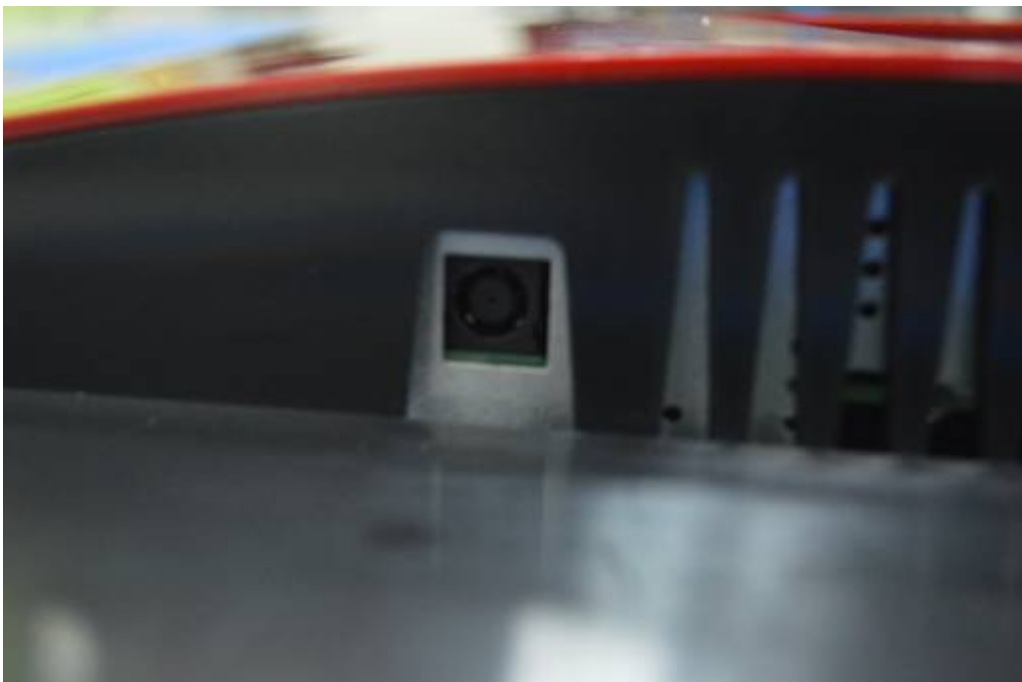





5) EUT Photo



6) EUT Photo





7) EUT Photo



8) EUT Photo





9) EUT Photo



10) EUT Photo





11) EUT Photo

