



FCC DOC TEST REPORT

Applicant : TPV Electronics (Fujian) Co., Ltd.
Address : Rongqiao Economic and Technological
Development Zone, Fuqing City, Fujian Province,
P.R. China
Equipment : LCD Monitor
Model No. : 270LM00027, AG271***

I HEREBY CERTIFY THAT :

The sample was received on Apr. 16, 2016 and the testing was carried out on Apr. 17, 2016 at CerpPASS Technology Corp. The test result refers exclusively to the test presented test model / sample. Without written approval of CerpPASS Technology Corp., the test report shall not be reproduced except in full.

Approved by:

Ray Chou / Assistant Manager

Laboratory Accreditation:

CerpPASS Technology Corporation Test Laboratory





Contents

1. Summary of Test Procedure and Test Result	4
1.1. Applicable Standards	4
2. Test Configuration of Equipment under Test	5
2.1. Feature of Equipment under Test.....	5
2.2. Test Manner	5
2.3. Description of Test System.....	6
2.4. General Information of Test.....	7
2.5. Measurement Uncertainty	7
3. Test of Conducted Emission	8
3.1. Test Limit	8
3.2. Test Procedures	8
3.3. Typical test Setup.....	9
3.4. Measurement Equipment.....	9
3.5. Test Result and Data.....	10
3.6. Test Photographs	12
4. Test of Radiated Emission	13
4.1. Test Limit	13
4.2. Test Procedures	13
4.3. Typical test Setup.....	14
4.4. Measurement Equipment.....	15
4.5. Test Result and Data (30MHz ~ 1GHz).....	16
4.6. Test Result and Data (1GHz ~ 18GHz).....	18
4.7. Test Photographs (30MHz~1GHz)	20
4.8. Test Photographs (1GHz~18GHz)	21
5. Photographs of EUT	22



History of this test report

Report No.	Issue Date	Description
TEFD1604119	May 04, 2016	Original



1. Summary of Test Procedure and Test Result

1.1. Applicable Standards

The measurements shown in this test report were made in accordance with the procedures given in ANSI C63.4 – 2009 and the energy emitted by this equipment was passed Part 2, Part 15, CISPR PUB. 22 and Canada ICES-003 Issue 5.

The energy emitted by this equipment was passed both Radiated and Conducted Emissions Class B limits.

Test Item	Normative References	Test Result	Remarks
Conducted Emission	ANSI C63.4-2009 FCC Part 15 Subpart B KDB17416 ICES-003 Issue 5	PASS	Meets Class B Limit Minimum passing margin(AVG) is -13.21 dB at 1.4420 MHz
Radiated Emission	ANSI C63.4-2009 FCC Part 15 Subpart B KDB17416 ICES-003 Issue 5	PASS	Meets Class B Limit Minimum passing margin(QP) is -4.83 dB at 966.05 MHz



2. Test Configuration of Equipment under Test

2.1. Feature of Equipment under Test

LCD Monitor	Model No.	270LM00027, AG271*** (The "*" could be any alphanumeric character including blank for marketing differentiation.)
Adapter	Model No.	ADPC20120
	Input	100-240V, 50-60Hz
	Output	20V, 6A
Power Cable	Non-Shielding, 1.5m & 1.8m	
Please refer to the user's manual.		

2.2. Test Manner

- a. During testing, the interface cables and equipment positions were varied according to ANSI C63.4.
- b. The complete test system included PC, Keyboard, Mouse, Printer, iPod, Earphone, DVD player, USB 3.0 HDD and EUT for EMI test.
- c. An executive program, "Burnin.exe" under WIN 8, which generates a complete line of continuously repeating "H" pattern were used as the test software.
The program was executed as follows:
 1. Turn on the power of all equipment.
 2. The PC reads the test program from the hard disk drive and runs it.
 3. The PC sends "H" messages to the EUT, and the EUT displays "H" patterns on the screen.
 4. The PC sends "H" messages to the internal Hard Disk, and the Hard Disk reads and writes the message.
 5. The PC sends "H" messages to the printer, then the printer prints them on the paper.
 6. Repeat the steps from 2 to 5.
- d. An executive program, "Burnin.exe" was executed to play 1kHz audio.
- e. An executive program, "Burnin.exe" was executed to read and write data from USB 3.0 HDD.
- f. The test modes of EMI test as follow:
<Mainboard 1, Panel 1>
 - Test Mode 1. AC 120V, VGA: 1920 x 1080@60Hz for Horizontal
 - Test Mode 2. AC 120V, VGA: 1280 x 1024@75Hz for Horizontal
 - Test Mode 3. AC 120V, VGA: 640 x 480@60Hz for Horizontal
 - Test Mode 4. AC 120V, VGA: 1920 x 1080@60Hz for Vertical
 - Test Mode 5. AC 120V, DVI: 2560 x 1440@144Hz for Horizontal
 - Test Mode 6. AC 120V, DVI: 1280 x 1024@75Hz for Horizontal
 - Test Mode 7. AC 120V, DVI: 640 x 480@60Hz for Horizontal
 - Test Mode 8. AC 120V, DVI: 2560 x 1440@144Hz for Vertical
 - Test Mode 9. AC 120V, HDMI 1: 2560 x 1440@144Hz for Horizontal
 - Test Mode 10. AC 120V, HDMI 1: 1280 x 1024@75Hz for Horizontal
 - Test Mode 11. AC 120V, HDMI 1: 640 x 480@60Hz for Horizontal
 - Test Mode 12. AC 120V, HDMI 1: 2560 x 1440@144Hz for Vertical
 - Test Mode 13. AC 120V, HDMI 2: 2560 x 1440@144Hz for Horizontal
 - Test Mode 14. AC 120V, HDMI 2: 1280 x 1024@75Hz for Horizontal
 - Test Mode 15. AC 120V, HDMI 2: 640 x 480@60Hz for Horizontal
 - Test Mode 16. AC 120V, HDMI 2: 2560 x 1440@144Hz for Vertical
 - Test Mode 17. AC 120V, Display: 2560 x 1440@144Hz for Horizontal
 - Test Mode 18. AC 120V, Display: 1280 x 1024@75Hz for Horizontal
 - Test Mode 19. AC 120V, Display: 640 x 480@60Hz for Horizontal
 - Test Mode 20. AC 120V, Display: 2560 x 1440@144Hz for Vertical
 - Test Mode 21. AC 120V, 1080P DVD mode for Horizontal



<Mainboard 2, Panel 2>

Test Mode 22. AC 120V, HDMI: 2560 x 1440@144Hz for Horizontal

Test Mode 23. AC 120V, HDMI: 1280 x 1024@75Hz for Horizontal

Test Mode 24. AC 120V, HDMI: 640 x 480@60Hz for Horizontal

Test Mode 25. AC 120V, HDMI: 2560 x 1440@144Hz for Vertical

Test Mode 26. AC 120V, Display: 2560 x 1440@144Hz for Horizontal

Test Mode 27. AC 120V, Display: 1280 x 1024@75Hz for Horizontal

Test Mode 28. AC 120V, Display: 640 x 480@60Hz for Horizontal

Test Mode 29. AC 120V, Display: 2560 x 1440@144Hz for Vertical

Test Mode 30. AC 120V, 1080P DVD mode for Horizontal

<Mainboard 1, Panel 1>

Test Mode 31. AC 240V, VGA: 1920 x 1080@60Hz for Horizontal

The "Test Mode 1" generated the worst test result, it was reported as final data.

- g. The maximum operating frequency is above 108MHz, the test frequency range is from 30MHz to 18GHz.

2.3. Description of Test System

Device	Manufacturer	Model No.	Description
PC	DELL	XPS8700	Power Cable, Non-Shielded, 1.8m
Keyboard	DELL	SK-8175	USB Cable, Shielding 1.85m
Mouse	DELL	MS111-P	USB Cable, Shielding 1.85m
Printer	HP	P1102w	Power Cable, Non-Shielded 1.8m USB Cable, Shielding 1.6m
iPod	APPLE	A1320	USB Cable, Shielding 1m
Earphone*2	INTOPIC	JAZZ-269	Audio Cable, Unshielding 1.35m
DVD player	SONY	DVP-NS718HP	Power Cable, Unshielding, 1.8m
USB 3.0 HDD*4	WD	WD1600BEVT/P	USB 3.0 Cable, Shielding 1.0m

Use Cable:

Cable	Quantity	Description
VGA	1	Shielding, 1.8m with two ferrite cores bonded
VGA	1	Shielding, 1.5m with two ferrite cores bonded
DVI	1	Shielding, 1.8m with two ferrite cores bonded
DVI	1	Shielding, 1.5m with two ferrite cores bonded
HDMI	2	Shielding, 1.8m
HDMI	2	Shielding, 1.5m
Display	1	Shielding, 1.8m
Display	1	Shielding, 1.5m
USB 3.0 A to B	1	Shielding, 1.8m
Mini USB	1	Shielding, 1.8m



2.4. General Information of Test

Test Site :	Cerpass Technology Corporation Test Laboratory Address: No.10, Ln. 2, Lianfu St., Luzhu Dist., Taoyuan City 33848, Taiwan (R.O.C.) Tel:+886-3-3226-888 Fax:+886-3-3226-881 Address: No.68-1, Shihbachongsi, Shihding Township, New Taipei City 223, Taiwan, R.O.C. Tel: +886-2-2663-8582
FCC Registration Number :	TW1079, TW1061,390316, 228391, 641184
IC Registration Number :	4934E-1, 4934E-2
VCCI	T-2205 for Telecommunication Test C-4663 for Conducted emission test R-3428, R-4218 for Radiated emission test G-812, G-813 for radiated disturbance above 1GHz
Frequency Range Investigated :	Conducted Emission Test: from 150 kHz to 30 MHz Radiated Emission Test: from 30 MHz to 18,000 MHz
Test Distance :	The test distance of radiated emission below 1GHz from antenna to EUT is 10 M. The test distance of radiated emission above 1GHz from antenna to EUT is 3 M.

2.5. Measurement Uncertainty

Measurement Item	Measurement Frequency	Polarization	Uncertainty
Conducted Emission	9 kHz ~ 30 MHz	LINE / NEUTRAL	± 3.25 dB
Radiated Emission	30 MHz ~ 1,000 MHz	Vertical / Horizontal	± 3.93 dB
	1,000 MHz ~ 6,000 MHz	Vertical / Horizontal	± 4.01 dB
	6,000 MHz ~ 18,000 MHz	Vertical / Horizontal	± 4.72 dB

The measurement uncertainty will be considered, when test result margin to the limit.



3. Test of Conducted Emission

3.1. Test Limit

Conducted Emissions were measured from 150 kHz to 30 MHz with a bandwidth of 9 KHz, according to the methods defined in ANSI C63.4-2009. The EUT was placed on a nonmetallic stand in a shielded room 0.8 meters above the ground plane. The interface cables and equipment positioning were varied within limits of reasonable applications to determine the position produced maximum conducted emissions.

Conducted Emission Limits:

Frequency (MHz)	Quasi Peak (dB μ V)	Average (dB μ V)
0.15 – 0.5	66-56*	56-46*
0.5 – 5.0	56	46
5.0 – 30.0	60	50

3.2. Test Procedures

- a. The EUT was placed 0.4 meter from the conducting wall of the shielding room was kept at least 80 centimeters from any other grounded conducting surface.
- b. Connect EUT to the power mains through a line impedance stabilization network (LISN).
- c. All the support units are connecting to the other LISN.
- d. The LISN provides 50 ohm coupling impedance for the measuring instrument.
- e. The FCC states that a 50 ohm, 50 micro-Henry LISN should be used.
- f. Both sides of AC line were checked for maximum conducted interference.
- g. The frequency range from 150 kHz to 30 MHz was searched.
- h. Set the test-receiver system to Peak Detect Function and Specified Bandwidth with Maximum Hold Mode.

3.3. Typical test Setup

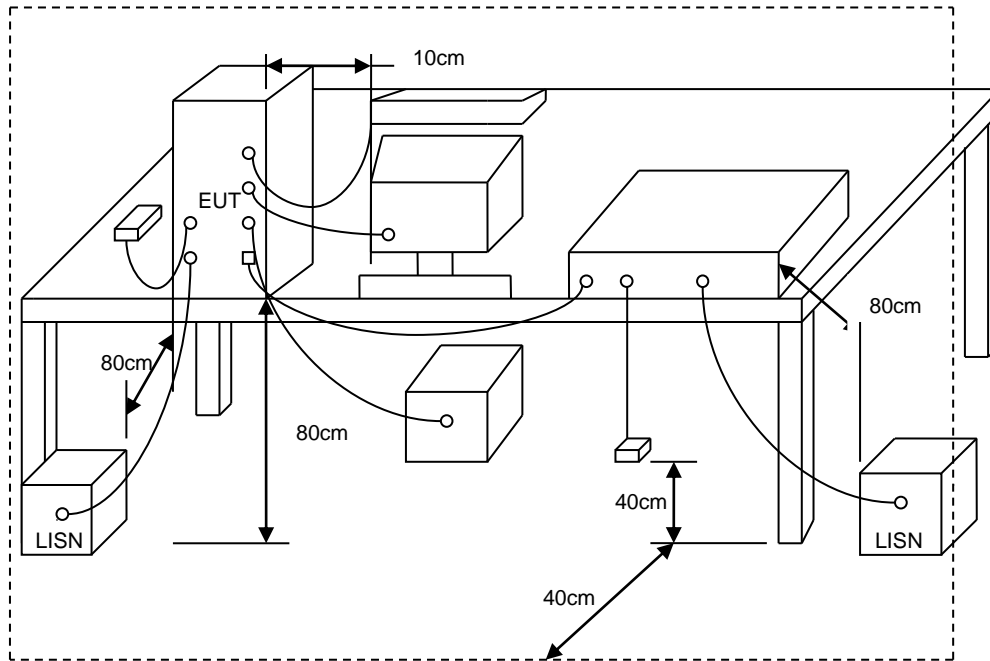

3.4. Measurement Equipment

Instrument	Manufacturer	Model No.	Serial No.	Calibration Date	Valid Date
EMI Receiver	R&S	ESCI3	100443	2016/03/28	2017/03/27
LISN	Schwarzbeck	NSLK 8127	8127-516	2016/03/11	2017/03/10
LISN	Schwarzbeck	NSLK 8127	8127-740	2015/09/03	2016/09/02
Pulse Limiter	R&S	ESH3-Z2	101933	2015/08/25	2016/08/24
Software	Farad	Ez-EMC	ver.ct3a1	N/A	N/A



3.5. Test Result and Data

Power	: AC 120V	Pol/Phase	: LINE
Test Mode	: Mode 1	Temperature	: 26 °C
Test Date	: Apr. 16, 2016	Humidity	: 48 %
Model No.	: 270LM00027	Atmospheric Pressure	: 1008 hPa

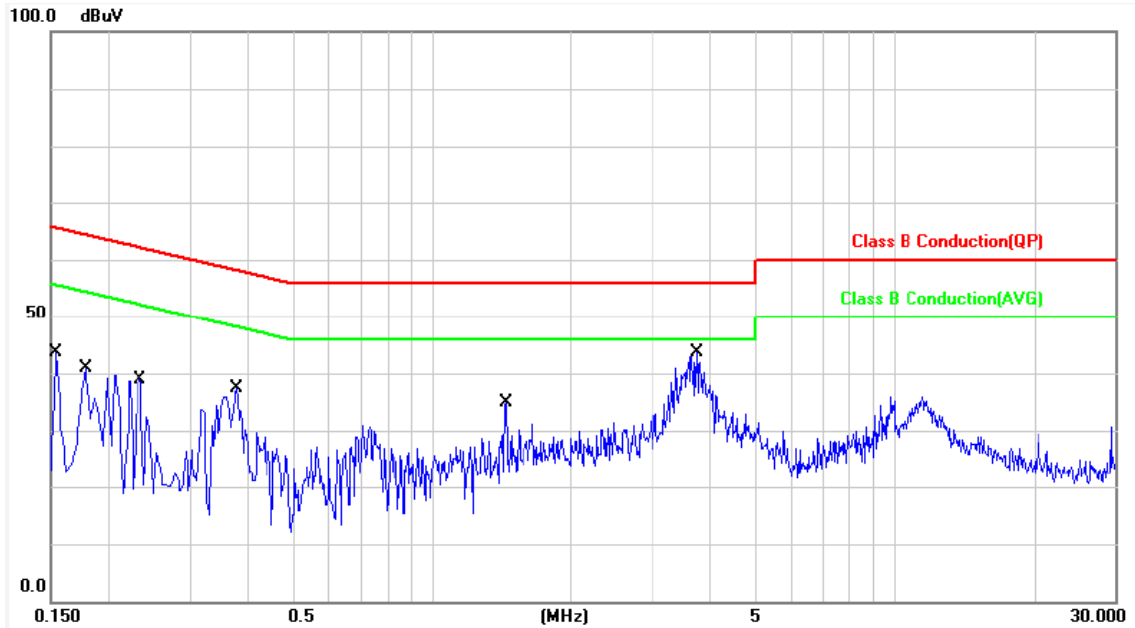

No.	Frequency (MHz)	Factor (dB)	Reading (dBuV)	Level (dBuV)	Limit (dBuV)	Margin (dB)	Detector	P/F
1	0.1539	9.99	31.44	41.43	65.78	-24.35	QP	P
2	0.1539	9.99	14.41	24.40	55.78	-31.38	AVG	P
3	0.1780	10.00	27.62	37.62	64.57	-26.95	QP	P
4	0.1780	10.00	11.54	21.54	54.57	-33.03	AVG	P
5	0.2340	10.01	25.03	35.04	62.30	-27.26	QP	P
6	0.2340	10.01	7.88	17.89	52.30	-34.41	AVG	P
7	0.3780	10.04	25.39	35.43	58.32	-22.89	QP	P
8	0.3780	10.04	11.99	22.03	48.32	-26.29	AVG	P
9	1.4420	10.07	23.77	33.84	56.00	-22.16	QP	P
10	1.4420	10.07	22.58	32.65	46.00	-13.35	AVG	P
11	3.7420	10.20	29.26	39.46	56.00	-16.54	QP	P
12	3.7420	10.20	19.43	29.63	46.00	-16.37	AVG	P

Note: Level = Reading + Factor
 Margin = Level – Limit
 Factor = (LISN, ISN, PLC or current probe) Factor + Cable Loss+ Attenuator



Power	: AC 120V	Pol/Phase	: NEUTRAL
Test Mode	: Mode 1	Temperature	: 26 °C
Test Date	: Apr. 16, 2016	Humidity	: 48 %
Model No.	: 270LM00027	Atmospheric Pressure	: 1008 hPa

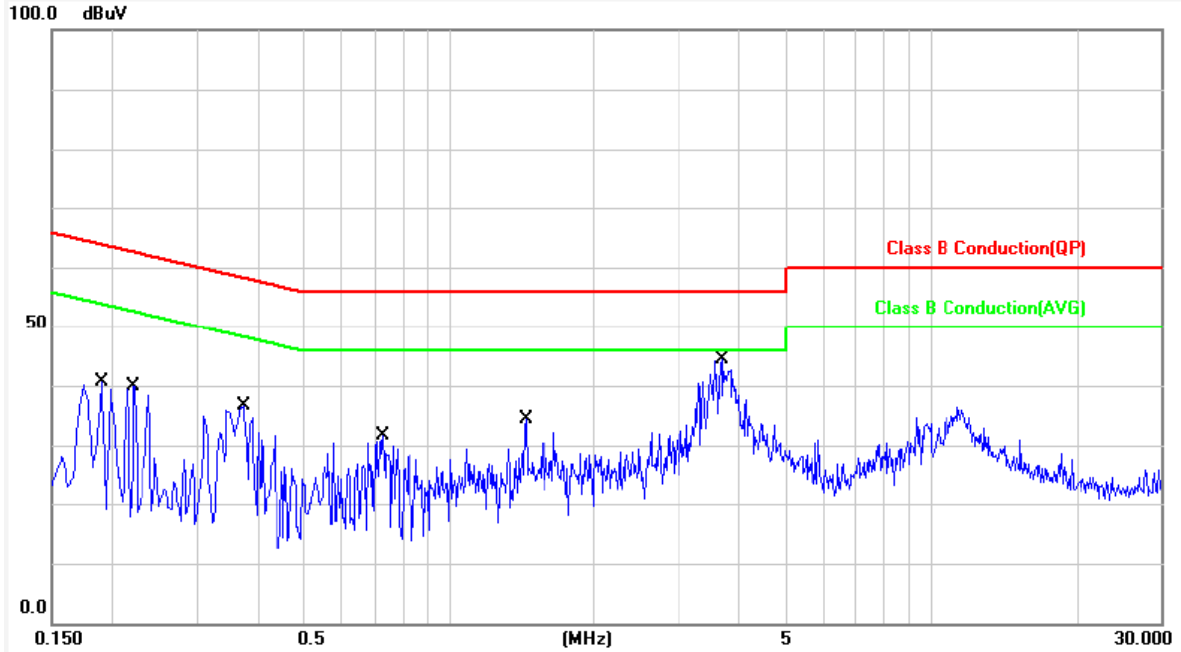

No.	Frequency (MHz)	Factor (dB)	Reading (dBuV)	Level (dBuV)	Limit (dBuV)	Margin (dB)	Detector	P/F
1	0.1900	9.97	26.80	36.77	64.03	-27.26	QP	P
2	0.1900	9.97	12.62	22.59	54.03	-31.44	AVG	P
3	0.2220	9.97	24.98	34.95	62.74	-27.79	QP	P
4	0.2220	9.97	7.47	17.44	52.74	-35.30	AVG	P
5	0.3740	9.99	25.16	35.15	58.41	-23.26	QP	P
6	0.3740	9.99	11.85	21.84	48.41	-26.57	AVG	P
7	0.7300	10.00	16.89	26.89	56.00	-29.11	QP	P
8	0.7300	10.00	6.04	16.04	46.00	-29.96	AVG	P
9	1.4420	10.06	23.89	33.95	56.00	-22.05	QP	P
10	1.4420	10.06	22.73	32.79	46.00	-13.21	AVG	P
11	3.6980	10.21	27.14	37.35	56.00	-18.65	QP	P
12	3.6980	10.21	17.70	27.91	46.00	-18.09	AVG	P

Note: Level = Reading + Factor
 Margin = Level – Limit
 Factor = (LISN, ISN, PLC or current probe) Factor + Cable Loss+ Attenuator

Test engineer: Yen



3.6. Test Photographs

Front View



Rear View

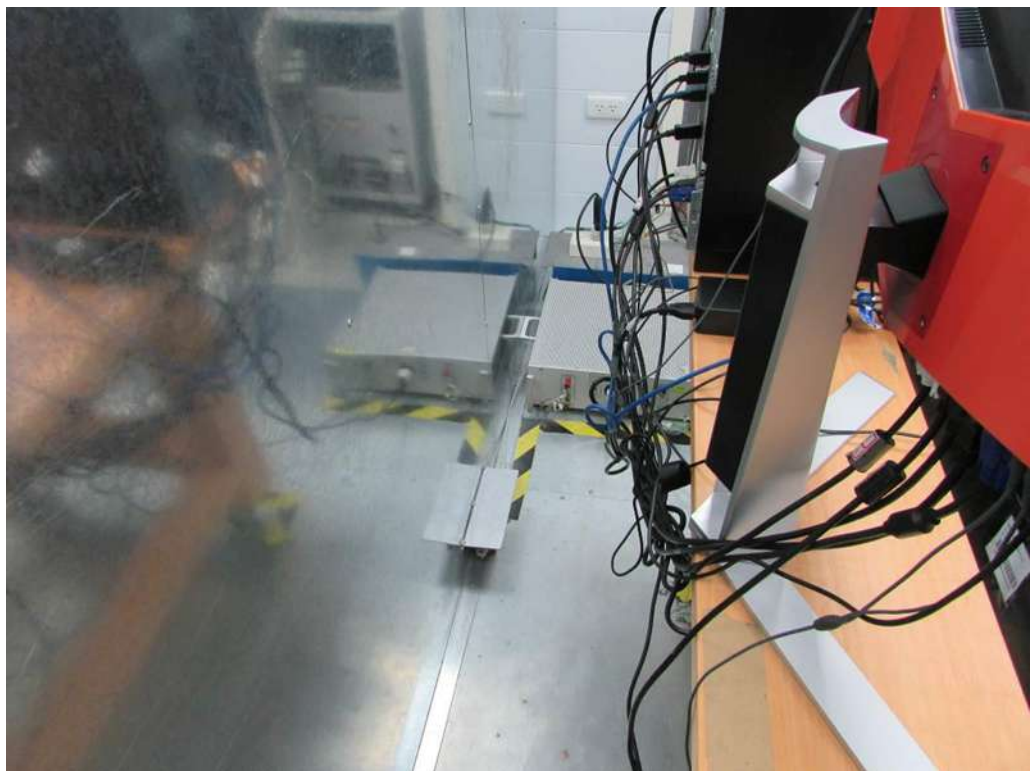



4. Test of Radiated Emission

4.1. Test Limit

Radiated emissions from 30 MHz to 18,000 MHz were measured with a bandwidth of 120 kHz according to the methods defines in ANSI C63.4-2009. The EUT was placed on a nonmetallic stand in the open-field site, 0.8 meter above the ground plane. The interface cables and equipment positions were varied within limits of reasonable applications to determine the positions producing maximum radiated emissions.

For unintentional device, according to § 15.109(a), except for Class A digital devices, the field strength of radiated emissions from unintentional radiators at a distance of 3 meters shall not exceed the following values:

Frequency (MHz)	Distance Meters	Radiated ($\mu\text{V} / \text{M}$)	Radiated (dB $\mu\text{V} / \text{M}$)
30-88	3	100	40.0
88-216	3	150	43.5
216-960	3	200	46.0
Above 960	3	500	54.0

For unintentional device, according to CISPR PUB.22, for Class B digital devices, the general requirement of field strength of radiated emissions from intentional radiators at a distance of 10 meters shall not exceed the below table.

Frequency (MHz)	Distance Meters	Radiated (dB $\mu\text{V} / \text{M}$)
30-230	10	30
230-1000	10	37

4.2. Test Procedures

- The EUT was placed on a Rota table top 0.8 meter above ground.
- The EUT was set 3/10 meters from the interference receiving antenna which was mounted on the top of a variable height antenna tower.
- The table was rotated 360 degrees to determine the position of the highest radiation.
- The antenna is a half wave dipole and its height is varied between one meter and four meters above ground to find the maximum value of the field strength both horizontal polarization and vertical polarization of the antenna are set to make the measurement.
- For each suspected emission the EUT was arranged to its worst case and then tune the antenna tower (from 1 M to 4 M) and turn table (from 0 degree to 360 degrees) to find the maximum reading.
- Set the test-receiver system to Peak Detect Function and specified bandwidth with Maximum Hold Mode.
- If the emission level of the EUT in peak mode was 6 dB lower than the limit specified, then testing will be stopped and peak values of EUT will be reported, otherwise, the emissions which do not have 6 dB margin will be repeated one by one using the quasi-peak method and reported.



4.3. Typical test Setup

Below 1GHz Test Setup

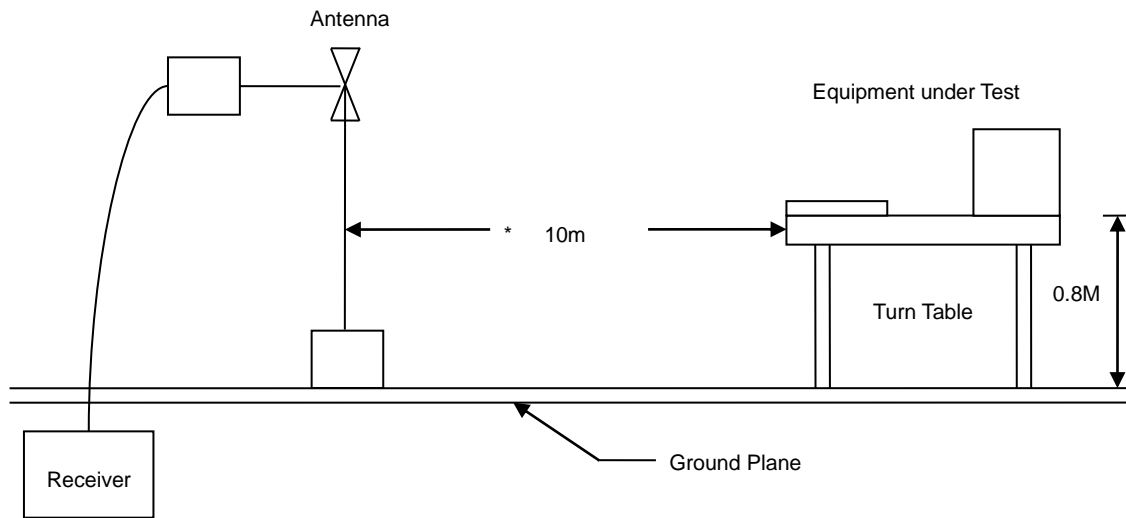

Above 1GHz Test Setup

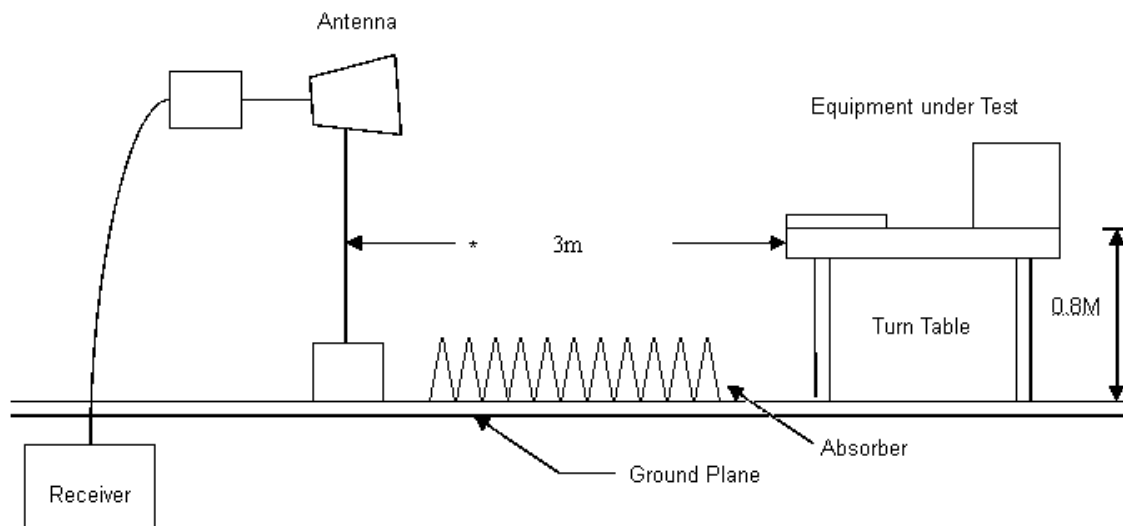



4.4. Measurement Equipment

Instrument	Manufacturer	Model No.	Serial No.	Calibration Date	Valid Date
Bilog Antenna	Sunol	JB1	A020514-2	2016/03/17	2017/03/16
Bilog Antenna	Sunol	JB1	A020514-1	2016/02/17	2017/02/16
EMI Receiver	R&S	ESCI7	100963	2016/02/25	2017/02/24
EMI Receiver	R&S	ESCI3	101402	2016/02/18	2017/02/17
Preamplifier	EM Electronics corp.	EM330	60610	2016/02/24	2017/02/23
Preamplifier	EM Electronics corp.	EM330	60611	2016/02/15	2017/02/14
Software	E3	AUDIX	Version:8. 2014-6-4	N/A	N/A
Spectrum Analyzer	R&S	FSP40	100219	2015/09/01	2016/08/31
Horn Antenna	EMCO	3115	31601	2015/09/02	2016/09/01
Preamplifier	Agilent	8449B	3008A01954	2016/03/04	2017/03/03
Software	Farad	Ez-EMC	ver.ct3a1	N/A	N/A



4.5. Test Result and Data (30MHz ~ 1GHz)

Power	: AC 120V	Pol/Phase	: VERTICAL
Test Mode	: Mode 1	Temperature	: 25 °C
Test Date	: Apr. 17, 2016	Humidity	: 50 %
Model No.	: 270LM00027	Atmospheric Pressure	: 1005 hPa

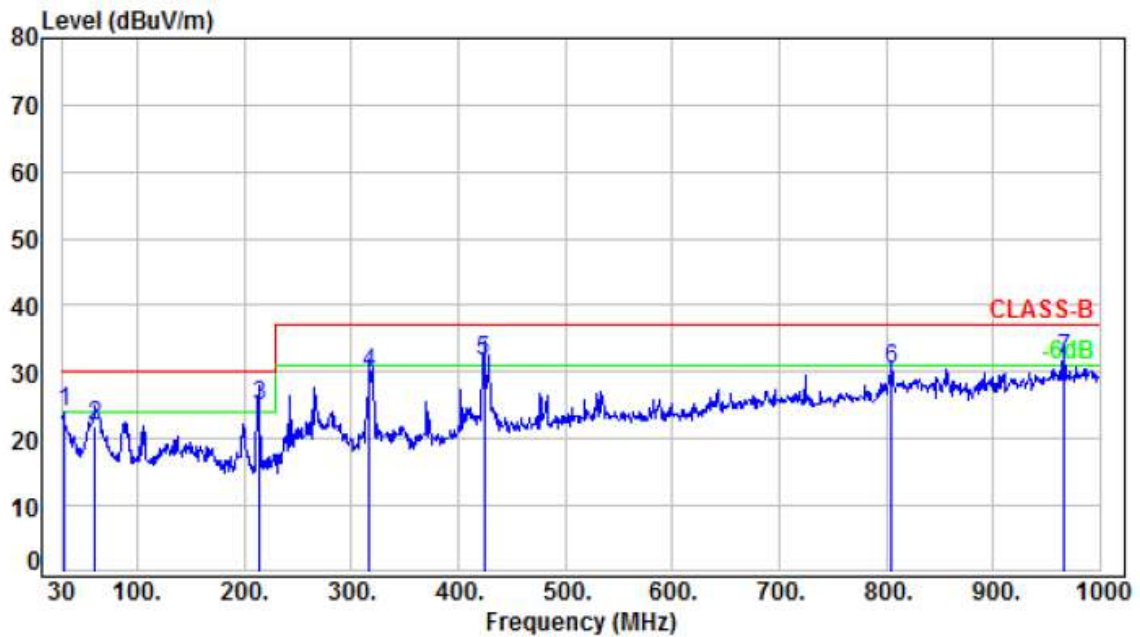

No.	Frequency (MHz)	Factor (dB/m)	Reading (dBuV)	Level (dBuV/m)	Limit (dBuV/m)	Margin (dB)	Detector	Height (cm)	Azimuth (°)	P/F
1	30.97	-3.69	27.61	23.92	30	-6.08	Peak	100	140	P
2	60.07	-16.09	38.13	22.04	30	-7.96	QP	200	229	P
3	213.33	-12.05	36.9	24.85	30	-5.15	QP	100	52	P
4	317.12	-8.05	37.94	29.89	37	-7.11	QP	100	353	P
5	423.82	-4.93	36.7	31.77	37	-5.23	QP	400	196	P
6	805.03	2.24	28.13	30.37	37	-6.63	QP	300	17	P
7	966.05	4.56	27.39	31.95	37	-5.05	QP	300	120	P

Note: Level = Reading + Factor
 Margin = Level – Limit
 Factor = Antenna factor + Cable loss - Amplifier factor



Power	: AC 120V	Pol/Phase	: HORIZONTAL
Test Mode	: Mode 1	Temperature	: 25 °C
Test Date	: Apr. 17, 2016	Humidity	: 50 %
Model No.	: 270LM00027	Atmospheric Pressure	: 1005 hPa

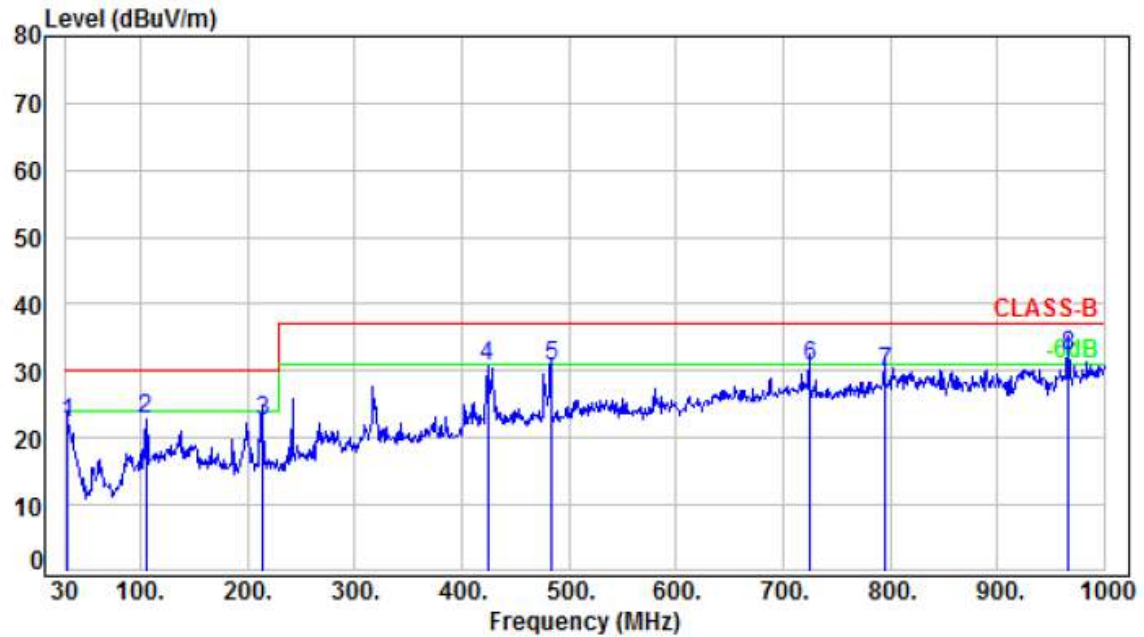

No.	Frequency (MHz)	Factor (dB/m)	Reading (dBuV)	Level (dBuV/m)	Limit (dBuV/m)	Margin (dB)	Detector	Height (cm)	Azimuth (°)	P:F
1	30.97	-3.14	25.28	22.14	30	-7.86	QP	300	285	P
2	104.69	-11.59	34.42	22.83	30	-7.17	Peak	400	73	P
3	213.33	-11.81	34.35	22.54	30	-7.46	QP	400	182	P
4	423.82	-4.78	35.51	30.73	37	-6.27	Peak	300	259	P
5	482.99	-3.18	34.03	30.85	37	-6.15	QP	200	37	P
6	724.52	0.96	29.63	30.59	37	-6.41	QP	100	132	P
7	794.36	2.06	27.88	29.94	37	-7.06	QP	100	120	P
8	966.05	4.6	27.57	32.17	37	-4.83	QP	100	44	P

Note: Level = Reading + Factor
Margin = Level – Limit
Factor = Antenna factor + Cable loss - Amplifier factor

Test engineer: Cap



4.6. Test Result and Data (1GHz ~ 18GHz)

Power	: AC 120V	Pol/Phase	: VERTICAL
Test Mode	: Mode 1	Temperature	: 22.3 °C
Test Date	: Apr. 17, 2016	Humidity	: 49 %
Model No.	: 270LM00027	Atmospheric Pressure	: 1008 hPa

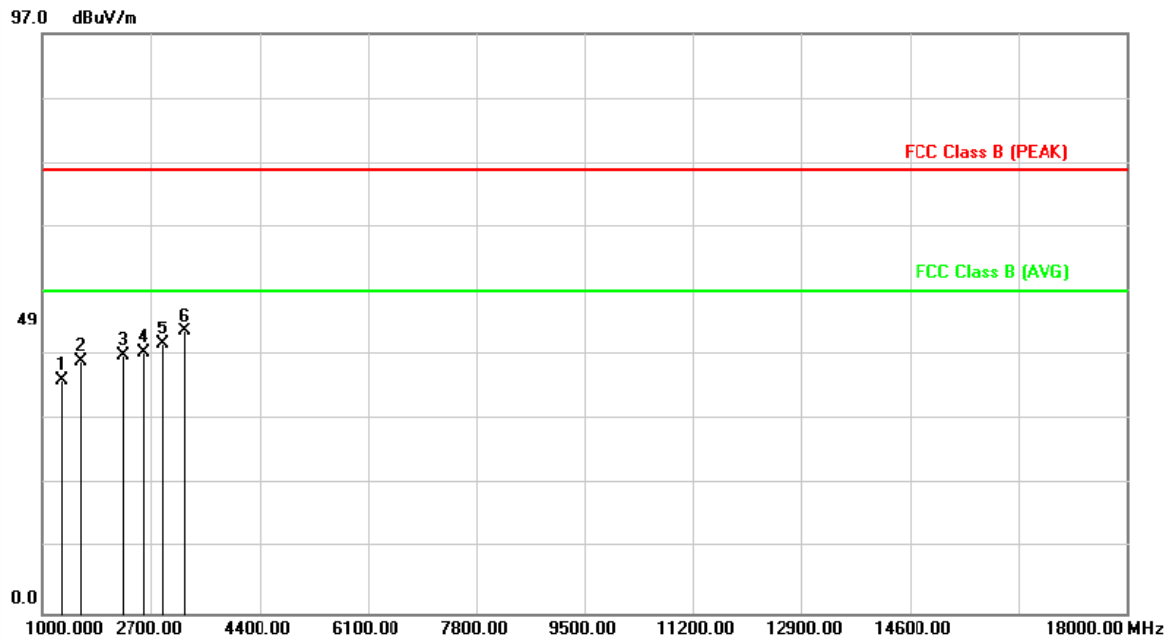

No.	Frequency (MHz)	Factor (dB/m)	Reading (dBuV)	Level (dBuV/m)	Limit (dBuV/m)	Margin (dB)	Detector	Height (cm)	Azimuth (°)	P/F
1	1306.000	-6.92	45.77	38.85	74.00	-35.15	peak	100	0	P
2	1595.000	-4.96	46.96	42.00	74.00	-32.00	peak	100	0	P
3	2258.000	-1.36	44.30	42.94	74.00	-31.06	peak	100	0	P
4	2598.000	-0.10	43.74	43.64	74.00	-30.36	peak	100	0	P
5	2887.000	1.36	43.56	44.92	74.00	-29.08	peak	100	0	P
6	3227.000	2.82	44.45	47.27	74.00	-26.73	peak	100	0	P

Note: Level = Reading + Factor
Margin = Level – Limit
Factor = Antenna factor + Cable loss - Amplifier factor



Power	: AC 120V	Pol/Phase	: HORIZONTAL
Test Mode	: Mode 1	Temperature	: 22.3 °C
Test Date	: Apr. 17, 2016	Humidity	: 49 %
Model No.	: 270LM00027	Atmospheric Pressure	: 1008 hPa

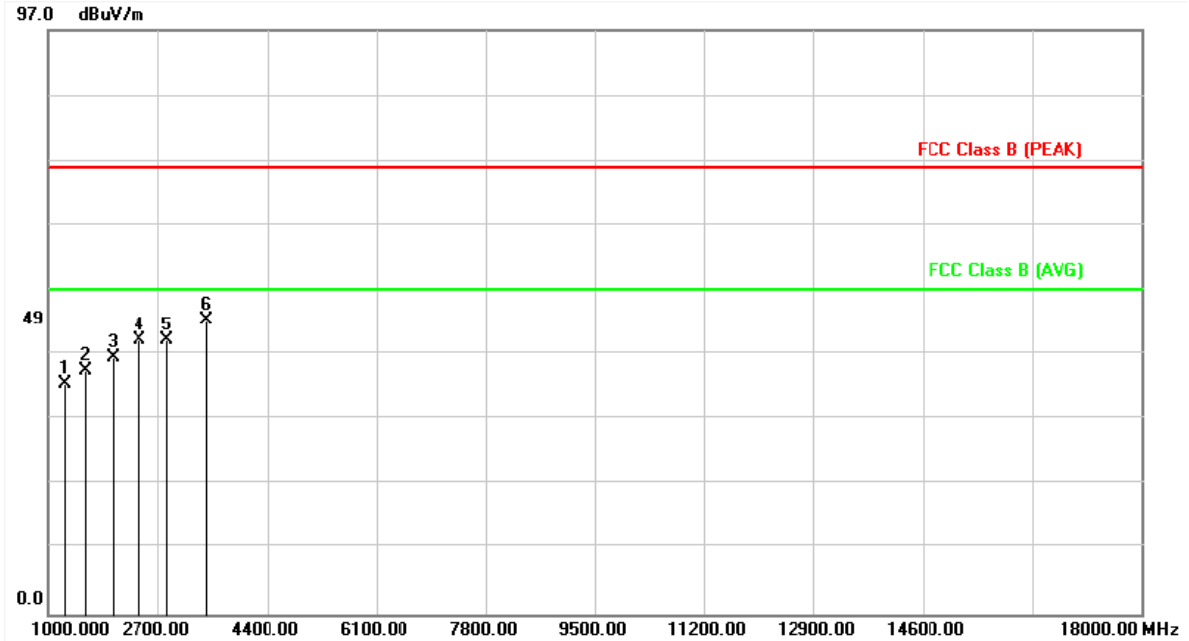

No.	Frequency (MHz)	Factor (dB/m)	Reading (dBuV)	Level (dBuV/m)	Limit (dBuV/m)	Margin (dB)	Detector	Height (cm)	Azimuth (°)	P/F
1	1255.000	-7.28	45.59	38.31	74.00	-35.69	peak	200	0	P
2	1578.000	-5.08	45.37	40.29	74.00	-33.71	peak	200	0	P
3	2003.000	-2.17	44.81	42.64	74.00	-31.36	peak	200	0	P
4	2411.000	-0.88	46.25	45.37	74.00	-28.63	peak	200	0	P
5	2853.000	1.19	44.16	45.35	74.00	-28.65	peak	200	0	P
6	3465.000	3.77	45.11	48.88	74.00	-25.12	peak	200	0	P

Note: Level = Reading + Factor
 Margin = Level – Limit
 Factor = Antenna factor + Cable loss - Amplifier factor

Test engineer: Ken



4.7. Test Photographs (30MHz~1GHz)

Front View



Rear View





4.8. Test Photographs (1GHz~18GHz)

Front View



Rear View

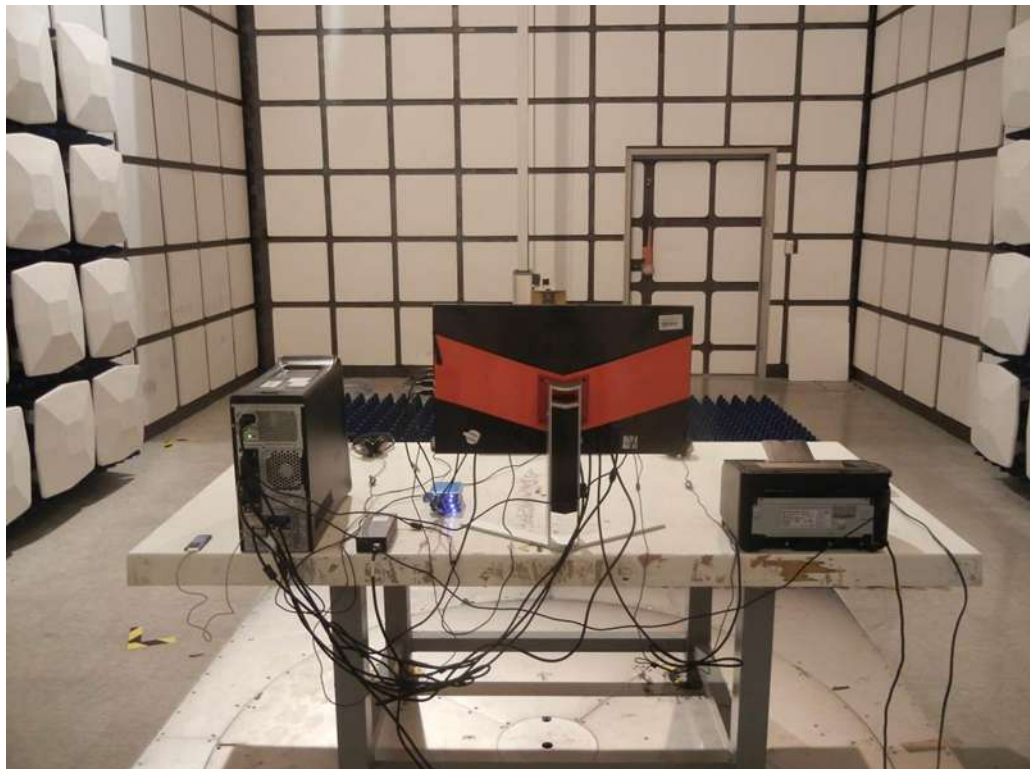



5. Photographs of EUT

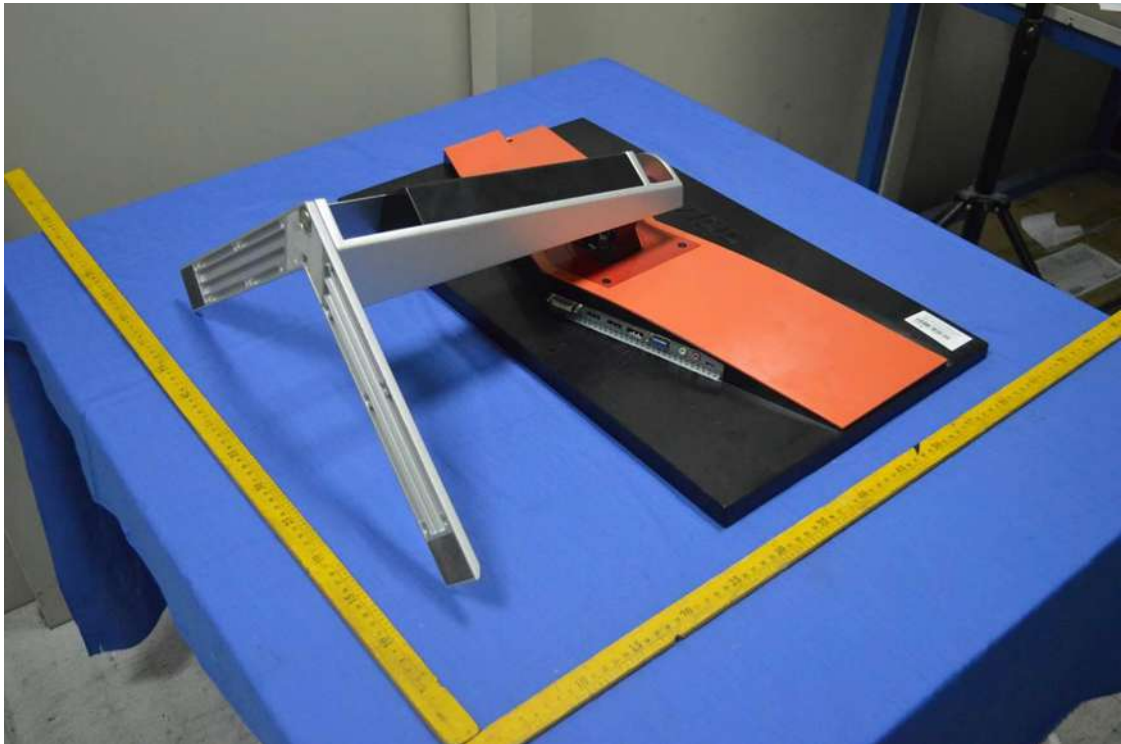
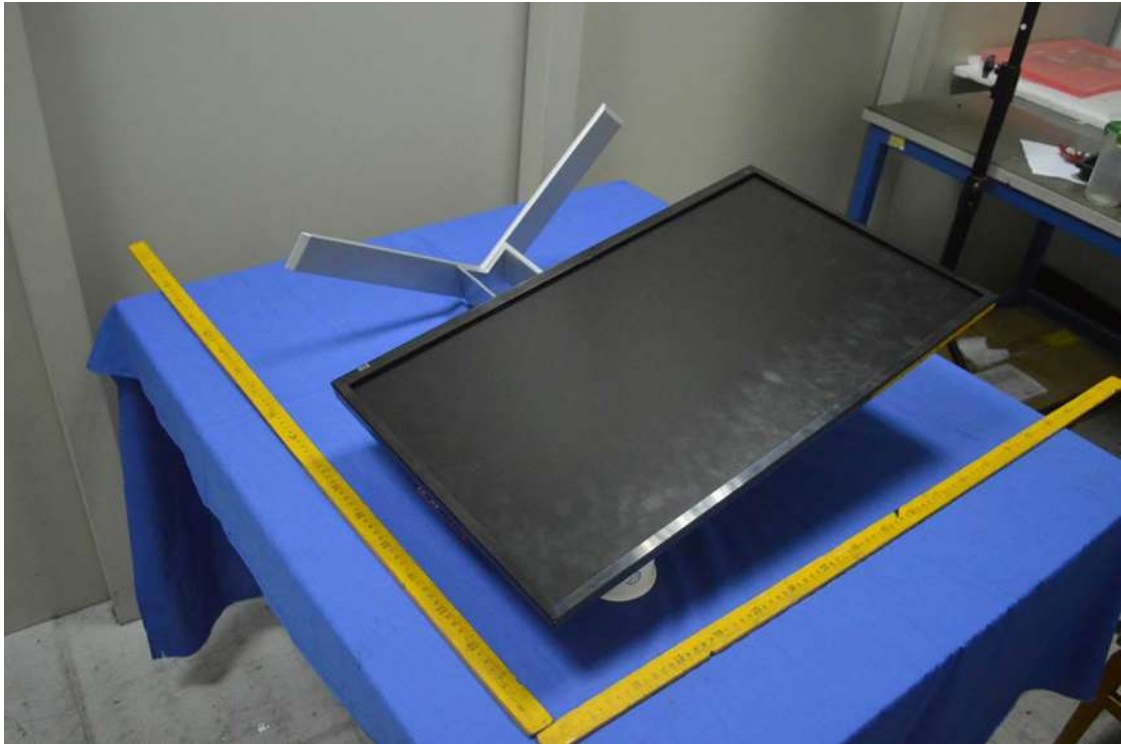



Mainboard 1



Mainboard 2





