

**CB TEST CERTIFICATE CERTIFICAT D'ESSAI OC**Product  
Produit

LCD monitor

Name and address of the applicant  
Nom et adresse du demandeurTaiwan BOE Vision-electronic Technology Co., Ltd.  
7th Fl., No. 2, Rei Kuang Road, Nei Hu, Taipei  
TaiwanName and address of the manufacturer  
Nom et adresse du fabricantTaiwan BOE Vision-electronic Technology Co., Ltd.  
7th Fl., No. 2, Rei Kuang Road, Nei Hu, Taipei  
TaiwanName and address of the factory  
Nom et adresse de l'usineK Tronics (Suzhou) Technology Co., Ltd.  
No.1700 Zhongshan North Road, Economic and  
Technological Development Zone, Wujiang District,  
Suzhou, Jiangsu Province, P.R.  
ChinaNote: When more than one factory, please report on page 2  
Note: Lorsque il y plus d'une usine, veuillez utiliser la deuxième page Additional information on page 2Ratings and principal characteristics  
Valeurs nominales et caractéristiques principales1.5A 100-240Vac, 50/60Hz  
Cl. ITrademark (if any)  
Marque de fabrique (si elle existe)

AOC

Type of Manufacturer's Testing Laboratories used  
Type de programme du laboratoire d'essais constructeurModel / Type Ref.  
Ref. De type

E2275SW\*\*

Additional information (if necessary may also be  
reported on page 2)

The \* in the model name can be alphameric or blank

Les informations complémentaires (si nécessaire,  
peuvent être indiqués sur la deuxième page Additional information on page 2A sample of the product was tested and found  
to be in conformity withUn échantillon de produit a été essayé et a été  
considéré conforme à la

IEC 60950-1(ed.2);am1;am2

As shown in the Test Report Ref. No. which forms part  
of this Certificate

296234



Comme indiqué dans le Rapport de tests numéro de  
référence qui constitue partie de ce CertificatThis CB Test Certificate is issued by the National Certification Body  
Ce Certificat de test OC est établi par l'Organisme **National de Certification**Gaustadalléen 30  
NO-0373 Oslo, Norway

Date: 04-11-2015

Signature: Okhyun Jeon  
Certification Department



<b>TEST REPORT</b> <b>IEC 60950-1</b> <b>Information technology equipment – Safety –</b> <b>Part 1: General requirements</b>	
<b>Report Number</b> .....	296234
<b>Date of issue</b> .....	4 November, 2015
<b>Total number of pages</b> .....	53 pages and refer to page 3
<b>Applicant's name</b> .....	Taiwan BOE Vision-electronic Technology Co., Ltd.
<b>Address</b> .....	7 <sup>th</sup> Fl., No. 2, Rei Kuang Road, Nei Hu, Taipei, Taiwan
<b>Test specification:</b>	
<b>Standard</b> .....	IEC 60950-1:2005 (Second Edition) + Am 1:2009 + Am 2:2013
<b>Test procedure</b> .....	CB Scheme
<b>Non-standard test method</b> .....	N/A
<b>Test Report Form No.</b> .....	IEC60950_1F
<b>Test Report Form(s) Originator</b> .....	SGS Fimko Ltd
<b>Master TRF</b> .....	Dated 2014-02
<b>Copyright © 2014 IEC System of Conformity Assessment Schemes for Electrotechnical Equipment and Components (IECEE System). All rights reserved.</b>	
This publication may be reproduced in whole or in part for non-commercial purposes as long as the IECEE is acknowledged as copyright owner and source of the material. IECEE takes no responsibility for and will not assume liability for damages resulting from the reader's interpretation of the reproduced material due to its placement and context.	
If this Test Report Form is used by non-IECEE members, the IECEE/IEC logo and the reference to the CB Scheme procedure shall be removed.	
<b>This report is not valid as a CB Test Report unless signed by an approved CB Testing Laboratory and appended to a CB Test Certificate issued by an NCB in accordance with IECEE 02.</b>	
<b>General disclaimer:</b>	
The test results presented in this report relate only to the object tested. This report shall not be reproduced, except in full, without the written approval of the Issuing CB Testing Laboratory. The authenticity of this Test Report and its contents can be verified by contacting the NCB, responsible for this Test Report.	
<b>Test item description</b> .....	LCD monitor
<b>Trade Mark</b> .....	AOC
<b>Manufacturer</b> .....	Same as applicant
<b>Model/Type reference</b> .....	E2275SW** (the * in the model name can be alphameric or blank)
<b>Ratings</b> .....	I/P: Cl. I 1.5A 100-240V~ 50/60Hz

<b>Testing procedure and testing location:</b>		
<input checked="" type="checkbox"/>	<b>CB Testing Laboratory:</b>	Nemko Taiwan
<b>Testing location/ address.....:</b>		5 Fl., No. 409, Sec.2, Tiding Blvd., Neihu, Taipei 114, Taiwan
<input type="checkbox"/>	<b>Associated CB Laboratory:</b>	
<b>Testing location/ address.....:</b>		
<b>Tested by (name + signature).....:</b>		Ryan Chen 
<b>Approved by (name + signature).....:</b>		Roger Liou 
<input type="checkbox"/>	<b>Testing procedure: TMP/CTF Stage 1</b>	
<b>Testing location/ address ..... :</b>		
<b>Tested by (name + signature).....:</b>		
<b>Approved by (name + signature):</b>		
<input type="checkbox"/>	<b>Testing procedure: WMT/CTF Stage 2:</b>	
<b>Testing location/ address ..... :</b>		
<b>Tested by (name + signature).....:</b>		
<b>Witnessed by (name + signature).....:</b>		
<b>Approved by (name + signature).....:</b>		
<input type="checkbox"/>	<b>Testing procedure: SMT/CTF Stage 3 or 4:</b>	
<b>Testing location/ address ..... :</b>		
<b>Tested by (name + signature).....:</b>		
<b>Witnessed by (name + signature).....:</b>		
<b>Approved by (name + signature).....:</b>		
<b>Supervised by (name + signature).....:</b>		

**List of Attachments (including a total number of pages in each attachment):**

1. PCB layout (1 pages)
2. Photos (8 pages)
3. Transformer specification(s) (6 pages)
4. European Group difference and nation differences (19 pages)
5. US differences (6 pages)
6. Canadian differences (6 pages)

Additional National differences according to IEC 60950-1 2 ed./Am1:

7. Korean differences (1 pages)
8. Germany differences (1 page)
9. Israel differences (4 pages)

Additional National differences according to IEC 60950-1 2 ed.:

10. Australian / New Zealand differences (8 pages)
11. China differences (4 pages)
12. Singapore differences (3 pages)

Additional National differences according to IEC 60950-1 1 ed.:

13. Japan differences (12 pages)

**Summary of testing:**

**Tests performed (name of test and test clause):**

- 1.6 Power interface
- 1.7 Marking and instructions
- 2.1 Protection from electric shock and energy hazards
- 2.2 SELV circuits
- 2.5 Limited power sources
- 2.6 Provisions for earthing and bonding
- 2.9 Electrical insulation
- 2.10 Clearances, creepage distances and distances through insulation
- 4.1 Physical Requirements
- 4.2 Mechanical strength
- 4.5 Thermal requirements
- 4.6 Openings in enclosures
- 4.7 Resistance to fire
- 5.1 Touch current and protective conductor current
- 5.2 Electric strength
- 5.3 Abnormal operating and fault conditions
- Annex A Tests For Resistance To Heat And Fire
- Annex C Transformers

**Testing location:**

See page 2

Operation condition:

Continuous. Full white display with max. brightness and contrast, picture provided from a computer.

<p>Radio and television interference suppression compliance with the EMC directive is necessary for achieving type certification. The appliance shall comply with the relevant EMC standards, depending on the equipment in question. In NO, compliance with standards for radio interference suppression is a part of Nemko's certification. In FI, DK and SE compliance is not necessary for achieving safety certification.</p>	<p>The EUT has not been tested for EMC and must be tested and considered before marketed into the country in which is to be sold.</p>
<p>1.1.2 The unit is operated under altitude up to 5,000m (16,405 feet)</p>	<p>This equipment is intended to be operated under altitude up to 5,000m (16,405 feet), so the clearance is multiplied by the altitude correction factor (1.48), specified in table A.2 of IEC 60664-1, 1992+A1: 2000</p>
<p>1.5, 3.2.5 Power supply cord set.</p>	<p>The equipment shall be provided with an approved mains cord set complying with the national regulations of the countries in which the appliance is to be sold. "No switch in the power cord."</p>
<p>1.7.2.1 Safety instructions and marking</p>	<p>FI, N, S and D required marking for an unit that must be connected to protective earth only. The text is required because safety relies on connection to protective earth. The Norwegian, Swedish and Finnish texts are provided on the marking plate, therefore, must be considered when enter Denmark market.</p>
<p>1.7.2.1, Note 3 Language of safety markings/instructions.</p>	<p>Instructions and equipment marking related to safety is applied in the language that is acceptable in the country in which the equipment is to be sold.</p>
<p>2.7.5 Protection by several devices.</p>	<p>The standards require also a protective device in the neutral phase when connected to IT power system. For Norway, this is not required; refer to Lists of Decisions from OSM.</p>
<p>2.7.6 Warning to service personnel.</p>	<p>After operation of the protective device, the equipment is still under voltage if it is connected to an IT power system. A warning is required for service personnel. Norway does not require this warning.</p>
<p><b>Summary of compliance with National Differences:</b> The sample(s) tested compliance with the requirements of IEC 60950-1: 2005 (2nd Edition); Am1: 2009; Am2: 2013 and all CENELEC members except Denmark as listed in EN 60950-1: 2006 +A11: 2009+A1: 2010+A12: 2011+ A2: 2013. At the time of issuing this test report, not all countries are listed for IEC 60950-1:2005 (2nd Edition); Am1:2009+Am2:2013. Therefore this test report includes national differences for IEC 60950-1: 2005 (2nd Edition) and IEC 60950-1: 2001 1st Edition. All national differences listed in the IECEE Online CB Bulletin except Denmark are covered by the Common Modifications, Special National Conditions, National Deviations, and the National Requirements noted above except for the countries which are documented in Attachment. National Differences attached to this test report: refer to List of attachments for details.</p>	

**Copy of marking plate** The artwork below may be only a draft. The use of certification marks on a product must be authorized by the respective NCBs that own these marks.

<p>LCD monitor (LED Backlight)                  Product Name: <b>E2275SWN</b>                  Model No.: <b>215LM00063</b>                  Power Rating:100-240V~50/60Hz 1.5A</p>	<p>XXXXXXXXXXXXXXXXXX</p>
	<p>Made in China</p>
<p>Envision Peripherals, Inc.                  47490 Seabridge Drive                  Fremont, CA 94538                  USA</p> <p style="text-align: right;">www.aoc.com</p>	

<p>Apparatet må kun tilkoples jordet stikkontakt.                  Apparaten ska anslutas till jordat uttag.                  Laite on liitettävä suojamaadoituskoskettimella varustettuun pistorasiaan</p> <p><b>CAN ICES-3(B)/NMB-3(B)</b></p>	
<p>Warning: Shock Hazard, Do Not Open.                  J40G024N-815-19A BO</p>	

<p>LCD monitor (LED Backlight)                  Product Name: <b>E2275SWDA</b>                  Model No.: <b>215LM00063</b>                  Power Rating:100-240V~50/60Hz 1.5A</p>	<p>XXXXXXXXXXXXXXXXXX</p>	
	<p>Made in China</p>	
<p>Envision Peripherals, Inc.                  47490 Seabridge Drive                  Fremont, CA 94538                  USA</p> <p style="text-align: right;">www.aoc.com</p>		

<p>Apparatet må kun tilkoples jordet stikkontakt.                  Apparaten ska anslutas till jordat uttag.                  Laite on liitettävä suojamaadoituskoskettimella varustettuun pistorasiaan</p> <p><b>CAN ICES-3(B)/NMB-3(B)</b></p>	
<p>Warning: Shock Hazard, Do Not Open.                  J40G024N-815-19A BO</p>	
<p>1 5 0 8 5 5 - 1 2</p>	<p>YU10320-15001                  MSIIP-REM                  기자의의 명칭(모델명): 모니터                  신청인: K-Tronics (Suzhou) Technology Co., Ltd.                  제조자: K-Tronics (Suzhou) Technology Co., Ltd.                  생산지:중국                  AIS연락처: 080-513-0880                  상호명: 한국리노버 유통회사</p>

<b>Test item particulars</b> .....	
Equipment mobility .....	<input checked="" type="checkbox"/> movable <input type="checkbox"/> hand-held <input type="checkbox"/> transportable <input type="checkbox"/> stationary <input type="checkbox"/> for building-in <input type="checkbox"/> direct plug-in
Connection to the mains.....	<input checked="" type="checkbox"/> pluggable equipment <input checked="" type="checkbox"/> type A <input type="checkbox"/> type B <input type="checkbox"/> permanent connection <input checked="" type="checkbox"/> detachable power supply cord <input type="checkbox"/> non-detachable power supply cord <input type="checkbox"/> not directly connected to the mains
Operating condition .....	<input checked="" type="checkbox"/> continuous <input type="checkbox"/> rated operating / resting time:
Access location .....	<input checked="" type="checkbox"/> operator accessible <input type="checkbox"/> restricted access location
Over voltage category (OVC) .....	<input type="checkbox"/> OVC I <input checked="" type="checkbox"/> OVC II <input type="checkbox"/> OVC III <input type="checkbox"/> OVC IV <input type="checkbox"/> other:
Mains supply tolerance (%) or absolute mains supply values .....	±10%
Tested for IT power systems .....	<input checked="" type="checkbox"/> Yes <input type="checkbox"/> No
IT testing, phase-phase voltage (V) .....	230V
Class of equipment .....	<input checked="" type="checkbox"/> Class I <input type="checkbox"/> Class II <input type="checkbox"/> Class III <input type="checkbox"/> Not classified
Considered current rating of protective device as part of the building installation (A) .....	16A or 20A (for Canada and US)
Pollution degree (PD) .....	<input type="checkbox"/> PD 1 <input checked="" type="checkbox"/> PD 2 <input type="checkbox"/> PD 3
IP protection class .....	IP20
Altitude during operation (m) .....	Up to 5000m
Altitude of test laboratory (m) .....	Up to 25m above sea level.
Mass of equipment (kg) .....	2.86kg (base: 0.39kg) dimensions: 510 x 310 x 195 mm

<b>Possible test case verdicts:</b>	
- test case does not apply to the test object .....	N/A
- test object does meet the requirement .....	P (Pass)
- test object does not meet the requirement .....	F (Fail)
<b>Testing</b> .....	
Date of receipt of test item.....	October, 2015
Date(s) of performance of tests.....	October, 2015

<b>General remarks:</b>
"(see Enclosure #)" refers to additional information appended to the report. "(see appended table)" refers to a table appended to the report.
Throughout this report a <input type="checkbox"/> comma / <input checked="" type="checkbox"/> point is used as the decimal separator.

<b>Manufacturer's Declaration per sub-clause 4.2.5 of IEC 60664-1:</b>	
The application for obtaining a CB Test Certificate includes more than one factory location and a declaration from the Manufacturer stating that the sample(s) submitted for evaluation is (are) representative of the products from each factory has been provided.....:	<input type="checkbox"/> <b>Yes</b> <input checked="" type="checkbox"/> <b>Not applicable</b>

**When differences exist; they shall be identified in the General product information section.**

**Name and address of factory (ies) .....**  
 K Tronics (Suzhou) Technology Co., Ltd.  
 No.1700 Zhongshan North Road, Economic and Technological Development Zone, Wujiang District,  
 Suzhou, Jiangsu Province, P.R. CHINA

**General product information:**  
 The EUT is a colour display LCD Monitor with non-certified building-in power supply.

The unit has the following features:

1. The unit is provided with an internal metal fire enclosure, this enclosure covers all parts except keypad board and sec. LED drive board, these PCBs are supplied by PSU (+5V, +14V output) complied with LPS requirement.
2. The plastic enclosure is located outside of the fire enclosure and regarded as mechanical enclosure.

Circuit characteristics: The equipment contains primary and secondary (SELV) circuits.

Maximum recommended ambient (T<sub>mra</sub>): 40°C

1.1.2 – Additional requirements:  
 Exposure to extreme temperatures, excessive dust, moisture or vibration; to flammable gases; to corrosive or explosive atmospheres:  
 This equipment is intended to operate in a "normal" environment (Offices and homes).

Electromedical equipment connected to the patient:  
 This equipment is not an electromedical equipment intended to be physically connected to a patient.

Equipment used in vehicles, ships or aircrafts, in tropical countries, or at elevations > 2000m:  
 This equipment is intended to be operated under altitude up to 5,000m (16,405 feet), so the required clearance is multiplied by the altitude correction factor (1.48, linear interpolation used), specified in table A.2 of IEC 60664-1, 1992+A1: 2000.

<b>Abbreviations used in the report:</b>			
- normal conditions	<b>N.C.</b>	- single fault conditions	<b>S.F.C</b>
- functional insulation	<b>FI</b>	- basic insulation	<b>BI</b>
- double insulation	<b>DI</b>	- supplementary insulation	<b>SI</b>
- between parts of opposite polarity	<b>BOP</b>	- reinforced insulation	<b>RI</b>
<b>Indicate used abbreviations (if any)</b>			



IEC 60950-1			
Clause	Requirement + Test	Result - Remark	Verdict
<b>1</b>	<b>GENERAL</b>		<b>P</b>
<b>1.5</b>	<b>Components</b>		<b>P</b>
1.5.1	General	See below.	<b>P</b>
	Comply with IEC 60950-1 or relevant component standard	(see appended table 1.5.1)	<b>P</b>
1.5.2	Evaluation and testing of components	Certified components are used in accordance with their ratings, certifications and they comply with applicable parts of this standard. Components not certified are used in accordance with their ratings and they comply with applicable parts of IEC 60950-1 and the relevant component standard. Components, for which no relevant IEC-standard exists, have been tested under the conditions occurring in the equipment, using applicable parts of IEC 60950-1.	<b>P</b>
1.5.3	Thermal controls	No thermal controls.	<b>N/A</b>
1.5.4	Transformers	Transformers used are suitable for their intended applications and comply with relevant parts of this standard and particularly Annex C, see Annex C – Transformers.	<b>P</b>
1.5.5	Interconnecting cables	No interconnecting cable.	<b>N/A</b>
1.5.6	Capacitors bridging insulation	X1 or X2 and Y2 capacitors according to IEC 60384-14:1993.	<b>P</b>
1.5.7	Resistors bridging insulation	Refer to below:	<b>P</b>
1.5.7.1	Resistors bridging functional, basic or supplementary insulation	No special requirement for the bleeder resistors (Three in series, located after the fuse) are bridging functional insulation. Refer to appended table 1.5.1 for details.	<b>P</b>
1.5.7.2	Resistors bridging double or reinforced insulation between a.c. mains and other circuits	No resistors bridging double or reinforced insulation.	<b>N/A</b>
1.5.7.3	Resistors bridging double or reinforced insulation between a.c. mains and antenna or coaxial cable	Not connected to antenna or coaxial cable.	<b>N/A</b>

IEC 60950-1			
Clause	Requirement + Test	Result - Remark	Verdict
1.5.8	Components in equipment for IT power systems	Certified capacitors connected between line and earth, refer List of Critical Components and 1.5.6.	<b>P</b>
1.5.9	Surge suppressors	No Surge suppressors in the equipment.	<b>N/A</b>
1.5.9.1	General	Refer to sub-clause 1.5.9.	<b>N/A</b>
1.5.9.2	Protection of VDRs		<b>N/A</b>
1.5.9.3	Bridging of functional insulation by a VDR		<b>N/A</b>
1.5.9.4	Bridging of basic insulation by a VDR		<b>N/A</b>
1.5.9.5	Bridging of supplementary, double or reinforced insulation by a VDR		<b>N/A</b>

<b>1.6</b>	<b>Power interface</b>		<b>P</b>
1.6.1	AC power distribution systems	TN, and IT for Norway.	<b>P</b>
1.6.2	Input current	(see appended table 1.6.2)	<b>P</b>
1.6.3	Voltage limit of hand-held equipment	The equipment is not hand-held.	<b>N/A</b>
1.6.4	Neutral conductor	Neutral is insulated from earth with basic insulation throughout the equipment.	<b>P</b>

<b>1.7</b>	<b>Marking and instructions</b>		<b>P</b>
1.7.1	Power rating and identification markings	The required marking is located on the outside surface of the equipment.	<b>P</b>
1.7.1.1	Power rating marking	Refer to below:	<b>P</b>
	Multiple mains supply connections.....:	Single supply connection.	<b>N/A</b>
	Rated voltage(s) or voltage range(s) (V) .....	Refer to copy of marking plate.	<b>—</b>
	Symbol for nature of supply, for d.c. only.....:	The equipment is for a.c. supply.	<b>N/A</b>
	Rated frequency or rated frequency range (Hz) ...:	Refer to copy of marking plate.	<b>—</b>
	Rated current (mA or A) .....	Refer to copy of marking plate.	<b>—</b>
1.7.1.2	Identification markings	Refer to below:	<b>P</b>
	Manufacturer's name or trade-mark or identification mark .....	Refer to copy of marking plate.	<b>—</b>
	Model identification or type reference .....	Refer to copy of marking plate.	<b>—</b>
	Symbol for Class II equipment only .....	Class I equipment.	<b>N/A</b>

IEC 60950-1			
Clause	Requirement + Test	Result - Remark	Verdict
	Other markings and symbols .....	The additional marking does not give rise to misunderstandings.	<b>P</b>
1.7.1.3	Use of graphical symbols	Refer to copy of marking plate.	<b>P</b>
1.7.2	Safety instructions and marking	FI, N, S and D required marking for an unit that must be connected to protective earth only. The text is required because safety relies on connection to protective earth. The Norwegian, Swedish, and Finnish texts are provided on the marking plate, therefore, must be considered when enter Denmark market.	—
1.7.2.1	General	Refer to sub-clause 1.7.2.	<b>P</b>
1.7.2.2	Disconnect devices	The appliance coupler will be acting as disconnect device.	<b>N/A</b>
1.7.2.3	Overcurrent protective device	Not applicable for pluggable equipment type A equipment.	<b>N/A</b>
1.7.2.4	IT power distribution systems	The following or similar information should be given in the installation instruction: "This product is also designed for IT power distribution system with phase-to-phase voltage 230V".	—
1.7.2.5	Operator access with a tool	All areas containing hazard(s) are inaccessible to the operator.	<b>N/A</b>
1.7.2.6	Ozone	The equipment not containing ozone.	<b>N/A</b>
1.7.3	Short duty cycles	The equipment is intended for continuous operation.	<b>N/A</b>
1.7.4	Supply voltage adjustment .....	No voltage selector.	<b>N/A</b>
	Methods and means of adjustment; reference to installation instructions .....		—
1.7.5	Power outlets on the equipment .....	No power outlet.	<b>N/A</b>
1.7.6	Fuse identification (marking, special fusing characteristics, cross-reference) .....	Fuse location and marking: F801, T2AL / 250V	<b>P</b>
1.7.7	Wiring terminals	Refer to below:	<b>N/A</b>
1.7.7.1	Protective earthing and bonding terminals .....	Appliance inlet, marking of the protective earthing terminal is not applicable.	<b>N/A</b>

IEC 60950-1			
Clause	Requirement + Test	Result - Remark	Verdict
1.7.7.2	Terminals for a.c. mains supply conductors	Not a permanently connected equipment or with non-detachable power supply cords.	N/A
1.7.7.3	Terminals for d.c. mains supply conductors	The equipment is not supplied from d.c. mains.	N/A
1.7.8	Controls and indicators	Refer to below:	P
1.7.8.1	Identification, location and marking .....	The function of controls affecting safety is obvious without knowledge of language etc.	P
1.7.8.2	Colours .....	For functional indication a LED lights when the equipment is operating.	P
1.7.8.3	Symbols according to IEC 60417 .....	The functional switch is marked  complies with IEC-60417-5009.	P
1.7.8.4	Markings using figures .....	No controls.	N/A
1.7.9	Isolation of multiple power sources .....	Only one connection supplying hazardous voltages and energy levels to the equipment.	N/A
1.7.10	Thermostats and other regulating devices .....	No thermostats or other regulating devices.	N/A
1.7.11	Durability	The marking withstands required tests.	P
1.7.12	Removable parts	No marking is placed on the removable parts (base).	N/A
1.7.13	Replaceable batteries .....	No battery in the equipment.	N/A
	Language(s) .....		—
1.7.14	Equipment for restricted access locations .....	Equipment not intended for installation in RAL.	N/A

<b>2</b>	<b>PROTECTION FROM HAZARDS</b>		<b>P</b>
2.1	Protection from electric shock and energy hazards		<b>P</b>
2.1.1	Protection in operator access areas	Refer to below:	—

IEC 60950-1			
Clause	Requirement + Test	Result - Remark	Verdict
2.1.1.1	Access to energized parts	There is adequate protection against operator contact with bare parts at ELV or hazardous voltage or parts separated from these with basic or functional insulation only (except protective earth), no operator detachable parts. Voltage not exceeding 1000Vac or 1500Vdc checked by test finger and test pin.	<b>P</b>
	Test by inspection .....	Complies.	<b>P</b>
	Test with test finger (Figure 2A) .....	Complies.	<b>P</b>
	Test with test pin (Figure 2B) .....	Complies.	<b>P</b>
	Test with test probe (Figure 2C) .....	Not applicable.	<b>N/A</b>
2.1.1.2	Battery compartments	No battery compartments in the equipment.	<b>N/A</b>
2.1.1.3	Access to ELV wiring	No internal wiring at ELV accessible to the operator.	<b>N/A</b>
	Working voltage (V <sub>peak</sub> or V <sub>rms</sub> ); minimum distance through insulation (mm)		<b>—</b>
2.1.1.4	Access to hazardous voltage circuit wiring	All accessible parts are separated from internal wiring at hazardous voltage by double or reinforced insulation, complying with 2.10.5 and 3.1.4.	<b>P</b>
2.1.1.5	Energy hazards .....	No energy hazard in operator access area. Checked by means of test finger. (see appended table 2.1.1.5)	<b>N/A</b>
2.1.1.6	Manual controls	No shafts of knobs etc.	<b>N/A</b>
2.1.1.7	Discharge of capacitors in equipment	The capacitance of the input circuit is > 0.1µF. The measurements were performed in worst case condition with regard to the fuse-in.	<b>P</b>
	Measured voltage (V); time-constant (s).....	Refer to table 2.1.1.7.	<b>P</b>
2.1.1.8	Energy hazards – d.c. mains supply	Not connected to d.c. mains supply.	<b>N/A</b>
	a) Capacitor connected to the d.c. mains supply ...		<b>N/A</b>
	b) Internal battery connected to the d.c. mains supply .....		<b>N/A</b>

IEC 60950-1			
Clause	Requirement + Test	Result - Remark	Verdict
2.1.1.9	Audio amplifiers .....	No audio amplifier.	N/A
2.1.2	Protection in service access areas	Checked by inspection, unintentional contact is unlikely during service operations.	P
2.1.3	Protection in restricted access locations	Equipment not intended for installation in RAL.	N/A

<b>2.2</b>	<b>SELV circuits</b>		<b>P</b>
2.2.1	General requirements	SELV limits are not exceeded under normal condition and after a single fault.	P
2.2.2	Voltages under normal conditions (V) .....	Within SELV limits. (see appended table 2.2)	P
2.2.3	Voltages under fault conditions (V) .....	Within SELV limits. (See appended table 2.2)	P
2.2.4	Connection of SELV circuits to other circuits .....	SELV circuits are only connected to other SELV circuits.	P

<b>2.3</b>	<b>TNV circuits</b>		<b>N/A</b>
2.3.1	Limits	2.3.1-2.3.5: No TNV circuits.	N/A
	Type of TNV circuits .....		—
2.3.2	Separation from other circuits and from accessible parts		N/A
2.3.2.1	General requirements		N/A
2.3.2.2	Protection by basic insulation		N/A
2.3.2.3	Protection by earthing		N/A
2.3.2.4	Protection by other constructions .....		N/A
2.3.3	Separation from hazardous voltages		N/A
	Insulation employed .....		—
2.3.4	Connection of TNV circuits to other circuits		N/A
	Insulation employed .....		—
2.3.5	Test for operating voltages generated externally		N/A

<b>2.4</b>	<b>Limited current circuits</b>		<b>N/A</b>
2.4.1	General requirements	No Limits Current Circuits.	N/A
2.4.2	Limit values		N/A
	Frequency (Hz).....		—

IEC 60950-1			
Clause	Requirement + Test	Result - Remark	Verdict
	Measured current (mA) .....		—
	Measured voltage (V).....		—
	Measured circuit capacitance (nF or $\mu$ F) .....		N/A
2.4.3	Connection of limited current circuits to other circuits		N/A

<b>2.5</b>	<b>Limited power sources</b>		<b>P</b>
	a) Inherently limited output		N/A
	b) Impedance limited output		N/A
	c) Regulating network limited output under normal operating and single fault condition	(see appended table 2.5.)	P
	Use of integrated circuit (IC) current limiters		N/A
	d) Overcurrent protective device limited output		N/A
	Max. output voltage (V), max. output current (A), max. apparent power (VA) .....	(see appended table 2.5.)	P
	Current rating of overcurrent protective device (A) ..		—

<b>2.6</b>	<b>Provisions for earthing and bonding</b>		<b>P</b>
2.6.1	Protective earthing	Accessible conductive parts are reliably connected to protective earth.	P
2.6.2	Functional earthing	Functional earthing is separated from hazardous voltages by reinforced insulation.	P
	Use of symbol for functional earthing .....		N/A
2.6.3	Protective earthing and protective bonding conductors	Refer to below:	P
2.6.3.1	General	Refer to below:	P
2.6.3.2	Size of protective earthing conductors	Refer to Summary of Testing.	N/A
	Rated current (A), cross-sectional area ( $\text{mm}^2$ ), AWG .....		—
2.6.3.3	Size of protective bonding conductors	Refer to cl. 2.6.3.4	P
	Rated current (A), cross-sectional area ( $\text{mm}^2$ ), AWG .....	Refer to cl. 2.6.3.4	—
	Protective current rating (A), cross-sectional area ( $\text{mm}^2$ ), AWG .....	Refer to cl. 2.6.3.4	—

IEC 60950-1			
Clause	Requirement + Test	Result - Remark	Verdict
2.6.3.4	Resistance of earthing conductors and their terminations; resistance ( $\Omega$ ), voltage drop (V), test current (A), duration (min) .....	Refer to table 2.6.3.4.	<b>P</b>
2.6.3.5	Colour of insulation .....	All insulated protective earth conductors are coloured green and yellow.	<b>P</b>
2.6.4	Terminals	Refer to below:	—
2.6.4.1	General	Refer to below:	—
2.6.4.2	Protective earthing and bonding terminals	The equipment is provided with an appliance inlet.	—
	Rated current (A), type, nominal thread diameter (mm) .....		—
2.6.4.3	Separation of the protective earthing conductor from protective bonding conductors	The equipment is provided with an appliance inlet.	<b>N/A</b>
2.6.5	Integrity of protective earthing	Refer to below:	—
2.6.5.1	Interconnection of equipment	No interconnection of equipment.	<b>N/A</b>
2.6.5.2	Components in protective earthing conductors and protective bonding conductors	There are no switches or overcurrent protective devices in the protective earthing / bonding conductors.	<b>P</b>
2.6.5.3	Disconnection of protective earth	It is not possible to disconnect protective earth without disconnecting mains; an appliance coupler will be used as disconnect device.	<b>P</b>
2.6.5.4	Parts that can be removed by an operator	No operator removable parts with protective earth connection except supply cord.	<b>P</b>
2.6.5.5	Parts removed during servicing	Protective earthed parts cannot be removed in a way which impair safety.	<b>P</b>
2.6.5.6	Corrosion resistance	No risk of corrosion.	<b>P</b>
2.6.5.7	Screws for protective bonding	Adequate connection of protective bonding.	<b>P</b>
2.6.5.8	Reliance on telecommunication network or cable distribution system	No TNV circuits in the equipment.	<b>N/A</b>
<b>2.7</b>	<b>Overcurrent and earth fault protection in primary circuits</b>		<b>P</b>
2.7.1	Basic requirements	Protective devices are integrated in the equipment, see also Sub-clause 5.3.	<b>P</b>



IEC 60950-1			
Clause	Requirement + Test	Result - Remark	Verdict
	Instructions when protection relies on building installation	Protective devices are integrated in the equipment.	<b>P</b>
2.7.2	Faults not simulated in 5.3.7	Considered.	<b>P</b>
2.7.3	Short-circuit backup protection	Adequate protective device.	<b>P</b>
2.7.4	Number and location of protective devices :	In Norway, IT power distribution system is used. Equipment with a single protective device is accepted in Norway. Other countries may have additional requirements.	<b>P</b>
2.7.5	Protection by several devices	Only one protective device. See Sub-clause 2.7.4.	<b>N/A</b>
2.7.6	Warning to service personnel.....:	After operation of the protective device, the equipment is still under voltage if it is connected to an IT-power distribution system. A warning is required for service personnel. Norway does not require this warning. See also Sub-clause 2.7.4.	<b>N/A</b>

<b>2.8</b>	<b>Safety interlocks</b>		<b>N/A</b>
2.8.1	General principles	No safety interlock provided.	<b>N/A</b>
2.8.2	Protection requirements		<b>N/A</b>
2.8.3	Inadvertent reactivation		<b>N/A</b>
2.8.4	Fail-safe operation		<b>N/A</b>
	Protection against extreme hazard		<b>N/A</b>
2.8.5	Moving parts		<b>N/A</b>
2.8.6	Overriding		<b>N/A</b>
2.8.7	Switches, relays and their related circuits		<b>N/A</b>
2.8.7.1	Separation distances for contact gaps and their related circuits (mm) .....		<b>N/A</b>
2.8.7.2	Overload test		<b>N/A</b>
2.8.7.3	Endurance test		<b>N/A</b>
2.8.7.4	Electric strength test		<b>N/A</b>
2.8.8	Mechanical actuators		<b>N/A</b>

<b>2.9</b>	<b>Electrical insulation</b>		<b>P</b>
------------	------------------------------	--	----------

IEC 60950-1			
Clause	Requirement + Test	Result - Remark	Verdict
2.9.1	Properties of insulating materials	Neither natural rubber, materials containing asbestos nor hygroscopic materials are used as insulation. No driving belts or couplings used. However, humidity test performed on equipment with all sources of transformer (T801) and optocoupler (I802) then subjected to the electric strength test of 5.2.2.	N/A
2.9.2	Humidity conditioning	Humidity treatment performed for 120hrs. (Also test incorporated for all sources of transformer and optocoupler)	P
	Relative humidity (%), temperature (°C) .....	91-95%, 40°C.	—
2.9.3	Grade of insulation	Insulation is considered to be functional, basic, supplementary, reinforced or double insulation.	P
2.9.4	Separation from hazardous voltages	The accessible conductive parts, including SELV circuits, and their related windings, are separated from parts at hazardous voltage by double or reinforced insulation.	P
	Method(s) used .....	Method 1 is used.	—

<b>2.10</b>	<b>Clearances, creepage distances and distances through insulation</b>		<b>P</b>
2.10.1	General	Refer to below:	P
2.10.1.1	Frequency .....	Considered.	P
2.10.1.2	Pollution degrees .....	The equipment is considered located within pollution degree II.	P
2.10.1.3	Reduced values for functional insulation	The functional insulation complies with 5.3.4 a) and c)	P
2.10.1.4	Intervening unconnected conductive parts	Considered.	P
2.10.1.5	Insulation with varying dimensions	No such insulations.	N/A
2.10.1.6	Special separation requirements	Special separation is not used.	N/A
2.10.1.7	Insulation in circuits generating starting pulses	No such circuit generating starting pulses.	N/A
2.10.2	Determination of working voltage	(See appended table 2.10.2)	P
2.10.2.1	General	Refer below:	P

IEC 60950-1			
Clause	Requirement + Test	Result - Remark	Verdict
2.10.2.2	RMS working voltage	(see appended table 2.10.2)	<b>P</b>
2.10.2.3	Peak working voltage	(see appended table 2.10.2)	<b>P</b>
2.10.3	Clearances	Refer to below:	<b>P</b>
2.10.3.1	General	Considered.	<b>P</b>
2.10.3.2	Mains transient voltages	Refer to below:	<b>P</b>
	a) AC mains supply .....	Equipment is Overvoltage Category II (2500V).	<b>P</b>
	b) Earthed d.c. mains supplies .....	Not intended for d.c.	<b>N/A</b>
	c) Unearthed d.c. mains supplies .....	Not intended for d.c.	<b>N/A</b>
	d) Battery operation .....	No battery in the equipment.	<b>N/A</b>
2.10.3.3	Clearances in primary circuits	(see appended table 2.10.3 and 2.10.4)	<b>P</b>
2.10.3.4	Clearances in secondary circuits	Only the functional insulation in secondary circuits complied with clause 5.3.4.	<b>N/A</b>
2.10.3.5	Clearances in circuits having starting pulses	The circuit will not generating starting pulse.	<b>N/A</b>
2.10.3.6	Transients from a.c. mains supply .....	Considered.	<b>P</b>
2.10.3.7	Transients from d.c. mains supply .....	Not connected to d.c mains supply.	<b>N/A</b>
2.10.3.8	Transients from telecommunication networks and cable distribution systems .....	Not connected to telecommunication networks and cable distribution systems.	<b>N/A</b>
2.10.3.9	Measurement of transient voltage levels	See below.	<b>—</b>
	a) Transients from a mains supply	Measurement not relevant.	<b>N/A</b>
	For an a.c. mains supply .....		<b>N/A</b>
	For a d.c. mains supply .....		<b>N/A</b>
	b) Transients from a telecommunication network :		<b>N/A</b>
2.10.4	Creepage distances	See below.	<b>P</b>
2.10.4.1	General	Considered.	<b>P</b>
2.10.4.2	Material group and comparative tracking index	Material group IIIa or IIIb is assumed to be used.	<b>P</b>
	CTI tests .....	CTI rating for all material of minimum 100.	<b>—</b>
2.10.4.3	Minimum creepage distances	(see appended table 2.10.3 and 2.10.4)	<b>P</b>
2.10.5	Solid insulation	Considered.	<b>P</b>
2.10.5.1	General	Refer to below:	<b>P</b>

IEC 60950-1			
Clause	Requirement + Test	Result - Remark	Verdict
2.10.5.2	Distances through insulation	(see appended table 2.10.5)	<b>P</b>
2.10.5.3	Insulating compound as solid insulation	Approved optocouplers, see appended table 1.5.1.	<b>P</b>
2.10.5.4	Semiconductor devices	No semiconductor devices.	<b>N/A</b>
2.10.5.5	Cemented joints	No cemented joints.	<b>N/A</b>
2.10.5.6	Thin sheet material – General	Refer to below:	<b>P</b>
2.10.5.7	Separable thin sheet material	Refer to appended table 2.10.5	<b>P</b>
	Number of layers (pcs).....:		<b>—</b>
2.10.5.8	Non-separable thin sheet material	Not used.	<b>N/A</b>
2.10.5.9	Thin sheet material – standard test procedure	Refer to sub-clause 2.10.5.10	<b>N/A</b>
	Electric strength test		<b>—</b>
2.10.5.10	Thin sheet material – alternative test procedure	(see appended table 2.10.5)	<b>P</b>
	Electric strength test	(see appended table 2.10.5)	<b>P</b>
2.10.5.11	Insulation in wound components	Not used.	<b>N/A</b>
2.10.5.12	Wire in wound components	Insulation on winding wires of T801 complies with annex U.	<b>P</b>
	Working voltage .....	(see appended table 2.10.2)	<b>P</b>
	a) Basic insulation not under stress .....		<b>N/A</b>
	b) Basic, supplementary, reinforced insulation .....	(see appended table Annex C.2)	<b>P</b>
	c) Compliance with Annex U .....	Considered.	<b>P</b>
	Two wires in contact inside wound component; angle between 45° and 90° .....		<b>N/A</b>
2.10.5.13	Wire with solvent-based enamel in wound components	No wire with solvent-based enamel in wound components.	<b>N/A</b>
	Electric strength test		<b>—</b>
	Routine test		<b>—</b>
2.10.5.14	Additional insulation in wound components	No additional insulation used.	<b>N/A</b>
	Working voltage .....		<b>—</b>
	- Basic insulation not under stress .....		<b>—</b>
	- Supplementary, reinforced insulation .....		<b>—</b>
2.10.6	Construction of printed boards	Refer to below:	<b>P</b>
2.10.6.1	Uncoated printed boards	Considered. (see appended table 2.10.3 and 2.10.4)	<b>P</b>
2.10.6.2	Coated printed boards	No such parts.	<b>N/A</b>

<b>IEC 60950-1</b>			
Clause	Requirement + Test	Result - Remark	Verdict
2.10.6.3	Insulation between conductors on the same inner surface of a printed board	No such parts.	<b>N/A</b>
2.10.6.4	Insulation between conductors on different layers of a printed board	Double side with single layer PCB does not serve as insulation barrier.	<b>N/A</b>
	Distance through insulation		—
	Number of insulation layers (pcs) .....:		—
2.10.7	Component external terminations	No such parts.	<b>N/A</b>
2.10.8	Tests on coated printed boards and coated components	No such parts.	<b>N/A</b>
2.10.8.1	Sample preparation and preliminary inspection		<b>N/A</b>
2.10.8.2	Thermal conditioning		<b>N/A</b>
2.10.8.3	Electric strength test		<b>N/A</b>
2.10.8.4	Abrasion resistance test		<b>N/A</b>
2.10.9	Thermal cycling	Approved optocouplers, see appended table 1.5.1.	<b>P</b>
2.10.10	Test for Pollution Degree 1 environment and insulating compound	Approved optocouplers, see appended table 1.5.1.	<b>P</b>
2.10.11	Tests for semiconductor devices and cemented joints	No such device used.	<b>N/A</b>
2.10.12	Enclosed and sealed parts	Approved optocouplers, see appended table 1.5.1.	<b>P</b>

<b>3</b>	<b>WIRING, CONNECTIONS AND SUPPLY</b>		<b>P</b>
3.1	General		<b>P</b>
3.1.1	Current rating and overcurrent protection	Adequate cross sectional areas on internal wiring.	<b>P</b>
3.1.2	Protection against mechanical damage	Wireways are smooth and free from edges. Wires are adequately fixed to prevent excessive strain on wire and terminals and avoiding damage to the insulation of the conductors.	<b>P</b>
3.1.3	Securing of internal wiring	Internal wiring is secured against excessive strain, loosening of terminals and damage to the conductor insulation.	<b>P</b>

IEC 60950-1			
Clause	Requirement + Test	Result - Remark	Verdict
3.1.4	Insulation of conductors	Insulation on internal conductors is considered to be of adequate quality and suitable for the application and the working voltage involved.	<b>P</b>
3.1.5	Beads and ceramic insulators	No beads or similar ceramic insulators on conductors.	<b>N/A</b>
3.1.6	Screws for electrical contact pressure	No electric screw connection.	<b>N/A</b>
3.1.7	Insulating materials in electrical connections	No contact pressure through insulating material.	<b>N/A</b>
3.1.8	Self-tapping and spaced thread screws	Thread-cutting or space thread screws are not used for electrical connections.	<b>P</b>
3.1.9	Termination of conductors	Terminations cannot become displaced so that clearances and creepage distances can be reduced.	<b>P</b>
	10 N pull test	Considered.	<b>P</b>
3.1.10	Sleeving on wiring	Sleeves can only be removed by breaking or cutting.	<b>P</b>

<b>3.2</b>	<b>Connection to a mains supply</b>		<b>P</b>
3.2.1	Means of connection	Refer to below:	<b>P</b>
3.2.1.1	Connection to an a.c. mains supply	The equipment is provided with an appliance inlet.	—
3.2.1.2	Connection to a d.c. mains supply	The equipment is not for connection to a d.c. mains supply.	<b>N/A</b>
3.2.2	Multiple supply connections	Only one power supply connection.	<b>N/A</b>
3.2.3	Permanently connected equipment	The equipment is not intended for permanent connection to the mains.	<b>N/A</b>
	Number of conductors, diameter of cable and conduits (mm) .....		—
3.2.4	Appliance inlets	The appliance inlet complies with IEC 60320-1 and is properly placed to avoid hazards after insertion of the appliance coupler.	<b>P</b>
3.2.5	Power supply cords	Refer to below:	—
3.2.5.1	AC power supply cords	Refer to Summary of Testing.	<b>N/A</b>

IEC 60950-1			
Clause	Requirement + Test	Result - Remark	Verdict
	Type .....		—
	Rated current (A), cross-sectional area (mm <sup>2</sup> ), AWG .....		—
3.2.5.2	DC power supply cords	The equipment is not for connecting to d.c. mains.	N/A
3.2.6	Cord anchorages and strain relief	Equipment provided with an appliance inlet.	P
	Mass of equipment (kg), pull (N) .....		—
	Longitudinal displacement (mm) .....		—
3.2.7	Protection against mechanical damage	No sharp points or cutting edges on the equipment surfaces.	P
3.2.8	Cord guards	The equipment is neither hand-held nor intended to be moved during operation.	N/A
	Diameter or minor dimension D (mm); test mass (g) .....		—
	Radius of curvature of cord (mm) .....		—
3.2.9	Supply wiring space	Equipment provided with an appliance inlet.	N/A

<b>3.3</b>	<b>Wiring terminals for connection of external conductors</b>		<b>N/A</b>
3.3.1	Wiring terminals	3.3.1 – 3.3.8 Equipment provided with an appliance inlet.	N/A
3.3.2	Connection of non-detachable power supply cords		—
3.3.3	Screw terminals		—
3.3.4	Conductor sizes to be connected		—
	Rated current (A), cord/cable type, cross-sectional area (mm <sup>2</sup> ).....		—
3.3.5	Wiring terminal sizes		—
	Rated current (A), type, nominal thread diameter (mm) .....		—
3.3.6	Wiring terminal design		—
3.3.7	Grouping of wiring terminals		—
3.3.8	Stranded wire		—

<b>3.4</b>	<b>Disconnection from the mains supply</b>		<b>P</b>
------------	--	--	----------

<b>IEC 60950-1</b>			
Clause	Requirement + Test	Result - Remark	Verdict
3.4.1	General requirement	The appliance coupler will be acting as disconnect device.	<b>P</b>
3.4.2	Disconnect devices	The appliance coupler will be acting as disconnect device.	<b>P</b>
3.4.3	Permanently connected equipment	Not permanently connected equipment.	<b>N/A</b>
3.4.4	Parts which remain energized	No parts remain energized after the disconnect device is pull out.	<b>N/A</b>
3.4.5	Switches in flexible cords	Refer to Summary Of Testing.	<b>N/A</b>
3.4.6	Number of poles - single-phase and d.c. equipment	The disconnect device disconnects both poles simultaneously.	<b>P</b>
3.4.7	Number of poles - three-phase equipment	Single phase equipment.	<b>N/A</b>
3.4.8	Switches as disconnect devices	No switches used.	<b>N/A</b>
3.4.9	Plugs as disconnect devices	The appliance coupler will be regarded as disconnect device, no warning is required.	<b>N/A</b>
3.4.10	Interconnected equipment	No interconnections using hazardous voltages.	<b>N/A</b>
3.4.11	Multiple power sources	One power source only.	<b>N/A</b>

<b>3.5</b>	<b>Interconnection of equipment</b>		<b>P</b>
3.5.1	General requirements	Considered.	<b>P</b>
3.5.2	Types of interconnection circuits :	SELV circuits.	<b>—</b>
3.5.3	ELV circuits as interconnection circuits	No ELV interconnections.	<b>N/A</b>
3.5.4	Data ports for additional equipment	No data ports.	<b>N/A</b>

<b>4</b>	<b>PHYSICAL REQUIREMENTS</b>		<b>P</b>
4.1	Stability		<b>N/A</b>
	Angle of 10°	Units did not overbalance at 10°. (Per client request)	<b>P</b>
	Test force (N) .....	The unit is not floor-standing.	<b>N/A</b>

<b>4.2</b>	<b>Mechanical strength</b>		<b>P</b>
4.2.1	General	Considered.	<b>P</b>
	Rack-mounted equipment.	Not rack-mounted equipment.	<b>N/A</b>



IEC 60950-1			
Clause	Requirement + Test	Result - Remark	Verdict
4.2.2	Steady force test, 10 N	No hazard, ref. comment in table 2.10.3 and 2.10.4.	<b>P</b>
4.2.3	Steady force test, 30 N	No hazard. The test is performed on metal enclosure.	<b>P</b>
4.2.4	Steady force test, 250 N	No hazard. The test is performed at outside plastic enclosure.	<b>P</b>
4.2.5	Impact test	Refer to below:	<b>P</b>
	Fall test	No hazard as result from the steel sphere fall test.	<b>P</b>
	Swing test	No hazard as result from the steel sphere swing test.	<b>P</b>
4.2.6	Drop test; height (mm) .....	Drop test not applicable.	<b>N/A</b>
4.2.7	Stress relief test	Test is carried out at 70°C/7h. No risk of shrinkage or distortion on enclosures due to release of internal stresses.	<b>P</b>
4.2.8	Cathode ray tubes	CRT(s) not used in the equipment.	<b>N/A</b>
	Picture tube separately certified .....		<b>—</b>
4.2.9	High pressure lamps	No high pressure lamps in the equipment.	<b>N/A</b>
4.2.10	Wall or ceiling mounted equipment; force (N) .....	(Tested =7.41g, Unit weight=2.47kg, excluded base). The equipment and its associated mounting means still remain secure during the test. (wall mounting kit, 100 x 100 mm distance, diameter of screw=4.0mm, 10mm length used)	<b>P</b>

<b>4.3</b>	<b>Design and construction</b>		<b>P</b>
4.3.1	Edges and corners	All edges and corners are rounded and/or smoothed.	<b>P</b>
4.3.2	Handles and manual controls; force (N) .....	No knobs, grips, handles, lever, etc.	<b>N/A</b>
4.3.3	Adjustable controls	No hazardous adjustable controls.	<b>N/A</b>
4.3.4	Securing of parts	No loosening of parts impairing creepage distances or clearances is likely to occur.	<b>P</b>

IEC 60950-1			
Clause	Requirement + Test	Result - Remark	Verdict
4.3.5	Connection by plugs and sockets	SELV connectors do not comply with IEC 60320-1 or IEC 60083.	<b>P</b>
4.3.6	Direct plug-in equipment	Not intended to plug directly into a wall socket-outlet.	<b>N/A</b>
	Torque .....		—
	Compliance with the relevant mains plug standard .....		—
4.3.7	Heating elements in earthed equipment	No heating elements provided.	<b>N/A</b>
4.3.8	Batteries	No batteries in the equipment.	<b>N/A</b>
	- Overcharging of a rechargeable battery		—
	- Unintentional charging of a non-rechargeable battery		—
	- Reverse charging of a rechargeable battery		—
	- Excessive discharging rate for any battery		—
4.3.9	Oil and grease	Insulation is not exposed to oil, grease etc.	<b>N/A</b>
4.3.10	Dust, powders, liquids and gases	The equipment does not contain flammable liquids or gases.	<b>N/A</b>
4.3.11	Containers for liquids or gases	No containers for liquids or gases in the equipment.	<b>N/A</b>
4.3.12	Flammable liquids .....	The equipment does not contain flammable liquid.	<b>N/A</b>
	Quantity of liquid (l) .....		—
	Flash point (°C) .....		—
4.3.13	Radiation	Refer to below:	<b>P</b>
4.3.13.1	General	Refer to below:	—
4.3.13.2	Ionizing radiation	The equipment does not generate ionizing radiation.	<b>N/A</b>
	Measured radiation (pA/kg) .....		—
	Measured high-voltage (kV) .....		—
	Measured focus voltage (kV) .....		—
	CRT markings .....		—
4.3.13.3	Effect of ultraviolet (UV) radiation on materials	The equipment does not produce significant UV radiation.	<b>N/A</b>

IEC 60950-1			
Clause	Requirement + Test	Result - Remark	Verdict
	Part, property, retention after test, flammability classification .....		—
4.3.13.4	Human exposure to ultraviolet (UV) radiation .....	The equipment does not produce significant UV radiation.	N/A
4.3.13.5	Lasers (including laser diodes) and LEDs	Refer to below.	N/A
4.3.13.5.1	Lasers (including laser laser diodes)	No lasers.	N/A
	Laser class .....		—
4.3.13.5.2	Light emitting diodes (LEDs)	Diffusive LED only.	N/A
4.3.13.6	Other types .....	The equipment does not generate other types of radiation.	N/A

<b>4.4</b>	<b>Protection against hazardous moving parts</b>		<b>N/A</b>
4.4.1	General	4.4.1 – 4.4.5: No moving parts.	N/A
4.4.2	Protection in operator access areas .....		N/A
	Household and home/office document/media shredders		—
4.4.3	Protection in restricted access locations .....		N/A
4.4.4	Protection in service access areas		N/A
4.4.5	Protection against moving fan blades		N/A
4.4.5.1	General		—
	Not considered to cause pain or injury. a).....:		—
	Is considered to cause pain, not injury. b) .....		—
	Considered to cause injury. c) .....		—
4.4.5.2	Protection for users		N/A
	Use of symbol or warning .....		—
4.4.5.3	Protection for service persons		N/A
	Use of symbol or warning .....		—

<b>4.5</b>	<b>Thermal requirements</b>		<b>P</b>
4.5.1	General	Considered.	P
4.5.2	Temperature tests	(see appended table 4.5)	P

IEC 60950-1			
Clause	Requirement + Test	Result - Remark	Verdict
	Normal load condition per Annex L .....	Rated load with continuous operation.	<b>P</b>
4.5.3	Temperature limits for materials	(see appended table 4.5)	<b>P</b>
4.5.4	Touch temperature limits	(see appended table 4.5)	<b>P</b>
4.5.5	Resistance to abnormal heat .....	No thermoplastic parts carrying hazardous voltages.	<b>N/A</b>

<b>4.6</b>	<b>Openings in enclosures</b>		<b>P</b>
4.6.1	Top and side openings	Refer to bellow	<b>P</b>
	Dimensions (mm) .....	<p><b>External plastic enclosure:</b></p> <p><b>Front side:</b> No openings.</p> <p><b>Rear sides:</b> - One key hold opening Max. 7.2 x 3.1 mm. - Numerous slot openings, each measured 18.5 x 1.1 mm.</p> <p><b>Top, left and right side:</b> no openings.</p> <p><b>Internal metal chassis:</b></p> <p><b>Top side:</b> Numerous circle openings measured Max. 4.2 mm in diameter.</p> <p><b>Right side:</b> One rectangle opening measured Max. 33.0 x 11.5 mm for data transmission wire.</p> <p><b>Left side:</b> no openings.</p> <p><b>Rear side:</b> no openings. (No any components are located within 5° projection of openings)</p>	—
4.6.2	Bottoms of fire enclosures	Refer to bellow	<b>P</b>
	Construction of the bottom, dimensions (mm) ...	No openings.	—
4.6.3	Doors or covers in fire enclosures	No doors or covers in the enclosure.	<b>N/A</b>
4.6.4	Openings in transportable equipment	The unit is not regarded as transportable equipment.	<b>N/A</b>
4.6.4.1	Constructional design measures		<b>N/A</b>
	Dimensions (mm) .....		—

<b>IEC 60950-1</b>			
Clause	Requirement + Test	Result - Remark	Verdict
4.6.4.2	Evaluation measures for larger openings		<b>N/A</b>
4.6.4.3	Use of metallized parts		<b>N/A</b>
4.6.5	Adhesives for constructional purposes	No barrier secured by adhesive inside enclosure.	<b>N/A</b>
	Conditioning temperature (°C), time (weeks).....:		—
<b>4.7</b>	<b>Resistance to fire</b>		<b>P</b>
4.7.1	Reducing the risk of ignition and spread of flame	Method 1 is used.	<b>P</b>
	Method 1, selection and application of components wiring and materials	(see appended table 4.7)	<b>P</b>
	Method 2, application of all of simulated fault condition tests	Not used method 2.	<b>N/A</b>
4.7.2	Conditions for a fire enclosure	Refer to below:	—
4.7.2.1	Parts requiring a fire enclosure	The fire enclosure is required to cover all part, except sec. LED driver board and keypad board.	<b>P</b>
4.7.2.2	Parts not requiring a fire enclosure	The following parts are not required fire enclosure: sec. LED drive board and keypad board, located outside of fire enclosure, which are supplied by LPS.	<b>P</b>
4.7.3	Materials	Refer to below:	<b>P</b>
4.7.3.1	General	Components and materials have adequate flammability classification. See appended table 1.5.1.	<b>P</b>
4.7.3.2	Materials for fire enclosures	The fire enclosure is of metal and glass of LCD panel. (Glass of LCD panel is complies Annex A.2, refer to Annex A.2)	<b>P</b>
4.7.3.3	Materials for components and other parts outside fire enclosures	The parts outside the fire enclosure is made of HB min.	<b>P</b>
4.7.3.4	Materials for components and other parts inside fire enclosures	Other materials inside the fire enclosure are minimum V-2 material. For Varistor, refer to Annex Q.	<b>P</b>
4.7.3.5	Materials for air filter assemblies	No air filters in the equipment.	<b>N/A</b>
4.7.3.6	Materials used in high-voltage components	No parts exceeding 4kV.	<b>N/A</b>
<b>5</b>	<b>ELECTRICAL REQUIREMENTS AND SIMULATED ABNORMAL CONDITIONS</b>		<b>P</b>

IEC 60950-1			
Clause	Requirement + Test	Result - Remark	Verdict
5.1	Touch current and protective conductor current		<b>P</b>
5.1.1	General	Test conducted in accordance with 5.1.2 to 5.1.7.	<b>P</b>
5.1.2	Configuration of equipment under test (EUT)	Refer to below:	—
5.1.2.1	Single connection to an a.c. mains supply	Considered.	<b>P</b>
5.1.2.2	Redundant multiple connections to an a.c. mains supply	No multiple power sources.	<b>N/A</b>
5.1.2.3	Simultaneous multiple connections to an a.c. mains supply	No multiple power sources.	<b>N/A</b>
5.1.3	Test circuit	Tested for connection to IT power distribution system (also relevant for TN or TT power distribution system).	<b>P</b>
5.1.4	Application of measuring instrument	Measuring instrument D.1 is used.	—
5.1.5	Test procedure	Considered.	—
5.1.6	Test measurements	Measuring instrument D.1 is used.	—
	Supply voltage (V) .....	(See appended table 5.1)	—
	Measured touch current (mA) .....	(See appended table 5.1)	<b>P</b>
	Max. allowed touch current (mA) .....	3.5 and 0.25	—
	Measured protective conductor current (mA) .....		—
	Max. allowed protective conductor current (mA)....		—
5.1.7	Equipment with touch current exceeding 3,5 mA	The touch current does not exceed 3.5mA.	<b>N/A</b>
5.1.7.1	General .....		—
5.1.7.2	Simultaneous multiple connections to the supply		—
5.1.8	Touch currents to telecommunication networks and cable distribution systems and from telecommunication networks	Not connected to a telecommunication network nor cable distribution systems.	<b>N/A</b>
5.1.8.1	Limitation of the touch current to a telecommunication network or to a cable distribution system		—
	Supply voltage (V) .....		—
	Measured touch current (mA) .....		—
	Max. allowed touch current (mA) .....		—
5.1.8.2	Summation of touch currents from telecommunication networks	Not connected to a telecommunication network.	<b>N/A</b>
	a) EUT with earthed telecommunication ports .....		—

IEC 60950-1			
Clause	Requirement + Test	Result - Remark	Verdict
	b) EUT whose telecommunication ports have no reference to protective earth		—

<b>5.2</b>	<b>Electric strength</b>		<b>P</b>
5.2.1	General	(see appended table 5.2)	<b>P</b>
5.2.2	Test procedure	(see appended table 5.2)	<b>P</b>

<b>5.3</b>	<b>Abnormal operating and fault conditions</b>		<b>P</b>
5.3.1	Protection against overload and abnormal operation	(see appended table 5.3)	<b>P</b>
5.3.2	Motors	There are no motors in the equipment.	<b>N/A</b>
5.3.3	Transformers	See appended Annex C.	<b>P</b>
5.3.4	Functional insulation.....:	Complies with a) and c).	<b>P</b>
5.3.5	Electromechanical components	No electromechanical components in secondary circuits.	<b>N/A</b>
5.3.6	Audio amplifiers in ITE .....	No audio amplifiers inside equipment.	<b>N/A</b>
5.3.7	Simulation of faults	(see appended table 5.3)	<b>P</b>
5.3.8	Unattended equipment	No thermostats, temperature limiters or thermal cut-outs.	<b>N/A</b>
5.3.9	Compliance criteria for abnormal operating and fault conditions	Refer to below:	<b>P</b>
5.3.9.1	During the tests	No fire or molten metal occurred and no deformation of enclosure during the tests.	<b>P</b>
5.3.9.2	After the tests	No reduction of clearance and creepage distances. Electric strength test is made on basic, supplementary and reinforced insulation.	<b>P</b>

<b>6</b>	<b>CONNECTION TO TELECOMMUNICATION NETWORKS</b>		<b>N/A</b>
6.1	Protection of telecommunication network service persons, and users of other equipment connected to the network, from hazards in the equipment		<b>N/A</b>
6.1.1	Protection from hazardous voltages	No TNV circuits.	<b>N/A</b>
6.1.2	Separation of the telecommunication network from earth		<b>N/A</b>
6.1.2.1	Requirements		<b>N/A</b>

IEC 60950-1			
Clause	Requirement + Test	Result - Remark	Verdict
	Supply voltage (V) .....		—
	Current in the test circuit (mA) .....		—
6.1.2.2	Exclusions .....	No TNV circuits.	N/A

<b>6.2</b>	<b>Protection of equipment users from overvoltages on telecommunication networks</b>		<b>N/A</b>
6.2.1	Separation requirements	6.2.1-6.2.2.3: No TNV circuits.	N/A
6.2.2	Electric strength test procedure		—
6.2.2.1	Impulse test		—
6.2.2.2	Steady-state test		—
6.2.2.3	Compliance criteria		—

<b>6.3</b>	<b>Protection of the telecommunication wiring system from overheating</b>		<b>N/A</b>
	Max. output current (A) .....	No TNV circuits.	N/A
	Current limiting method .....		—

<b>7</b>	<b>CONNECTION TO CABLE DISTRIBUTION SYSTEMS</b>		<b>N/A</b>
7.1	General	7.1-7.4.3: Not connected to cable distribution systems.	N/A
7.2	Protection of cable distribution system service persons, and users of other equipment connected to the system, from hazardous voltages in the equipment		N/A
7.3	Protection of equipment users from overvoltages on the cable distribution system		N/A
7.4	Insulation between primary circuits and cable distribution systems		N/A
7.4.1	General		N/A
7.4.2	Voltage surge test		N/A
7.4.3	Impulse test		N/A

<b>A</b>	<b>ANNEX A, TESTS FOR RESISTANCE TO HEAT AND FIRE</b>		<b>P</b>
A.1	Flammability test for fire enclosures of movable equipment having a total mass exceeding 18 kg, and of stationary equipment (see 4.7.3.2)	Refer below:	N/A
A.1.1	Samples.....	Product mass <18kg	N/A
	Wall thickness (mm).....		—



IEC 60950-1			
Clause	Requirement + Test	Result - Remark	Verdict
A.1.2	Conditioning of samples; temperature (°C) .....		—
A.1.3	Mounting of samples .....		—
A.1.4	Test flame (see IEC 60695-11-3)		—
	Flame A, B, C or D .....		—
A.1.5	Test procedure		—
A.1.6	Compliance criteria		—
	Sample 1 burning time (s) .....		—
	Sample 2 burning time (s) .....		—
	Sample 3 burning time (s) .....		—
A.2	Flammability test for fire enclosures of movable equipment having a total mass not exceeding 18 kg, and for material and components located inside fire enclosures (see 4.7.3.2 and 4.7.3.4)		N/A
A.2.1	Samples, material.....	All materials have suitable flame class and testing of Glass of LCD panel	P
	Wall thickness (mm).....	0.34mm	—
A.2.2	Conditioning of samples; temperature (°C) .....	70°C, for 7 days (168 h)	P
A.2.3	Mounting of samples .....	Samples are mounted vertically.	P
A.2.4	Test flame (see IEC 60695-11-4)	Considered	P
	Flame A, B or C .....		—
A.2.5	Test procedure		N/A
A.2.6	Compliance criteria		N/A
	Sample 1 burning time (s) .....		—
	Sample 2 burning time (s) .....		—
	Sample 3 burning time (s) .....		—
A.2.7	Alternative test acc. To IEC 60695-11-5, cl. 5 and 9		N/A
	Sample 1 burning time (s) .....		—
	Sample 2 burning time (s) .....		—
	Sample 3 burning time (s) .....		—
A.3	Hot flaming oil test (see 4.6.2)	Not applicable.	N/A
A.3.1	Mounting of samples		N/A
A.3.2	Test procedure		N/A
A.3.3	Compliance criterion		N/A

IEC 60950-1			
Clause	Requirement + Test	Result - Remark	Verdict
<b>B</b>	<b>ANNEX B, MOTOR TESTS UNDER ABNORMAL CONDITIONS (see 4.7.2.2 and 5.3.2)</b>		<b>N/A</b>
B.1	General requirements	No motor in the equipment.	N/A
	Position .....		—
	Manufacturer .....		—
	Type .....		—
	Rated values .....		—
B.2	Test conditions		N/A
B.3	Maximum temperatures		N/A
B.4	Running overload test		N/A
B.5	Locked-rotor overload test		N/A
	Test duration (days) .....		—
	Electric strength test: test voltage (V) .....		—
B.6	Running overload test for d.c. motors in secondary circuits		N/A
B.6.1	General		N/A
B.6.2	Test procedure		N/A
B.6.3	Alternative test procedure		N/A
B.6.4	Electric strength test; test voltage (V) .....		N/A
B.7	Locked-rotor overload test for d.c. motors in secondary circuits		N/A
B.7.1	General		N/A
B.7.2	Test procedure		N/A
B.7.3	Alternative test procedure		N/A
B.7.4	Electric strength test; test voltage (V) .....		N/A
B.8	Test for motors with capacitors		N/A
B.9	Test for three-phase motors		N/A
B.10	Test for series motors		N/A
	Operating voltage (V) .....		—

<b>C</b>	<b>ANNEX C, TRANSFORMERS (see 1.5.4 and 5.3.3)</b>		<b>P</b>
	Position .....	Primary to SELV.	—
	Manufacturer .....	(see appended table 1.5.1)	—
	Type .....	(see appended table 1.5.1)	—
	Rated values .....	(see appended table 1.5.1)	—

IEC 60950-1			
Clause	Requirement + Test	Result - Remark	Verdict
	Method of protection..... :	Inherent impedance.	—
C.1	Overload test	(see appended table 5.3)	P
C.2	Insulation	The reinforced insulation fulfil the requirement in Sub-clause 2.10 and relevant tests of Sub-clause 5.2.2	P
	Protection from displacement of windings..... :	Secured by tubing and insulation tape. (see appended table C.2)	P

<b>D</b>	<b>ANNEX D, MEASURING INSTRUMENTS FOR TOUCH-CURRENT TESTS (see 5.1.4)</b>		<b>P</b>
D.1	Measuring instrument	Figure D.1 used.	P
D.2	Alternative measuring instrument		N/A

<b>E</b>	<b>ANNEX E, TEMPERATURE RISE OF A WINDING (see 1.4.13)</b>		<b>N/A</b>
----------	--	--	------------

<b>F</b>	<b>ANNEX F, MEASUREMENT OF CLEARANCES AND CREEPAGE DISTANCES (see 2.10 and Annex G)</b>		<b>P</b>
----------	---	--	----------

<b>G</b>	<b>ANNEX G, ALTERNATIVE METHOD FOR DETERMINING MINIMUM CLEARANCES</b>		<b>N/A</b>
G.1	Clearances		N/A
G.1.1	General		N/A
G.1.2	Summary of the procedure for determining minimum clearances		N/A
G.2	Determination of mains transient voltage (V)		N/A
G.2.1	AC mains supply .....		N/A
G.2.2	Earthed d.c. mains supplies .....		N/A
G.2.3	Unearthed d.c. mains supplies .....		N/A
G.2.4	Battery operation .....		N/A
G.3	Determination of telecommunication network transient voltage (V) .....		N/A
G.4	Determination of required withstand voltage (V)		N/A
G.4.1	Mains transients and internal repetitive peaks .... :		N/A
G.4.2	Transients from telecommunication networks ..... :		N/A
G.4.3	Combination of transients		N/A

IEC 60950-1			
Clause	Requirement + Test	Result - Remark	Verdict
G.4.4	Transients from cable distribution systems		N/A
G.5	Measurement of transient voltages (V)		N/A
	a) Transients from a mains supply		N/A
	For an a.c. mains supply		N/A
	For a d.c. mains supply		N/A
	b) Transients from a telecommunication network		N/A
G.6	Determination of minimum clearances ..... :		N/A

<b>H</b>	<b>ANNEX H, IONIZING RADIATION (see 4.3.13)</b>		<b>N/A</b>
----------	---	--	------------

<b>J</b>	<b>ANNEX J, TABLE OF ELECTROCHEMICAL POTENTIALS (see 2.6.5.6)</b>		<b>P</b>
	Metal(s) used ..... :		—

<b>K</b>	<b>ANNEX K, THERMAL CONTROLS (see 1.5.3 and 5.3.8)</b>		<b>N/A</b>
K.1	Making and breaking capacity		N/A
K.2	Thermostat reliability; operating voltage (V) ..... :		N/A
K.3	Thermostat endurance test; operating voltage (V) ..... :		N/A
K.4	Temperature limiter endurance; operating voltage (V) ..... :		N/A
K.5	Thermal cut-out reliability		N/A
K.6	Stability of operation		N/A

<b>L</b>	<b>ANNEX L, NORMAL LOAD CONDITIONS FOR SOME TYPES OF ELECTRICAL BUSINESS EQUIPMENT (see 1.2.2.1 and 4.5.2)</b>		<b>P</b>
L.1	Typewriters		N/A
L.2	Adding machines and cash registers		N/A
L.3	Erasers		N/A
L.4	Pencil sharpeners		N/A
L.5	Duplicators and copy machines		N/A
L.6	Motor-operated files		N/A
L.7	Other business equipment		P

<b>M</b>	<b>ANNEX M, CRITERIA FOR TELEPHONE RINGING SIGNALS (see 2.3.1)</b>		<b>N/A</b>
M.1	Introduction	No telephone ringing signal.	N/A

IEC 60950-1			
Clause	Requirement + Test	Result - Remark	Verdict
M.2	Method A		N/A
M.3	Method B		N/A
M.3.1	Ringing signal		N/A
M.3.1.1	Frequency (Hz) ..... :		—
M.3.1.2	Voltage (V) ..... :		—
M.3.1.3	Cadence; time (s), voltage (V) ..... :		—
M.3.1.4	Single fault current (mA) ..... :		—
M.3.2	Tripping device and monitoring voltage ..... :		N/A
M.3.2.1	Conditions for use of a tripping device or a monitoring voltage		N/A
M.3.2.2	Tripping device		N/A
M.3.2.3	Monitoring voltage (V) ..... :		N/A
<b>N</b>	<b>ANNEX N, IMPULSE TEST GENERATORS (see 1.5.7.2, 1.5.7.3, 2.10.3.9, 6.2.2.1, 7.3.2, 7.4.3 and Clause G.5)</b>		<b>N/A</b>
N.1	ITU-T impulse test generators		N/A
N.2	IEC 60065 impulse test generator		N/A
<b>P</b>	<b>ANNEX P, NORMATIVE REFERENCES</b>		<b>P</b>
<b>Q</b>	<b>ANNEX Q, Voltage dependent resistors (VDRs) (see 1.5.9.1)</b>		<b>N/A</b>
	- Preferred climatic categories ..... :	No VDR in the equipment.	N/A
	- Maximum continuous voltage ..... :		N/A
	- Combination pulse current ..... :		N/A
	Body of the VDR Test according to IEC60695-11-5.....:		—
	Body of the VDR. Flammability class of material ( min V-1).....:		N/A
<b>R</b>	<b>ANNEX R, EXAMPLES OF REQUIREMENTS FOR QUALITY CONTROL PROGRAMMES</b>		<b>N/A</b>
R.1	Minimum separation distances for unpopulated coated printed boards (see 2.10.6.2)	The quality control programmes are not used.	N/A
R.2	Reduced clearances (see 2.10.3)		N/A
<b>S</b>	<b>ANNEX S, PROCEDURE FOR IMPULSE TESTING (see 6.2.2.3)</b>		<b>N/A</b>

IEC 60950-1			
Clause	Requirement + Test	Result - Remark	Verdict
S.1	Test equipment	The impulse testing is not used.	N/A
S.2	Test procedure		N/A
S.3	Examples of waveforms during impulse testing		N/A
<b>T</b>	<b>ANNEX T, GUIDANCE ON PROTECTION AGAINST INGRESS OF WATER (see 1.1.2)</b>		<b>N/A</b>
			—
<b>U</b>	<b>ANNEX U, INSULATED WINDING WIRES FOR USE WITHOUT INTERLEAVED INSULATION (see 2.10.5.12)</b>		<b>N/A</b>
			—
<b>V</b>	<b>ANNEX V, AC POWER DISTRIBUTION SYSTEMS (see 1.6.1)</b>		<b>P</b>
V.1	Introduction	See below.	P
V.2	TN power distribution systems	See sub-clause 1.6.1.	P
<b>W</b>	<b>ANNEX W, SUMMATION OF TOUCH CURRENTS</b>		<b>N/A</b>
W.1	Touch current from electronic circuits		N/A
W.1.1	Floating circuits		N/A
W.1.2	Earthed circuits		N/A
W.2	Interconnection of several equipments		N/A
W.2.1	Isolation		N/A
W.2.2	Common return, isolated from earth		N/A
W.2.3	Common return, connected to protective earth		N/A
<b>X</b>	<b>ANNEX X, MAXIMUM HEATING EFFECT IN TRANSFORMER TESTS (see clause C.1)</b>		<b>P</b>
X.1	Determination of maximum input current	See Annex C.1	P
X.2	Overload test procedure	Electronic protection mode is used.	P
<b>Y</b>	<b>ANNEX Y, ULTRAVIOLET LIGHT CONDITIONING TEST (see 4.3.13.3)</b>		<b>N/A</b>
Y.1	Test apparatus .....	No ultraviolet light.	N/A
Y.2	Mounting of test samples .....		N/A
Y.3	Carbon-arc light-exposure apparatus .....		N/A
Y.4	Xenon-arc light exposure apparatus .....		N/A
<b>Z</b>	<b>ANNEX Z, OVERVOLTAGE CATEGORIES (see 2.10.3.2 and Clause G.2)</b>		<b>P</b>

IEC 60950-1			
Clause	Requirement + Test	Result - Remark	Verdict
<b>AA</b>	<b>ANNEX AA, MANDREL TEST (see 2.10.5.8)</b>		<b>N/A</b>
<b>BB</b>	<b>ANNEX BB, CHANGES IN THE SECOND EDITION</b>		<b>P</b>
<b>CC</b>	<b>ANNEX CC, Evaluation of integrated circuit (IC) current limiters</b>		<b>N/A</b>
CC.1	General	No such components used.	<b>N/A</b>
CC.2	Test program 1.....:		<b>N/A</b>
CC.3	Test program 2.....:		<b>N/A</b>
CC.4	Test program 3.....:		<b>N/A</b>
CC.5	Compliance.....:		<b>N/A</b>
<b>DD</b>	<b>ANNEX DD, Requirements for the mounting means of rack-mounted equipment</b>		<b>N/A</b>
DD.1	General	Not a rack-mounted equipment.	<b>N/A</b>
DD.2	Mechanical strength test, variable N.....:		<b>N/A</b>
DD.3	Mechanical strength test, 250N, including end stops.....:		<b>N/A</b>
DD.4	Compliance.....:		<b>N/A</b>
<b>EE</b>	<b>ANNEX EE, Household and home/office document/media shredders</b>		<b>N/A</b>
EE.1	General	Not household and home/office document/media shredders	<b>N/A</b>
EE.2	Markings and instructions		<b>N/A</b>
	Use of markings or symbols.....:		<b>N/A</b>
	Information of user instructions, maintenance and/or servicing instructions.....:		<b>N/A</b>
EE.3	Inadvertent reactivation test.....:		<b>N/A</b>
EE.4	Disconnection of power to hazardous moving parts:		<b>N/A</b>
	Use of markings or symbols.....:		<b>N/A</b>
EE.5	Protection against hazardous moving parts		<b>N/A</b>
	Test with test finger (Figure 2A).....:		<b>N/A</b>
	Test with wedge probe (Figure EE1 and EE2) .....		<b>N/A</b>

1.5.1	TABLE: List of critical components					P
Object/part No.	Manufacturer/ trademark	Type/model	Technical data	Standard (Edition / year)	Mark(s) of conformity1)	
Fire enclosure	Interchangeable	Interchangeable	Metal, 0.5mm thick	--	Tested in the equip.	
Stand	Interchangeable	Interchangeable	Min. HB	UL94	UL	
Plastic enclosure	Interchangeable	Interchangeable	HB or better, min. 1.6mm thick	UL 94	UL	
LCD display Panel	BOE	BOEA215XXX (X=0-9, A-Z or blank)	21.5" TFT type, LED Backlight	--	See Annex A.2	
PCB material	Interchangeable	Interchangeable	V-1 or better, min. 105°C	UL 796	UL	
The following components are located on PSU & main board type LE22BW-D-7 (with VGA and DVI input) and LE19BW-A-2 (with VGA input) which are different at secondary circuits.						
Appliance inlet (S801)	Tecx-unions Rong Feng Rong Feng Zhangjiagang Huajie Electronic Co., Ltd. Inalways  Shenzhen Delikang Kunshan DLK	TU-301-SP, SS-7B, SS-7B-1 SS-120 SA-4S  0711, 0711-1 0711-2, 0711-3 CDJ-3  CDJ-3	10A, 250V, min. 70°C	IEC 60320-1, UL 498	ENEC, UL VDE, UL VDE, UL VDE, UL  VDE, UL VDE, UL VDE, UL  VDE, UL	
Fuse (F801)	Ever Island walter Bussmann Bussmann Hollyland Hollyland Littelfuse Conquer Bel	2010, 2000  SS-5 SR-5 5RT 5ET 382, 392 MET, MST MRT	T2.0AL, 250V	IEC 60127-1, IEC 60127-3, UL 248-14	VDE, UL  VDE, UL VDE, UL VDE, UL VDE, UL VDE, UL VDE, UL VDE, UL	
Y-capacitors (C820,C830, C831) (Optional)	Success TDK Kunshan Wansheng Xiamen sino falsh	SE, SB CD CT7  HCY Series, HCX Series	C820=3300pF C830=C831= 2000pF Max., Min. 250V, min. 85°C, min. Y2 type	IEC 60384-14 2ed., UL 1414	FI, UL FI, UL FI, UL  FI, UL FI, UL	
Thermistor (R802) (Optional)	Interchangeable	Interchangeable	10Ω at 25°C, 3A (Located after main fuse)		Tested in the equip.	



Object/part No.	Manufacturer/ trademark	Type/model	Technical data	Standard (Edition / year)	Mark(s) of conformity1)
X-Capacitor (C810) (Optional)	Liow Gu Europtronic Chiefcon Shiny Space STRONG Components Co. LTD	GS-L MPX CKX SX1 MPX	Max. 0.33µF, 250V, min. 100°C, min. X2	IEC 60384-14 2ed. with 21 days damp heat test, UL 1414	FI, UL FI, UL VDE, UL VDE, UL VDE, UL
Line Choke (L805) <b>1)</b> (optional)	ASET MANNILUN LI TAI	2371214310X-0B 2371214310X-0C 2371214310T-02 (X=0-9, A-Z or blank for RoHS difference purpose)	130°C		Tested in equip
Bobbin	Chang Chun Chang Chun	T375HF T373J	Phenolic, V-0 Phenolic, V-0	UL 94	UL UL
Bleeder resistors (R801, R803, R833)	Interchangeable	SMD type	1MΩ, min. 1/4W (three in series, located after fuse)		Tested in the equip.
Bridge rectifier (D801)	Interchangeable	Interchangeable	Min. 2A, min. 600V		Tested in the equip.
Bulk capacitor (C816)	Interchangeable	Interchangeable	47µF, min. 400V, 105°C		Tested in the equip.
Mosfet (Q801)	Interchangeable	Interchangeable	Min. 2A, min. 600V		Tested in the equip.
Current sensor resistor (R831)	Interchangeable	Interchangeable	0.68-1.0Ω, 2W		Tested in the equip.
Transformer (T801) <b>2)</b>	LI TAI (factory: LITAI ELECTONICS ENTERPRISE CO., LTD.)	2374225120X-02 (X=0-9, A-Z or blank for RoHS difference purpose)	Class B	IEC 60950-1 and evaluated acc. To IEC60085	Tested in the equip.
Bobbin		T375J	V-0, phenolic	UL 94	UL
Insu. tape	3M SYMBIO SYMBIO INC	1350F-1(b) 35660Y*d	130°C 130°C	UL 510 UL 510	UL UL
Triple insu. wire	COSMOLINK	TIW-M	130°C	IEC 60950-1 Annex U, UL 2353	VDE, UL

Object/part No.	Manufacturer/ trademark	Type/model	Technical data	Standard (Edition / year)	Mark(s) of conformity1)
Alt. transformer (T801) 2)	ASET (factory: PHILIP SUZHOU ASIA ELECTRONICS TECHNOLOGY CO.,LTD)	2374225120X-08 (X=0-9, A-Z or blank for RoHS difference purpose)	Class B	IEC 60950-1 and evaluated acc. To IEC60085	Tested in the equip.
Bobbin	SUMITOMO BAKELITE CO LTD	PM-9820	V-0, phenolic	UL 94	UL
Insu. tape	JINGJIANG YAHUA PRESSURE SENSITIVE GLUE CO LTD	CT	130°C	UL 510	UL
Triple insu. wire	COSMOLINK	TIW-M	130°C	IEC 60950-1 Annex U, UL 2353	VDE, UL
Alt. ransformer (T801) 2)	SUZHOU MANNILUN ELECTRONICS TECHNOLOGY CO LTD(factory: SUZHOU MANNILUN ELECTRONICS TECHNOLOGY CO LTD)	2374225120X-0C (X=0-9, A-Z or blank for RoHS difference purpose)	Class B	IEC 60950-1 and evaluated acc. To IEC60085	Tested in the equip.
Bobbin	SUMITOMO BAKELITE CO LTD	PM-9820	V-0, phenolic	UL 94	UL
Insu. tape	JINGJIANG YAHUA PRESSURE SENSITIVE GLUE CO LTD	CT	130°C	UL 510	UL UL
Triple insu. wire	COSMOLINK	TIW-M	130°C	IEC 60950-1 Annex U, UL 2353	VDE, UL

Object/part No.	Manufacturer/ trademark	Type/model	Technical data	Standard (Edition / year)	Mark(s) of conformity <sup>1)</sup>
Optocoupler (I802)	COSMO	K1010 series	Isolating voltage: min 3000Vac. Int. cr. / Ext. cr. / Dti: 5.3 / 6.5 / 0.5 mm., min. 100°C	IEC 60950-1 UL 1577	FI, UL
Alt. Optocoupler (I802)	Lite-On	LTV817	Isolating voltage: min 3000Vac. Int. cr. / Ext. cr. / Dti: *) / 8 / 0.6 mm., min. 100°C	IEC 60950-1 UL 1577	FI, UL
Alt. Optocoupler (I802)	Lite-On	LTV827	Isolating voltage: min 3000Vac. Int. cr. / Ext. cr. / Dti: *) / 8 / 0.6 mm., min. 100°C	IEC 60950-1 UL 1577	FI, UL
Alt. Optocoupler (I802)	Lite-On	LTV847	Isolating voltage: min 3000Vac. Int. cr. / Ext. cr. / Dti: *) / 8 / 0.6 mm., min. 100°C	IEC 60950-1 UL 1577	FI, UL

<sup>1)</sup> An asterisk indicates a mark which assures the agreed level of surveillance

Supplementary information:

**1)** All sources of choke are identical to each other's except manufacturer, type and materials.  
**2)** All sources of transformer are identical to each other's except manufacturer, type and materials. Refer to attachment transformer specification.  
 \*) There is not any internal creepage distance. Test according to IEC 60950-1:2005, cl. 2.10.8 (same as requirement in IEC 60950-1:2005, Am 1: 2009, Am2: 2013 cl. 2.10.9) has been carried out ten times for the components at 100°C / 25°C / 0°C / 25°C. Humidity treatment of 48 hours as well as electric strength tests at 3000V / 1 minute and min. 4800V / 1 minute were carried out to the component after thermal cycling test.

1.5.1	TABLE: Opto Electronic Devices	P
Manufacturer ..... : See appended table 1.5.1		
Type..... : See appended table 1.5.1		
Separately tested ..... : See appended table 1.5.1		
Bridging insulation ..... : Reinforced insulation		
External creepage distance..... : See appended table 1.5.1		
Internal creepage distance..... : See appended table 1.5.1		
Distance through insulation..... : See appended table 1.5.1		
Tested under the following conditions..... : R, S, B		
Input..... :		
Output..... :		
supplementary information		

1.6.2	TABLE: Electrical data (in normal conditions)						P
U (V)	I (A)	Irated (A)	P (W)	Fuse #	Ifuse (A)	Condition/status	
Testing conducted on PSU & main board P/N: LE19BW-A-2 (VGA mode)							
90V/50Hz	0.37	--	21.0	F801	0.37	Maximum Normal Load	
90V/60Hz	0.37	--	21.0	F801	0.37	Maximum Normal Load	
100V/50Hz	0.34	1.5	20.9	F801	0.34	Maximum Normal Load	
100V/60Hz	0.34	1.5	20.9	F801	0.34	Maximum Normal Load	
240V/50Hz	0.17	1.5	20.6	F801	0.17	Maximum Normal Load	
240V/60Hz	0.17	1.5	20.6	F801	0.17	Maximum Normal Load	
264V/50Hz	0.16	--	20.6	F801	0.16	Maximum Normal Load	
264V/60Hz	0.16	--	20.6	F801	0.16	Maximum Normal Load	
Testing conducted on PSU & main board P/N: LE22BW-D-7 (VGA mode)							
90V/50Hz	0.39	--	22.5	F801	0.39	Maximum Normal Load	
90V/60Hz	0.39	--	22.5	F801	0.39	Maximum Normal Load	
100V/50Hz	0.36	1.5	22.4	F801	0.36	Maximum Normal Load	
100V/60Hz	0.36	1.5	22.4	F801	0.36	Maximum Normal Load	
240V/50Hz	0.18	1.5	22.0	F801	0.18	Maximum Normal Load	
240V/60Hz	0.18	1.5	22.0	F801	0.18	Maximum Normal Load	
264V/50Hz	0.17	--	22.0	F801	0.17	Maximum Normal Load	
264V/60Hz	0.17	--	22.0	F801	0.17	Maximum Normal Load	

U (V)	I (A)	Irated (A)	P (W)	Fuse #	Ifuse (A)	Condition/status
Testing conducted on PSU & main board P/N: LE22BW-D-7 (DVI mode)						
90V/50Hz	0.39	--	22.6	F801	0.39	Maximum Normal Load
90V/60Hz	0.39	--	22.6	F801	0.39	Maximum Normal Load
100V/50Hz	0.36	1.5	22.5	F801	0.36	Maximum Normal Load
100V/60Hz	0.36	1.5	22.5	F801	0.36	Maximum Normal Load
240V/50Hz	0.18	1.5	22.1	F801	0.18	Maximum Normal Load
240V/60Hz	0.18	1.5	22.1	F801	0.18	Maximum Normal Load
264V/50Hz	0.17	--	22.1	F801	0.17	Maximum Normal Load
264V/60Hz	0.17	--	22.1	F801	0.17	Maximum Normal Load
Supplementary information:						

2.1.1.5 c) 1) TABLE: max. V, A, VA test					P
Voltage (rated) (V)	Current (rated) (A)	Voltage (max.) (V)	Current (max.) (A)	VA (max.) (VA)	
+5V (After D806)	2.0	5.00	6.0	25.1	
+14V (After D810)	0.9	14.30	3.0	25.52	
supplementary information:					
Measured on build-in power supply output,					

2.1.1.5 c2) TABLE: stored energy			N/A
Capacitance C (µF)	Voltage U (V)	Energy E (J)	
Supplementary information:			
$E=0,5 CU^2 \times 10^{-6}$			

2.1.1.7 TABLE: discharge test				P
Condition	calculated (s)	measured (s)	t u → 0V (s)	Comments
L-N	0.99	0.79	--	Vo=388V, 37% of Vo=143.6V
supplementary information:				
Overall capacity C810 (0.33uF). Discharge resistor: 3MΩ, R801=R803=R833=1MΩ, 3 in series. Note: supplied with 264V/60Hz.				

2.2	TABLE: evaluation of voltage limiting components in SELV circuits			P
Component (measured between)	max. voltage (V) (normal operation)		Voltage Limiting Components	
	V peak	V d.c.		
T801 Pin 6,7 to Pin 9, 10	29.6	--	--	
T801 Pin 8 to Pin 9, 10	83.0	--	--	
After R822, R823	78.2	--	--	
After C823, D810	--	14.8	C823, D810	
Before L901 to earth (LED drive board)	--	14.8	--	
After L901 to earth (LED drive board)	43.2	--	--	
After D901 to earth (LED driver board)	--	39.2	D901	
Fault test performed on voltage limiting components	Voltage measured (V) in SELV circuits (V peak or V d.c.)			
D810 s-c	0 Vdc (Measured at +14V to GND)			
C823 s-c	14.8 Vdc (Measured at +14V to GND)			
R822, R823 s-c	14.8 Vdc (Measured at +14V to GND)			
L901 s-c	33.0 Vdc (Measured at P901 pin3, 4 to GND) *)			
D901 s-c	14.8 Vdc (Measured at P901 pin3, 4 to GND) *)			
C924 s-c	1.58 Vdc (Measured at P901 pin3, 4 to GND) *)			
R921 s-c	14.9 Vdc (Measured at P901 pin3, 4 to GND) *)			
R922 s-c	14.9 Vdc (Measured at P901 pin3, 4 to GND) *)			
R923	14.9 Vdc (Measured at P901 pin3, 4 to GND) *)			
supplementary information: s-c=short circuit				
*) per client request				

2.4	TABLE: Limited current circuits				N/A
Location	Voltage (V)	Current (mA)	Freq. (Hz)	Limit (mA)	
Supplementary information:					

2.5	TABLE: Limited power sources					P
Circuit output tested:						
Note: Measured Uoc (V) with all load circuits disconnected:						
Components	Uoc (V)	Isc (A)		VA		
		Meas.	Limit	Meas.	Limit	
Testing conducted on power supply +14Vdc o/p: table 2B (after D810)						
Normal condition	14.30	3.0	8	25.52	100	
R826 s-c	14.30	2.9	8	25.11	100	
R827 s-c	14.30	2.8	8	24.78	100	
R829 s-c	0	0	8	0	100	
Testing conducted on power supply +5Vdc o/p: table 2B (after D806)						
Normal condition	5.1	6.0	8	25.1	100	
R826 s-c	5.1	5.9	8	24.7	100	
R827 s-c	5.1	5.8	8	23.9	100	
R829 s-c	0	0	8	0	100	
Supplementary information:						

2.6.3.4	TABLE: ground continue test		P
Location	Resistance measured (mΩ)	Comments	
PE pin of AC inlet to Metal chassis	11	Test current = 32A, 2min. Voltage drop = 0.352V	
PE pin of AC inlet to Metal chassis	12	Test current = 40A, 2min. Voltage drop =0.48V	
PE pin of AC inlet to C820 Sec. Pin	3	Test current = 32A, 2min. Voltage drop = 0.096V	
PE pin of AC inlet to C820 Sec. Pin	4	Test current = 40A, 2min. Voltage drop =0.16V	
Supplementary information:			

2.10.2		Table: working voltage measurement		P
Location		RMS voltage (V)	Peak voltage (V)	Comments
T801	Pin 1 to Pin 6,7	210	380	
	Pin 1 to Pin 8	211	424	
	Pin 1 to Pin 9,10	209	352	
	Pin 3 to Pin 6,7	242	468	
	Pin 3 to Pin 8	234	452	
	Pin 3 to Pin 9,10	<b>247</b>	<b>472</b>	Max. Vrms and Vpeak
	Pin 4 to Pin 6,7	223	408	
	Pin 4 to Pin 8	223	384	
	Pin 4 to Pin 9,10	225	428	
	Pin 5 to Pin 6,7	222	380	
	Pin 5 to Pin 8	223	388	
	Pin 5 to Pin 9,10	222	372	
I802	Pin 3 to Pin 1	225	376	
	Pin 3 to Pin 2	225	376	
	Pin 4 to Pin 1	225	376	
	Pin 4 to Pin 2	225	376	
C820	Pin1 to Pin 2	222	376	
supplementary information:				



2.10.3 and 2.10.4	TABLE: Clearance and creepage distance measurements						P
Clearance (cl) and creepage distance (cr) at/of/between:	U peak (V)	U r.m.s. (V)	Required cl (mm)	cl (mm)	Required cr (mm)	cr (mm)	
Functional: Live – Neutral before fuse <b>a)</b>	339	240	2.3 <b>1)</b>	14.2	2.5	14.2	
Functional: F801, pad-1 – F801, pad 2 <b>a)</b>	339	240	2.3 <b>1)</b>	2.5	2.5	2.5	
Basic: Line – PE <b>a)</b>	339	240	3.0 <b>1)</b>	5.3	3.0 <b>2)</b>	5.3	
Basic: Neutral – PE <b>a)</b>	339	240	3.0 <b>1)</b>	5.3	3.0 <b>2)</b>	5.3	
Basic: C830 (prim.) – metal chassis (PE) <b>b)</b>	339	240	3.0 <b>1)</b>	5.3	3.0 <b>2)</b>	5.3	
Basic: C83 (prim.) – PE <b>a)</b>	339	240	3.0 <b>1)</b>	5.3	3.0 <b>2)</b>	5.3	
Basic: L805 (prim.) – PE <b>a)</b>	339	240	3.0 <b>1)</b>	8.0	3.0 <b>2)</b>	8.0	
Basic: C820 (prim.) – PE <b>a)</b>	376	222	3.0 <b>1)</b>	7.0	3.0 <b>2)</b>	7.0	
Basic: trace of C820 (prim.) – trace of C820 (sec.)	376	222	3.0 <b>1)</b>	7.0	3.0 <b>2)</b>	7.0	
Reinforced: trace of T801 pin 5 (prim.) – trace of D803 (sec.) <b>a)</b>	472	242	6.3 <b>1)</b>	11.0	6.3 <b>2)</b>	11.0	
Reinforced: trace of I802 (prim.) – trace of I802 (sec.)	376	225	6.0 <b>1)</b>	7.0	6.0 <b>2)</b>	7.0	
Supplementary information: - Following components are fixed by glue: C816 with PCB; C819 with PCB. <b>1)</b> This equipment is intended to be operated under altitude up to 5,000m, so the clearance is multiplied by the altitude correction factor (1.48, linear interpolation used), specified in table A.2 of IEC 60664-1, 1992+A1: 2000. <b>2)</b> The minimum creepage distance is less than the minimum clearance, that value of minimum clearance applied as the minimum creepage distance. <b>a)</b> Measured at solder side of PCB. <b>b)</b> Measured at component side of PCB.							

2.10.5	TABLE: Distance through insulation measurements					P
Distance through insulation (DTI) at/of:	U peak (V)	U rms (V)	Test voltage (V)	Required DTI (mm)	DTI (mm)	
Insulation tape in transformer (T801) Reinforced- 3 layers (2 layers tested). Basic: 1 layer.	472	242	3000V ac 1740V ac	2 layers --	3 layers 1 layer	
Supplementary information:						

<b>4.3.8</b>	<b>TABLE: Batteries</b>	<b>N/A</b>
Battery category ..... : Manufacturer ..... : Type / model..... : Voltage ..... : Capacity..... : Tested and Certified by (incl. Ref. No.) ..... :  Circuit protection diagram:		

<b>MARKINGS AND INSTRUCTIONS (1.7.13)</b>	
Location of replaceable battery	
Language(s):	
Close to the battery	
In the servicing instructions	
In the operating instructions	

<b>4.3.8</b>	<b>TABLE: Batteries</b>								<b>N/A</b>
The tests of 4.3.8 are applicable only when appropriate battery data is not available									
Is it possible to install the battery in a reverse polarity position?									
	Non-rechargeable batteries			Rechargeable batteries					
	Discharging		Un-intentional charging	Charging		Discharging		Reversed charging	
	Meas. current	Manuf. Specs.		Meas. current	Manuf. Specs.	Meas. current	Manuf. Specs.	Meas. current	Manuf. Specs.
Max. current during normal condition									
Max. current during fault condition									
Test results:									
- Chemical leaks									Verdict
- Explosion of the battery									
- Emission of flame or expulsion of molten metal									
- Electric strength tests of equipment after completion of tests									
Supplementary information:									

4.5	TABLE: Thermal requirements			<b>P</b>
	Supply voltage (V):	90V/60H	264V/60Hz	—
Maximum measured temperature T of part/at:		T (°C)		Allowed T <sub>max</sub> (°C)
AC Inlet near line (PSU)		52.3	50.2	70
C830 body (PSU)		56.3	53.3	85
C810 body (PSU)		70.3	61.6	100
PCB near R802 (PSU)		70.3	63.0	105
L805 coil (PSU)		90.8	68.1	120
PCB near Q801 (PSU)		73.0	76.9	105
C816 body (PSU)		76.3	74.3	105
PCB near D801 (PSU)		77.5	73.4	105
T801 coil (PSU)		84.2	88.3	110
C820 body (PSU)		73.6	75.7	85
I802 body (PSU)		67.7	69.7	100
PWB near I101		67.4	68.0	105
Enclosure inside near T801		45.0	44.4	--
Enclosure outside near T801		40.5	40.2	95
Ambient		40.0	40.0	--
Supplementary information:				
Having a specified maximum ambient temperature of 40°C. Tmax. Limits include less 10°C for thermocouple measurement method. The maximum temperatures are calculated according to cl. 1.4.12. If no limit is stated, temperature is for reference only.				

4.5.5	TABLE: Ball pressure test of thermoplastic parts			<b>N/A</b>
	Allowed impression diameter (mm) .....	≤ 2 mm		—
Part		Test temperature (°C)	Impression diameter (mm)	
Supplementary information:				

<b>4.7</b>	<b>TABLE: Resistance to fire</b>					<b>P</b>
Part	Manufacturer of material	Type of material	Thickness (mm)	Flammability class	Evidence	
Enclosure	Interchangeable	Interchangeable	0.6 mm	Metal	--	
Supplementary information:						

<b>5.1</b>	<b>TABLE: touch current measurement</b>			<b>P</b>
Measured between:	Measured (mA)	Limit (mA)	Comments/conditions	
Line to plastic enclosure with metal foil	0.01	0.25	Fuse in	
Neutral to plastic enclosure with metal foil	0.01	0.25	Fuse in	
Line to metal chassis	0.62	3.5	Fuse in	
Neutral to metal chassis	0.62	3.5	Fuse in	
supplementary information:				
- All Y-caps rated max. according to List of critical components.				

<b>5.2</b>	<b>TABLE: Electric strength tests, impulse tests and voltage surge tests</b>			<b>P</b>
Test voltage applied between:	Voltage shape (AC, DC, impulse, surge)	Test voltage (V)	Breakdown Yes / No	
Primary to Secondary	DC	4242	No	
Primary to PE	DC	2396	No	
Primary to Plastic enclosure	DC	4242	No	
T801 Primary to Secondary	AC	3000	No	
T801 Secondary to Core	AC	3000	No	
Supplementary information:				
All source of optocoupler, transformer (see table 1.5.1) were performed the test.				

<b>5.3</b>	<b>TABLE: Fault condition tests</b>					<b>P</b>
	Ambient temperature (°C) .....		25°C if not state.		—	
	Power source for EUT: Manufacturer, model/type, output rating .....				—	
Component No.	Fault	Supply voltage (V)	Test time	Fuse #	Fuse current (A)	Observation
Ventilation openings	Blocked	240	1 hours	F801	0.18	Unit operated normally. CT: T801 = 76.2°C, I802 = 58.5°C, ambient=29.6°C, NCD, NB, NH.
D801 (~ to +)	s-c	240	< 1sec	F801	1)	Fuse opened, CD: D801, NB, NH.
C816	s-c	240	< 1sec	F801	1)	Fuse opened, no hazards.
R831	s-c	240	< 1sec	F801	1)	Fuse opened, CD: D801, Q801, NB, NH.

Component No.	Fault	Supply voltage (V)	Test time	Fuse #	Fuse current (A)	Observation
Q801, (G - S)	s-c	240	10 mins	F801	0.01	Unit shut down, NCD, NB, NH.
Q801, (D - G)	s-c	240	< 1sec	F801	1)	Fuse opened, CD: Q801, I801, NB, NH.
Q801, (D - S)	s-c	240	< 1sec	F801	1)	Fuse opened, CD: Q801, NB, NH.
I801, (1 - 5)	s-c	240	10 mins	F801	0.01	Unit shut down, NCD, NB, NH.
I801, (2 - 5)	s-c	240	10 mins	F801	1)	Fuse opened, CD: Q801, NB, NH.
I802, (1 - 2)	s-c	240	10 mins	F801	0.01	Unit shut down, NCD, NB, NH.
I802, (3 - 4)	s-c	240	10 mins	F801	0.01	Unit shut down, NCD, NB, NH.
I802, (1)	o-c	240	10 mins	F801	0.01	Unit shut down, NCD, NB, NH.
I802, (3)	o-c	240	10 mins	F801	0.01	Unit shut down, NCD, NB, NH.
+5V - GND	s-c	240	10 mins	F801	0.01	Unit shut down, NCD, NB, NH.
+12V - GND	s-c	240	10 mins	F801	0.03	Unit shut down, NCD, NB, NH.
+12V - + 5V	s-c	240	10 mins	F801	0.03	Unit shut down, NCD, NB, NH.
T801, (1 - 3)	s-c	240	10 mins	F801	0.01	Unit shut down, NCD, NB, NH.
T801, (4 - 5)	s-c	240	10 mins	F801	0.01	Unit shut down, NCD, NB, NH.
T801, (8 - 6, 7)	s-c	240	10 mins	F801	0.01	Unit shut down, NCD, NB, NH.
T801, (8 - 9, 10)	s-c	240	10 mins	F801	0.01	Unit shut down, NCD, NB, NH.
+5V to GND	s-c	240	10 mins	F801	--	Unit shut down, NCD, NB, NH.
+14V to GND	s-c	240	10 mins	F801	--	Unit shut down, NCD, NB, NH.
+14V to +5V	s-c	240	10 mins	F801	--	Unit shut down, NCD, NB, NH.
T801 after D806 (+5V)	o-l	240	2.5 hours	F801	--	Unit shut down when increase to 5.5A, temperature was stable at 5.0A. CT: T801 coil= 108.0°C, I802=75.1°C, ambient=29.9°C, NB, NH.
T801 after D810 (+14V)	o-l	240	3.0 hours	F801	0.01	Unit shut down when increase to 2.7A, temperature was stable at 2.5A. CT: T801 coil= 102.2°C, I802=70.1°C, ambient=31.7°C, NB, NH.
<p>Supplementary information: s-c=Short circuit, o-c=Open circuit, o-l=Over load.            CT= Constant temperature were obtained, CD=Components damaged, NB= No electric strength breakdown, NCD= No component damaged, NH=No hazard.</p>						
<p>1) Fuse current is more than fuse rating times 2.1, for fuse open conditions, same result came out for each source of fuse.</p>						

C.2	TABLE: transformers							P
Loc.	Tested insulation	Working voltage peak / V (2.10.2)	Working voltage rms / V (2.10.2)	Required electric strength (5.2)	Required clearance / mm (2.10.3)	Required creepage distance / mm (2.10.4)	Required distance thr. insul. (2.10.5)	
T801	Primary windings / core – Secondary windings	472	242	3000Vac	6.3 <b>1)</b>	6.3 <b>2)</b>	2 layers min. or 0.4 mm	
Loc.	Tested insulation			Test voltage/ V	Measured clearance / mm	Measured creepage dist./ mm	Measured distance thr. insul. / mm; number of layers	
T801	Primary windings / core – Secondary windings			3000Vac	15.4	15.4	<b>3)</b>	
supplementary information:								
<p><b>1)</b> This equipment is intended to be operated under altitude up to 5,000m, so the clearance is multiplied by the altitude correction factor (1.48, linear interpolation used), specified in table A.2 of IEC 60664-1, 1992+A1: 2000</p> <p><b>2)</b> Min. creepage distance is less than the applicable min. clearance, that value of min. clearance is applied as min. creepage distance.</p> <p><b>3)</b> Secondary winding is triple insulated. Transformer core regarded as a primary part. Primary winding to core distance is 0mm.</p>								



# PCB layout

Report No. 296234

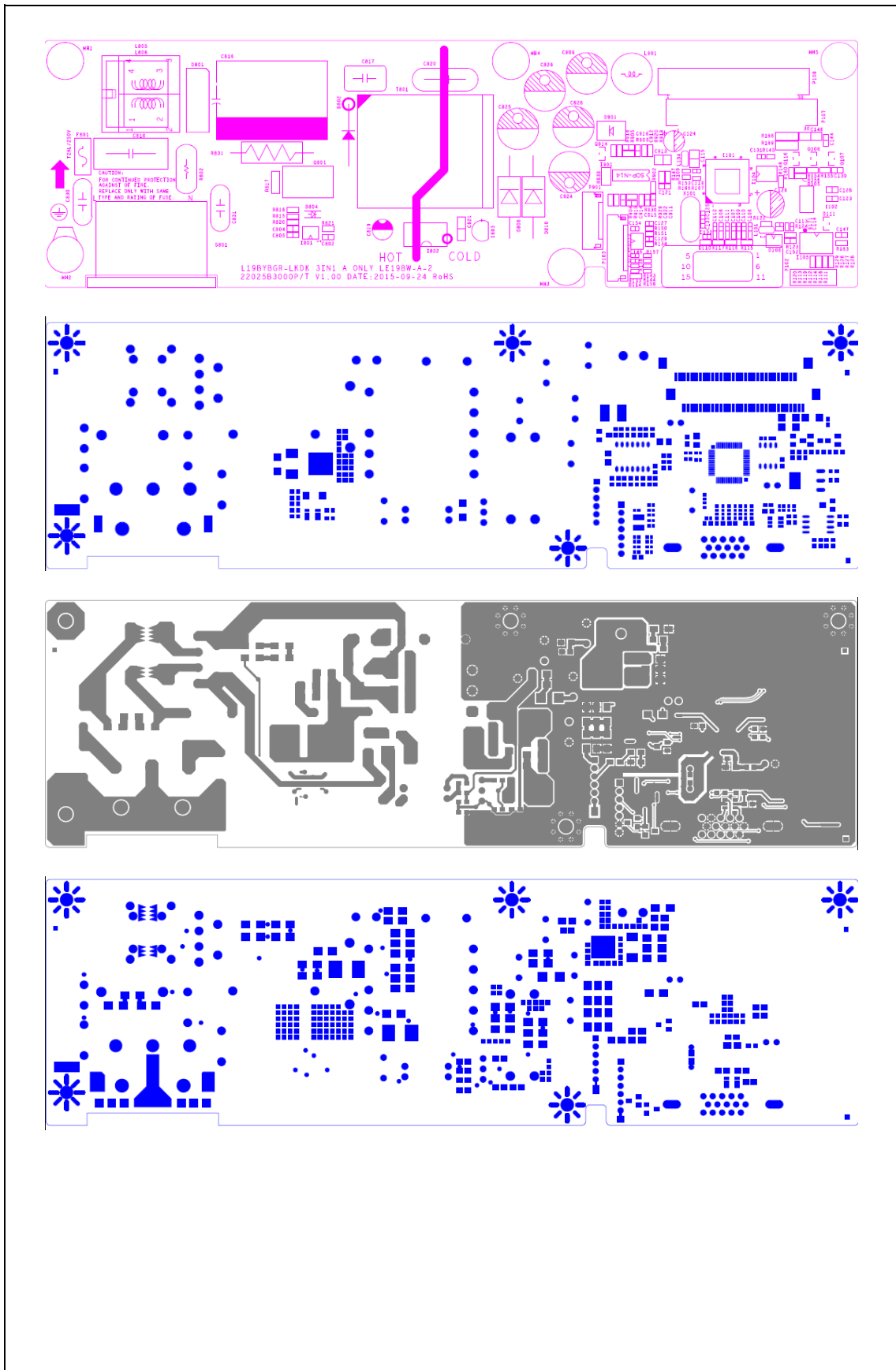



Photos

Report No. 296234







**Photos**

Report No. 296234





Photos

Report No. 296234

With PSU & main board P/N LE22BW-D-7 (DVI and VGA input)



With PSU & main board P/N LE19BW-A-2 (VGA input)





**Photos**

Report No. 296234





Photos

Report No. 296234

With PSU & main board P/N LE19BW-A-2 (VGA input)



With PSU & main board P/N LE22BW-D-7 (DVI and VGA input)





Photos

Report No. 296234

With PSU & main board P/N LE19BW-A-2 (VGA input)





Photos

Report No. 296234

With PSU & main board P/N LE19BW-A-2 (VGA input)



With PSU & main board P/N LE22BW-D-7 (DVI and VGA input)

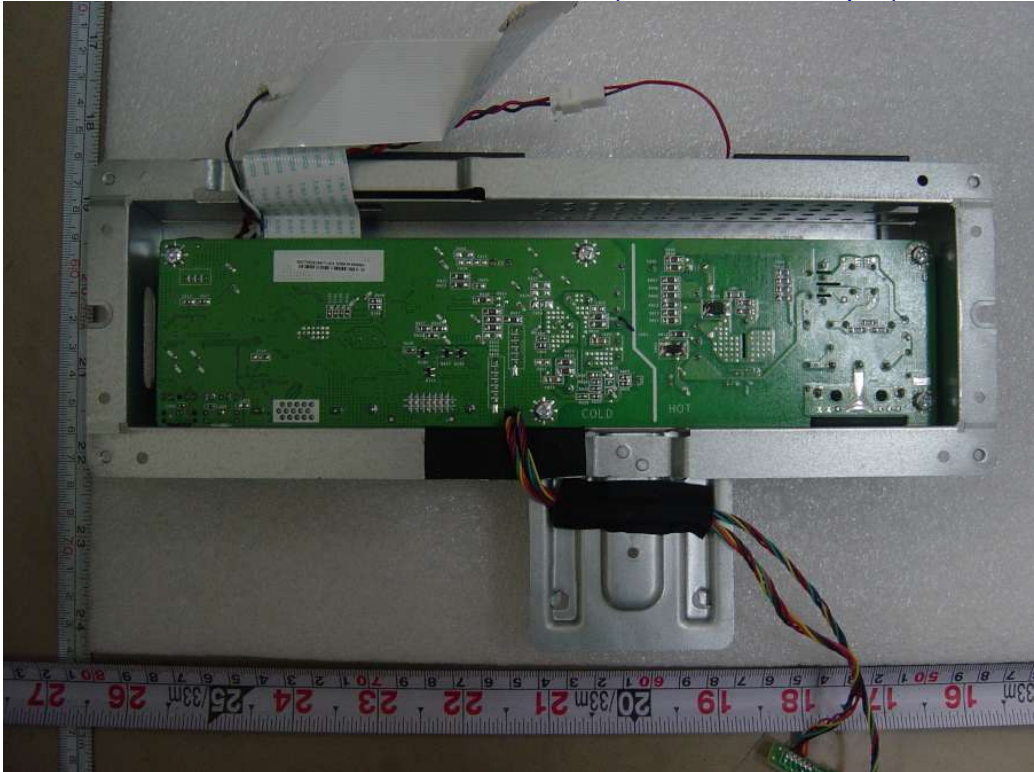



Photos

Report No. 296234

With PSU & main board P/N LE22BW-D-7 (DVI and VGA input)

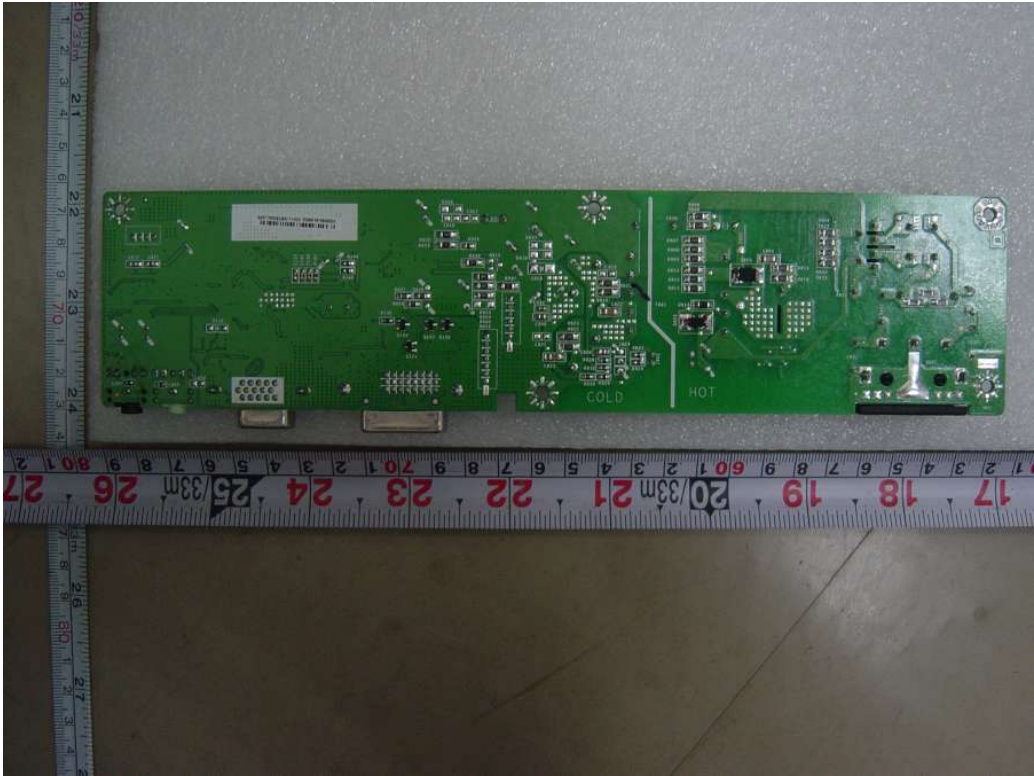
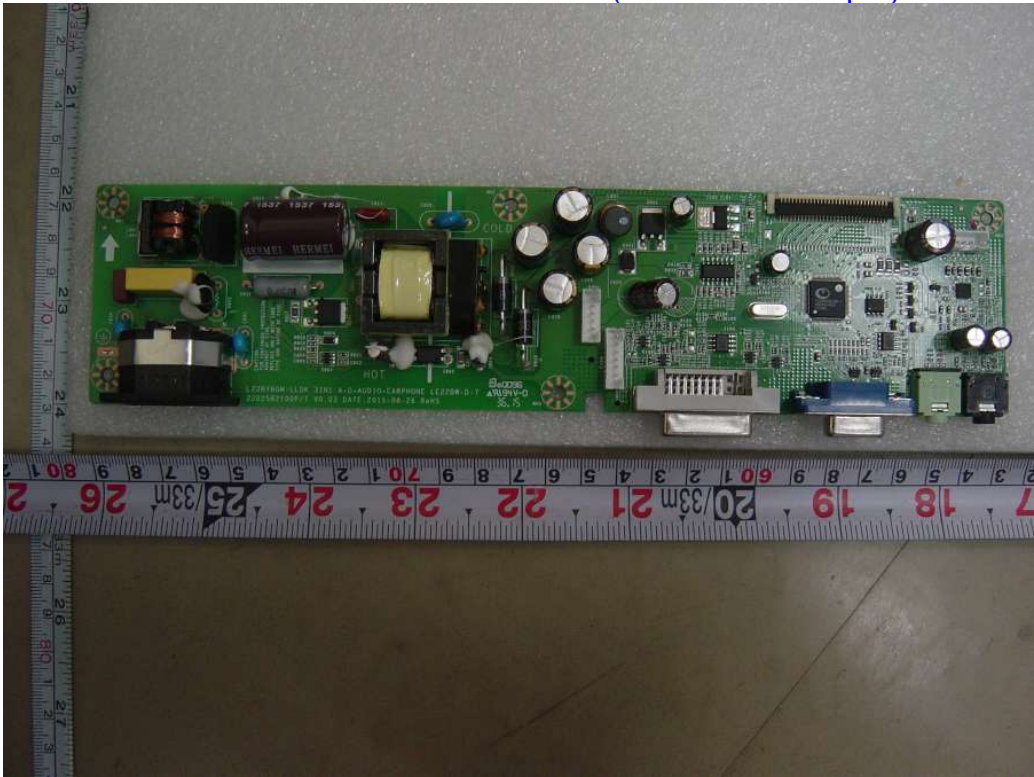



# Transformer specification

Report No. 296234

Construction / Winding diagram / Component part no: T801, LI TAI type 2374225120X-02

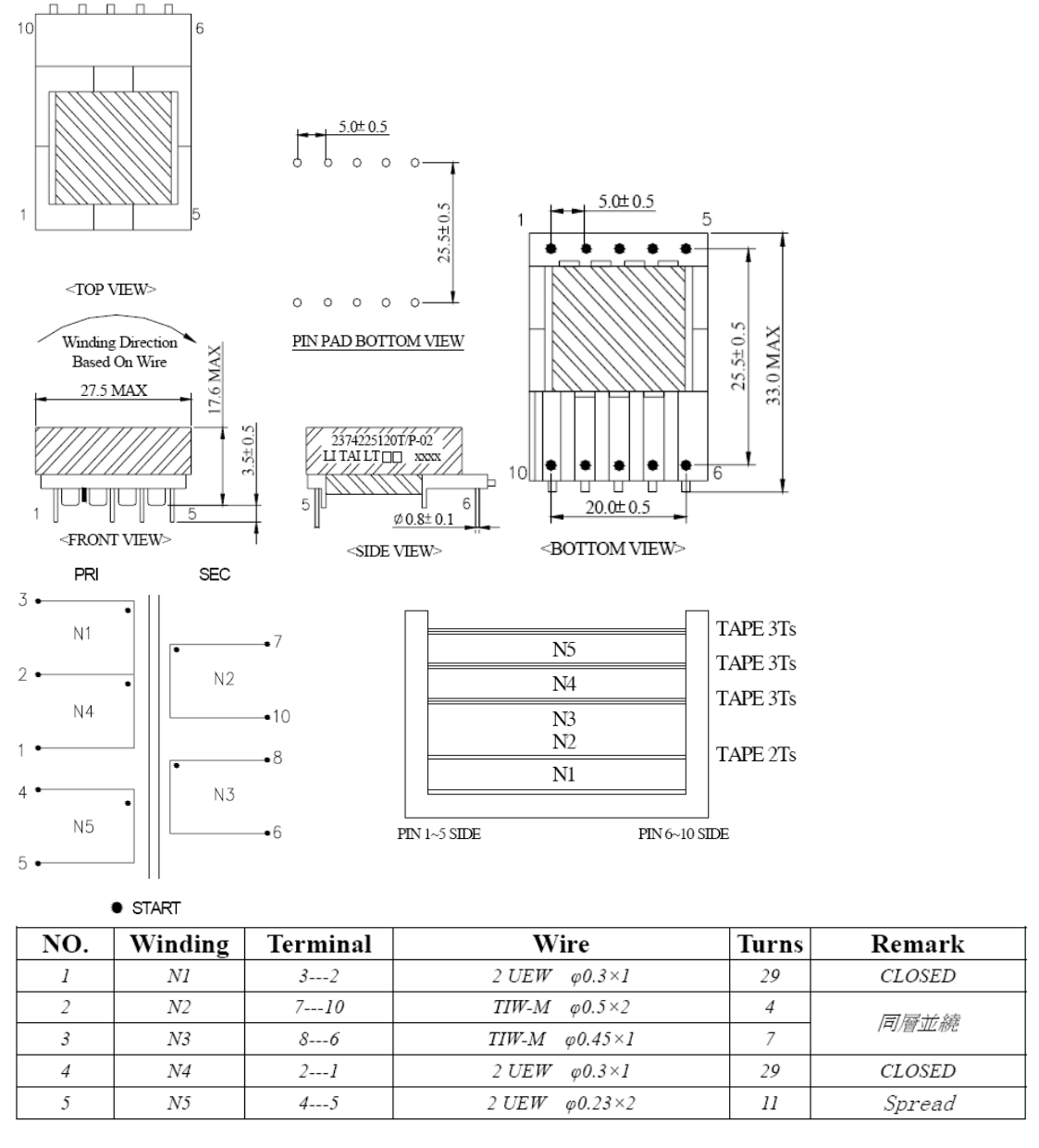





## Transformer specification

Report No. 296234

Construction / Winding diagram / Component part no: T801, LI TAI type 2374225120X-02

NO	SUB PART	RAW		MATERIAL		
		MANUFACTURER	DESCRIPTION	TYPE	FLAME/TEMP	UL NO.
1	CORE	A-CORE	FERRITE CORE EFD-25	JPP4	N/A	N/A
		TONG DA		TD4		
		TDG OR EQU		TP-4		
2	BOBBIN	CHANG CHUN PLASTICS CO.,LTD	PHENOLIC	T375J	94V-0 /150 °C	E59481
3	WIRE	PACIFIC ELECTRIC WIRE & CABLE CO.,LTD	BC-POLYURETHANE OVERCOAT- POLYAMIDE	UEWN/U (ANSI MW-28)	130 °C	E201757
4	TRIPLE WIRE	COSMOLINK CO.,LTD	TRIPLE INSULATED	TIW-M	130 °C	E213764
5	TAPE	3M COMPANY. (CTI GPOUP II) Dielectric breakdown 5kv THICKNESS 0.063mm	POLYESTER THICKNESS	NO. 1350F-1(b)	130 °C	E17385
		SYMBIO INC (CTI GPOUP II) Dielectric breakdown 5.5kv THICKNESS 0.055mm	POLYETHYLENE	NO.35660Y*d	130 °C	E50292
6	VARNISH	HITACHI CHEMICAL CO.,LTD	POLYESTER	WP-2952F-2G(Y)	130 °C	E72979



# Transformer specification

Report No. 296234

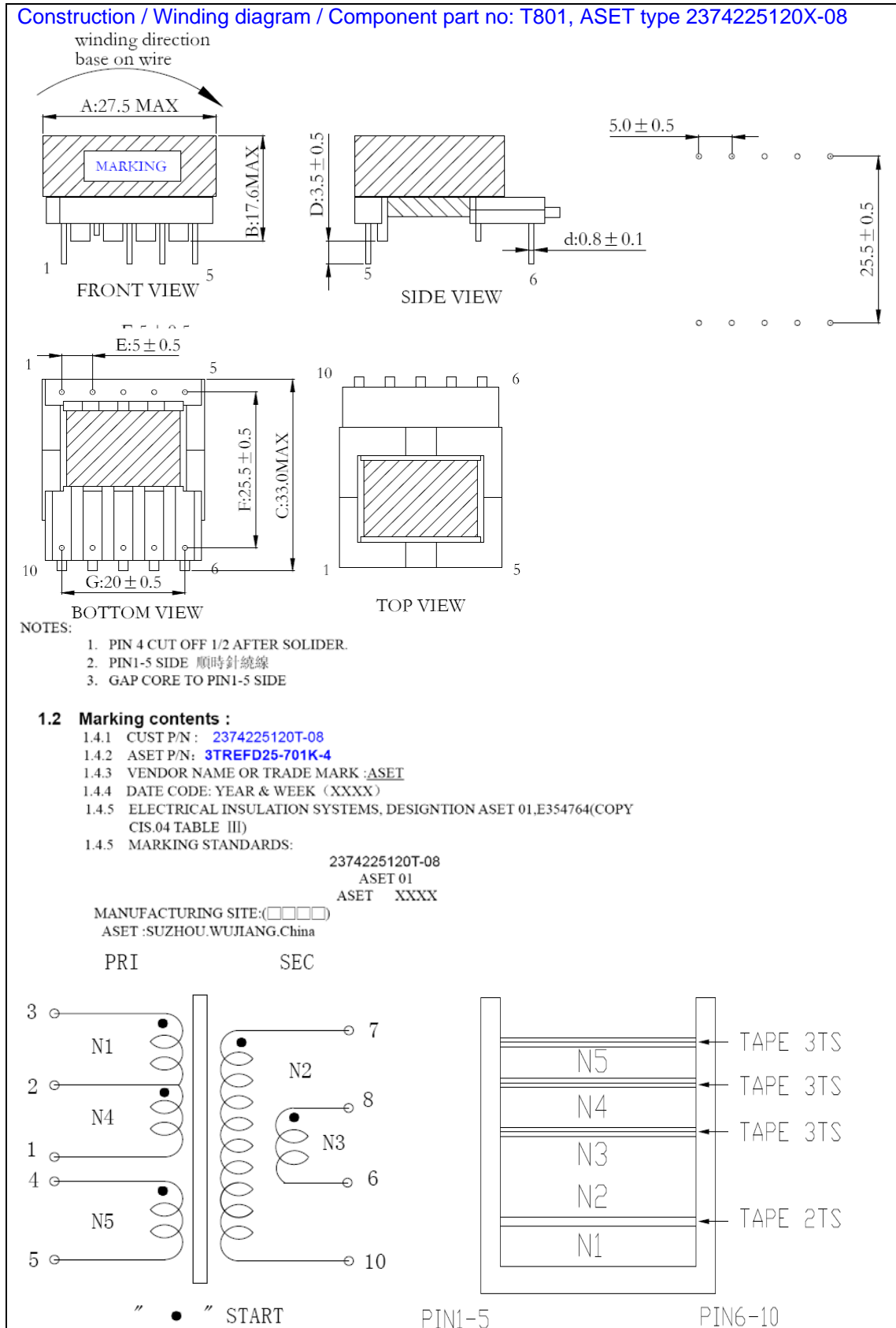



## Transformer specification

Report No. 296234

Construction / Winding diagram / Component part no: T801, ASET type 2374225120X-08

Winding	Terminal	Wire	Turns	Tape	Margin tape		Remark
					Pin1-5	Pin6-10	
N1	3--2	2 UEW $\phi 0.3 \times 1$	29	2TS	-	-	密绕
N2	7--10	TIW-M $\phi 0.5 \times 2$	4	3TS	-	-	同層并绕
N3	8--6	TIW-M $\phi 0.45 \times 1$	7		-	-	
N4	2--1	2 UEW $\phi 0.3 \times 1$	29	3TS	-	-	密绕
N5	4--5	2 UEW $\phi 0.23 \times 2$	11	3TS	-	-	散绕

NO	SUB PART	TYPE	UL FILE NO.	TMP	MANUFACTURER
1	CORE	EFD-25 DRM40	N/A	N/A	HENGDIAN GROUP DMEGC MAGNETICS CO.,LTD.
		EFD-25 PF-2	N/A	N/A	WORLD BEST MAGWAY MAGNETIC COMPONENTS CO.,LTD
2	WIRE	TYPV-130 (UEW/QA-B) $\phi 0.3\text{mm} \& \phi 0.23\text{mm}$	E245514	130°C	HENG YA ELECTRIC KUN SHAN LTD
3	Triple Insulated Wire	TIW-M $\phi 0.45 \text{ mm} \& \phi 0.5 \text{ mm}$	E213764 VDE 138053 TUV B07025261 7001	130°C	COSMOLINK CO.,LTD
4	BOBBIN	EFD25 PM-9820 94V-0	E41429	150°C	SUMITOMO BAKELITE CO LTD
5	TAPE	Cat. No. CT (c) CTI Group I (Dielectric breakdown $\geq 5.0\text{KV}$ ) THICKNES:0.06mm	E165111	130°C	JINGJIANG YAHUA PRESSURE SENSITIVE GLUE CO LTD
6	VARNISH	T-4260(a)	E228349	130°C	SUZHOU TAIHU ELECTRIC ADVANCED MATERIAL CO LTD
7	SOLDER	SHENGMAO (PF640) SOLDER	NA	NA	SHENGMAO TECHNOLOYG INC.
8	EPOXY	3300A-1/3300B-1	E218090	130°C	DONGGUAN EATTO ELECTRONIC MATERIAL CO LTD



## Transformer specification

Report No. 296234

Construction / Winding diagram / Component part no: T801, SUZHOU MANNILUN type 2374225120X-0C

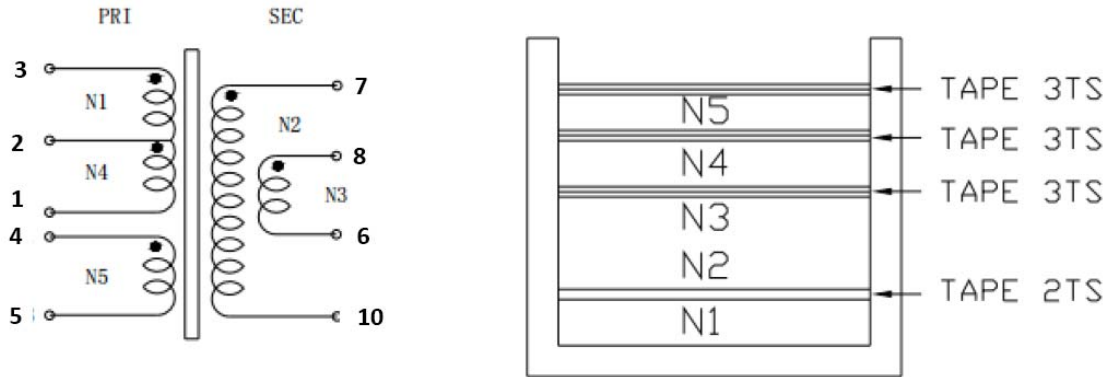

NO	WIRE SIZE	START	END	TURNS	INSULATING TAPE	Safety tape		NOTE
						PIN1-5	PIN6-10	
N1	0.3*1 2UEW	3	2	29	2TS	-	-	Closed
N2	0.5*2 TIW-M	7	10	4	3TS	-	-	Bifilar
N3	0.45*1 TIW-M	8	6	7		-	-	
N4	0.3*1 2UEW	2	1	29	3TS	-	-	Closed
N5	0.23*2 2UEW	4	5	11	3TS	-	-	Spread

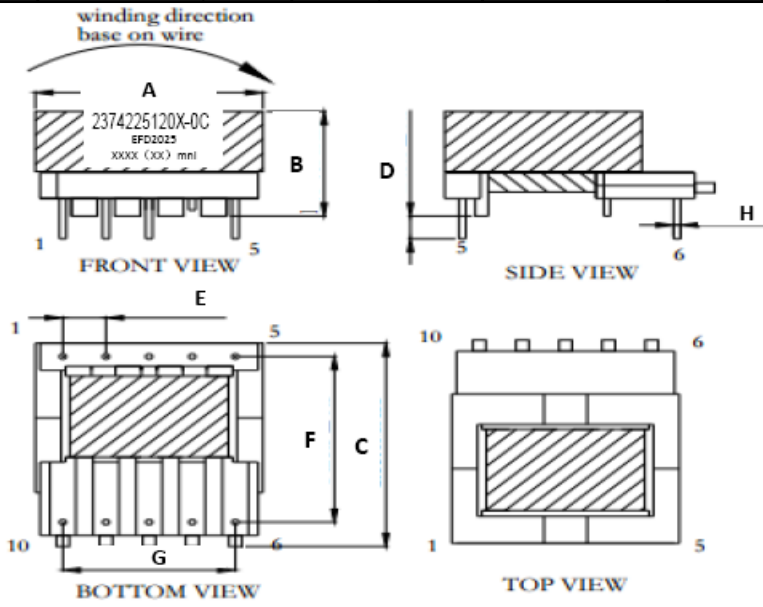

A	27.5 MAX
B	17.6 MAX
C	33.0MAX
D	3.5±0.5
E	5.0±0.5
F	25.5±0.5
G	20.0±0.5
H	0.8±0.1

UNIT: mm

- 备注:
- PIN7保留。在焊锡后，PIN4剪除1/2。
  - 研磨磁芯中柱加点软胶（E-8757B）。装在PIN1-5边。如图示：
  - 磁芯包胶布（T9.0mm）3TS。

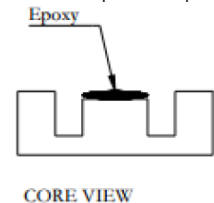



## Transformer specification

Report No. 296234

Construction / Winding diagram / Component part no: T801, SUZHOU MANNILUN type 2374225120X-0C

NO	ITEM	SIZE	MATERIAL	MANUFACTURER	UL FILE NO
1	CORE	EFD-25	PC40	浙江天通磁性材料有限公司	NA
			JF40	无锡斯贝尔磁性材料有限公司	NA
2	WIRE	2UEW	WIRE CU 2UEW MW-28 NAT (130°C)	SHANGHAI ASIA PACIFIC ELECTRIC CO, LTD	E214423
				NINGBO JINTIAN NEW MATERIAL CO, LTD	E227047
3	TRIPLE INSULATED WIRE	φ 0.5&0.45mm	TIW-M (130°C)	COSMOLINK CO LTD	E213764
4	BOBBIN	EFD-25	PM-9820 (150°C)	SUMITOMO BAKELITE CO LTD	E41429
5	VARNISH	EPOXY CLEAR	BC-346-A (155°C)	JOHN C DOLPH CO	E317427
6	SOLDER	SOLDER BAR SN99.7/CU0.3	NA	苏州市升贸焊锡制造有限公司	NA
7	TAPE	Cat. No. CT*(b) CTI Group I (Dielectric breakdown ≥5.0KV) THICKNES:0.06mm	CT*(b) (130°C)	JINGJIANG YAHUA PRESSURE SENSITIVE GLUE CO LTD	E165111

IEC60950_1F - ATTACHMENT			
Clause	Requirement + Test	Result - Remark	Verdict

**ATTACHMENT TO TEST REPORT IEC 60950-1  
EUROPEAN GROUP DIFFERENCES AND NATIONAL DIFFERENCES**

Information technology equipment – Safety –

Part 1: General requirements

**Differences according to**.....: EN 60950-1:2006/A11:2009/A1:2010/A12:2011/A2:2013

**Attachment Form No.**.....: EU\_GD\_IEC60950\_1F

**Attachment Originator** .....: SGS Fimko Ltd

**Master Attachment**.....: Date 2014-02

**Copyright © 2014 IEC System for Conformity Testing and Certification of Electrical Equipment (IECEE), Geneva, Switzerland. All rights reserved.**

**EN 60950-1:2006/A11:2009/A1:2010/A12:2011/A2:2013 – CENELEC COMMON MODIFICATIONS**

**IEC 60950-1, GROUP DIFFERENCES (CENELEC common modifications EN)**

Clause	Requirement + Test	Result - Remark	Verdict
	Clauses, subclauses, notes, tables and figures which are additional to those in IEC60950-1 and it's amendmets are prefixed "Z"		<b>P</b>
Contents  (A2:2013)	Add the following annexes: Annex ZA (normative) Normative references to international publications with their corresponding European publications Annex ZB (normative) Special national conditions Annex ZD (informative) IEC and CENELEC code designations for flexible cords		<b>P</b>
General	Delete all the "country" notes in the reference document (IEC 60950-1:2005) according to the following list: 1.4.8 Note 2 1.5.1 Note 2 & 3 1.5.7.1 Note 1.5.8 Note 2 1.5.9.4 Note 1.7.2.1 Note 4, 5 & 6 2.2.3 Note 2.2.4 Note 2.3.2 Note 2.3.2.1 Note 2 2.3.4 Note 2 2.6.3.3 Note 2 & 3 2.7.1 Note 2.10.3.2 Note 2 2.10.5.13 Note 3 3.2.1.1 Note 3.2.4 Note 3. 2.5.1 Note 2 4.3.6 Note 1 & 2 4.7 Note 4 4.7.2.2 Note 4.7.3.1 Note 2 5.1.7.1 Note 3 & 4 5.3.7 Note 1 6 Note 2 & 5 6.1.2.1 Note 2 6.1.2.2 Note 6.2.2 Note 6.2.2.1 Note 2 6.2.2.2 Note 7.1 Note 3 7.2 Note 7.3 Note 1 & 2 G.2.1 Note 2 Annex H Note 2		<b>P</b>
General (A1:2010)	Delete all the "country" notes in the reference document (IEC 60950-1:2005/A1:2010) according to the following list: 1.5.7.1 Note 6.1.2.1 Note 2 6.2.2.1 Note 2 EE.3 Note		<b>P</b>

IEC60950_1F - ATTACHMENT			
Clause	Requirement + Test	Result - Remark	Verdict
<b>IEC 60950-1, GROUP DIFFERENCES (CENELEC common modifications EN)</b>			
Clause	Requirement + Test	Result - Remark	Verdict
General (A2:2013)	Delete all the "country" notes in the reference document (IEC 60950-1:2005/A2:2013) according to the following list: 2.7.1 Note * 2.10.3.1 Note 2 6.2.2. Note * Note of secretary: Text of Common Modification remains unchanged.		<b>P</b>
1.1.1 (A1:2010)	<b>Replace</b> the text of NOTE 3 by the following. NOTE 3 The requirements of EN 60065 may also be used to meet safety requirements for multimedia equipment. See IEC Guide 112, Guide on the safety of multimedia equipment. For television sets EN 60065 applies.		<b>P</b>
1.3.Z1	Add the following subclause: 1.3.Z1 Exposure to excessive sound pressure The apparatus shall be so designed and constructed as to present no danger when used for its intended purpose, either in normal operating conditions or under fault conditions, particularly providing protection against exposure to excessive sound pressures from headphones or earphones. NOTE Z1 A new method of measurement is described in EN 50332-1, Sound system equipment: Headphones and earphones associated with portable audio equipment - Maximum sound pressure level measurement methodology and limit considerations - Part 1: General method for "one package equipment", and in EN 50332-2, Sound system equipment: Headphones and earphones associated with portable audio equipment - Maximum sound pressure level measurement methodology and limit considerations - Part 2: Guidelines to associate sets with headphones coming from different manufacturers.	No audio output.	<b>N/A</b>
(A12:2011)	In EN 60950-1:2006/A12:2011 Delete the addition of 1.3.Z1 / EN 60950-1:2006 Delete the definition 1.2.3.Z1 / EN 60950-1:2006 /A1:2010	Deleted.	<b>N/A</b>
1.5.1  (Added info*)	Add the following NOTE: NOTE Z1 The use of certain substances in electrical and electronic equipment is restricted within the EU: see Directive 2002/95/EC. New Directive 2011/65/11 *	Considered.	<b>P</b>
1.7.2.1 (A1:2010)	In addition, for a PORTABLE SOUND SYSTEM, the instructions shall include a warning that excessive sound pressure from earphones and headphones can cause hearing loss.	Not a portable sound system.	<b>N/A</b>
1.7.2.1 (A12:2011)	In EN 60950-1:2006/A12:2011 Delete NOTE Z1 and the addition for Portable Sound System. Add the following clause and annex to the existing standard and amendments.	Not a portable sound system.	<b>N/A</b>

IEC60950_1F - ATTACHMENT			
Clause	Requirement + Test	Result - Remark	Verdict

**IEC 60950-1, GROUP DIFFERENCES (CENELEC common modifications EN)**

Clause	Requirement + Test	Result - Remark	Verdict
--------	--------------------	-----------------	---------

	<b>Zx Protection against excessive sound pressure from personal music players</b>		<b>N/A</b>
--	---	--	------------

	<b>Zx.1 General</b>	Not a portable equipment.	<b>N/A</b>
--	---------------------	---------------------------	------------

This sub-clause specifies requirements for protection against excessive sound pressure from personal music players that are closely coupled to the ear. It also specifies requirements for earphones and headphones intended for use with personal music players.

A personal music player is a portable equipment for personal use, that:

- is designed to allow the user to listen to recorded or broadcast sound or video; and
- primarily uses headphones or earphones that can be worn in or on or around the ears; and
- allows the user to walk around while in use.

NOTE 1 Examples are hand-held or body-worn portable CD players, MP3 audio players, mobile phones with MP3 type features, PDA's or similar equipment.

A personal music player and earphones or headphones intended to be used with personal music players shall comply with the requirements of this sub-clause.

The requirements in this sub-clause are valid for music or video mode only.

The requirements do not apply:

- while the personal music player is connected to an external amplifier; or
- while the headphones or earphones are not used.

NOTE 2 An external amplifier is an amplifier which is not part of the personal music player or the listening device, but which is intended to play the music as a standalone music player.

The requirements do not apply to:

- hearing aid equipment and professional equipment;

NOTE 3 Professional equipment is equipment sold through special sales channels. All products sold through normal electronics stores are considered not to be professional equipment.



IEC60950_1F - ATTACHMENT			
Clause	Requirement + Test	Result - Remark	Verdict

IEC 60950-1, GROUP DIFFERENCES (CENELEC common modifications EN)			
Clause	Requirement + Test	Result - Remark	Verdict
	<p>– analogue personal music players (personal music players without any kind of digital processing of the sound signal) that are brought to the market before the end of 2015.</p> <p>NOTE 4 This exemption has been allowed because this technology is falling out of use and it is expected that within a few years it will no longer exist. This exemption will not be extended to other technologies.</p> <p>For equipment which is clearly designed or intended for use by young children, the limits of EN 71-1 apply.</p>		N/A
	<p><b>Zx.2 Equipment requirements</b></p> <p>No safety provision is required for equipment that complies with the following:</p> <ul style="list-style-type: none"> <li>– equipment provided as a package (personal music player with its listening device), where the acoustic output <math>L_{Aeq,T}</math> is <math>\leq 85</math> dBA measured while playing the fixed “programme simulation noise” as described in EN 50332-1; and</li> <li>– a personal music player provided with an analogue electrical output socket for a listening device, where the electrical output is <math>\leq 27</math> mV measured as described in EN 50332-2, while playing the fixed “programme simulation noise” as described in EN 50332-1.</li> </ul> <p>NOTE 1 Wherever the term acoustic output is used in this clause, the 30 s A-weighted equivalent sound pressure level <math>L_{Aeq,T}</math> is meant. See also Zx.5 and Annex Zx.</p> <p>All other equipment shall:</p> <ol style="list-style-type: none"> <li>a) protect the user from unintentional acoustic outputs exceeding those mentioned above; and</li> <li>b) have a standard acoustic output level not exceeding those mentioned above, and automatically return to an output level not exceeding those mentioned above when the power is switched off; and</li> </ol>	Not a portable equipment.	N/A

IEC60950_1F - ATTACHMENT			
Clause	Requirement + Test	Result - Remark	Verdict

IEC 60950-1, GROUP DIFFERENCES (CENELEC common modifications EN)			
Clause	Requirement + Test	Result - Remark	Verdict
	<p>c) provide a means to actively inform the user of the increased sound pressure when the equipment is operated with an acoustic output exceeding those mentioned above. Any means used shall be acknowledged by the user before activating a mode of operation which allows for an acoustic output exceeding those mentioned above. The acknowledgement does not need to be repeated more than once every 20 h of cumulative listening time; and</p> <p>NOTE 2 Examples of means include visual or audible signals. Action from the user is always required.</p> <p>NOTE 3 The 20 h listening time is the accumulative listening time, independent how often and how long the personal music player has been switched off.</p> <p>d) have a warning as specified in Zx.3; and</p> <p>e) not exceed the following:</p> <ol style="list-style-type: none"> <li>1) equipment provided as a package (player with its listening device), the acoustic output shall be <math>\leq 100</math> dBA measured while playing the fixed "programme simulation noise" described in EN 50332-1; and</li> <li>2) a personal music player provided with an analogue electrical output socket for a listening device, the electrical output shall be <math>\leq 150</math> mV measured as described in EN 50332-2, while playing the fixed "programme simulation noise" described in EN 50332-1.</li> </ol> <p>For music where the average sound pressure (long term <math>L_{Aeq,T}</math>) measured over the duration of the song is lower than the average produced by the programme simulation noise, the warning does not need to be given as long as the average sound pressure of the song is below the basic limit of 85 dBA. In this case T becomes the duration of the song.</p> <p>NOTE 4 Classical music typically has an average sound pressure (long term <math>L_{Aeq,T}</math>) which is much lower than the average programme simulation noise. Therefore, if the player is capable to analyse the song and compare it with the programme simulation noise, the warning does not need to be given as long as the average sound pressure of the song is below the basic limit of 85 dBA.</p> <p>For example, if the player is set with the programme simulation noise to 85 dBA, but the average music level of the song is only 65 dBA, there is no need to give a warning or ask an acknowledgement as long as the average sound level of the song is not above the basic limit of 85 dBA.</p>		N/A

IEC60950_1F - ATTACHMENT			
Clause	Requirement + Test	Result - Remark	Verdict
<b>IEC 60950-1, GROUP DIFFERENCES (CENELEC common modifications EN)</b>			
Clause	Requirement + Test	Result - Remark	Verdict
	<p><b>Zx.3 Warning</b></p> <p>The warning shall be placed on the equipment, or on the packaging, or in the instruction manual and shall consist of the following:</p> <ul style="list-style-type: none"> <li>– the symbol of Figure 1 with a minimum height of 5 mm; and</li> <li>– the following wording, or similar:</li> </ul> <p>“To prevent possible hearing damage, do not listen at high volume levels for long periods.”</p> <div style="text-align: center;">  </div> <p><b>Figure 1 – Warning label (IEC 60417-6044)</b></p> <p>Alternatively, the entire warning may be given through the equipment display during use, when the user is asked to acknowledge activation of the higher level.</p>	Not a portable sound system.	<b>N/A</b>
	<b>Zx.4 Requirements for listening devices (headphones and earphones)</b>		<b>N/A</b>
	<p><b>Zx.4.1 Wired listening devices with analogue input</b></p> <p>With 94 dBA sound pressure output <math>L_{Aeq,T}</math>, the input voltage of the fixed “programme simulation noise” described in EN 50332-2 shall be <math>\geq 75</math> mV.</p> <p>This requirement is applicable in any mode where the headphones can operate (active or passive), including any available setting (for example built-in volume level control).</p> <p>NOTE The values of 94 dBA – 75 mV correspond with 85dBA – 27 mV and 100 dBA – 150 mV.</p>	Not a portable sound system.	<b>N/A</b>

IEC60950_1F - ATTACHMENT			
Clause	Requirement + Test	Result - Remark	Verdict
<b>IEC 60950-1, GROUP DIFFERENCES (CENELEC common modifications EN)</b>			
Clause	Requirement + Test	Result - Remark	Verdict
	<p><b>Zx.4.2 Wired listening devices with digital input</b>            With any playing device playing the fixed “programme simulation noise” described in EN 50332-1 (and respecting the digital interface standards, where a digital interface standard exists that specifies the equivalent acoustic level), the acoustic output <math>L_{Aeq,T}</math> of the listening device shall be <math>\leq 100</math> dBA.</p> <p>This requirement is applicable in any mode where the headphones can operate, including any available setting (for example built-in volume level control, additional sound feature like equalization, etc.).</p> <p>NOTE An example of a wired listening device with digital input is a USB headphone.</p>	Not a portable sound system.	N/A
	<p><b>Zx.4.3 Wireless listening devices</b>            In wireless mode:</p> <ul style="list-style-type: none"> <li>– with any playing and transmitting device playing the fixed programme simulation noise described in EN 50332-1; and</li> <li>– respecting the wireless transmission standards, where an air interface standard exists that specifies the equivalent acoustic level; and</li> <li>– with volume and sound settings in the listening device (for example built-in volume level control, additional sound feature like equalization, etc.) set to the combination of positions that maximize the measured acoustic output for the abovementioned programme simulation noise, the acoustic output <math>L_{Aeq,T}</math> of the listening device shall be <math>\leq 100</math> dBA.</li> </ul> <p>NOTE An example of a wireless listening device is a Bluetooth headphone.</p>	Not a portable sound system.	N/A
	<p><b>Zx.5 Measurement methods</b>            Measurements shall be made in accordance with EN 50332-1 or EN 50332-2 as applicable. Unless stated otherwise, the time interval T shall be 30 s.</p> <p>NOTE Test method for wireless equipment provided without listening device should be defined.</p>	Not a portable sound system.	N/A

IEC60950_1F - ATTACHMENT			
Clause	Requirement + Test	Result - Remark	Verdict

IEC 60950-1, GROUP DIFFERENCES (CENELEC common modifications EN)			
Clause	Requirement + Test	Result - Remark	Verdict
2.7.1	<p>Replace the subclause as follows:</p> <p>Basic requirements</p> <p>To protect against excessive current, short-circuits and earth faults in PRIMARY CIRCUITS, protective devices shall be included either as integral parts of the equipment or as parts of the building installation, subject to the following, a), b) and c):</p> <p>a) except as detailed in b) and c), protective devices necessary to comply with the requirements of 5.3 shall be included as parts of the equipment;</p> <p>b) for components in series with the mains input to the equipment such as the supply cord, appliance coupler, r.f.i. filter and switch, short-circuit and earth fault protection may be provided by protective devices in the building installation;</p> <p>c) it is permitted for PLUGGABLE EQUIPMENT TYPE B or PERMANENTLY CONNECTED EQUIPMENT, to rely on dedicated overcurrent and short-circuit protection in the building installation, provided that the means of protection, e.g. fuses or circuit breakers, is fully specified in the installation instructions.</p> <p>If reliance is placed on protection in the building installation, the installation instructions shall so state, except that for PLUGGABLE EQUIPMENT TYPE A the building installation shall be regarded as providing protection in accordance with the rating of the wall socket outlet.</p>	<p>The equipment is provided with the fuse and complied with a).</p> <p>For the appliance inlet and the cord set, protection is dependent on the building installation, see main test report.</p>	<b>P</b>
2.7.2	This subclause has been declared 'void'.	Considered.	<b>P</b>
3.2.3	Delete the NOTE in Table 3A, and delete also in this table the conduit sizes in parentheses.	The equipment is not intended for permanent connection to the mains.	<b>N/A</b>

IEC60950_1F - ATTACHMENT									
Clause	Requirement + Test	Result - Remark	Verdict						
<b>IEC 60950-1, GROUP DIFFERENCES (CENELEC common modifications EN)</b>									
Clause	Requirement + Test	Result - Remark	Verdict						
3.2.5.1	<p>Replace “60245 IEC 53” by “H05 RR-F”;  “60227 IEC 52” by “H03 VV-F or H03 VVH2-F”;  “60227 IEC 53” by “H05 VV-F or H05 VVH2-F2”.</p> <p>In Table 3B, replace the first four lines by the following:</p> <table style="margin-left: 20px;"> <tr> <td>Up to and including 6  </td> <td>0,75<sup>a)</sup>  </td> </tr> <tr> <td>Over 6 up to and including 10  </td> <td>(0,75)<sup>b)</sup> 1,0  </td> </tr> <tr> <td>Over 10 up to and including 16  </td> <td>(1,0)<sup>c)</sup> 1,5  </td> </tr> </table> <p>In the conditions applicable to Table 3B delete the words “in some countries” in condition<sup>a)</sup>.</p> <p>In NOTE 1, applicable to Table 3B, delete the second sentence.</p>	Up to and including 6	0,75 <sup>a)</sup>	Over 6 up to and including 10	(0,75) <sup>b)</sup> 1,0	Over 10 up to and including 16	(1,0) <sup>c)</sup> 1,5	Refer to Summary of Testing in main test report.	N/A
Up to and including 6	0,75 <sup>a)</sup>								
Over 6 up to and including 10	(0,75) <sup>b)</sup> 1,0								
Over 10 up to and including 16	(1,0) <sup>c)</sup> 1,5								
3.2.5.1 (A2:2013)	NOTE Z1 The harmonised code designations corresponding to the IEC cord types are given in Annex ZD		N/A						
3.3.4	<p>In Table 3D, delete the fourth line: conductor sizes for 10 to 13 A, and replace with the following:</p> <table style="margin-left: 20px;"> <tr> <td>Over 10 up to and including 16  </td> <td>1,5 to 2,5  </td> <td>1,5 to 4  </td> </tr> </table> <p>Delete the fifth line: conductor sizes for 13 to 16 A</p>	Over 10 up to and including 16	1,5 to 2,5	1,5 to 4	Refer to Summary of Testing in main test report.	N/A			
Over 10 up to and including 16	1,5 to 2,5	1,5 to 4							
4.3.13.6 (A1:2010)	<p>Replace the existing NOTE by the following:</p> <p>NOTE Z1 Attention is drawn to:</p> <p>1999/519/EC: Council Recommendation on the limitation of exposure of the general public to electromagnetic fields 0 Hz to 300 GHz, and</p> <p>2006/25/EC: Directive on the minimum health and safety requirements regarding the exposure of workers to risks arising from physical agents (artificial optical radiation).</p>	Not applicable.	N/A						
	Standards taking into account mentioned Recommendation and Directive which demonstrate compliance with the applicable EU Directive are indicated in the OJEC.	Not applicable.	N/A						
Annex H	<p>Replace the last paragraph of this annex by:</p> <p>At any point 10 cm from the surface of the OPERATOR ACCESS AREA, the dose rate shall not exceed 1 µSv/h (0,1 mR/h) (see NOTE). Account is taken of the background level.</p> <p>Replace the notes as follows:</p> <p>NOTE These values appear in Directive 96/29/Euratom. Delete NOTE 2.</p>	The unit does not emit X-ray radiation.	N/A						
Bibliography	Additional EN standards.		—						

IEC60950_1F - ATTACHMENT			
Clause	Requirement + Test	Result - Remark	Verdict

IEC 60950-1, GROUP DIFFERENCES (CENELEC common modifications EN)			
Clause	Requirement + Test	Result - Remark	Verdict
<b>ZA</b>	<b>NORMATIVE REFERENCES TO INTERNATIONAL PUBLICATIONS WITH THEIR CORRESPONDING EUROPEAN PUBLICATIONS</b>		—

ZB ANNEX (normative) SPECIAL NATIONAL CONDITIONS (EN)			
Clause	Requirement + Test	Result - Remark	Verdict
1.2.4.1	In <b>Denmark</b> , certain types of Class I appliances (see 3.2.1.1) may be provided with a plug not establishing earthing conditions when inserted into Danish socket-outlets.	Refer to Summary of Testing in main test report.	<b>N/A</b>
1.2.13.14 (A11:2009)	In <b>Norway</b> and <b>Sweden</b> , for requirements see 1.7.2.1 and 7.3 of this annex.	Not connected to cable distribution system.	<b>N/A</b>
1.5.7.1 (A11:2009)	In <b>Finland, Norway</b> and <b>Sweden</b> , resistors bridging BASIC INSULATION in CLASS I PLUGGABLE EQUIPMENT TYPE A must comply with the requirements in 1.5.7.1. In addition when a single resistor is used, the resistor must withstand the resistor test in 1.5.7.2.	No such parts.	<b>N/A</b>
1.5.8	In <b>Norway</b> , due to the IT power system used (see annex V, Figure V.7), capacitors are required to be rated for the applicable line-to-line voltage (230 V).	Considered	<b>P</b>
1.5.9.4	In <b>Finland, Norway</b> and <b>Sweden</b> , the third dashed sentence is applicable only to equipment as defined in 6.1.2.2 of this annex.	Not applicable.	<b>N/A</b>
1.7.2.1	In <b>Finland, Norway</b> and <b>Sweden</b> , CLASS I PLUGGABLE EQUIPMENT TYPE A intended for connection to other equipment or a network shall, if safety relies on connection to protective earth or if surge suppressors are connected between the network terminals and accessible parts, have a marking stating that the equipment must be connected to an earthed mains socket-outlet. The marking text in the applicable countries shall be as follows: In <b>Finland</b> : "Laite on liitettävä suojakoskettimilla varustettuun pistorasiaan" In <b>Norway</b> : "Apparatet må tilkoples jordet stikkontakt" In <b>Sweden</b> : "Apparaten skall anslutas till jordat uttag"	FI, N and S required marking for an unit that must be connected to protective earth only. The text is required because safety relies on connection to protective earth. The Norwegian, Swedish, and Finnish texts are not provided on the marking plate, therefore, must be considered when enter Finland, Norway and Sweden market.	—

IEC60950_1F - ATTACHMENT			
Clause	Requirement + Test	Result - Remark	Verdict

<b>ZB ANNEX (normative)</b> <b>SPECIAL NATIONAL CONDITIONS (EN)</b>			
Clause	Requirement + Test	Result - Remark	Verdict
1.7.2.1 (A11:2009)	<p>In <b>Norway</b> and <b>Sweden</b>, the screen of the cable distribution system is normally not earthed at the entrance of the building and there is normally no equipotential bonding system within the building. Therefore the protective earthing of the building installation need to be isolated from the screen of a cable distribution system.</p> <p>It is however accepted to provide the insulation external to the equipment by an adapter or an interconnection cable with galvanic isolator, which may be provided by e.g. a retailer.</p> <p>The user manual shall then have the following or similar information in Norwegian and Swedish language respectively, depending on in what country the equipment is intended to be used in:</p> <p>“Equipment connected to the protective earthing of the building installation through the mains connection or through other equipment with a connection to protective earthing – and to a cable distribution system using coaxial cable, may in some circumstances create a fire hazard. Connection to a cable distribution system has therefore to be provided through a device providing electrical isolation below a certain frequency range (galvanic isolator, see EN 60728-11).” NOTE In Norway, due to regulation for installations of cable distribution systems, and in Sweden, a galvanic isolator shall provide electrical insulation below 5 MHz. The insulation shall withstand a dielectric strength of 1,5 kV r.m.s., 50 Hz or 60 Hz, for 1 min.</p> <p>Translation to Norwegian (the Swedish text will also be accepted in Norway):</p> <p>“Utstyr som er koplet til beskyttelsesjord via nettplugg og/eller via annet jordtilkoplet utstyr – og er tilkoplet et kabel-TV nett, kan forårsake brannfare. For å unngå dette skal det ved tilkopling av utstyret til kabel-TV nettet installeres en galvanisk isolator mellom utstyret og kabel-TV nettet.”</p> <p>Translation to Swedish:</p> <p>”Utrustning som är kopplad till skyddsjord via jordat vägguttag och/eller via annan utrustning och samtidigt är kopplad till kabel-TV nät kan i vissa fall medföra risk för brand. För att undvika detta skall vid anslutning av utrustningen till kabel-TV nät galvanisk isolator finnas mellan utrustningen och kabel-TV nätet.”</p>	Not connected to a cable distribution system.	N/A



IEC60950_1F - ATTACHMENT			
Clause	Requirement + Test	Result - Remark	Verdict
<b>ZB ANNEX (normative) SPECIAL NATIONAL CONDITIONS (EN)</b>			
Clause	Requirement + Test	Result - Remark	Verdict
1.7.2.1 (A2:2013)	In <b>Denmark</b> , CLASS I PLUGGABLE EQUIPMENT TYPE A intended for connection to other equipment or a network shall, if safety relies on connection to protective earth or if surge suppressors are connected between the network terminals and accessible parts, have a marking stating that the equipment must be connected to an earthed mains socket-outlet.  The marking text in <b>Denmark</b> shall be as follows: In <b>Denmark</b> : "Apparatets stikprop skal tilsluttes en stikkontakt med jord, som giver forbindelse til stikproppens jord."	The Danish text is not provided on the marking plate, therefore, must be considered when enter Denmark market.	—
1.7.5  1.7.5 (A11:2009)	In <b>Denmark</b> , socket-outlets for providing power to other equipment shall be in accordance with the Heavy Current Regulations, Section 107-2-D1, Standard Sheet DK 1-3a, DK 1-5a or DK 1-7a, when used on Class I equipment. For STATIONARY EQUIPMENT the socket-outlet shall be in accordance with Standard Sheet DK 1-1b or DK 1-5a.  For <b>CLASS II EQUIPMENT</b> the socket outlet shall be in accordance with Standard Sheet DKA 1-4a.	No socket-outlets provided.	<b>N/A</b>
1.7.5 (A2:2013)	In <b>Denmark</b> , socket-outlets for providing power to other equipment shall be in accordance with the DS 60884-2-D1:2011.  For class I equipment the following Standard Sheets are applicable: DK 1-3a, DK 1-1c, DK 1-1d, DK 1-5a or DK 1-7a, with the exception for STATIONARY EQUIPMENT where the socket-outlets shall be in accordance with Standard Sheet DK 1-1b, DK 1-1c, DK 1-1d or DK 1-5a.  Socket outlets intended for providing power to Class II apparatus with a rated current of 2,5 A shall be in accordance with DS 60884-2-D1 standard sheet DKA 1-4a. Other current rating socket outlets shall be in compliance with by DS 60884-2-D1 Standard Sheet DKA 1-3a or DKA 1-3b.  Justification the Heavy Current Regulations, 6c	No socket-outlets provided.	<b>N/A</b>
2.2.4	In <b>Norway</b> , for requirements see 1.7.2.1, 6.1.2.1 and 6.1.2.2 of this annex.	No TNV circuits.	<b>N/A</b>
2.3.2	In <b>Finland, Norway and Sweden</b> there are additional requirements for the insulation. See 6.1.2.1 and 6.1.2.2 of this annex.	No TNV circuits.	<b>N/A</b>

IEC60950_1F - ATTACHMENT			
Clause	Requirement + Test	Result - Remark	Verdict
<b>ZB ANNEX (normative) SPECIAL NATIONAL CONDITIONS (EN)</b>			
Clause	Requirement + Test	Result - Remark	Verdict
2.3.4	In <b>Norway</b> , for requirements see 1.7.2.1, 6.1.2.1 and 6.1.2.2 of this annex.	No TNV circuits.	<b>N/A</b>
2.6.3.3	In the <b>United Kingdom</b> , the current rating of the circuit shall be taken as 13 A, not 16 A.	Considered.	<b>P</b>
2.7.1	In the <b>United Kingdom</b> , to protect against excessive currents and short-circuits in the PRIMARY CIRCUIT of DIRECT PLUG-IN EQUIPMENT, tests according to 5.3 shall be conducted, using an external protective device rated 30 A or 32 A. If these tests fail, suitable protective devices shall be included as integral parts of the DIRECT PLUG-IN EQUIPMENT, so that the requirements of 5.3 are met.	Not Direct Plug-In equipment.	<b>N/A</b>
2.10.5.13	In <b>Finland, Norway and Sweden</b> , there are additional requirements for the insulation, see 6.1.2.1 and 6.1.2.2 of this annex.	No TNV circuits.	<b>N/A</b>
3.2.1.1	<p>In <b>Switzerland</b>, supply cords of equipment having a RATED CURRENT not exceeding 10 A shall be provided with a plug complying with SEV 1011 or IEC 60884-1 and one of the following dimension sheets:</p> <p>SEV 6532-2.1991 Plug Type 15 3P+N+PE 250/400 V, 10 A</p> <p>SEV 6533-2.1991 Plug Type 11 L+N 250 V, 10 A</p> <p>SEV 6534-2.1991 Plug Type 12 L+N+PE 250 V, 10 A</p> <p>In general, EN 60309 applies for plugs for currents exceeding 10 A. However, a 16 A plug and socket-outlet system is being introduced in Switzerland, the plugs of which are according to the following dimension sheets, published in February 1998:</p> <p>SEV 5932-2.1998: Plug Type 25 , 3L+N+PE 230/400 V, 16 A</p> <p>SEV 5933-2.1998: Plug Type 21, L+N, 250 V, 16A</p> <p>SEV 5934-2.1998: Plug Type 23, L+N+PE 250 V, 16 A</p>	Refer to Summary of Testing in main test report.	<b>N/A</b>

IEC60950_1F - ATTACHMENT			
Clause	Requirement + Test	Result - Remark	Verdict

<b>ZB ANNEX (normative)</b> <b>SPECIAL NATIONAL CONDITIONS (EN)</b>			
Clause	Requirement + Test	Result - Remark	Verdict
3.2.1.1	<p>In <b>Denmark</b>, supply cords of single-phase equipment having a rated current not exceeding 13 A shall be provided with a plug according to the Heavy Current Regulations, Section 107-2-D1.</p> <p>CLASS I EQUIPMENT provided with socket-outlets with earth contacts or which are intended to be used in locations where protection against indirect contact is required according to the wiring rules shall be provided with a plug in accordance with standard sheet DK 2-1a or DK 2-5a.</p> <p>If poly-phase equipment and single-phase equipment having a RATED CURRENT exceeding 13 A is provided with a supply cord with a plug, this plug shall be in accordance with the Heavy Current Regulations, Section 107-2-D1 or EN 60309-2.</p>	Refer to Summary of Testing in main test report.	<b>N/A</b>
3.2.1.1 (A2:2013)	<p>In <b>Denmark</b>, supply cords of single-phase equipment having a rated current not exceeding 13 A shall be provided with a plug according to DS 60884-2-D1.</p> <p>CLASS I EQUIPMENT provided with socket-outlets with earth contacts or which are intended to be used in locations where protection against indirect contact is required according to the wiring rules shall be provided with a plug in accordance with standard sheet DK 2-1a or DK 2-5a.</p> <p>If a single-phase equipment having a RATED CURRENT exceeding 13 A or if a poly-phase equipment is provided with a supply cord with a plug, this plug shall be in accordance with the standard sheets DK 6-1a in DS 60884-2-D1 or EN 60309-2.</p> <p>Justification the Heavy Current Regulations, 6c</p>	Refer to Summary of Testing in main test report.	<b>N/A</b>

IEC60950_1F - ATTACHMENT			
Clause	Requirement + Test	Result - Remark	Verdict
<b>ZB ANNEX (normative) SPECIAL NATIONAL CONDITIONS (EN)</b>			
Clause	Requirement + Test	Result - Remark	Verdict
3.2.1.1	<p>In <b>Spain</b>, supply cords of single-phase equipment having a rated current not exceeding 10 A shall be provided with a plug according to UNE 20315:1994.</p> <p>Supply cords of single-phase equipment having a rated current not exceeding 2,5 A shall be provided with a plug according to UNE-EN 50075:1993.</p> <p>CLASS I EQUIPMENT provided with socket-outlets with earth contacts or which are intended to be used in locations where protection against indirect contact is required according to the wiring rules, shall be provided with a plug in accordance with standard UNE 20315:1994.</p> <p>If poly-phase equipment is provided with a supply cord with a plug, this plug shall be in accordance with UNE-EN 60309-2.</p>	Refer to Summary of Testing in main test report.	N/A
3.2.1.1	<p>In the <b>United Kingdom</b>, apparatus which is fitted with a flexible cable or cord and is designed to be connected to a mains socket conforming to BS 1363 by means of that flexible cable or cord and plug, shall be fitted with a 'standard plug' in accordance with Statutory Instrument 1768:1994 - The Plugs and Sockets etc. (Safety) Regulations 1994, unless exempted by those regulations.</p> <p>NOTE 'Standard plug' is defined in SI 1768:1994 and essentially means an approved plug conforming to BS 1363 or an approved conversion plug.</p>	Refer to Summary of Testing in main test report.	N/A
3.2.1.1	<p>In <b>Ireland</b>, apparatus which is fitted with a flexible cable or cord and is designed to be connected to a mains socket conforming to I.S. 411 by means of that flexible cable or cord and plug, shall be fitted with a 13 A plug in accordance with Statutory Instrument 525:1997 - National Standards Authority of Ireland (section 28) (13 A Plugs and Conversion Adaptors for Domestic Use) Regulations 1997.</p>	Refer to Summary of Testing in main test report.	N/A
3.2.4	<p>In <b>Switzerland</b>, for requirements see 3.2.1.1 of this annex.</p>	Refer to Summary of Testing in main test report.	N/A
3.2.5.1	<p>In the <b>United Kingdom</b>, a power supply cord with conductor of 1,25 mm<sup>2</sup> is allowed for equipment with a rated current over 10 A and up to and including 13 A.</p>	Refer to Summary of Testing in main test report.	N/A

IEC60950_1F - ATTACHMENT			
Clause	Requirement + Test	Result - Remark	Verdict
<b>ZB ANNEX (normative) SPECIAL NATIONAL CONDITIONS (EN)</b>			
Clause	Requirement + Test	Result - Remark	Verdict
3.3.4	In the <b>United Kingdom</b> , the range of conductor sizes of flexible cords to be accepted by terminals for equipment with a RATED CURRENT of over 10 A up to and including 13 A is: • 1,25 mm <sup>2</sup> to 1,5 mm <sup>2</sup> nominal cross-sectional area.	Refer to Summary of Testing in main test report.	<b>N/A</b>
4.3.6	In the <b>United Kingdom</b> , the torque test is performed using a socket outlet complying with BS 1363 part 1:1995, including Amendment 1:1997 and Amendment 2:2003 and the plug part of DIRECT PLUG-IN EQUIPMENT shall be assessed to BS 1363: Part 1, 12.1, 12.2, 12.3, 12.9, 12.11, 12.12, 12.13, 12.16 and 12.17, except that the test of 12.17 is performed at not less than 125 °C. Where the metal earth pin is replaced by an Insulated Shutter Opening Device (ISOD), the requirements of clauses 22.2 and 23 also apply.	Not Direct plug-In equipment.	<b>N/A</b>
4.3.6	In <b>Ireland</b> , DIRECT PLUG-IN EQUIPMENT is known as plug similar devices. Such devices shall comply with Statutory Instrument 526:1997 - National Standards Authority of Ireland (Section 28) (Electrical plugs, plug similar devices and sockets for domestic use) Regulations, 1997.	Not Direct plug-In equipment.	<b>N/A</b>
5.1.7.1	In <b>Finland, Norway and Sweden</b> TOUCH CURRENT measurement results exceeding 3,5 mA r.m.s. are permitted only for the following equipment: • STATIONARY PLUGGABLE EQUIPMENT TYPE A that is intended to be used in a RESTRICTED ACCESS LOCATION where equipotential bonding has been applied, for example, in a telecommunication centre; and has provision for a permanently connected PROTECTIVE EARTHING CONDUCTOR; and is provided with instructions for the installation of that conductor by a SERVICE PERSON; • STATIONARY PLUGGABLE EQUIPMENT TYPE B; • STATIONARY PERMANENTLY CONNECTED EQUIPMENT.	Not applicable.	<b>N/A</b>

IEC60950_1F - ATTACHMENT			
Clause	Requirement + Test	Result - Remark	Verdict

ZB ANNEX (normative) SPECIAL NATIONAL CONDITIONS (EN)			
Clause	Requirement + Test	Result - Remark	Verdict
6.1.2.1 (A1:2010)	<p>In <b>Finland, Norway</b> and <b>Sweden</b>, add the following text between the first and second paragraph of the compliance clause:</p> <p>If this insulation is solid, including insulation forming part of a component, it shall at least consist of either</p> <ul style="list-style-type: none"> <li>- two layers of thin sheet material, each of which shall pass the electric strength test below, or</li> <li>- one layer having a distance through insulation of at least 0,4 mm, which shall pass the electric strength test below.</li> </ul> <p>Alternatively for components, there is no distance through insulation requirements for the insulation consisting of an insulating compound completely filling the casing, so that CLEARANCES and CREEPAGE DISTANCES do not exist, if the component passes the electric strength test in accordance with the compliance clause below and in addition</p> <ul style="list-style-type: none"> <li>- passes the tests and inspection criteria of 2.10.11 with an electric strength test of 1,5 kV multiplied by 1,6 (the electric strength test of 2.10.10 shall be performed using 1,5 kV), and</li> <li>- is subject to ROUTINE TESTING for electric strength during manufacturing, using a test voltage of 1,5 kV.</li> </ul>	No TNV circuits.	N/A

IEC60950_1F - ATTACHMENT			
Clause	Requirement + Test	Result - Remark	Verdict
<b>ZB ANNEX (normative) SPECIAL NATIONAL CONDITIONS (EN)</b>			
Clause	Requirement + Test	Result - Remark	Verdict
	<p>It is permitted to bridge this insulation with an optocoupler complying with 2.10.5.4 b).</p> <p>It is permitted to bridge this insulation with a capacitor complying with EN 60384-14:2005, subclass Y2.</p> <p>A capacitor classified Y3 according to EN 60384-14:2005, may bridge this insulation under the following conditions:</p> <ul style="list-style-type: none"> <li>- the insulation requirements are satisfied by having a capacitor classified Y3 as defined by EN 60384-14, which in addition to the Y3 testing, is tested with an impulse test of 2,5 kV defined in EN 60950-1:2006, 6.2.2.1;</li> <li>- the additional testing shall be performed on all the test specimens as described in EN 60384-14:</li> <li>- the impulse test of 2,5 kV is to be performed before the endurance test in EN 60384-14, in the sequence of tests as described in EN 60384-14.</li> </ul>		
6.1.2.2	In <b>Finland, Norway and Sweden</b> , the exclusions are applicable for PERMANENTLY CONNECTED EQUIPMENT, PLUGGABLE EQUIPMENT TYPE B and equipment intended to be used in a RESTRICTED ACCESS LOCATION where equipotential bonding has been applied, e.g. in a telecommunication centre, and which has provision for a permanently connected PROTECTIVE EARTHING CONDUCTOR and is provided with instructions for the installation of that conductor by a SERVICE PERSON.	No TNV circuits.	<b>N/A</b>
7.2	In <b>Finland, Norway and Sweden</b> , for requirements see 6.1.2.1 and 6.1.2.2 of this annex.  The term TELECOMMUNICATION NETWORK in 6.1.2 being replaced by the term CABLE DISTRIBUTION SYSTEM.	Not connected to a cable distribution system.	<b>N/A</b>
7.3 (A11:2009)	In <b>Norway and Sweden</b> , for requirements see 1.2.13.14 and 1.7.2.1 of this annex.	Not connected to a cable distribution system.	<b>N/A</b>

IEC60950_1F - ATTACHMENT			
Clause	Requirement + Test	Result - Remark	Verdict

**Annex ZD  
(informative)**

**IEC and CENELEC code designations for flexible cords**

Type of flexible cord	Code designations	
	IEC	CENELEC
<b>PVC insulated cords</b>		
Flat twin tinsel cord	60227 IEC 41	H03VH-Y
Light polyvinyl chloride sheathed flexible cord	60227 IEC 52	H03VV-F H03VVH2-F
Ordinary polyvinyl chloride sheathed flexible cord	60277 IEC 53	H05VV-F H05VVH2-F
<b>Rubber insulated cords</b>		
Braided cord	60245 IEC 51	H03RT-F
Ordinary tough rubber sheathed flexible cord	60245 IEC 53	H05RR-F
Ordinary polychloroprene sheathed flexible cord	60245 IEC 57	H05RN-F
Heavy polychloroprene sheathed flexible cord	60245 IEC 66	H07RN-F
<b>Cords having high flexibility</b>		
Rubber insulated and sheathed cord	60245 IEC 86	H03RR-H
Rubber insulated, crosslinked PVC sheathed cord	60245 IEC 87	H03RV4-H
Crosslinked PVC insulated and sheathed cord	60245 IEC 88	H03V4V4-H



IEC60950_1F ATTACHMENT			
Clause	Requirement + Test	Result - Remark	Verdict

<b>ATTACHMENT TO TEST REPORT IEC 60950-1 with A1: 2009 and A2:2013</b> <b>U.S.A. NATIONAL DIFFERENCES</b> Information technology equipment – Safety – Part 1: General requirements	
<b>Differences according to.....:</b>	UL 60950-1-07(Second Edition) + A1: 2011 + A2: 2014
<b>Attachment Form No. ....:</b>	US_ND_IEC60950_1F
<b>Attachment Originator .....</b>	UL
<b>Master Attachment.....:</b>	Date 2014-07
<b>Copyright © 2014 IEC System for Conformity Testing and Certification of Electrical Equipment (IECEE), Geneva, Switzerland. All rights reserved.</b>	

	<b>Special national conditions</b>		<b>P</b>
1.1.1	All equipment is designed as to allow installation in accordance with the National Electrical Code (NEC), ANSI/NFPA 70, Canadian Electrical Code (CEC), Part I, CAN/CSA C22.1, and if applicable, the National Electrical Safety Code, IEEE C2	Considered.	<b>P</b>
	Also, unless marked or otherwise identified, installation is allowed per the Standard for the Protection of Electronic Computer/Data-Processing Equipment, ANSI/NFPA 75	Considered.	<b>P</b>
1.1.2	Baby monitors are required to additionally comply with ASTM F2951, Consumer Safety Specification for Baby Monitors	No such part.	<b>N/A</b>
1.4.14	For Pluggable Equipment Type A, the protection in the installation is assumed to be 20A	Considered.	<b>P</b>
1.5.5	For lengths exceeding 3.05 m, external interconnecting flexible cord and cable assemblies are required to be a suitable cable type (e.g., DP, CL2) specified in the /NEC	Not applicable.	<b>N/A</b>
	For lengths 3.05 m or less, external interconnecting flexible cord and cable assemblies that are not types specified in the NEC are required to have special construction features and identification markings	Not applicable.	<b>N/A</b>
1.7.1	Equipment for use on a.c. mains supply systems with a neutral and more than one phase conductor (e.g. 120/240 V, 3-wire) require a special marking format for electrical ratings	Single phase only.	<b>N/A</b>
	A voltage rating that exceeds an attachment plug cap rating is only permitted if it does not exceed the extreme operating conditions in Table 2 of CAN/CSA C22.2 No. 235, and	Refer to Summary Of Testing in main test report.	<b>P</b>
	- if it is part of a range that extends into the Table 2 "Normal Operating Conditions"	Refer to Summary Of Testing in main test report.	<b>N/A</b>

IEC60950_1F ATTACHMENT			
Clause	Requirement + Test	Result - Remark	Verdict
	Likewise, a voltage rating is not to be lower than the specified "Normal Operating Conditions," unless it is part of a range that extends into the "Normal Operating Conditions"	Refer to Summary Of Testing in main test report.	<b>P</b>
1.7.7	Wiring terminals intended to supply Class 2 outputs in accordance with NEC or CEC Part 1 or NEC are marked with the voltage rating and "Class 2" or equivalent	No connectors and field wiring terminal for external Class 2 or Class 3 circuits.	<b>N/A</b>
	- Marking is located adjacent to the terminals	No such terminal used.	—
	- Marking is visible during wiring		—
2.5	Fuse providing Class 2, Limited Power Source, or TNV current limiting is not operator-accessible unless it is not interchangeable	No such fuse used.	<b>N/A</b>
2.6	Equipment with isolated ground (earthing) receptacles is in compliance with NEC 250.146(D) and CEC 10-112 and 10-906(8)	No ground receptacles.	<b>N/A</b>
2.7.1	Suitable NEC/CEC branch circuit protection rated at the maximum circuit rating is provided for all standard supply outlets and receptacles (such as supplied in power distribution units) if the supply branch circuit protection is not suitable.	No such part.	<b>N/A</b>
	Power distribution transformers distributing power at 100 volts or more, and rated 10 kVA or more, provided with special transformer overcurrent protection	No such part.	<b>N/A</b>
3.2	Wiring methods (terminals, leads, etc.) used for the connection of the equipment to the mains is in accordance with the NEC/CEC	The equipment is provided with an appliance inlet.	<b>N/A</b>
3.2.1	Attachment plugs of power supply cords are rated not less than 125 percent of the rated current of the equipment	Refer to Summary Of Testing in main test report.	<b>P</b>
3.2.1.2	Equipment connected to a centralized d.c. power system, and having one pole of the DC mains input terminal connected to the main protective earthing terminal in the equipment comply with special earthing, wiring, marking and installation instruction requirements	The equipment is not for connection to a DC mains supply.	<b>N/A</b>
3.2.3	Permanent connection of equipment to the mains supply by a power supply cord is not permitted, except for certain equipment, such as ATMs	Not permanently connected equipment.	<b>N/A</b>
3.2.5	Power supply cords are no longer than 4.5 m in length	Refer to Summary Of Testing in main test report.	<b>P</b>
	Minimum cord length is 1.5 m, with certain constructions such as external power supplies allowed to consider both input and output cord lengths into the requirement	Refer to Summary Of Testing in main test report.	<b>P</b>

IEC60950_1F ATTACHMENT			
Clause	Requirement + Test	Result - Remark	Verdict
	Flexible power supply cords are compatible with Article 400 of the NEC, and Tables 11 and 12 of the CEC	Refer to Summary Of Testing in main test report.	<b>P</b>
3.2.9	Permanently connected equipment has a suitable wiring compartment and wire bending space	No permanently connected equipment.	<b>N/A</b>
3.3	Wiring terminals and associated spacings for field wiring connections comply with CSA C22.2 No. 0	No field wiring terminal provided.	<b>N/A</b>
3.3.3	Wire binding screws are not attached with conductors larger than 10 AWG (5.3 mm <sup>2</sup> )		<b>N/A</b>
3.3.4	Terminals for permanent wiring, including protective earthing terminals, are suitable for Canadian/US wire gauge sizes, are		<b>N/A</b>
	- rated 125 per cent of the equipment rating, and		—
	- are specially marked when specified (1.7.7)		—
3.3.5	Revise first column of Table 3E to "Smaller of the RATED CURRENT of the equipment or the PROTECTIVE CURRENT RATING of the circuit under consideration"	Revised.	<b>N/A</b>
3.4.2	Motor control devices are provided for cord-connected equipment with a motor if the equipment is rated more than 12 A,	No AC motor.	<b>N/A</b>
	- or if the motor has a nominal voltage rating greater than 120 V		—
	- or is rated more than 1/3 hp (locked rotor current over 43 A)		—
3.4.8	Vertically-mounted disconnect switches and circuit breakers have the "on" position indicated by the handle in the up position	No such switch used.	<b>N/A</b>
3.4.11	For computer room applications, equipment with battery systems capable of supplying 750 VA for five minutes have a battery disconnect means that may be connected to the computer room remote power-off circuit	No battery in the equipment.	<b>N/A</b>
4.3.12	The maximum quantity of flammable liquid stored in equipment complies with NFPA 30	No flammable liquids within the equipment.	<b>N/A</b>
4.3.13.5.1	Equipment with lasers meets the U.S. Code of Federal Regulations 21 CFR 1040 (and the Canadian Radiation Emitting Devices Act, REDR C1370).	No laser on equipment.	<b>N/A</b>
4.7	For computer room applications, automated information storage systems with combustible media greater than 0.76 m <sup>3</sup> (27 cu ft) have a provision for connection of either automatic sprinklers or a gaseous agent extinguishing system with an extended discharge	The equipment has no combustible area greater than 0.76 m <sup>3</sup> .	<b>N/A</b>

IEC60950_1F ATTACHMENT			
Clause	Requirement + Test	Result - Remark	Verdict
4.7.3.1	For computer room applications, enclosures with combustible material measuring greater than 0.9m <sup>2</sup> (10 sq ft) or a single dimension greater than 1.8 m (6 ft) have a flame spread rating of 50 or less	The equipment has no combustible material greater than 0.9m <sup>2</sup> or single dimension greater than 1.8m.	N/A
	For other applications, enclosures with the same dimensions require a flame spread rating of 200 or less		—
4.7.3.1	Non-metallic enclosures of equipment for use in spaces used for environmental air (plenums) are required to comply with UL 2043	Equipment not used in environmental air space.	N/A
Annex H	Equipment that produces ionizing radiation complies with U.S. Code of Federal Regulations, 21 CFR 1020 (and the Canadian Radiation Emitting Devices Act, REDR C1370)	The equipment does not produce ionizing radiation.	N/A
<b>Other National Differences</b>			
1.5.1	Some components and materials associated with the risk of fire, electric shock, or personal injury have component or material ratings in accordance with the applicable national (Canadian and/or U.S.) component or material standard requirements. These components include: attachment plugs, battery backup systems, battery packs, cathode ray tubes, circuit breakers, communication circuit accessories, connectors (used for current interruption of non-LPS circuits), cord sets and power supply cords, direct plug-in equipment, electrochemical capacitor modules (energy storage modules with ultracapacitors), enclosures (outdoor), flexible cords and cables, fuses (branch circuit), fuseholders, ground-fault current interrupters, industrial control equipment, insulating tape, interconnecting cables, lampholders, limit controls, printed wiring, protectors for communications circuits, receptacles, solid state controls, supplementary protectors, switches (including interlock switches), thermal cut-offs, thermostats, (multi-layer) transformer winding wire, surge protective devices, tubing, vehicle battery adapters, wire connectors, and wire and cables	Considered, see appended table 1.5.1 in the main test report.	P
1.6.1.2	A circuit for connection to the DC Mains Supply is classified as a SELV Circuit, TNV-2 Circuit or Hazardous Voltage Circuit depending on the maximum operating voltage of the supply	No connect to DC power distribution system.	N/A
	This maximum operating voltage includes consideration of the battery charging "float voltage" associated with the intended supply system, regardless of the marked power rating of the equipment	No such part.	N/A

IEC60950_1F ATTACHMENT			
Clause	Requirement + Test	Result - Remark	Verdict
2.3.1	For TNV-2 and TNV-3 circuits with other than ringing signals and with voltages exceeding 42.4 V <sub>peak</sub> or 60 Vd.c., the maximum acceptable current through a 2000 ohm resistor (or greater) connected across the voltage source with other loads disconnected is 7.1 mA peak or 30 mA d.c. under normal operating conditions	No TNV circuitry.	N/A
2.3.2.1	In the event of a single fault between TNV and SELV circuits, the limits of 2.2.3 apply to SELV Circuits and accessible conductive parts	No TNV circuitry.	N/A
2.6.2	Equipment with functional earthing marked with the functional earthing symbol (IEC 60417-6092)	Must be considered when marketed in USA.	—
2.6.3.4	Protective bonding conductors of non-standard protective bonding constructions (e.g., printed circuit traces) may be subjected to the additional limited short circuit test conditions specified	Must be considered when marketed in USA.	—
4.2.8.1	Enclosures around CRTs with a face diameter of 160 mm or more reduce the risk of injury due to the implosion of the CRT	No CRTs in the equipment.	N/A
4.3.2	Equipment with handles complies with special loading tests		N/A
4.3.8	Battery packs for both portable and stationary applications comply with special component requirements	No battery packs.	N/A
5.1.8.3	Equipment intended to receive telecommunication ringing signals comply with a special touch current measurement tests	Not connected to a telecommunication network.	N/A
5.3.7	Internal (e.g., card cage) SELV circuit connectors and printed wiring board connectors that are accessible to the operator and that deliver power are overloaded	Considered.	P
	During abnormal operating testing, if a circuit is interrupted by the opening of a component, the test is repeated twice (three tests total) using new components as necessary	No tests interrupted by opening of a component.	N/A
6.4	Equipment intended for connection to telecommunication network outside plant cable is protected against overvoltage from power line crosses in accordance with 6.4 and Annex NAC	No TNV circuitry.	N/A
Annex EE	Articulated accessibility probe (Fig EE.3) is used for assessing accessibility to document/media shredders instead of the Figure 2A test finger	No such parts.	N/A
Annex M.2	Continuous ringing signals up to 16 mA only are permitted if the equipment is subjected to special installation and performance restrictions	No applicable.	N/A

IEC60950_1F ATTACHMENT			
Clause	Requirement + Test	Result - Remark	Verdict
Annex NAD	Equipment connected to a telecommunication and cable distribution networks and supplied with an earphone intended to be held against, or in the ear comply with special acoustic pressure requirements	Not applicable.	<b>N/A</b>

IEC60950_1F ATTACHMENT			
Clause	Requirement + Test	Result - Remark	Verdict

<b>ATTACHMENT TO TEST REPORT IEC 60950-1 with A1:2009 and A2:2013 CANADA NATIONAL DIFFERENCES</b> Information technology equipment – Safety – Part 1: General requirements			
<b>Differences according to.....:</b>	CAN/CSA-C22.2 No. 60950-1-07, Amd 1:2011, Amd 2:2014		
<b>Attachment Form No. ....:</b>	CA_ND_IEC60950_1F		
<b>Attachment Originator .....</b>	CSA		
<b>Master Attachment.....:</b>	Date (2015-05)		
<b>Copyright © 2015 IEC System for Conformity Testing and Certification of Electrical Equipment (IECEE), Geneva, Switzerland. All rights reserved.</b>			

1.1.1	All equipment is to be designed to allow installation in accordance with the National Electrical Code (NEC), ANSI/NFPA 70, the Canadian Electrical Code (CEC), Part I, CAN/CSA C22.1, and when applicable, the National Electrical Safety Code, IEEE C2. Also, unless marked or otherwise identified, installation is allowed per the Standard for the Protection of Electronic Computer/Data-Processing Equipment, ANSI/NFPA 75.	Considered.	P
1.1.2	Baby monitors are required to additionally comply with ASTM F2951, Consumer Safety Specification for Baby Monitors.	No such part.	N/A
1.4.14	For Pluggable Equipment Type A, the protection in the installation is assumed to be 20A:	Considered.	P
1.5.5	For lengths exceeding 3.05 m, external interconnecting flexible cord and cable assemblies are required to be a suitable cable type (e.g., DP, CL2) specified in the CEC/NEC.  For lengths 3.05 m or less, external interconnecting flexible cord and cable assemblies that are not types specified in the CEC/NEC are required to have special construction features and identification markings.	Not applicable.	N/A

IEC60950_1F ATTACHMENT			
Clause	Requirement + Test	Result - Remark	Verdict
1.7.1	Equipment for use on a.c. mains supply systems with a neutral and more than one phase conductor (e.g. 120/240 V, 3-wire) require a special marking format for electrical ratings. A voltage rating that exceeds an attachment plug cap rating is only permitted if it does not exceed the extreme operating conditions in Table 2 of CAN/CSA C22.2 No. 235, and if it is part of a range that extends into the Table 2 "Normal Operating Conditions." Likewise, a voltage rating shall not be lower than the specified "Normal Operating Conditions," unless it is part of a range that extends into the "Normal Operating Conditions."	See main test report cl. 1.7.1	N/A
1.7.7	Wiring terminals intended to supply Class 2 outputs in accordance with CEC Part 1 or NEC shall be marked with the voltage rating and "Class 2" or equivalent. Marking shall be located adjacent to the terminals and shall be visible during wiring.	Not applicable.	N/A
2.5	Where a fuse is used to provide Class 2, Limited Power Source, or TNV current limiting, it shall not be operator-accessible unless it is not interchangeable.	No such fuse used.	N/A
2.6	Equipment with isolated ground (earthing) receptacles are required to comply with NEC 250.146(D) and CEC 10-112 and 10-906(8).	No ground receptacles.	N/A
2.7.1	Suitable NEC/CEC branch circuit protection rated at the maximum circuit rating is required for all standard supply outlets and receptacles (such as supplied in power distribution units) if the supply branch circuit protection is not suitable.  Power distribution transformers distributing power at 100 volts or more, and rated 10 kVA or more, require special transformer overcurrent protection.	No such part.	N/A
3.2	Wiring methods (terminals, leads, etc.) used for the connection of the equipment to the mains shall be in accordance with the NEC/CEC.	The equipment is provided with an appliance inlet.	N/A
3.2.1	Power supply cords are required to have attachment plugs rated not less than 125 percent of the rated current of the equipment.	Refer to Summary Of Testing in main test report.	P



IEC60950_1F ATTACHMENT			
Clause	Requirement + Test	Result - Remark	Verdict
3.2.1.2	Equipment connected to a centralized d.c. power system, and having one pole of the DC mains input terminal connected to the main protective earthing terminal in the equipment, is required to comply with special earthing, wiring, marking and installation instruction requirements.	The equipment is not for connection to a DC mains supply.	N/A
3.2.3	Permanent connection of equipment to the mains supply by a power supply cord is not permitted, except for certain equipment, such as ATMs.	Not permanently connected equipment.	N/A
3.2.5	Power supply cords are required to be no longer than 4.5 m in length.  Minimum cord length is required to be 1.5 m, with certain constructions such as external power supplies allowed to consider both input and output cord lengths into the requirement.  Flexible power supply cords are required to be compatible with Article 400 of the NEC, and Tables 11 and 12 of the CEC.	Refer to Summary Of Testing in main test report.	P
3.2.9	Permanently connected equipment is required to have a suitable wiring compartment and wire bending space.	Not permanently connected equipment.	N/A
3.3	Wiring terminals and associated spacings for field wiring connections shall comply with CSA C22.2 No. 0	The equipment is provided with an appliance inlet, no such parts.	N/A
3.3.3	Wire binding screws are not permitted to attach conductors larger than 10 AWG (5.3 mm <sup>2</sup> ).	The equipment is provided with an appliance inlet, no such parts.	N/A
3.3.4	Terminals for permanent wiring, including protective earthing terminals, are required to be suitable for US/Canadian wire gauge sizes, rated 125 percent of the equipment rating, and be specially marked when specified (1.7.7).	The equipment is provided with an appliance inlet, no such parts.	N/A
3.3.5	First column of Table 3E revised to require "Smaller of the RATED CURRENT of the equipment or the PROTECTIVE CURRENT RATING of the circuit under consideration."	Revised.	N/A
3.4.2	Motor control devices are required for cord-connected equipment with a motor if the equipment is rated more than 12 A, or if the motor has a nominal voltage rating greater than 120 V, or is rated more than 1/3 hp (locked rotor current over 43 A).	No AC motor.	N/A

IEC60950_1F ATTACHMENT			
Clause	Requirement + Test	Result - Remark	Verdict
3.4.8	Vertically-mounted disconnect switches and circuit breakers are required to have the "on" position indicated by the handle in the up position.	No such switch used.	N/A
3.4.11	For computer room applications, equipment with battery systems capable of supplying 750 VA for five minutes are required to have a battery disconnect means that may be connected to the computer room remote power-off circuit.	No battery in the equipment.	N/A
4.3.12	The maximum quantity of flammable liquid stored in equipment is required to comply with NFPA 30.	No flammable liquids within the equipment.	N/A
4.3.13.5.1	Equipment with lasers is required to meet the U.S. Code of Federal Regulations 21 CFR 1040 (and the Canadian Radiation Emitting Devices Act, REDR C1370).	No laser.	N/A
4.7	For computer room applications, automated information storage systems with combustible media greater than 0.76 m <sup>3</sup> (27 cu ft) are required to have a provision for connection of either automatic sprinklers or a gaseous agent extinguishing system with an extended discharge.	The equipment has no combustible area greater than 0.76 m <sup>3</sup> .	N/A
4.7.3.1	For computer room applications, enclosures with combustible material measuring greater than 0.9 m <sup>2</sup> (10 sq ft) or a single dimension greater than 1.8 m (6 ft) are required to have a flame spread rating of 50 or less. For other applications, enclosures with the same dimensions require a flame spread rating of 200 or less.	The equipment has no combustible material greater than 0.9m <sup>2</sup> or single dimension greater than 1.8m.	N/A
	Non-metallic enclosures of equipment for use in spaces used for environmental air (plenums) are required to comply with UL 2043.	Equipment not used in environmental air space.	N/A
Annex H	Equipment that produces ionizing radiation is required to comply with the U.S. Code of Federal Regulations, 21 CFR 1020 (and the Canadian Radiation Emitting Devices Act, REDR C1370).	The equipment does not produce ionizing radiation.	N/A

IEC60950_1F ATTACHMENT			
Clause	Requirement + Test	Result - Remark	Verdict

#### OTHER DIFFERENCES

The following key national differences are based on requirements other than national regulatory requirements.

1.5.1	<p>Some components and materials associated with the risk of fire, electric shock, or personal injury are required to have component or material ratings in accordance with the applicable national (Canadian and/or U.S.) component or material standard requirements. These components include:</p> <p>attachment plugs, battery packs (rechargeable type, used with transportable equipment), cathode ray tubes, circuit breakers, communication circuit accessories, connectors (used for current interruption of non-LPS circuits), cord sets and power supply cords, direct plug-in equipment, enclosures (outdoor), flexible cords and cables, fuses (branch circuit), fuseholders, ground-fault current interrupters, industrial control equipment, insulating tape, interconnecting cables, lampholders, limit controls, printed wiring, protectors for communications circuits, receptacles, solid state controls, supplementary protectors, switches (including interlock switches), thermal cutoffs, thermostats, (multi-layer) transformer winding wire, transient voltage surge suppressors, tubing, wire connectors, and wire and cables.</p>	Considered, see appended table 1.5.1 in the main test report.	<b>P</b>
1.6.1.2	<p>A circuit for connection to the DC Mains Supply is classified as either a SELV Circuit, TNV-2 Circuit or Hazardous Voltage Circuit depending on the maximum operating voltage of the supply. This maximum operating voltage shall include consideration of the battery charging "float voltage" associated with the intended supply system, regardless of the marked power rating of the equipment.</p>	No connect to DC power distribution system.	<b>N/A</b>
2.3.1	<p>For TNV-2 and TNV-3 circuits with other than ringing signals and with voltages exceeding 42.4 V<sub>peak</sub> or 60 V<sub>d.c.</sub>, the maximum acceptable current through a 2000 ohm resistor (or greater) connected across the voltage source with other loads disconnected is 7.1 mA peak or 30 mA d.c. under normal operating conditions.</p>	No TNV circuitry.	<b>N/A</b>
2.3.2.1	<p>In the event of a single fault between TNV and SELV circuits, the limits of 2.2.3 apply to SELV Circuits and accessible conductive parts.</p>	No TNV circuitry.	<b>N/A</b>

IEC60950_1F ATTACHMENT			
Clause	Requirement + Test	Result - Remark	Verdict
2.6.2	Equipment with functional earthing is required to be marked with the functional earthing symbol (IEC 60417-6092).	Must be considered when marketed in Canada.	—
2.6.3.4	Protective bonding conductors of non-standard protective bonding constructions (e.g., printed circuit traces) may be subjected to the additional limited short circuit test conditions specified.	Must be considered when marketed in Canada.	—
4.2.8.1	Enclosures around CRTs with a face diameter of 160 mm or more are required to reduce the risk of injury due to the implosion of the CRT.	No CRTs in the equipment.	N/A
4.3.2	Equipment with handles is required to comply with special loading tests.		N/A
4.3.8	Battery packs for both portable and stationary applications are required to comply with special component requirements.	No battery packs.	N/A
5.1.8.3	Equipment intended to receive telecommunication ringing signals is required to comply with a special touch current measurement tests.	Not connected to a telecommunication network.	N/A
5.3.7	Internal (e.g., card cage) SELV circuit connectors and printed wiring board connectors that are accessible to the operator and that deliver power are to be overloaded.	Considered.	P
	During abnormal operating testing, if a circuit is interrupted by the opening of a component, the test shall be repeated twice (three tests total) using new components as necessary.	Not applicable.	N/A
6.4	Equipment intended for connection to telecommunication network outside plant cable is required to be protected against overvoltage from power line crosses in accordance with 6.4 and Annex NAC.	No TNV circuitry.	N/A
Annex EE	UL articulated accessibility probe (Fig EE.3) required for assessing accessibility to document/media shredders instead of the Figure 2A test finger.	No such parts.	N/A
M.2	Continuous ringing signals up to 16 mA only are permitted if the equipment is subjected to special installation and performance restrictions.	No applicable.	N/A
Annex NAD	Equipment connected to a telecommunication and cable distribution networks and supplied with an earphone intended to be held against, or in the ear is required to comply with special acoustic pressure requirements.	Not applicable.	N/A

IEC 60950-1:2005Am1			
Clause	Requirement + Test	Result - Remark	Verdict

National Differences for Korea			N/A
Test results according to last modification date 2010-12-16 in CB Bulletin			
1.5.101	Addition Plugs for the connection of the apparatus to the supply mains shall comply with the Korean requirement (KSC 8305 and 8305).	Refer to Summary Of Testing in main test report.	N/A
8	Addition EMC The apparatus shall comply with the relevant CISPR standards.	Must be considered before marketed in Korea.	—

IEC 60950-1:2005Am1			
Clause	Requirement + Test	Result - Remark	Verdict

**ATTACHMENT TO TEST REPORT IEC 60950-1**  
**GERMANY NATIONAL DIFFERENCES**  
 Information technology equipment – Safety –  
 Part 1: General requirements

**Differences according to.....: VDE 0805-1:2011-01**

**Test results according to last modification date 2011-02-15 in CB Bulletin**

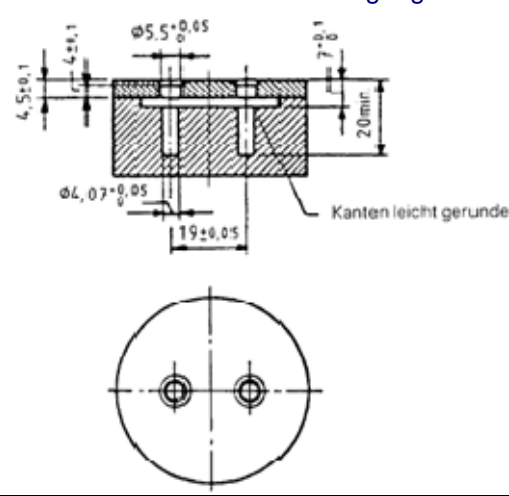
<p>DIN EN 60950-1 (VDE 0805-1):2011-01: 1.5            EK1-557-13            2013-07</p>	<p>The moulded plug of plug-in power supplies will be considered as component and will be generally evaluated in Germany according to DIN VDE 0620-1:2010 respectively DIN VDE 0620-1:2013 and DIN VDE 0620-2-1:2013</p> <p>After the test according to DIN VDE 0620-2-1:2013, sub-clause 24.2, the plug be shall still pass the test according to DIN VDE 0620-101:1992 clause 7, figure 2 “Gauge for interchangeability”</p> <p>It should be possible to insert the plug without applying an excessive force such that the end surface touches the surface of the gauge</p> 	<p>Not a plug-in equipment.</p>	<p>N/A</p>
<p>Annex ZC, 1.7.2.1</p>	<p>According to GPSG, section 2, clause 4: If certain rules on the use, supplementation or maintenance of an item of technical work equipment or ready-to-use commodity must be observed in order to guarantee safety and health, instructions for use in German must be supplied when it is brought into circulation.</p>	<p>Must be considered before marketed in Germany.</p>	<p>—</p>

IEC 60950-1:2005Am1			
Clause	Requirement + Test	Result - Remark	Verdict

SI 60950 Part 1 (2009)			
ATTACHMENT: NATIONAL DIFFERENCES – ISRAEL			
Test results according to Online CB BULLETIN (Last modified date of 2011-03-02)			
1.7	<p><b>Marking and instructions</b></p> <p>The clause is applicable with the following additions:            - Subclause 1.7.201 shall be added at the beginning of the clause as follows:</p>		—
1.7.201	<p><b>Marking in the Hebrew language</b></p> <p>The marking in the Hebrew language shall be in accordance with the Consumer Protection Order (Marking of goods), 1983.</p> <p>In addition to the marking required by clause 1.7.1, the following details shall be marked in the Hebrew language.</p> <p>The details shall be marked on the apparatus or on its package, or on a label properly attached to the apparatus or on the package, by bonding or sewing, in a manner that the label cannot be easily removed.</p> <ol style="list-style-type: none"> <li>1. Name of the apparatus and its commercial designation;</li> <li>2. Manufacturer's name and address. If the apparatus is imported, the importer's name and address;</li> <li>3. Manufacturer's registered trademark, if any;</li> <li>4. Name of the model and serial number, if any;</li> <li>5. Country of manufacture.</li> </ol>	<p>Must be considered when marketing into Israel.</p>	—
1.7.2	<p><b>Safety instructions and Marking</b></p> <p><b>1.7.2.1 General</b></p> <p>The following shall be added to the clause:            All the instructions and warnings related to safety shall also be written in the Hebrew language.</p>	<p>Must be considered when marketing into Israel.</p>	—
2.	<p><b>Protection from Hazards</b></p> <p>The clause is applicable with the following additions:</p>		P

IEC 60950-1:2005Am1			
Clause	Requirement + Test	Result - Remark	Verdict
2.9.4	<p>Separation from hazardous voltages The following shall be added at the beginning of the clause :</p> <p>In Israel, according to the Electricity Law, 1954, and the Electricity Regulations (Earthing and means of protection against electricity of voltages up to 1,000V) 1991, seven means of protection against electrocution are permitted, as follows:</p> <ol style="list-style-type: none"> <li>1) TN-S - Network system earthing; TN-C-S - Network system earthing;</li> <li>2) TT - Network system earthing;</li> <li>3) IT - Network Insulation Terre;</li> <li>4) Isolated transformer;</li> <li>5) Safety extra low voltage (SELV or ELV) ;</li> <li>6) Residual current circuit breaker (30 rna =I<math>\Delta</math>);</li> <li>7) Reinforced insulation; Double insulation (class II)</li> </ol> <p><input type="checkbox"/></p> <p>Clause 2.201 shall be added at the end of the clause, as follows:</p>	Considered.	P
2.201	<p>Prevention of electromagnetic interference</p> <ul style="list-style-type: none"> <li>- Prior to carrying out the tests in accordance with the clauses of this Standard, the compliance of the apparatus with the relevant requirements specified in the appropriate part of the Standard series, SI 961, shall be checked.</li> </ul> <p><b>The apparatus shall meet the requirements in the appropriate part of the Standard series.</b> SI 961.</p> <ul style="list-style-type: none"> <li>- <b>If there are components in the apparatus for the prevention of electromagnetic interference,</b> these components shall not reduce the safety level of the apparatus as required by this Standard.</li> </ul>	Considered.	P
3.	<p><b>Wiring, connections and supply</b> The clause is applicable with the following additions:</p>		—
3.2	<p><b>Connection to a mains supply</b></p>		—
3.2.1	<p><b>Means of connection</b></p>		N/A
3.2.1.1	<p><b>Connection to an a.c. mains supply</b> After the note, the following note shall be added: Note: <b>In Israel, the feed plug shall comply with the requirements of Israel Standard 51 32 Part I.</b></p>	Must be considered when marketing in Israel	—
3.2.1.2	<p><b>Connection to a d.c. mains supply</b> At the end of the first paragraph, the following note shall be added: Note: At the time of issue of this Standard, there is no Israel Standard for connection accessories to d.c.</p>	The equipment dose not connect to d.c. mains supply	N/A



<b>IEC 60950-1:2005Am1</b>			
<b>Clause</b>	<b>Requirement + Test</b>	<b>Result - Remark</b>	<b>Verdict</b>

<b>ANNEX P</b>	<p><b>Normative references</b></p> <p>The annex is applicable with the following national deviations:</p> <ul style="list-style-type: none"> <li>- The following Israel Standards have been inserted in place of some of the International Standards specified in this annex of the Standard, as follows:</li> </ul>																																			
	<table border="1" style="width: 100%; border-collapse: collapse;"> <thead> <tr> <th style="width: 20%; padding: 5px;">The referenced International Standard</th> <th style="width: 40%; padding: 5px;">The substituted Israel Standard</th> <th style="width: 40%; padding: 5px;">Comments</th> </tr> </thead> <tbody> <tr> <td style="padding: 5px;">IEC 60065: 2001</td> <td style="padding: 5px;">SI 250(A) - Safety requirements for mains operated electronic and related apparatus for household and similar <b>general use</b></td> <td style="padding: 5px;">The Israel Standard, excluding national <b>deviations in it, is identical to the</b> Standard of the International Electrotechnical Commission, IEC 65:1985, including its amendments</td> </tr> <tr> <td style="padding: 5px;">IEC 60227 (all parts)</td> <td style="padding: 5px;">SI 473, all parts - Cables, cords and <b>insulated conductors for nominal</b> voltage up to 1000 volt</td> <td style="padding: 5px;">-</td> </tr> <tr> <td style="padding: 5px;">IEC 60309 (all parts)</td> <td style="padding: 5px;">SI 1109, all parts - Plugs, socket-outlets and couplers for industrial <b>purposes</b></td> <td style="padding: 5px;">SI 1109, part I and part 2, excluding <b>national deviations in them, are</b> identical to the Standards of the International Electrotechnical Commission IEC 60309-1:1999 and IEC 60309-2:1999, respectively.</td> </tr> <tr> <td style="padding: 5px;">IEC 60317 (all parts)</td> <td style="padding: 5px;">SI 1067 Part I – Self-fluxing <b>enamelled(B)</b> round copper wires with high mechanical properties</td> <td style="padding: 5px;">The Israel Standard is identical to the Standard of the International <b>Electrotechnical Commission</b> IEC 317-1 (1980)</td> </tr> <tr> <td></td> <td style="padding: 5px;">SI 1067 Part 2 – Self-fluxing <b>enamelled(B)</b> round copper wires</td> <td style="padding: 5px;">The Israel Standard is identical to the Standard of the International <b>Electrotechnical Commission</b> IEC 317-4 (1980)</td> </tr> <tr> <td></td> <td style="padding: 5px;">SI 1067 Part 3 - Self-fluxing <b>enamelled<sup>(B)</sup></b> round copper wires with a temperature index of 180°</td> <td style="padding: 5px;">The Israel Standard is identical to the Standard of the International <b>Electrotechnical Commission</b> IEC 317-8 (1980)</td> </tr> <tr> <td style="padding: 5px;">IEC 60320 (all parts)</td> <td style="padding: 5px;">SI 60320 Part 1 - Appliance couplers for household and similar general <b>purposes: General requirements</b></td> <td style="padding: 5px;">The Israel Standard, excluding national <b>deviations in it, is identical to the</b> Standard of the International <b>Electrotechnical Commission,</b> IEC 60320-1 (2001)</td> </tr> <tr> <td></td> <td style="padding: 5px;">SI 60320 Part 2.1 - Appliance couplers for household and similar general <b>purposes: Sewing machine couplers</b></td> <td style="padding: 5px;">The Israel Standard, excluding national <b>deviations in it, is identical to the</b> Standard of the International <b>Electrotechnical Commission,</b> IEC 60320-2.1 (2000)</td> </tr> <tr> <td style="padding: 5px;">IEC 60320 (all parts)</td> <td style="padding: 5px;">SI 60320 Part 2.2 – Appliance couplers for household and similar general <b>purposes: Interconnection couplers</b> for household and similar equipment</td> <td style="padding: 5px;">The Israel Standard, excluding national <b>deviations in it, is identical to the</b> Standard of the International <b>Electrotechnical Commission,</b> IEC 60320-2.2 (1998)</td> </tr> <tr> <td></td> <td style="padding: 5px;">SI 60320 Part 2.3 - Appliance couplers for household and similar general <b>purposes: Interconnection couplers</b> for household and similar equipment Appliance coupler for household and similar general purposes: Appliance coupler with a degree of protection higher than IPXO</td> <td style="padding: 5px;">The Israel Standard, excluding national <b>deviations in it, is identical to the</b> Standard of the International <b>Electrotechnical Commission,</b> IEC 60320-2.3 (1998)</td> </tr> </tbody> </table>	The referenced International Standard	The substituted Israel Standard	Comments	IEC 60065: 2001	SI 250(A) - Safety requirements for mains operated electronic and related apparatus for household and similar <b>general use</b>	The Israel Standard, excluding national <b>deviations in it, is identical to the</b> Standard of the International Electrotechnical Commission, IEC 65:1985, including its amendments	IEC 60227 (all parts)	SI 473, all parts - Cables, cords and <b>insulated conductors for nominal</b> voltage up to 1000 volt	-	IEC 60309 (all parts)	SI 1109, all parts - Plugs, socket-outlets and couplers for industrial <b>purposes</b>	SI 1109, part I and part 2, excluding <b>national deviations in them, are</b> identical to the Standards of the International Electrotechnical Commission IEC 60309-1:1999 and IEC 60309-2:1999, respectively.	IEC 60317 (all parts)	SI 1067 Part I – Self-fluxing <b>enamelled(B)</b> round copper wires with high mechanical properties	The Israel Standard is identical to the Standard of the International <b>Electrotechnical Commission</b> IEC 317-1 (1980)		SI 1067 Part 2 – Self-fluxing <b>enamelled(B)</b> round copper wires	The Israel Standard is identical to the Standard of the International <b>Electrotechnical Commission</b> IEC 317-4 (1980)		SI 1067 Part 3 - Self-fluxing <b>enamelled<sup>(B)</sup></b> round copper wires with a temperature index of 180°	The Israel Standard is identical to the Standard of the International <b>Electrotechnical Commission</b> IEC 317-8 (1980)	IEC 60320 (all parts)	SI 60320 Part 1 - Appliance couplers for household and similar general <b>purposes: General requirements</b>	The Israel Standard, excluding national <b>deviations in it, is identical to the</b> Standard of the International <b>Electrotechnical Commission,</b> IEC 60320-1 (2001)		SI 60320 Part 2.1 - Appliance couplers for household and similar general <b>purposes: Sewing machine couplers</b>	The Israel Standard, excluding national <b>deviations in it, is identical to the</b> Standard of the International <b>Electrotechnical Commission,</b> IEC 60320-2.1 (2000)	IEC 60320 (all parts)	SI 60320 Part 2.2 – Appliance couplers for household and similar general <b>purposes: Interconnection couplers</b> for household and similar equipment	The Israel Standard, excluding national <b>deviations in it, is identical to the</b> Standard of the International <b>Electrotechnical Commission,</b> IEC 60320-2.2 (1998)		SI 60320 Part 2.3 - Appliance couplers for household and similar general <b>purposes: Interconnection couplers</b> for household and similar equipment Appliance coupler for household and similar general purposes: Appliance coupler with a degree of protection higher than IPXO	The Israel Standard, excluding national <b>deviations in it, is identical to the</b> Standard of the International <b>Electrotechnical Commission,</b> IEC 60320-2.3 (1998)		
The referenced International Standard	The substituted Israel Standard	Comments																																		
IEC 60065: 2001	SI 250(A) - Safety requirements for mains operated electronic and related apparatus for household and similar <b>general use</b>	The Israel Standard, excluding national <b>deviations in it, is identical to the</b> Standard of the International Electrotechnical Commission, IEC 65:1985, including its amendments																																		
IEC 60227 (all parts)	SI 473, all parts - Cables, cords and <b>insulated conductors for nominal</b> voltage up to 1000 volt	-																																		
IEC 60309 (all parts)	SI 1109, all parts - Plugs, socket-outlets and couplers for industrial <b>purposes</b>	SI 1109, part I and part 2, excluding <b>national deviations in them, are</b> identical to the Standards of the International Electrotechnical Commission IEC 60309-1:1999 and IEC 60309-2:1999, respectively.																																		
IEC 60317 (all parts)	SI 1067 Part I – Self-fluxing <b>enamelled(B)</b> round copper wires with high mechanical properties	The Israel Standard is identical to the Standard of the International <b>Electrotechnical Commission</b> IEC 317-1 (1980)																																		
	SI 1067 Part 2 – Self-fluxing <b>enamelled(B)</b> round copper wires	The Israel Standard is identical to the Standard of the International <b>Electrotechnical Commission</b> IEC 317-4 (1980)																																		
	SI 1067 Part 3 - Self-fluxing <b>enamelled<sup>(B)</sup></b> round copper wires with a temperature index of 180°	The Israel Standard is identical to the Standard of the International <b>Electrotechnical Commission</b> IEC 317-8 (1980)																																		
IEC 60320 (all parts)	SI 60320 Part 1 - Appliance couplers for household and similar general <b>purposes: General requirements</b>	The Israel Standard, excluding national <b>deviations in it, is identical to the</b> Standard of the International <b>Electrotechnical Commission,</b> IEC 60320-1 (2001)																																		
	SI 60320 Part 2.1 - Appliance couplers for household and similar general <b>purposes: Sewing machine couplers</b>	The Israel Standard, excluding national <b>deviations in it, is identical to the</b> Standard of the International <b>Electrotechnical Commission,</b> IEC 60320-2.1 (2000)																																		
IEC 60320 (all parts)	SI 60320 Part 2.2 – Appliance couplers for household and similar general <b>purposes: Interconnection couplers</b> for household and similar equipment	The Israel Standard, excluding national <b>deviations in it, is identical to the</b> Standard of the International <b>Electrotechnical Commission,</b> IEC 60320-2.2 (1998)																																		
	SI 60320 Part 2.3 - Appliance couplers for household and similar general <b>purposes: Interconnection couplers</b> for household and similar equipment Appliance coupler for household and similar general purposes: Appliance coupler with a degree of protection higher than IPXO	The Israel Standard, excluding national <b>deviations in it, is identical to the</b> Standard of the International <b>Electrotechnical Commission,</b> IEC 60320-2.3 (1998)																																		

IEC 60950-1:2005Am1				
Clause	Requirement + Test		Result - Remark	Verdict
ANNEX P	Continued			
	IEC 60730-1: 1999	SI 60730 Part] - Automatic electrical controls for household and similar use: <b>General requirements</b>	The Israel Standard, excluding national <b>deviations in it, is identical to the</b> Standard of the International <b>Electrotechnical Commission,</b> IEC 60730-1 (1999)	
	IEC 60825-1	SI 60825 Part I - Safety of laser products: Equipment classification, <b>requirements and user's guide</b>	The Israel Standard, excluding national <b>deviations in it, is identical to the</b> Standard of the International <b>Electrotechnical Commission,</b> IEC 60825-1 (2001).	
	IEC 60947-[ : 2004	SI 60947 Part 1 - Low-voltage <b>switchgear and controlgear: General rules</b>	The Israel Standard, excluding national <b>deviations in it, is identical to</b> Standard of the International <b>Electrotechnical Commission,</b> IEC 60947-[ (1999)	
	IEC 61058-1: 2000	SI 61058 Part I – Switches for <b>appliances: General requirements</b>	The Israel Standard, excluding national <b>deviations in it, is identical to the</b> Standard of the International Electrotechnical Commission, IEC 61058-1 (2001)	
	ISO 3864 (all parts)	SI 3864 Part 1 -Graphical symbols – Safety colours and safety signs: Design principles for safety signs in workplaces and public areas	The Israel Standard, excluding national <b>deviations in it, is identical to the</b> Standard of the International Electrotechnical Commission IEC 3864-1 (2002)	
	<b>Notes</b> (A) This Standard will be replaced by SI 60065 - Audio, video and similar electronic apparatus – safety requirements - that excluding the national deviations indicated is identical to the Standard of the International Electrotechnical Commission IEC 60065 (2005). (B) Not relevant to the translation.			
<b>B. Add the following to the clause:</b> <b>Israel Standards</b> SI 32 Part 1.1 - Plugs and socket-outlets for household and similar purposes : Plugs and socket-outlets for single phase up to I6A - Genera I requirements SI 96 1, all parts - Electromagnetic compatibility <b>Israel documents</b> Electricity Law, 1954, its regulations and revisions Kovetz Takanot 4465 dated 1983-02-24, Consumer Protection Order (Marking of goods), 1983				

IEC 60950-1: 2005			
Clause	Requirement + Test	Result - Remark	Verdict

**ATTACHMENT: AUSTRALIA / NEW ZEALAND NATIONAL DIFFERENCES**  
**Test results according to Online CB BULLETIN (Last modified date of 2011-05-06)**

<b>ZZ.1 Introduction</b>			
This Appendix sets out variations and additional requirements to cover issues which have not been addressed by the International Standard. These variations indicate national variations for purposes of the IECEE CB System and will be published in the IECEE CB Bulletin.			
<b>ZZ.2 Variations</b>			
The variations are as follows:			
1.2	Insert the following between 'person, service' and 'range, rated frequency': <b>POTENTIAL IGNITION SOURCE</b> 1.2.12	Considered.	P
1.2.12.20 1	Insert a new Clause 1.2.12.201 after Clause 1.2.12.15 as follows:  <b>1.2.12.201</b> <b>POTENTIAL IGNITION SOURCE</b>  Possible fault which can start a fire if the open-circuit voltage measured across an interruption or faulty contact exceeds a value of 50 V (peak) a.c. or d.c. and the product of the peak value of this voltage and the measured r.m.s. current under normal operating conditions exceeds 15 VA. Such a faulty contact or interruption in an electrical connection includes those which may occur in <b>CONDUCTIVE PATTERNS</b> on <b>PRINTED BOARDS</b> .  NOTE 201 An electronic protection circuit may be used to prevent such a fault from becoming a <b>POTENTIAL IGNITION SOURCE</b> .  NOTE 202 This definition is from AS/NZS 60065:2003.	Considered.	P
1.5.1	1. <i>Add</i> the following to the end of first paragraph: 'or the relevant Australian/New Zealand Standard'. 2. In NOTE 1, add the following after the word 'standard': 'or an Australian/New Zealand Standard'	Considered.	P
1.5.2	<i>Add</i> the following to the end of first and third dash items: 'or the relevant Australian/New Zealand Standard'.	Considered.	P

IEC 60950-1: 2005																						
Clause	Requirement + Test	Result - Remark	Verdict																			
3.2.5.1	<p><i>Modify</i> Table 3B as follows:</p> <p>1. <i>Delete</i> the first four rows and replace with the following:</p> <table border="1"> <thead> <tr> <th rowspan="2">RATED CURRENT OF EQUIPMENT A</th> <th colspan="3">Minimum conductor sizes</th> </tr> <tr> <th></th> <th>Nominal cross-sectional area mm<sup>2</sup></th> <th>AWG or kcmil [cross-sectional area in mm<sup>2</sup>] see note 2</th> </tr> </thead> <tbody> <tr> <td>Over 0.2 up to and including 3</td> <td>0,5 <sup>1)</sup></td> <td>18 [0,8]</td> </tr> <tr> <td>Over 3 up to and including 7.5</td> <td>0,75</td> <td>16 [1,3]</td> </tr> <tr> <td>Over 7.5 up to and including 10</td> <td>(0,75)<sup>2)</sup></td> <td>16 [1,3]</td> </tr> <tr> <td>Over 10 up to and including 16</td> <td>(1,0 )<sup>3)</sup></td> <td>14 [2]</td> </tr> </tbody> </table> <p><i>Replace</i> footnote 1) with the following:</p> <p><sup>1)</sup> This nominal cross-sectional area is only allowed for Class II appliances if the length of the power supply cord, measured between the point where the cord, or cord guard, enters the appliance, and the entry to the plug does not exceed 2 m (0,5 mm<sup>2</sup> three-core supply flexible cords are not permitted; see AS/NZS 3191).</p> <p>2. <i>Delete</i> Note 1.</p> <p>3. <i>Delete</i> Footnote a and replace with the following:</p> <p><sup>a</sup> This nominal cross-sectional area is only allowed for Class II appliances if the length of the power supply cord, measured between the point where the cord, or cord guard, enters the appliance, and the entry to the plug does not exceed 2 m (0,5 mm<sup>2</sup> three-core supply flexible cords are not permitted; see AS/NZS 3191).</p>	RATED CURRENT OF EQUIPMENT A	Minimum conductor sizes				Nominal cross-sectional area mm <sup>2</sup>	AWG or kcmil [cross-sectional area in mm <sup>2</sup> ] see note 2	Over 0.2 up to and including 3	0,5 <sup>1)</sup>	18 [0,8]	Over 3 up to and including 7.5	0,75	16 [1,3]	Over 7.5 up to and including 10	(0,75) <sup>2)</sup>	16 [1,3]	Over 10 up to and including 16	(1,0 ) <sup>3)</sup>	14 [2]	Refer to Summary Of Testing in main test report.	N/A
RATED CURRENT OF EQUIPMENT A	Minimum conductor sizes																					
		Nominal cross-sectional area mm <sup>2</sup>	AWG or kcmil [cross-sectional area in mm <sup>2</sup> ] see note 2																			
Over 0.2 up to and including 3	0,5 <sup>1)</sup>	18 [0,8]																				
Over 3 up to and including 7.5	0,75	16 [1,3]																				
Over 7.5 up to and including 10	(0,75) <sup>2)</sup>	16 [1,3]																				
Over 10 up to and including 16	(1,0 ) <sup>3)</sup>	14 [2]																				
4.1.201	<p><i>Insert</i> a new Clause 4.1.201 after Clause 4.1 as follows:</p> <p><b>4.1.201 Display devices used for television purposes</b> Display devices which may be used for television purposes, with a mass of 7 kg or more, shall comply with the requirements for stability and mechanical hazards, including the additional stability requirements for television receivers, specified in AS/NZS 60065.</p>	Not display devices used for television.	N/A																			
4.3.6	<p><i>Delete</i> the third paragraph and <i>Replace</i> with the following:</p> <p>Equipment with a plug portion, suitable for insertion into a 10 A 3-pin flat-pin socket-outlet complying with AS/NZS 3112, shall comply with the requirements in AS/NZS 3112 for equipment with integral pins for insertion into socket-outlets.</p>	Not intended to plug directly into a wall socket-outlet.	N/A																			
4.3.13.5	<p><i>Add</i> the following to the end of first paragraph: 'or AS/NZS 2211.1'.</p>	No Laser and LED is diffusive type.	N/A																			
4.7	<p><i>Add</i> the following paragraph to the end of the clause:</p> <p>For alternative tests refer to Clause 4.7.201.</p>	Refer to below.	P																			

IEC 60950-1: 2005			
Clause	Requirement + Test	Result - Remark	Verdict
4.7.201	<p><i>Insert a new Clause 4.7.201 after Clause 4.7.3.6 as follows:</i></p> <p><b>4.7.201 Resistance to fire – Alternative tests</b></p> <p><b>4.7.201.1 General</b></p> <p>Parts of non-metallic material shall be resistant to ignition and spread of fire.</p> <p>This requirement does not apply to decorative trims, knobs and other parts unlikely to be ignited or to propagate flames originating from inside the apparatus, or the following:</p> <p>(a) Components that are contained in an enclosure having a flammability category of V-0 according to AS/NZS 60695.11.10 and having openings only for the connecting wires filling the openings completely, and for ventilation not exceeding 1 mm in width regardless of length.</p> <p>(b) The following parts which would contribute negligible fuel to a fire:</p> <ul style="list-style-type: none"> <li>- small mechanical parts, the mass of which does not exceed 4g, such as mounting parts, gears, cams, belts and bearings;</li> <li>- small electrical components, such as capacitors with a volume not exceeding 1,750mm<sup>3</sup>, integrated circuits, transistors and optocoupler packages, if these components are mounted on material of flammability category V-1, or better, according to AS/NZS 60695.11.10.</li> </ul> <p><b>NOTE</b> In considering how to minimize propagation of fire and what 'small parts' are, account should be taken of the cumulative effect of small parts adjacent to each other for the possible effect of propagating fire from one part to another.</p> <p>Compliance shall be checked by the tests of 4.7.201.2, 4.7.201.3, 4.7.201.4 and 4.7.201.5.</p> <p>For the base material of printed boards, compliance shall be checked by the test of 4.7.201.5.</p> <p>The tests shall be carried out on parts of non-metallic material which have been removed from the apparatus. When the glow-wire test is carried out, the parts shall be placed in the same orientation as they would be in normal use.</p> <p>These tests are not carried out on internal wiring.</p> <p><b>4.7.201.2 Testing of non-metallic materials</b></p> <p>Parts of non-metallic material shall be subject to the glow-wire test of AS/NZS 60695.2.11 which shall be carried out at 550°C.</p>	<p>All materials have suitable flame class, no testing required.</p>	<p><b>P</b></p>

IEC 60950-1: 2005													
Clause	Requirement + Test	Result - Remark	Verdict										
4.7.201	<p><b>4.7.201.3 Testing of insulating materials</b></p> <p>Parts of insulating material supporting <b>POTENTIAL IGNITION SOURCES</b> shall be subject to the glow-wire test of AS/NZS 60695.2.11 which shall be carried out at 750°C</p> <p>The test shall also be carried out on other parts of insulating material which are within a distance of 3 mm of the connection.</p> <p>NOTE: Contacts in components such as switch contacts are considered to be connections.</p> <p>For parts which withstand the glow-wire test but produce a flame, other parts above the connection within the envelope of a vertical cylinder having a diameter of 20 mm and a height of 50 mm shall be subjected to the needle-flame test. However, parts shielded by a barrier which meets the needle-flame test shall not be tested.</p> <p>The needle-flame test shall be made in accordance with AS/NZS 60695.11.5 with the following modifications:</p> <table border="1" style="width: 100%; border-collapse: collapse;"> <thead> <tr> <th style="width: 30%;">Clause of AS/NZS 60695.11.5</th> <th>Change</th> </tr> </thead> <tbody> <tr> <td>9 Test procedure</td> <td></td> </tr> <tr> <td>9.2 Application of needle flame</td> <td> <p><i>Replace</i> the first paragraph with:</p> <p>The specimen shall be arranged so that the flame can be applied to a vertical or horizontal edge as shown in the examples of figure 1. If possible the flame shall be applied at least 10 mm from a corner</p> <p><i>Replace</i> the second paragraph with:</p> <p>The duration of application of the test flame shall be 30 s ±1 s.</p> </td> </tr> <tr> <td>9.3 Number of test specimens</td> <td> <p><i>Replace</i> with:</p> <p>The test shall be made on one specimen. If the specimen does not withstand the test, the test may be repeated on two further specimens, both of which shall withstand the test.</p> </td> </tr> <tr> <td>11 Evaluation of test results</td> <td> <p><i>Replace</i> with:</p> <p>The duration of burning (<math>t_b</math>) shall not exceed 30 s. However, for printed circuit boards, it shall not exceed 15 s.</p> </td> </tr> </tbody> </table> <p>The needle-flame test shall not be carried out on parts of material classified as V-0 or V-1 according to AS/NZS 60695.11.10, provided that the sample tested was not thicker than the relevant part.</p>	Clause of AS/NZS 60695.11.5	Change	9 Test procedure		9.2 Application of needle flame	<p><i>Replace</i> the first paragraph with:</p> <p>The specimen shall be arranged so that the flame can be applied to a vertical or horizontal edge as shown in the examples of figure 1. If possible the flame shall be applied at least 10 mm from a corner</p> <p><i>Replace</i> the second paragraph with:</p> <p>The duration of application of the test flame shall be 30 s ±1 s.</p>	9.3 Number of test specimens	<p><i>Replace</i> with:</p> <p>The test shall be made on one specimen. If the specimen does not withstand the test, the test may be repeated on two further specimens, both of which shall withstand the test.</p>	11 Evaluation of test results	<p><i>Replace</i> with:</p> <p>The duration of burning (<math>t_b</math>) shall not exceed 30 s. However, for printed circuit boards, it shall not exceed 15 s.</p>	<p>All materials have suitable flame class, no testing required.</p>	<p><b>P</b></p>
Clause of AS/NZS 60695.11.5	Change												
9 Test procedure													
9.2 Application of needle flame	<p><i>Replace</i> the first paragraph with:</p> <p>The specimen shall be arranged so that the flame can be applied to a vertical or horizontal edge as shown in the examples of figure 1. If possible the flame shall be applied at least 10 mm from a corner</p> <p><i>Replace</i> the second paragraph with:</p> <p>The duration of application of the test flame shall be 30 s ±1 s.</p>												
9.3 Number of test specimens	<p><i>Replace</i> with:</p> <p>The test shall be made on one specimen. If the specimen does not withstand the test, the test may be repeated on two further specimens, both of which shall withstand the test.</p>												
11 Evaluation of test results	<p><i>Replace</i> with:</p> <p>The duration of burning (<math>t_b</math>) shall not exceed 30 s. However, for printed circuit boards, it shall not exceed 15 s.</p>												

IEC 60950-1: 2005			
Clause	Requirement + Test	Result - Remark	Verdict
4.7.201	<p><b>4.7.201.4 Testing in the event of non-extinguishing material</b></p> <p>If parts, other than enclosures, do not withstand the glow wire tests of 4.7.201.3, by failure to extinguish within 30 s after the removal of the glowwire tip, the needle-flame test detailed in 4.7.201.3 shall be made on all parts of non-metallic material which are within a distance of 50 mm or which are likely to be impinged upon by flame during the tests of 4.7.201.3. Parts shielded by a separate barrier which meets the needle-flame test need not be tested.</p> <p>NOTE 1 If the enclosure does not withstand the glow-wire test the equipment is considered to have failed to meet the requirements of Clause 4.7.201 without the need for consequential testing.</p> <p>NOTE 2 If other parts do not withstand the glow-wire test due to ignition of the tissue paper and if this indicates that burning or glowing particles can fall onto an external surface underneath the equipment, the equipment is considered to have failed to meet the requirements of Clause 4.7.201 without the need for consequential testing.</p> <p>NOTE 3 Parts likely to be impinged upon by the flame are considered to be those within the envelope of a vertical cylinder having a radius of 10 mm and a height equal to the height of the flame, positioned above the point of the material supporting, in contact with, or in close proximity to, connections.</p>	<p>All materials have suitable flame class, no testing required.</p>	<b>P</b>

IEC 60950-1: 2005			
Clause	Requirement + Test	Result - Remark	Verdict
4.7.201	<p><b>4.7.201.5 Testing of printed boards</b></p> <p>The base material of printed boards shall be subjected to the needle-flame test of Clause 4.7.201.3. The flame shall be applied to the edge of the board where the heat sink effect is lowest when the board is positioned as in normal use. The flame shall not be applied to an edge, consisting of broken perforations, unless the edge is less than 3 mm from a <b>POTENTIAL IGNITION SOURCE</b>.</p> <p>The test is not carried out if the –</p> <ul style="list-style-type: none"> <li>- Printed board does not carry any <b>POTENTIAL IGNITION SOURCE</b>;</li> <li>- Base material of printed boards, on which the available apparent power at a connection exceeds 15 VA operating at a voltage exceeding 50 V and equal or less than 400 V (peak) a.c. or d.c. under normal operating conditions, is of flammability category V-1 or better according to AS/NZS 60695.11.10, or the printed boards are protected by an enclosure meeting the flammability category V-0 according to AS/NZS 60695.11.10, or made of metal, having openings only for connecting wires which fill the openings completely; or</li> <li>- Base material of printed boards, on which the available apparent power at a connection exceeds 15 VA operating at a voltage exceeding 400 V (peak) a.c. or d.c. under normal operating conditions, and base material of printed boards supporting spark gaps which provides protection against overvoltages, is of flammability category V-0 according to AS/NZS 60695.11.10 or the printed boards are contained in a metal enclosure, having openings only for connecting wires which fill the openings completely.</li> </ul> <p>Compliance shall be determined using the smallest thickness of the material.</p> <p>NOTE: Available apparent power is the maximum apparent power which can be drawn from the supplying circuit through a resistive load whose value is chosen to maximise the apparent power from more than 2 min when the circuit supplied is disconnected.</p>	<p>All materials have suitable flame class, no testing required.</p>	<b>P</b>
6.2.2	<p>For Australia only, <i>delete</i> the first paragraph and Note, and replace with</p> <p>the following:</p> <p>In Australia only, compliance with 6.2.2 shall be checked by the tests of both 6.2.2.1 and 6.2.2.2.</p>	<p>No TNV circuits in the equipment.</p>	<b>N/A</b>





IEC 60950-1: 2005			
Clause	Requirement + Test	Result - Remark	Verdict
6.2.2.1	<p>For Australia only, <i>delete</i> the first paragraph including the Notes, and <i>replace</i> with the following:</p> <p>In Australia only, the electrical separation is subjected to 10 impulses of alternating polarity, using the impulse test generator reference 1 of Table N.1. The interval between successive impulses is 60 s and the initial voltage, <math>U_c</math>, is:</p> <p>(i) for 6.2.1 a): 7.0 kV for hand-held telephones and for headsets and 2.5 kV for other equipment; and</p> <p>(ii) for 6.2.1 b) and 6.2.1 c): 1.5 kV.</p> <p>NOTE 201 The 7 kV impulse simulates lightning surges on typical rural and semi-rural network lines.</p> <p>NOTE 202 The value of 2.5 kV for 6.2.1 a) was chosen to ensure the adequacy of the insulation concerned and does not necessarily simulate likely overvoltages.</p>	No TNV circuits in the equipment.	N/A
6.2.2.2	<p>For Australia only, <i>delete</i> the second paragraph including the Note, and <i>replace</i> with the following:</p> <p>In Australia only, the a.c. test voltage is:</p> <p>(i) for 6.2.1 a): 3 kV; and</p> <p>(ii) for 6.2.1 b) and 6.2.1 c): 1.5 kV.</p> <p>NOTE 201 Where there are capacitors across the insulation under test, it is recommended that d.c. test voltages are used.</p> <p>NOTE 202 The 3 kV and 1.5 kV values have been determined considering the low frequency induced voltages from the power supply distribution system.</p>	No TNV circuits in the equipment.	N/A
7.3	<p><i>Add</i> the following before the first paragraph:</p> <p>Equipment providing functions that fall only within the scope of AS/NZS 60065 and that incorporate a PSTN interface, are not required to comply with this Clause where the only ports provided on the equipment, in addition to a coaxial cable connection and a PSTN interface, are audio or video ports and analogue or data ports not intended to be used for telecommunications purposes.</p>	Not connected to coaxial cable.	N/A
Annex P	<p><i>Add</i> the following Normative References:</p> <p>AS/NZS 3191, Electric flexible cords</p> <p>AS/NZS 3112, Approval and test specification—Plugs and socket-outlets</p>	Considered.	P

IEC 60950-1: 2005			
Clause	Requirement + Test	Result - Remark	Verdict
Index	<p>1. <i>Insert</i> the following between 'asbestos, not to be used as insulation' and 'attitude see orientation':</p> <p>AS/NZS 2211.1.....4.3.13.5</p> <p>AS/NZS 3112.....4.3.6</p> <p>AS/NZS 3191..... 3.2.5.1 (Table 3B)</p> <p>AS/NZS 60064.....4.1.201</p> <p>AS/NZS 60695.2.11..... 4.7.201.2, 4.7.201.3</p> <p>AS/NZS 60695.11.10..... 4.7.201.1, 4.7.201.5</p> <p>AS/NZS 60695.11.5.....4.7.201.3</p> <p>2. Insert the following between 'positive temperature coefficient (PTC) device' and 'powder':</p> <p>potential ignition source ..... 1.2.201, 4.7.201.3, 4.7.201.5</p>	<p>Considered.</p>	<p>P</p>



IEC 60950-1: 2005			
Clause	Requirement + Test	Result - Remark	Verdict

<p align="center"><b>ATTACHMENT TO TEST REPORT IEC 60950-1</b>  <b>CHINA NATIONAL DIFFERENCES</b>                      Information technology equipment Safety – Part 1: General requirements</p>	
<b>Differences according to.....</b>	GB 4943.1--2011
<b>Attachment Form No.....</b>	CN_ND_IEC60950_1A
<b>Attachment Originator .....</b>	CQC-TIRT
<b>Master Attachment.....</b>	Date 2012-11
<p><b>Copyright © 2012 IEC System for Conformity Testing and Certification of Electrical Equipment (IECEE), Geneva, Switzerland. All rights reserved.</b></p>	

China National Differences			
1.5. 2	Add a note behind the first dashed paragraph. Note: A component used shall comply with related requirements corresponding altitude of 5000m.	Considered.	<b>P</b>
1.7	Add a paragraph before the last paragraph: The required marking and instruction should be given in normative Chinese unless otherwise specified.	Must be checked when marketing into China.	—
1.7.1	Amend dashed paragraph at the fifth paragraph : The RATED VOLTAGE should be 220V (single phase) or 380V (three-phases) for single rated voltage, for RATED VOLTAGE RANGE, it should cover 220V or 380V (three-phases), for multiple RATED VOLTAGES, one of them should be 220V or 380V (three-phases) and set on 220V or 380V (three-phases) when manufactured. And the RATED FREQUENCY or RATED FREQUENCY RANGE should be 50Hz or include 50Hz.	The single phase input rating 100-240V~ 50/60Hz is considered that cover the 220V 50Hz.	<b>P</b>
1.7.2.1	Add requirements of warning for equipment intended to be used at altitude not exceeding 2000m or at non-tropical climate regions: For equipment intended to be used at altitude not exceeding 2000m, a warning label containing the following or a similar appropriate wording, or a symbol as in annex DD shall fixed to the equipment at readily visible place. "Only used at altitude not exceeding 2000m."  For equipment intended to be used in not-tropical climate regions, a warning label containing the following or a similar appropriate wording, or a symbol as in annex DD shall fixed to the equipment at readily visible place. "Only used in not-tropical climate regions."  If only the symbol used, the explanation of the symbol shall be contained in the instruction manual. The above statements shall be given in a language acceptable to the regions where the apparatus is intended to be used.	Must be checked when marketing into China.	—

IEC 60950-1: 2005			
Clause	Requirement + Test	Result - Remark	Verdict
2.7.1	Amended the first paragraph as: Protection in PRIMARY CIRCUITS against overcurrent short-circuits and earth faults shall be provided as an integral part of the equipment except special provisions. And the protective device shall meet the requirement of Clause 5.3. Delete note of Clause 2.7.1.	Considered.	P
2.9.2	First section of Clause 2.9.2 amended as two sections: Where required by 2.9.1, 2.10.8.3, 2.10.10 or 2.10.11, humidity conditioning is conducted for 120 h in a cabinet or room containing air with ambient temperature 40±2°C and a relative humidity of (93±3)%. During this conditioning the component or subassembly is not energized. For equipment not to be operated at tropical climatic conditions, Where required by 2.9.1, 2.10.8.3, 2.10.10 or 2.10.11, humidity conditioning is conducted for 48 h in a cabinet or room containing air with a relative humidity of (93±3) %. The temperature of the air, at all places where samples can be located, is maintained within 2 °C of any convenient value between 20 °C and 30 °C such that condensation does not occur. Due to pretreatment of equipment operated at high altitude area is humidity conditioning withstand hot shock, specific requirements are to be considered.  Add note: For equipment to be operated at 2000 m - 5000m above sea level, assessment and requirement of humidity conditioning for Insulation material properties are considered.	The test performed with relative humidity 93%, temperature 40°C for 120h, refer to main test report.	P
2.10.3.1	Amend the third paragraph of Clause 2.10.3.1 to be: These requirements apply for equipment to be operated up to 2000 m above sea level. For equipment to be operated at more than 2000 m above sea level and up to 5000m above sea level, the minimum CLEARANCE shall be multiplied by the factor 1.48 corresponding altitude of 5000m given in Table A.2 of IEC 60664-1. For equipment to be operated at more than 5000 m above sea level, the minimum CLEARANCE shall be multiplied by the factor given in Table A.2 of IEC 60664-1. Linear interpolation is permitted between the nearest two points in Table A.2. The calculated minimum CLEARANCE using this multiplication factor shall be rounded up to the next higher 0,1 mm increment.	Considered. Refer to main test report.	P
2.10.3.3& 2.10.3.4	Add "(applicable for altitude up to 2000m)" in header of Table 2K \ 2L and 2M.	Considered.	P

IEC 60950-1: 2005			
Clause	Requirement + Test	Result - Remark	Verdict
2.10.3.4	Add a new section above Table 2K and in Clause 2.10.3.4: Minimum CLEARANCES determined by above rules apply for equipment to be operated up to 2000m above sea level. For equipment operated at 2000 m - 5000m above sea level, the minimum CLEARANCE shall be multiplied by the factor 1.48 corresponding altitude of 5000m given in Table A.2 of GB/T16935.1 ( IEC 60664-1) . For equipment to be operated at more than 5000 m above sea level, the minimum CLEARANCE shall be multiplied by the factor given in Table A.2 of GB/T16935.1.	This equipment is intended to be operated under altitude up to 5,000m, so the clearance is multiplied by the altitude correction factor (1.48), specified in table A.2 of IEC 60664-1, 1992+A1: 2000.	<b>P</b>
3.2.1.1	Add a paragraph before the last paragraph: Plugs connected to AC mains supply shall comply with GB 1002 or GB 1003 or GB/T 11918 as applicable.	Refer to Summary of testing in main test report.	<b>N/A</b>
4.2.8	Clause 4.2.8 cathode ray tubes quoted Clause 18 of GB8898-2011. Delete note of Clause 4.2.8.	No such parts.	<b>N/A</b>
Annex E	Amend last section: For comparison of winding temperatures determined by the resistance method of this annex with the temperature limits of Table 4B, 35 °C shall be added to the calculated temperature rise. Add note: for equipment not to be operated at tropical climatic conditions, 25 °C shall be added to the calculated temperature rise to compare with the temperature of Table 4B.	Not used.	<b>N/A</b>
Annex G.6	Change the second section of Clause G.6 to be: For equipment to be operated at 2000 m - 5000m above sea level, the minimum CLEARANCE shall be multiplied by the factor 1.48 corresponding altitude of 5000m given in Table A.2 of GB/T16935.1. For equipment to be operated at more than 5000 m above sea level, the minimum CLEARANCE shall be multiplied by the factor given in Table A.2 of IEC 60664-1. Linear interpolation is permitted between the nearest two points in Table A.2. The calculated minimum CLEARANCE using this multiplication factor shall be rounded up to the next higher 0,1 mm increment.	Not used.	<b>N/A</b>

IEC 60950-1: 2005			
Clause	Requirement + Test	Result - Remark	Verdict
Annex DD (normative)	<p>Added annex DD: Instructions for the new safety warning labels.</p> <p> DD.1 Altitude warning label Meaning of the label: Evaluation for apparatus only based on altitude not exceeding 2000m, therefore it's the only operating condition applied for the equipment .There may be some potential safety hazard if the equipment is used at altitude above 2000m.</p> <p> DD.2 Climate warning label Meaning of the label: Evaluation for apparatus only based on temperate climate condition, therefor it's the only operating condition applied for the equipment .There may be some potential safety hazard if the equipment is used in tropical climate region.</p>	Must be checked when marketing into China.	—
Annex EE (informative)	Added annex EE: Illustration relative to safety explanation in normative Chinese 、 Tibetan 、 Mongolian 、 Zhuang Language and Uighur.	Must be checked when marketing into China.	—

<b>Special national conditions</b>			
1.1.2	GB4943.1-2011 applies to equipment used at altitudes not exceeding 5000m above sea level, primarily in regions with moderate or tropical climates. Revise the third dashed paragraph of 1.1.2 as: ——equipment intended to be used in vehicles, on board ships or aircraft, at altitudes greater than 5000m;	Considered.	P
1.4.5	Amend the second paragraph by the following: If the equipment is intended for direct connection to an AC mains supply, the tolerances on RATED VOLTAGE shall be taken as +10% and -10%.	Considered. Test conducted at input voltage 100-240V 50/60Hz with +/-10% tolerance.	P
1.4.12.1	Tma: The maximum ambient temperature permitted by the manufacturer's specification, or 35 °C, whichever is greater. Add note 1: For equipment not to be operated at tropical climatic conditions, Tma is the maximum ambient temperature permitted by the manufacturer's specification, or 25 °C, whichever is greater. Add note 2: For equipment to be operated at 2000m-5000m above sea level, its temperature test conditions and temperature limits are under consideration.	Considered, refer to main test report.	P

IEC 60950-1: 2005			
Clause	Requirement + Test	Result - Remark	Verdict

**ATTACHMENT: SINGAPORE DIFFERENCES  
to IEC 60950-1 (ed.2)**

No	Item	Requirement	Result - Remark	Verdict
<p>The following is the national differences in accordance with safety authority website <a href="http://www.spring.gov.sg/">www.spring.gov.sg/</a> , ref. Singapore Consumer Protection (Safety Requirements) - Information booklet - chapter 7 (page 20 - 21). Based on information by Singapore NCB – PSB Corp.</p>				
<p><b>7 SAFETY AUTHORITY’S REQUIREMENTS</b></p> <p>The Safety Authority monitors the safety of the controlled goods sold in Singapore by investigating all complaints, incidents and accidents reported to the authority. Experiences gained are translated into the Safety Authority’s Requirements. These requirements are to be fulfilled in addition to the applicable safety standards.</p>				
<p><b>Applicable to all electrical products</b></p>				
3	All appliances	All appliances must be tested to 230 VAC, 50 Hz.	Tested cover the range 230V, 50Hz	P
4	Voltage selector (voltage mis-match test)	Appliance fitted with voltage selector shall be tested as follows: Connect appliance to 230 VAC mains with voltage selector switch to settings not suitable for operation at 230 VAC	No voltage selector	N/A
5	Tropical condition test	All appliances (with tropical test requirements in applicable Standards) shall comply with the tropical condition test as stated in the relevant IEC Standards.	Test performed, see main test report.	P
6	Class I appliances (3-pin mains plug)	All Class I appliances must be fitted with 3-pin mains plugs complied with SS 145 /SS 472 that are registered with the Safety Authority.	Refer to Summary Of Testing in main test report.	N/A
7	Class II appliances (mains plug)	a) All Class II appliances must be fitted with 2-pin mains plug (Appendix T) complied with EN 50075. b) Class II appliances that are fitted with 3-pin mains plugs must use plugs that are complied with SS 145 and registered with the Safety Authority.	Class I equipment.	N/A
8	Appliances rated ≥ 3 kW or connected to fixed wiring	Electric appliance ≥ 3 kW must be connected to fixed wiring. All connection to fixed wiring must be in accordance with Code of Practice CP5.	Rating is <3kW	N/A

IEC 60950-1: 2005			
Clause	Requirement + Test	Result - Remark	Verdict

No	Item	Requirement	Result - Remark	Verdict
9	Detachable power cord set (consists of mains plug, mains cord and appliance connector)	Detachable power cord set must be listed in the test report critical component list.	Refer to Summary Of Testing in main test report.	N/A
10	Circuit diagrams	Circuit diagrams must be indicated with component's values for products tested to IEC 60065 and IEC 60950.	Refer to Summary Of Testing in main test report.	N/A
11	Circuit diagrams of electronic modules in electrical appliances	Circuit diagrams of the electronic modules in the electrical appliances must be provided.	Must be considered when marketing in Singapore.	—
12	Controlled goods likely to be treated as toy by children	Controlled goods, having an enclosure, which is shaped and decorated so that it is likely to be treated as a toy by children, shall not be accepted for certification and registration.	The shape and function are not considered as toy.	N/A
13	Controlled goods with rated voltage that are not suitable for local supply voltage	a) Controlled goods with rated voltage that are not suitable for local supply voltage will not be allowed for registration unless they are supplied with step-down isolating transformer and are tested together with the transformer as a complete set. b) A test to ensure that the controlled goods shut-down/fail safely should the consumer accidentally plugs the product directly into the 230 V mains supply socket outlet without using the isolating stepdown transformer shall be conducted.	Considered.	P
<b>Applicable to AC adaptor</b>				
15	3-pin AC adaptor (Appendix U)	Test report showing that the 3-pin complied with sub-clauses 12.1 & 12.3 of SS 246 must be submitted.	Not a Direct Plug-in Equipment.	N/A
16	2-pin AC adaptor (Appendix U)	The 2-pin (Appendix T) shall comply with EN 50075.	Not a Direct Plug-in Equipment.	N/A
17	Detachable power supply cord set not supplied by Registered Supplier	a) Registered Supplier who is not supplying the detachable power supply cord set together with the AC Adaptor must provide written instruction to its customer on the type of approved detachable power cord set to use and declare to Conformity Assessment Body when applying for Certificate of Conformity. b) This requirement is only applicable to Register Supplier whose core business is supplying AC Adaptor or its Registered Supplier name is affiliated	No cord-set supplied.	N/A



IEC 60950-1: 2005			
Clause	Requirement + Test	Result - Remark	Verdict
		with the AC Adaptor's manufacturer.	
18	AC Adaptor incorporated with 13A socket-outlet	Additional tests clauses to 13, 17 and 18 of SS 246 would be required.	No cord-set supplied. N/A
<b>Applicable to computer products</b>			
19	CD/DVD ROM (used in personal computer)	Test certificate showing that CD/DVD ROM has complied with IEC 60825-1 must be provided.	Not used. N/A
20	Modem Card (used in personal computer)	Modem card incorporated in the personal computer must be tested at set level (sub-clauses 5.1 & 6 of IEC 60950) or at component level.	Not used. N/A
21	Powerline Ethernet Adaptor incorporated with 13A socket-outlet	Additional tests to clauses 13, 17 and 18 of SS 246 would be required.	Not used. N/A
<b>Applicable to plasma/LCD display monitor computer products</b>			
42	Plasma/LCD display monitor with TV tuner	Plasma/LCD display monitor tested to IEC 60950 would require additional test to clauses 9 (related to antenna only), 10.1, 10.2, 10.3 and 12.5 of IEC 60065.	No TV tuner provided. N/A

IEC 60950-1 ATTACHMENT			
Clause	Requirement + Test	Result - Remark	Verdict

<b>ATTACHMENT TO TEST REPORT IEC 60950-1</b> <b>JAPAN NATIONAL DIFFERENCES</b> Information technology equipment – Safety – Part 1: General requirements			
<b>Differences according to.....:</b> J60950-1(H22)			
<b>Attachment Form No.....:</b> JP_ND_IEC60950_1A			
<b>Attachment Originator .....</b>			
<b>Master Attachment.....:</b> 2010-11			
<b>Copyright © 2010 IEC System for Conformity Testing and Certification of Electrical Equipment (IECEE), Geneva, Switzerland. All rights reserved.</b>			

National Differences - Japan			
1.2.4.1	Add the following new NOTE.  NOTE Even if the equipment is designed as Class I, the equipment is regarded as Class 0I equipment when a 2-pin adaptor with an earthing lead wire or a cord set having a 2-pin plug with an earthing lead wire is provided or recommended.	Must be considered before marketed in Japan.	—
1.2.4.3A	Add the following new clause.  1.2.4.3A CLASS 0I EQUIPMENT Equipment having attachment plug without earthing blade, where protection against electric shock is achieved by: <ul style="list-style-type: none"> <li>- using BASIC INSULATION, and</li> <li>- providing externally an earth terminal or a lead wire for earthing in order to connect those conductive parts that might assume a HAZARDOUS VOLTAGES in the event of BASIC INSULATION fault to the PROTECTIVE EARTHING CONDUCTOR in the building wiring.</li> </ul> NOTE Class 0I equipment may have a part constructed with Double Insulation or Reinforced Insulation. circuit.	Must be considered before marketed in Japan.	—

IEC 60950-1 ATTACHMENT			
Clause	Requirement + Test	Result - Remark	Verdict
1.3.2	<p>Add the following notes after the first paragraph:</p> <p>NOTE 1 Transportable or similar equipment that is relocated frequently for intended usage should not be designed as Class I or Class 0I equipment unless it is intended to be installed by service personnel.</p> <p>NOTE 2 Considering wiring circumstance in Japan, equipment intended to be installed where the provision for earthing connection is unlikely should not be designed as Class I or Class 0I equipment unless it is intended to be installed by service personnel.</p>	<p>Must be considered before marketed in Japan.</p>	—
1.5.1	<p>Replace the first paragraph with the following:</p> <p>Where safety is involved, components shall comply either with the requirements of this standard or with the safety aspects of the relevant JIS component standard or IEC component standards in case there is no applicable JIS component standard is available. However, in case a component that falls within the scope of the METI Ministerial ordinance (No. 85:1962) is properly used in accordance with its marked ratings, the requirements of 1.5.4, 2.8.7 and 3.2.5 apply, and in addition, a cord connector of power supply cord set matching with an appliance inlet specified in the standard sheets of IEC 60320-1, shall comply with relevant standard sheet of IEC 60320-1.</p> <p>Replace NOTE 1 with the following:</p> <p>NOTE 1 A JIS or an IEC component standard is considered relevant only if the component in question clearly falls within its scope.</p>	<p>Critical components are IEC certified. See list of critical components in main CB report (§1.5.1). There may be additional requirements for components in Japan.</p>	P

<b>IEC 60950-1 ATTACHMENT</b>			
Clause	Requirement + Test	Result - Remark	Verdict
1.5.2	<p>Replace the first sentence in the first dashed paragraph with the following:</p> <ul style="list-style-type: none"> <li>- a component that has been demonstrated to comply with a JIS component standard harmonized with the relevant IEC component standard, or where such JIS component standard is not available, a component that has been demonstrated to comply with the relevant IEC component standard shall be checked for correct application and use in accordance with its rating.</li> </ul> <p>Add a NOTE after the first dashed paragraph as follows:</p> <p>NOTE 1 See 1.7.5A when Type C.14 appliance coupler rated 10 A per IEC 60320-1 is used with an equipment rated not more than 125 V and rated more than 10 A.</p> <p>Replace the first sentence in the third dashed paragraph as follows:</p> <ul style="list-style-type: none"> <li>- where no relevant IEC component standard or JIS component standard harmonized with the relevant IEC component standard exists, or where components are used in circuits not in accordance with their specified rating, the components shall be tested under the conditions occurring in the equipment.</li> </ul>	Considered.	<b>P</b>
1.5.6	In this sub-clause, add “JIS C 5101-14:1998 or” before the reference number, IEC 60384-14:1993.	Considered.	<b>P</b>
1.5.7.2	In this sub-clause, add “JIS C 5101-14:1998 or” before the reference number, IEC 60384-14:1993.	No such part.	<b>N/A</b>
1.5.8	In the first paragraph, add “JIS C 5101-14:1998 or” before the reference number, IEC 60384-14:1993.	Considered.	<b>P</b>
1.7.1	<p>Replace the fifth dashed paragraph with the following:</p> <ul style="list-style-type: none"> <li>- manufacturer's or responsible company's name or trade-mark or identification mark;</li> </ul>	Must be considered when marketed in Japan.	—
1.7.5	In the second paragraph, add “or JIS C 8303:2007” after the reference number, IEC/TR 60083:1997”.	No such part.	<b>N/A</b>

<b>IEC 60950-1 ATTACHMENT</b>			
Clause	Requirement + Test	Result - Remark	Verdict
1.7.5A	<p>Add the following new clause after 1.7.5</p> <p>1.7.5A Appliance Couplers</p> <p>If an appliance coupler according to IEC 60320-1, C.14(rated current: 10 A) is used in equipment whose rated voltage is less than 125 V and the rated current is over 10 A, the following instruction or equivalent shall be described in the user instruction.</p> <p>“ Use only designated cord set attached in this equipment”</p>	Refer to Summary Of Testing in main test report.	<b>N/A</b>
1.7.12	<p>Replace first sentence with the following:</p> <p>Instructions and equipment marking related to safety shall be in Japanese.</p>	Must be considered when marketed in Japan.	—
1.7.17A	<p>Add the following new clause after 1.7.17</p> <p>1.7.17A Marking for CLASS 0I EQUIPMENT</p> <p>For CLASS 0I EQUIPMENT, the following instruction shall be marked on the visible place of the mains plug or the main body:</p> <p>必ず接地接続を行って下さい “Provide an earthing connection”</p> <p>Moreover, for CLASS 0I EQUIPMENT, the following or equivalent instruction shall be indicated on the visible place of the main body or written in the operating instructions:</p> <p>接地接続は必ず、電源プラグを電源につなぐ前に行って下さい。又、接地接続を外す場合は、必ず電源プラグを電源から切り離してから行って下さい。 “Provide an earthing connection before the mains plug is connected to the mains. And, when disconnecting the earthing connection, be sure to disconnect after pulling out the mains plug from the mains.”</p>	Must be considered before marketed in Japan.	<b>N/A</b>
2.1.1.1	In item b) of this sub-clause, replace “IEC 60083” with “JIS C 8303:2007 or Article 1 of the Ministerial Ordinance (No. 85:1962)”	Considered	<b>P</b>
2.6.3.2	<p>Add the following after the first paragraph.</p> <p>This also applies to the conductor of lead wire for protective earthing of CLASS 0I EQUIPMENT.</p>	Must be considered before marketed in Japan.	—

<b>IEC 60950-1 ATTACHMENT</b>			
Clause	Requirement + Test	Result - Remark	Verdict
2.6.4.2	<p>Replace the first paragraph with the following.</p> <p>Equipment required to have protective earthing shall have a main protective earthing terminal. For equipment with a DETACHABLE POWER SUPPLY CORD, the earthing terminal in the appliance inlet is regarded as the main protective earthing terminal except for CLASS 0I EQUIPMENT providing separate main protective earthing terminal other than appliance inlet.</p>	Must be considered before marketed in Japan.	—
2.6.5.4	<p>Replace the first sentence with the following.</p> <p>Protective earthing connections of CLASS I EQUIPMENT shall make earlier and break later than the supply connections in each of the following:</p>	Considered.	<b>P</b>
2.6.5.8A	<p>Add the following new clause after 2.6.5.8</p> <p>2.6.5.8A Earthing of CLASS 0I EQUIPMENT Plugs with a lead wire for earthing shall not be used for equipment having a rated voltage exceeding 150 V. For plugs with a lead wire for earthing, the lead wire shall not be earthed by a clip. CLASS 0I EQUIPMENT shall be provided with an earthing terminal or a lead wire for earthing in the external location where easily visible.</p>	Must be considered before marketed in Japan.	—
2.10.3.1	In this sub-clause, replace IEC 60664-1 with JIS C 0664:2003.	Considered	<b>P</b>
2.10.3.2	In the second paragraph, replace IEC 60664-1 with JIS C 0664:2003.	Considered	<b>P</b>
3.2.3	<p>Add the following after Table 3A:</p> <p>Table 3A applies when cables complying with JIS C 3662 or JIS C 3663 are used. In case of other cables, the cable entries shall be so designed that a conduit suitable for the cable used can be fitted.</p>	The equipment is not intended for permanent connection to the mains.	<b>N/A</b>

<b>IEC 60950-1 ATTACHMENT</b>			
Clause	Requirement + Test	Result - Remark	Verdict
3.2.5.1	<p>Add the following to the last of first dashed paragraph.</p> <p>Or mains cords shall be of the sheathed type complying with Appendix 1 of Article 1 of the Ministerial Ordinance (No. 85:1962) on stipulating technical requirements for the Electrical Appliance.</p> <p>Add the following to the last of second dashed paragraph.</p> <p>Or mains cords shall be of the sheathed type complying with Appendix 1 of Article 1 of the Ministerial Ordinance (No. 85:1962) on stipulating technical requirements for the Electrical Appliance.</p> <p>Delete 1) in Table 3B.</p>	Refer to Summary Of Testing in main test report.	<b>N/A</b>
3.3.4	<p>Add the following note to Table 3D:</p> <p>NOTE For cables other than those complying with JIS C 3662 or JIS C 3663, terminals shall be suitable for the size of the intended cables.</p>	The equipment is provided with an appliance inlet.	<b>N/A</b>
3.3.7	<p>Add the following after the first sentence:</p> <p>This requirement is not applicable to the external earthing terminal of Class 0I equipment.</p>	The equipment is provided with an appliance inlet.	<b>N/A</b>
4.3.4	<p>Add the following after the first sentence:</p> <p>This requirement also applies to those connections in Class 0I equipment, where CLEARANCE or CREEPAGE DISTANCES over BASIC INSULATION would be reduced to less than the values specified in 2.10.</p>	Considered	<b>P</b>
4.3.13.5	<p>Replace the first paragraph with the following:</p> <p>Except as permitted below, equipment shall be classified and labelled according to JIS C 6802:2005, and JIS C 6803:2006 or IEC 60825-2:2000, as applicable.</p> <p>Replace IEC 60825-1 in the second and the last paragraph with JIS C 6802:2005.</p>	No Laser and LED is diffusive type.	<b>N/A</b>

IEC 60950-1 ATTACHMENT																															
Clause	Requirement + Test	Result - Remark	Verdict																												
4.5	<p>Add the following NOTE to Table 4B, 3):</p> <p>NOTE: In case no data for the material is available, Appendix 4, 4. (1). b. 3 of the Interpretation on the Ministerial Ordinance stipulating Technical Specifications for Electrical Appliances (Commerce and Distribution Policy Group No. 3:2008/06/19) may apply.</p>	Considered.	P																												
5.1.3	<p>Add a note after the first paragraph as follows:</p> <p>NOTE Attention should be drawn to that majority of three-phase power system in Japan is of delta connection, and therefore, in that case, the test is conducted using the test circuit from IEC 60990, figure 13.</p>	Single phase only.	N/A																												
5.1.6	<p>Replace Table 5A as follows:</p> <table border="1" data-bbox="424 1043 1337 1760"> <thead> <tr> <th>Type of equipment</th> <th>Terminal A of measuring instrument connected to:</th> <th>Maximum TOUCH CURRENT mA r.m.s. <sup>1)</sup></th> <th>Maximum PROTECTIVE CONDUCTOR CURRENT</th> </tr> </thead> <tbody> <tr> <td>All equipment</td> <td>Accessible parts and circuits not connected to protective earth</td> <td>0,25</td> <td>-</td> </tr> <tr> <td>HAND-HELD</td> <td rowspan="4">Equipment main protective earthing terminal (if any) CLASS I EQUIPMENT</td> <td>0,75</td> <td>-</td> </tr> <tr> <td>MOVABLE (other than HAND-HELD, but including TRANSPORTABLE EQUIPMENT</td> <td>3,5</td> <td>-</td> </tr> <tr> <td>STATIONARY, PLUGGABLE TYPE A</td> <td>3,5</td> <td>-</td> </tr> <tr> <td>All other STATIONARY EQUIPMENT - not subject to the conditions of 5.1.7 - subject to the conditions of 5.1.7</td> <td>3,5 -</td> <td>- 5 % of input current</td> </tr> <tr> <td>HAND-HELD</td> <td rowspan="2">Equipment main protective earthing terminal (if any) CLASS 0I EQUIPMENT</td> <td>0,5</td> <td>-</td> </tr> <tr> <td>Others</td> <td>1,0</td> <td>-</td> </tr> </tbody> </table> <p><sup>1)</sup> If peak values of TOUCH-CURRENT are measured, the maximum values obtained by multiplying the r.m.s. values by 1,414.</p>	Type of equipment	Terminal A of measuring instrument connected to:	Maximum TOUCH CURRENT mA r.m.s. <sup>1)</sup>	Maximum PROTECTIVE CONDUCTOR CURRENT	All equipment	Accessible parts and circuits not connected to protective earth	0,25	-	HAND-HELD	Equipment main protective earthing terminal (if any) CLASS I EQUIPMENT	0,75	-	MOVABLE (other than HAND-HELD, but including TRANSPORTABLE EQUIPMENT	3,5	-	STATIONARY, PLUGGABLE TYPE A	3,5	-	All other STATIONARY EQUIPMENT - not subject to the conditions of 5.1.7 - subject to the conditions of 5.1.7	3,5 -	- 5 % of input current	HAND-HELD	Equipment main protective earthing terminal (if any) CLASS 0I EQUIPMENT	0,5	-	Others	1,0	-		P
Type of equipment	Terminal A of measuring instrument connected to:	Maximum TOUCH CURRENT mA r.m.s. <sup>1)</sup>	Maximum PROTECTIVE CONDUCTOR CURRENT																												
All equipment	Accessible parts and circuits not connected to protective earth	0,25	-																												
HAND-HELD	Equipment main protective earthing terminal (if any) CLASS I EQUIPMENT	0,75	-																												
MOVABLE (other than HAND-HELD, but including TRANSPORTABLE EQUIPMENT		3,5	-																												
STATIONARY, PLUGGABLE TYPE A		3,5	-																												
All other STATIONARY EQUIPMENT - not subject to the conditions of 5.1.7 - subject to the conditions of 5.1.7		3,5 -	- 5 % of input current																												
HAND-HELD	Equipment main protective earthing terminal (if any) CLASS 0I EQUIPMENT	0,5	-																												
Others		1,0	-																												
6	Replace IEC 60664-1 in NOTE 4 with JIS C 0664.	Not TNV circuit.	N/A																												
7	Replace IEC 60664-1 in NOTE 3 with JIS C 0664:2003.	Not cable distribution systems.	N/A																												



<b>IEC 60950-1 ATTACHMENT</b>			
Clause	Requirement + Test	Result - Remark	Verdict
7.2	<p>Add the following after the paragraph:</p> <p>However, the separation requirements and tests of 6.2.1 a), b) and c) do not apply to a CABLE DISTRIBUTION SYSTEM if all of the following apply:</p> <ul style="list-style-type: none"> <li>- the circuit under consideration is a TNV-1 CIRCUIT; and</li> <li>- the common or earthed side of the circuit is connected to the screen of the coaxial cable and to all accessible parts and circuits (SELV, accessible metal parts and LIMITED CURRENT CIRCUITS, if any); and</li> <li>- the screen of the coaxial cable is intended to be connected to earth in the building installation.</li> </ul>	Not connected to cable distribution systems.	<b>N/A</b>
W.1	<p>Replace the second and the third sentence in the first paragraph with the following:</p> <p>This distinction between earthed and unearthed (floating) circuit is not the same as between CLASS I EQUIPMENT, CLASS 0I EQUIPMENT and CLASS II EQUIPMENT. Floating circuits can exist in CLASS I EQUIPMENT or CLASS 0I EQUIPMENT and earthed circuits in CLASS II EQUIPMENT.</p>	Not connected to a telecommunication network.	<b>N/A</b>

IEC 60950-1 ATTACHMENT			
Clause	Requirement + Test	Result - Remark	Verdict
Annex JA	<p>Add a new annex JA with the following contents.</p> <p style="text-align: center;">Annex JA (normative)</p> <p style="text-align: center;">Document shredding machines</p> <p>Document shredding machines shall also comply with the requirements of this annex except those of STATIONARY EQUIPMENT used by connecting directly to an AC MAINS SUPPLY of three-phase 200V or more.</p> <p><b>JA.1 Markings and instructions</b> The symbol</p>  (JIS S 0101:2000, 6.2.4) and the following precautions for use shall be marked on readily visible part adjacent to document feed opening. The marking shall be clearly legible, permanent, and easily discernible; <ul style="list-style-type: none"> <li>- that use by an infants/children may cause a hazard of injury etc.;</li> <li>- that a hand can be drawn into the mechanical section for shredding when touching the document-slot;</li> <li>- that clothing can be drawn into the mechanical section for shredding when touching the document-slot;</li> <li>- that hairs can be drawn into the mechanical section for shredding when touching the document-slot;</li> <li>- in case of equipment incorporating a commutator motor, that equipment may catch fire or explode by spraying of flammable gas.</li> </ul> <p><b>JA.2 Inadvertent reactivation</b> Any safety interlock that can be operated by means of the test finger, Figure JA.1, is considered to be likely to cause inadvertent reactivation of the hazard. Compliance is checked by inspection and, where necessary, by a test with the test finger, Figure JA.1</p> <p><b>JA.3 Disconnection from the mains supply</b> Document shredding machines shall incorporate an isolating switch complying with sub-clause 3.4.2 as the device disconnecting the power of hazardous moving parts. For this switch, two-position (single-use) switch or multi-position (multifunction) switch (e.g., slide switch) may be used.</p>	The equipment is not Document shredding machines.	N/A

<b>IEC 60950-1 ATTACHMENT</b>			
Clause	Requirement + Test	Result - Remark	Verdict
Annex JA	<p>If two-position switch, the positions for "ON" and "OFF" shall be indicated in accordance with sub-clause 1.7.8. If multi-position switch, the position for "OFF" shall be indicated in accordance with sub-clause 1.7.8 and other positions shall be indicated with proper terms or symbols.</p> <p>Compliance is checked by inspection</p> <p><b>JA.4 Protection against hazardous moving parts</b>            Any warning shall not be used instead of the structure for preventing access to hazardous moving parts.            Document shredding machines shall comply with the following requirements.</p> <p>Insert the test finger, Figure JA.1, into all openings in MECHANICAL ENCLOSURES without applying appreciable force. It shall not be possible to touch hazardous moving parts with the test finger. This consideration applies to all sides of MECHANICAL ENCLOSURES when the equipment is mounted as intended. Before testing with the test finger, remove the parts detachable without a tool.</p> <p>Insert the wedge-probe, Figure JA.2, into the document-slot. And, against all directions of openings, if straight-cutting type, a force of 45 N shall apply to the probe, and 90 N if cross-cutting type. In this case, the weight of the probe is to be factored into the overall applied force. Before testing with the wedge-probe, remove the parts detachable without a tool. It shall not be possible to touch any hazardous moving parts, including the shredding roller or the mechanical section for shedding, with the probe.</p>	<p>The equipment is not Document shredding machines.</p>	<b>N/A</b>

IEC 60950-1 ATTACHMENT			
Clause	Requirement + Test	Result - Remark	Verdict

<p>Annex JA</p>	<p style="text-align: center;">Dimensions in millimeters</p>	<p>N/A</p>
-----------------	--	------------

Figure JA.1 Test finger

IEC 60950-1 ATTACHMENT			
Clause	Requirement + Test	Result - Remark	Verdict

Annex JA	<p style="text-align: center;">Diameters in millimeters</p> <p style="text-align: center;">See Note 1</p> <p style="text-align: center;">Diameters in millimeters</p> <p style="text-align: center;">See Note for thickness dimensions</p> <p style="text-align: center;">Rounded to allow rotation about hinge pin (screw) in one direction</p> <p style="text-align: center;">Diameters in millimeters</p> <p>Details of the tip of wedge</p> <table border="1" style="margin-left: auto; margin-right: auto;"> <thead> <tr> <th>Distance from the tip (mm)</th> <th>Thickness of probe (mm)</th> </tr> </thead> <tbody> <tr> <td>0</td> <td>2</td> </tr> <tr> <td>12</td> <td>4</td> </tr> <tr> <td>180</td> <td>24</td> </tr> </tbody> </table> <p>NOTE 1 The thickness of the probe varies linearly, with slope changes at the respective points shown in the table.            NOTE2 The allowable dimensional tolerance of the probe is +/- 0.127 mm.</p> <p style="text-align: center;"><b>Figure JA.2 Wedge-probe</b></p>	Distance from the tip (mm)	Thickness of probe (mm)	0	2	12	4	180	24	N/A
Distance from the tip (mm)	Thickness of probe (mm)									
0	2									
12	4									
180	24									