

TPV Electronics (Fujian) Co., Ltd.
Mr. Xinliang Wu
RD-SE
Rongqiao Economic and
Technological Development Zone
Fuqing City, Fujian Province
P.R. China

Date : 17.05.2017
Our ref. : WangAn ZJ
Your ref.: 1140034085

Ref : CB Certificate Japan

Type of Equipment : LCD MONITOR
Model Designation : See Certificate
Certificate No. : JPTUV-080617
Report No. : 50080564 001

Dear Mr. Xinliang Wu,

Thank you very much for your interest in our services.

Please find enclosed your certification documents.

We appreciate your support and would like to offer our assistance in the approval of your future products through our extensive range of technical services.

Please feel free to contact us whatever your requirements may be.

With kind regards,

Certification Body

Aegean Li



CC: TPV Electronics (Fujian) Co., Ltd.

Enclosure

证书的详细资料请登陆www.certipedia.com查阅,或拨打我司客服热线800 999 3668 / 400 883 1300咨询



Ref. Certif. No.

JPTUV-080617

IEC SYSTEM FOR MUTUAL RECOGNITION OF TEST CERTIFICATES FOR ELECTRICAL EQUIPMENT (IECEE) CB SCHEME

SYSTEME CEI D'ACCEPTATION MUTUELLE DE CERTIFICATS D ESSAIS DES EQUIPEMENTS ELECTRIQUES (IECEE) METHODE OC

CB TEST CERTIFICATE

CERTIFICAT D'ESSAI OC

Product
Produit

LCD MONITOR

Name and address of the applicant
Nom et adresse du demandeur

TPV Electronics (Fujian) Co., Ltd.
Rongqiao Economic and Technological Development Zone, Fuqing City, Fujian Province, P.R. China

Name and address of the manufacturer
Nom et adresse du fabricant

TPV Electronics (Fujian) Co., Ltd.
Rongqiao Economic and Technological Development Zone, Fuqing City, Fujian Province, P.R. China

Name and address of the factory
Nom et adresse de l'usine

See additional page(s)

Ratings and principal characteristics
Valeurs nominales et caractéristiques principales

AC 100-240V; 50/60Hz; 1.5A; Class I

Trademark (if any)
Marque de fabrique (si elle existe)

AOC

Type of Manufacturer's Testing Laboratories used
Type de programme du laboratoire d'essais constructeur

N/A

Model / Type Ref.
Ref. de type

185LM000**, *970SW****, 215LM000**, *2270SW****
195LM000**, *2070SW****
(* = 0-9, A-Z, a-z, +, -, /, \ or blank)

Additional information (if necessary may also be reported on page 2)
Les informations complémentaires (si nécessaire, peuvent être indiqués sur la 2^{ème} page)

For model differences, refer to the test report.

A sample of the product was tested and found to be in conformity with
Un échantillon de ce produit a été essayé et a été considéré conforme à la

IEC 60950-1:2005+A1+A2
See Test Report for National Differences

As shown in the Test Report Ref. No. which forms part of this Certificate
Comme indiqué dans le Rapport d'essais numéro de référence qui constitue partie de ce Certificat

50080564 001

This CB Test Certificate is issued by the National Certification Body
Ce Certificat d'essai OC est établi par l'Organisme National de Certification



TÜV Rheinland Japan Ltd.
Global Technology Assessment Center
4-25-2 Kita-Yamata, Tsuzuki-ku
Yokohama 224-0021 Japan
Phone + 81 45 914-3888
Fax + 81 45 914-3354
Mail: info@jpn.tuv.com
Web: www.tuv.com

Date: 17.05.2017

Signature:

Agean Li

1. TPV Display Technology (Wuhan) Co., Ltd.
Unique No. 11, Zhuankou Development District of Economic Technological Development Zone, Wuhan City 430056, P.R. China
2. TPV Electronics (Fujian) Co., Ltd.
Shangzheng, Yuan Hong Road
Fuqing City, Fujian Province
P.R. China
3. Envision Industry of Electronic Products Ltd.
Rodovia Anhanguera S/N-KM 49
Tijuco Preto-Jundiá-SP-
13.205-700, Brazil
4. L&T Display Technology (Fujian) Ltd.
Optoelectronic Park, Rongqiao Economic and Technological Development Zone
Fuqing, Fujian 350301, P.R. China
5. TPV Electronics (Fujian) Co., Ltd.
Rongqiao Economic and Technological Development Zone
Fuqing City, Fujian Province
P.R. China
6. Trend Smart CE Mexico S de RL de CV
Avenida Sor Juana Ines de la Cruz de 19602 Nueva Tijuana,
22435 Tijuana Baja California
MEXICO
7. TPV Display Technology (Beihai) Co., Ltd.
China Electronic Beihai Industry Park, Northeast of the Crossing
Between Taiwan Road and Jilin Road, Beihai City, Guangxi, P.R. China
8. TPV Technology (Qingdao) Co., Ltd.
No.99 Huoju Road, High-tech Industrial Development Zone
Qingdao City, Shandong Province, P.R. China
9. TPV Display Technology (China) Co., Ltd.
No. 106 Jinghai 3 Rd., BDA
Beijing City 100176
P.R. China

Additional information (if necessary)
Information complémentaire (si nécessaire)

Report Ref. No.: 50080564 001

Date: 17.05.2017

Signature:



Aegean Li

10. Hefei Huntkey Display Technology Co., Ltd.
South Jinxiu Road, East Qingtan Road
Economic And Technological
Development Zone, Hefei, Anhui 230601, P.R. China
11. TPV Electronics (Fujian) Co., Ltd.
Optoelectronic Park,
Rongqiao Economic and
Technological Development Zone,
Fuqing City, Fujian Province 350301, P.R. China
12. Envision Indústria de Produtos
Eletrônicos Ltda.
Av. Torquato Tapajós, 2236,
Flores - CEP 69058-830 - Manaus/AM
Brazil

Additional information (if necessary)
Information complémentaire (si nécessaire)

Report Ref. No.: 50080564 001

Date: 17.05.2017

Signature:



Aegean Li



Test Report issued under the responsibility of:

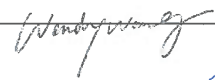
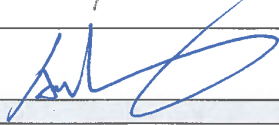

TEST REPORT	
IEC 60950-1	
Information technology equipment – Safety – Part 1: General requirements	
Report Number	50080564 001
Date of issue	May 15, 2017
Total number of pages	102 pages
Applicant's name	TPV Electronics (Fujian) Co., Ltd.
Address	Rongqiao Economic and Technological Development Zone, Fuqing City, Fujian Province, P.R. China
Test specification:	
Standard	IEC 60950-1:2005 (Second Edition) + Am 1:2009 + Am 2:2013
Test procedure	CB Scheme
Non-standard test method	N/A
Test Report Form No	IEC60950_1F
Test Report Form(s) Originator	SGS Fimko Ltd
Master TRF	Dated 2014-02
Copyright © 2014 IEC System of Conformity Assessment Schemes for Electrotechnical Equipment and Components (IECEE System). All rights reserved.	
This publication may be reproduced in whole or in part for non-commercial purposes as long as the IECEE is acknowledged as copyright owner and source of the material. IECEE takes no responsibility for and will not assume liability for damages resulting from the reader's interpretation of the reproduced material due to its placement and context.	
If this Test Report Form is used by non-IECEE members, the IECEE/IEC logo and the reference to the CB Scheme procedure shall be removed.	
This report is not valid as a CB Test Report unless signed by an approved CB Testing Laboratory and appended to a CB Test Certificate issued by an NCB in accordance with IECEE 02.	
General disclaimer:	
The test results presented in this report relate only to the object tested. This report shall not be reproduced, except in full, without the written approval of the Issuing CB Testing Laboratory. The authenticity of this Test Report and its contents can be verified by contacting the NCB, responsible for this Test Report.	

Test item description..... :		LCD MONITOR	
Trade Mark..... :		AOC	
Manufacturer..... :		Same as applicant	
Model/Type reference..... :		185LM000**, *970SW****, 215LM000**, *2270SW****, 195LM000**, *2070SW**** (* can be 0-9, A-Z, a-z, -, \, /, + or blank for marketing purpose)	
Ratings..... :		I/P: 100-240Vac, 50/60Hz, 1.5A	
Testing procedure and testing location:			
<input checked="" type="checkbox"/>	CB Testing Laboratory:	TÜV Rheinland (Shenzhen) Co., Ltd.	
Testing location/ address		East of F/1, F/2~F/4, Building 1, Cybio Technology Building No. 6 Langshan No.2 Road, North Hi-tech Industry Park 518057 Shenzhen Nanshan District CHINA	
<input type="checkbox"/>	Associated CB Testing Laboratory:		
Testing location/ address			
Tested by (name + signature)		Wendy Wang Project Engineer	
Approved by (name + signature)		Anderson Wang Technical Reviewer	
<input type="checkbox"/>	Testing procedure: TMP/CTF Stage 1:		
Testing location/ address			
Tested by (name + signature)			
Approved by (name + signature)			
<input type="checkbox"/>	Testing procedure: WMT/CTF Stage 2:		
Testing location/ address			
Tested by (name + signature)			
Witnessed by (name + signature)			
Approved by (name + signature)			
<input type="checkbox"/>	Testing procedure: SMT/CTF Stage 3 or 4:		
Testing location/ address			
Tested by (name + signature)			
Witnessed by (name + signature)			
Approved by (name + signature)			
Supervised by (name + signature)			

List of Attachments (including a total number of pages in each attachment):

- Photo documentation
- National differences
- Appendix ZZ

Total number of pages in each attachment is indicated in individual attachment.

Summary of testing:**Tests performed (name of test and test clause):**

name of test	test clause number
Input Current Test	1.6.2
Durability of Marking Test	1.7.11
Access to energized parts	2.1.1.1
Energy hazard in Operator Access Area	2.1.1.5
Discharge of Capacitors	2.1.1.7
SELV limits for Normal Conditions	2.2.2
SELV limits for Abnormal Conditions	2.2.3
Limited current Test	2.4
Limited power source	2.5
Ground continue test	2.6.3.4
Humidity Conditioning	2.9.2
Working Voltage over Insulation	2.10.2
Clearance and creepage distance measurements	2.10.3 & 2.10.4
Stability test	4.1
Steady force test, 10 N	4.2.2
Steady Force Test, 30N	4.2.3
Steady Force Test, 250N	4.2.4
Impact Test	4.2.5
Stress Relief Test	4.2.7
Wall mounting test	4.2.10
Maximum Temperature Test	4.5.2
Ball pressure test	4.5.5
Openings in enclosures	4.6
Touch current and protective conductor current	5.1.6
Electric Strength Test	5.2
Fault Condition Test	5.3

Testing location:

All tests as described in Test Case and Measurement Sections were performed at the laboratory described on page 2.

EUT passed all the tests.

Summary of compliance with National Differences

List of countries addressed:

EU Group Differences, EU Special National Conditions, EU A-Deviations, AT, AU, BE, CH, CN, CZ, DE, DK, FI, FR, GB, GR, HU, IT, IL*, JP*, KR*, NL, NO, PL, SE, SI, SK

Explanation of used codes: AT=Austria, AU=Australia, BE=Belgium, CH=Switzerland, CN=China, CZ=Czech Republic, DE=Germany, DK=Denmark, FI=Finland, FR=France, GB=United Kingdom, GR=Greece, HU=Hungary, IT=Italy, IL=Israel, JP=Japan, KR=Korea, NL=The Netherlands, NO=Norway, PL=Poland, SE=Sweden, SI=Slovenia, SK=Slovakia

For National Differences see end of this test report.

* National differences to IEC 60950-1:2005 (Second Edition) + Am 1:2009 evaluated.

The product fulfils the requirements of EN 60950-1: 2006 + A11:2009 + A1:2010 + A12:2011 + A2:2013.

Copy of marking plate

The artwork below may be only a draft. The use of certification marks on a product must be authorized by the respective NCBs that own these marks.



Test item particulars:	
Equipment mobility:	<input checked="" type="checkbox"/> movable (for unit with base stand) <input type="checkbox"/> hand-held <input type="checkbox"/> transportable <input checked="" type="checkbox"/> stationary (for unit without base stand) <input type="checkbox"/> for building-in <input type="checkbox"/> direct plug-in
Connection to the mains:	<input checked="" type="checkbox"/> pluggable equipment <input checked="" type="checkbox"/> type A <input type="checkbox"/> type B <input type="checkbox"/> permanent connection <input checked="" type="checkbox"/> detachable power supply cord <input type="checkbox"/> non-detachable power supply cord <input type="checkbox"/> not directly connected to the mains
Operating condition:	<input checked="" type="checkbox"/> continuous <input type="checkbox"/> rated operating / resting time:
Access location	<input checked="" type="checkbox"/> operator accessible <input type="checkbox"/> restricted access location
Over voltage category (OVC)	<input type="checkbox"/> OVC I <input checked="" type="checkbox"/> OVC II <input type="checkbox"/> OVC III <input type="checkbox"/> OVC IV <input type="checkbox"/> other:
Mains supply tolerance (%) or absolute mains supply values	±10% (requested by client)
Tested for IT power systems	<input type="checkbox"/> Yes <input checked="" type="checkbox"/> No
IT testing, phase-phase voltage (V)	
Class of equipment	<input checked="" type="checkbox"/> Class I <input type="checkbox"/> Class II <input type="checkbox"/> Class III <input type="checkbox"/> Not classified
Considered current rating of protective device as part of the building installation (A)	16A (20A for North America)
Pollution degree (PD)	<input type="checkbox"/> PD 1 <input checked="" type="checkbox"/> PD 2 <input type="checkbox"/> PD 3
IP protection class	IP20
Altitude during operation (m)	Up to 5000
Altitude of test laboratory (m)	≤ 2000
Mass of equipment (kg)	18.5 inch model: approx. 1.95kg with base (base weight: 0.19kg); 21.5 inch model: approx. 2.46kg with base (base weight: 0.22kg) 19.5 inch model: approx. 2.3kg with base (base weight: 0.19kg)
Possible test case verdicts:	
- test case does not apply to the test object	N/A
- test object does meet the requirement	P (Pass)
- test object does not meet the requirement	F (Fail)
Testing:	
Date of receipt of test item:	Apr. 11, 2017
Date(s) of performance of tests	Apr. 11, 2017 to May 08, 2017
General remarks:	
"(see Enclosure #)" refers to additional information appended to the report. "(see appended table)" refers to a table appended to the report.	
Throughout this report a <input type="checkbox"/> comma / <input checked="" type="checkbox"/> point is used as the decimal separator.	

Manufacturer's Declaration per sub-clause 4.2.5 of IEC60950-1:

The application for obtaining a CB Test Certificate includes more than one factory location and a declaration from the Manufacturer stating that the sample(s) submitted for evaluation is (are) representative of the products from each factory has been provided

 Yes **Not applicable****When differences exist; they shall be identified in the General product information section.**

Name and address of factory (ies)..... :	
	1 TPV Display Technology (Wuhan) Co., Ltd. Unique No. 11, Zhuankou Development District of Economic Technological Development Zone, Wuhan City 430056, P.R. China
	2 TPV Electronics (Fujian) Co., Ltd. Shangzheng, Yuan Hong Road, Fuqing City, Fujian Province, P.R. China
	3 Envision Industry of Electronic Products Ltd. Rodovia Anhanguera S/N-KM 49 Tijuco Preto-Jundiaí-SP-13.205-700, Brazil
	4 L&T Display Technology (Fujian) Ltd. Optoelectronic Park, Rongqiao Economic and Technological, Development Zone, Fuqing, Fujian 350301, P.R. China
	5 TPV Electronics (Fujian) Co., Ltd. Rongqiao Economic and Technological Development Zone, Fuqing City, Fujian Province, P.R. China
	6 Trend Smart CE Mexico S de RL de CV Avenida Sor Juana Ines de la Cruz de 19602 Nueva Tijuana, 22435 Tijuans Baja California, MEXICO
	7 TPV Display Technology (Beihai) Co., Ltd. China Electronic Beihai Industry Park, Northeast of the Crossing Between Taiwan Road and Jilin Road, Beihai City, Guangxi, P.R. China
	8 TPV Technology (Qingdao) Co., Ltd. No.99 Huoju Road, High-tech Industrial Development Zone, Qingdao City, Shandong Province, P.R. China
	9 TPV Display Technology (China) Co., Ltd. No.106 Jinghai 3 Rd., BDA, Beijing City 100176, P.R. China.
	10 Hefei Huntkey Display Technology Co.,Ltd. South Jinxiu Road, East Qingtan Road, Economic And Technological Development Zone, Hefei, Anhui 230601, P.R. China
	11 TPV Electronics (Fujian) Co., Ltd. Optoelectronic Park, Rongqiao Economic and Technological Development Zone, Fuqing City, Fujian Province 350301, P.R. China
	12 Envision Indústria de Produtos Eletrônicos Ltda. Av. Torquato Tapajós, 2236, Flores - CEP 69058-830 - Manaus/AM Brazil

General product information:

The models covered in this report are LCD monitors with LED backlight which are intended for general office use.

The units have the following features:

1. LCD panel with LED backlight
2. Building-in type power board 715G5527 with DC/DC convertor;
Alternative building-in type power board 715G6053 with DC/DC convertor;
Alternative building-in type power board 715G7300 with DC/DC convertor;
3. Main board 715G5965 with VGA port;
Alternative main board 715G5846 with VGA port;
Alternative main board 715G6851 type A with VGA port;
Alternative main board 715G6851 type B with VGA port;
4. The internal metal chassis is considered as fire enclosure and mechanical enclosure, and the external plastic enclosure is regarded as electrical enclosure and mechanical enclosure, made of min. HB material;
5. Maximum declared ambient: 40°C.
6. For indoor used only

See following table for model differences:

Model	Panel	Power board	Main board	Metal enclosure	Plastic enclosure
185LM000**, *970SW****	18.5 inch LCD panel with LED backlight	715G5527	715G5965	Type A	Type A
		715G6053	715G6851 type A	Type B	
195LM000**, *2070SW****	19.5 inch LCD panel with LED backlight	715G5527	715G5846	Type A	Type A'
		715G6053	715G6851 type A	Type B	
215LM000**, *2270SW****	21.5 inch LCD panel with LED backlight	715G5527	715G5846	Type A	Type A''
		715G6053	715G6851 type A	Type B	
		715G7300	715G6851 type B	Type C	

Note(s): Plastic enclosure type A, A', A'' are identical except for dimensions due to different panel size (type A < type A' < type A'').

Additional information: The manufacturer declared that the product also fulfilled of the requirements of SANS 60950-1: 2014 (Edition 2.2) / IEC 60950-1: 2013 (Edition 2.2).

Abbreviations used in the report:

- normal conditions	N.C.	- single fault conditions	S.F.C
- functional insulation	OP	- basic insulation	BI
- double insulation	DI	- supplementary insulation	SI
- between parts of opposite polarity	BOP	- reinforced insulation	RI

Indicate used abbreviations (if any)

IEC 60950-1			
Clause	Requirement + Test	Result - Remark	Verdict
1	GENERAL		P
1.5	Components		P
1.5.1	General		P
	Comply with IEC 60950-1 or relevant component standard	(see appended table 1.5.1)	P
1.5.2	Evaluation and testing of components	Components which are certified to IEC and/or national standards are used correctly within their ratings. Components not covered by IEC standards are tested under the conditions present in the equipment.	P
1.5.3	Thermal controls	No thermal controls.	N/A
1.5.4	Transformers	Transformers used are suitable for their intended application and comply with the relevant requirements of the standard and particularly Annex C.	P
1.5.5	Interconnecting cables	Interconnecting cable does not carry voltage higher than SELV and no higher energy level than 240VA.	P
1.5.6	Capacitors bridging insulation	Between lines: X1 or X2 capacitors according to IEC 60384-14 used. Between line and earth: Y1 or Y2 capacitors according to IEC 60384-14 used. Between primary and secondary: Y1 capacitor according to IEC 60384-14 used. (see appended table 1.5.1)	P
1.5.7	Resistors bridging insulation		P
1.5.7.1	Resistors bridging functional, basic or supplementary insulation	Only discharge resistors bridging between L-N (functional)	P
1.5.7.2	Resistors bridging double or reinforced insulation between a.c. mains and other circuits		N/A
1.5.7.3	Resistors bridging double or reinforced insulation between a.c. mains and antenna or coaxial cable		N/A
1.5.8	Components in equipment for IT power systems		N/A
1.5.9	Surge suppressors	No such component.	N/A

IEC 60950-1			
Clause	Requirement + Test	Result - Remark	Verdict
1.5.9.1	General		N/A
1.5.9.2	Protection of VDRs		N/A
1.5.9.3	Bridging of functional insulation by a VDR		N/A
1.5.9.4	Bridging of basic insulation by a VDR		N/A
1.5.9.5	Bridging of supplementary, double or reinforced insulation by a VDR		N/A

1.6	Power interface		P
1.6.1	AC power distribution systems	TN power system	P
1.6.2	Input current	(see appended table 1.6.2)	P
1.6.3	Voltage limit of hand-held equipment	This appliance is not hand-held equipment.	N/A
1.6.4	Neutral conductor	The neutral conductor insulated from earth and from the body throughout the equipment as if it were a line conductor	P

1.7	Marking and instructions		P
1.7.1	Power rating and identification markings	See below.	P
1.7.1.1	Power rating marking	See below.	P
	Multiple mains supply connections.....:		N/A
	Rated voltage(s) or voltage range(s) (V)	See copy of marking plate for details	P
	Symbol for nature of supply, for d.c. only	AC source	N/A
	Rated frequency or rated frequency range (Hz)	See copy of marking plate for details	P
	Rated current (mA or A)	See copy of marking plate for details	P
1.7.1.2	Identification markings	See below.	P
	Manufacturer's name or trade-mark or identification mark	See copy of marking plate for details	P
	Model identification or type reference	See copy of marking plate for details	P
	Symbol for Class II equipment only	Class I equipment.	N/A
	Other markings and symbols	Additional symbol or marking does not give rise to misunderstanding.	P

IEC 60950-1			
Clause	Requirement + Test	Result - Remark	Verdict
1.7.1.3	Use of graphical symbols	Graphical symbols used according to IEC 60417 or ISO 3864-2 or ISO 7000.	P
1.7.2	Safety instructions and marking	English safety instruction provided.	P
1.7.2.1	General		P
1.7.2.2	Disconnect devices	AC inlet serves as disconnect device.	P
1.7.2.3	Overcurrent protective device	Not type B pluggable equipment or permanently connected equipment.	N/A
1.7.2.4	IT power distribution systems	TN power system.	N/A
1.7.2.5	Operator access with a tool	No such access required.	N/A
1.7.2.6	Ozone	Ozone not used or generated.	N/A
1.7.3	Short duty cycles	Equipment is designed for continuous operation.	N/A
1.7.4	Supply voltage adjustment	Single input voltage range without adjustment.	N/A
	Methods and means of adjustment; reference to installation instructions		N/A
1.7.5	Power outlets on the equipment	No power outlets provided.	N/A

IEC 60950-1			
Clause	Requirement + Test	Result - Remark	Verdict
1.7.6	Fuse identification (marking, special fusing characteristics, cross-reference)	<p>For power board 715G5527: The fuse marking is marked near fuse on PCB as follow: F901(on primary): T3.15AL/250Vac</p> <p>F902(on secondary)(optional): T5AL/250Vac</p> <p>For power board 715G6053: The fuse marking is marked near fuse on PCB as follow: F901(on primary): T2.5AL/250Vac</p> <p>For power board 715G7300: The fuse marking is marked near fuse on PCB as follow: F901(on primary): T3.15AL/250Vac</p> <p>Below marking marked on PCB near primary fuse: CAUTION: FOR CONTINUED PROTECTION AGAINST RISK OF FIRE, REPLACE ONLY WITH SAME TYPE AND RATING OF FUSE</p> <p>Not located in operator access areas.</p>	P
1.7.7	Wiring terminals	See below.	P
1.7.7.1	Protective earthing and bonding terminals	AC inlet used. Symbol marked beside earthing pin of AC inlet	P
1.7.7.2	Terminals for a.c. mains supply conductors	The equipment is not permanently connected or provided with a non-detachable power supply cord	N/A
1.7.7.3	Terminals for d.c. mains supply conductors	Not connected to d.c. mains	N/A
1.7.8	Controls and indicators	See below	P
1.7.8.1	Identification, location and marking	"STAND-BY" condition is indicated by the symbol according to IEC 60417-5009.	P
1.7.8.2	Colours	Colours used for LED indicate the operation status and not involved safety.	N/A
1.7.8.3	Symbols according to IEC 60417	See 1.7.8.1	P
1.7.8.4	Markings using figures	No figures used.	N/A
1.7.9	Isolation of multiple power sources	Only one supply voltage range provided.	N/A

IEC 60950-1			
Clause	Requirement + Test	Result - Remark	Verdict
1.7.10	Thermostats and other regulating devices	No such components.	N/A
1.7.11	Durability	The label was subjected to the permanence of marking test. The label was rubbed with cloth soaked with water for 15 sec. and then again for 15 sec. with the cloth soaked with petroleum spirit. After this test there was no damage to the label. The marking on the label did not fade. There was no curling or lifting of the label edge.	P
1.7.12	Removable parts	None.	N/A
1.7.13	Replaceable batteries	No batteries.	N/A
	Language(s)		—
1.7.14	Equipment for restricted access locations	Equipment not intended for installation in restricted access locations.	N/A

2	PROTECTION FROM HAZARDS		P
2.1	Protection from electric shock and energy hazards		P
2.1.1	Protection in operator access areas	Only SELV signal interface accessible by operator.	P
2.1.1.1	Access to energized parts	See below	P
	Test by inspection	Protection established by plastic enclosure.	P
	Test with test finger (Figure 2A)	Protection established by plastic enclosure.	P
	Test with test pin (Figure 2B)	No access to any energized parts with the removable stand detached.	P
	Test with test probe (Figure 2C)		N/A
2.1.1.2	Battery compartments	No battery compartment.	N/A
2.1.1.3	Access to ELV wiring	No ELV wiring in operator accessible area.	N/A
	Working voltage (V _{peak} or V _{rms}); minimum distance through insulation (mm)	(see appended table 2.10.5)	—
2.1.1.4	Access to hazardous voltage circuit wiring	No hazardous voltage wiring in operator accessible area.	N/A

IEC 60950-1			
Clause	Requirement + Test	Result - Remark	Verdict
2.1.1.5	Energy hazards	The energy does not exceed 240VA between any two points in accessible connector of secondary circuit. (see appended table 2.1.1.5.)	P
2.1.1.6	Manual controls	No manual controls.	N/A
2.1.1.7	Discharge of capacitors in equipment	(See appended table 2.1.1.7)	P
	Measured voltage (V); time-constant (s)	(See appended table 2.1.1.7)	—
2.1.1.8	Energy hazards – d.c. mains supply	a.c. mains supply	N/A
	a) Capacitor connected to the d.c. mains supply ...:		N/A
	b) Internal battery connected to the d.c. mains supply		N/A
2.1.1.9	Audio amplifiers		N/A
2.1.2	Protection in service access areas	No service access area.	N/A
2.1.3	Protection in restricted access locations	Equipment not intended for installation in restricted access locations	N/A

2.2	SELV circuits		P
2.2.1	General requirements	The secondary circuits were tested as SELV. See sub-clauses 2.2.1 to 2.2.4.	P
2.2.2	Voltages under normal conditions (V)	42.4V peak or 60V d.c. are not exceeded in SELV circuit under normal operation.	P
2.2.3	Voltages under fault conditions (V)	Single fault did not cause excessive voltage in accessible SELV circuits. Limits of 71V peak and 120V d.c. were not exceeded within 0.2 sec. and limits 42.4V peak and 60V d.c. were not exceeded for longer than 0.2 sec., see appended tables 2.2 and 5.3.	P
2.2.4	Connection of SELV circuits to other circuits	See sub-clauses 2.2.2 and 2.2.3. No direct connection between SELV and any primary circuits.	P

2.3	TNV circuits		N/A
2.3.1	Limits		N/A

IEC 60950-1			
Clause	Requirement + Test	Result - Remark	Verdict
	Type of TNV circuits		—
2.3.2	Separation from other circuits and from accessible parts		N/A
2.3.2.1	General requirements		N/A
2.3.2.2	Protection by basic insulation		N/A
2.3.2.3	Protection by earthing		N/A
2.3.2.4	Protection by other constructions		N/A
2.3.3	Separation from hazardous voltages		N/A
	Insulation employed		—
2.3.4	Connection of TNV circuits to other circuits		N/A
	Insulation employed		—
2.3.5	Test for operating voltages generated externally		N/A

2.4	Limited current circuits		P
2.4.1	General requirements		P
2.4.2	Limit values	See appended table 2.4.	P
	Frequency (Hz)		—
	Measured current (mA)		—
	Measured voltage (V)		—
	Measured circuit capacitance (nF or μ F)		—
2.4.3	Connection of limited current circuits to other circuits	Only connected to SELV circuits.	P

2.5	Limited power sources		P
	a) Inherently limited output		N/A
	b) Impedance limited output		N/A
	c) Regulating network or IC current limiter, limits output under normal operating and single fault condition	(see appended table 2.5)	P
	Use of integrated circuit (IC) current limiters		N/A
	d) Overcurrent protective device limited output		N/A
	Max. output voltage (V), max. output current (A), max. apparent power (VA)		—
	Current rating of overcurrent protective device (A) :		—

2.6	Provisions for earthing and bonding		P
------------	--	--	----------

IEC 60950-1			
Clause	Requirement + Test	Result - Remark	Verdict
2.6.1	Protective earthing	Class I appliance inlet terminal provided as protective earthing terminal, and accessible metal plate is connected to earthed metal fire enclosure. The test of 2.6.3.4 complied.	P
2.6.2	Functional earthing	Functional earthing in the secondary circuit is accessible at the signal connectors and separated from the primary by reinforced insulation.	P
	Use of symbol for functional earthing		N/A
2.6.3	Protective earthing and protective bonding conductors		P
2.6.3.1	General	Appliance inlet used. No power cord provided with the unit.	P
2.6.3.2	Size of protective earthing conductors	AC inlet used	N/A
	Rated current (A), cross-sectional area (mm ²), AWG		—
2.6.3.3	Size of protective bonding conductors	Screws fixing earthed PCB trace to metal chassis for protective bonding.	P
	Rated current (A), cross-sectional area (mm ²), AWG	Refer to test of appended table 2.6.3.4 only.	—
	Protective current rating (A), cross-sectional area (mm ²), AWG	Refer to test of appended table 2.6.3.4 only.	—
2.6.3.4	Resistance of earthing conductors and their terminations; resistance (Ω), voltage drop (V), test current (A), duration (min)	(see appended table 2.6.3.4)	P
2.6.3.5	Colour of insulation	Protective bonding conductor as in 2.6.3 and assembled by printed wiring on power board.	N/A
2.6.4	Terminals	See below	P
2.6.4.1	General		P
2.6.4.2	Protective earthing and bonding terminals	The earth terminal of the approved appliance inlet is considered as protective earthing terminal and was evaluated by sub clause 2.6.3.4.	P
	Rated current (A), type, nominal thread diameter (mm)	Evaluation by test. See sub-clause 2.6.3.4.	—
2.6.4.3	Separation of the protective earthing conductor from protective bonding conductors	Separated PE and protective bonding conductor used.	P

IEC 60950-1			
Clause	Requirement + Test	Result - Remark	Verdict
2.6.5	Integrity of protective earthing	See below	P
2.6.5.1	Interconnection of equipment	Not depending on interconnection for protective earthing.	P
2.6.5.2	Components in protective earthing conductors and protective bonding conductors	No switch or overcurrent protective device in protective earthing or bonding conductor	P
2.6.5.3	Disconnection of protective earth	Appliance inlet used for disconnection of protective earth.	P
2.6.5.4	Parts that can be removed by an operator	AC inlet with PE terminal used.	P
2.6.5.5	Parts removed during servicing		N/A
2.6.5.6	Corrosion resistance	All safety earthing connections comply with Annex J.	P
2.6.5.7	Screws for protective bonding	No self-tapping or spaced thread screws are used. For the earth connection to the metal chassis a spring washer and a screw are used.	N/A
2.6.5.8	Reliance on telecommunication network or cable distribution system	No TNV circuit.	N/A

2.7	Overcurrent and earth fault protection in primary circuits		P
2.7.1	Basic requirements	The equipment relies on fuse or circuit breaker of the wall outlet protection of the building installation in regard to L to N short-circuits. A built-in fuse provided as overcurrent protection device (see 5.3)	P
	Instructions when protection relies on building installation	Pluggable equipment type A.	N/A
2.7.2	Faults not simulated in 5.3.7	The protection devices are well dimensioned and mounted.	P
2.7.3	Short-circuit backup protection	Building installation is considered as providing short-circuit backup protection.	P
2.7.4	Number and location of protective devices :	Overcurrent protection by one built-in fuse	P
2.7.5	Protection by several devices	Protection by one fuse only.	N/A
2.7.6	Warning to service personnel..... :	No service work necessary.	N/A

IEC 60950-1			
Clause	Requirement + Test	Result - Remark	Verdict
2.8	Safety interlocks		N/A
2.8.1	General principles		N/A
2.8.2	Protection requirements		N/A
2.8.3	Inadvertent reactivation		N/A
2.8.4	Fail-safe operation		N/A
	Protection against extreme hazard		N/A
2.8.5	Moving parts		N/A
2.8.6	Overriding		N/A
2.8.7	Switches, relays and their related circuits		N/A
2.8.7.1	Separation distances for contact gaps and their related circuits (mm)		N/A
2.8.7.2	Overload test		N/A
2.8.7.3	Endurance test		N/A
2.8.7.4	Electric strength test		N/A
2.8.8	Mechanical actuators		N/A

2.9	Electrical insulation		P
2.9.1	Properties of insulating materials	Natural rubber, asbestos or hygroscopic material not used. After the humidity treatment of 2.9.2, the insulation is then subjected to the relevant electric strength test of 5.2.2.	P
2.9.2	Humidity conditioning	Performed at 40 °C, 95% R.H. for 120 h by client's request.	P
	Relative humidity (%), temperature (°C)	See above.	—
2.9.3	Grade of insulation	See above.	P
2.9.4	Separation from hazardous voltages	The adequate levels of safety insulation provided and maintained to comply with the requirements of this standard.	P
	Method(s) used	SELV separated from primary by reinforced or double insulation.	—

2.10	Clearances, creepage distances and distances through insulation		P
2.10.1	General	See sub-clauses 2.10.3, 2.10.4 and 2.10.5.	P
2.10.1.1	Frequency	Considered	P

IEC 60950-1			
Clause	Requirement + Test	Result - Remark	Verdict
2.10.1.2	Pollution degrees	2	P
2.10.1.3	Reduced values for functional insulation	Considered	P
2.10.1.4	Intervening unconnected conductive parts	Considered	P
2.10.1.5	Insulation with varying dimensions	Insulation kept homogenous.	N/A
2.10.1.6	Special separation requirements	Not applied.	N/A
2.10.1.7	Insulation in circuits generating starting pulses	No such circuits.	N/A
2.10.2	Determination of working voltage		P
2.10.2.1	General	The rms and the peak voltage were measured with unit connected to a 240V TN power system. The input neutral and secondary ground were connected during measurement. Pollution Degree 2 and Overvoltage Category II considered.	P
2.10.2.2	RMS working voltage	See table 2.10.2	P
2.10.2.3	Peak working voltage	See table 2.10.2	P
2.10.3	Clearances	See below and advantage of annex G is not considered.	P
2.10.3.1	General	Considered.	P
2.10.3.2	Mains transient voltages		P
	a) AC mains supply	240V a.c. and Overvoltage Category II	P
	b) Earthed d.c. mains supplies		N/A
	c) Unearthed d.c. mains supplies		N/A
	d) Battery operation		N/A
2.10.3.3	Clearances in primary circuits	(see appended table 2.10.3 and 2.10.4)	P
2.10.3.4	Clearances in secondary circuits	Sub-clause 5.3.4 considered.	P
2.10.3.5	Clearances in circuits having starting pulses		N/A
2.10.3.6	Transients from a.c. mains supply	Normal transient voltage considered (overvoltage category II for primary circuit).	N/A
2.10.3.7	Transients from d.c. mains supply		N/A
2.10.3.8	Transients from telecommunication networks and cable distribution systems		N/A
2.10.3.9	Measurement of transient voltage levels		N/A
	a) Transients from a mains supply		N/A
	For an a.c. mains supply		N/A

IEC 60950-1			
Clause	Requirement + Test	Result - Remark	Verdict
	For a d.c. mains supply		N/A
	b) Transients from a telecommunication network :		N/A
2.10.4	Creepage distances		P
2.10.4.1	General		P
2.10.4.2	Material group and comparative tracking index		P
	CTI tests	Material group IIIb is assumed to be used.	—
2.10.4.3	Minimum creepage distances	(see appended table 2.10.3 and 2.10.4)	P
2.10.5	Solid insulation		P
2.10.5.1	General		P
2.10.5.2	Distances through insulation	(see appended table 2.10.5)	P
2.10.5.3	Insulating compound as solid insulation	Only inside approved optocoupler.	N/A
2.10.5.4	Semiconductor devices	Approved optocoupler complies to IEC 60747-5-2 and having dti ≥ 0.4 mm.	P
2.10.5.5.	Cemented joints	Not applied.	N/A
2.10.5.6	Thin sheet material – General		P
2.10.5.7	Separable thin sheet material	Used in transformer.	P
	Number of layers (pcs)	(see appended table C.2)	—
2.10.5.8	Non-separable thin sheet material	Not applied for.	N/A
2.10.5.9	Thin sheet material – standard test procedure		N/A
	Electric strength test		—
2.10.5.10	Thin sheet material – alternative test procedure		P
	Electric strength test	(see appended table 5.2)	—
2.10.5.11	Insulation in wound components		P
2.10.5.12	Wire in wound components		P
	Working voltage	Exceeds 71 V.	P
	a) Basic insulation not under stress		N/A
	b) Basic, supplementary, reinforced insulation	Reinforced.	P
	c) Compliance with Annex U		P
	Two wires in contact inside wound component; angle between 45° and 90°	Secondary insulated wires crossing each other at an angle between 45° and 90° are protected against mechanical stress by tubing and insulation tape.	P

IEC 60950-1			
Clause	Requirement + Test	Result - Remark	Verdict
2.10.5.13	Wire with solvent-based enamel in wound components	Not applied.	N/A
	Electric strength test		—
	Routine test		N/A
2.10.5.14	Additional insulation in wound components	Not applied.	N/A
	Working voltage		N/A
	- Basic insulation not under stress		N/A
	- Supplementary, reinforced insulation		N/A
2.10.6	Construction of printed boards		P
2.10.6.1	Uncoated printed boards	(see appended table 2.10.3 and 2.10.4)	P
2.10.6.2	Coated printed boards	Not applied.	N/A
2.10.6.3	Insulation between conductors on the same inner surface of a printed board	Not multi-layer printed board.	N/A
2.10.6.4	Insulation between conductors on different layers of a printed board	See above.	N/A
	Distance through insulation		N/A
	Number of insulation layers (pcs)		N/A
2.10.7	Component external terminations	Coatings not used over terminations to increase effective clearance and creepage distance.	N/A
2.10.8	Tests on coated printed boards and coated components		N/A
2.10.8.1	Sample preparation and preliminary inspection		N/A
2.10.8.2	Thermal conditioning		N/A
2.10.8.3	Electric strength test		N/A
2.10.8.4	Abrasion resistance test		N/A
2.10.9	Thermal cycling		N/A
2.10.10	Test for Pollution Degree 1 environment and insulating compound	Pollution Degree 2.	N/A
2.10.11	Tests for semiconductor devices and cemented joints	Photo couplers are approved components. No other components applied for.	N/A
2.10.12	Enclosed and sealed parts	No hermetically sealed component.	N/A
3	WIRING, CONNECTIONS AND SUPPLY		P
3.1	General		P

IEC 60950-1			
Clause	Requirement + Test	Result - Remark	Verdict
3.1.1	Current rating and overcurrent protection	The cross-sectional area and the temperature of the internal wires are adequate. No internal wire for primary power distribution.	P
3.1.2	Protection against mechanical damage	Wires do not touch sharp edges which could damage the insulation and cause hazard.	P
3.1.3	Securing of internal wiring	Wires with only basic insulation are routed so that they are not close to any live bare components. Wires are secured by soldering method and additionally fixed by glue or by connectors.	P
3.1.4	Insulation of conductors	The insulation of the individual conductors suitable for the application and the working voltage. For the insulation material see 3.1.1.	P
3.1.5	Beads and ceramic insulators	Not used.	N/A
3.1.6	Screws for electrical contact pressure	Only metal screw is used for electrical connection between protective earth and metal chassis, and engages more than 2 complete threads.	P
3.1.7	Insulating materials in electrical connections	The integrity of protective bonding made by screw, PCB trace and spring washer.	P
3.1.8	Self-tapping and spaced thread screws	No self-tapping or spaced thread screws are used.	N/A
3.1.9	Termination of conductors	All conductors are reliably secured.	P
	10 N pull test		P
3.1.10	Sleeving on wiring		N/A

3.2	Connection to a mains supply		P
3.2.1	Means of connection	See below.	P
3.2.1.1	Connection to an a.c. mains supply	Appliance inlet used.	P
3.2.1.2	Connection to a d.c. mains supply	Only a.c. mains supply.	N/A
3.2.2	Multiple supply connections	Only for one mains connection.	N/A
3.2.3	Permanently connected equipment	Unit is not a permanently connected equipment.	N/A

IEC 60950-1			
Clause	Requirement + Test	Result - Remark	Verdict
	Number of conductors, diameter of cable and conduits (mm)		—
3.2.4	Appliance inlets	Approved appliance inlet used.	P
3.2.5	Power supply cords	See below.	N/A
3.2.5.1	AC power supply cords	Not provided.	N/A
	Type		—
	Rated current (A), cross-sectional area (mm ²), AWG		—
3.2.5.2	DC power supply cords	Not provided.	N/A
3.2.6	Cord anchorages and strain relief	Appliance inlet used	N/A
	Mass of equipment (kg), pull (N)		—
	Longitudinal displacement (mm)		—
3.2.7	Protection against mechanical damage		N/A
3.2.8	Cord guards	No cord guards	N/A
	Diameter or minor dimension D (mm); test mass (g)		—
	Radius of curvature of cord (mm)		—
3.2.9	Supply wiring space	Not permanent connection or non-detachable power cord type.	N/A

3.3	Wiring terminals for connection of external conductors		N/A
3.3.1	Wiring terminals	AC inlet used.	N/A
3.3.2	Connection of non-detachable power supply cords		N/A
3.3.3	Screw terminals		N/A
3.3.4	Conductor sizes to be connected		N/A
	Rated current (A), cord/cable type, cross-sectional area (mm ²)		—
3.3.5	Wiring terminal sizes		N/A
	Rated current (A), type, nominal thread diameter (mm)		—
3.3.6	Wiring terminal design		N/A
3.3.7	Grouping of wiring terminals		N/A
3.3.8	Stranded wire		N/A

3.4	Disconnection from the mains supply		P
3.4.1	General requirement	Disconnect device provided	P

IEC 60950-1			
Clause	Requirement + Test	Result - Remark	Verdict
3.4.2	Disconnect devices	Appliance coupler used as disconnect device.	P
3.4.3	Permanently connected equipment	Not permanently connected equipment	N/A
3.4.4	Parts which remain energized	When AC coupler is disconnected from inlet, there are no parts remaining with hazardous voltage or energy in the equipment.	P
3.4.5	Switches in flexible cords	No such switch in flexible cords	N/A
3.4.6	Number of poles - single-phase and d.c. equipment	The appliance coupler disconnects both poles simultaneously.	P
3.4.7	Number of poles - three-phase equipment	Single-phase equipment	N/A
3.4.8	Switches as disconnect devices	No such switch	N/A
3.4.9	Plugs as disconnect devices	Plug not used	N/A
3.4.10	Interconnected equipment	Only interconnected with other unit through SELV interface.	P
3.4.11	Multiple power sources	Single power source	N/A
3.5	Interconnection of equipment		P
3.5.1	General requirements	This power supply is not considered for connection to TNV.	P
3.5.2	Types of interconnection circuits	Interconnection circuits of SELV through the connector. No ELV interconnection circuits.	P
3.5.3	ELV circuits as interconnection circuits	No ELV interconnection	N/A
3.5.4	Data ports for additional equipment	All data ports are supplied by LPS.	P
4	PHYSICAL REQUIREMENTS		P
4.1	Stability		P
	Angle of 10°	No overturn. (Test by client's request)	P
	Test force (N)	Equipment is not a floor standing unit.	N/A
4.2	Mechanical strength		P

IEC 60950-1			
Clause	Requirement + Test	Result - Remark	Verdict
4.2.1	General	See below. After tests, unit comply with 2.1.1, 2.6.1 and 2.10.	P
	Rack-mounted equipment.		N/A
4.2.2	Steady force test, 10 N	Test performed on internal components. No components located such that distances according to 2.10 can be reduced.	P
4.2.3	Steady force test, 30 N	Test performed on internal metal enclosure.	P
4.2.4	Steady force test, 250 N	Test performed on plastic enclosure.	P
4.2.5	Impact test	500g steel ball falls freely from 1.3m on top, back and bottom of plastic enclosure, no access to hazardous parts.	P
	Fall test		P
	Swing test		N/A
4.2.6	Drop test; height (mm) :		N/A
4.2.7	Stress relief test	70°C, 7 hours, no deformation on all sources of plastic enclosure.	P
4.2.8	Cathode ray tubes	No CRT	N/A
	Picture tube separately certified :		N/A
4.2.9	High pressure lamps	No high pressure lamps	N/A
4.2.10	Wall or ceiling mounted equipment; force (N) :	An additional force 52N for 18.5 inch model, 66N for 21.5 inch model, 63 N for 19.5 inch model applied downwards through the centre of gravity of the equipment for 1 min after the removal of base (by client's request). After the test, the equipment was not damaged. (52N = 3 x 1.76 x 9.8N; 66N = 3 x 2.24 x 9.8N; 63N = 3 x 2.11 x 9.8N)	P

4.3	Design and construction		P
4.3.1	Edges and corners	Edges and corners of the enclosure are rounded.	P
4.3.2	Handles and manual controls; force (N) :	No safety relevant handles or manual controls.	N/A

IEC 60950-1			
Clause	Requirement + Test	Result - Remark	Verdict
4.3.3	Adjustable controls	No such controls.	N/A
4.3.4	Securing of parts	All parts secured properly. Spring washer used for securing screws.	P
4.3.5	Connection by plugs and sockets		N/A
4.3.6	Direct plug-in equipment	Not such equipment.	N/A
	Torque		—
	Compliance with the relevant mains plug standard		N/A
4.3.7	Heating elements in earthed equipment	None.	N/A
4.3.8	Batteries	No batteries.	N/A
	- Overcharging of a rechargeable battery		N/A
	- Unintentional charging of a non-rechargeable battery		N/A
	- Reverse charging of a rechargeable battery		N/A
	- Excessive discharging rate for any battery		N/A
4.3.9	Oil and grease	None.	N/A
4.3.10	Dust, powders, liquids and gases	Equipment in intended use not considered to be exposed to these.	N/A
4.3.11	Containers for liquids or gases	None	N/A
4.3.12	Flammable liquids	None	N/A
	Quantity of liquid (l)		N/A
	Flash point (°C)		N/A
4.3.13	Radiation		P
4.3.13.1	General	See below	P
4.3.13.2	Ionizing radiation	No ionizing radiation.	N/A
	Measured radiation (pA/kg)		—
	Measured high-voltage (kV)		—
	Measured focus voltage (kV)		—
	CRT markings		—
4.3.13.3	Effect of ultraviolet (UV) radiation on materials	No ultraviolet radiation	N/A
	Part, property, retention after test, flammability classification		N/A
4.3.13.4	Human exposure to ultraviolet (UV) radiation	No ultraviolet radiation	N/A
4.3.13.5	Lasers (including laser diodes) and LEDs	See below.	P
4.3.13.5.1	Lasers (including laser diodes)	Not used.	N/A
	Laser class		—

IEC 60950-1			
Clause	Requirement + Test	Result - Remark	Verdict
4.3.13.5.2	Light emitting diodes (LEDs)	The following parts are considered complied without tests: Indicating lights. Optocouplers. For LED backlight, the luminance is far less than 10000 cd/m ² . With reference to sub clause 4.1 of IEC 62471:2006 no further test is necessary.	P
4.3.13.6	Other types		N/A

4.4	Protection against hazardous moving parts		N/A
4.4.1	General		N/A
4.4.2	Protection in operator access areas		N/A
	Household and home/office document/media shredders		N/A
4.4.3	Protection in restricted access locations		N/A
4.4.4	Protection in service access areas		N/A
4.4.5	Protection against moving fan blades		N/A
4.4.5.1	General		N/A
	Not considered to cause pain or injury. a)		N/A
	Is considered to cause pain, not injury. b)		N/A
	Considered to cause injury. c)		N/A
4.4.5.2	Protection for users		N/A
	Use of symbol or warning		N/A
4.4.5.3	Protection for service persons		N/A
	Use of symbol or warning		N/A

4.5	Thermal requirements		P
4.5.1	General		P
4.5.2	Temperature tests		P
	Normal load condition per Annex L	Equipment loaded with rated output current.	—
4.5.3	Temperature limits for materials	(see appended table 4.5)	P
4.5.4	Touch temperature limits	(see appended table 4.5)	P

IEC 60950-1			
Clause	Requirement + Test	Result - Remark	Verdict
4.5.5	Resistance to abnormal heat	Bobbin materials of transformer and some of line choke are Phenolic that is accepted without further tests. Others see appended table 4.5.5.	P
4.6	Openings in enclosures		P
4.6.1	Top and side openings	(see appended table 4.6.1 and 4.6.2)	P
	Dimensions (mm)		—
4.6.2	Bottoms of fire enclosures	(see appended table 4.6.1 and 4.6.2)	P
	Construction of the bottomm, dimensions (mm) .. :		—
4.6.3	Doors or covers in fire enclosures	No doors or covers.	N/A
4.6.4	Openings in transportable equipment	Not transportable equipment.	N/A
4.6.4.1	Constructional design measures		N/A
	Dimensions (mm)		—
4.6.4.2	Evaluation measures for larger openings		N/A
4.6.4.3	Use of metallized parts		N/A
4.6.5	Adhesives for constructional purposes		N/A
	Conditioning temperature (°C), time (weeks)		—
4.7	Resistance to fire		P
4.7.1	Reducing the risk of ignition and spread of flame	No excessive temperatures. No easily burning materials employed. Fire enclosure provided. Safety relevant components used within their specified temperature limits.	P
	Method 1, selection and application of components wiring and materials	(see appended table 4.7)	P
	Method 2, application of all of simulated fault condition tests		N/A
4.7.2	Conditions for a fire enclosure	Internal metal enclosure used as fire enclosure.	P

IEC 60950-1			
Clause	Requirement + Test	Result - Remark	Verdict
4.7.2.1	Parts requiring a fire enclosure	With having the following parts: - Components in primary - Insulated wiring - Components in secondary (not supplied by LPS, and not applied all fault condition test) The buttons control board is outside the fire enclosure as it is supplied by LPS and mounted on PCB of class V-1 or better material. Internal metal enclosure used as fire enclosure.	P
4.7.2.2	Parts not requiring a fire enclosure	For components in secondary circuits supplied by LPS.	P
4.7.3	Materials		P
4.7.3.1	General	PCB rated V-1	P
4.7.3.2	Materials for fire enclosures	Earthed metal enclosure is considered as fire enclosure, which complies without test.	P
4.7.3.3	Materials for components and other parts outside fire enclosures	HB plastic enclosure used, which is outside the fire enclosure.	P
4.7.3.4	Materials for components and other parts inside fire enclosures	Internal components except small parts are V-2, HF-2 or better.	P
4.7.3.5	Materials for air filter assemblies	No air filter.	N/A
4.7.3.6	Materials used in high-voltage components	No such high voltage components in this meaning	N/A

5	ELECTRICAL REQUIREMENTS AND SIMULATED ABNORMAL CONDITIONS		P
5.1	Touch current and protective conductor current		P
5.1.1	General	See sub-clauses 5.1.2 to 5.1.6.	P
5.1.2	Configuration of equipment under test (EUT)	See below.	P
5.1.2.1	Single connection to an a.c. mains supply	EUT has only one mains connection.	P
5.1.2.2	Redundant multiple connections to an a.c. mains supply		N/A
5.1.2.3	Simultaneous multiple connections to an a.c. mains supply		N/A
5.1.3	Test circuit	Using figure 5A.	P

IEC 60950-1			
Clause	Requirement + Test	Result - Remark	Verdict
5.1.4	Application of measuring instrument	Using measuring instrument in annex D.	P
5.1.5	Test procedure		P
5.1.6	Test measurements	(see appended table 5.1.6)	P
	Supply voltage (V)		—
	Measured touch current (mA)		—
	Max. allowed touch current (mA)		—
	Measured protective conductor current (mA)		—
	Max. allowed protective conductor current (mA) ...:		—
5.1.7	Equipment with touch current exceeding 3,5 mA	Touch current does not exceed 3.5mA.	N/A
5.1.7.1	General		N/A
5.1.7.2	Simultaneous multiple connections to the supply		N/A
5.1.8	Touch currents to telecommunication networks and cable distribution systems and from telecommunication networks	No TNV circuits.	N/A
5.1.8.1	Limitation of the touch current to a telecommunication network or to a cable distribution system		N/A
	Supply voltage (V)		—
	Measured touch current (mA)		—
	Max. allowed touch current (mA)		—
5.1.8.2	Summation of touch currents from telecommunication networks		N/A
	a) EUT with earthed telecommunication ports		N/A
	b) EUT whose telecommunication ports have no reference to protective earth		N/A
5.2	Electric strength		P
5.2.1	General	(see appended table 5.2)	P
5.2.2	Test procedure	(see appended table 5.2)	P
5.3	Abnormal operating and fault conditions		P
5.3.1	Protection against overload and abnormal operation	Ventilation openings blocked, output overloaded, no unaccepted overheating of parts (see appended table 5.3)	P
5.3.2	Motors	Motors not used.	N/A

IEC 60950-1			
Clause	Requirement + Test	Result - Remark	Verdict
5.3.3	Transformers	(see appended Annex C and table 5.3)	P
5.3.4	Functional insulation	By short-circuited, results see appended table 5.3.	P
5.3.5	Electromechanical components	No electromechanical component.	N/A
5.3.6	Audio amplifiers in ITE		N/A
5.3.7	Simulation of faults	(see appended table 5.3.)	P
5.3.8	Unattended equipment	No such equipment.	N/A
5.3.9	Compliance criteria for abnormal operating and fault conditions		P
5.3.9.1	During the tests	No fire or molten metal occurred and no deformation of enclosure during the tests.	P
5.3.9.2	After the tests	No reduction of clearance and creepage distance. Electric strength test is made on basic, supplementary and reinforced insulation after test.	P

6	CONNECTION TO TELECOMMUNICATION NETWORKS		N/A
6.1	Protection of telecommunication network service persons, and users of other equipment connected to the network, from hazards in the equipment		N/A
6.1.1	Protection from hazardous voltages		N/A
6.1.2	Separation of the telecommunication network from earth		N/A
6.1.2.1	Requirements		N/A
	Supply voltage (V)		—
	Current in the test circuit (mA)		—
6.1.2.2	Exclusions		N/A

6.2	Protection of equipment users from overvoltages on telecommunication networks		N/A
6.2.1	Separation requirements		N/A
6.2.2	Electric strength test procedure		N/A
6.2.2.1	Impulse test		N/A
6.2.2.2	Steady-state test		N/A
6.2.2.3	Compliance criteria		N/A

6.3	Protection of the telecommunication wiring system from overheating		N/A
	Max. output current (A)		—

IEC 60950-1			
Clause	Requirement + Test	Result - Remark	Verdict
	Current limiting method		—
7	CONNECTION TO CABLE DISTRIBUTION SYSTEMS		N/A
7.1	General		N/A
7.2	Protection of cable distribution system service persons, and users of other equipment connected to the system, from hazardous voltages in the equipment		N/A
7.3	Protection of equipment users from overvoltages on the cable distribution system		N/A
7.4	Insulation between primary circuits and cable distribution systems		N/A
7.4.1	General		N/A
7.4.2	Voltage surge test		N/A
7.4.3	Impulse test		N/A
A	ANNEX A, TESTS FOR RESISTANCE TO HEAT AND FIRE		N/A
A.1	Flammability test for fire enclosures of movable equipment having a total mass exceeding 18 kg, and of stationary equipment (see 4.7.3.2)		N/A
A.1.1	Samples.....		—
	Wall thickness (mm).....		—
A.1.2	Conditioning of samples; temperature (°C)		N/A
A.1.3	Mounting of samples		N/A
A.1.4	Test flame (see IEC 60695-11-3)		N/A
	Flame A, B, C or D		—
A.1.5	Test procedure		N/A
A.1.6	Compliance criteria		N/A
	Sample 1 burning time (s)		—
	Sample 2 burning time (s)		—
	Sample 3 burning time (s)		—
A.2	Flammability test for fire enclosures of movable equipment having a total mass not exceeding 18 kg, and for material and components located inside fire enclosures (see 4.7.3.2 and 4.7.3.4)		N/A
A.2.1	Samples, material.....		—
	Wall thickness (mm).....		—
A.2.2	Conditioning of samples; temperature (°C)		N/A
A.2.3	Mounting of samples		N/A
A.2.4	Test flame (see IEC 60695-11-4)		N/A

IEC 60950-1			
Clause	Requirement + Test	Result - Remark	Verdict
	Flame A, B or C		—
A.2.5	Test procedure		N/A
A.2.6	Compliance criteria		N/A
	Sample 1 burning time (s)		—
	Sample 2 burning time (s)		—
	Sample 3 burning time (s)		—
A.2.7	Alternative test acc. to IEC 60695-11-5, cl. 5 and 9		N/A
	Sample 1 burning time (s)		—
	Sample 2 burning time (s)		—
	Sample 3 burning time (s)		—
A.3	Hot flaming oil test (see 4.6.2)		N/A
A.3.1	Mounting of samples		N/A
A.3.2	Test procedure		N/A
A.3.3	Compliance criterion		N/A
B	ANNEX B, MOTOR TESTS UNDER ABNORMAL CONDITIONS (see 4.7.2.2 and 5.3.2)		N/A
B.1	General requirements		N/A
	Position		—
	Manufacturer		—
	Type		—
	Rated values		—
B.2	Test conditions		N/A
B.3	Maximum temperatures		N/A
B.4	Running overload test		N/A
B.5	Locked-rotor overload test		N/A
	Test duration (days)		—
	Electric strength test: test voltage (V)		—
B.6	Running overload test for d.c. motors in secondary circuits		N/A
B.6.1	General		N/A
B.6.2	Test procedure		N/A
B.6.3	Alternative test procedure		N/A
B.6.4	Electric strength test; test voltage (V)		N/A
B.7	Locked-rotor overload test for d.c. motors in secondary circuits		N/A

IEC 60950-1			
Clause	Requirement + Test	Result - Remark	Verdict
B.7.1	General		N/A
B.7.2	Test procedure		N/A
B.7.3	Alternative test procedure		N/A
B.7.4	Electric strength test; test voltage (V):		N/A
B.8	Test for motors with capacitors		N/A
B.9	Test for three-phase motors		N/A
B.10	Test for series motors		N/A
	Operating voltage (V):		—
C	ANNEX C, TRANSFORMERS (see 1.5.4 and 5.3.3)		P
	Position:	See appended table 1.5.1.	—
	Manufacturer:	See appended table 1.5.1.	—
	Type:	See appended table 1.5.1.	—
	Rated values:	See appended table 1.5.1.	—
	Method of protection :	By protection circuit.	—
C.1	Overload test	(see appended table 5.3)	P
C.2	Insulation	(see appended table 5.2)	P
	Protection from displacement of windings :	Fixed by insulation tape.	P
D	ANNEX D, MEASURING INSTRUMENTS FOR TOUCH-CURRENT TESTS (see 5.1.4)		P
D.1	Measuring instrument		P
D.2	Alternative measuring instrument		N/A
E	ANNEX E, TEMPERATURE RISE OF A WINDING (see 1.4.13)		N/A
F	ANNEX F, MEASUREMENT OF CLEARANCES AND CREEPAGE DISTANCES (see 2.10 and Annex G)		P

IEC 60950-1			
Clause	Requirement + Test	Result - Remark	Verdict
G	ANNEX G, ALTERNATIVE METHOD FOR DETERMINING MINIMUM CLEARANCES		N/A
G.1	Clearances		N/A
G.1.1	General		N/A
G.1.2	Summary of the procedure for determining minimum clearances		N/A
G.2	Determination of mains transient voltage (V)		N/A
G.2.1	AC mains supply		N/A
G.2.2	Earthed d.c. mains supplies		N/A
G.2.3	Unearthed d.c. mains supplies		N/A
G.2.4	Battery operation		N/A
G.3	Determination of telecommunication network transient voltage (V)		N/A
G.4	Determination of required withstand voltage (V)		N/A
G.4.1	Mains transients and internal repetitive peaks		N/A
G.4.2	Transients from telecommunication networks		N/A
G.4.3	Combination of transients		N/A
G.4.4	Transients from cable distribution systems		N/A
G.5	Measurement of transient voltages (V)		N/A
	a) Transients from a mains supply		N/A
	For an a.c. mains supply		N/A
	For a d.c. mains supply		N/A
	b) Transients from a telecommunication network		N/A
G.6	Determination of minimum clearances		N/A
H	ANNEX H, IONIZING RADIATION (see 4.3.13)		N/A
J	ANNEX J, TABLE OF ELECTROCHEMICAL POTENTIALS (see 2.6.5.6)		P
	Metal(s) used	The internal metal enclosure is made of mild steel, screw spring washer are made of Ni on steel, the combined electrochemical potential is below 0.6V according to Table J.1.	—
K	ANNEX K, THERMAL CONTROLS (see 1.5.3 and 5.3.8)		N/A
K.1	Making and breaking capacity		N/A
K.2	Thermostat reliability; operating voltage (V)		N/A

IEC 60950-1			
Clause	Requirement + Test	Result - Remark	Verdict
K.3	Thermostat endurance test; operating voltage (V)		N/A
K.4	Temperature limiter endurance; operating voltage (V)		N/A
K.5	Thermal cut-out reliability		N/A
K.6	Stability of operation		N/A

L	ANNEX L, NORMAL LOAD CONDITIONS FOR SOME TYPES OF ELECTRICAL BUSINESS EQUIPMENT (see 1.2.2.1 and 4.5.2)		P
L.1	Typewriters		N/A
L.2	Adding machines and cash registers		N/A
L.3	Erasers		N/A
L.4	Pencil sharpeners		N/A
L.5	Duplicators and copy machines		N/A
L.6	Motor-operated files		N/A
L.7	Other business equipment	See 1.6.2.	P

M	ANNEX M, CRITERIA FOR TELEPHONE RINGING SIGNALS (see 2.3.1)		N/A
M.1	Introduction		N/A
M.2	Method A		N/A
M.3	Method B		N/A
M.3.1	Ringing signal		N/A
M.3.1.1	Frequency (Hz)		—
M.3.1.2	Voltage (V)		—
M.3.1.3	Cadence; time (s), voltage (V)		—
M.3.1.4	Single fault current (mA)		—
M.3.2	Tripping device and monitoring voltage		N/A
M.3.2.1	Conditions for use of a tripping device or a monitoring voltage		N/A
M.3.2.2	Tripping device		N/A
M.3.2.3	Monitoring voltage (V)		N/A

N	ANNEX N, IMPULSE TEST GENERATORS (see 1.5.7.2, 1.5.7.3, 2.10.3.9, 6.2.2.1, 7.3.2, 7.4.3 and Clause G.5)		N/A
N.1	ITU-T impulse test generators		N/A
N.2	IEC 60065 impulse test generator		N/A

IEC 60950-1			
Clause	Requirement + Test	Result - Remark	Verdict
P	ANNEX P, NORMATIVE REFERENCES		—
Q	ANNEX Q, Voltage dependent resistors (VDRs) (see 1.5.9.1)		N/A
	- Preferred climatic categories		N/A
	- Maximum continuous voltage		N/A
	- Combination pulse current		N/A
	Body of the VDR Test according to IEC60695-11-5		N/A
	Body of the VDR. Flammability class of material (min V-1)		N/A
R	ANNEX R, EXAMPLES OF REQUIREMENTS FOR QUALITY CONTROL PROGRAMMES		N/A
R.1	Minimum separation distances for unpopulated coated printed boards (see 2.10.6.2)		N/A
R.2	Reduced clearances (see 2.10.3)		N/A
S	ANNEX S, PROCEDURE FOR IMPULSE TESTING (see 6.2.2.3)		N/A
S.1	Test equipment		N/A
S.2	Test procedure		N/A
S.3	Examples of waveforms during impulse testing		N/A
T	ANNEX T, GUIDANCE ON PROTECTION AGAINST INGRESS OF WATER (see 1.1.2)		N/A
			—
U	Annex U, INSULATED WINDING WIRES FOR USE WITHOUT INTERLEAVED INSULATION (see 2.10.5.4)		P
		Approved triple insulated wire used in main transformer.	—
V	ANNEX V, AC POWER DISTRIBUTION SYSTEMS (see 1.6.1)		P
V.1	Introduction		P
V.2	TN power distribution systems		P
W	ANNEX W, SUMMATION OF TOUCH CURRENTS		N/A
W.1	Touch current from electronic circuits		N/A
W.1.1	Floating circuits		N/A

IEC 60950-1			
Clause	Requirement + Test	Result - Remark	Verdict
W.1.2	Earthed circuits		N/A
W.2	Interconnection of several equipments		N/A
W.2.1	Isolation		N/A
W.2.2	Common return, isolated from earth		N/A
W.2.3	Common return, connected to protective earth		N/A
X	ANNEX X, MAXIMUM HEATING EFFECT IN TRANSFORMER TESTS (see clause C.1)		N/A
X.1	Determination of maximum input current		N/A
X.2	Overload test procedure		N/A
Y	ANNEX Y, ULTRAVIOLET LIGHT CONDITIONING TEST (see 4.3.13.3)		N/A
Y.1	Test apparatus		N/A
Y.2	Mounting of test samples		N/A
Y.3	Carbon-arc light-exposure apparatus		N/A
Y.4	Xenon-arc light exposure apparatus		N/A
Z	ANNEX Z, OVERVOLTAGE CATEGORIES (see 2.10.3.2 and Clause G.2)		P
AA	ANNEX AA, MANDREL TEST (see 2.10.5.8)		N/A
BB	ANNEX BB, CHANGES IN THE SECOND EDITION		—
CC	ANNEX CC, Evaluation of integrated circuit (IC) current limiters		N/A
CC.1	General		N/A
CC.2	Test program 1		N/A
CC.3	Test program 2		N/A
CC.4	Test program 3		N/A
CC.5	Compliance		N/A
DD	ANNEX DD, Requirements for the mounting means of rack-mounted equipment		N/A
DD.1	General		N/A
DD.2	Mechanical strength test, variable N.....		N/A

IEC 60950-1			
Clause	Requirement + Test	Result - Remark	Verdict
DD.3	Mechanical strength test, 250 N, including end stops.....:		N/A
DD.4	Compliance.....:		N/A
EE	ANNEX EE, Household and home/office document/media shredders		N/A
EE.1	General		N/A
EE.2	Markings and instructions		N/A
	Use of markings or symbols.....:		N/A
	Information of user instructions, maintenance and/or servicing instructions.....:		N/A
EE.3	Inadvertent reactivation test.....:		N/A
EE.4	Disconnection of power to hazardous moving parts:		N/A
	Use of markings or symbols.....:		N/A
EE.5	Protection against hazardous moving parts		N/A
	Test with test finger (Figure 2A)		N/A
	Test with wedge probe (Figure EE1 and EE2)		N/A

IEC 60950-1			
Clause	Requirement + Test	Result - Remark	Verdict

1.5.1	TABLE: List of critical components					P
Object/part No.	Manufacturer/ trademark	Type/model	Technical data	Standard (Edition / year)	Mark(s) of conformity ¹	
LCD Panel for 18.5 inch model	TPV	TPM185B*_*_*_*_*_*_*_* (*can be 0-9, A-Z or blank)	18.5 inch panel with LED backlight The declared power consumption is 11.4W and backlight input voltage is 35.2V in specification.	IEC 60950-1	Tested in equipment	
	AUO	M185XW** (*can be 0-9, A-Z or blank)	18.5 inch panel with LED backlight The declared power consumption is 10.2W and backlight input voltage is 36V in specification.	IEC 60950-1	Tested in equipment	
	AUO	M185XTN** (*can be 0-9, A-Z or blank)	18.5 inch panel with LED backlight The declared power consumption is 7.8W and backlight input voltage is 25.2V in specification.	IEC 60950-1	Tested in equipment	
	BOE	HM185WX*_*_*_*_* (*can be 0-9, A-Z or blank)	18.5 inch panel with LED backlight The declared power consumption is 10.68W and backlight input voltage is 32V in specification.	IEC 60950-1	Tested in equipment	

IEC 60950-1					
Clause	Requirement + Test			Result - Remark	Verdict
	CHIMEI INNOLUX	M185B**_*** (*can be 0-9, A-Z or blank)	18.5 inch panel with LED backlight The declared power consumption is 11.11W and backlight input voltage is 27.2V in specification.	IEC 60950-1	Tested in equipment
	L&T	LM185WH*-**** (*can be 0-9, A-Z or blank)	18.5 inch panel with LED backlight The declared power consumption is 12.8W and backlight input voltage is 51.2V in specification.	IEC 60950-1	Tested in equipment
	SAMSUNG	LTM185AT** (*can be 0-9, A-Z or blank)	18.5 inch panel with LED backlight The declared power consumption is 11.9W and backlight input voltage is 35.2V in specification.	IEC 60950-1	Tested in equipment
	TPV	TPM185WH* (*can be 0-9, A-Z or blank)	18.5 inch panel with LED backlight The declared power consumption is 11.8W and backlight input voltage is 38.5V in specification.	IEC 60950-1	Tested in equipment

IEC 60950-1					
Clause	Requirement + Test			Result - Remark	Verdict
LCD Panel for 19.5 inch model	L&T	LM195WD*_***** (*can be 0-9, A-Z or blank)	19.5 inch panel with LED backlight The declared power consumption is 10.76W and backlight input voltage is 36.6V in specification.	IEC 60950-1	Tested in equipment
	CHIMEI INNOLUX	M195FGE-*** (*can be 0-9, A-Z or blank)	19.5 inch panel with LED backlight The declared power consumption is 13.83W and backlight input voltage is 28.8V in specification.	IEC 60950-1	Tested in equipment
	LG Display	LM195WD* (* can be 0-9, A-Z, a-z or blank for marketing purpose)	19.5 inch TFT type, with LED back light, power consumption: 12.02W; LED Array Voltage: 37.2V.	--	Tested in equipment
	TPV	TPM195WD*_*-***** (* can be 0-9, A-Z, a-z or blank for marketing purpose)	19.5 inch TFT type, with LED back light, power consumption: 15.16W; LED Array Voltage: 41.6V.	--	Tested in equipment
	AUO	M195RTN**** (* can be 0-9, A-Z, a-z or blank for marketing purpose)	19.5 inch TFT type, with LED back light, power consumption: 9.94W; LED Array Voltage: 31V.	--	Tested in equipment

IEC 60950-1					
Clause	Requirement + Test			Result - Remark	Verdict
LCD Panel for 21.5 inch model	TPV	TPM215HW**-* ***** (*can be 0-9, A-Z or blank)	21.5 inch panel with LED backlight The declared power consumption is 19.35W and backlight input voltage is 41.6V in specification.	IEC 60950-1	Tested in equipment
	AUO	M215HTN** (*can be 0-9, A-Z or blank)	21.5 inch panel with LED backlight The declared power consumption is 15.54W and backlight input voltage is 38.4V in specification.	IEC 60950-1	Tested in equipment
	CHIMEI INNOLUX	M215H**-* (*can be 0-9, A-Z or blank)	21.5 inch panel with LED backlight The declared power consumption is 16.97W and backlight input voltage is 34.65V in specification.	IEC 60950-1	Tested in equipment
	L&T	BM215WF*-* (*can be 0-9, A-Z or blank)	21.5 inch panel with LED backlight The declared power consumption is 16.3W and backlight input voltage is 51.2V in specification.	IEC 60950-1	Tested in equipment

IEC 60950-1					
Clause	Requirement + Test			Result - Remark	Verdict
	L&T	LM215WF*_*_*_*_* (* can be 0-9, A-Z or blank)	21.5 inch panel with LED backlight The declared power consumption is 14.35W and backlight input voltage is 45.0V in specification.	IEC 60950-1	Tested in equipment
	BOE	HR215WU*_*_*_* (* can be 0-9, A-Z, a-z for marketing purpose)	21.5 inch TFT type, with LED back light, power consumption: 24.87W; LED Array Voltage: 41.6V.	--	Tested in equipment
	BOE	HM215WU*_*_*_* (* can be 0-9, A-Z, a-z for marketing purpose)*	21.5 inch TFT type, with LED back light, power consumption: 17.19W; LED Array Voltage: 51.2V.	--	Tested in equipment
	SAMSUNG	LTM215HT** (* can be 0-9, A-Z and blank, for marketing purpose only)	21.5 inch TFT type, with LED back light, power consumption: 15.82W; LED Array Voltage: 52.8V	--	Tested in equipment
	AUO	M215HW** (* can be 0-9, A-Z and blank, for marketing purpose only)	21.5 inch TFT type, with LED back light, power consumption: 17W; LED Array Voltage: 52.8V.	--	Tested in equipment
	CHIMEI	M215H*-L** (* can be 0-9, A-Z and blank, for marketing purpose only)	21.5 inch TFT type, with LED back light, power consumption: 12.55W; LED Array Voltage: 41.V.	--	Tested in equipment

IEC 60950-1					
Clause	Requirement + Test			Result - Remark	Verdict
	LG Display	LM215WF* (* can be 0-9, A-Z and blank, for marketing purpose only)	21.5 inch TFT type, with LED back light, power consumption: 16.0W; LED Array Voltage: 57.6V.	--	Tested in equipment
	CPT	CLAA215FA** (* can be 0-9, A-Z and blank, for marketing purpose only)	21.5 inch TFT type, with LED back light, power consumption: 14.6W; LED Array Voltage: 41.6V.	--	Tested in equipment
	BOE	HT215F**.* (* can be 0-9, A-Z and blank, for marketing purpose only)	21.5 inch TFT type, with LED back light, power consumption: 16.56W; LED Array Voltage: 54.4V.	--	Tested in equipment
	AUO	T215HVN**** (* can be 0-9, A-Z and blank, for marketing purpose only)	21.5 inch TFT type, with LED back light, power consumption: 16.55W; LED Array Voltage: 54.4V.	--	Tested in equipment
	TPV	TPM215WF* (* can be 0-9, A-Z and blank, for marketing purpose only)	21.5 inch TFT type, with LED back light, power consumption: 14.9W; LED Array Voltage: 31.5V.	IEC 60950-1	Tested in equipment

IEC 60950-1					
Clause	Requirement + Test	Result - Remark			Verdict
Plastic enclosure	LOTTE ADVANCED MATERIALS CO LTD	SD-0150(+), VH-0810(+), VE-0812(+), NH-1000T(+)(&), GC- 0700(+++)(RR28) , GC-0700A(RR), GC- 0750(+)(RR70), GC- 1017(+)(RR30), VE-1890(+), BF-0675(+), BF-0670(+), NH-1017(p), NH-1017T, NH-1017SG(+), BF-0677(+), HS-7000(+), HG-0760(+), NE-1030(+), HR-1360(+), LX-0951(+), LX-0957(+), TH-1100(+), TN-1100(+)	HB or better, 2.0mm thickness min. 60 °C	UL 94	UL
	GRAND PACIFIC PETROCHEMIC AL CORP	D-150, D-1000, D-1000A	HB or better, 2.0mm thickness min. 60 °C	UL 94	UL
	CHI MEI CORPORATION	PA-757(+), PH-88, PA-756S	HB or better, 2.0mm thickness min. 60 °C	UL 94	UL
	ALBIS PLASTIC GMBH	GP-35, GP-22, 495F	HB or better, 2.0mm thickness min. 60 °C	UL 94	UL
	COVESTRO DEUTSCHLAND AG [PC RESINS]	FR3000 series, FR3005 series	HB or better, 2.0mm thickness min. 60 °C	UL 94	UL

IEC 60950-1					
Clause	Requirement + Test			Result - Remark	Verdict
	LG CHEM LTD	HF350(#), HF380(m), HF380NS, HF380(#), HF-380(#), HF-380(m), HF-380, HF-380NS, HF380X, AF312T1, AF342T1, LUPOY GN- 5001TF(#), GN-5001RFD, LUPOY GN- 5008HF(#), LUPOY GP- 5008BF(#), SE750(#), XG568(#), XG569(#), GP-1000L, GP-1000F(#), GP-1000(m)(#), LUMILOY GP- 1000(#), SE750(#), LUPOY GN- 5001RF(T), SE885(#), HF388(#)	HB or better, 2.0mm thickness min. 60°C	UL 94	UL

IEC 60950-1					
Clause	Requirement + Test		Result - Remark		Verdict
	KINGFA SCI & TECH CO LTD	4418, 5197, FRABS-518, HIPS-5197, HF-606, HF-626, FRABS-518, GAR-011C, JH960 6(M), FRHIPS-960, RS-900, RS-300, RS-400, GAR-011, GAR-011(L65), GAR-011(L85), GAR-011(HG6), CK-100, CK-900, CK-55111, JH960 6(M), FRHIPS-960, HIPS-4418, HIPS-3399, HIPS-CM(ee), HIPS-HG(ee), HIPS-510 (o), HIPS-550, CK-61(M) (##), RS-(hh)0, HP-126, ABS-660, ABS-122, GAR-322, GAR-332, GAR-220, H12, G360, CK-55(M) (##), CK-58(M) (##), GAR-011C, GAR-011(ww)	HB or better, 2.0mm thickness min. 60°C	UL 94	UL
	QINGDAO HAIER NEW MATERIAL R & D CO LTD	HRABS-RS, HRABS-HG, CR-3002	HB or better, 2.0mm thickness min. 60°C	UL 94	UL
	DONGGUAN HINGLONG PLASTIC TECHNOLOGY CO LTD	HL-ABS-PCR85, HL-ABS-PCR65, HL-ABS-PCR35	HB or better, 2.0mm thickness min. 60°C	UL 94	UL

IEC 60950-1					
Clause	Requirement + Test		Result - Remark		Verdict
	ORINKO (HEFEI) ADVANCED PLASTIC CO LTD	ABS-3070H, HIPS-2000	HB or better, 2.0mm thickness min. 60°C	UL 94	UL
	WISTRON ADVANCED MATERIALS (KUNSHAN) CO LTD	GA(M)(b)(c)	HB or better, 2.0mm thickness min. 60°C	UL 94	UL
	UNIC TECHNOLOGY CORP	UR-3006+(RXX), UR-200+	HB or better, 2.0mm thickness min. 60°C	UL 94	UL
	GUO HENG (DONGGUAN)	YOUHO(####)(Y)	HB or better, 2.0mm thickness min. 60°C	UL 94	UL
	HUIZHOU WOTE	2100	HB or better, 2.0mm thickness min. 60°C	UL 94	UL
	TEIJIN LIMITED RESIN AND PLASTIC	TN-7500(c), TN-7500F(#), MN-3600V(#), MN-3600H(#)	HB or better, 2.0mm thickness min. 60°C	UL 94	UL
	INEOS STYROLUTION GROUP GMBH	495F GR2, 495F KG2, 495F GR21, 495F KG21, PC2065	HB or better, 2.0mm thickness min. 60°C	UL 94	UL
	STYRON	STYRON A- TECH 1200	HB or better, 2.0mm thickness min. 60°C	UL 94	UL
	TOTAL PETROCHEMIC ALS SOUTH EAST ASIA PTE LTD	3441; 260-XX	HB or better, 2.0mm thickness min. 60°C	UL 94	UL
	DOOSAN CORPORATION ELECTRO- MATERIALS BG	DS-1107A; DS-1202G; DS-7106	HB or better, 2.0mm thickness min. 60°C	UL 94	UL
	SABIC JAPAN L L C	C6600(GG)(X)(V S), C6600E (VS)(X)	HB or better, 2.0mm thickness min. 60°C	UL 94	UL
	PONTEX	AFE5000N, AFE5100N, 9004BK	HB or better, 2.0mm thickness min. 60°C	UL 94	UL

IEC 60950-1					
Clause	Requirement + Test			Result - Remark	Verdict
	CHI LIN TECHNOLOGY CO LTD	GA-1(aaa), GA-1535	HB or better, 2.0mm thickness min. 60°C	UL 94	UL
Metal enclosure (except part under power board)	Interchangeable	Interchangeable	Metal thickness: min. 0.6mm	--	--
Metal enclosure (under power board)	Interchangeable	Interchangeable	Metal thickness: min. 0.81mm	--	--
Base stand (optional)	Interchangeable	Interchangeable	HB or better	UL 94	UL
PCB	Interchangeable	Interchangeable	V-1 or better, min. 105°C	UL 94	UL
Power supply board: 715G5527					
AC-Inlet (CN901)	Zhangjiagang Huajie Electronic Co., Ltd.	SA-4S, SA-4S 1	10A, 250V	IEC/ EN 60320-1, UL 498	VDE, UL
	Rong Feng Industrial Co., Ltd.	SS-120, SS-7B	10A, 250V	IEC/ EN 60320-1, UL 498	VDE, UL
	Shenzhen Delikang Electronics Technology Co. Ltd.	CDJ-3 CDJ-3-1	10A, 250V	IEC/ EN 60320-1, UL 498	VDE, UL
	Solteam Electronics Co. Ltd.	ST-01	10A, 250V	IEC/ EN 60320-1, UL 498	VDE, UL
	Solteam Electronics Co. Ltd.	VDE: SC04 UL: SC04-1BWW, SC04-2BTT	10A, 250V	IEC/ EN 60320-1, UL 498	VDE, UL
	Yueqing Hongchang Radio Co., Ltd	DB-14	10A, 250V	IEC/ EN 60320-1, UL 498	VDE, UL
Fuse (F901)	Conquer Electronics Co., Ltd.	MET series, MST, PTU	T3.15AL, 250Vac	IEC/ EN 60127-1, IEC/ EN 60127-3, UL 248	VDE, UL
	Littelfuse, Inc.	677 series	T3.15AL, 250Vac	IEC/ EN 60127-1, IEC/ EN 60127-3, UL 248	VDE, UL

IEC 60950-1					
Clause	Requirement + Test			Result - Remark	Verdict
	Littelfuse, Inc./ LITTELFUSE WICKMANN WERKE	392, 382-series	T3.15AL, 250Vac	IEC/ EN 60127- 1, IEC/ EN 60127- 3, UL 248	VDE, UL
	Cooper Bussmann LLC	SR-5, SS-5 series	T3.15AL, 250Vac	IEC/ EN 60127- 1, IEC/ EN 60127- 3, UL 248	VDE, UL
	Ever Island Electric Co. ltd and Walter electric	2000, 2010 series	T3.15AL, 250Vac	IEC/ EN 60127- 1, IEC/ EN 60127- 3, UL 248	VDE, UL
Fuse (F902) (optional)	Conquer Electronics Co., Ltd.	MET series, MST, PTU	T5AL, 250Vac	IEC/ EN 60127- 1, IEC/ EN 60127- 3, UL 248	VDE, UL
	Littelfuse, Inc.	677 series	T5AL, 250Vac	IEC/ EN 60127- 1, IEC/ EN 60127- 3, UL 248	VDE, UL
	Littelfuse, Inc./ LITTELFUSE WICKMANN WERKE	392, 382-series	T5AL, 250Vac	IEC/ EN 60127- 1, IEC/ EN 60127- 3, UL 248	VDE, UL
	Cooper Bussmann LLC	SR-5, SS-5 series	T5AL, 250Vac	IEC/ EN 60127- 1, IEC/ EN 60127- 3, UL 248	VDE, UL
	Ever Island Electric Co. ltd and Walter electric	2000, 2010 series	T5AL, 250Vac	IEC/ EN 60127- 1, IEC/ EN 60127- 3, UL 248	VDE, UL
Y- Capacitor (C902, C903) Y1 or Y2 type (optional)	Walsin Technology Corp.	AC, AH	Max. 4700pF, 250Vac, 85°C	IEC/EN 60384- 14, UL 1414	VDE, UL
	TDK Corporation	CS, CD	Max. 4700pF, 250Vac, 85°C	IEC/EN 60384- 14, UL 1414	VDE, UL
	Murata Mfg. Co., Ltd.	KH, KX	Max. 4700pF, 250Vac, 85°C	IEC/EN 60384- 14, UL 1414	VDE, UL

IEC 60950-1					
Clause	Requirement + Test		Result - Remark		Verdict
	Guangdong South Hongming Electronic Science and Technology Co., Ltd.	F	Max. 4700pF, 250Vac, 85°C	IEC/EN 60384-14, UL 1414	VDE, UL
	Kunshan Wansheng Electronics Co., Ltd.	CT7	Max. 4700pF, 250Vac, 85°C	IEC/EN 60384-14, UL 1414	VDE, UL
	Haohua Electronic Co	CT7	Max. 4700pF, 250Vac, 85°C	IEC/EN 60384-14, UL 1414	VDE, UL
	Samwha Capacitor Co., Ltd.	SD	Max. 4700pF, 250Vac, 85°C	IEC/EN 60384-14, UL 1414	VDE, UL
	Success Electronics Co., Ltd.	SB, SE	Max. 4700pF, 250Vac, 85°C	IEC/EN 60384-14, UL 1414	VDE, UL
	Yinan Don's Electronic Component Co., Ltd.	CT81	Max. 4700pF, 250Vac, 85°C	IEC/EN 60384-14, UL 1414	VDE, UL
Y- Capacitor (C900) Y1 type (optional)	Walsin Technology Corp.	AH	Max. 4700pF, 250Vac, 85°C	IEC/EN 60384-14, UL 1414	VDE, UL
	TDK Corporation	CD	Max. 4700pF, 250Vac, 85°C	IEC/EN 60384-14, UL 1414	VDE, UL
	Murata Mfg. Co., Ltd.	KX	Max. 4700pF, 250Vac, 85°C	IEC/EN 60384-14, UL 1414	VDE, UL
	Guangdong South Hongming Electronic Science and Technology Co., Ltd.	F	Max. 4700pF, 250Vac, 85°C	IEC/EN 60384-14, UL 1414	VDE, UL
	Kunshan Wansheng Electronics Co., Ltd.	CT7	Max. 4700pF, 250Vac, 85°C	IEC/EN 60384-14, UL 1414	VDE, UL
	Haohua Electronic Co	CT7	Max. 4700pF, 250Vac, 85°C	IEC/EN 60384-14, UL 1414	VDE, UL
	Samwha Capacitor Co., Ltd.	SD	Max. 4700pF, 250Vac, 85°C	IEC/EN 60384-14, UL 1414	VDE, UL

IEC 60950-1					
Clause	Requirement + Test			Result - Remark	Verdict
	Success Electronics Co., Ltd.	SB, SE	Max. 4700pF, 250Vac, 85°C	IEC/EN 60384-14, UL 1414	VDE, UL
	Yinan Don's Electronic Component Co., Ltd.	CT81	Max. 4700pF, 250Vac, 85°C	IEC/EN 60384-14, UL 1414	VDE, UL
X-Capacitor (X1 or X2 type) (C904) (optional)	Ultra Tech Xiphi Enterprise Co. Ltd.	HQX	Max. 0.22µF, 250Vac, 85°C	IEC/EN 60384-14, UL 1414	VDE, UL
	Xiamen Faratronic Co. Ltd.	MKP62	Max. 0.22µF, 250Vac, 85°C	IEC/EN 60384-14, UL 1414	VDE, UL
	Eurotronic	MPX, MPX2	Max. 0.22µF, 250Vac, 85°C	IEC/EN 60384-14, UL 1414	VDE, UL
	Liow Gu	GS-L	Max. 0.22µF, 250Vac, 85°C	IEC/EN 60384-14, UL 1414	VDE, UL
	Arcotronics	R.46	Max. 0.22µF, 250Vac, 85°C	IEC/EN 60384-14, UL 1414	ENEC(IMQ), UL
	ZhuHai Sung Ho Electronics Co., Ltd.	CMPP	Max. 0.22µF, 250Vac, 85°C	IEC/EN 60384-14, UL 1414	VDE, UL
	EPCOS	B3292#	Max. 0.22µF, 250Vac, 85°C	IEC/EN 60384-14, UL 1414	VDE, UL
	Nanjing Tengen Rongguangda Electronics (Group) Co., Ltd.	MKP	Max. 0.22µF, 250Vac, 85°C	IEC/EN 60384-14, UL 1414	VDE, UL
Photo Coupler (U902)	Sharp	PC123	Di=0.7mm, int.cr= thermal cycling ³⁾ , ext.cr=8.0mm, 3000Vac, 100°C	DIN EN 60747-5-2, UL1577	VDE, UL
	Everlight Electronics Co., Ltd.	EL817, EL817M	Di=0.5mm, int.cr=6.0mm, ext.cr=7.7mm, 3000Vac, 100°C	DIN EN 60747-5-2, UL1577	VDE, UL
	Everlight Electronics Co., Ltd.	EL1013	Di=0.4mm, int. cr=thermal cycling ³⁾ , ext. cr=8.0mm, 3000Vac, 100°C	DIN EN 60747-5-2, UL1577	VDE, UL

IEC 60950-1					
Clause	Requirement + Test			Result - Remark	Verdict
	Lite-on	LTV-817	Di=0.4mm, int.cr=4.0mm, ext.cr=8.0m, 3000Vac, 100 °C	DIN EN 60747- 5-2, UL1577	VDE, UL
	Renesas	PS2561-1, PS2561L-1, PS2561L1-1, PS2561L2-1, PS2561DL1-1,	Di=0.4mm, int.cr=thermal cycling ³⁾ , ext.cr=8.0mm, 3000Vac, 100 °C	DIN EN 60747- 5-2, UL1577	VDE, UL
	TOSHIBA	TLP781F, TLP781	Di=0.4mm, int.cr=thermal cycling ³⁾ , ext.cr=8.0mm, 3000Vac, 100 °C	DIN EN 60747- 5-2, UL1577	VDE, UL
	TOSHIBA	TLP421F	Di=0.4mm, int. cr=thermal cycling ³⁾ , ext. cr=8.0mm, 3000Vac, 100 °C	DIN EN 60747- 5-2, UL1577	VDE, UL
	VISHAY Semiconductor GmbH	TCET1103-3034	Di=Min. 0.4mm, int. cr=thermal cycling ³⁾ , ext. cr=8.0mm, 3000Vac, 100 °C	DIN EN 60747- 5-2, UL1577	VDE, UL
Thermistor (NR901)	Interchangeable	Interchangeable	Min. 3Ω at 25 °C, min. 2A	--	--
Bleeder Resistor (R900, R901, R902)	Interchangeable	SMD type	Max. 1MΩ, min. 1/4W	--	--
Bridging Diode (BD901)	Interchangeable	Interchangeable	Min.600V, min.2A	--	--
Ripple Capacitor (C907)	Interchangeable	Interchangeable	45-150μF, min. 450V, 105 °C	--	--
Line Choke (L901) (Optional)	Dadon	73G174-65-H	105 °C	--	--
	TPV	73G174-65-V	105 °C	--	--
	DARFON	73G174-65-DN	105 °C	--	--
	TaiChang	73G174-65-S	105 °C	--	--
	TDK	73G174-65-T	105 °C	--	--
	Litai	73G174-65-L	105 °C	--	--
	YUVA	73G174-65-N	105 °C	--	--
	ASET	73G174-65-X	105 °C	--	--

IEC 60950-1					
Clause	Requirement + Test			Result - Remark	Verdict
Transformer (T901) (Alt.)	YUVA	80GL19P-39-N	Class B	Applicable part according to IEC60950-1 and IEC 60085	Accepted by TÜV Rheinland
Bobbin	Sumitomo Bakelite Co., Ltd.	PM-9820	Phenolic, V-0, 150°C	UL94	UL
Margin tape	SYMBIO INC	35661 (c), 35660 (a), 35660Y (e)	130°C	UL510	UL
	3M	44 (a)	130°C	UL510	UL
Insulation tape	SYMBIO INC	35660Y (e)	130°C	UL510	UL
	JINGJIANG YAHUA	CT	130°C	UL510	UL
Transformer (T901) (Alt.)	TPV	80GL19P-39-V	Class B	Applicable part according to IEC60950-1 and IEC 60085	Accepted by TÜV Rheinland
Bobbin	Sumitomo Bakelite Co., Ltd.	PM-9820	Phenolic, V-0, 150°C	UL94	UL
Margin tape	SYMBIO INC	35661 (c), 35660 (a), 35660Y (e)	130°C	UL510	UL
Insulation tape	SYMBIO INC	35660Y (e)	130°C	UL510	UL
Transformer (T901) (Alt.)	TAICHANG	80GL19P-39-S	Class B	Applicable part according to IEC60950-1 and IEC 60085	Accepted by TÜV Rheinland
Bobbin	Sumitomo Bakelite Co., Ltd.	PM-9820	Phenolic, V-0, 150°C	UL94	UL
Margin tape	JINGJIANG YAHUA	WF* (c)(h)	130°C	UL510	UL
Insulation tape	JINGJIANG YAHUA	CT	130°C	UL510	UL
Transformer (T901) (Alt.)	CHENPING	80GL19P-39-CP	Class B	Applicable part according to IEC60950-1 and IEC 60085	Accepted by TÜV Rheinland
Bobbin	Sumitomo Bakelite Co., Ltd.	PM-9820 PM-9630	Phenolic, V-0, 150°C	UL94	UL
Margin tape	SYMBIO INC	35661 (c), 35660 (a), 35660Y (e)	130°C	UL510	UL
	JINGJIANG YAHUA	WF* (c)(h)	130°C	UL510	UL

IEC 60950-1					
Clause	Requirement + Test			Result - Remark	Verdict
Insulation tape	JINGJIANG YAHUA	CT	130°C	UL510	UL
Power supply board: 715G6503					
AC-Inlet (CN901)	Zhangjiagang Huajie Electronic Co., Ltd.	SA-4S, SA-4S 1	10A, 250V	IEC/ EN 60320- 1, UL 498	VDE, UL
	Rong Feng Industrial Co., Ltd.	SS-120, SS-7B	10A, 250V	IEC/ EN 60320- 1, UL 498	VDE, UL
	Shenzhen Delikang Electronics Technology Co. Ltd.	CDJ-3 CDJ-3-1	10A, 250V	IEC/ EN 60320- 1, UL 498	VDE, UL
	Solteam Electronics Co. Ltd.	ST-01	10A, 250V	IEC/ EN 60320- 1, UL 498	VDE, UL
	Solteam Electronics Co. Ltd.	VDE: SC04 UL: SC04-1BWW, SC04-2BTT	10A, 250V	IEC/ EN 60320- 1, UL 498	VDE, UL
	Yueqing Hongchang Radio Co., Ltd	DB-14	10A, 250V	IEC/ EN 60320- 1, UL 498	VDE, UL
Fuse (F901 in primary)	Conquer Electronics Co., Ltd.	MET series, MST, PTU	T2.5AL, 250Vac	IEC/ EN 60127- 1, IEC/ EN 60127- 3, UL 248	VDE, UL
	Littelfuse, Inc.	677 series	T2.5AL, 250Vac	IEC/ EN 60127- 1, IEC/ EN 60127- 3, UL 248	VDE, UL
	Littelfuse, Inc./ LITTELFUSE WICKMANN WERKE	392, 382-series	T2.5AL, 250Vac	IEC/ EN 60127- 1, IEC/ EN 60127- 3, UL 248	VDE, UL
	Cooper Bussmann LLC	SR-5, SS-5 series	T2.5AL, 250Vac	IEC/ EN 60127- 1, IEC/ EN 60127- 3, UL 248	VDE, UL

IEC 60950-1					
Clause	Requirement + Test			Result - Remark	Verdict
	Ever Island Electric Co. ltd and Walter electric	2000, 2010 series	T2.5AL, 250Vac	IEC/ EN 60127-1, IEC/ EN 60127-3, UL 248	VDE, UL
Y- Capacitor (C903) (Y1 or Y2 type) (optional)	Walsin Technology Corp.	AC, AH	Max. 4700pF, 250Vac, 85°C	IEC/EN 60384-14, UL 1414	VDE, UL
	TDK Corporation	CS, CD	Max. 4700pF, 250Vac, 85°C	IEC/EN 60384-14, UL 1414	VDE, UL
	Murata Mfg. Co., Ltd.	KH, KX	Max. 4700pF, 250Vac, 85°C	IEC/EN 60384-14, UL 1414	VDE, UL
	Guangdong South Hongming Electronic Science and Technology Co., Ltd.	F	Max. 4700pF, 250Vac, 85°C	IEC/EN 60384-14, UL 1414	VDE, UL
	Kunshan Wansheng Electronics Co., Ltd.	CT7	Max. 4700pF, 250Vac, 85°C	IEC/EN 60384-14, UL 1414	VDE, UL
	Haohua Electronic Co	CT7	Max. 4700pF, 250Vac, 85°C	IEC/EN 60384-14, UL 1414	VDE, UL
	Samwha Capacitor Co., Ltd.	SD	Max. 4700pF, 250Vac, 85°C	IEC/EN 60384-14, UL 1414	VDE, UL
	Success Electronics Co., Ltd.	SB, SE	Max. 4700pF, 250Vac, 85°C	IEC/EN 60384-14, UL 1414	VDE, UL
	Yinan Don's Electronic Component Co., Ltd.	CT81	Max. 4700pF, 250Vac, 85°C	IEC/EN 60384-14, UL 1414	VDE, UL
Y- Capacitor (C902, C913) (Y1 type) (optional)	Walsin Technology Corp.	AH	Max. 4700pF, 250Vac, 85°C	IEC/EN 60384-14, UL 1414	VDE, UL
	TDK Corporation	CD	Max. 4700pF, 250Vac, 85°C	IEC/EN 60384-14, UL 1414	VDE, UL
	Murata Mfg. Co., Ltd.	KX	Max. 4700pF, 250Vac, 85°C	IEC/EN 60384-14, UL 1414	VDE, UL

IEC 60950-1					
Clause	Requirement + Test		Result - Remark		Verdict
	Guangdong South Hongming Electronic Science and Technology Co., Ltd.	F	Max. 4700pF, 250Vac, 85°C	IEC/EN 60384-14, UL 1414	VDE, UL
	Kunshan Wansheng Electronics Co., Ltd.	CT7	Max. 4700pF, 250Vac, 85°C	IEC/EN 60384-14, UL 1414	VDE, UL
	Haohua Electronic Co	CT7	Max. 4700pF, 250Vac, 85°C	IEC/EN 60384-14, UL 1414	VDE, UL
	Samwha Capacitor Co., Ltd.	SD	Max. 4700pF, 250Vac, 85°C	IEC/EN 60384-14, UL 1414	VDE, UL
	Success Electronics Co., Ltd.	SB, SE	Max. 4700pF, 250Vac, 85°C	IEC/EN 60384-14, UL 1414	VDE, UL
	Yinan Don's Electronic Component Co., Ltd.	CT81	Max. 4700pF, 250Vac, 85°C	IEC/EN 60384-14, UL 1414	VDE, UL
X-Capacitor (C901) (X1 or X2 type) (optional)	Ultra Tech Xiphi Enterprise Co. Ltd.	HQX	Max. 0.22μF, 250Vac, 85°C	IEC/ EN 60384-14	VDE, UL
	Xiamen Faratronic Co. Ltd.	MKP62	Max. 0.22μF, 250Vac, 85°C	IEC/ EN 60384-14	VDE, UL
	Europtronic	MPX, MPX2	Max. 0.22μF, 250Vac, 85°C	IEC/ EN 60384-14	VDE, UL
	Liow Gu	GS-L	Max. 0.22μF, 250Vac, 85°C	IEC/ EN 60384-14	VDE, UL
	Arcotronics	R.46	Max. 0.22μF, 250Vac, 85°C	IEC/ EN 60384-14	ENEC(IMQ), UL
	ZhuHai Sung Ho Electronics Co., Ltd.	CMPP	Max. 0.22μF, 250Vac, 85°C	IEC/ EN 60384-14	VDE, UL
	EPCOS	B3292#	Max. 0.22μF, 250Vac, 85°C	IEC/ EN 60384-14	VDE, UL
	Nanjing Tengen Rongguangda Electronics (Group) Co., Ltd.	MKP	Max. 0.22μF, 250Vac, 85°C	IEC/ EN 60384-14	VDE, UL
Thermistor (NR901)	Interchangeable	Interchangeable	Min. 0.2Ω at 25°C, min. 2A	--	--

IEC 60950-1					
Clause	Requirement + Test			Result - Remark	Verdict
Bleeder Resistor (R907, R908, R909)	Interchangeable	SMD type	Max. 1MΩ, min. 1/4W	--	--
Bridging Diode (BD901)	Interchangeable	Interchangeable	Min.600V, min.2A	--	--
Ripple Capacitor (C907)	Interchangeable	Interchangeable	45-150μF, max. 400V, 105°C	--	--
Line Choke (L901) (Optional)	Dadon	73G174-192-H	105°C	--	--
	Prosperity Dielectrics	73G174-192-F	105°C	--	--
	ASET	73G174-192-X	105°C	--	--
	TaiCheng	73G174-192-S	105°C	--	--
	Litai	73G174-192-L	105°C	--	--
	Darfon	73G174-192-DN	105°C	--	--
	YUVA	73G174-192-N	105°C	--	--
	Transformer (T902) (Alt.)	Chanelon	380GL19P535H00	Class B	Applicable part according to IEC60950-1 and IEC 60085
Bobbin	Sumitomo	PM-9820	V-0, Phenolic, 150°C	UL 94	UL
Triple insulation wire	Cosmolink	TIW-M	Max.130°C	IEC/EN 60950-1, VDE0805 Teil1, UL 2353	UL, VDE
Teflon tube	GREAT HOLDING	TFL	200°C	UL 224	UL
Insulation Tape	Jingjiang Symbio	CT 35660Y (e)	130°C	UL 510	UL
Transformer (T902) (Alt.)	YUVA	380GL19P535N00	Class B	Applicable part according to IEC60950-1 and IEC 60085	Accepted by TÜV Rheinland
Bobbin	Sumitomo	PM-9820	V-0, Phenolic, 150°C	UL 94	UL
Triple insulation wire	Cosmolink	TIW-M	Max.130°C	IEC/EN 60950-1, VDE0805 Teil1, UL 2353	UL, VDE
Teflon tube	GREAT HOLDING	TFL	200°C	UL 224	UL

IEC 60950-1					
Clause	Requirement + Test			Result - Remark	Verdict
Insulation Tape	Jingjiang Symbio	CT 35660Y (e)	130°C	UL 510	UL
Transformer (T902) (Alt.)	TPV	S80GL19P535V00	Class B	Applicable part according to IEC60950-1 and IEC 60085	Accepted by TÜV Rheinland
Bobbin	Sumitomo	PM-9820	V-0, Phenolic, 150°C	UL 94	UL
Triple insulation wire	Furukawa	TEX-E	Max.130°C	IEC/EN 60950-1, VDE0805 Teil1, UL 2353	UL, VDE
Teflon tube	GREAT HOLDING	TFL	200°C	UL 224	UL
Insulation Tape	Jingjiang Symbio	CT 35660Y (e)	130°C	UL 510	UL
Power supply board: 715G7300					
AC-Inlet (CN901)	Zhangjiagang Huajie Electronic Co., Ltd.	SA-4S, SA-4S 1	10A, 250Vac	IEC/ EN 60320-1, UL 498	VDE, UL
Alt.	Rong Feng Industrial Co., Ltd.	SS-120, SS-7B	10A, 250Vac	IEC/ EN 60320-1, UL 498	VDE, UL
Alt.	Shenzhen Delikang Electronics Technology Co. Ltd.	CDJ-3 CDJ-3-1	10A, 250Vac	IEC/ EN 60320-1, UL 498	VDE, UL
Alt.	Solteam Electronics Co. Ltd.	ST-01	10A, 250Vac	IEC/ EN 60320-1, UL 498	VDE, UL
Alt.	Solteam Electronics Co. Ltd.	VDE: SC04 UL: SC04-1BWW, SC04-2BTT	10A, 250Vac	IEC/ EN 60320-1, UL 498	VDE, UL
Alt.	Yueqing Hongchang Radio Co., Ltd	DB-14	10A, 250Vac	IEC/ EN 60320-1, UL 498	VDE, UL
Fuse (F901 for primary)	Conquer Electronics Co., Ltd.	MET series, MST, PTU	T3.15AL, 250Vac	IEC/ EN 60127-1, IEC/ EN 60127-3, UL 248	VDE, UL

IEC 60950-1					
Clause	Requirement + Test			Result - Remark	Verdict
Alt.	Littelfuse, Inc.	677 series	T3.15AL, 250Vac	IEC/ EN 60127-1, IEC/ EN 60127-3, UL 248	VDE, UL
Alt.	Littelfuse, Inc./ LITTELFUSE WICKMANN WERKE	392, 382-series	T3.15AL, 250Vac	IEC/ EN 60127-1, IEC/ EN 60127-3, UL 248	VDE, UL
Alt.	Cooper Bussmann LLC	SR-5, SS-5 series	T3.15AL, 250Vac	IEC/ EN 60127-1, IEC/ EN 60127-3, UL 248	VDE, UL
Alt.	Ever Island Electric Co. ltd and Walter electric	2000, 2010 series	T3.15AL, 250Vac	IEC/ EN 60127-1, IEC/ EN 60127-3, UL 248	VDE, UL
Y- Capacitors (C902, C903) (Optional) (Y1 or Y2 type)	Walsin Technology Corp.	AC, AH	1000pF, min. 250V, 125°C	IEC/EN 60384-14 UL1414	VDE, UL
Alt.	TDK Corporation	CS, CD	1000pF, min. 250V, 125°C	IEC/EN 60384-14 UL1414	VDE, UL
Alt.	Murata Mfg. Co., Ltd.	KH, KX	1000pF, min. 250V, 125°C	IEC/EN 60384-14 UL1414	VDE, UL
Alt.	Guangdong South Hongming Electronic Science and Technology Co., Ltd.	F	1000pF, min. 250V, 125°C	IEC/EN 60384-14 UL1414	VDE, UL
Alt.	Kunshan Wansheng Electronics Co., Ltd.	CT7	1000pF, min. 250V, 125°C	IEC/EN 60384-14 UL1414	VDE, UL
Alt.	Haohua Electronic Co	CT7	1000pF, min. 250V, 125°C	IEC/EN 60384-14 UL1414	VDE, UL
Alt.	Samwha Capacitor Co., Ltd.	SD	1000pF, min. 250V, 125°C	IEC/EN 60384-14 UL1414	VDE, UL

IEC 60950-1					
Clause	Requirement + Test			Result - Remark	Verdict
Alt.	Success Electronics Co., Ltd.	SB, SE	1000pF, min. 250V, 125°C	IEC/EN 60384-14 UL1414	VDE, UL
Alt.	Yinan Don's Electronic Component Co., Ltd.	CT81	1000pF, min. 250V, 125°C	IEC/EN 60384-14 UL1414	VDE, UL
Y- Capacitors (C913) (Optional) (Y1 type)	Walsin Technology Corp.	AC, AH	2200pF, min. 250V, 125°C	IEC/EN 60384-14 UL1414	VDE, UL
Alt.	TDK Corporation	CS, CD	2200pF, min. 250V, 125°C	IEC/EN 60384-14 UL1414	VDE, UL
Alt.	Murata Mfg. Co., Ltd.	KH, KX	2200pF, min. 250V, 125°C	IEC/EN 60384-14 UL1414	VDE, UL
Alt.	Guangdong South Hongming Electronic Science and Technology Co., Ltd.	F	2200pF, min. 250V, 125°C	IEC/EN 60384-14 UL1414	VDE, UL
Alt.	Kunshan Wansheng Electronics Co., Ltd.	CT7	2200pF, min. 250V, 125°C	IEC/EN 60384-14 UL1414	VDE, UL
Alt.	Haohua Electronic Co	CT7	2200pF, min. 250V, 125°C	IEC/EN 60384-14 UL1414	VDE, UL
Alt.	Samwha Capacitor Co., Ltd.	SD	2200pF, min. 250V, 125°C	IEC/EN 60384-14 UL1414	VDE, UL
Alt.	Success Electronics Co., Ltd.	SB, SE	2200pF, min. 250V, 125°C	IEC/EN 60384-14 UL1414	VDE, UL
Alt.	Yinan Don's Electronic Component Co., Ltd.	CT81	2200pF, min. 250V, 125°C	IEC/EN 60384-14 UL1414	VDE, UL
X-Capacitor (C901) (Optional) (X1 or X2 type)	Ultra Tech Xiphi Enterprise Co. Ltd.	HQX	Max. 0.22µF, min. 250Vac, min. 85°C	IEC/EN 60384-14 UL1414	VDE, UL

IEC 60950-1					
Clause	Requirement + Test			Result - Remark	Verdict
Alt.	Xiamen Faratronic Co. Ltd.	MKP62	Max. 0.22 μ F, min. 250Vac, min. 85 $^{\circ}$ C	IEC/EN 60384-14 UL1414	VDE, UL
Alt.	Eurotronic	MPX, MPX2	Max. 0.22 μ F, min. 250Vac, min. 85 $^{\circ}$ C	IEC/EN 60384-14 UL1414	VDE, UL
Alt.	Liow Gu	GS-L	Max. 0.22 μ F, min. 250Vac, min. 85 $^{\circ}$ C	IEC/EN 60384-14 UL1414	VDE, UL
Alt.	Arcotronics	R.46	Max. 0.22 μ F, min. 250Vac, min. 85 $^{\circ}$ C	IEC/EN 60384-14 UL1414	VDE, UL
Alt.	ZhuHai Sung Ho Electronics Co., Ltd.	CMPP	Max. 0.22 μ F, min. 250Vac, min. 85 $^{\circ}$ C	IEC/EN 60384-14 UL1414	VDE, UL
Alt.	EPCOS	B3292#	Max. 0.22 μ F, min. 250Vac, min. 85 $^{\circ}$ C	IEC/EN 60384-14 UL1414	VDE, UL
Alt.	Nanjing Tengen Rongguangda Electronics (Group) Co., Ltd.	MKP	Max. 0.22 μ F, min. 250Vac, min. 85 $^{\circ}$ C	IEC/EN 60384-14 UL1414	VDE, UL
Bleeder resistor (R907, R908, R909)	Interchangeable	SMD type	1M Ω , min. 1/4W for each	--	--
Bridging rectifier (BD901)	Interchangeable	Interchangeable	Min. 2A, min. 500Vac	--	--
Ripple capacitor (C907)	Interchangeable	Interchangeable	47-105 μ F, min. 450V, min. 105 $^{\circ}$ C	--	--
Thermistor (NR901)	Interchangeable	Interchangeable	Min. 3 Ω at 25 $^{\circ}$ C, min. 2A	--	--
MOSFET (Q901)	Interchangeable	Interchangeable	Min. 500V, min. 2A	--	--
Line choke (L901) (Optional)	Jiangsu Channelon Electronics Group Co., Ltd.	373G0174557H	Min. 105 $^{\circ}$ C	--	Tested in appliance
Alt.	LIANFENG	373G0174557J	Min. 105 $^{\circ}$ C	--	Tested in appliance
Alt.	LIAN ZHEN	373G0174557Z	Min. 105 $^{\circ}$ C	--	Tested in appliance

IEC 60950-1					
Clause	Requirement + Test			Result - Remark	Verdict
Opto-coupler (U902)	Sharp	PC123	Di=0.7mm, int.cr= thermal cycling ³ , ext.cr=8.0mm, 3000Vac, 100 °C	DIN EN 60747-5-2, UL1577	VDE, UL
	Everlight Electronics Co., Ltd.	EL817, EL817M	Di=0.5mm, int.cr=6.0mm, ext.cr=7.7mm, 3000Vac, 100 °C	DIN EN 60747-5-2, UL1577	VDE, UL
	Everlight Electronics Co., Ltd.	EL1013	Di=0.4mm, int. cr=thermal cycling ³ ext. cr=8.0mm, 3000Vac, 100 °C	DIN EN 60747-5-2, UL1577	VDE, UL
	Lite-on	LTV-817	Di=0.4mm, int.cr=4.0mm, ext.cr=8.0m, 3000Vac, 100 °C	DIN EN 60747-5-2, UL1577	VDE, UL
	Renesas	PS2561-1, PS2561L-1, PS2561L1-1, PS2561L2-1, PS2561DL1-1,	Di=0.4mm, int.cr=thermal cycling ³ , ext.cr=8.0mm, 3000Vac, 100 °C	DIN EN 60747-5-2, UL1577	VDE, UL
	TOSHIBA	TLP781F, TLP781	Di=0.4mm, int.cr=thermal cycling ³ , ext.cr=8.0mm, 3000Vac, 100 °C	DIN EN 60747-5-2, UL1577	VDE, UL
	TOSHIBA	TLP421F	Di=0.4mm, int. cr=thermal cycling ³ ext. cr=8.0mm, 3000Vac, 100 °C	DIN EN 60747-5-2, UL1577	VDE, UL
	VISHAY Semiconductor GmbH	TCET1103-3034	Di=Min. 0.4mm, int. cr=thermal cycling ³ ext. cr=8.0mm, 3000Vac, 100 °C	DIN EN 60747-5-2, UL1577	VDE, UL
Transformer (T902)	PHOENIX	380GL19P535P	130 °C, class B	--	Tested in appliance
	LFDJ	380GL19P535J	130 °C, class B	--	Tested in appliance
	TPV	S80GL19P535V	130 °C, class B	--	Tested in appliance
	YUVA	380GL19P535N	130 °C, class B	--	Tested in appliance

IEC 60950-1					
Clause	Requirement + Test			Result - Remark	Verdict
	Channelon	380GL19P535H	130°C, class B	--	Tested in appliance
- Bobbin	CHANG CHUN PLASTICS CO LTD	T375J, T375HF	Phenolic, V-0, 150°C	UL94	UL
	Sumitomo Bakelite Co., Ltd.	PM-9820, PM-8375, PM-9630	Phenolic, V-0, 150°C	UL94	UL
- Tape	3M	44 (a)	130°C	UL510	UL
	SYMBIO INC	35661 (c), 35660 (a), 35660Y (e)	130°C	UL510	UL
	JINGJIANG YAHUA PRESSURE SENSITIVE GLUE CO LTD	WF* (c)(h) CT, PZ* (b), yellow	130°C	UL510	UL
	JINGJIANG JINGYANG INSULATING PRODUCT CO LTD	JY-133	130°C	UL510	UL
- Triple insulated wire	Furukawa Electric Co., Ltd.	TEX-E	Reinforced insulated, 130°C, class B	IEC/EN 60950-1, UL 2353	VDE, UL
	COSMOLINK CO. Ltd.	TIW-M	Reinforced insulated, 130°C, class B	IEC/EN 60950-1, UL 2353	VDE, UL
	Great Leoflon Industrial Co., Ltd.	TRW(B)*	Reinforced insulated, 130°C, class B	IEC/EN 60950-1, UL 2353	VDE, UL
	SUZHOU YUSHENG ELECTRONIC CO LTD	TIW-B(x)	Reinforced insulated, 130°C, class B	IEC/EN 60950-1, UL 2353	VDE, UL
- Tube	GREAT HOLDING INDUSTRIAL CO LTD	TFL	200°C, VW-1	UL224	UL

IEC 60950-1			
Clause	Requirement + Test	Result - Remark	Verdict

Supplementary information:

1. An asterisk indicates a mark that assures the agreed level of surveillance.
2. In the technical data column of optocoupler, where "Dti" means distance through insulation, "Int. cr" means internal creepage distance, and "Ext. cr" means external creepage distance.
3. There is no any internal creepage distance. Test according to IEC60950-1:2001, cl. 2.10.8 (same as requirement in IEC60950-1:2005, cl. 2.10.9) has been carried out ten times for the components at 100°C / 25°C / 0°C / 25°C. Humidity treatment of 48 hours as well as electric strength tests at 3000V / 1 minute was carried out to the component after thermal cycling test.
4. All sources of photo coupler were certified according to DIN EN60747-5-2 which in compliance with the requirements and provisions of IEC 60747-5-5.
5. All sources of photo coupler were in compliance with CTL DSH 759 decision.
6. All sources of transformer were checked with same construction.

1.5.1	TABLE: Opto Electronic Devices	P
Manufacturer	See appended table 1.5.1 (List of critical components)	
Type.....	See appended table 1.5.1 (List of critical components)	
Separately tested.....	Tested with appliance	
Bridging insulation	Reinforced insulation.	
External creepage distance	See appended table 1.5.1 (List of critical components)	
Internal creepage distance	See appended table 1.5.1 (List of critical components)	
Distance through insulation	See appended table 1.5.1 (List of critical components)	
Tested under the following conditions		
Input.....	Tested with appliance	
Output.....	Tested with appliance	
Supplementary information:		

IEC 60950-1						
Clause	Requirement + Test				Result - Remark	Verdict
1.6.2	TABLE: electrical data (in normal conditions)					P
U (V)	I (A)	Irated (A)	P (W)	Fuse #	Ifuse (A)	Condition/status
Test on 18.5 inch model with power board 715G5527, main board 715G5965, panel LM185WH*-**** (L&T), VGA mode						
90/50	0.24	--	13.4	F901	0.24	Maximum normal load
90/60	0.24	--	13.4	F901	0.24	Maximum normal load
100/50	0.23	1.5	13.3	F901	0.23	Maximum normal load
100/60	0.23	1.5	13.3	F901	0.23	Maximum normal load
240/50	0.13	1.5	13.1	F901	0.13	Maximum normal load
240/60	0.13	1.5	13.1	F901	0.13	Maximum normal load
264/50	0.12	--	13.2	F901	0.12	Maximum normal load
264/60	0.12	--	13.2	F901	0.12	Maximum normal load
Test on 21.5 inch model with power board 715G5527, main board 715G5864, panel TPM215HW**-*****, VGA mode						
90/50	0.31	--	16.9	F901	0.24	Maximum normal load
90/60	0.31	--	16.9	F901	0.24	Maximum normal load
100/50	0.28	1.5	16.8	F901	0.23	Maximum normal load
100/60	0.28	1.5	16.8	F901	0.23	Maximum normal load
240/50	0.15	1.5	16.6	F901	0.13	Maximum normal load
240/60	0.15	1.5	16.6	F901	0.13	Maximum normal load
264/50	0.14	--	16.6	F901	0.12	Maximum normal load
264/60	0.14	--	16.6	F901	0.12	Maximum normal load
Test on 19.5 inch model with power board 715G5527, main board 715G5846, panel M195FGE-*** (CHIMEI INNOLUX), VGA mode						
90/50	0.30	--	16.2	F901	0.30	Maximum normal load
90/60	0.30	--	16.2	F901	0.30	Maximum normal load
100/50	0.28	1.5	16.2	F901	0.28	Maximum normal load
100/60	0.28	1.5	16.2	F901	0.28	Maximum normal load
240/50	0.17	1.5	16.1	F901	0.17	Maximum normal load
240/60	0.17	1.5	16.1	F901	0.17	Maximum normal load
264/50	0.15	--	16.0	F901	0.15	Maximum normal load
264/60	0.15	--	16.0	F901	0.15	Maximum normal load
Test on 18.5 inch model with panel LM185WH*-**** (L&T), power board 715G6503, main board 715G6851 type A, VGA mode						
90/50	0.23	--	12.0	F901	0.23	Maximum normal load

IEC 60950-1						
Clause	Requirement + Test				Result - Remark	Verdict
90/60	0.23	--	12.0	F901	0.23	Maximum normal load
100/50	0.21	1.5	11.8	F901	0.21	Maximum normal load
100/60	0.21	1.5	11.8	F901	0.21	Maximum normal load
240/50	0.12	1.5	12.0	F901	0.12	Maximum normal load
240/60	0.12	1.5	12.0	F901	0.12	Maximum normal load
264/50	0.11	--	12.1	F901	0.11	Maximum normal load
264/60	0.11	--	12.1	F901	0.11	Maximum normal load
Test on 19.5 inch model with panel TPM195WD*-*-* (TPV), power board 715G6503, main board 715G6851 type A, VGA mode						
90/50	0.30	--	16.7	F901	0.30	Maximum normal load
90/60	0.30	--	16.7	F901	0.30	Maximum normal load
100/50	0.28	1.5	16.4	F901	0.28	Maximum normal load
100/60	0.28	1.5	16.4	F901	0.28	Maximum normal load
240/50	0.15	1.5	16.5	F901	0.15	Maximum normal load
240/60	0.15	1.5	16.5	F901	0.15	Maximum normal load
264/50	0.14	--	16.5	F901	0.14	Maximum normal load
264/60	0.14	--	16.5	F901	0.14	Maximum normal load
Test on 21.5 inch model with panel HR215WU*-*-* (BOE), power board 715G6503, main board 715G6851 type A, VGA mode						
90/50	0.37	--	20.6	F901	0.37	Maximum normal load
90/60	0.37	--	20.6	F901	0.37	Maximum normal load
100/50	0.34	1.5	20.2	F901	0.34	Maximum normal load
100/60	0.34	1.5	20.2	F901	0.34	Maximum normal load
240/50	0.18	1.5	19.7	F901	0.18	Maximum normal load
240/60	0.18	1.5	19.7	F901	0.18	Maximum normal load
264/50	0.17	--	19.8	F901	0.17	Maximum normal load
264/60	0.17	--	19.8	F901	0.17	Maximum normal load
Test on 21.5 inch model with panel HR215WU*-*-* (BOE), power board 715G7300, main board 715G6851 type B, VGA mode						
90/50	0.25	--	13.6	F901	0.25	Maximum normal load
90/60	0.25	--	13.7	F901	0.25	Maximum normal load
100/50	0.23	1.5	13.5	F901	0.23	Maximum normal load
100/60	0.23	1.5	13.6	F901	0.23	Maximum normal load
240/50	0.13	1.5	13.0	F901	0.13	Maximum normal load
240/60	0.13	1.5	13.4	F901	0.13	Maximum normal load

IEC 60950-1						
Clause	Requirement + Test				Result - Remark	Verdict
264/50	0.12	--	13.1	F901	0.12	Maximum normal load
264/60	0.12	--	13.3	F901	0.12	Maximum normal load
Supplementary information:						
Maximum normal load: maximum brightness, maximum contrast, full white screen.						

2.1.1.5 c) 1)	TABLE: max. V, A, VA test					P
Voltage (rated) (V)	Current (rated) (A)	Voltage (max.) (V)	Current (max.) (A)	VA (max.) (VA)		
Power board 715G5527						
+5V output	--	5.1	4.6	22		
+15V output	--	18.0	2.4	32		
Power board 715G6053						
+19V output	--	18.6	2.0	32.1		
Power board 715G7300						
+19V output	--	18.2	1.4	25.34		
supplementary information:						
Test voltage is 264Vac, 60Hz						

2.1.1.5 c) 2)	TABLE: stored energy			N/A
Capacitance C (μ F)	Voltage U (V)		Energy E (J)	
supplementary information:				

2.1.1.7	TABLE: discharge test				P
Condition	τ calculated (s)	τ measured (s)	t $u \rightarrow 0V$ (s)	Comments	
Power board 715G5527					
System on (with fuse in, L-N)	0.66	0.58	--	Vo=375Vpk, 37% of Vo=138.75Vpk.	

IEC 60950-1			
Clause	Requirement + Test	Result - Remark	Verdict
Supplementary information: Overall capacity: C904 = 0.22 μ F, Discharge resistor: R900(1M Ω) + R901(1M Ω) + R902(1M Ω) = 3M Ω , Supplied with 264V/60Hz.			
Power board 715G6053			
System on (with fuse in, L-N)	0.66	0.55	--
Vo=373Vpk, 37% of Vo=138Vpk.			
Supplementary information: Overall capacity: C901 = 0.22 μ F, Discharge resistor: R907(1M Ω) + R908(1M Ω) + R909(1M Ω) = 3M Ω , Supplied with 264V/60Hz.			
Power board 715G7300			
System on (with fuse in, L-N)	--	0.61	--
Vo= 373Vpk, 37% of Vo=138Vpk.			
Supplementary information: Overall capacity: C901= 0.22 μ F, Discharge resistor: R907(1M Ω) + R908(1M Ω) + R909(1M Ω) = 3M Ω , Supplied with 264V/60Hz.			

2.2	TABLE: evaluation of voltage limiting components in SELV circuits	P	
Component (measured between)	max. voltage (V) (normal operation)		Voltage Limiting Components
	V peak	V d.c.	
Power board 715G5527			
T901: Pin 6,7 - pin 10	22.7	--	
T901: Pin 8,9 - pin 10	51.0	--	
After R904 to earth	44.2	--	
After C910 to earth	24.7	--	
After C919/D903 to earth	--	13.8	C929/D901
After L801 to earth	--	21.7	
After D801 to earth (converter output)	--	35.1	
Fault test performed on voltage limiting components	Voltage measured (V) in SELV circuits (V peak or V d.c.)		
C910 short	16.6 (+15V to earth)		
D903 short	0 (+15V to earth)		
L801 short	0 (CN804 pin 3,4 to earth)		

IEC 60950-1			
Clause	Requirement + Test	Result - Remark	Verdict

Supplementary information: Input Voltage is 240Vac, 60Hz

2.2	TABLE: evaluation of voltage limiting components in SELV circuits			P
Component (measured between)	max. voltage (V) (normal operation)		Voltage Limiting Components	
	V peak	V d.c.		
Power board 715G6053				
T902: Pin 7,8 - pin 9,10	64.4	--		
After R916 to earth	51.7	--	R916	
After C915 to earth	50.9	--	C915	
After C921/D904 to earth	--	39.8	C921/D904	
After L801 to earth	--	26.7		
After CN802 Pin1 to earth (converter output)	--	26.7		
Fault test performed on voltage limiting components	Voltage measured (V) in SELV circuits (V peak or V d.c.)			
C915 short	18.8 (+19V to earth)			
R916 short	18.7 (+19V to earth)			
D904 short	0 (+19V to earth)			
C921 short	0 (+19V to earth)			
L801 short	0 (CN802 Pin1 to earth)			
Supplementary information: Input Voltage is 240Vac, 60Hz				

2.2	TABLE: evaluation of voltage limiting components in SELV circuits			P
Component (measured between)	max. voltage (V) (normal operation)		Voltage Limiting Components	
	V peak	V d.c.		
Power board 715G7300				
T902 pin 7-10	69	--		
After D901	--	19.8	D901	
After L801	--	17.9		
After D802	--	18.9		
Convertor output	--	18.5		
Fault test performed on voltage limiting components	Voltage measured (V) in SELV circuits (V peak or V d.c.)			
D901 s-c	0 (+19V output)			
L801 s-c	0 (LED backlight output)			

IEC 60950-1			
Clause	Requirement + Test	Result - Remark	Verdict
D802 s-c		0 (LED backlight output)	
Q801 G-S s-c		0 (LED backlight output)	
Q801 G-D s-c		0 (LED backlight output)	
Q801 D-S s-c		0 (LED backlight output)	
Supplementary information: Input Voltage is 240Vac, 60Hz			

2.4.2	TABLE: limited current circuit measurement					P
Location	Voltage (V)	Current (mA)	Freq. (kHz)	Limit (mA)	Comments	
Power board 715G5527						
C900 ²⁾	1.8	0.9	30	21	--	
Power board 715G6053						
C913 ³⁾	--	0.4	--	0.7	--	
Power board 715G7300						
C913 ³⁾	--	0.29	--	0.7	--	
Note(s):						
1. Input Voltage is 240Vac, 60Hz.						
2. 2000Ω non-inductive resistance used for this test.						
3. Test circuit according to Annex D used.						

2.5	TABLE: Limited power sources					P
Circuit output tested: See below.						
Note: Measured Uoc (V) with all load circuits disconnected:						
	Uoc (V)	I _{sc} (A)		VA		
		Meas.	Limit	Meas.	Limit	
Location: Power board 715G5527 +15V output						
Normal condition	18.0	2.4	8	32	100	
Fault condition (ZD901 s-c)	--	2.8	8	35	100	
Fault condition (R913 s-c)	--	0*	8	0*	100	
Fault condition (R915 s-c)	--	0*	8	0*	100	
Fault condition (U903 pin A-K s-c)	--	0*	8	0*	100	
Fault condition (U902 pin 1 o-c)	--	0*	8	0*	100	
Location: Power board 715G5527 +5V output						
Normal condition	5.1	4.6	8	22	100	

IEC 60950-1					
Clause	Requirement + Test	Result - Remark			Verdict
Fault condition (R903 s-c)	--	3.0	8	17	100
Fault condition (R913 s-c)	--	0*	8	0*	100
Fault condition (R915 s-c)	--	0*	8	0*	100
Fault condition (U903 pin A-K s-c)	--	0*	8	0*	100
Fault condition (U902 pin 1 o-c)	--	0*	8	0*	100
Location: Power board 715G6053 +19V and +19V1 output					
Normal condition	18.6	2.0	8	32.1	100
Fault condition (R911 s-c)	--	4.4	8	52.8	100
Fault condition (R912 s-c)	--	0*	8	0*	100
Fault condition (R916 s-c)	--	2.1	8	33.7	100
Fault condition (C915 s-c)	--	2.0	8	32.7	100
Fault condition (C904 pin 1 o-c)	--	0*	8	0*	100
Location: Power board 715G7300 +19V output					
Normal condition	18.2	1.4	8	25.34	100
Fault condition (D901 s-c)	--	0*	8	0*	100
Fault condition (U902 pin 1-2 s-c)	--	0*	8	0*	100
Fault condition (U902 pin3-4 s-c)	--	0*	8	0*	100
Fault condition (U902 pin 1 o-c)	--	0*	8	0*	100
Fault condition (U902 pin 3 o-c)	--	0*	8	0*	100
Fault condition (R931 s-c)	17.8	3.6	8	65.20	100
Supplementary information:					
Input Voltage is 240Vac, 60Hz.					
* means unit shut down.					

2.6.3.4	TABLE: ground continue test		P
Location	Resistance measured (mΩ)	Comments	
Unit with power board 715G5527			
PE terminal of AC inlet to internal metal enclosure	3.0	Test with 32A, 2 minutes	
PE terminal of AC inlet to internal metal enclosure	3.0	Test with 40A, 2 minutes	

IEC 60950-1			
Clause	Requirement + Test	Result - Remark	Verdict
	PE terminal of AC inlet to C902 trace	5.0	Test with 32A, 2 minutes
	PE terminal of AC inlet to C902 trace	5.0	Test with 40A, 2 minutes
	PE terminal of AC inlet to C903 trace	5.0	Test with 32A, 2 minutes
	PE terminal of AC inlet to C903 trace	5.0	Test with 40A, 2 minutes
Unit with power board 715G6053			
	PE terminal of AC inlet to internal metal enclosure	4.0	Test with 32A, 2 minutes
	PE terminal of AC inlet to internal metal enclosure	4.0	Test with 40A, 2 minutes
	PE terminal of AC inlet to C902/C903 trace	4.0	Test with 32A, 2 minutes
	PE terminal of AC inlet to C902/C903 trace	4.0	Test with 40A, 2 minutes
Unit with power board 715G7300			
	PE terminal of AC inlet to internal metal enclosure	4.0	Test with 32A, 2 minutes
	PE terminal of AC inlet to internal metal enclosure	4.0	Test with 40A, 2 minutes
	PE terminal of AC inlet to C902 earthed trace	4.0	Test with 32A, 2 minutes
	PE terminal of AC inlet to C902 earthed trace	4.0	Test with 40A, 2 minutes
	PE terminal of AC inlet to C903 earthed trace	4.0	Test with 32A, 2 minutes
	PE terminal of AC inlet to C903 earthed trace	4.0	Test with 40A, 2 minutes
Note(s):			

2.10.2	Table: working voltage measurement			P
Location	Peak voltage (V)	RMS voltage (V)	Comments	
Unit with power board 715G5527				
T901: Pin 1 to pin 6,7	359	198		
T901: Pin 1 to pin 8,9	388	200		
T901: Pin 1 to pin 10	341	197		
T901: Pin 3 to pin 6,7	491	245		

IEC 60950-1			
Clause	Requirement + Test	Result - Remark	Verdict
T901: Pin 3 to pin 8,9	472	240	
T901: Pin 3 to pin 10	492	249	Max. Vpeak & Vrms
T901: Pin 4 to pin 6,7	394	196	
T901: Pin 4 to pin 8,9	369	196	
T901: Pin 4 to pin 10	413	196	
T901: Pin 5 to pin 6,7	350	195	
T901: Pin 5 to pin 8,9	359	196	
T901: Pin 5 to pin 10	347	196	
U902 Pin 1-3	344	217	
U902 Pin 1-4	347	220	
U902 Pin 2-3	351	223	
U902 Pin 2-4	254	225	
Unit with power board 715G6053			
T902: Pin 1 to pin 7,8	358	210	
T902: Pin 1 to pin 9,10	342	208	
T902: Pin 3 to pin 7,8	369	197	
T902: Pin 3 to pin 9,10	403	205	
T902: Pin 4 to pin 7,8	398	197	
T902: Pin 4 to pin 9,10	342	205	
T902: Pin 6 to pin 7,8	487	250	
T902: Pin 6 to pin 9,10	506	264	Max. Vpeak & Vrms
C913 Pin 1-2	342	208	
Unit with power board 715G7300			
T902 pin 1-7	400	237	
T902 pin 2-7	387	237	
T902 pin 4-7	438	237	
T902 pin 6-7	512	237	
T902 pin 1-10	378	237	
T902 pin 2-10	444	237	
T902 pin 4-10	378	237	
T902 pin 6-10	531	276	Max. Vpeak & Vrms
C913	381	238	
U902 1-3	394	238	

IEC 60950-1			
Clause	Requirement + Test	Result - Remark	Verdict
U902 1-4	394	248	
U902 2-3	393	248	
U902 2-4	395	249	
Note(s): Input Voltage is 240Vac, 60Hz			

2.10.3 and 2.10.4	TABLE: clearance and creepage distance measurements					P
Clearance cl and creepage distance dcr at/of:	U _p (V)	U r.m.s. (V)	Required cl (mm)	cl (mm)	Required dcr (mm)	dcr (mm)
Unit with power board 715G5527						
Functional:						
Under fuse (F901)	420	250	2.3	2.8	2.5	3.6
Before fuse (between L-N)	420	250	2.3	8.9	2.5	8.9
Basic / supplementary:						
Line-GND	420	250	3.0	3.0	3.0	3.8
Neutral-GND	420	250	3.0	3.0	3.0	3.8
Under C900	420	250	3.0	8.0	3.0	8.0
Under C902	420	250	3.0	3.9	3.0	4.7
Under C903	420	250	3.0	7.6	3.0	8.6
Primary component C906 to core of T901	492	250	3.2	7.1	3.2	7.3
Secondary Jumper J9013 to core of T901	492	250	3.2	10.1	3.2	1.
Primary component (main transformer) to metal enclosure	492	250	3.2	8.0	3.2	1.
Primary component trace to panel	492	250	3.2	5.5	3.2	1.
Reinforced:						
Under T901	492	250	6.3	8.0	6.3	8.0
U902 primary pin to U902 secondary pin (trace side)	420	250	6.0	7.8	6.0	8.6
Primary component NR901 to secondary component Q903 (trace side)	420	250	6.0	8.0	6.0	8.0

IEC 60950-1			
Clause	Requirement + Test	Result - Remark	Verdict

Supplementary information:

1. At least 10mm measured for creepage or clearance where indicated.
2. Core of main transformer T901 consider as floating.
3. Two layers of insulation tape wrapped external of transformer T901. See table C.2 for pri. Pin to core as smallest distance.
4. The basic insulation secondary wires are far enough from the primary components to fulfil the requirement for supplementary insulation.
5. Glued component: C907.
6. Considered altitude correction factor for clearances for an altitude of 5000m (based on IEC 60664-1:1992): 1.48.
7. For clearance and creepage that did not describe above are far larger than limit above.

2.10.3 and 2.10.4	TABLE: clearance and creepage distance measurements					P
Clearance cl and creepage distance dcr at/of:	U _p (V)	U _{r.m.s.} (V)	Required cl (mm)	cl (mm)	Required dcr (mm)	dcr (mm)
Unit with power board 715G6053						
Functional:						
Under fuse (F901)	420	250	2.3	2.8	2.5	4.5
Before fuse (between L-N)	420	250	2.3	3.2	2.5	3.2
Basic / supplementary:						
Line-GND	420	250	3.0	3.0 ⁴⁾	3.0	3.0 ⁴⁾
Neutral-GND	420	250	3.0	3.0 ⁴⁾	3.0	3.0 ⁴⁾
Under C902	420	250	3.0	3.6	3.0	7.6
Under C903	420	250	3.0	3.6	3.0	7.6
Transformer (T902) to metal enclosure ²⁾	506	264	3.3	6.7	3.3	⁸⁾
Primary component (C907) to metal enclosure ²⁾	506	264	3.3	6.7	3.3	⁸⁾
Trace side of power board to panel plate	506	264	3.3	5.4	3.3	⁴⁾
Reinforced:						
Pri. trace to sec. trace (under T902)	506	264	6.6	9.2	6.6	9.2
Secondary Jumper C904 to core of T902	506	264	6.6	8.0	6.6	⁸⁾
Under C913	420	250	6.0	7.5	6.0	9.4
Primary component C901 to secondary component CN801	420	250	6.0	7.8	6.0	7.8

IEC 60950-1			
Clause	Requirement + Test	Result - Remark	Verdict

Supplementary information:

8. At least 10mm measured for creepage or clearance where indicated.
9. Core of main transformer T902 consider as primary part.
10. Three layers of insulation tape wrapped external of transformer T902. See table C.2 for pri. Pin to core as smallest distance.
11. Measured three times with same result..
12. Heat shrinkable tube used for secondary wires is considered as reinforced insulation.
13. Glued component: C907.
14. Considered altitude correction factor for clearances for an altitude of 5000m (based on IEC 60664-1:1992): 1.48
15. For clearance and creepage that did not describe above are far larger than limit above.

2.10.3 and 2.10.4	TABLE: clearance and creepage distance measurements					P
Clearance cl and creepage distance dcr at/of:	U p (V)	U r.m.s. (V)	Required cl (mm)	cl (mm)	Required dcr (mm)	dcr (mm)
Unit with power board 715G7300						
Functional:						
L to N	420	250	2.3	3.3	2.5	3.3
Different pin of fuse	420	250	2.3	2.9	2.5	3.3
Basic / supplementary:						
L to GND	420	250	3.0	3.0	3.0	3.0
N to GND	420	250	3.0	3.0	3.0	3.0
Live parts on power board to metallic enclosure	531	276	3.3	9.0	3.3	9.0
Different pin of Y-cap C903	420	250	3.0	3.2	3.0	5.4
Different pin of Y-cap C902	420	250	3.0	3.2	3.0	3.2
Reinforced:						
Live trace to metallic part of panel	531	276	6.6	7.0	6.6	7.0
Different pin of C913	420	250	6.0	7.5	6.0	7.5
U902 primary trace to secondary trace	420	250	6.0	7.6	6.0	7.6
Secondary pin of C913 to core	531	276	6.6	8.5	6.6	8.5
Secondary component J902 to core	531	276	6.6	7.5	6.6	7.5

IEC 60950-1			
Clause	Requirement + Test	Result - Remark	Verdict

Supplementary information:

1. Core of main transformer T902 consider as primary.
2. Glued component: C907.
3. Considered altitude correction factor 1.48 for clearances for an altitude of 5000m.
4. For clearance and creepage that did not describe above are far larger than limit above.

2.10.5	TABLE: Distance through insulation measurements				P
Distance through insulation DTI at/of:	U peak (V)	U rms (V)	Test voltage (V)	Required DTI (mm)	DTI (mm)
Photo coupler (reinforced insulation)	420	250	3000	0.4	1.
Plastic enclosure	420	250	3000	0.4	1.

Supplementary information:

1. For approved component source see appended table 1.5.1.

IEC 60950-1			
Clause	Requirement + Test	Result - Remark	Verdict

4.3.8	TABLE: Batteries								N/A
The tests of 4.3.8 are applicable only when appropriate battery data is not available									
Is it possible to install the battery in a reverse polarity position?									
	Non-rechargeable batteries			Rechargeable batteries					
	Discharging		Un-intentional charging	Charging		Discharging		Reversed charging	
	Meas. current	Manuf. Specs.		Meas. current	Manuf. Specs.	Meas. current	Manuf. Specs.	Meas. current	Manuf. Specs.
Max. current during normal condition									
Max. current during fault condition									
Test results:									
- Chemical leaks								Verdict	
- Explosion of the battery									
- Emission of flame or expulsion of molten metal									
- Electric strength tests of equipment after completion of tests									
Supplementary information:									

4.3.8	TABLE: Batteries								N/A
Battery category.....		: (Lithium, NiMh, NiCad, Lithium Ion ...)							
Manufacturer		:							
Type / model.....		:							
Voltage		:							
Capacity.....		: mAh							
Tested and Certified by (incl. Ref. No.)		:							
Circuit protection diagram:									

IEC 60950-1			
Clause	Requirement + Test	Result - Remark	Verdict

MARKINGS AND INSTRUCTIONS (1.7.13)	
Location of replaceable battery	
Language(s)	
Close to the battery	
In the servicing instructions	
In the operating instructions	

4.5	TABLE: Thermal requirements						P
	Supply voltage (V)	90V/ 60Hz	264V/ 60Hz	--	--	--	—
	Ambient T _{min} (°C)	--	--	--	--	--	—
	Ambient T _{max} (°C)	--	--	--	--	--	—
	Maximum measured temperature T of part/at.....:	T (°C)					Allowed T _{max} (°C)
18.5 inch model with power board 715G5527, main board 715G5965							
	AC Inlet body CN901 (on power board)	34.9	32.0	--	--	--	44.3
	C902 body (on power board)	37.9	36.6	--	--	--	59.3
	PCB near NR901 (on power board)	40.8	41.4	--	--	--	79.3
	C904 body (on power board)	37.5	39.7	--	--	--	59.3
	L901 coil (on power board)	40.0	41.7	--	--	--	79.3
	PCB near BD901 (on power board)	40.8	39.8	--	--	--	79.3
	C907 body (on power board)	41.5	42.1	--	--	--	79.3
	C900 body (on power board)	44.8	40.9	--	--	--	59.3
	T901 coil (on power board)	51.0	48.3	--	--	--	84.3
	T901 core (on power board)	45.7	43.1	--	--	--	84.3
	U902 body (on power board)	43.5	41.7	--	--	--	74.3
	PCB near D906 (on power board)	45.3	44.8	--	--	--	79.3
	PCB near U901 (on power board)	46.6	47.3	--	--	--	79.3
	PCB near L801 (on power board)	50.5	51.8	--	--	--	79.3
	PCB near U801 (on power board)	43.6	43.1	--	--	--	79.3
	PCB near U401 (on main board)	45.8	44.0	--	--	--	79.3
	Metal enclosure	36.2	35.0	--	--	--	44.3
	Plastic enclosure inside near T901	33.8	34.1	--	--	--	--
	Panel surface	38.6	39.4	--	--	--	69.3

IEC 60950-1						
Clause	Requirement + Test		Result - Remark			Verdict
Plastic enclosure outside	28.5	28.1	--	--	--	34.3
Ambient	14.3	14.7	--	--	--	--
21.5 inch model with power board 715G5527, main board 715G5846						
AC Inlet body CN901 (on power board)	36.2	37.9	--	--	--	45.5
C902 body (on power board)	39.4	39.2	--	--	--	60.5
PCB near NR901 (on power board)	43.7	41.2	--	--	--	80.5
C904 body (on power board)	41.1	37.7	--	--	--	60.5
L901 coil (on power board)	44.2	42.3	--	--	--	80.5
PCB near BD901 (on power board)	45.2	40.8	--	--	--	80.5
C907 body (on power board)	44.5	40.1	--	--	--	80.5
C900 body (on power board)	43.8	40.9	--	--	--	60.5
T901 coil (on power board)	51.0	50.6	--	--	--	85.5
T901 core (on power board)	47.2	45.7	--	--	--	85.5
U902 body (on power board)	46.1	43.5	--	--	--	75.5
PCB near D906 (on power board)	47.2	46.2	--	--	--	80.5
PCB near U901 (on power board)	49.1	45.5	--	--	--	80.5
PCB near L801 (on power board)	50.5	48.2	--	--	--	80.5
PCB near U801 (on power board)	45.1	46.7	--	--	--	80.5
PCB near U401 (on main board)	45.8	44.0	--	--	--	80.5
Metal enclosure	37.4	36.3	--	--	--	45.5
Plastic enclosure inside near T901	35.2	32.6	--	--	--	--
Panel surface	38.0	39.0	--	--	--	70.5
Plastic enclosure outside	28.3	25.2	--	--	--	35.5
Ambient	15.5	15.6	--	--	--	--
19.5 inch model with power board 715G5527, main board 715G5846						
AC Inlet CN901 (on power board)	37.1	33.6	--	--	--	47.1
C902 body (on power board)	38.4	39.7	--	--	--	62.1
PCB near NR901 (on power board)	45.3	41.1	--	--	--	82.1
C904 body (on power board)	42.9	41.9	--	--	--	62.1
L901 coil (on power board)	44.3	44.5	--	--	--	72.1
PCB near BD901 (on power board)	43.1	40.1	--	--	--	82.1
C907 body (on power board)	46.7	46.7	--	--	--	82.1
C900 body (on power board)	46.1	44.1	--	--	--	62.1

IEC 60950-1						
Clause	Requirement + Test		Result - Remark			Verdict
T901 coil (on power board)	52.6	51.3	--	--	--	87.1
T901 core (on power board)	48.6	46.9	--	--	--	87.1
U902 body (on power board)	49.7	49.7	--	--	--	77.1
PCB near D906 (on power board)	49.7	46.2	--	--	--	82.1
PCB near U901 (on power board)	42.1	40.1	--	--	--	82.1
PCB near L801 (on power board)	48.1	48.1	--	--	--	82.1
PCB near U801 (on power board)	45.2	48.5	--	--	--	82.1
PCB near U401 (on main board)	42.5	47.8	--	--	--	82.1
Metal enclosure	35.8	37.3	--	--	--	47.1
Plastic enclosure inside near T901	36.1	39.7	--	--	--	--
Panel surface	38.1	36.8	--	--	--	72.1
Plastic enclosure outside	33.4	34.6	--	--	--	37.1
Ambient	17.1	17.4	--	--	--	--
18.5 inch model with power board 715G6053, main board 715G6851 type A						
Line pin of AC Inlet CN901 (on power board)	36.2	32.9	--	--	--	52.3
C902 body (on power board)	36.2	34.7	--	--	--	67.3
PCB near NR901 (on power board)	41.0	40.1	--	--	--	87.3
C901 body (on power board)	43.2	40.0	--	--	--	67.3
L901 coil (on power board)	42.0	42.5	--	--	--	87.3
PCB near BD901 (on power board)	42.6	41.6	--	--	--	87.3
C907 body (on power board)	43.7	40.2	--	--	--	87.3
C913 body (on power board)	44.1	40.5	--	--	--	67.3
T902 coil (on power board)	47.5	45.2	--	--	--	72.3
T902 core (on power board)	42.1	41.2	--	--	--	72.3
PCB near D904 (on power board)	46.9	42.6	--	--	--	87.3
PCB near L801 Coil (on power board)	45.7	44.0	--	--	--	87.3
PCB near U801 (on power board)	43.4	42.1	--	--	--	87.3
PCB near U401 (on main board)	45.2	42.9	--	--	--	87.3
Metal enclosure	35.7	34.8	--	--	--	52.3
Plastic enclosure inside near T902	32.1	30.0	--	--	--	--
Panel surface	31.3	30.1	--	--	--	77.3
Plastic enclosure outside	23.2	21.9	--	--	--	42.3
Ambient	22.3	22.5	--	--	--	--
19.5 inch model with power board 715G6053, main board 715G6851 type A						

IEC 60950-1						
Clause	Requirement + Test		Result - Remark			Verdict
Line pin of AC Inlet CN901 (on power board)	35.7	33.0	--	--	--	52.5
C902 body (on power board)	41.3	40.3	--	--	--	67.5
PCB near NR901(on power board)	42.3	40.6	--	--	--	87.5
C901 body (on power board)	43.7	42.4	--	--	--	67.5
L901 coil (on power board)	43.4	41.8	--	--	--	87.5
PCB near BD901(on power board)	49.3	46.7	--	--	--	87.5
C907 body (on power board)	45.7	44.2	--	--	--	87.5
C913 body (on power board)	42.0	40.0	--	--	--	67.5
T902 coil (on power board)	49.9	47.2	--	--	--	72.5
T902 core(on power board)	45.4	42.7	--	--	--	72.5
PCB near D904 (on power board)	43.4	40.3	--	--	--	87.5
PCB near L801 Coil (on power board)	45.8	42.3	--	--	--	87.5
PCB near U801 (on power board)	42.9	42.7	--	--	--	87.5
PCB near U401 (on main board)	47.8	43.2	--	--	--	87.5
Metal enclosure	37.9	36.4	--	--	--	52.5
Plastic enclosure inside near T902	32.7	31.5	--	--	--	--
Panel surface	31.2	29.0	--	--	--	77.5
Plastic enclosure outside	24.5	22.7	--	--	--	42.5
Ambient	22.5	22.7	--	--	--	--
21.5 inch model with power board 715G6053, main board 715G6851 type A						
Line pin of AC Inlet CN901 (on power board)	33.1	32.3	--	--	--	52.3
C902 body (on power board)	38.8	36.1	--	--	--	67.3
PCB near NR901(on power board)	42.0	41.3	--	--	--	87.3
C901 body (on power board)	41.4	40.5	--	--	--	67.3
L901 coil (on power board)	42.7	43.0	--	--	--	87.3
PCB near BD901(on power board)	43.6	41.8	--	--	--	87.3
C907 body (on power board)	45.7	40.9	--	--	--	87.3
C913 body (on power board)	46.5	42.1	--	--	--	67.3
T902 coil (on power board)	51.1	50.5	--	--	--	72.3
T902 core(on power board)	45.1	44.3	--	--	--	72.3
PCB near D904 (on power board)	47.9	45.1	--	--	--	87.3
PCB near L801 Coil (on power board)	47.3	45.7	--	--	--	87.3
PCB near U801 (on power board)	48.9	46.1	--	--	--	87.3
PCB near U401 (on main board)	45.8	44.1	--	--	--	87.3

IEC 60950-1							
Clause	Requirement + Test			Result - Remark			Verdict
Metal enclosure	37.3	35.6	--	--	--		52.3
Plastic enclosure inside near T902	33.3	33.6	--	--	--		--
Panel surface	30.3	30.5	--	--	--		77.3
Plastic enclosure outside	24.7	23.1	--	--	--		42.3
Ambient	22.3	22.6	--	--	--		--
21.5 inch model with power board 715G7300, main board 715G6851 type B							
Ambient	40.0	40.0	--	--	--		--
AC inlet	49.7	48.9	--	--	--		70
Y-cap C902	50.7	50.8	--	--	--		125
Y-cap C903	51.2	51.3	--	--	--		125
X-cap C901	60.0	54.3	--	--	--		85
Thermistor NR901	66.9	56.6	--	--	--		Ref.
E-cap C907	56.5	55.3	--	--	--		105
PCB near BD901	68.4	59.8	--	--	--		105
L901 winding	65.3	64.2	--	--	--		105
L901 bobbin	67.6	66.2	--	--	--		Ref.
PCB near L901	68.2	64.9	--	--	--		105
PCB near Q901	70.8	71.7	--	--	--		105
Opto-coupler U902	61.0	62.2	--	--	--		100
Y-cap C913	63.8	60.4	--	--	--		125
Transformer T902 winding	73.1	76.7	--	--	--		110
Transformer T902 bobbin	71.7	75.5	--	--	--		Ref.
PCB near T902	70.0	70.7	--	--	--		105
E-cap C916	73.9	72.8	--	--	--		105
PCB near D901	72.5	74.9	--	--	--		105
PCB near main IC (On main board)	58.4	58.8	--	--	--		105
Panel	46.5	46.9	--	--	--		95
Button	50.0	49.2	--	--	--		95
Plastic enclosure inside near T902	48.0	48.0	--	--	--		Ref.
Plastic enclosure outside near T902	44.7	44.8	--	--	--		95
Metallic enclosure	49.7	50.0	--	--	--		70
Supplementary information:							
Temperature T of winding:	t ₁ (°C)	R ₁ (Ω)	t ₂ (°C)	R ₂ (Ω)	T (°C)	Allowed T _{max} (°C)	Insulation class
--	--	--	--	--	--	--	--

IEC 60950-1			
Clause	Requirement + Test	Result - Remark	Verdict

Supplementary information:

4.5.5	TABLE: Ball pressure test of thermoplastic parts		P
	Allowed impression diameter (mm)	≤ 2 mm	—
Part	Test temperature (°C)	Impression diameter (mm)	
Line choke (L901), Chang Chun, type PBT-4115	125	1.0	
Line choke (L901), Chang Chun, type PBT-4130	125	1.0	
Below mentioned plastic enclosure material was tested by client's request:			
Plastic enclosure, Kingfa: HIPS-5197, 2.5mm	90	1.59	
Plastic enclosure, Kingfa: GAR-011(L85), 2.5mm	85	1.31	
Plastic enclosure, Kingfa: GAR-011(L65), 2.5mm	85	1.29	
Plastic enclosure, Kingfa: HIPS-510(H), 2.5mm	80	1.29	
Plastic enclosure, Kingfa: FRHIPS-960, 2.5mm	85	1.88	
Plastic enclosure, Cheil: GC-0750(+), 2.5mm	80	1.61	
Plastic enclosure, Cheil: GC-0700(+), 2.5mm	80	1.94	
Plastic enclosure, Cheil: HG-0760(+), 2.5mm	85	1.73	
Plastic enclosure, Cheil: LX-0951(+), 2.5mm	85	1.83	
Plastic enclosure, Cheil: SD-0150, 2.5mm	85	1.48	
Plastic enclosure, Cheil: HR-1360, 2.5mm	85	1.71	
Plastic enclosure, Cheil: BF-0670F, 2.5mm	80	1.59	
Plastic enclosure, LG: HF380, 2.5mm	85	1.48	
Plastic enclosure, LG: SE885, 2.5mm	80	1.42	
Plastic enclosure, LG: LUPOY GP-1000(#), 2.5mm	95	1.21	
Plastic enclosure, LG: XG568, 2.5mm	80	1.81	
Plastic enclosure, LG: XG569C, 2.5mm	80	1.85	
Plastic enclosure, LG: HF388H, 2.5mm	85	1.39	
Plastic enclosure, LG: SE750, 2.5mm	80	1.5	
Plastic enclosure, Teijin: TN-7500, 2.5mm	85	1.57	
Plastic enclosure, ORINKO: HIPS-2000, 2.5mm	85	1.48	
Plastic enclosure, Kingfa: GAR-011C, 2.5mm	90	1.91	
Supplementary information:			

IEC 60950-1			
Clause	Requirement + Test	Result - Remark	Verdict
4.6.1, 4.6.2	Table: enclosure openings		P
Location	Size (mm)	Comments	
External Plastic enclosure			
Top	Numerous rectangle openings: max. 18.9mm x 1.9mm.	No hazardous part within vertical projection of 5° from the opening.	
Rear	No opening.	--	
Left	No opening.	--	
Right	No opening.	--	
Bottom	No opening.	--	
Internal metal chassis type A			
Top	1) Numerous circle openings: Ø4.8mm; 2) One rectangle opening above power board: 20.0mm x 8.8mm.	1) Openings do not exceed 5mm in any dimension. No hazards. 2) No hazardous part within vertical projection of 5° from the opening.	
Rear	1) Two circle openings above main board: Ø14.0mm; 2) One rectangle opening above power board converter part: 68.7mm x 13.5mm.	No hazardous part within vertical projection of 5° from the opening.	
Left	One rectangle opening near main board: 32.0mm x 14.0mm.	No hazardous part within vertical projection of 5° from the opening.	
Right	One rectangle opening near power board converter part: 68.7mm x 26.1mm	No hazardous part within vertical projection of 5° from the opening.	
Bottom	1) One half-circle opening near main board: Ø12.0mm; 2) No opening under power board side.	Main board is supplied by LPS and mounted on V-1 material. The opening is not within the area of hazardous components on the power board traced out by the 5° angle. No hazards.	
Internal metal chassis type B			
Top	1) Numerous circle openings: Ø4.8mm; 2) One rectangle opening above power board: 19.9mm x 8.9mm 3) One rectangle openings above main board: 60.0mm x 8.5mm	1) Openings do not exceed 5mm in any dimension. No hazards. 2) The opening is covered by external plastic enclosure. No hazardous part within projection of 5°. 3) No hazardous part within projection of 5°.	

IEC 60950-1			
Clause	Requirement + Test	Result - Remark	Verdict
Rear	1) Two circle openings near main board: \varnothing 4.8mm; 2) One rectangle opening near power board for converter output wire: 38.3mm x 18.2mm; 3) One circle opening near main board: \varnothing 14.0mm;	1), 3) Main board is used with V-1 PCB and supplied by LPS. No hazardous part within projection of 5°.	2) No opening exists within the area below non-LPS-supplied parts on the power board traced out by the 5° angle. No hazards.
Left	One rectangle openings near main board: 20.9mm x 13.5mm.	No hazardous part within projection of 5°.	
Right	Two rectangle opening near power board for converter output wire: 38.0mm x 27.0mm; 15.7mm x 8.5mm.	No hazardous part within projection of 5°.	
Bottom	No opening	--	
Internal metal chassis type C			
Top	1) One rectangle opening: 19.9mmx8.7mm; 2) Numerous circle openings: \varnothing 4.6mm;	Blocked by plastic enclosure.	
Rear	1) Two circle openings: \varnothing 14.0mm; 2) One rectangle opening: 9.2mmx18.9mm; 3) One rectangle opening: 54.7mmx24.6mm;	No hazardous part within projection of 5°.	
Left (near power board)	One rectangle opening: 54.7mmx25.7mm;	No hazardous part within projection of 5°.	
Right	One rectangle opening: 14.1mmx31.9mm;	No hazardous part within projection of 5°.	
Bottom	1) One rectangle opening: 16.5mmx7.0mm; 2) One circle openings: \varnothing 7.6mm.	--	

IEC 60950-1				
Clause	Requirement + Test	Result - Remark	Verdict	
4.7	Table: resistance to fire			P
Part	Manufacturer of material	Type of material	Thickness (mm)	Flammability class
PCB	--	--	--	V-1
Plastic enclosure *	--	--	--	HB
Supplementary information: See table 1.5.1.				
* Not fire enclosure.				

5.1	TABLE: touch current measurement			P
Measured between:	Measured (mA)	Limit (mA)	Comments/conditions	
Unit with power board 715G5527				
L – metal enclosure	0.60	3.5	Switch “e” open	
N – metal enclosure	0.60	3.5	Switch “e” open	
L – signal connector	0.01	0.25	Switch “e” close *	
N – signal connector	0.01	0.25	Switch “e” close *	
L – plastic enclosure	0.01	0.25	Switch “e” close	
N – plastic enclosure	0.01	0.25	Switch “e” close	
Unit with power board 715G6053				
L – metal enclosure	0.50	3.5	Switch “e” open	
N – metal enclosure	0.50	3.5	Switch “e” open	
L – signal connector	0.08	0.25	Switch “e” close *	
N – signal connector	0.08	0.25	Switch “e” close *	
L – plastic enclosure	0.01	0.25	Switch “e” close	
N – plastic enclosure	0.01	0.25	Switch “e” close	
Unit with power board 715G7300				
L – metal enclosure	0.22	3.5	Switch “e” open	
N – metal enclosure	0.22	3.5	Switch “e” open	
L – signal connector	0.01	0.25	Switch “e” close *	
N – signal connector	0.01	0.25	Switch “e” close *	
L – plastic enclosure	0.01	0.25	Switch “e” close	
N – plastic enclosure	0.01	0.25	Switch “e” close	
Supplementary information: Supplied with 264V/60Hz.				
* Test performed with functional earthing disconnected.				

IEC 60950-1			
Clause	Requirement + Test	Result - Remark	Verdict
5.2	TABLE: Electric strength tests, impulse tests and voltage surge tests		P
Test voltage applied between:		Voltage shape (AC, DC, impulse, surge)	Test voltage (V)
Unit with power board 715G5527			
Basic/supplementary:			
Unit: primary and earth		AC	1740
T901 ¹⁾ : secondary and core		AC	1740
T901 ¹⁾ : primary and core		AC	1740
Reinforced:			
Unit: primary and secondary		DC	4242
Unit: primary and plastic enclosure with metal foil		AC	3000
T901 ¹⁾ : primary and secondary		AC	3000
T901 ¹⁾ : each combination of two layers of insulation tape		AC	3000
Supplementary information:			
1) For all sources of T901;			
2) The test mentioned above were performed after humidity conditioning test.			

IEC 60950-1			
Clause	Requirement + Test	Result - Remark	Verdict
5.2	TABLE: Electric strength tests, impulse tests and voltage surge tests		P
Test voltage applied between:		Voltage shape (AC, DC, impulse, surge)	Test voltage (V)
Unit with power board 715G6053			
Basic/supplementary:			
Unit: primary and earth		AC	1772
Reinforced:			
L/N to accessible plastic enclosure with metal foil		AC	3000
Unit primary to secondary (output)		DC	4242
T902 ¹⁾ : primary to secondary		AC	3000
T902 ¹⁾ : secondary to core		AC	3000
T902 ¹⁾ : each combination of two layers of insulation tape		AC	3000
Supplementary information:			
1) For all sources of T901;			
2) The test mentioned above were performed after humidity conditioning test.			

IEC 60950-1			
Clause	Requirement + Test	Result - Remark	Verdict
5.2	TABLE: Electric strength tests, impulse tests and voltage surge tests		P
Test voltage applied between:		Voltage shape (AC, DC, impulse, surge)	Test voltage (V)
Breakdown Yes / No			
Unit with power board 715G7300			
Basic/supplementary:			
Unit: L/N to earthed metallic part		AC	1803
No			
Reinforced:			
T901 ²⁾ : primary to secondary		AC	3000
No			
T901 ²⁾ : secondary to core		AC	3000
No			
Unit: L/N to secondary terminals		DC	4242
No			
Unit: L/N to plastic enclosure covered with meatl foil		DC	4242
No			
Supplementary information:			
1. The tests mentioned above were performed after humidity test.			
2. All source of T901 tested			

5.3	TABLE: Fault condition tests					P
Ambient temperature (°C)		See below			—	
Power source for EUT: ManuFacterer, model/type, output rating					—	
Component No.	Fault	Supply voltage (V)	Test time	Fuse #	Fuse current (A)	Observation
18.5 inch model with power board 715G5527, main board 715G5965						
Ventilation openings	blocked	264	2.0 hrs	F901	0.13	Unit operated normally, no hazards, no damaged. After temperature reached stable, max. measured temp. in T901 coil = 53.7°C, T901 core = 48.7°C, U902 = 46.4°C, ambient = 14.2°C.
BD901 pin1-3	s-c	264	<1 sec	F901	--	Fuse F901 opened instantly, no hazard.
C907	s-c	264	<1 sec	F901	--	Fuse F901 opened instantly, no hazard.

IEC 60950-1						
Clause	Requirement + Test			Result - Remark		Verdict
U901 pin 4-5	s-c	264	< 1 sec	F901	--	F901 opened instantly, R921, R920, R903 and U901 damaged. No hazard. This test was repeated twice (three tests total) with same result.
U901 pin 2-5	s-c	264	< 1 sec	F901	--	F901 opened instantly, R921, R920, R925 and U901 damaged. No hazard. This test was repeated twice (three tests total) with same result.
U901 pin 3-6	s-c	264	< 1 sec	F901	0.06	Unit shut down, no hazard.
T901 pin6,7 to pin10	s-c	264	5 min	F901	0.06	Unit shut down, no hazard.
T901 pin8,9 to pin10	s-c	264	5 min	F901	0.06	Unit shut down, no hazard.
T901 pin1 to pin3	s-c	264	5 min	F901	0.03	Unit shut down, no hazard.
T901 pin4 to pin5	s-c	264	5 min	F901	0.06	Unit shut down, no hazard.
U902 pin1-2	s-c	264	5 min	F901	0.05	Unit shut down, no hazard.
U902 pin3-4	s-c	264	5 min	F901	0.05	Unit shut down, no hazard.
U902 pin 1	o-c	264	5 min	F901	0.05	Unit shut down, no hazard.
D902	s-c	264	5 min	F901	0.04	Unit shut down, no hazard.
D906	s-c	264	5 min	F901	0.04	Unit shut down, no hazard.
+5V output to earth	s-c	264	5 min	F901	0.04	Unit shut down, no hazard.
+15V output to earth	s-c	264	5 min	F901	0.04	Unit shut down, no hazard.
+5V output to +15V output	s-c	264	5 min	F901	0.04	Unit shut down, no hazard.

IEC 60950-1						
Clause	Requirement + Test			Result - Remark		Verdict
T901 pin8,9- pin10 after D903(+15V)	o-l	264	8 hrs	F901	0.54	Max. measured temp. in T901 coil = 82 °C, T901 core = 76 °C, U902 = 69 °C, ambient = 14.1 °C, before shut down winding is loaded to 2.0A. No hazards.
T901 pin6,7-pin10 after D906(+5V)	o-l	264	11 hrs	F901	0.51	Max. measured temp. in T901 coil = 81 °C, T901 core = 74 °C, U902 = 65 °C, ambient = 14.7 °C, before shut down winding is loaded to 3.5A. No hazards.
21.5 inch model with power board 715G6053, main board 715G6851 type A						
Ventilation openings	blocked	264	4.7 hrs	F901	0.18	Unit operated normally, no hazards, no damaged. After temperature reached stable, max. measured temp. in T902 coil =53.8 °C, T902 core=48.5 °C, ambient= 18.2 °C.
BD901 pin 2-4	s-c	264	<1 sec	F901	--	Fuse F901 opened instantly, no hazard.
C907	s-c	264	<1 sec	F901	--	Fuse F901 opened instantly, no hazard.
T902 pin 1 to pin 2	s-c	264	5 min	F901	0.06	Unit shut down, no hazard.
T902 pin 4 to pin 6	s-c	264	5 min	F901	0.06	Unit shut down, no hazard.
T902 pin 9,10 to pin 7,8	s-c	264	5 min	F901	0.03	Unit shut down, no hazard.
D902	s-c	264	5 min	F901	0.04	Unit shut down, no hazard.
D904	s-c	264	5 min	F901	0.04	Unit shut down, no hazard.
C904	s-c	264	5 min	F901	0.04	Unit shut down, no hazard.

IEC 60950-1						
Clause	Requirement + Test			Result - Remark		Verdict
R912	s-c	264	5 min	F901	0.04	Unit shut down, no hazard.
+19V output to earth	s-c	264	5 min	F901	0.04	Unit shut down, no hazard.
T902 pin 7,8 to 9,10 (after D904) (+19V)	o-l	240	8 hrs 30 min	F901	0.52	Max. measured temp.in T902 coil= 83.0°C, T902 core = 75.7°C, ambient= 19.7°C, before shutdown winding is loaded to 1.7A. No damage, no hazards.
21.5 inch model with power board 715G7300, main board 715G6851 type B						
Ventilation	Blocked	264	2hrs	F901	0.13	Unit work normal, no damage, no hazards, no temperature rise exceeding its limit: T901 coil=71.3°C, T901 core=69.6°C, U902 body=55.8°C, ambient=24.3°C
BD901 pin1-2	s-c	264	5 sec	F901	--	Fuse open immediately, no hazards.
C907	s-c	264	5 sec	F901	--	Fuse open immediately, no hazards.
IC U901 pin1-5	s-c	264	10 mins	F901	0.04	Unit shutdown, no hazards.
IC U901 pin2-5	s-c	264	10 mins	F901	0.04	Unit shutdown, no hazards.
Q901 G-S	s-c	264	10 mins	F901	0.04	Unit shutdown, no hazards.
Q901 G-D	s-c	264	10 mins	F901	0.04	Unit shutdown, R928, Q901 and U901 damaged, no hazards.
Q901 D-S	s-c	264	10 mins	F901	0.04	Unit shutdown, R931 and Q901 damaged, no hazards.
R931	s-c	264	10 mins	F901	0.12	Unit work normal, no damaged, no hazards.
T902 pin 1-2	s-c	264	10 mins	F901	0.06	Unit shutdown, no hazards, no damaged.
T902 pin 4-6	s-c	264	10 mins	F901	0.06	Unit shutdown, no hazards, no damaged.

IEC 60950-1						
Clause	Requirement + Test				Result - Remark	Verdict
T902 pin 7-10	s-c	264	10 mins	F901	0.03	Unit shutdown, no hazards, no damaged.
D901	s-c	264	10 mins	F901	0.04	Unit shutdown, no hazards, no damaged.
U902 1-2	s-c	264	10 mins	F901	0.04	Unit shutdown, no hazards, no damaged.
U902 3-4	s-c	264	10 mins	F901	0.04	Unit shutdown, no hazards, no damaged.
U902 1	o-c	264	10 mins	F901	0.04	Unit shutdown, no hazards, no damaged.
U902 3	o-c	264	10 mins	F901	0.04	Unit shutdown, no hazards, no damaged.
+19V	o-l	264	3hrs	F901	0.31	No damage, no hazards, no temperature rise exceeding its limit: T901 coil=115.3°C, T901 core=114.2°C, U902 body=74.5°C, ambient=24.9°C
+19V	s-c	264	10 mins	F901	0.04	Showdown
Notes:						
1. The unit passed 3000V hi-pot test between primary and accessible output connector after single fault test above.						
2. In fault column, where s-c=short-circuited, o-c=open-circuited, o-l = overload.						
3. For fuse opened conditions were tested with each source of fuse.						
4. Test repeated three times with same result.						
5. Temp. limited of transformer (class B) according to table C.1 is 175°C -(40°C -Tamb).						

C.2	TABLE: transformers						P
Loc.	Tested insulation	Working voltage peak / V	Working voltage rms / V	Required electric strength	Required clearance / mm	Required creepage distance / mm	Required distance thr. insul.
		(2.10.2)	(2.10.2)	(5.2)	(2.10.3)	(2.10.4)	(2.10.5)
T901 on power board 715G5527							

IEC 60950-1							
Clause	Requirement + Test				Result - Remark		Verdict
T901	Primary solder pin to secondary solder pin	492	250	3000	6.4	6.4	0.4mm for bobbin
T901	Primary winding to secondary winding	492	250	3000	6.4	6.4	--
T901	Primary trace to secondary trace	492	250	3000	6.4	6.4	--
T901	Primary pin to core	492	250	1740	3.2	3.2	0.4mm for bobbin
T901	Primary winding to core	492	250	1740	3.2	3.2	--
T901	Secondary pin to core	492	250	1740	3.2	3.2	0.4mm for bobbin
T901	Secondary winding to core	492	250	1740	3.2	3.2	--
Loc.	Tested insulation			Test voltage/ V	Measured clearance / mm	Measured creepage dist./ mm	Measured distance thr. insul. / mm; number of layers
T901	Primary solder pin to secondary solder pin			3000	21.5	21.5	Bobbin with min. thickness 0.45mm
T901	Primary winding to secondary winding			3000	6.4	6.4	Margin tape with min. width 3.2mm used for all primary and secondary windings; 3Ts insulation tape used between primary and secondary windings
T901	Primary trace to secondary trace			3000	7.2	7.2	--
T901	Primary pin to core			1740	4.4	4.4	Bobbin with min. thickness 0.45mm

IEC 60950-1					
Clause	Requirement + Test	Result - Remark			Verdict
T901	Primary winding to core	1740	3.2	3.2	Margin tape with min. width 3.2mm used for all primary and secondary windings.
T901	Secondary pin to core	1740	4.4	4.4	Bobbin with min. thickness 0.45mm
T901	Secondary winding to core	1740	3.2	3.2	Margin tape with min. width 3.2mm used for all primary and secondary windings
supplementary information:					

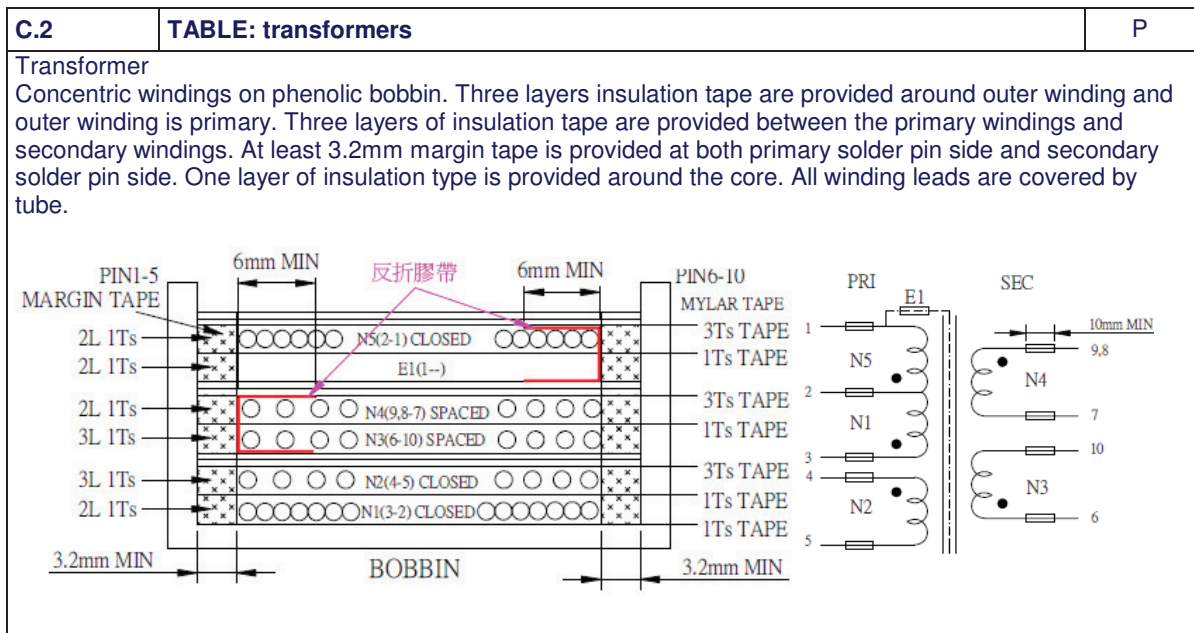

IEC 60950-1							
Clause	Requirement + Test			Result - Remark			Verdict
C.2	TABLE: transformers						P
Loc.	Tested insulation	Working voltage peak / V (2.10.2)	Working voltage rms / V (2.10.2)	Required electric strength (5.2)	Required clearance / mm (2.10.3)	Required creepage distance / mm (2.10.4)	Required distance thr. insul. (2.10.5)
T902 on power board 715G6053							
T902	Primary pin to secondary pin	506	264	3000	6.6	6.6	Bobbin thickness min. 0.4mm
T902	Primary trace to secondary trace	506	264	3000	6.6	6.6	--
T902	Primary winding to secondary pin	506	264	3000	6.6	6.6	Bobbin thickness min. 0.4mm
T902	Core to secondary pin	506	264	3000	6.6	6.6	Bobbin thickness min. 0.4mm
Loc.	Tested insulation			Test voltage/ V	Measured clearance / mm	Measured creepage dist./ mm	Measured distance thr. insul. / mm; number of layers
T902	Primary pin to secondary pin			3000	30.0	30.0	Bobbin with min. thickness. 0.45mm; triple insulated wire used as secondary windings
T902	Primary trace to secondary trace			3000	7.2	7.2	
T902	Primary winding to secondary pin			3000	10.0	10.0	
T902	Core to secondary pin			3000	13.2	13.2	
supplementary information:							

IEC 60950-1			
Clause	Requirement + Test	Result - Remark	Verdict

C.2 **TABLE: transformers** **P**

Transformer

The drawing includes a side view with dimensions B, D, 6, 7, and a note for CORE TAPE: 25um*8.5mmW 2Ts MIN E3. It also shows a front view with MARKING and dimensions 1, 6, and d. A winding direction diagram shows a clockwise rotation. A detailed view of the bobbin shows four layers of windings: N4 (5-4), N3 (7-10), N2 (2-1), and N1 (6-5). Insulation tapes are labeled as TAPE 1T, TAPE 1F, TAPE 2T, and TAPE 2F. A legend indicates 2.GA, 3.PIN, 4.COI, and symbols for WINDING START and TUBING.

TOP SIDE PIN SIDE

Concentric windings on phenolic bobbin, only one layer insulation tapes between primary and secondary windings. One layer of insulation tape wrapped on the bobbin before winding. Two layer of insulation tape wrapped on core of transformer. Secondary winding used triple insulated wire. Core is considered as primary part. Tubing on all primary windings exit end are provided.

C.2 TABLE: transformers P							
Loc.	Tested insulation	Working voltage peak / V	Working voltage rms / V	Required electric strength	Required clearance / mm	Required creepage distance / mm	Required distance thr. insul.
		(2.10.2)	(2.10.2)	(5.2)	(2.10.3)	(2.10.4)	(2.10.5)
T902 on power board 715G7300							

IEC 60950-1							
Clause	Requirement + Test				Result - Remark		Verdict
T902	Primary pin to secondary pin	531	276	3000	6.6	6.6	Bobbin thickness min. 0.4mm
T902	Primary trace to secondary trace	531	276	3000	6.6	6.6	--
T902	Primary winding to secondary pin	531	276	3000	6.6	6.6	Bobbin thickness min. 0.4mm
T902	Core to secondary pin	531	276	3000	6.6	6.6	Bobbin thickness min. 0.4mm
Loc.	Tested insulation			Test voltage/ V	Measured clearance / mm	Measured creepage dist./ mm	Measured distance thr. insul. / mm; number of layers
T902	Primary pin to secondary pin			3000	25.2	25.2	Bobbin with min. thickness. 0.45mm; triple insulated wire used as secondary windings
T902	Primary trace to secondary trace			3000	11.1	11.1	
T902	Primary winding to secondary pin			3000	10.8	10.8	
T902	Core to secondary pin			3000	10.8	10.8	
supplementary information:							

C.2	TABLE: transformers	P
------------	----------------------------	----------

IEC 60950-1

Clause	Requirement + Test	Result - Remark	Verdict
--------	--------------------	-----------------	---------

Transformer

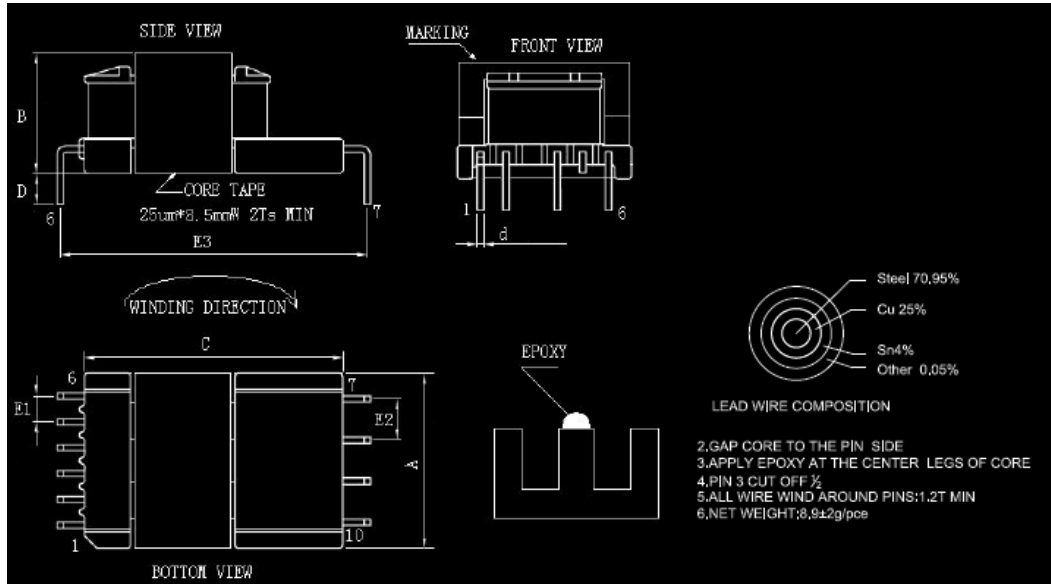

A=18.0 mm MAX

B=13.0 mm MAX

C=26.5 mm MAX

D=3.5 ± 0.3mm

E1=2.5 ± 0.3mm

E2=4.0 ± 0.3mm

E3=30.0 ± 0.5mm

d=SQ0.6 ± 0.1mm

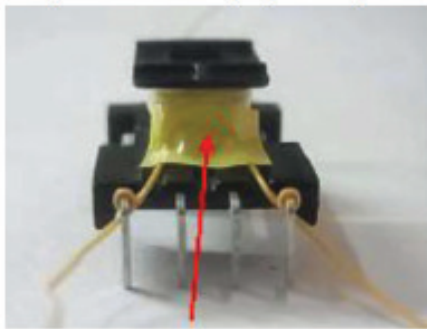

在次级侧三层绝缘线上贴一层宽度为 10mm 的 Tape, 使得 Tape 向三层绝缘线方向偏移约 1mm 贴到三层绝缘线上或直接贴 Tape 在三层绝缘线上

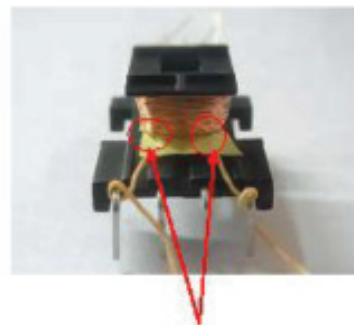

初级线圈与三层线交叉处不接触
三层线出入线交叉处需有胶布隔离

IEC 60950-1			
Clause	Requirement + Test	Result - Remark	Verdict

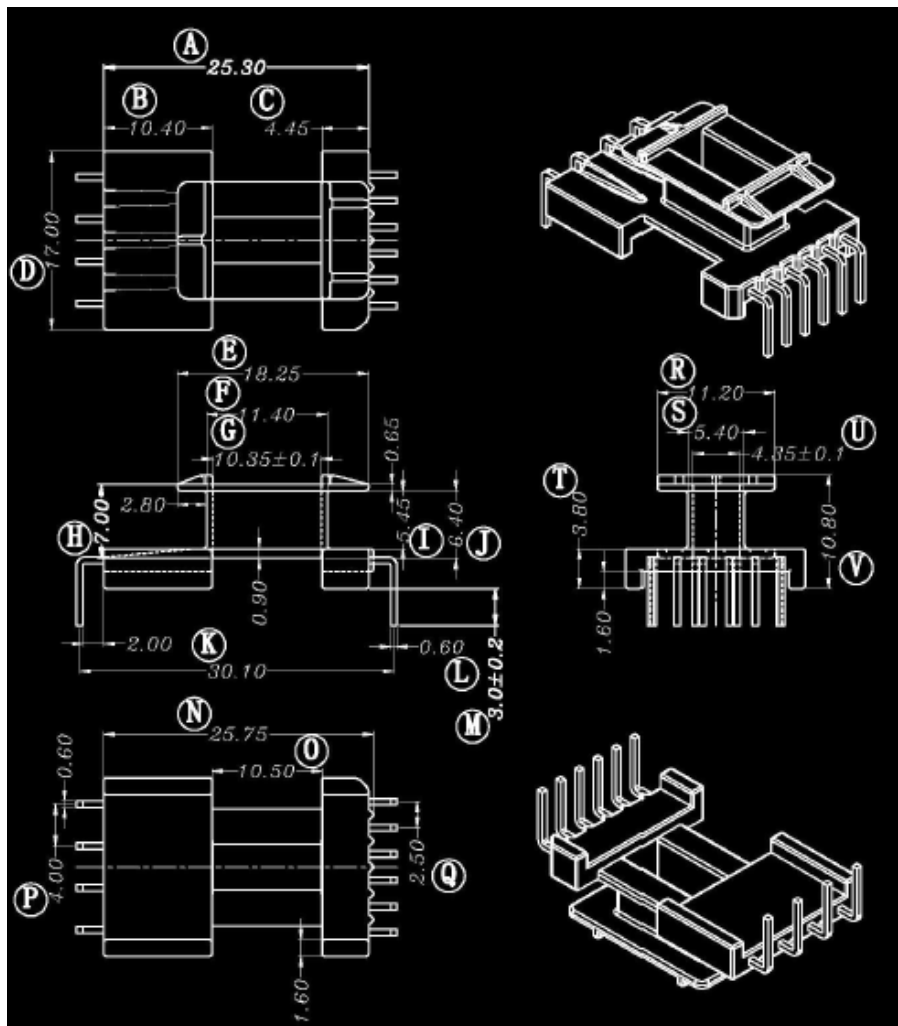
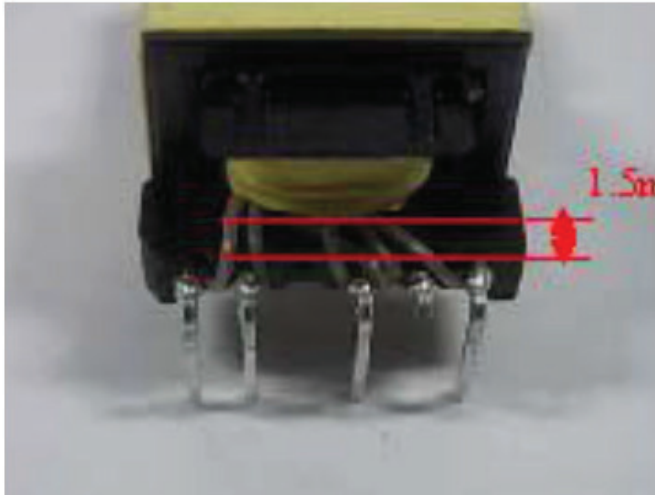

TRF No. IEC60950_1F

IEC 60950-1			
Clause	Requirement + Test	Result - Remark	Verdict

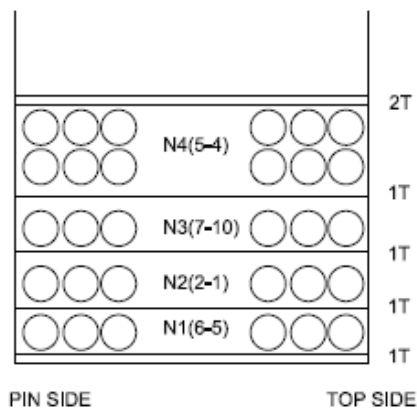
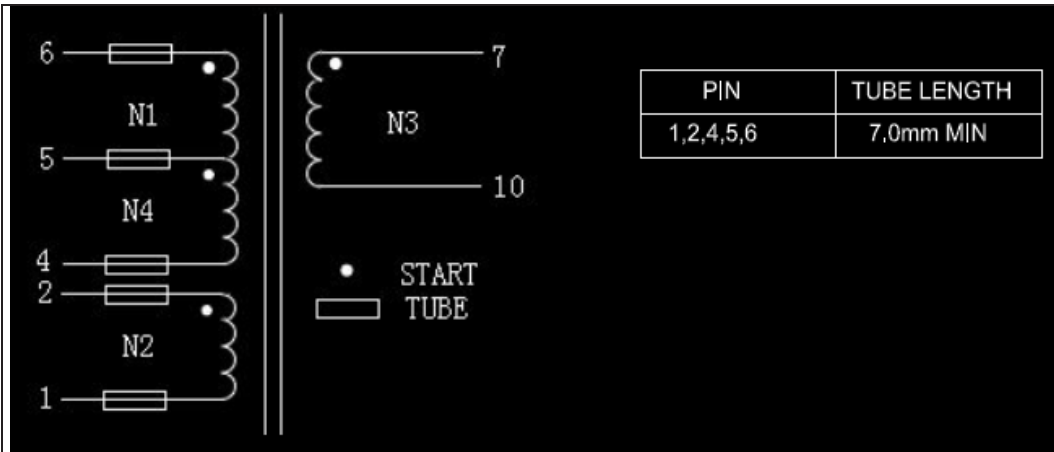

1.) Mylar tape:t0.025mm*5.8mmW

2.) PIN1,2,4,5,6 ADDED TUBE

NO.	Winding	Terminal	Wire	Turns	Remark	TAPE
						1T
1	N1	6-5	2UEW Ø0.21	21	CLOSED	1T
2	N2	2-1	2UEW Ø0.25*2	8	CLOSED	1T
3	N3	7-9	TEX-B Ø0.3*1	8	CLOSED	1T
4	N4	4-3	2UEW Ø0.21	32	CLOSED	2T

Concentric windings on phenolic bobbin, only one layer insulation tapes between primary and secondary windings. One layer of insulation tape wrapped on the bobbin before winding. Secondary winding used triple insulated wire. Core is considered as primary part. Tube used for all primary winding leads, additional insulation tape used between secondary winding leads and primary winding.

IEC60950_1F - ATTACHMENT			
Clause	Requirement + Test	Result - Remark	Verdict

**ATTACHMENT TO TEST REPORT IEC 60950-1
EUROPEAN GROUP DIFFERENCES AND NATIONAL DIFFERENCES**

Information technology equipment – Safety –
Part 1: General requirements

Differences according to	EN 60950-1:2006/A11:2009/A1:2010/A12:2011/A2:2013
Attachment Form No.	EU_GD_IEC60950_1F
Attachment Originator	SGS Fimko Ltd
Master Attachment	Date 2014-02
Copyright © 2014 IEC System for Conformity Testing and Certification of Electrical Equipment (IECEE), Geneva, Switzerland. All rights reserved.	

EN 60950-1:2006/A11:2009/A1:2010/A12:2011/A2:2013 – CENELEC COMMON MODIFICATIONS

IEC 60950-1, GROUP DIFFERENCES (CENELEC common modifications EN)			
Clause	Requirement + Test	Result - Remark	Verdict
	Clauses, subclauses, notes, tables and figures which are additional to those in IEC60950-1 and it's amendmets are prefixed "Z"		P
Contents (A2:2013)	Add the following annexes: Annex ZA (normative) Annex ZB (normative) Annex ZD (informative)	Normative references to international publications with their corresponding European publications Special national conditions IEC and CENELEC code designations for flexible cords	P
General	Delete all the "country" notes in the reference document (IEC 60950-1:2005) according to the following list: 1.4.8 Note 2 1.5.1 Note 2 & 3 1.5.8 Note 2 1.5.9.4 Note 2.2.3 Note 2.2.4 Note 2.3.2.1 Note 2 2.3.4 Note 2 2.7.1 Note 2.10.3.2 Note 2 3.2.1.1 Note 3.2.4 Note 3. 4.3.6 Note 1 & 2 4.7 Note 4 4.7.3.1Note 2 5.1.7.1 Note 3 & 4 6 Note 2 & 5 6.1.2.1 Note 2 6.2.2 Note 6.2.2.1 Note 2 7.1 Note 3 7.2 Note G.2.1 Note 2 Annex H Note 2	1.5.7.1 Note 1.7.2.1 Note 4, 5 & 6 2.3.2 Note 2.6.3.3 Note 2 & 3 2.10.5.13 Note 3 2.5.1 Note 2 4.7.2.2 Note 5.3.7 Note 1 6.1.2.2 Note 6.2.2.2 Note 7.3 Note 1 & 2	P
General (A1:2010)	Delete all the "country" notes in the reference document (IEC 60950-1:2005/A1:2010) according to the following list: 1.5.7.1 Note 6.2.2.1 Note 2	6.1.2.1 Note 2 EE.3 Note	P

IEC60950_1F - ATTACHMENT			
Clause	Requirement + Test	Result - Remark	Verdict

IEC 60950-1, GROUP DIFFERENCES (CENELEC common modifications EN)			
Clause	Requirement + Test	Result - Remark	Verdict
General (A2:2013)	Delete all the "country" notes in the reference document (IEC 60950-1:2005/A2:2013) according to the following list: 2.7.1 Note * 2.10.3.1 Note 2 6.2.2. Note * Note of secretary: Text of Common Modification remains unchanged.		P
1.1.1 (A1:2010)	Replace the text of NOTE 3 by the following. NOTE 3 The requirements of EN 60065 may also be used to meet safety requirements for multimedia equipment. See IEC Guide 112, Guide on the safety of multimedia equipment. For television sets EN 60065 applies.		P
1.3.Z1	Add the following subclause: 1.3.Z1 Exposure to excessive sound pressure The apparatus shall be so designed and constructed as to present no danger when used for its intended purpose, either in normal operating conditions or under fault conditions, particularly providing protection against exposure to excessive sound pressures from headphones or earphones. NOTE Z1 A new method of measurement is described in EN 50332-1, Sound system equipment: Headphones and earphones associated with portable audio equipment - Maximum sound pressure level measurement methodology and limit considerations - Part 1: General method for "one package equipment", and in EN 50332-2, Sound system equipment: Headphones and earphones associated with portable audio equipment - Maximum sound pressure level measurement methodology and limit considerations - Part 2: Guidelines to associate sets with headphones coming from different manufacturers.	Added.	N/A
(A12:2011)	In EN 60950-1:2006/A12:2011 Delete the addition of 1.3.Z1 / EN 60950-1:2006 Delete the definition 1.2.3.Z1 / EN 60950-1:2006 /A1:2010	Deleted.	N/A
1.5.1 (Added info*)	Add the following NOTE: NOTE Z1 The use of certain substances in electrical and electronic equipment is restricted within the EU: see Directive 2002/95/EC. New Directive 2011/65/11 *	Added.	P
1.7.2.1 (A1:2010)	In addition, for a PORTABLE SOUND SYSTEM, the instructions shall include a warning that excessive sound pressure from earphones and headphones can cause hearing loss.	Added.	N/A
1.7.2.1 (A12:2011)	In EN 60950-1:2006/A12:2011 Delete NOTE Z1 and the addition for Portable Sound System. Add the following clause and annex to the existing standard and amendments.		N/A

IEC60950_1F - ATTACHMENT			
Clause	Requirement + Test	Result - Remark	Verdict

IEC 60950-1, GROUP DIFFERENCES (CENELEC common modifications EN)			
Clause	Requirement + Test	Result - Remark	Verdict
	Zx Protection against excessive sound pressure from personal music players		N/A
	<p>Zx.1 General</p> <p>This sub-clause specifies requirements for protection against excessive sound pressure from personal music players that are closely coupled to the ear. It also specifies requirements for earphones and headphones intended for use with personal music players.</p> <p>A personal music player is a portable equipment for personal use, that:</p> <ul style="list-style-type: none"> is designed to allow the user to listen to recorded or broadcast sound or video; and primarily uses headphones or earphones that can be worn in or on or around the ears; and allows the user to walk around while in use. <p>NOTE 1 Examples are hand-held or body-worn portable CD players, MP3 audio players, mobile phones with MP3 type features, PDA's or similar equipment.</p> <p>A personal music player and earphones or headphones intended to be used with personal music players shall comply with the requirements of this sub-clause.</p> <p>The requirements in this sub-clause are valid for music or video mode only.</p> <p>The requirements do not apply:</p> <ul style="list-style-type: none"> while the personal music player is connected to an external amplifier; or while the headphones or earphones are not used. <p>NOTE 2 An external amplifier is an amplifier which is not part of the personal music player or the listening device, but which is intended to play the music as a standalone music player.</p> <p>The requirements do not apply to:</p> <ul style="list-style-type: none"> hearing aid equipment and professional equipment; <p>NOTE 3 Professional equipment is equipment sold through special sales channels. All products sold through normal electronics stores are considered not to be professional equipment.</p>	Not personal music player	N/A

IEC60950_1F - ATTACHMENT			
Clause	Requirement + Test	Result - Remark	Verdict

IEC 60950-1, GROUP DIFFERENCES (CENELEC common modifications EN)			
Clause	Requirement + Test	Result - Remark	Verdict
	<p>analogue personal music players (personal music players without any kind of digital processing of the sound signal) that are brought to the market before the end of 2015.</p> <p>NOTE 4 This exemption has been allowed because this technology is falling out of use and it is expected that within a few years it will no longer exist. This exemption will not be extended to other technologies.</p> <p>For equipment which is clearly designed or intended for use by young children, the limits of EN 71-1 apply.</p>		
	<p>Zx.2 Equipment requirements</p> <p>No safety provision is required for equipment that complies with the following:</p> <p>equipment provided as a package (personal music player with its listening device), where the acoustic output $L_{Aeq,T}$ is ≤ 85 dBA measured while playing the fixed "programme simulation noise" as described in EN 50332-1; and</p> <p>a personal music player provided with an analogue electrical output socket for a listening device, where the electrical output is ≤ 27 mV measured as described in EN 50332-2, while playing the fixed "programme simulation noise" as described in EN 50332-1.</p> <p>NOTE 1 Wherever the term acoustic output is used in this clause, the 30 s A-weighted equivalent sound pressure level $L_{Aeq,T}$ is meant. See also Zx.5 and Annex Zx.</p> <p>All other equipment shall:</p> <p>a) protect the user from unintentional acoustic outputs exceeding those mentioned above; and</p> <p>b) have a standard acoustic output level not exceeding those mentioned above, and automatically return to an output level not exceeding those mentioned above when the power is switched off; and</p>	Not such equipment.	N/A

IEC60950_1F - ATTACHMENT			
Clause	Requirement + Test	Result - Remark	Verdict

IEC 60950-1, GROUP DIFFERENCES (CENELEC common modifications EN)			
Clause	Requirement + Test	Result - Remark	Verdict
	<p>c) provide a means to actively inform the user of the increased sound pressure when the equipment is operated with an acoustic output exceeding those mentioned above. Any means used shall be acknowledged by the user before activating a mode of operation which allows for an acoustic output exceeding those mentioned above. The acknowledgement does not need to be repeated more than once every 20 h of cumulative listening time; and</p> <p>NOTE 2 Examples of means include visual or audible signals. Action from the user is always required.</p> <p>NOTE 3 The 20 h listening time is the accumulative listening time, independent how often and how long the personal music player has been switched off.</p> <p>d) have a warning as specified in Zx.3; and</p> <p>e) not exceed the following:</p> <ol style="list-style-type: none"> 1) equipment provided as a package (player with its listening device), the acoustic output shall be ≤ 100 dBA measured while playing the fixed "programme simulation noise" described in EN 50332-1; and 2) a personal music player provided with an analogue electrical output socket for a listening device, the electrical output shall be ≤ 150 mV measured as described in EN 50332-2, while playing the fixed "programme simulation noise" described in EN 50332-1. <p>For music where the average sound pressure (long term $L_{Aeq,T}$) measured over the duration of the song is lower than the average produced by the programme simulation noise, the warning does not need to be given as long as the average sound pressure of the song is below the basic limit of 85 dBA. In this case T becomes the duration of the song.</p> <p>NOTE 4 Classical music typically has an average sound pressure (long term $L_{Aeq,T}$) which is much lower than the average programme simulation noise. Therefore, if the player is capable to analyse the song and compare it with the programme simulation noise, the warning does not need to be given as long as the average sound pressure of the song is below the basic limit of 85 dBA.</p> <p>For example, if the player is set with the programme simulation noise to 85 dBA, but the average music level of the song is only 65 dBA, there is no need to give a warning or ask an acknowledgement as long as the average sound level of the song is not above the basic limit of 85 dBA.</p>		

IEC60950_1F - ATTACHMENT			
Clause	Requirement + Test	Result - Remark	Verdict
IEC 60950-1, GROUP DIFFERENCES (CENELEC common modifications EN)			
	<p>Zx.3 Warning</p> <p>The warning shall be placed on the equipment, or on the packaging, or in the instruction manual and shall consist of the following:</p> <p style="padding-left: 40px;">the symbol of Figure 1 with a minimum height of 5 mm; and</p> <p style="padding-left: 40px;">the following wording, or similar:</p> <p>“To prevent possible hearing damage, do not listen at high volume levels for long periods.”</p> <div style="text-align: center;">  </div> <p>Figure 1 – Warning label (IEC 60417-6044)</p> <p>Alternatively, the entire warning may be given through the equipment display during use, when the user is asked to acknowledge activation of the higher level.</p>	Not such equipment	N/A
	Zx.4 Requirements for listening devices (headphones and earphones)		N/A
	<p>Zx.4.1 Wired listening devices with analogue input</p> <p>With 94 dBA sound pressure output $L_{Aeq,T}$, the input voltage of the fixed “programme simulation noise” described in EN 50332-2 shall be ≥ 75 mV.</p> <p>This requirement is applicable in any mode where the headphones can operate (active or passive), including any available setting (for example built-in volume level control).</p> <p>NOTE The values of 94 dBA – 75 mV correspond with 85dBA – 27 mV and 100 dBA – 150 mV.</p>	Not such equipment	N/A

IEC60950_1F - ATTACHMENT			
Clause	Requirement + Test	Result - Remark	Verdict
IEC 60950-1, GROUP DIFFERENCES (CENELEC common modifications EN)			
Clause	Requirement + Test	Result - Remark	Verdict
	<p>Zx.4.2 Wired listening devices with digital input</p> <p>With any playing device playing the fixed "programme simulation noise" described in EN 50332-1 (and respecting the digital interface standards, where a digital interface standard exists that specifies the equivalent acoustic level), the acoustic output $L_{Aeq,T}$ of the listening device shall be ≤ 100 dBA.</p> <p>This requirement is applicable in any mode where the headphones can operate, including any available setting (for example built-in volume level control, additional sound feature like equalization, etc.).</p> <p>NOTE An example of a wired listening device with digital input is a USB headphone.</p>	Not such equipment	N/A
	<p>Zx.4.3 Wireless listening devices</p> <p>In wireless mode:</p> <p>with any playing and transmitting device playing the fixed programme simulation noise described in EN 50332-1; and</p> <p>respecting the wireless transmission standards, where an air interface standard exists that specifies the equivalent acoustic level; and</p> <p>with volume and sound settings in the listening device (for example built-in volume level control, additional sound feature like equalization, etc.) set to the combination of positions that maximize the measured acoustic output for the abovementioned programme simulation noise, the acoustic output $L_{Aeq,T}$ of the listening device shall be ≤ 100 dBA.</p> <p>NOTE An example of a wireless listening device is a Bluetooth headphone.</p>	Not such equipment	N/A
	<p>Zx.5 Measurement methods</p> <p>Measurements shall be made in accordance with EN 50332-1 or EN 50332-2 as applicable. Unless stated otherwise, the time interval T shall be 30 s.</p> <p>NOTE Test method for wireless equipment provided without listening device should be defined.</p>	Not such equipment	N/A

IEC60950_1F - ATTACHMENT									
Clause	Requirement + Test	Result - Remark	Verdict						
IEC 60950-1, GROUP DIFFERENCES (CENELEC common modifications EN)									
Clause	Requirement + Test	Result - Remark	Verdict						
2.7.1	<p>Replace the subclause as follows:</p> <p>Basic requirements</p> <p>To protect against excessive current, short-circuits and earth faults in PRIMARY CIRCUITS, protective devices shall be included either as integral parts of the equipment or as parts of the building installation, subject to the following, a), b) and c):</p> <p>a) except as detailed in b) and c), protective devices necessary to comply with the requirements of 5.3 shall be included as parts of the equipment;</p> <p>b) for components in series with the mains input to the equipment such as the supply cord, appliance coupler, r.f.i. filter and switch, short-circuit and earth fault protection may be provided by protective devices in the building installation;</p>	Replaced.	P						
	<p>c) it is permitted for PLUGGABLE EQUIPMENT TYPE B or PERMANENTLY CONNECTED EQUIPMENT, to rely on dedicated overcurrent and short-circuit protection in the building installation, provided that the means of protection, e.g. fuses or circuit breakers, is fully specified in the installation instructions.</p> <p>If reliance is placed on protection in the building installation, the installation instructions shall so state, except that for PLUGGABLE EQUIPMENT TYPE A the building installation shall be regarded as providing protection in accordance with the rating of the wall socket outlet.</p>	No such equipment	N/A						
2.7.2	This subclause has been declared 'void'.		N/A						
3.2.3	Delete the NOTE in Table 3A, and delete also in this table the conduit sizes in parentheses.	Unit is not permanently connected equipment.	N/A						
3.2.5.1	<p>Replace "60245 IEC 53" by "H05 RR-F";</p> <p>"60227 IEC 52" by "H03 VV-F or H03 VVH2-F";</p> <p>"60227 IEC 53" by "H05 VV-F or H05 VVH2-F2".</p> <p>In Table 3B, replace the first four lines by the following:</p> <table style="margin-left: 20px;"> <tr> <td>Up to and including 6 </td> <td>0,75^{a)} </td> </tr> <tr> <td>Over 6 up to and including 10 </td> <td>(0,75)^{b)} 1,0 </td> </tr> <tr> <td>Over 10 up to and including 16 </td> <td>(1,0)^{c)} 1,5 </td> </tr> </table> <p>In the conditions applicable to Table 3B delete the words "in some countries" in condition^{a)}.</p> <p>In NOTE 1, applicable to Table 3B, delete the second sentence.</p>	Up to and including 6	0,75 ^{a)}	Over 6 up to and including 10	(0,75) ^{b)} 1,0	Over 10 up to and including 16	(1,0) ^{c)} 1,5	No power supply cord provided.	N/A
Up to and including 6	0,75 ^{a)}								
Over 6 up to and including 10	(0,75) ^{b)} 1,0								
Over 10 up to and including 16	(1,0) ^{c)} 1,5								
3.2.5.1 (A2:2013)	NOTE Z1 The harmonised code designations corresponding to the IEC cord types are given in Annex ZD		N/A						

IEC60950_1F - ATTACHMENT			
Clause	Requirement + Test	Result - Remark	Verdict

IEC 60950-1, GROUP DIFFERENCES (CENELEC common modifications EN)			
Clause	Requirement + Test	Result - Remark	Verdict
3.3.4	In Table 3D, delete the fourth line: conductor sizes for 10 to 13 A, and replace with the following: Over 10 up to and including 16 1,5 to 2,5 1,5 to 4 Delete the fifth line: conductor sizes for 13 to 16 A		N/A
4.3.13.6 (A1:2010)	Replace the existing NOTE by the following: NOTE Z1 Attention is drawn to: 1999/519/EC: Council Recommendation on the limitation of exposure of the general public to electromagnetic fields 0 Hz to 300 GHz, and 2006/25/EC: Directive on the minimum health and safety requirements regarding the exposure of workers to risks arising from physical agents (artificial optical radiation).		N/A
	Standards taking into account mentioned Recommendation and Directive which demonstrate compliance with the applicable EU Directive are indicated in the OJEC.		N/A
Annex H	Replace the last paragraph of this annex by: At any point 10 cm from the surface of the OPERATOR ACCESS AREA, the dose rate shall not exceed 1 µSv/h (0,1 mR/h) (see NOTE). Account is taken of the background level. Replace the notes as follows: NOTE These values appear in Directive 96/29/Euratom. Delete NOTE 2.		N/A
Bibliography	Additional EN standards.		—

ZA	NORMATIVE REFERENCES TO INTERNATIONAL PUBLICATIONS WITH THEIR CORRESPONDING EUROPEAN PUBLICATIONS	—
-----------	--	---

ZB ANNEX (normative) SPECIAL NATIONAL CONDITIONS (EN)			
1.2.4.1	In Denmark , certain types of Class I appliances (see 3.2.1.1) may be provided with a plug not establishing earthing conditions when inserted into Danish socket-outlets.		N/A
1.2.13.14 (A11:2009)	In Norway and Sweden , for requirements see 1.7.2.1 and 7.3 of this annex.		N/A
1.5.7.1 (A11:2009)	In Finland , Norway and Sweden , resistors bridging BASIC INSULATION in CLASS I PLUGGABLE EQUIPMENT TYPE A must comply with the requirements in 1.5.7.1. In addition when a single resistor is used, the resistor must withstand the resistor test in 1.5.7.2.	No such resistors.	N/A

IEC60950_1F - ATTACHMENT			
Clause	Requirement + Test	Result - Remark	Verdict
1.5.8	In Norway , due to the IT power system used (see annex V, Figure V.7), capacitors are required to be rated for the applicable line-to-line voltage (230 V).		P
1.5.9.4	In Finland, Norway and Sweden , the third dashed sentence is applicable only to equipment as defined in 6.1.2.2 of this annex.		N/A
1.7.2.1	In Finland, Norway and Sweden , CLASS I PLUGGABLE EQUIPMENT TYPE A intended for connection to other equipment or a network shall, if safety relies on connection to protective earth or if surge suppressors are connected between the network terminals and accessible parts, have a marking stating that the equipment must be connected to an earthed mains socket-outlet. The marking text in the applicable countries shall be as follows: In Finland : "Laite on liitettävä suojakoskettimilla varustettuun pistorasiaan" In Norway : "Apparatet må tilkoples jordet stikkontakt" In Sweden : "Apparaten skall anslutas till jordat uttag"		P
1.7.2.1 (A11:2009)	In Norway and Sweden , the screen of the cable distribution system is normally not earthed at the entrance of the building and there is normally no equipotential bonding system within the building. Therefore the protective earthing of the building installation need to be isolated from the screen of a cable distribution system. It is however accepted to provide the insulation external to the equipment by an adapter or an interconnection cable with galvanic isolator, which may be provided by e.g. a retailer. The user manual shall then have the following or similar information in Norwegian and Swedish language respectively, depending on in what country the equipment is intended to be used in: "Equipment connected to the protective earthing of the building installation through the mains connection or through other equipment with a connection to protective earthing – and to a cable distribution system using coaxial cable, may in some circumstances create a fire hazard. Connection to a cable distribution system has therefore to be provided through a device providing electrical isolation below a certain frequency range (galvanic isolator, see EN 60728-11)."		

IEC60950_1F - ATTACHMENT			
Clause	Requirement + Test	Result - Remark	Verdict
	<p>NOTE In Norway, due to regulation for installations of cable distribution systems, and in Sweden, a galvanic isolator shall provide electrical insulation below 5 MHz. The insulation shall withstand a dielectric strength of 1,5 kV r.m.s., 50 Hz or 60 Hz, for 1 min.</p> <p>Translation to Norwegian (the Swedish text will also be accepted in Norway):</p> <p>“Utstyr som er koplet til beskyttelsesjord via nettplugg og/eller via annet jordtilkoplet utstyr – og er tilkoplet et kabel-TV nett, kan forårsake brannfare. For å unngå dette skal det ved tilkopling av utstyret til kabel-TV nettet installeres en galvanisk isolator mellom utstyret og kabel- TV nettet.”</p> <p>Translation to Swedish:</p> <p>”Utrustning som är kopplad till skyddsjord via jordat vägguttag och/eller via annan utrustning och samtidigt är kopplad till kabel-TV nät kan i vissa fall medföra risk för brand. För att undvika detta skall vid anslutning av utrustningen till kabel-TV nät galvanisk isolator finnas mellan utrustningen och kabel-TV nätet.”</p>		
1.7.2.1 (A2:2013)	<p>In Denmark, CLASS I PLUGGABLE EQUIPMENT TYPE A intended for connection to other equipment or a network shall, if safety relies on connection to protective earth or if surge suppressors are connected between the network terminals and accessible parts, have a marking stating that the equipment must be connected to an earthed mains socket-outlet.</p> <p>The marking text in Denmark shall be as follows: In Denmark: “Apparatets stikprop skal tilsluttes en stikkontakt med jord, som giver forbindelse til stikproppens jord.”</p>		P
1.7.5 1.7.5 (A11:2009)	<p>In Denmark, socket-outlets for providing power to other equipment shall be in accordance with the Heavy Current Regulations, Section 107-2-D1, Standard Sheet DK 1-3a, DK 1-5a or DK 1-7a, when used on Class I equipment. For STATIONARY EQUIPMENT the socket-outlet shall be in accordance with Standard Sheet DK 1-1b or DK 1-5a.</p> <p>For CLASS II EQUIPMENT the socket outlet shall be in accordance with Standard Sheet DKA 1-4a.</p>	No socket-outlet provided.	N/A

IEC60950_1F - ATTACHMENT			
Clause	Requirement + Test	Result - Remark	Verdict
1.7.5 (A2:2013)	<p>In Denmark, socket-outlets for providing power to other equipment shall be in accordance with the DS 60884-2-D1:2011.</p> <p>For class I equipment the following Standard Sheets are applicable: DK 1-3a, DK 1-1c, DK 1-1d, DK 1-5a or DK 1-7a, with the exception for STATIONARY EQUIPMENT where the socket-outlets shall be in accordance with Standard Sheet DK 1-1b, DK 1-1c, DK 1-1d or DK 1-5a.</p> <p>Socket outlets intended for providing power to Class II apparatus with a rated current of 2,5 A shall be in accordance with DS 60884-2-D1 standard sheet DKA 1-4a. Other current rating socket outlets shall be in compliance with by DS 60884-2-D1 Standard Sheet DKA 1-3a or DKA 1-3b.</p> <p>Justification the Heavy Current Regulations, 6c</p>	No socket-outlet provided.	N/A
2.2.4	In Norway , for requirements see 1.7.2.1, 6.1.2.1 and 6.1.2.2 of this annex.	No TNV.	N/A
2.3.2	In Finland, Norway and Sweden there are additional requirements for the insulation. See 6.1.2.1 and 6.1.2.2 of this annex.	No TNV.	N/A
2.3.4	In Norway , for requirements see 1.7.2.1, 6.1.2.1 and 6.1.2.2 of this annex.	No TNV.	N/A
2.6.3.3	In the United Kingdom , the current rating of the circuit shall be taken as 13 A, not 16 A.		P
2.7.1	In the United Kingdom , to protect against excessive currents and short-circuits in the PRIMARY CIRCUIT of DIRECT PLUG-IN EQUIPMENT, tests according to 5.3 shall be conducted, using an external protective device rated 30 A or 32 A. If these tests fail, suitable protective devices shall be included as integral parts of the DIRECT PLUG-IN EQUIPMENT, so that the requirements of 5.3 are met.	Not direct plug-in equipment	N/A
2.10.5.13	In Finland, Norway and Sweden , there are additional requirements for the insulation, see 6.1.2.1 and 6.1.2.2 of this annex.		N/A
3.2.1.1	<p>In Switzerland, supply cords of equipment having a RATED CURRENT not exceeding 10 A shall be provided with a plug complying with SEV 1011 or IEC 60884-1 and one of the following dimension sheets:</p> <p>SEV 6532-2.1991 Plug Type 15 3P+N+PE 250/400 V, 10 A</p>	No supply cords provided.	N/A

IEC60950_1F - ATTACHMENT			
Clause	Requirement + Test	Result - Remark	Verdict
	<p>SEV 6533-2.1991 Plug Type 11 L+N 250 V, 10 A</p> <p>SEV 6534-2.1991 Plug Type 12 L+N+PE 250 V, 10 A</p> <p>In general, EN 60309 applies for plugs for currents exceeding 10 A. However, a 16 A plug and socket-outlet system is being introduced in Switzerland, the plugs of which are according to the following dimension sheets, published in February 1998: SEV 5932-2.1998: Plug Type 25 , 3L+N+PE 230/400 V, 16 A</p> <p>SEV 5933-2.1998: Plug Type 21, L+N, 250 V, 16A</p> <p>SEV 5934-2.1998: Plug Type 23, L+N+PE 250 V, 16 A</p>		
3.2.1.1	<p>In Denmark, supply cords of single-phase equipment having a rated current not exceeding 13 A shall be provided with a plug according to the Heavy Current Regulations, Section 107-2-D1.</p> <p>CLASS I EQUIPMENT provided with socket-outlets with earth contacts or which are intended to be used in locations where protection against indirect contact is required according to the wiring rules shall be provided with a plug in accordance with standard sheet DK 2-1a or DK 2-5a.</p> <p>If poly-phase equipment and single-phase equipment having a RATED CURRENT exceeding 13 A is provided with a supply cord with a plug, this plug shall be in accordance with the Heavy Current Regulations, Section 107-2-D1 or EN 60309-2.</p>	No supply cords provided.	N/A
3.2.1.1 (A2:2013)	<p>In Denmark, supply cords of single-phase equipment having a rated current not exceeding 13 A shall be provided with a plug according to DS 60884-2-D1.</p> <p>CLASS I EQUIPMENT provided with socket-outlets with earth contacts or which are intended to be used in locations where protection against indirect contact is required according to the wiring rules shall be provided with a plug in accordance with standard sheet DK 2-1a or DK 2-5a.</p> <p>If a single-phase equipment having a RATED CURRENT exceeding 13 A or if a poly-phase equipment is provided with a supply cord with a plug, this plug shall be in accordance with the standard sheets DK 6-1a in DS 60884-2-D1 or EN 60309-2.</p> <p>Justification the Heavy Current Regulations, 6c</p>	No supply cords provided.	N/A

IEC60950_1F - ATTACHMENT			
Clause	Requirement + Test	Result - Remark	Verdict
3.2.1.1	<p>In Spain, supply cords of single-phase equipment having a rated current not exceeding 10 A shall be provided with a plug according to UNE 20315:1994.</p> <p>Supply cords of single-phase equipment having a rated current not exceeding 2,5 A shall be provided with a plug according to UNE-EN 50075:1993.</p> <p>CLASS I EQUIPMENT provided with socket-outlets with earth contacts or which are intended to be used in locations where protection against indirect contact is required according to the wiring rules, shall be provided with a plug in accordance with standard UNE 20315:1994.</p> <p>If poly-phase equipment is provided with a supply cord with a plug, this plug shall be in accordance with UNE-EN 60309-2.</p>	No supply cords provided.	N/A
3.2.1.1	<p>In the United Kingdom, apparatus which is fitted with a flexible cable or cord and is designed to be connected to a mains socket conforming to BS 1363 by means of that flexible cable or cord and plug, shall be fitted with a 'standard plug' in accordance with Statutory Instrument 1768:1994 - The Plugs and Sockets etc. (Safety) Regulations 1994, unless exempted by those regulations.</p> <p>NOTE 'Standard plug' is defined in SI 1768:1994 and essentially means an approved plug conforming to BS 1363 or an approved conversion plug.</p>	No supply cords provided.	N/A
3.2.1.1	<p>In Ireland, apparatus which is fitted with a flexible cable or cord and is designed to be connected to a mains socket conforming to I.S. 411 by means of that flexible cable or cord and plug, shall be fitted with a 13 A plug in accordance with Statutory Instrument 525:1997 - National Standards Authority of Ireland (section 28) (13 A Plugs and Conversion Adaptors for Domestic Use) Regulations 1997.</p>	No supply cords provided.	N/A
3.2.4	In Switzerland , for requirements see 3.2.1.1 of this annex.		N/A
3.2.5.1	In the United Kingdom , a power supply cord with conductor of 1,25 mm ² is allowed for equipment with a rated current over 10 A and up to and including 13 A.	No supply cords provided.	N/A
3.3.4	<p>In the United Kingdom, the range of conductor sizes of flexible cords to be accepted by terminals for equipment with a RATED CURRENT of over 10 A up to and including 13 A is:</p> <ul style="list-style-type: none"> • 1,25 mm² to 1,5 mm² nominal cross-sectional area. 	No supply cords provided.	N/A

IEC60950_1F - ATTACHMENT			
Clause	Requirement + Test	Result - Remark	Verdict
4.3.6	In the United Kingdom , the torque test is performed using a socket outlet complying with BS 1363 part 1:1995, including Amendment 1:1997 and Amendment 2:2003 and the plug part of DIRECT PLUG-IN EQUIPMENT shall be assessed to BS 1363: Part 1, 12.1, 12.2, 12.3, 12.9, 12.11, 12.12, 12.13, 12.16 and 12.17, except that the test of 12.17 is performed at not less than 125 °C. Where the metal earth pin is replaced by an Insulated Shutter Opening Device (ISOD), the requirements of clauses 22.2 and 23 also apply.	Not direct plug-in equipment.	N/A
4.3.6	In Ireland , DIRECT PLUG-IN EQUIPMENT is known as plug similar devices. Such devices shall comply with Statutory Instrument 526:1997 - National Standards Authority of Ireland (Section 28) (Electrical plugs, plug similar devices and sockets for domestic use) Regulations, 1997.	Not direct plug-in equipment.	N/A
5.1.7.1	In Finland, Norway and Sweden TOUCH CURRENT measurement results exceeding 3,5 mA r.m.s. are permitted only for the following equipment: <ul style="list-style-type: none"> • STATIONARY PLUGGABLE EQUIPMENT TYPE A that <ul style="list-style-type: none"> is intended to be used in a RESTRICTED ACCESS LOCATION where equipotential bonding has been applied, for example, in a telecommunication centre; and has provision for a permanently connected PROTECTIVE EARTHING CONDUCTOR; and is provided with instructions for the installation of that conductor by a SERVICE PERSON; • STATIONARY PLUGGABLE EQUIPMENT TYPE B; • STATIONARY PERMANENTLY CONNECTED EQUIPMENT. 	Measured touch current not exceeding 3,5 mA r.m.s.	N/A
6.1.2.1 (A1:2010)	In Finland, Norway and Sweden , add the following text between the first and second paragraph of the compliance clause: If this insulation is solid, including insulation forming part of a component, it shall at least consist of either - two layers of thin sheet material, each of which shall pass the electric strength test below, or - one layer having a distance through insulation of at least 0,4 mm, which shall pass the electric strength test below. Alternatively for components, there is no distance through insulation requirements for the insulation consisting of an insulating compound completely filling the casing, so that CLEARANCES and CREEPAGE DISTANCES do not exist, if the component passes the electric strength test in	No connection to telecommunication networks.	N/A

IEC60950_1F - ATTACHMENT			
Clause	Requirement + Test	Result - Remark	Verdict
	<p>accordance with the compliance clause below and in addition</p> <ul style="list-style-type: none"> - passes the tests and inspection criteria of 2.10.11 with an electric strength test of 1,5 kV multiplied by 1,6 (the electric strength test of 2.10.10 shall be performed using 1,5 kV), and - is subject to ROUTINE TESTING for electric strength during manufacturing, using a test voltage of 1,5 kV. 		
	<p>It is permitted to bridge this insulation with an optocoupler complying with 2.10.5.4 b).</p> <p>It is permitted to bridge this insulation with a capacitor complying with EN 60384-14:2005, subclass Y2.</p> <p>A capacitor classified Y3 according to EN 60384-14:2005, may bridge this insulation under the following conditions:</p> <ul style="list-style-type: none"> - the insulation requirements are satisfied by having a capacitor classified Y3 as defined by EN 60384-14, which in addition to the Y3 testing, is tested with an impulse test of 2,5 kV defined in EN 60950-1:2006, 6.2.2.1; - the additional testing shall be performed on all the test specimens as described in EN 60384-14: - the impulse test of 2,5 kV is to be performed before the endurance test in EN 60384-14, in the sequence of tests as described in EN 60384-14. 		N/A
6.1.2.2	<p>In Finland, Norway and Sweden, the exclusions are applicable for PERMANENTLY CONNECTED EQUIPMENT, PLUGGABLE EQUIPMENT TYPE B and equipment intended to be used in a RESTRICTED ACCESS LOCATION where equipotential bonding has been applied, e.g. in a telecommunication centre, and which has provision for a permanently connected PROTECTIVE EARTHING CONDUCTOR and is provided with instructions for the installation of that conductor by a SERVICE PERSON.</p>	No connection to telecommunication networks.	N/A
7.2	<p>In Finland, Norway and Sweden, for requirements see 6.1.2.1 and 6.1.2.2 of this annex.</p> <p>The term TELECOMMUNICATION NETWORK in 6.1.2 being replaced by the term CABLE DISTRIBUTION SYSTEM.</p>	Not connected to cable distribution system.	N/A
7.3 (A11:2009)	<p>In Norway and Sweden, for requirements see 1.2.13.14 and 1.7.2.1 of this annex.</p>	Not connected to cable distribution system.	N/A

IEC60950_1F - ATTACHMENT			
Clause	Requirement + Test	Result - Remark	Verdict

**Annex ZD
(informative)**

IEC and CENELEC code designations for flexible cords

Type of flexible cord	Code designations	
	IEC	CENELEC
PVC insulated cords		
Flat twin tinsel cord	60227 IEC 41	H03VH-Y
Light polyvinyl chloride sheathed flexible cord	60227 IEC 52	H03VV-F H03VVH2-F
Ordinary polyvinyl chloride sheathed flexible cord	60277 IEC 53	H05VV-F H05VVH2-F
Rubber insulated cords		
Braided cord	60245 IEC 51	H03RT-F
Ordinary tough rubber sheathed flexible cord	60245 IEC 53	H05RR-F
Ordinary polychloroprene sheathed flexible cord	60245 IEC 57	H05RN-F
Heavy polychloroprene sheathed flexible cord	60245 IEC 66	H07RN-F
Cords having high flexibility		
Rubber insulated and sheathed cord	60245 IEC 86	H03RR-H
Rubber insulated, crosslinked PVC sheathed cord	60245 IEC 87	H03RV4-H
Crosslinked PVC insulated and sheathed cord	60245 IEC 88	H03V4V4-H

IEC60950_1F - ATTACHMENT			
Clause	Requirement + Test	Result - Remark	Verdict

ATTACHMENT TO TEST REPORT IEC 60950-1 FINLAND NATIONAL DIFFERENCES Information technology equipment – Safety – Part 1: General requirements			
Differences according to: EN 60950-1:2006/A11:2009/A1:2010			
Attachment Form No.: FI_ND_IEC60950_1C			
Attachment Originator: SGS Fimko Ltd			
Master Attachment: Date (2010-04)			
Copyright © 2010 IEC System for Conformity Testing and Certification of Electrical Equipment (IECEE), Geneva, Switzerland. All rights reserved.			

	National Differences		
General	See also Group Differences (EN 60950-1:2006/A11/A1)		P
1.5.7.1	In Finland resistors bridging BASIC INSULATION in CLASS I PLUGGABLE EQUIPMENT TYPE A must comply with the requirements in 1.5.7.1. In addition when a single resistor is used, the resistor must withstand the resistor test in 1.5.7.2.		N/A
1.5.9.4	In Finland , the third dashed sentence is applicable only to equipment as defined in 6.1.2.2 of this annex.	No such construction.	N/A
1.7.2.1	In Finland , CLASS I PLUGGABLE EQUIPMENT TYPE A intended for connection to other equipment or a network shall, if safety relies on connection to protective earth or if surge suppressors are connected between the network terminals and accessible parts, have a marking stating that the equipment must be connected to an earthed mains socket-outlet. The marking text in in Finland shall be as follows: "Laitte on liitettävä suojakoskettimilla varustettuun pistorasiaan"		P
2.3.2	In Finland , there are additional requirements for the insulation. See 6.1.2.1 and 6.1.2.2 of this annex.	No TNV.	N/A
2.10.5.13	In Finland , there are additional requirements for the insulation, see 6.1.2.1 and 6.1.2.2 of this annex.	No TNV.	N/A

IEC60950_1F - ATTACHMENT			
Clause	Requirement + Test	Result - Remark	Verdict
5.1.7.1	<p>In Finland, TOUCH CURRENT measurement results exceeding 3,5 mA r.m.s. are permitted only for the following equipment:</p> <ul style="list-style-type: none"> • STATIONARY PLUGGABLE EQUIPMENT TYPE A that <ul style="list-style-type: none"> - is intended to be used in a RESTRICTED ACCESS LOCATION where equipotential bonding has been applied, for example, in a telecommunication centre; and - has provision for a permanently connected PROTECTIVE EARTHING CONDUCTOR; and - is provided with instructions for the installation of that conductor by a SERVICE PERSON; • STATIONARY PLUGGABLE EQUIPMENT TYPE B; • STATIONARY PERMANENTLY CONNECTED EQUIPMENT. 	Not exceed 3.5mA.	N/A
6.1.2.1 (A1:2010)	<p>In Finland, add the following text between the first and second paragraph of the compliance clause:</p> <p>If this insulation is solid, including insulation forming part of a component, it shall at least consist of either</p> <ul style="list-style-type: none"> - two layers of thin sheet material, each of which shall pass the electric strength test below, or - one layer having a distance through insulation of at least 0,4 mm, which shall pass the electric strength test below. <p>Alternatively for components, there is no distance through insulation requirement for the insulation consisting of an insulating compound completely filling the casing, so that CLEARANCES and CREEPAGE DISTANCES do not exist, if the component passes the electric strength test in accordance with the compliance clause below and in addition</p> <ul style="list-style-type: none"> - passes the tests and inspection criteria of 2.10.11 with an electric strength test of 1,5 kV multiplied by 1,6 (the electric strength test of 2.10.10 shall be performed using 1,5 kV), and - is subject to ROUTINE TESTING for electric strength during manufacturing, using a test voltage of 1,5 kV. 	No TNV.	N/A

IEC60950_1F - ATTACHMENT			
Clause	Requirement + Test	Result - Remark	Verdict
	<p>It is permitted to bridge this insulation with an optocoupler complying with 2.10.5.4 b).</p> <p>It is permitted to bridge this insulation with a capacitor complying with EN 60384-14:2005, subclass Y2.</p> <p>A capacitor classified Y3 according to EN 60384-14:2005, may bridge this insulation under the following conditions:</p> <ul style="list-style-type: none"> - the insulation requirements are satisfied by having a capacitor classified Y3 as defined by EN 60384-14:2005 which in addition to the Y3 testing, is tested with an impulse test of 2,5 kV defined in EN 60950-1:2006, 6.2.2.1; - the additional testing shall be performed on all the test specimens as described in EN 60384-14:2005; - the impulse test of 2,5 kV is to be performed before the endurance test in EN 60384-14:2005, in the sequence of tests as described in EN 60384-14:2005. 		
6.1.2.2	<p>In Finland, the exclusions are applicable for PERMANENTLY CONNECTED EQUIPMENT, PLUGGABLE EQUIPMENT TYPE B and equipment intended to be used in a RESTRICTED ACCESS LOCATION where equipotential bonding has been applied, e.g. in a telecommunication centre, and which has provision for a permanently connected PROTECTIVE EARTHING CONDUCTOR and is provided with instructions for the installation of that conductor by a SERVICE PERSON.</p>	No TNV.	N/A
7.2	<p>In Finland, for requirements see 6.1.2.1 and 6.1.2.2 of this annex.</p> <p>The term TELECOMMUNICATION NETWORK in 6.1.2 being replaced by the term CABLE DISTRIBUTION SYSTEM.</p>	Not connected to cable distribution system.	N/A

IEC60950_1F - ATTACHMENT			
Clause	Requirement + Test	Result - Remark	Verdict

<p>ATTACHMENT TO TEST REPORT IEC 60950-1 GERMANY NATIONAL DIFFERENCES Information technology equipment – Safety – Part 1: General requirements</p>
<p>Differences according to: VDE 0805-1:2011-01</p>

Annex ZC, 1.7.2.1	According to GPSG, section 2, clause 4: If certain rules on the use, supplementation or maintenance of an item of technical work equipment or ready-to-use commodity must be observed in order to guarantee safety and health, instructions for use in German must be supplied when it is brought into circulation.		N/A
----------------------	--	--	------------

IEC60950_1F - ATTACHMENT			
Clause	Requirement + Test	Result - Remark	Verdict

**ATTACHMENT TO TEST REPORT IEC 60950-1
ISRAEL NATIONAL DIFFERENCES**

Information technology equipment – Safety –
Part 1: General requirements

Differences according to.....: SI 60950 Part 1

1.1.1	Replace the the text of Note 3 as follows: The requirements of Israel Standard SI 60065 may also be used to meet safety requirements for multimedia equipment. See IEC Guide 112, Guide on the safety of multimedia equipment.	Replaced.	P
1.6	The clause is applicable with the following addition:		N/A
1.6.1	Add following note: In Israel, this clause is applicable subject to the Electricity Law, 1954, its regulations and revisions.	Added	N/A
1.7	The clause is applicable with the following additions: Subclause 1.7.201 shall be added at the beginning of the clause as follows:	Added	N/A
1.7.201	Marking in the Hebrew language The marking in the Hebrew language shall be in accordance with the Consumer Protection Order (Marking of goods), 1983. In addition to the marking required by clause 1.7.1, the following details shall be marked in the Hebrew language. The details shall be marked on the apparatus or on its package, or on a label properly attached to the apparatus or on the package, by bonding or sewing, in a manner that the label cannot be easily removed. 1. Name of the apparatus and it commercial designation; 2. Manufacturer's name and address. If the apparatus is imported, the importer's name and address; 3. Manufacturer's registered trademark, if any; 4. Name of the model and serial number, if any; 5. Country of manufacture.		N/A
1.7.2.1	The following shall be added to the clause: All the instructions and warnings related to safety shall also be written in the Hebrew language.	Added	N/A
2	The clause is applicable with the following additions:		P

IEC60950_1F - ATTACHMENT			
Clause	Requirement + Test	Result - Remark	Verdict
2.9.4	<p>The following shall be added at the beginning of the clause:</p> <p>In Israel, according to the Electricity Law, 1954, and the Electricity Regulations (Earthing and means of protection against electricity of voltages up to 1,000V) 1991, seven means of protection against electrocution are permitted, as follows:</p> <p>1) TN-S - Network system earthing; TN-C-S - Network system earthing; 2) TT - Network system earthing; 3) IT - Network Insulation Terre; 4) Isolated transformer; 5) Safety extra low voltage (SELV or ELV); 6) Residual current circuit breaker (30 mA = IΔ); 7) Reinforced insulation; Double insulation (class II)</p>	Added.	P
2.201	<p>Prevention of electromagnetic interference</p> <p>- Prior to carrying out the tests in accordance with the clauses of this Standard, the compliance of the apparatus with the relevant requirements specified in the appropriate part of the Standard series, SI 961, shall be checked.</p> <p><u>The apparatus shall meet the requirements in the appropriate part of the Standard series, SI 961.</u></p> <p>- If there are components in the apparatus for the prevention of electromagnetic interference, these components shall not reduce the safety level of the apparatus as required by this Standard.</p>		N/A
3	The clause is applicable with the following additions:		
3.2.1.1	<p>Connection to an a.c. mains supply</p> <p>After the note, the following note shall be added:</p> <p>Note:</p> <p>In Israel, the feed plug shall comply with the requirements of Israel Standard SI 32 Part 1.1.</p>	No feed plug provided.	N/A
3.2.1.2	<p>Connection to a d.c. mains supply</p> <p>At the end of the first paragraph, the following note shall be added:</p> <p>Note:</p> <p>At the time of issue of this Standard, there is no Israel Standard for connection accessories to d.c.</p>	No connected to d.c. mains supply	N/A
Annex P	<p>Normative references</p> <p>(List of relevant Israel Standards that have been inserted in place of some of the International Standards)</p>	Inserted	P

IEC60950_1F - ATTACHMENT			
Clause	Requirement + Test	Result - Remark	Verdict

<p>ATTACHMENT TO TEST REPORT IEC 60950-1 KOREA NATIONAL DIFFERENCES Information technology equipment – Safety – Part 1: General requirements</p>
<p>Differences according to.....: K 60950-1</p>

1.5.101	Plugs for the connection of the apparatus to the supply mains shall comply with the Korean requirement (KSC 8305)	No power supply cord provided.	N/A
8	EMC The apparatus shall comply with the relevant CISPR standards.		N/A

IEC60950_1F - ATTACHMENT			
Clause	Requirement + Test	Result - Remark	Verdict

J 60950-1(H27) TEST REPORT (Deviations from IEC 60950-1:2005+A1:2009) Special National conditions, National deviation and other information according to MITI Ordinance No. 85. <u>Japanese unique deviations</u> in J60950-1(H27) (=JIS C 6950-1:2014)			
1.2.4.1	Replace the existing NOTE as NOTE 1, and add NOTE 2 as following: NOTE 2: Even if the equipment is designed as CLASS I EQUIPMENT, if a 2-pin plug adaptor with a protective earthing lead wire (adaptor which converts a plug for CLASS I EQUIPMENT to a 2-pin plug with no earthing contact) or a cord set having a 2-pin plug with a protective earthing lead wire is packed as accessory together with the equipment or if use of those is recommended to the users, the equipment is considered as CLASS 0I EQUIPMENT.	Added. Class I.	P
1.2.4.3A	Add 1.2.4.3A as following: 1.2.4.3A CLASS 0I EQUIPMENT Equipment having a mains plug without earthing contact, which protection against electric shock is achieved by: - using BASIC INSULATION; and - for the measures to connect conductive part(s) regarded as part at HAZARDIOUS VOLTAGE in the event of fault of BASIC INSULATION to PROTECTIVE EARTHING CONDUCTOR, equipping any one of the following: a) mains plug with a protective earthing lead wire, this includes the following cases: - where a 2-pin plug adaptor with a protective earthing lead wire is packed as accessory together with the equipment; or - where use of it is recommended. b) independent protective earthing terminal (see 2.6.5.8A) if the equipment uses a power supply cord of two conductors (exclude earthing conductor) NOTE - CLASS 0I EQUIPMENT may have a part constructed with DOUBLE INSULATION or REINFORCED INSULATION.	Class I	N/A

IEC60950_1F - ATTACHMENT			
Clause	Requirement + Test	Result - Remark	Verdict
1.3.2	<p>Add the following NOTES after first paragraph:</p> <p>NOTE 1 TRANSPORTABLE or similar equipment that are relocated frequently for intended usage it is recommended not to design as CLASS I or CLASS 0I EQUIPMENT unless it is intended to be installed by a SERVICE PERSON or installation personnel.</p> <p>NOTE 2 Considering wiring circumstance in Japan, equipment intended to be installed where the provision for earthing connection is unlikely should not be designed as CLASS I or CLASS 0I EQUIPMENT unless it is intended to be installed by a SERVICE PERSON or installation personnel.</p>	Added.	N/A
1.5.1	<p>Replace the first paragraph with the following:</p> <p>Where safety is involved, components shall comply either with the requirements of this standard, with the safety aspects of the relevant JIS component standards, or IEC component standards in case there is no applicable JIS component standard available. However, a component that falls within the scope of METI Ministerial ordinance No. 85 is properly used in accordance with its marked ratings, requirements of 1.5.4, 2.8.7 and 3.2.5 apply, and in addition, for connector of power cord set which is capable of insertion to one of appliance inlets specified in either IEC 60320-1 or JIS C 8283-1, the connector shall comply with the dimensions of the appropriate connector specified in IEC 60320-1 or JIS C 8283-1.</p> <p>Replace NOTE 1 with the following:</p> <p>NOTE 1 A JIS or an IEC component standard is considered relevant only if the component in question clearly falls within its scope.</p>	Replaced.	P

IEC60950_1F - ATTACHMENT			
Clause	Requirement + Test	Result - Remark	Verdict
1.5.2	<p>Replace first sentence in the first dashed paragraph with the following:</p> <ul style="list-style-type: none"> - a component that has been demonstrated to comply with a JIS component standard harmonized with the relevant IEC component standard, or where such JIS component standard is not available, a component that has been demonstrated to comply with the relevant IEC component standard shall be checked for correct application and use in accordance with its rating. <p>Replace existing NOTE to NOTE 1 without modification of the sentence in the second dashed paragraph.</p> <p>Replace “where no relevant IEC component standard exists” to “where neither the relevant IEC component standard nor JIS standard corresponding to the relevant IEC component standard exists” in the third dashed paragraph.</p> <p>Add NOTE 2 as follows: NOTE 2 If an appliance inlet with a rated current of 10A, which is of STANDARD SHEET C14 specified in JIS C 8283-1, is used for equipment with a rated voltage of 125V or less; and with a rated current of exceeding 10A, refer to 1.7.5A.</p>	Replaced.	P
1.5.9.1	<p>General</p> <p>Replace the following at first dash of NOTE 2:</p> <p>JIS C5381-21 [Part 21 of Low pressure surge protection device : Performance requirement and test method of surge protection device (SPD) which connected with communication channel and signal]</p>	No gas discharge tube (GDT).	N/A
1.5.9.4	<p>Add the following at last paragraph:</p> <p>It is permitted to use a gas discharge tube (GDT) in series with a VDR that bridges BASIC INSULATION in accordance with the conditions in this subclause if the GDT complies with the requirements for FUNCTIONAL INSULATION.</p>	No gas discharge tube (GDT).	N/A
1.7.1	<p>Replace the existing dashed items for manufacturer’s name etc. and for model identification etc. with the following respectively:</p> <ul style="list-style-type: none"> - manufacturer’s (or responsible business operator’s) name or trade-mark or identification mark; - manufacturer’s (or responsible business operator’s) model identification or type reference; <p>In the last paragraph, replace “ISO 7000 or IEC 60417” with “JIS S 0101, ISO 7000 or IEC 60417”.</p>	Replaced.	P

IEC60950_1F - ATTACHMENT			
Clause	Requirement + Test	Result - Remark	Verdict
1.7.2.1	Add the following: Instructions and the marking(s) on equipment, which related to safety, shall be made in Japanese.		N/A
1.7.5	Replace IEC 60083 with JIS C 8303 in the second paragraph.	Replaced.	N/A
1.7.5A	Add the following new clause after 1.7.5 1.7.5.A Power supply cord set If an appliance inlet with a rated current of 10 A, which is of STANDARD SHEET C14 specified in JIS C 8283-1, is used for equipment with a rated voltage of 125 V or less and with a rated current of exceeding 10 A, the operating instructions shall provide the following or equivalent instruction: "この機器に同梱(輸)した指定の電源コードセットだけを使用する。" For equipment with an appliance inlet, if a power supply cord set is not provided by packing together with the equipment, the operating instructions shall provide information on the applicable power supply cord set. NOTE For the combination of CLASS 0I EQUIPMENT equipped with an appliance inlet with earthing contact and a power supply cord set of two conductors (exclude earthing conductor), to pack the power supply cord set together with the equipment and to provide a sentence calling attention of the following purport in the operating instructions are recommended, because such power supply cord set is a special kind of cord set: - this is usable only for this equipment; and - to use this for other equipment is not allowed.	Added.	N/A
1.7.14A	Add the following new clause after 1.7.14 1.7.14A Marking for protective earthing connection for CLASS 0I EQUIPMENT CLASS 0I EQUIPMENT shall be provided with the following or equivalent instruction: - on the mains-plug or the easily visible section of equipment, the following instruction: 必ず接地接続を行って下さい。 - in the easily visible section of equipment or in the operating instructions, the following instruction: 接地接続は必ず、電源プラグを電源につなぐ前に行ってください。 また、接地接続を外す場合は、必ず電源プラグを電源から切り離してから行って下さい。	Added. Class I.	N/A

IEC60950_1F - ATTACHMENT			
Clause	Requirement + Test	Result - Remark	Verdict
1.7.14B	Add the following new clause after 1.7.14 1.7.14B Protective earth wire used for CLASS 0I EQUIPMENT For CLASS 0I EQUIPMENT equipped with a separate protective earthing terminal as main protective earthing terminal, if a protective earth wire is not provided by packing together with the equipment, the operating instructions shall provide information on the applicable protective earth wire. (See 2.6.3.2.)	Added. Class I.	N/A
2.1.1.1	In b) of the fifth paragraph, replace "IEC 60083, IEC 60309, IEC 60320, IEC 60906-1 or IEC 60906-2" with "JIS C 8303, (the Ministerial Ordinance establishing Technical Requirements for Electrical Appliances and Materials, MEIT Ordinance No. 85, Clause 1 (METI Ordinance No. 34 of 2013), JIS C 8285, the IEC 60309 series of standards, the JIS C 8283 series of standards, the IEC 60320 series of standards".	Replaced.	P
2.6.3.2	Add the following: If the conductor of protective earthing lead wire or the protective earth wire of CLASS 0I EQUIPMENT is of single-core, it shall be one of the following: - annealed copper wire of 1,6 mm in diameter, or metallic wire having the same or more strength and diameter and being not easily corrosive; or - single-core cord or single-core cable (sheathed flexible cable), which have a cross-sectional area of at least 1,25 mm ² .	Added. Class I.	N/A
2.6.3.5	Add the following: However, this requirement does not apply to the inside conductor of power supply cord (or power supply cord set), which has been molded together with a plug and a connector and has been sheathed.	Added.	N/A
2.6.4.2	Add the following: For CLASS 0I EQUIPMENT equipped with a separate protective earthing terminal, the protective earthing terminal may be used as the main protective earthing terminal.	Added. Class I.	N/A
2.6.5.4	Replace 1st sentence with the following. "Protective earthing conductors" with "Protective earthing conductors of CLASS I EQUIPMENT".	Replaced.	P
2.6.5.6	Replace "protective earthing terminals" with "protective earthing and protective bonding terminals".	Replaced.	P

IEC60950_1F - ATTACHMENT			
Clause	Requirement + Test	Result - Remark	Verdict
2.6.5.8A	<p>Add the following new clause. after 2.6.5.8A</p> <p>2.6.5.8A Earthing of CLASS 0I EQUIPMENT Plugs with a lead wire for earthing shall not be used for equipment having a rated voltage exceeding 150V. For plugs with a lead wire for earthing, the lead wire shall not be earthed by a clip. CLASS 0I EQUIPMENT shall be provided with an earthing terminal or lead wire for earthing in the external location where easily visible.</p>	Added. Class I.	N/A
2.9.3 Table 2H	Deleted the following mark of Figure 2H: B13 e) and S2 d)	Deleted	N/A
2.9.3 Figure 2H	Addition of marking for table 2H: B8, B9, B12, B13, S1	Added	N/A
2.10.3.1	<p>In the third paragraph, replace IEC 60664-1 with JIS C 60664-1.</p> <p>Replace the 8th paragraph with the following: The above minimum CLEARANCES for connectors do not apply to:</p> <ul style="list-style-type: none"> - connectors that comply with JIS C 8285, the IEC 60309 series of standards, the JIS C 8283 series of standards, the IEC 60320 series of standards or JIS C 8303; and - connectors that comply with the Ministerial Ordinance establishing Technical Requirements for Electrical Appliances and Materials MEIT Ordinance No. 85, Clause 1 (METI Ordinance No. 34 of 2013), and comply with the dimensions specified in the JIS C 8283 series of standards, JIS C 8303 or IEC 60309-2; see also 1.5.2. 	Replaced.	P
2.10.3.2	<p>In the bottom column of Table 2J, add the following: In Japan, the MAINS TRANSIENT VOLTAGE value against the nominal AC MAINS SUPPLY voltage of 100 V is decided by applying the columns for the AC MAINS SUPPLY voltage of 150 V.</p>	Added.	P
2.10.3.3	<p>In Table 2L, add the following into the column specifying the additional CLEARANCES and at the end: For intermediate voltage values between the PEAK WORKING VOLTAGE values given in this table, linear interpolation is permitted between the nearest two points, the calculated additional minimum CLEARANCE being rounded up to the next higher 0,1 mm increment.</p>	Added.	P

IEC60950_1F - ATTACHMENT			
Clause	Requirement + Test	Result - Remark	Verdict
2.10.4.3	Replace the 6th paragraph with the following: The above minimum CLEPAGE DISTANCES for connectors do not apply to: - connectors that comply with JIS C 8285, the IEC 60309 series of standards, the JIS C 8283 series of standards, the IEC 60320 series of standards or JIS C 8303; and - connectors that comply with the Ministerial Ordinance establishing Technical Requirements for Electrical Appliances and Materials MEIT Ordinance No. 85, Clause 1 (METI Ordinance No. 34 of 2013), and comply with the dimensions specified in the JIS C 8283 series of standards, JIS C8303 or IEC 60309-2; see also 1.5.2.	Replaced.	P
2.10.9	Replace clause which as test method of T^I from 1.4.5 to 1.4.12.	Replaced.	N/A
3.2.1.1	Add the following: When equipment with an appliance inlet connects to AC mains supply, see clause 1.7.5A for the relevant mark of power supply cord set.	Added.	N/A
3.2.3	Add the following after Table 3A: Table 3A applies when cables complying JIS C 3662 or JIS C 3663 are used. In case of other cables, cable entries shall be so designed that a conduit suitable for the cable used can be fitted.	Added.	N/A
3.2.4	Add the following: The equipment shall have a structure of which the soldered sections of the terminals of appliance inlet are not subjected to mechanical stress during the insertion or removal of the connector, except the case fixing the appliance inlet itself mechanically but not only by soldering.	Body of appliance inlet secured to metal chassis by screws and lock washer, and wire soldered to inlet pins.	P
3.2.5.1	At the end of the first dashed item, replace “; and” with “, or be a sheathed cord complying with Appendix 1 specified in the Interpretation for the Ministerial Ordinance establishing Technical Requirements for Electrical Appliances and Materials MEIT Ordinance No. 85, Clause 1 (METI Ordinance No. 34 of 2013) ; and”.	Added.	N/A
	In the second dashed item, replace “insulated:” with “insulated, be a cord of the following or be a sheathed cord complying with Appendix 1 specified in the Interpretation for the Ministerial Ordinance establishing Technical Requirements for Electrical Appliances and Materials MEIT Ordinance No. 85, Clause 1 (METI Ordinance No. 34 of 2013), :”	Replaced.	N/A

IEC60950_1F - ATTACHMENT			
Clause	Requirement + Test	Result - Remark	Verdict
	In the third dashed item, add the following: However, the coating of the protective earth conductor inside covered with sheath (cord set) power cord integrally formed with the connector and the plug need not be a combination of green and yellow. In addition, the power cord of CLASS 0I EQUIPMENT having a protective earth conductor separately, it is not necessary to provide a protective earth conductor.	Added.	N/A
	Replace the existing fourth dashed item with the following: - if those complying with JIS C 3662-5 or JIS C 3663-4, have conductors with cross-sectional areas not less than those specified in Table 3B, and if others, comply with the relevant wiring rules. In Table 3B, replace "IEC 60320" with "the JIS C8283 series of standards or the IEC 60320 series of standards".	Replaced.	N/A
3.3.4	Add the following note to Table 3D: For cables other than those complying with JIS C 3662 or JIS C 3663, terminals shall be suitable for the size of the intended cables.	Added.	N/A
3.3.7	Add the following after the first sentence: This requirement is not applicable to the external earthing terminal of CLASS 0I EQUIPMENT.	Added.	N/A
4.3.4	Add the following after the first sentence: This requirement also applies to those connections in CLASS 0I EQUIPMENT, where CLEARANCE or CREEPAGE DISTANCES of BASIC INSULATION would be reduced to less than the values specified in 2.10.	Added. Class I.	N/A
4.3.5	In the paragraph, replace "IEC 60083 or IEC 60320" with "the JIS C 8283 series of standards, JIS C 8303 or JIS C 8358".	Replaced.	N/A
4.5.3	In the item b in Table 4B, add the following: NOTE If no data of material is available, Appendix 4, 1(1), ^v ,3 specified in the Interpretation for "the Ministerial Ordinance establishing Technical Requirements for Electrical Appliances and Materials MEIT Ordinance No. 85, Clause 1 (METI Ordinance No. 34 of 2013)" is applicable. In the item c in Table 4B, replace IEC 60085 with JIS C 4003.	Replaced.	P
5.1.3	Add a note after the first paragraph as follows: NOTE In Japan, three-phase power distribution systems of delta connection are typical, therefore, in such case, test is conducted using the test circuit from IEC 60990, figure 13.	Added.	P
5.1.6	Replace Table 5A as follows	Replaced.	P

IEC60950_1F - ATTACHMENT																																							
Clause	Requirement + Test	Result - Remark	Verdict																																				
	<table border="1"> <thead> <tr> <th>Type of equipment</th> <th>Terminal A of measuring instrument connected to:</th> <th>Maximum TOUCH CURRENT mA r.m.s.^a</th> <th>Maximum PROTECTIVE CONDUCTOR CURRENT</th> </tr> </thead> <tbody> <tr> <td>All equipment</td> <td>Accessible parts and circuits not connected to protective earth^b</td> <td>0,25</td> <td>–</td> </tr> <tr> <td rowspan="2">HAND-HELD</td> <td>Class I equipment main protective earthing terminal</td> <td>0,75</td> <td>–</td> </tr> <tr> <td>Class 0I equipment main protective earthing terminal</td> <td>0,5</td> <td>–</td> </tr> <tr> <td rowspan="2">MOVABLE (other than HAND-HELD, but including TRANSPORTABLE EQUIPMENT)</td> <td>Class I equipment main protective earthing terminal</td> <td>3,5</td> <td>–</td> </tr> <tr> <td>Class 0I equipment main protective earthing terminal</td> <td>1,0</td> <td>–</td> </tr> <tr> <td rowspan="2">STATIONARY, PLUGGABLE TYPE A</td> <td>Class I equipment main protective earthing terminal</td> <td>3,5</td> <td>–</td> </tr> <tr> <td>Class 0I equipment main protective earthing terminal</td> <td>1,0</td> <td>–</td> </tr> <tr> <td rowspan="2">All other STATIONARY EQUIPMENT – not subject to the conditions of 5.1.7 – subject to the conditions of 5.1.7</td> <td>Class I equipment main protective earthing terminal</td> <td>3,5 –</td> <td>– 5 % of input current</td> </tr> <tr> <td>Class 0I equipment main protective earthing terminal</td> <td>1,0 –</td> <td>– –</td> </tr> </tbody> </table> <p>^a If peak values of TOUCH CURRENT are measured, the maximum values are obtained by multiplying the r.m.s. values in the table by 1,414.</p> <p>^b Some unearthed accessible parts are covered in 1.5.6 and 1.5.7 and the requirements of 2.4 apply. These may be different from those in 5.1.6.</p>	Type of equipment	Terminal A of measuring instrument connected to:	Maximum TOUCH CURRENT mA r.m.s. ^a	Maximum PROTECTIVE CONDUCTOR CURRENT	All equipment	Accessible parts and circuits not connected to protective earth ^b	0,25	–	HAND-HELD	Class I equipment main protective earthing terminal	0,75	–	Class 0I equipment main protective earthing terminal	0,5	–	MOVABLE (other than HAND-HELD, but including TRANSPORTABLE EQUIPMENT)	Class I equipment main protective earthing terminal	3,5	–	Class 0I equipment main protective earthing terminal	1,0	–	STATIONARY, PLUGGABLE TYPE A	Class I equipment main protective earthing terminal	3,5	–	Class 0I equipment main protective earthing terminal	1,0	–	All other STATIONARY EQUIPMENT – not subject to the conditions of 5.1.7 – subject to the conditions of 5.1.7	Class I equipment main protective earthing terminal	3,5 –	– 5 % of input current	Class 0I equipment main protective earthing terminal	1,0 –	– –		
Type of equipment	Terminal A of measuring instrument connected to:	Maximum TOUCH CURRENT mA r.m.s. ^a	Maximum PROTECTIVE CONDUCTOR CURRENT																																				
All equipment	Accessible parts and circuits not connected to protective earth ^b	0,25	–																																				
HAND-HELD	Class I equipment main protective earthing terminal	0,75	–																																				
	Class 0I equipment main protective earthing terminal	0,5	–																																				
MOVABLE (other than HAND-HELD, but including TRANSPORTABLE EQUIPMENT)	Class I equipment main protective earthing terminal	3,5	–																																				
	Class 0I equipment main protective earthing terminal	1,0	–																																				
STATIONARY, PLUGGABLE TYPE A	Class I equipment main protective earthing terminal	3,5	–																																				
	Class 0I equipment main protective earthing terminal	1,0	–																																				
All other STATIONARY EQUIPMENT – not subject to the conditions of 5.1.7 – subject to the conditions of 5.1.7	Class I equipment main protective earthing terminal	3,5 –	– 5 % of input current																																				
	Class 0I equipment main protective earthing terminal	1,0 –	– –																																				
6	Add following in the end of NOTE 1: For suitable additional measures, see Annex JB.	No TNV.	N/A																																				
6.1.2.1	Add the following: NOTE 3 For example, the highest nominal voltage is 230 V in Europe and 120 V in North America.	No TNV.	N/A																																				
Annex G.6	Replace the existing 8 th paragraph with the following: The above minimum CLEARANCES for connectors do not apply to: - connectors that comply with JIS C 8285, the IEC 60309 series of standards, the JIS C 8283 series of standards, the IEC 60320 series of standards or JIS C 8303; and - connectors that with the Ministerial Ordinance establishing Technical Requirements for Electrical Appliances and Materials (MEIT Ordinance No. 34 of 2013) and comply with the dimensions specified in the JIS C 8283 series of standards, JIS C 8303 or IEC 60309-2; see also 1.5.2.	Replaced.	N/A																																				

IEC60950_1F - ATTACHMENT			
Clause	Requirement + Test	Result - Remark	Verdict
Annex M	In M.1, replace the existing paragraph with the following: One of the two methods specified in this annex shall be applied. NOTE Method A specified in the annex is typical of analogue telephone network in Europe and Method B of those in North America.	No telephone ringing signals.	N/A
Annex P	Replace the existing Annex P with the following:	Replaced.	P
	<p style="text-align: center;">Annex P (normative)</p> <p style="text-align: center;">Normative references</p> <p>The following reference documents are indispensable for the application of this standard. If the date of the reference document is given, only that edition applies, and any newer edition and subsequent amendments do not apply. If the date of the reference document is not given, the latest edition including the amendments applies.</p> <p>Further information on the reference documents, including how to obtain copies, can be found on the following internet sites:</p> <p style="text-align: center;"> http://www.jisc.go.jp/ http://www.iec.ch http://www.iso.org http://www.itu.int </p> <p>JIS B 0205-2, ISO general purpose metric screw threads - Part2: General plan NOTE Corresponding IS: ISO 261, ISO general purpose metric screw threads—General plan (IDT)</p> <p>JIS B 0205-3, ISO general purpose metric screw threads - Part3 : Selected sizes for screws, bolts and nuts NOTE Corresponding IS: ISO 262, ISO general purpose metric screw threads - Selected sizes for screws, bolts and nuts (IDT)</p> <p>JIS C 0448, Coding of indicating devices and actuators by colours and supplementary means NOTE Corresponding IS: IEC 60073, Basic and safety principles for man-machine interface, marking and identification - Coding principles for indicator devices and actuators (IDT)</p> <p>JIS C 2134, Method for the determination of the proof and the comparative tracking indices of solid insulating materials NOTE Corresponding IS: IEC 60112, Method for the determination of the proof and the comparative tracking indices of insulating materials (IDT)</p> <p>JIS C 3215 (all parts), Specifications for particular types of winding wires NOTE Corresponding IS: IEC 60317 (all parts), Specifications for particular types of winding wires (IDT)</p> <p>JIS C 3661-1:1998, Electrical test methods for electric cables - Part 1: Electrical tests for cables, cords and wires for voltages up to and including 450/750V NOTE Corresponding IS: IEC 60885-1:1987, Electrical test methods for electric cables. Part 1: Electrical tests for cables, cords and wires for voltages up to and including 450/750 V (IDT)</p> <p>JIS C 3662 (all parts), Polyvinyl chloride insulated cables of rated voltages up to and including 450/750V - Part 1 : General requirements NOTE Corresponding IS: IEC 60227 (all parts), Polyvinyl chloride insulated cables of rated voltages up to and including 450/750 V (MOD)</p> <p>JIS C 3663 (all parts), Rubber insulated cables - Rated voltages up to and including 450/750 V NOTE Corresponding IS: IEC 60245 (all parts), Rubber insulated cables - Rated voltages up to and including 450/750 V (MOD)</p> <p>JIS C 4003, Electrical insulation-Thermal evaluation and designation NOTE Corresponding IS: IEC 60085:2004, Electrical insulation - Thermal classification (MOD)</p> <p>JIS C 4526-1:2005, Switches for appliances - Part 1: General requirements NOTE Corresponding IS: IEC 61058-1:2000, Switches for appliances - Part 1: General requirements (MOD)</p> <p>JIS C 5101-14:2009, Fixed capacitors for use in electronic equipment - Part 14: Sectional specification: Fixed capacitors for electromagnetic interference suppression and connection to the supply mains NOTE Corresponding IS: IEC 60384-14:2005, Fixed capacitors for use in electronic equipment - Part 14: Sectional specification: Fixed capacitors for electromagnetic interference suppression and connection to the supply mains (IDT)</p> <p>JIS C 6065:2007 and Amendment 1:2009, Audio, video and similar electronic apparatus - Safety requirements NOTE Corresponding IS: IEC 60065:2001, Audio, video and similar electronic apparatus - Safety requirements and Amendment 1:2005 (MOD)</p> <p>JIS C 6802, Safety of laser products NOTE Corresponding IS: IEC 60825-1, Safety of laser products-Part 1: Equipment classification and requirements (IDT)</p> <p>JIS C 6803, Safety of laser products-Safety of optical fiber communication systems NOTE Corresponding IS: IEC 60825-2, Safety of laser products-Part 2: Safety of optical fiber communication systems (OFCS) (IDT)</p>		

IEC60950_1F - ATTACHMENT			
Clause	Requirement + Test	Result - Remark	Verdict
	<p>JIS C 6804, Safety of laser products-Safety of free space optical communication systems used for transmission of information NOTE Corresponding IS: IEC 60825-12, Safety of laser products - Part 12: Safety of free space optical communication systems used for transmission of information (IDT)</p> <p>JIS C 8201-1:2007, Low-voltage switchgear and controlgear-Part 1: General rules NOTE Corresponding IS: IEC 60947-1:2004, Low-voltage switchgear and controlgear - Part 1: General rules (MOD)</p> <p>JIS C 8283 (all parts), Appliance couplers for household and similar general purposes NOTE Corresponding IS: IEC 60320 (all parts), Appliances couplers for household and similar general purposes (MOD)</p> <p>JIS C 8285, Plugs, socket-outlets and couplers for industrial purposes NOTE Corresponding IS: IEC 60309-1, Plugs, socket-outlets and couplers for industrial purposes - Part 1: General requirements (MOD)</p> <p>JIS C 8303, Plugs and receptacles for domestic and similar general use</p> <p>JIS C 8358:1994, Appliance couplers for domestic and similar use</p> <p>JIS C 9730-1:2010, Automatic electrical controls for household and similar use - Part 1:General requirements NOTE Corresponding IS: IEC 60730-1:1999, Automatic electrical controls for household and similar use - Part 1: General requirements and Amendment 1:2003 (MOD)</p> <p>JIS C 60068-2-78, Environmental testing - Test Cab:Damp heat,steady state NOTE Corresponding IS: IEC 60068-2-78, Environmental testing - Part 2-78: Tests - Test Cab: Damp heat, steady state (IDT)</p> <p>JIS C 60364-1:2006, Low-voltage electrical installations - Part 1: Fundamental principles, assessment of general characteristics, definitions NOTE Corresponding IS: IEC 60364-1:2001, Electrical installations of buildings - Part 1: Fundamental principles, assessment of general characteristics, definitions (IDT)</p> <p>JIS C 60664-1:2009, Insulation coordination for equipment within low-voltage systems - Part 1:Principles,requirements and tests NOTE Corresponding IS: IEC 60664-1:1992, Insulation coordination for equipment within low-voltage systems - Part 1: Principles, requirements and tests, Amendment 1:2000 and Amendment 2:2002 (IDT)</p> <p>JIS C 60695-2-11, Fire hazard testing - Glow-wire flammability test method for end-products NOTE Corresponding IS: IEC 60695-2-11, Fire hazard testing - Part 2-11: Glowing/hot-wire based test methods - Glow-wire flammability test method for end-products (IDT)</p> <p>JIS C 60695-2-20, Fire hazard testing—Part 2 : Glowing /Hot wire based test methods—Section 20 : Hot-wire coil ignitability test on materials NOTE Corresponding IS: IEC/TS 60695-2-20, Fire hazard testing - Part 2-20: Glowing/hot wire based test methods - Hot-wire coil ignitability - Apparatus test method and guidance (IDT)</p> <p>JIS C 60695-10-2, Fire hazard testing-Part 10-2: Abnormal heat-Ball pressure test NOTE Corresponding IS: IEC 60695-10-2, Fire hazard testing - Part 10-2: Abnormal heat - Ball pressure test (IDT)</p> <p>JIS C 60695-11-5:2007, Fire hazard testing-Part 11-5:Test flames-Needle-flame test method - Apparatus, confirmatory test arrangement and guidance NOTE Corresponding IS: IEC 60695-11-5:2004, Fire hazard testing - Part 11-5: Test flames - Needle-flame test method - Apparatus, confirmatory test arrangement and guidance (IDT)</p> <p>JIS C 60695-11-10, Fire hazard testing-Part 11-10:Test flames - 50 W horizontal and vertical flame test methods NOTE Corresponding IS: IEC 60695-11-10, Fire hazard testing - Part 11-10: Test flames - 50 W horizontal and vertical flame test methods (IDT)</p> <p>JIS C 60695-11-20, Fire hazard testing-Part 11-20: Test flames - 500 W flame test methods NOTE Corresponding IS: IEC 60695-11-20, Fire hazard testing - Part 11-20: Test flames - 500 W flame test methods (IDT)</p> <p>JIS C 7550:2011, Safety for lighting of lamp and lamp system on biology</p> <p>JIS C 60695-10-3:2005, Fire resistance test – Electrical . Electronic – Part 10-3 : Thermal caused abnormal – Deformation test of molded stress after released NOTE Corresponding IS: IEC 60695-10-3:2002, Fire hazard testing – Part 10-3 : Abnormal heat – Mould stress relief distortion test (IDT)</p> <p>JIS K 7110, Plastics - Determinaion of Izod impact strength NOTE Corresponding IS: ISO 180, Plastics - Determination of Izod impact strength (MOD)</p> <p>JIS K 7111 (all parts), Plastics-Determination of Charpy impact properties - Part 1: Non-instrumented impact test NOTE Corresponding IS: ISO 179 (all parts), Plastics - Determination of Charpy impact properties (MOD)</p> <p>JIS K 7127, Plastics - Determination of tensile properties—Part 3 : Test conditions for films and sheets NOTE Corresponding IS: ISO 527-3, Plastics - Determination of tensile properties - Part 3: Test conditions for films and sheets (IDT)</p> <p>JIS K 7160, Plastics—Determination of tensile-impact strength NOTE Corresponding IS: ISO 8256, Plastics - Determination of tensile-impact strength (IDT)</p> <p>JIS K 7161, Plastics—Determination of tensile properties—Part 1 : General principles NOTE Corresponding IS: ISO 527-1, Plastics - Determination of tensile properties - Part 1: General principles (IDT)</p> <p>JIS K 7162, Plastics - Determination of tensile properties - Part 2 : Test conditions for moulding and extrusion plastics NOTE Corresponding IS: ISO 527-2, Plastics - Determination of tensile properties - Part 2: Test conditions for moulding and extrusion plastics (IDT)</p> <p>JIS K 7164, Plastics - Determination of tensile properties - Test conditions for isotropic and orthotropic fibre-</p>		

IEC60950_1F - ATTACHMENT			
Clause	Requirement + Test	Result - Remark	Verdict
	<p>reinforced plastic composites NOTE Corresponding IS: ISO 527-4, Plastics - Determination of tensile properties - Part 4: Test conditions for isotropic and orthotropic fibre-reinforced plastic composites (MOD) JIS K 7165, Plastics-Determination of tensile properties-Part 5: Test conditions for unidirectional fibre-reinforced plastic composites NOTE Corresponding IS: ISO 527-5, Plastics - Determination of tensile properties - Part 5: Test conditions for unidirectional fibre-reinforced plastic composites (MOD) JIS K 7171, Plastics - Determination of flexural properties NOTE Corresponding IS: ISO 178, Plastics - Determination of flexural properties (IDT) JIS K 7241, Cellular plastics-Determination of horizontal burning characteristics of small specimens subjected to a small flame NOTE Corresponding IS: ISO 9772, Cellular plastics - Determination of horizontal burning characteristics of small specimens subjected to a small flame (IDT) JIS K 7341, Plastics-Determination of burning behaviour of thin flexible vertical specimens in contact with a small-flame ignition source NOTE Corresponding IS: ISO 9773, Plastics - Determination of burning behaviour of thin flexible vertical specimens in contact with a small-flame ignition source (IDT) JIS K 7350-1, Plastics - Methods of exposure to laboratory light sources - Part 1: General guidance NOTE Corresponding IS: ISO 4892-1, Plastics - Methods of exposure to laboratory light sources - Part 1: General guidance (IDT) JIS K 7350-2, Plastics - Methods of exposure to laboratory light sources - Part 2 : Xenon-arc lamps NOTE Corresponding IS: ISO 4892-2, Plastics - Methods of exposure to laboratory light sources - Part 2: Xenon-arc lamps (MOD) JIS K 7350-4, Plastics - Methods of exposure to laboratory light sources - Part 4: Open-flame carbon-arc lamps NOTE Corresponding IS: ISO 4892-4, Plastics - Methods of exposure to laboratory light sources - Part 4: Open-flame carbon-arc lamps (MOD) JIS S 0101:2000, Graphical warning symbols for consumers TS C 60695-11-3, Fire hazard testing - Part 11-3: Test flames - 500 W flames - Apparatus and confirmational test methods NOTE Corresponding IS: IEC 60695-11-3, Fire hazard testing - Part 11-3: Test flames - 500 W flames - Apparatus and confirmational test methods (IDT) TS C 60695-11-4, Fire hazard testing - Part 11-4: Test flames - 50 W flames - Apparatus and confirmational test methods NOTE Corresponding IS: IEC 60695-11-4, Fire hazard testing - Part 11-4: Test flames - 50 W flames - Apparatus and confirmational test methods (IDT) IEC 60216-4-1, Electrical insulating materials - Thermal endurance properties - Part 4-1: Ageing ovens - Single-chamber ovens IEC 60309 (all parts), Plugs, socket-outlets and couplers for industrial purposes IEC 60317 (all parts), Specifications for particular types of winding wires IEC 60317-43, Specifications for particular types of winding wires - Part 43: Aromatic polyimide tape wrapped round copper wire, class 240 IEC 60320 (all parts), Appliance couplers for household and similar general purposes IEC 60417-DB:2002, Graphical symbols for use on equipment (For DB, see the online database of the IEC.) IEC 60747-5-5, Semiconductor devices - Discrete devices - Part 5-5: Optoelectronic devices – Photocouplers IEC/TR 60825-9, Safety of laser products - Part 9: Compilation of maximum permissible exposure to incoherent optical radiation IEC 60851-3:1996, Winding wires - Test methods - Part 3: Mechanical properties and Amendment 1:1997 IEC 60851-5:1996, Winding wires - Test methods - Part 5: Electrical properties, Amendment 1:1997 and Amendment 2:2004 IEC 60851-6:1996, Methods of test for winding wires - Part 6: Thermal properties IEC 60947-1:2004, Low-voltage switchgear and controlgear - Part 1: General rules IEC 60990:1999, Methods of measurement of touch current and protective conductor current IEC 61051-2, Varistors for use in electronic equipment - Part 2: Sectional specification for surge suppression varistors ISO 180, Plastics - Determination of Izod impact strength ISO 3864-2: Graphical symbols – Safety colours and safety signs – Part 2: principles for product safety labels. ISO 4892-1, Plastics - Methods of exposure to laboratory light sources - Part 1: General guidance ISO 7000-DB:2004, Graphical symbols for use on equipment - Index and synopsis (For DB, see the online database of the IEC.) ISO 8256, Plastics - Determination of tensile-impact strength ITU-T Recommendation K.44, Resistibility tests for telecommunication equipment exposed to overvoltages and overcurrents - Basic Recommendation</p>		

IEC60950_1F - ATTACHMENT			
Clause	Requirement + Test	Result - Remark	Verdict
Annex U.2.4	Replace the existing NOTE as NOTE1, add NOTE 2 as follows: NOTE 2 by taking into account environmental impact, "(for example, 1.1.1-trichloroethane)" described in the corresponding IEC standard was deleted.	Replaced.	P
Annex V.1	Replace "In 3.1.2 of IEC 60364-1" with "312 of JIS C 60364-1".	Replaced.	P
Annex W.1	Replace second and third sentence in the first paragraph with the following: This distinction between earthed and unearthed (floating) circuit is not the same as between CLASS I EQUIPMENT, CLASS 0I EQUIPMENT and CLASS II EQUIPMENT. Floating circuits can exist in CLASS I EQUIPMENT or CLASS 0I EQUIPMENT and earthed circuits in CLASS II EQUIPMENT.	Replaced.	N/A
Annex AA	Replace figure AA.3 which correct the position of insulating metal sheet.	Replaced.	N/A
Annex BB	(Reference) [Change point which from IEC 60950-1 : 2001 (v1) to IEC 60950-1 : 2005 (v2)] (Deleted text body)		—
Annex CC	Evaluation of integrated circuit (IC) current limiters		N/A
CC.2	Test program 1		N/A
	10 000 cycles of turning enable on and off with an iron-core inductor having (0.35 ± 0.1) mH inductance at 1 kHz and less than 1 Ω DC resistance value connected in the output circuit;		N/A
	10 000 cycles of turning enable on and off with the input connected to a capacitor rated $425 \mu\text{F} \pm 10 \mu\text{F}$ and shorting the output;		N/A
	10 000 cycles of turning the input pin on and off with an iron-core inductor having (0.35 ± 0.1) mH inductance at 1 kHz and less than 1 Ω DC resistance value connected to the input supply and return while keeping enable active and shorting the output;		N/A
CC.3	Test program 2		N/A
	Note: It's advisable to use that in conformity with IEC 60127-2 for quick-fusing type fuse.		N/A
Annex EE	Household and home/office document/media shredders		N/A
	Note: Delete requirements of this Annex which corresponding IS and replace this Annex by Annex JA.		N/A
	Foreword of Annex JA (Requirements for shredder) was replaced by following: It shall conformity with requirements of this Annex for that add to body with Household and home/office document /media shredders.		N/A

IEC60950_1F - ATTACHMENT			
Clause	Requirement + Test	Result - Remark	Verdict
Annex JA	<p>Add a new annex JA with the following contents.</p> <p style="text-align: center;">Annex JA (normative)</p> <p>Requirements for document shredding machines (see 1.7, 2.8.3, 3.4 and 4.4)</p> <p>Introduction</p> <p>This annex specifies the safety requirements for document shredding machines, except those of STATIONARY EQUIPMENT used by connecting directly to 3-phase AC MAINS SUPPLY of a voltage not the than 200V.</p> <p>Document shredding machines shall comply with the requirements of this annex in addition to other requirements specified in this standard, except those of STATIONARY EQUIPMENT used by connecting directly to three-phase AC MAINS SUPPLY of a voltage not less than 200V.</p>	Not document shredding machine.	N/A
JA.1	<p>Markings and instructions</p> <p>In the easily visible part near to the slot for documents, by a method of clearly legible and permanent and by using easily understandable terms, document shredding machines shall have markings of the symbol  specified in 6.2.1 (general cautions) of JIS S 0101:2000, Graphical warning symbols for consumers, and also the following precautions for use:</p> <ul style="list-style-type: none"> - that use by an infants/children may cause a hazard of injury etc.; - that a hand can be drawn into the mechanical section for shredding when touching the document-slot; - that clothing can be drawn into the mechanical section for shredding when touching the document-slot; - that hairs can be drawn into the mechanical section for shredding when touching the document-slot; - in case of equipment incorporating a commutator motor, that equipment may catch fire or explode by spraying of flammable gas. 		N/A
JA.2	<p>Inadvertent reactivation</p> <p>Any safety interlock that can be operated by means of the test finger, Figure JA.1, is considered to be likely to cause inadvertent reactivation of the hazard.</p> <p>Compliance is checked by inspection and, where necessary, by a test with the test finger, Figure JA.1</p>		N/A

IEC60950_1F - ATTACHMENT			
Clause	Requirement + Test	Result - Remark	Verdict
JA.3	<p>Disconnect switch</p> <p>Document shredding machines shall incorporate an isolating switch complying with sub-clause 3.4.2 as the device disconnecting the power of hazardous moving parts. For this switch, two-position (single-use) switch or multi-position (multifunction) switch (e.g., slide switch) may be used.</p> <p>If two-position switch, the positions for "ON" and "OFF" shall be indicated in accordance with sub-clause 1.7.8. If multi-position switch, the position for "OFF" shall be indicated in accordance with sub-clause 1.7.8 and other positions shall be indicated with proper terms or symbols.</p> <p>Compliance is checked by inspection.</p>		N/A
JA.4	<p>Protection in operator access area</p> <p>Any warning shall not be used instead of the structure for preventing access to hazardous moving parts.</p> <p>Document shredding machines shall comply with the following requirements.</p> <p>Insert the test finger, Figure JA.1, into all openings in MECHANICAL ENCLOSURES without applying appreciable force. It shall not be possible to touch hazardous moving parts with the test finger. This consideration applies to all sides of MECHANICAL ENCLOSURES when the equipment is mounted as intended. Before testing with the test finger, remove the parts detachable without a tool.</p> <p>Insert the wedge-probe, Figure JA.2, into the document-slot. And, against all directions of openings, if straight-cutting type, a force of 45 N shall apply to the probe, and 90 N if cross-cutting type. In this case, the weight of the probe is to be factored into the overall applied force. Before testing with the wedge-probe, remove the parts detachable without a tool. It shall not be possible to touch any hazardous moving parts, including the shredding roller or the mechanical section for shredding, with the probe.</p>		N/A

IEC60950_1F - ATTACHMENT			
Clause	Requirement + Test	Result - Remark	Verdict

Dimensions in millimeters

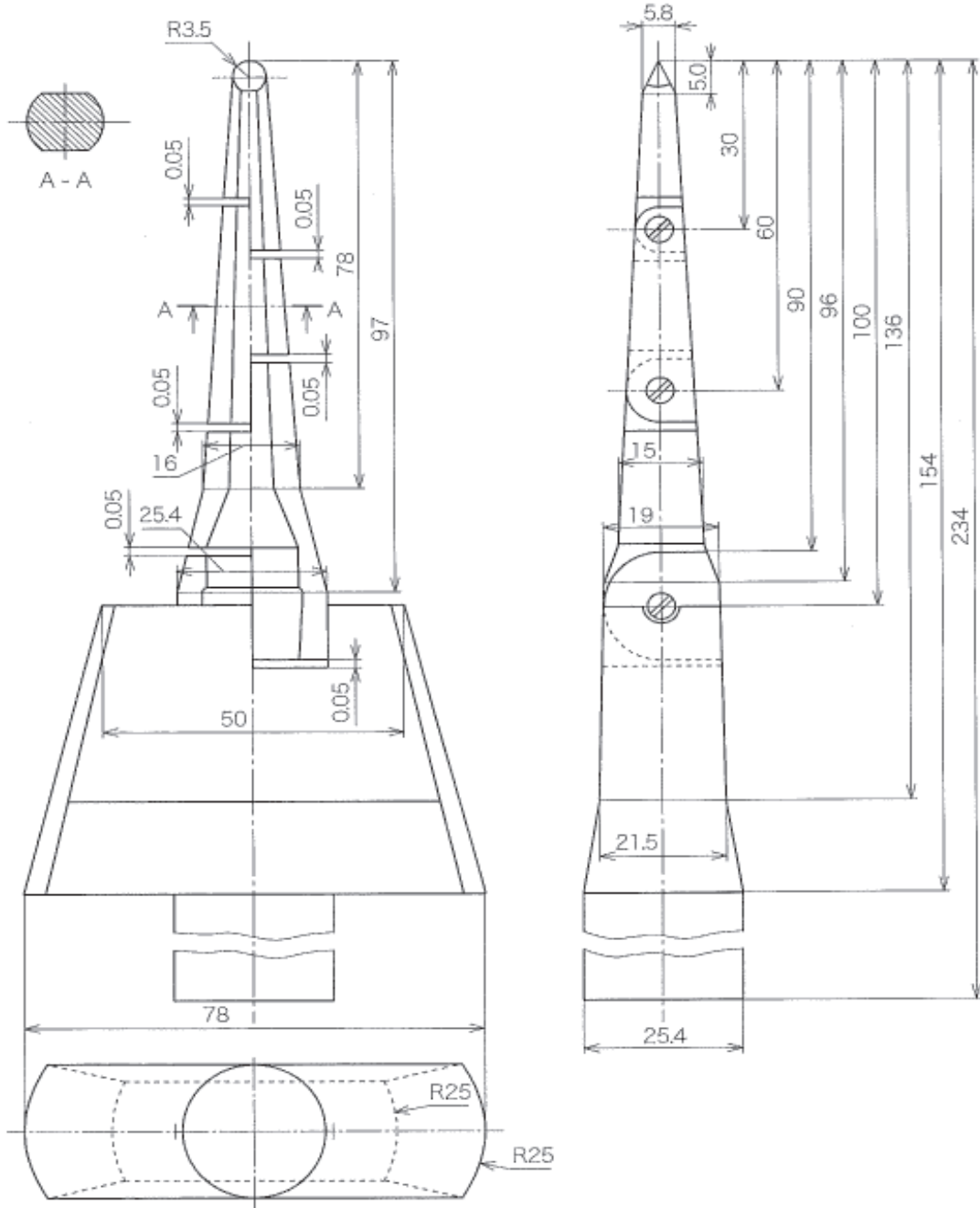
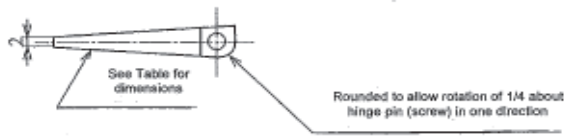
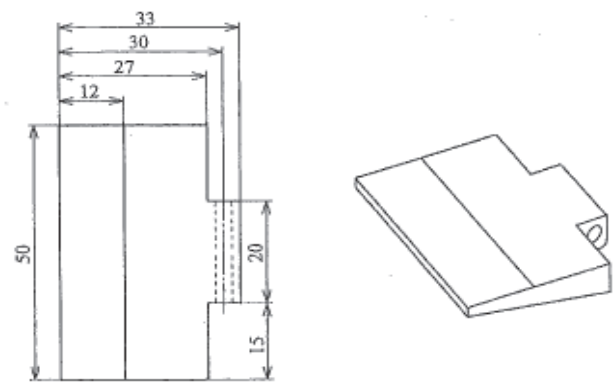
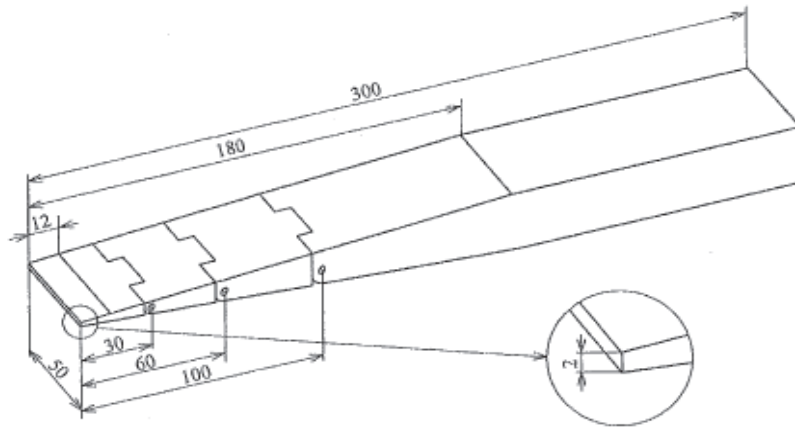

Figure JA.1 Test finger

IEC60950_1F - ATTACHMENT			
Clause	Requirement + Test	Result - Remark	Verdict



Details of the tip of wedge

Dimensions in millimeters

Distance from the tip	Thickness of probe
0	2
12	4
180	24

The thickness of the probe varies linearly, except changing the slope at the respective points shown in the table. The allowable dimensional tolerance of the probe shall be +/- 0,127 mm.

Figure JA.2 Wedge-probe.

IEC60950_1F - ATTACHMENT			
Clause	Requirement + Test	Result - Remark	Verdict
Annex JB	<p>Add Annex JB as follows:</p> <p style="text-align: center;">Annex JB (informative)</p> <p>Current conditions Installation environment on overvoltages and overcurrents, and the measures (see NOTE 1 in Clause 6)</p> <p>Introduction This standard is based on “ITU-T Recommendation K.11:1993” to stipulate requirement for equipment on a premise to install in the environment where appropriate measures were taken for so that overvoltage more than peak 1.5kV does not hang to the apparatus. But in Japan due to environment is difficult to integrate with “ITU-T Recommendation K.11:1993”, in here explain for desirable environment and show actions to be taken how to make a desirable setting environment.</p>	Added.	N/A
JB.1	<p>A desirable setting environment</p> <p>When lead electric wires in building for any kind service of metal wire, for overvoltage restraint and overcurrent restraint, it is desirable that be close to each other including grounding conductor. It is important to make it close each other especially the lead in point of power line, communication line and grounding conductor. In that case, attention is necessary for electromagnetic induction where occurred between a communication line and the power line which are not covered. It is desirable that set up main grounding terminal which close to lead in point of power line and communication line in building as much as possible. Due to minimize the surge current in building for all shielding conductor of cable which lead in building, it shall connected directly with main grounding terminal in lead in point via surge protection device (SPD) e.g. arrester and so on. It shall be considered corrosion measures in joint if necessary.</p> <p>It is desirable that SPD which set on communication line is close to lead in point toward the building as much as possible. Furthermore set the SPD near the main power line, and it may make the distance from SPD to a grounding conductor as short as possible. It is effective if use a short grounding conductor with low impedance for that decrease surge voltage between electric power system protection conductor and the communication line.</p>		N/A

IEC60950_1F - ATTACHMENT			
Clause	Requirement + Test	Result - Remark	Verdict
	Desirable setting environment for TT electric power system is as figure JB.1. Established SPD as that excessive potential difference does not occur between communication side and the electricity side, and recommend that ground wire of both are connected with a short conductor. Concerning the detail for recommend setting environment, see ITU-T Recommendation K.11:1993, K.21:1996, K.27:1996, K.31:1993 and K.66:2004.		N/A

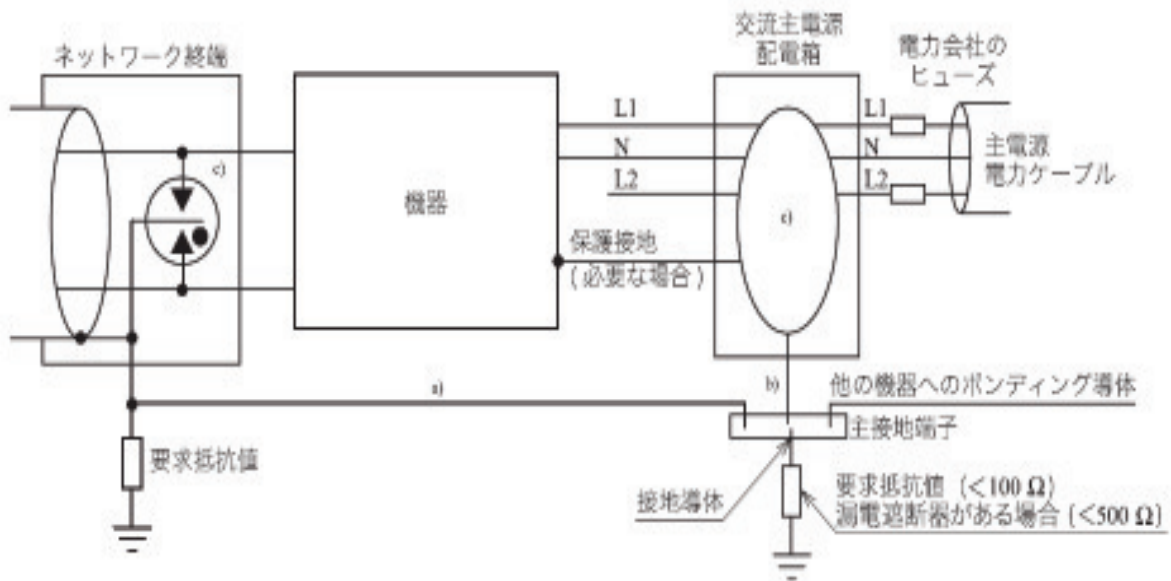

Note:

- a) All bonding line to a main grounding terminal makes it as short as possible (Less than 1.5m in the place that danger of direct lightning is high).
- b) The connected line which from SPD to main grounding terminal is as short as possible (less 1.5m).
- c) Setting for SPD (omitted the detail). All SPD connected line is short as possible (less 0.5m).

Figure JB.1 – Sample of desirable setting for TT electric power system of single phase three-wire type + neutral line
(From **ITU-T Recommendation K.66:2004**)

IEC60950_1F - ATTACHMENT			
Clause	Requirement + Test	Result - Remark	Verdict
JB.2	<p>Situation and countermeasure of setting environment for overvoltage and overcurrent</p> <p>In Japan, TT type often adopted for electric power system. Typical example is as figure JB.2. For this TT type, on condition that it shall be an electric power system which does not wired with grounding conductor except neutral line, and it shall be connected with grounding terminal which have an electrically independent different from this grounding terminal of neutral line by user for equipment which need to connect with ground.</p>		N/A

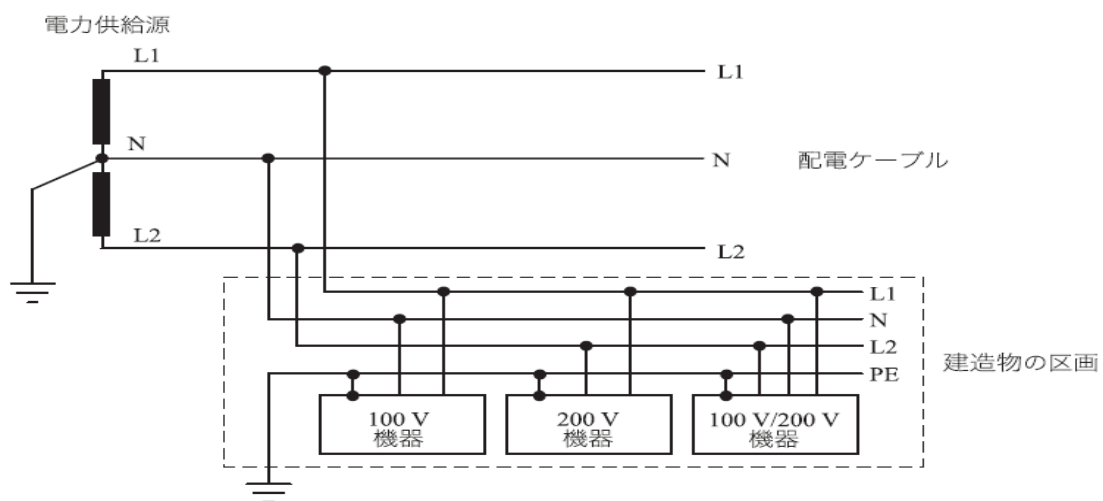

Grounded electric wire and grounded equipment in particularly

Figure JB.2 – Example of three-wire type TT electric power system

IEC60950_1F - ATTACHMENT			
Clause	Requirement + Test	Result - Remark	Verdict

	<p>But as thing are stand, there are a lot of cases that an outlet is not prepared with the grounding terminal which is appropriate in the setting place of the equipment. On the other hand, grounding resistance value of SPD where set at lead-in point of communication line sometime is not enough low, it make that dielectric breakdown was occurred due to the voltage that a thunder surge current evoked for grounding resistance which flow into the communication line and drift to the ground through SPD. The same result is expected that grounding resistance value is not enough low too if set SPD on electric power system. This status is as figure JB.3.</p> <p>As figure JB.1, it can decrease effectively by connecting both with the conductor of the low resistance value when excessive potential difference occurred in internal equipment.</p>		N/A
--	--	--	-----

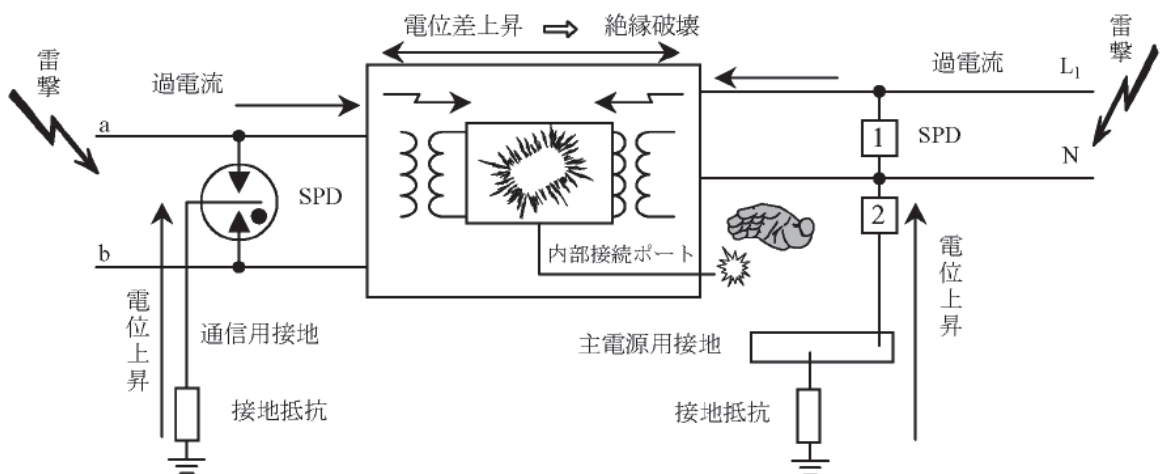

Figure JB.3 - Insufficient grounding and setting environment of bonding
(From ITU-T Recommendation K.66:2004)

	<p>It is desirable that provide the information for set environment which appropriate measures were given based on ITU-T Recommendation K.11:1993 when perform design and sale network connected equipment.</p>		N/A
--	--	--	-----

IEC60950_1F - ATTACHMENT			
Clause	Requirement + Test	Result - Remark	Verdict
Appendix	Appendix 12, J3000(H25) Special National conditions, National deviation and other information according to MITI Ordinance No. 85.		—
1	General requirement When equipment provides with appliance inlet complying with JIS C 8283-1(2008), soldered parts of appliance inlet is not applied by force during insert or removal of connector. This is not applied when inlet body is fixed itself and not fixed by solder.	Inlet is fixed by adequate mechanical construction, not rely on soldering only.	P
2	Requirement for equipment		—
2.1	Heater Appliances When diode is used in parallel for adjustment of power, the equipment shall remain safe for operation under open condition of one diode.	Not electric stove.	N/A
	The current rating of one diode shall be more than main current. The diodes connected in parallel are same type.		N/A
	The heating test specified by clause 11 of JIS C 9335-2-30(2006) under open condition of one diode shall comply with the requirements.		N/A
2.2	Electric heater with glowing heating elements	Not electric stove.	N/A
	Surface treatment by paint or adhesive on protective frame or protective mesh shall not be used.		N/A
	Caution marking like below shall be on - easily visible place of the equipment or - Instruction manual 「注意 当該機器から、使用初期段階で揮発性有機化合物及びカルボニル化合物が最も放散するおそれがあるため、その際には十分換気を行うこと。」		N/A
3	Components used in equipment	No such equipment /components.	N/A

IEC60950_1F - ATTACHMENT			
Clause	Requirement + Test	Result - Remark	Verdict
3.1	Motor capacitors used in ventilating fan, electric fan, air conditioner, electric washing machine, refrigerator or electric freezer shall be comply with <ul style="list-style-type: none"> - capacitors with protective elements or protective mechanism complying with JIS C 4908(2007) - P2 capacitor complying with IEC 60252-1(2001) Capacitor complying with below is acceptable		N/A
	Enclosed by metal or ceramic		N/A
	No non-metallic materials within 50 mm from capacitor surface		N/A
	Non-metallic material within 50 mm from capacitor surface comply with needle frame test of JIS C 9335-1(2003), Annex E		N/A
	Non-metallic material within 50 mm from capacitor surface comply with V-1 test of JIS C 60965-11-10(2006).		N/A
3.2	Plug directly inserted to outlet used refrigerator or electric freezer. Shall comply with <ul style="list-style-type: none"> - Face contact with outlet shall have CTI with more than 400 according to JIS C 2134(2007) or - Supporting material of blades shall comply with glow wire test by temperature of 750°C according to JIS C 60695-2-11(2004) or JIS C 60695-2-12(2004). Materials having glow wire frame temperature of 775 °C are acceptable.		N/A

National Differences			
Clause	Requirement - Test	Result - Remark	Verdict

APPENDIX ZZ
VARIATIONS TO IEC 60950-1, ED. 2.2 (2013) FOR
AUSTRALIA AND NEW ZEALAND

Differences according to.....: AS/NZS 60950.1:2015

ZZ1 INTRODUCTION

This Appendix sets out variations and additional requirements to cover issues which have not been addressed by the International Standard. These variations indicate national variations for purposes of the IECEE CB System and will be published in the IECEE CB Bulletin.

ZZ2 VARIATIONS

The following variations apply to the source text.

1.2	After definition 'PERSON, SERVICE' , insert the following new definition: POTENTIAL IGNITION SOURCE..... 1.2.12.201	Added.	P
1.2.12.201	After Clause 1.2.12.15, insert the following new clause: 1.2.12.201 POTENTIAL IGNITION SOURCE Possible fault which can start a fire if the open-circuit voltage measured across an interruption or faulty contact exceeds a value of 50 V (peak) a.c. or d.c. and the product of the peak value of this voltage and the measured r.m.s. current under normal operating conditions exceeds 15 VA. Such a faulty contact or interruption in an electrical connection includes those which may occur in CONDUCTIVE PATTERNS on PRINTED BOARDS. NOTE 1 An electronic protection circuit may be used to prevent such a fault from becoming a POTENTIAL IGNITION SOURCE. NOTE 2 This definition is from AS/NZS 60065:2012, Clause 2.8.11.	Added.	P
1.5.1	<ol style="list-style-type: none"> 1. First paragraph, insert the following text after the words 'IEC component standard': 'or the relevant Australian/New Zealand Standard.' 2. In the NOTE, insert the following text after the word 'standard': 'or an Australian/New Zealand Standard' 3. Second paragraph, delete the words 'without further evaluation'. 	<p>Added.</p> <p>Added.</p> <p>Deleted.</p>	P

National Differences																				
Clause	Requirement - Test	Result - Remark	Verdict																	
1.5.2	<ol style="list-style-type: none"> 1. First paragraph, insert the following text after the word 'standard': 'or an Australian/New Zealand Standard.' 2. First paragraph, second dash item, second line, insert the following text after the word 'standard': 'or an Australian/New Zealand Standard.' 3. First paragraph, second dash item, last line, insert the following text after the word 'standard': 'or an Australian/New Zealand Standard.' 	Added.	P																	
1.7.1.3	<p>Delete existing text and replace with the following: Graphical symbols placed on the equipment as a requirement of this standard, shall be in accordance with IEC 60417 or ISO 3864-2 or ISO 7000, if available. In the absence of suitable symbols, the manufacturer may design specific graphical symbols. Symbols as required by this standard placed on the equipment shall be explained in the user manual.</p>	Replaced.	P																	
2.9.2	Second paragraph, delete the word 'designated'.	Deleted.	N/A																	
3.2.5.1 Table 3B	<p>Modify Table 3B as follows:</p> <ol style="list-style-type: none"> 1. Delete the first four rows and replace with the following: <table border="1"> <thead> <tr> <th rowspan="2">RATED CURRENT of equipment A</th> <th colspan="2">Minimum conductor sizes</th> </tr> <tr> <th>Nominal cross-sectional area mm²</th> <th>AWG or kcmil [cross-sectional area in mm²] see Note 2</th> </tr> </thead> <tbody> <tr> <td>Over 0.2 up to and including 3</td> <td>0,5 ^a</td> <td>18 [0,8]</td> </tr> <tr> <td>Over 3 up to and including 7.5</td> <td>0,75</td> <td>16 [1,3]</td> </tr> <tr> <td>Over 7.5 up to and including 10</td> <td>(0,75) ^b 1,00</td> <td>16 [1,3]</td> </tr> <tr> <td>Over 10 up to and including 16</td> <td>(1,0) ^c 1,5</td> <td>14 [2]</td> </tr> </tbody> </table> <ol style="list-style-type: none"> 2. Delete NOTE 1 and renumber existing NOTE 2 as 'NOTE'. 3. Delete Footnote ^a and replace with the following: ^a This nominal cross-sectional area is only allowed for Class II appliances if the length of the power supply cord, measured between the point where the cord, or cord guard, enters the appliance, and the entry to the plug does not exceed 2 m (0,5 mm² three-core supply flexible cords are not permitted; see AS/NZS 3191). 	RATED CURRENT of equipment A	Minimum conductor sizes		Nominal cross-sectional area mm ²	AWG or kcmil [cross-sectional area in mm ²] see Note 2	Over 0.2 up to and including 3	0,5 ^a	18 [0,8]	Over 3 up to and including 7.5	0,75	16 [1,3]	Over 7.5 up to and including 10	(0,75) ^b 1,00	16 [1,3]	Over 10 up to and including 16	(1,0) ^c 1,5	14 [2]	Modified.	N/A
RATED CURRENT of equipment A	Minimum conductor sizes																			
	Nominal cross-sectional area mm ²	AWG or kcmil [cross-sectional area in mm ²] see Note 2																		
Over 0.2 up to and including 3	0,5 ^a	18 [0,8]																		
Over 3 up to and including 7.5	0,75	16 [1,3]																		
Over 7.5 up to and including 10	(0,75) ^b 1,00	16 [1,3]																		
Over 10 up to and including 16	(1,0) ^c 1,5	14 [2]																		

National Differences			
Clause	Requirement - Test	Result - Remark	Verdict
4.1.201	<p>After Clause 4.1, insert new Clause 4.1.201 as follows:</p> <p>4.1.201 Display devices used for television purposes</p> <p>Display devices which may be used for television purposes, with a mass of 7 kg or more, shall comply with the requirements for stability and mechanical hazards, including the additional stability requirements for television receivers, specified in AS/NZS 60065.</p>	Inserted.	N/A
4.3.6	<p>Delete the third paragraph and replace with the following:</p> <p><i>Equipment with a plug portion, suitable for insertion into a 10 A 3-pin flatpin socket-outlet complying with AS/NZS 3112 shall comply with the requirements in AS/NZS 3112 for equipment with integral pins for insertion into socket-outlets.</i></p>	Deleted and replaced. Not direct plug-in type.	N/A
4.3.8	<p>Eighth paragraph, insert the following new note after the first dash item:</p> <p>NOTE 6.201 In cases where the voltage source is provided by power from an unassociated power source, consideration should be given to the effects of possible single fault conditions in the unassociated equipment. If the power source is unknown then it should be assumed that the maximum limit of SELV may be applied to the source input under assumed single fault conditions in the source when assessing the charging circuit in the equipment under test.</p>	No Batteries.	N/A
4.3.8.201	<p>After Clause 4.3.8, add the following new clause as follows:</p> <p>4.3.8.201 Products containing coin/button cell batteries and batteries designated R1</p> <p>The requirements of AS/NZS 60065:2012 Amendment 1:2015, Clause 14.10.201 apply for this Clause.</p>	No such Batteries.	N/A
4.3.13.5.1	<ol style="list-style-type: none"> Delete the first paragraph and replace with the following: Except as permitted below, equipment shall be classified and labelled according to IEC 60825-1 or AS/NZS 60825.1, IEC 60825-2 or AS/NZS 60825.2 and IEC 60825-12, as applicable. Third paragraph, first sentence, after 'IEC 60825-1', insert the following text: or AS/NZS 60825.1 Fourth paragraph, after 'IEC 60825-1', insert the following text: or AS/NZS 60825.1 	No Lasers.	N/A
4.7	<p>At the end of Clause 4.7, insert the following text: 'For alternate tests refer to Clause 4.7.201.'</p>	Added. The alternative method is not considered.	N/A

National Differences			
Clause	Requirement - Test	Result - Remark	Verdict
4.7.201	After Clause 4.7.3.6, add new Clauses as follows: 4.7.201 Resistance to fire – Alternative tests	Added. The alternative method is not considered.	N/A
4.7.201.1	<p>4.7.201.1 General</p> <p>Parts of non-metallic material shall be resistant to ignition and spread of fire.</p> <p>This requirement does not apply to decorative trims, knobs and other parts unlikely to be ignited or to propagate flames from inside the apparatus, or the following:</p> <p>(a) Components that are contained in an enclosure having a flammability category of V-0 according to AS/NZS 60695.11.10 and having openings only for the connecting wires filling the openings completely, and for ventilation not exceeding 1mm in width regardless of length.</p> <p>(b) The following parts which would contribute negligible fuel to a fire:</p> <ul style="list-style-type: none"> - small mechanical parts, the mass of which does not exceed 4g, such as mounting parts, gears, cams, belts and bearings; - small electrical components, such as capacitors with a volume not exceeding 1,750 mm³, integrated circuits, transistors and optocoupler packages, if these components are mounted on material of flammability category V-1, or better, according to AS/NZS 60695.11.10. <p>NOTE In considering how to minimize propagation of fire and what 'small parts' are, account should be taken of the cumulative effect of small parts adjacent to each other for the possible effect of propagating the fire from one part to another.</p> <p>Compliance shall be checked by the tests of 4.7.201.2, 4.7.201.3, 4.7.201.4 and 4.7.201.5.</p> <p>For the base material of printed boards, compliance shall be checked by the test of 4.7.201.5.</p> <p>The tests shall be carried out on parts of non-metallic material which have been removed from the apparatus. When the glow-wire test is carried out, the parts shall be placed in the same orientation as they would be in normal use.</p> <p>These tests are not carried out on internal wiring.</p>	Added. The alternative method is not considered.	N/A

National Differences													
Clause	Requirement - Test	Result - Remark	Verdict										
4.7.201.2	<p>4.7.201.2 Testing of non-metallic materials</p> <p>Parts of non-metallic material shall be subject to the glow-wire test of AS/NZS 60695.2.11 which shall be carried out at 550 °C.</p> <p>Parts for which the glow-wire test cannot be carried out, such as those made of soft or foamy material, shall meet the requirements specified in ISO 9772 for category FH-3 material. The glow-wire test shall be not carried out on parts of material classified at least FH-3 according to ISO 9772 provided that the sample tested was not thicker than the relevant part.</p>	Added. The alternative method is not considered.	N/A										
4.7.201.3	<p>4.7.201.3 Testing of insulating materials</p> <p>Parts of insulating material supporting POTENTIAL IGNITION SOURCES shall be subject to the glow-wire test of AS/NZS 60695.2.11 which shall be carried out at 750 °C.</p> <p>The test shall be also carried out on other parts of insulating material which are within a distance of 3 mm of the connection.</p> <p>NOTE Contacts in components such as switch contacts are considered to be connections.</p> <p>For parts which withstand the glow-wire test but produce a flame, other parts above the connection within the envelope of a vertical cylinder having a diameter of 20 mm and a height of 50 mm shall be subjected to the needle-flame test. However, parts shielded by a barrier which meets the needle-flame test shall not be tested.</p> <p>The needle-flame test shall be made in accordance with AS/NZS 60695.11.5 with the following modifications:</p> <table border="1"> <thead> <tr> <th>Clause of AS/NZS 60695.11.5</th> <th>Change</th> </tr> </thead> <tbody> <tr> <td colspan="2">9 Test procedure</td> </tr> <tr> <td>9.2 Application of needleflame</td> <td>Replace the first paragraph with: The specimen shall be arranged so that the flame can be applied to a vertical or horizontal edge as shown in the examples of figure 1. If possible the flame shall be applied at least 10 mm from a corner Replace the second paragraph with: The duration of application of the test flame shall be 30 s ±1 s.</td> </tr> <tr> <td>9.3 Number of test specimens</td> <td>Replace with: The test shall be made on one specimen. If the specimen does not withstand the test, the test may be repeated on two further specimens, both of which shall withstand the test.</td> </tr> <tr> <td>11 Evaluation of test results</td> <td>Replace with: The duration of burning (t_b) shall not exceed 30 s. However, for printed circuit boards, it shall not exceed 15 s.</td> </tr> </tbody> </table> <p>The needle-flame test shall not be carried out on</p>	Clause of AS/NZS 60695.11.5	Change	9 Test procedure		9.2 Application of needleflame	Replace the first paragraph with: The specimen shall be arranged so that the flame can be applied to a vertical or horizontal edge as shown in the examples of figure 1. If possible the flame shall be applied at least 10 mm from a corner Replace the second paragraph with: The duration of application of the test flame shall be 30 s ±1 s.	9.3 Number of test specimens	Replace with: The test shall be made on one specimen. If the specimen does not withstand the test, the test may be repeated on two further specimens, both of which shall withstand the test.	11 Evaluation of test results	Replace with: The duration of burning (t _b) shall not exceed 30 s. However, for printed circuit boards, it shall not exceed 15 s.	Added. The alternative method is not considered.	N/A
Clause of AS/NZS 60695.11.5	Change												
9 Test procedure													
9.2 Application of needleflame	Replace the first paragraph with: The specimen shall be arranged so that the flame can be applied to a vertical or horizontal edge as shown in the examples of figure 1. If possible the flame shall be applied at least 10 mm from a corner Replace the second paragraph with: The duration of application of the test flame shall be 30 s ±1 s.												
9.3 Number of test specimens	Replace with: The test shall be made on one specimen. If the specimen does not withstand the test, the test may be repeated on two further specimens, both of which shall withstand the test.												
11 Evaluation of test results	Replace with: The duration of burning (t _b) shall not exceed 30 s. However, for printed circuit boards, it shall not exceed 15 s.												

National Differences			
Clause	Requirement - Test	Result - Remark	Verdict
	parts of material classified as V-0 or V-1 according to AS/NZS 60695.11.10, provided that the sample tested was not thicker than the relevant part.		
4.7.201.4	<p>4.7.201.4 Testing in the event of non-extinguishing material</p> <p>If parts, other than enclosures, do not withstand the glow wire tests of 4.7.201.3, by failure to extinguish within 30 s after the removal of the glowwire tip, the needle-flame test detailed in 4.7.201.3 shall be made on all parts of non-metallic material which are within a distance of 50 mm or which are likely to be impinged upon by flame during the tests of 4.7.201.3. Parts shielded by a separate barrier which meets the needle-flame test need not be tested.</p> <p>NOTE 1 If the enclosure does not withstand the glow-wire test the equipment is considered to have failed to meet the requirements of Clause 4.7.201 without the need for consequential testing.</p> <p>NOTE 2 If other parts do not withstand the glow-wire test due to ignition of the tissue paper and if this indicates that burning or glowing particles can fall onto an external surface underneath the equipment, the equipment is considered to have failed to meet the requirements of Clause 4.7.201 without the need for consequential testing.</p> <p>NOTE 3 Parts likely to be impinged upon by the flame are considered to be those within the envelope of a vertical cylinder having a radius of 10 mm and a height equal to the height of the flame, positioned above the point of the material supporting, in contact with, or in close proximity to, connections.</p>	Added. The alternative method is not considered.	N/A

National Differences			
Clause	Requirement - Test	Result - Remark	Verdict
4.7.201.5	<p>4.7.201.5 Testing of printed boards</p> <p>The base material of printed boards shall be subjected to the needle-flame test of Clause 4.7.201.3. The flame shall be applied to the edge of the board where the heat sink effect is lowest when the board is positioned as in normal use. The flame shall not be applied to an edge, consisting of broken perforations, unless the edge is less than 3 mm from a POTENTIAL IGNITION SOURCE.</p> <p>The test is not carried out if the —</p> <ul style="list-style-type: none"> - Printed board does not carry any POTENTIAL IGNITION SOURCE; - Base material of printed boards, on which the available apparent power at a connection exceeds 15 VA operating at a voltage exceeding 50 V and equal or less than 400 V (peak) a.c. or d.c. under normal operating conditions, is of flammability category V-1 or better according to AS/NZS 60695.11.10, or the printed boards are protected by an enclosure meeting the flammability category V-0 according to AS/NZS 60695.11.10, or made of metal, having openings only for connecting wires which fill the openings completely; or - Base material of printed boards, on which the available apparatus power at a connection exceeds 15 VA operating at a voltage exceeding 400 V (peak) a.c. or d.c. under normal operating conditions, and base material of printed boards supporting spark gaps which provides protection against overvoltages, is of flammability category V-0 according to AS/NZS 60695.11.10 or the printed boards are contained in a metal enclosure, having openings only for connecting wires which fill the openings completely. <p>Compliance shall be determined using the smallest thickness of the material.</p> <p>NOTE Available apparent power is the maximum apparent power which can be drawn from the supplying circuit through a resistive load whose value is chosen to maximise the apparent power for more than 2 min when the circuit supplied is disconnected.</p>	Added. The alternative method is not considered.	N/A
6.2.2	<p>For Australia only, delete the first paragraph and Note, and replace with the following:</p> <p>In Australia only, compliance with 6.2.2 shall be checked by the tests of both 6.2.2.1 and 6.2.2.2.</p>	No TNV.	N/A

National Differences			
Clause	Requirement - Test	Result - Remark	Verdict
6.2.2.1	<p>For Australia only, delete the first paragraph including the Notes, and replace with the following:</p> <p><i>In Australia only, the electrical separation is subjected to 10 impulses of alternating polarity, using the impulse test generator reference 1 of Table N.1. The interval between successive impulses is 60 s and the initial voltage, U_c, is:</i></p> <p><i>(i) for 6.2.1 a): 7.0 kV for hand-held telephones and for headsets and 2.5 kV for other equipment; and</i></p> <p><i>(ii) for 6.2.1 b) and 6.2.1 c): 1.5 kV.</i></p> <p>NOTE 201 The 7 kV impulse simulates lightning surges on typical rural and semi-rural network lines.</p> <p>NOTE 202 The value of 2.5 kV for 6.2.1 a) was chosen to ensure the adequacy of the insulation concerned and does not necessarily simulate likely overvoltages.</p>	No TNV.	N/A
6.2.2.2	<p>For Australia only, delete the second paragraph including the Note, and replace with the following:</p> <p><i>In Australia only, the a.c. test voltage is:</i></p> <p><i>(i) for 6.2.1 a): 3 kV; and</i></p> <p><i>(ii) for 6.2.1 b) and 6.2.1 c): 1.5 kV.</i></p> <p>NOTE 201 Where there are capacitors across the insulation under test, it is recommended that d.c. test voltages are used.</p> <p>NOTE 202 The 3 kV and 1.5 kV values have been determined considering the low frequency induced voltages from the power supply distribution system.</p>	No TNV.	N/A
7.3	<p>Add the following before the first paragraph:</p> <p>Equipment providing functions that fall only within the scope of AS/NZS 60065 and that incorporate a PSTN interface, are not required to comply with this Clause where the only ports provided on the equipment, in addition to a coaxial cable connection and a PSTN interface, are audio or video ports and analogue or data ports not intended to be used for telecommunications purposes.</p>	No cable distribution systems.	N/A
Annex P	<p>Add the following Normative References:</p> <p>AS/NZS 3191, Electric flexible cords</p> <p>AS/NZS 3112, Approval and test specification—Plugs and socket-outlets</p>	Added.	P

National Differences			
Clause	Requirement - Test	Result - Remark	Verdict
Index	<p>1. Insert the following between 'asbestos, not to be used as insulation' and 'attitude see orientation':</p> <p>AS/NZS 3112 4.3.6</p> <p>AS/NZS 3191 3.2.5.1 (Table 3B)</p> <p>AS/NZS 60064 4.1.201</p> <p>AS/NZS60695.2.11 4.7.201.2, 4.7.201.3</p> <p>AS/NZS 60695.11.104.7.201.1, 4.7.201.5</p> <p>AS/NZS 60695.11.5 4.7.201.3</p> <p>AS/NZS 60825.1 4.3.13.5.1</p> <p>AS/NZS 60825.2 4.3.13.5.1</p> <p>2. Insert the following between 'positive temperature coefficient (PTC) device' and 'powder':</p> <p>Potential ignition source 1.2.201, 4.7.201.3, 4.7.201.5</p>	Inserted.	N/A

Product: LCD MONITOR

Type Designation: 185LM000**, *970SW****, 215LM000**, *2270SW****, 195LM000**, *2070SW**** (* can be 0-9, A-Z, a-z, -, \, /, + or blank for marketing purpose)



Figure 1. Model 185LM000**



Figure 2. Model 185LM000**

Product: LCD MONITOR

Type Designation: 185LM000**, *970SW****, 215LM000**, *2270SW****, 195LM000**, *2070SW**** (* can be 0-9, A-Z, a-z, - , \ , / , + or blank for marketing purpose)

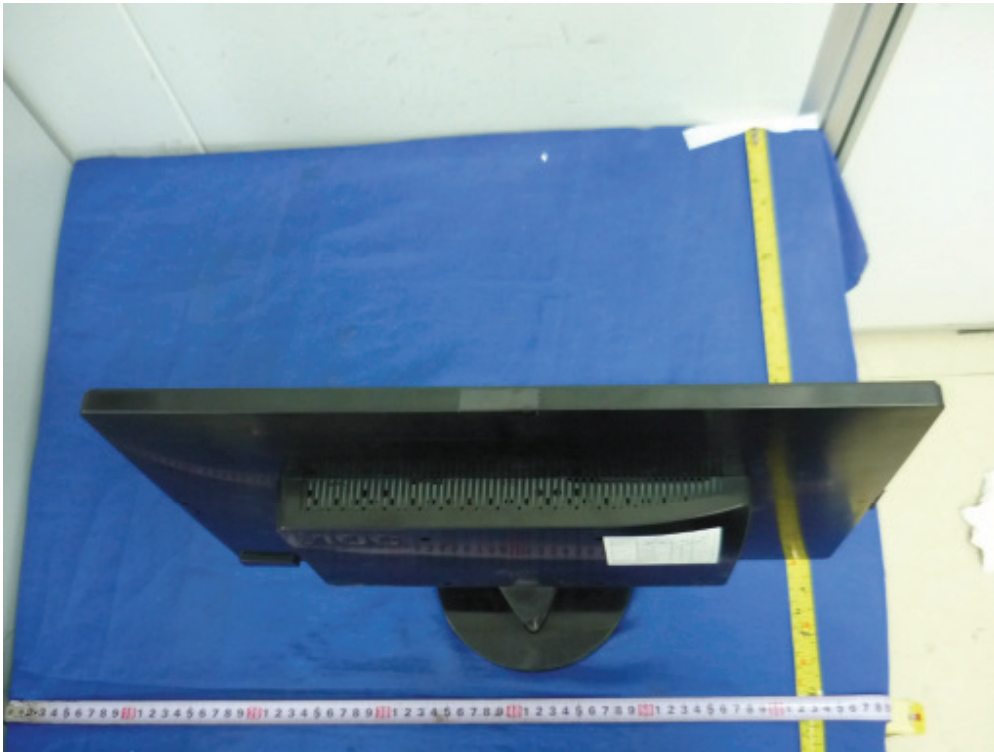

Figure 3. Model 185LM000**



Figure 4. Model 185LM000**

Product: LCD MONITOR

Type Designation: 185LM000**, *970SW****, 215LM000**, *2270SW****, 195LM000**, *2070SW**** (* can be 0-9, A-Z, a-z, -, \, /, + or blank for marketing purpose)



Figure 5. Model 215LM000**



Figure 6. Model 215LM000**

Product: LCD MONITOR

Type Designation: 185LM000**, *970SW****, 215LM000**, *2270SW****, 195LM000**, *2070SW**** (* can be 0-9, A-Z, a-z, -, \, /, + or blank for marketing purpose)



Figure 7. Model 195LM000**



Figure 8. Model 195LM000**

Product: LCD MONITOR

Type Designation: 185LM000**, *970SW****, 215LM000**, *2270SW****, 195LM000**, *2070SW**** (* can be 0-9, A-Z, a-z, -, \, /, + or blank for marketing purpose)

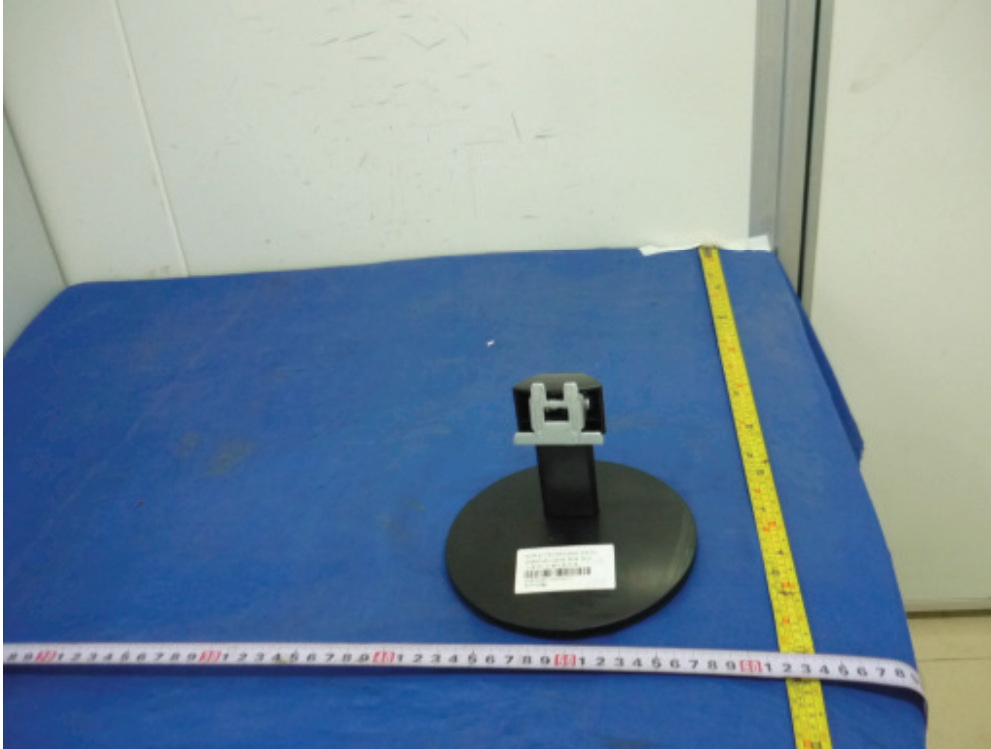

Figure 9. Base



Figure 10. Metal enclosure type A

Product: LCD MONITOR

Type Designation: 185LM000**, *970SW****, 215LM000**, *2270SW****, 195LM000**, *2070SW**** (* can be 0-9, A-Z, a-z, -, \, /, + or blank for marketing purpose)

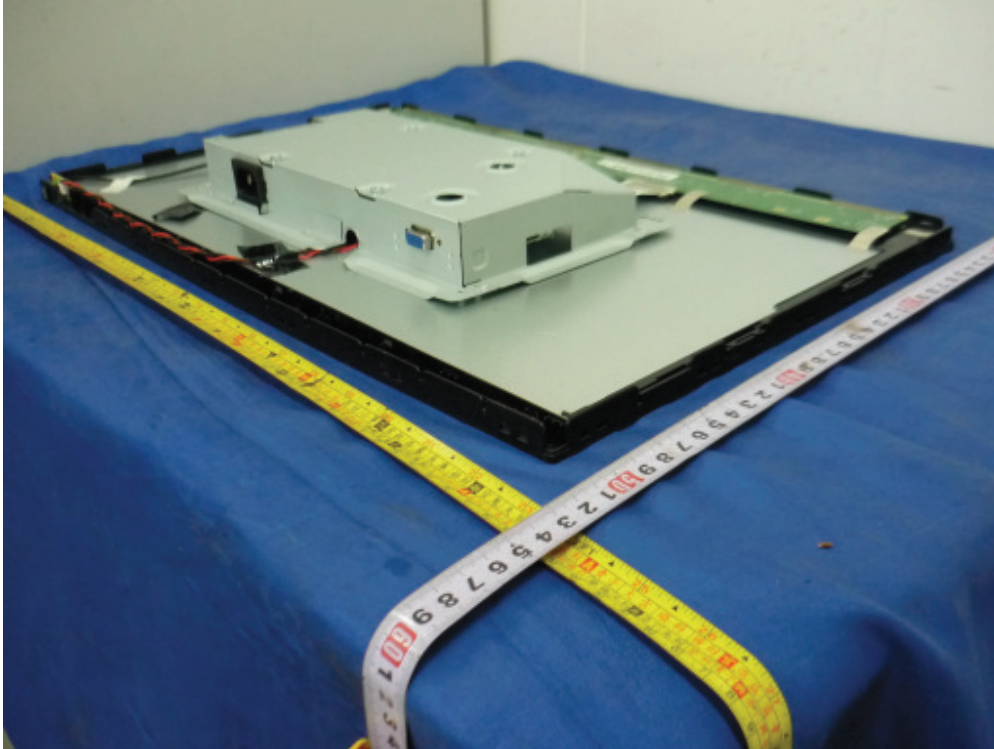

Figure 11. Metal enclosure type A

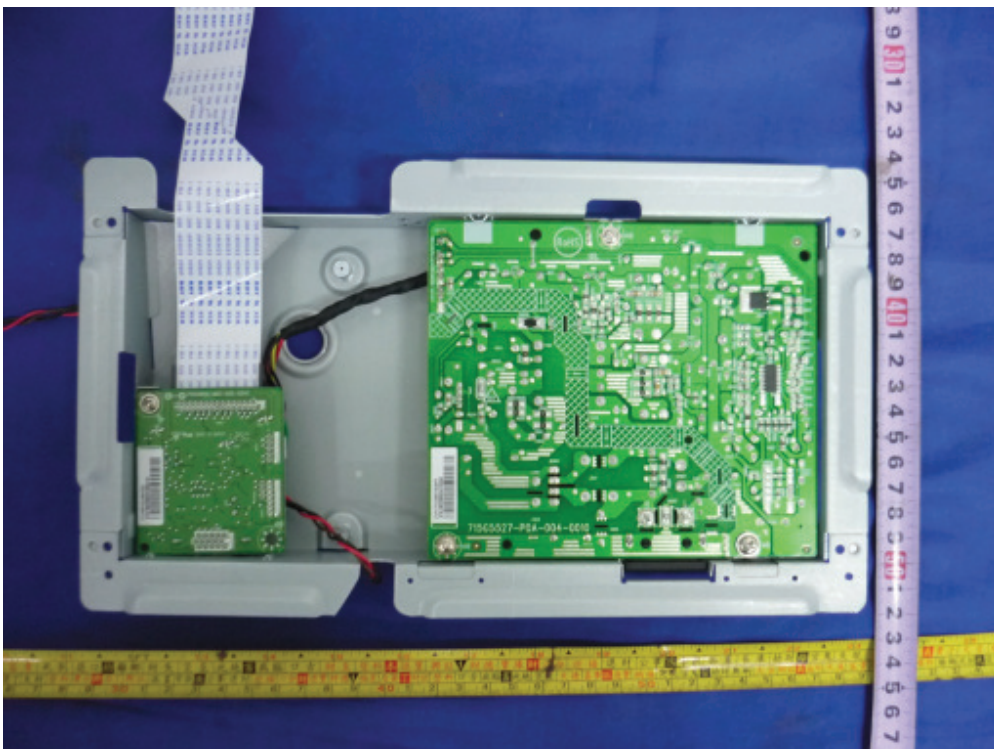

Figure 12. Metal enclosure type A

Product: LCD MONITOR

Type Designation: 185LM000**, *970SW****, 215LM000**, *2270SW****, 195LM000**, *2070SW**** (* can be 0-9, A-Z, a-z, - , \ , / , + or blank for marketing purpose)

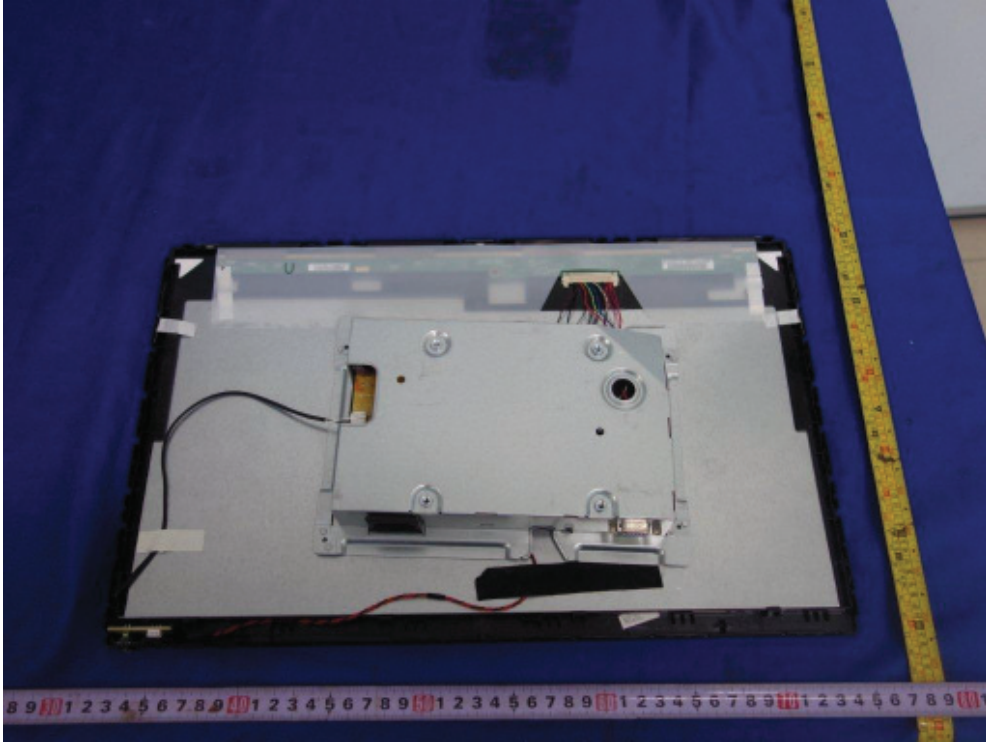

Figure 13. Metal enclosure type B

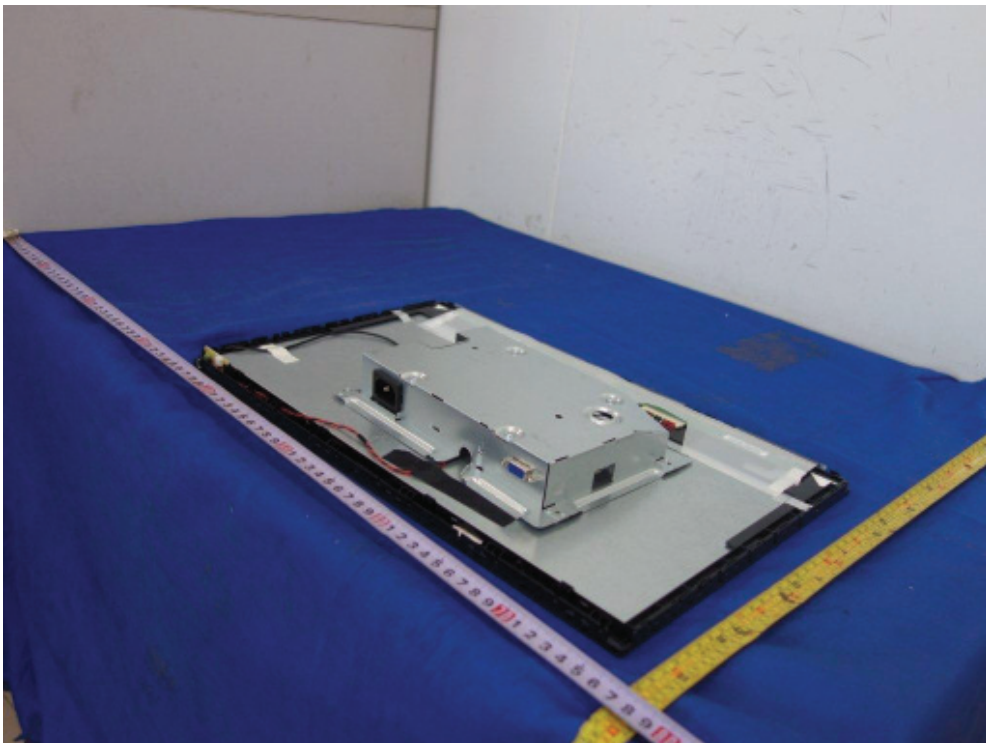

Figure 14. Metal enclosure type B

Product: LCD MONITOR

Type Designation: 185LM000**, *970SW****, 215LM000**, *2270SW****, 195LM000**, *2070SW**** (* can be 0-9, A-Z, a-z, -, \, /, + or blank for marketing purpose)

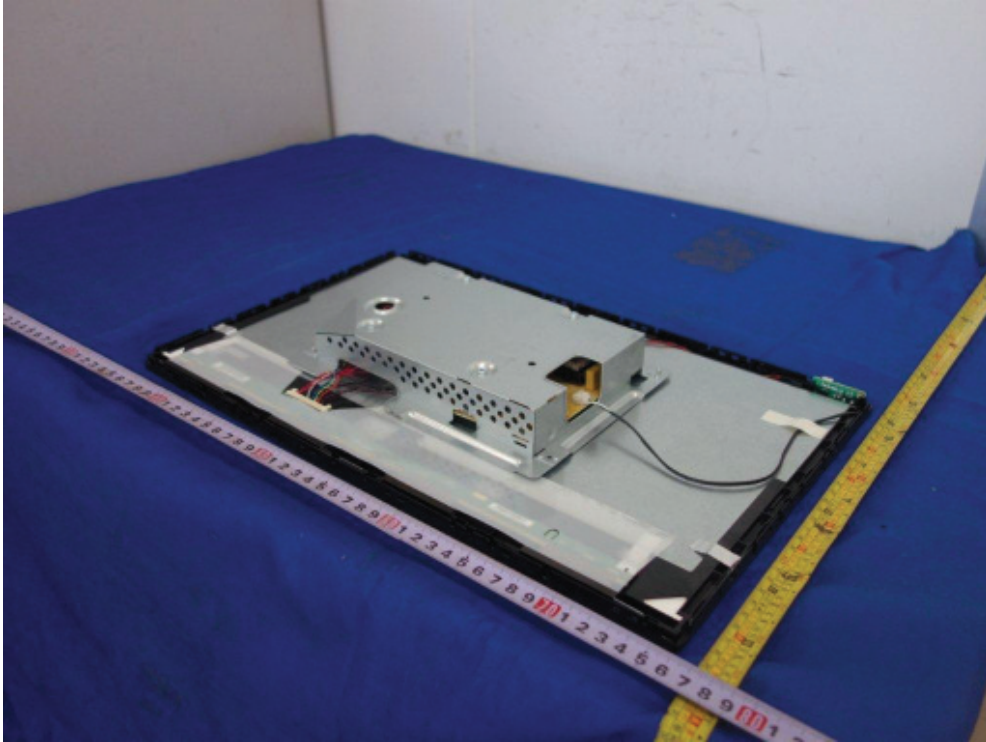

Figure 15. Metal enclosure type B

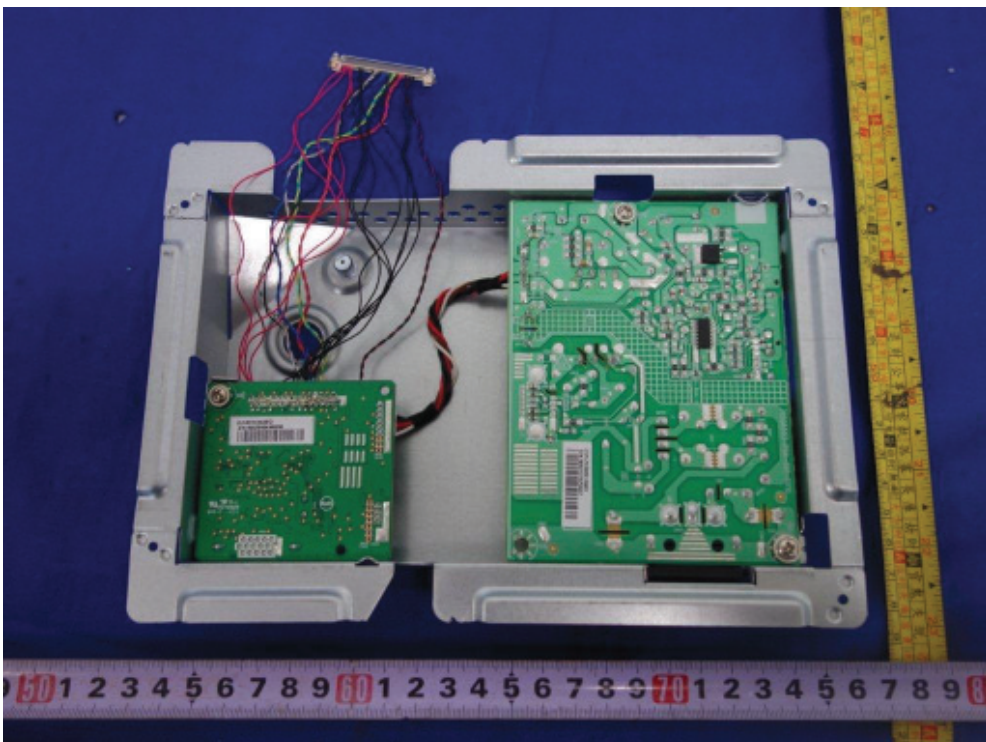

Figure 16. Metal enclosure type B

Product: LCD MONITOR

Type Designation: 185LM000**, *970SW****, 215LM000**, *2270SW****, 195LM000**, *2070SW**** (* can be 0-9, A-Z, a-z, -, \, /, + or blank for marketing purpose)

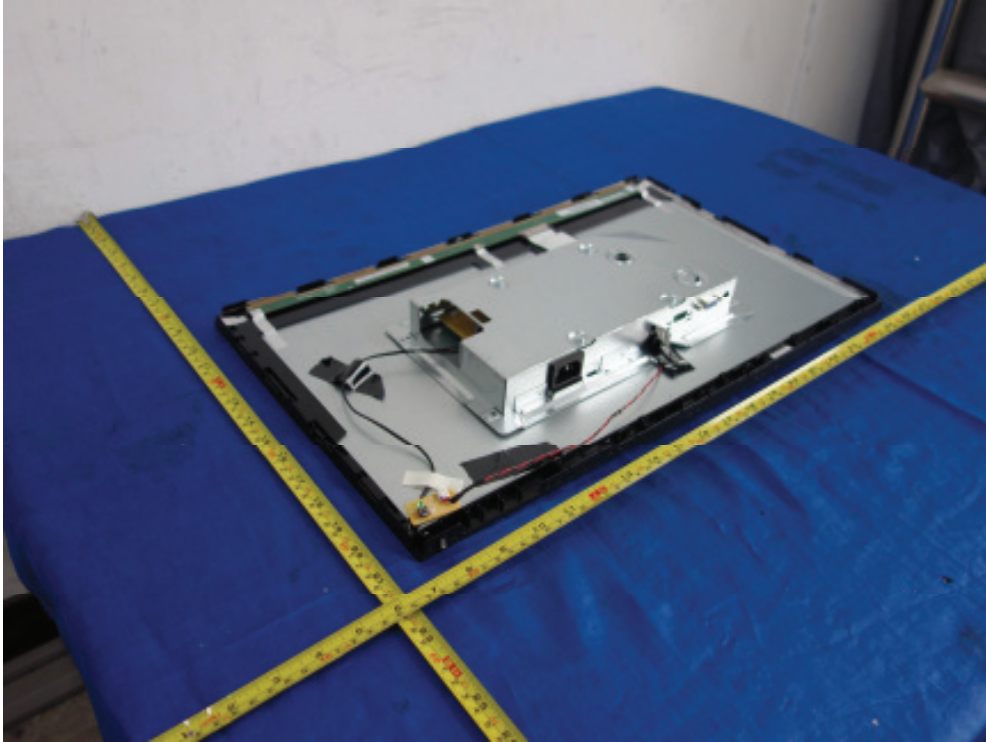

Figure 17. Metal enclosure type C

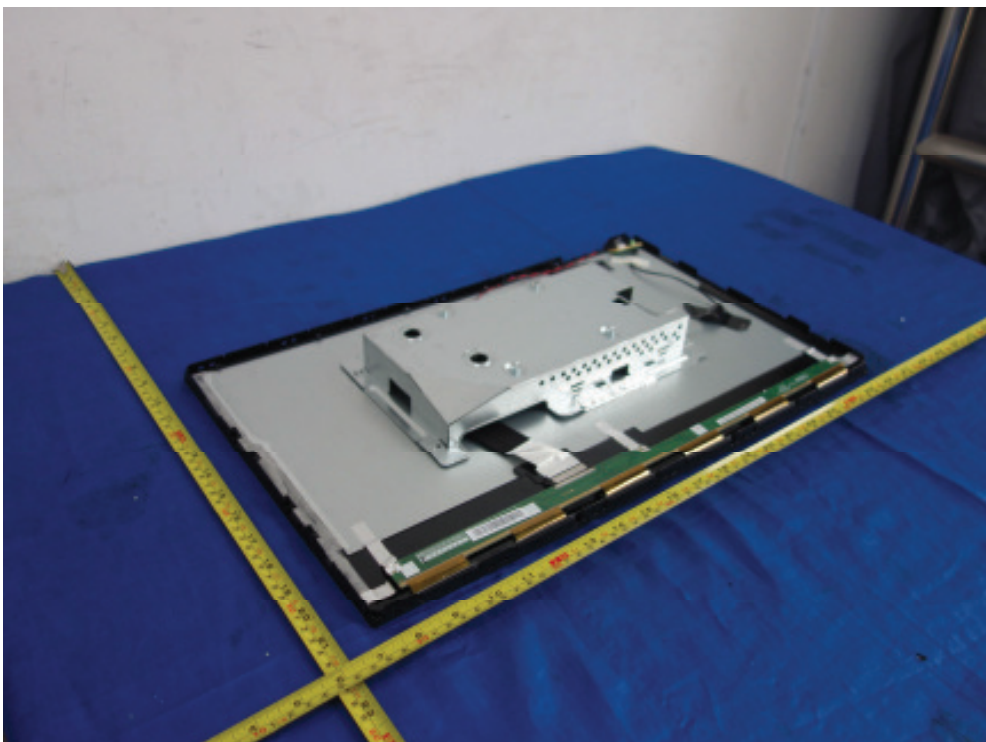

Figure 18. Metal enclosure type C

Product: LCD MONITOR

Type Designation: 185LM000**, *970SW****, 215LM000**, *2270SW****, 195LM000**, *2070SW**** (* can be 0-9, A-Z, a-z, -, \, /, + or blank for marketing purpose)

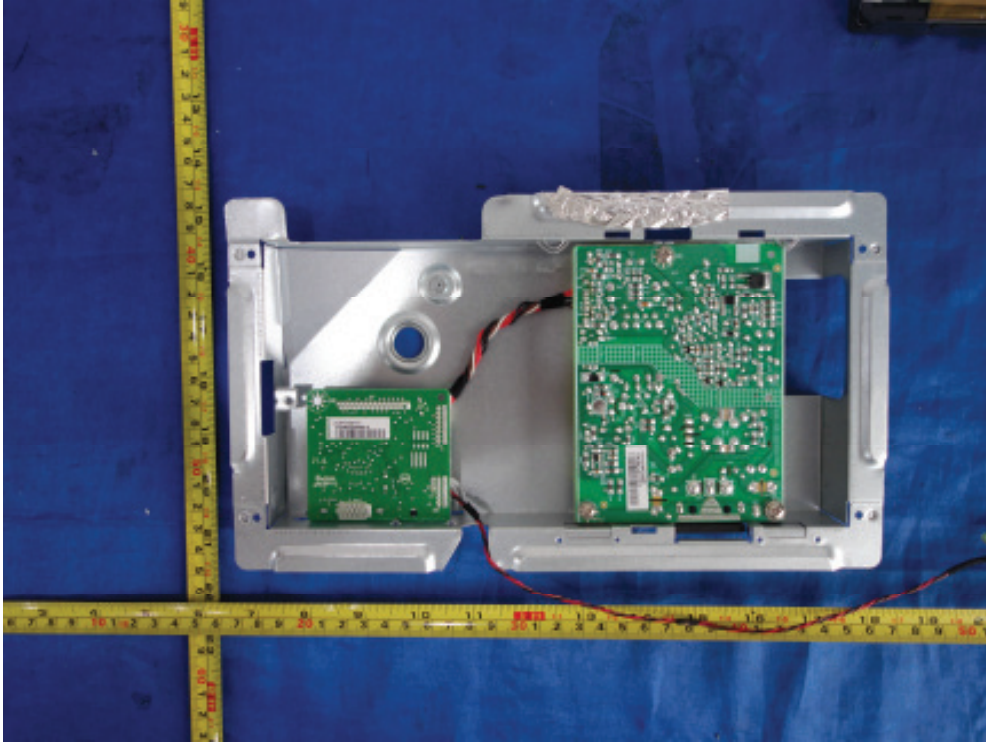

Figure 19. Metal enclosure type C

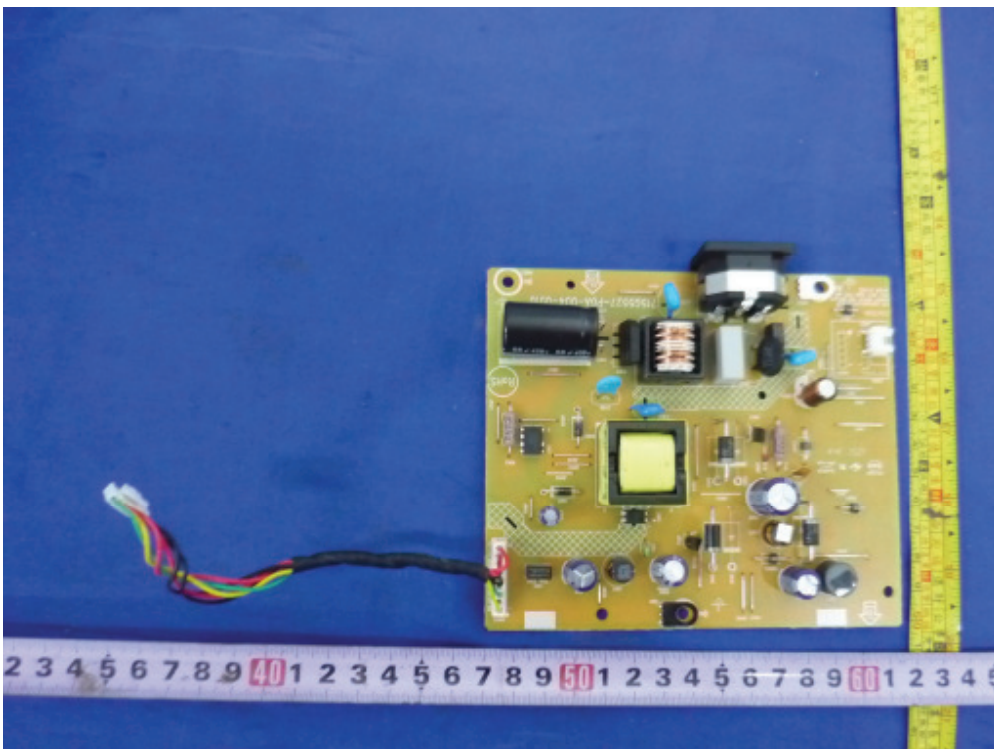

Figure 20. Power board 715G5527

Product: LCD MONITOR

Type Designation: 185LM000**, *970SW****, 215LM000**, *2270SW****, 195LM000**, *2070SW**** (* can be 0-9, A-Z, a-z, -, \, /, + or blank for marketing purpose)

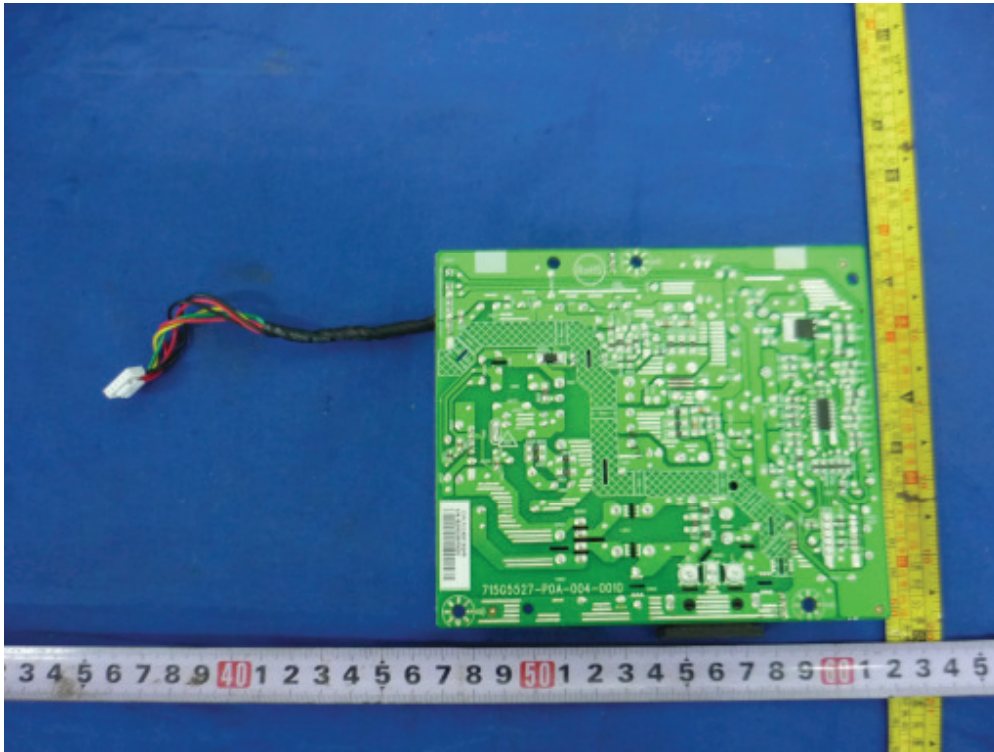

Figure 21. Power board 715G5527

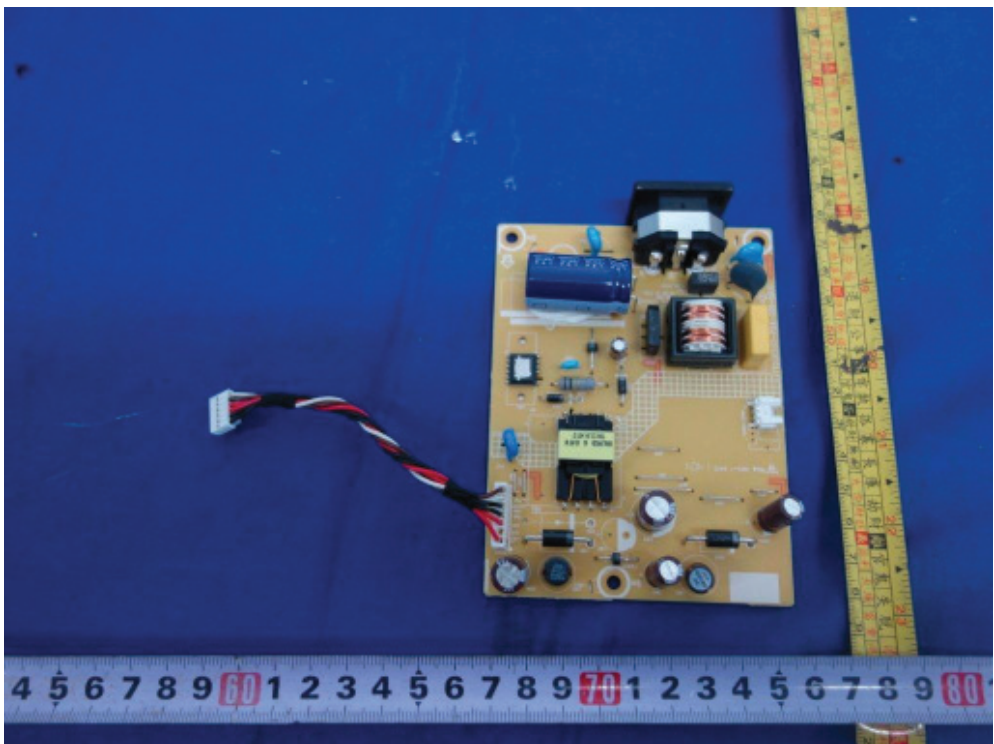

Figure 22. Power board 715G6503

Product: LCD MONITOR

Type Designation: 185LM000**, *970SW****, 215LM000**, *2270SW****, 195LM000**, *2070SW**** (* can be 0-9, A-Z, a-z, -, \, /, + or blank for marketing purpose)

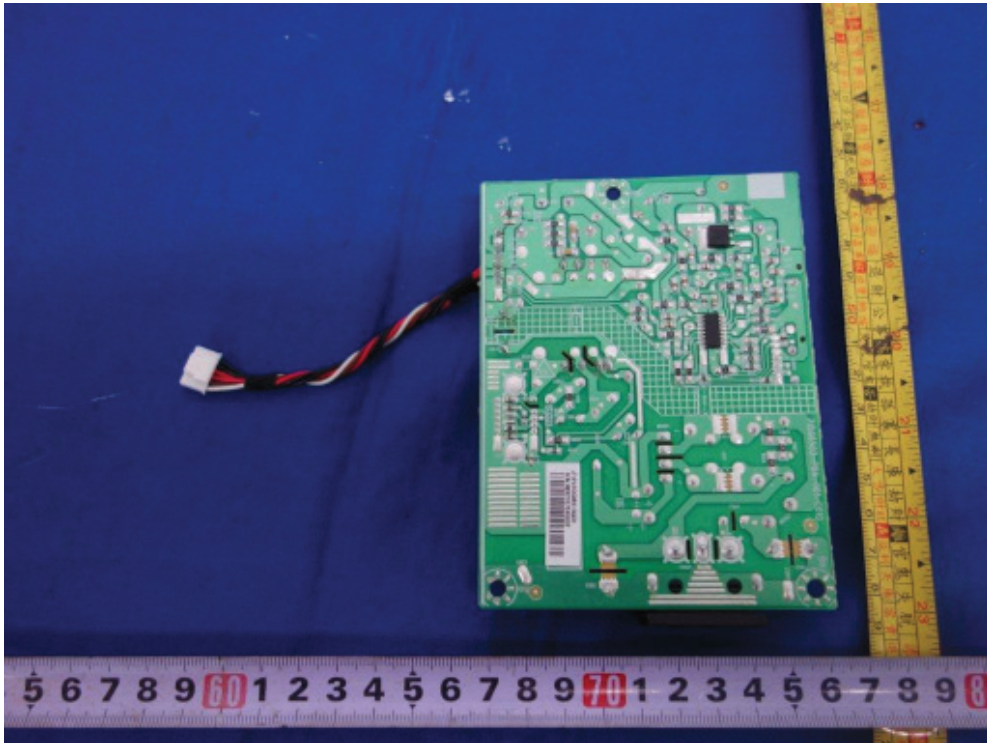

Figure 23. Power board 715G6503

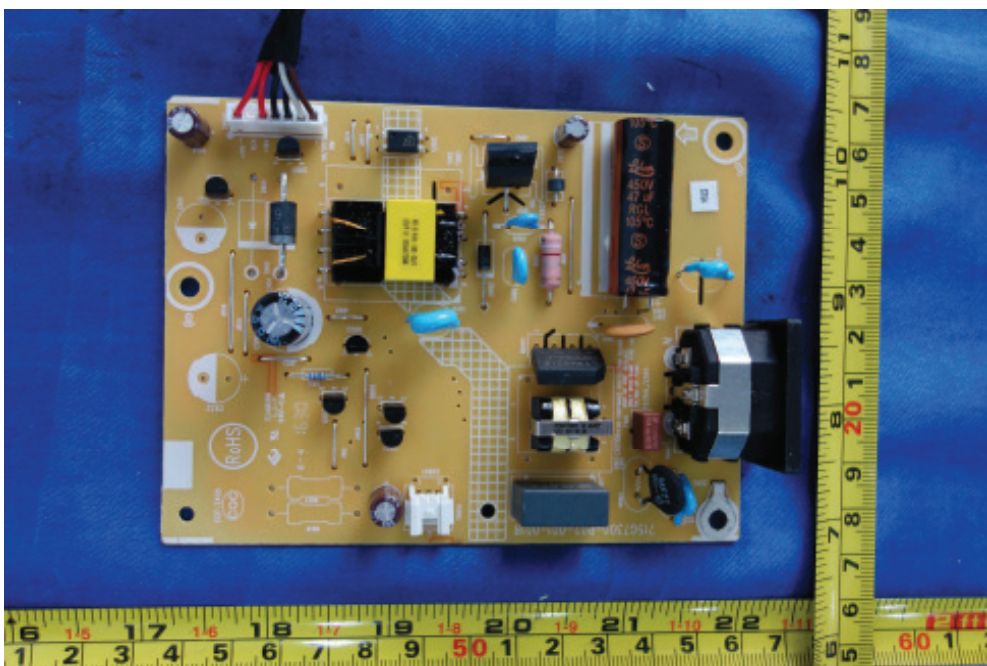

Figure 24. Power board 715G7300

Product: LCD MONITOR

Type Designation: 185LM000**, *970SW****, 215LM000**, *2270SW****, 195LM000**, *2070SW**** (* can be 0-9, A-Z, a-z, - , \ , / , + or blank for marketing purpose)

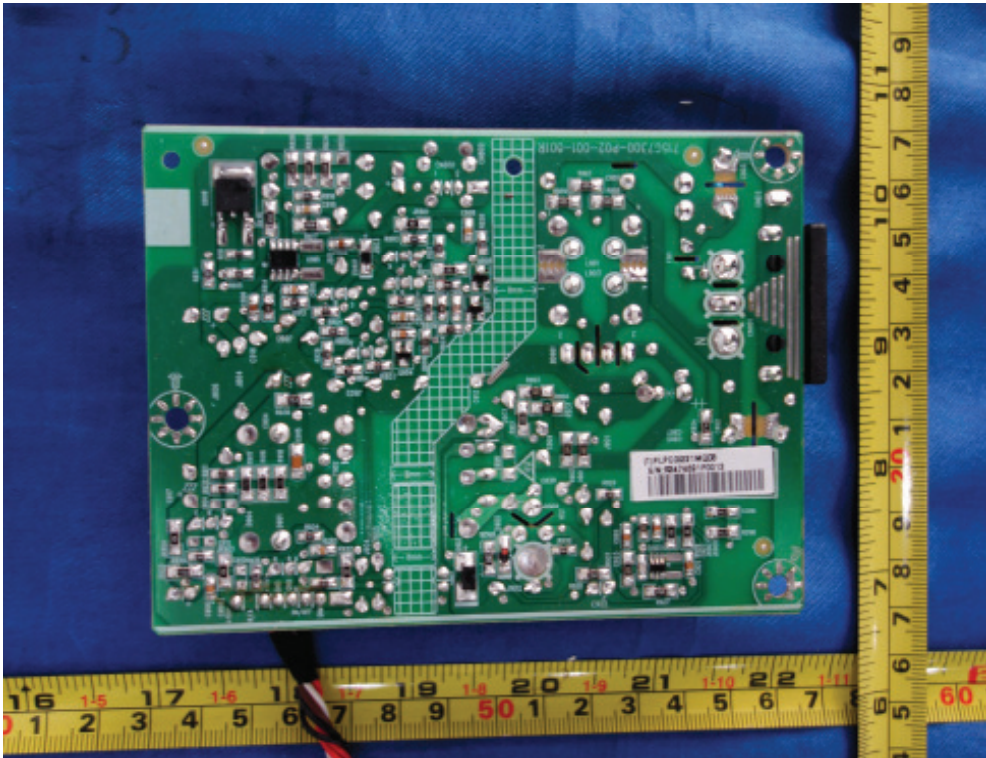

Figure 25. Power board 715G7300

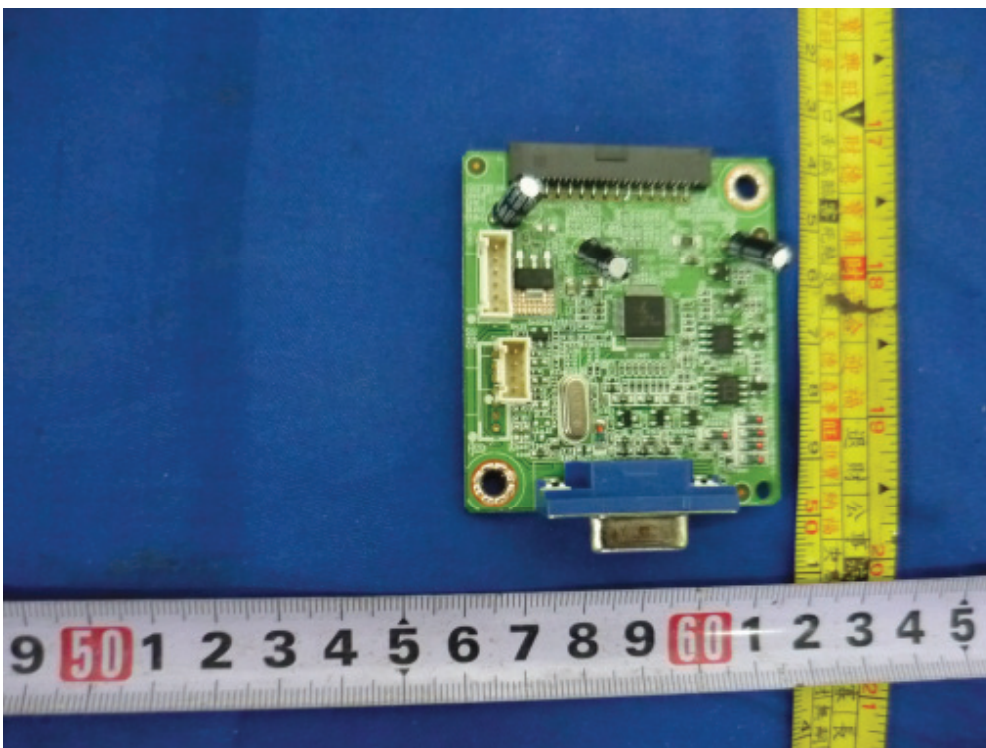

Figure 26. Main board 715G5965

Product: LCD MONITOR

Type Designation: 185LM000**, *970SW****, 215LM000**, *2270SW****, 195LM000**, *2070SW**** (* can be 0-9, A-Z, a-z, -, \, /, + or blank for marketing purpose)

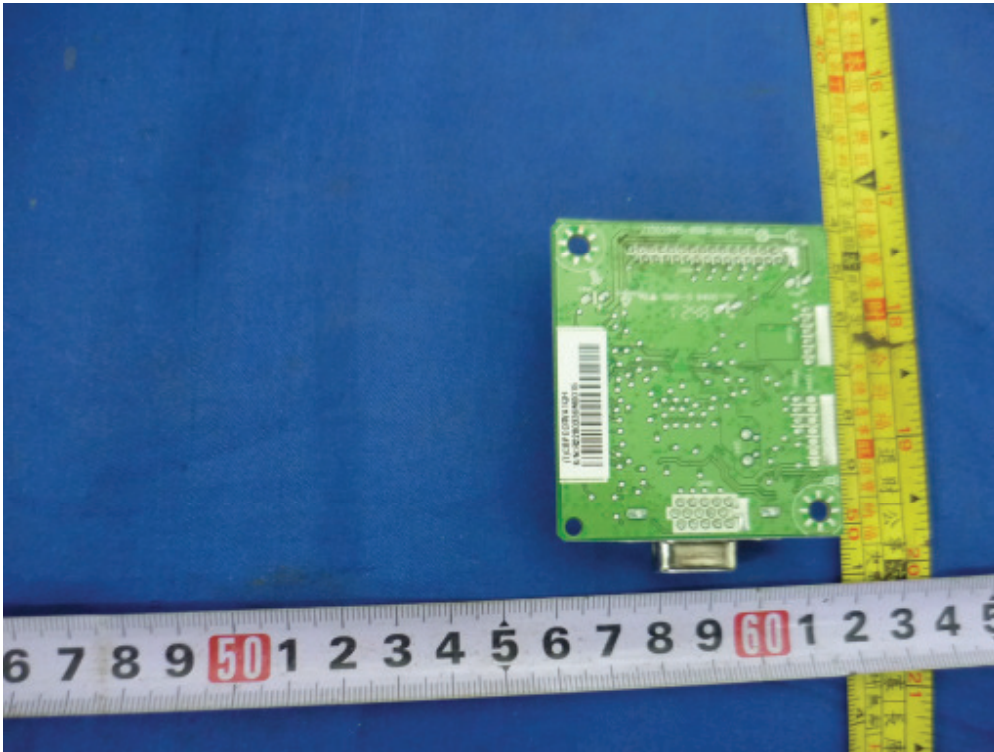

Figure 27. Main board 715G5965

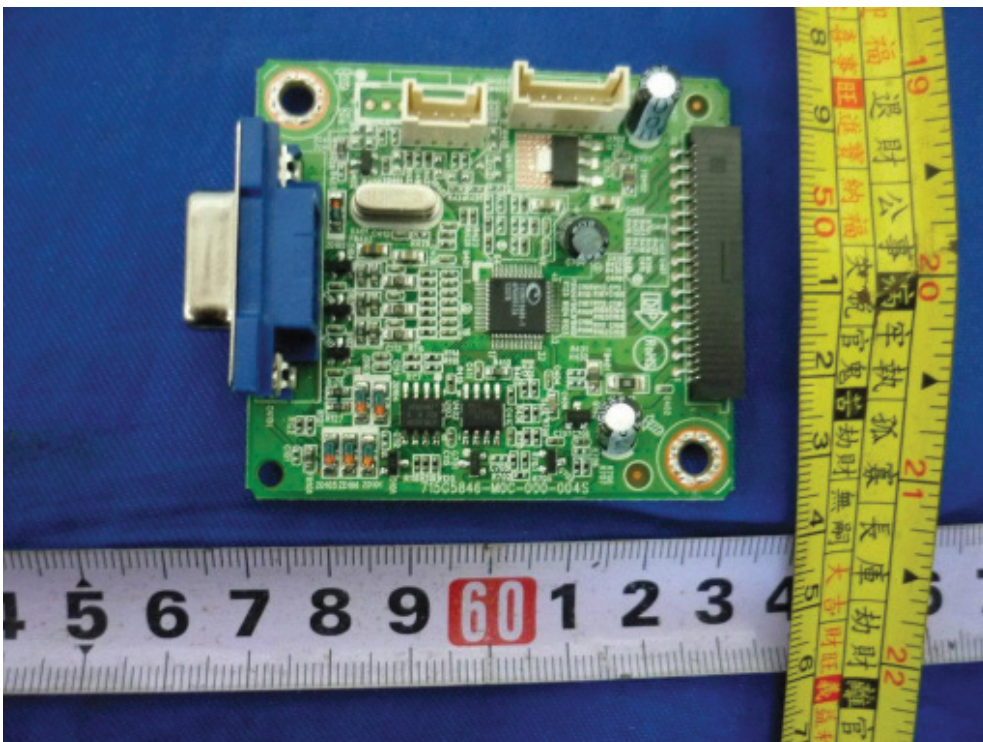

Figure 28. Main board 715G5846

Product: LCD MONITOR

Type Designation: 185LM000**, *970SW****, 215LM000**, *2270SW****, 195LM000**, *2070SW**** (* can be 0-9, A-Z, a-z, -, \, /, + or blank for marketing purpose)

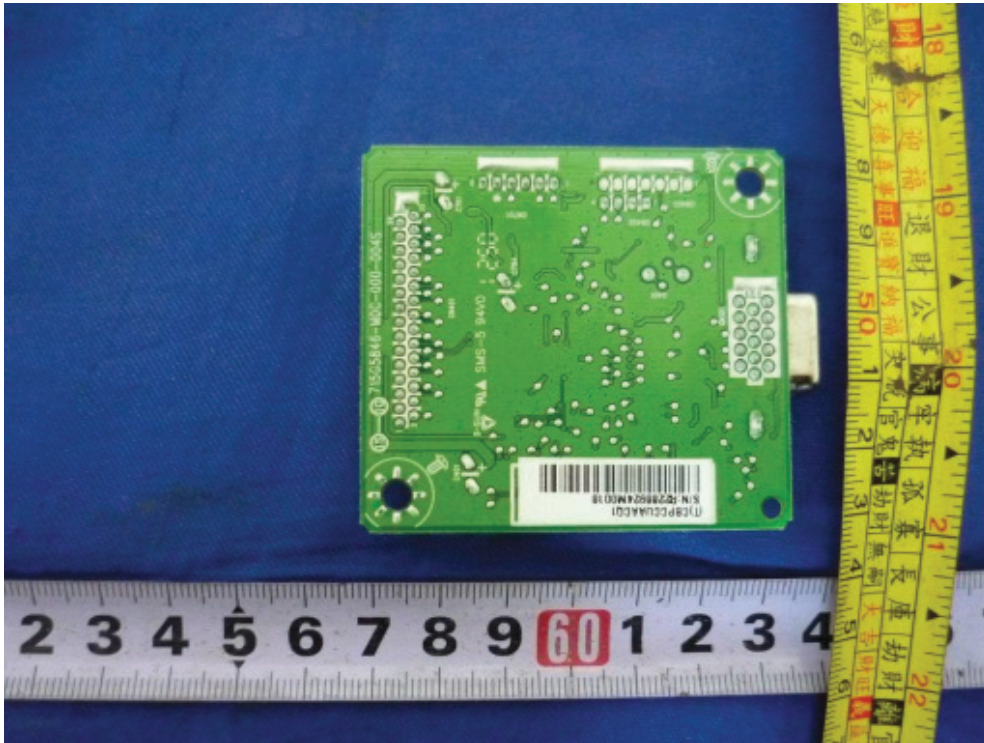

Figure 29. Main board 715G5846

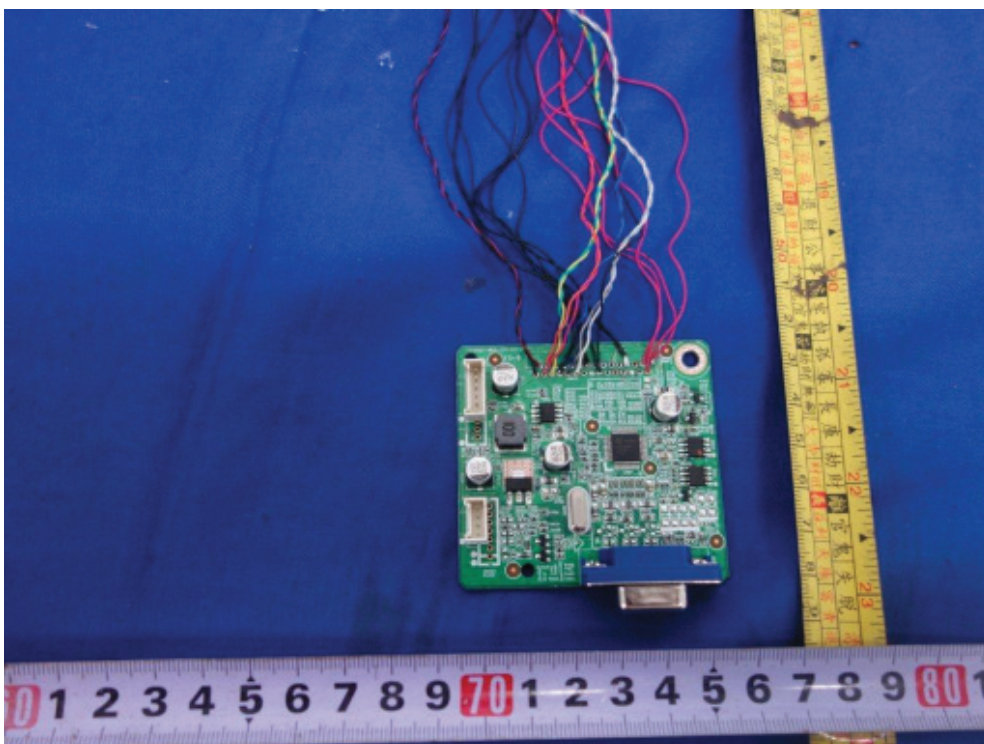

Figure 30. Main board 715G6851 type A

Product: LCD MONITOR

Type Designation: 185LM000**, *970SW****, 215LM000**, *2270SW****, 195LM000**, *2070SW**** (* can be 0-9, A-Z, a-z, -, \, /, + or blank for marketing purpose)

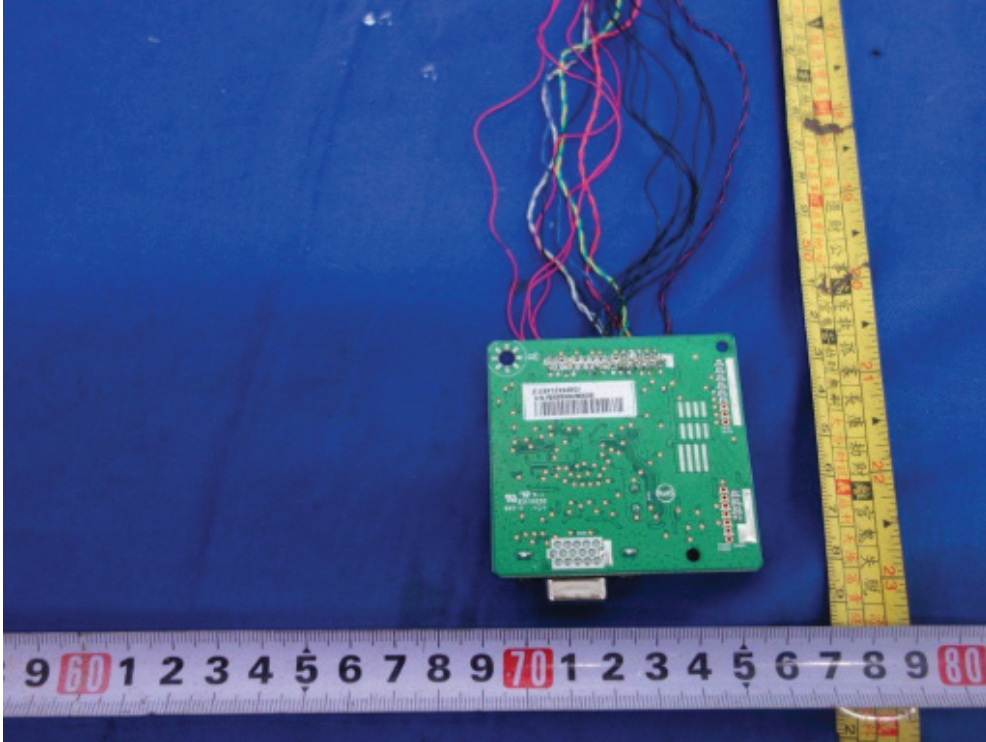

Figure 31. Main board 715G6851 type A

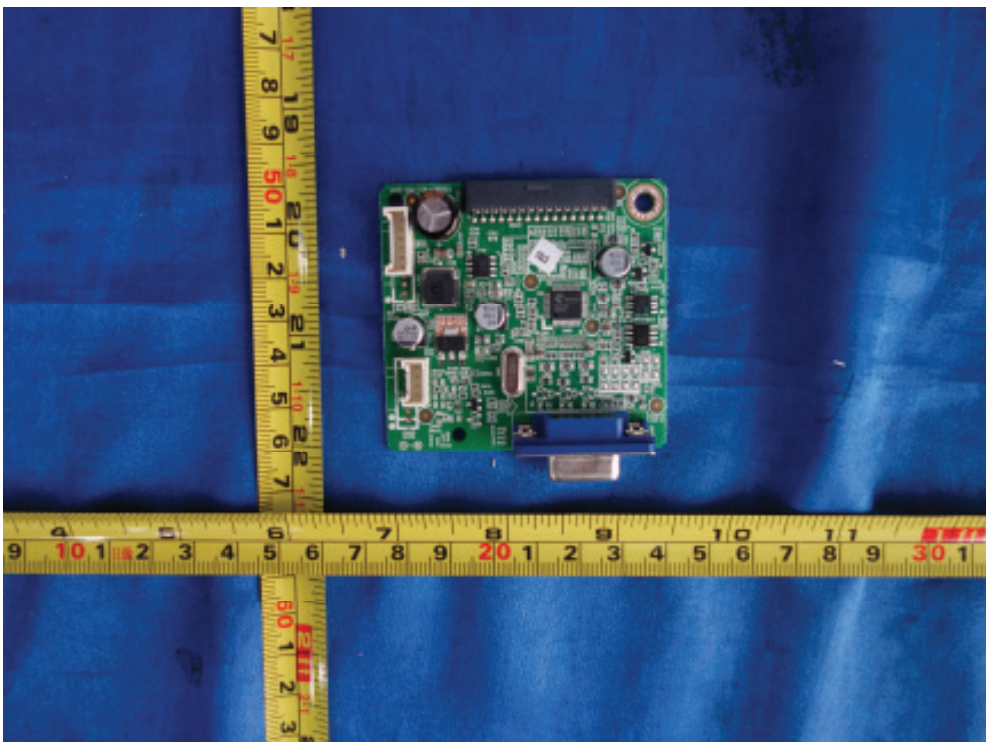

Figure 32. Main board 715G6851 type B

Product: LCD MONITOR

Type Designation: 185LM000**, *970SW****, 215LM000**, *2270SW****, 195LM000**, *2070SW**** (* can be 0-9, A-Z, a-z, -, \, /, + or blank for marketing purpose)

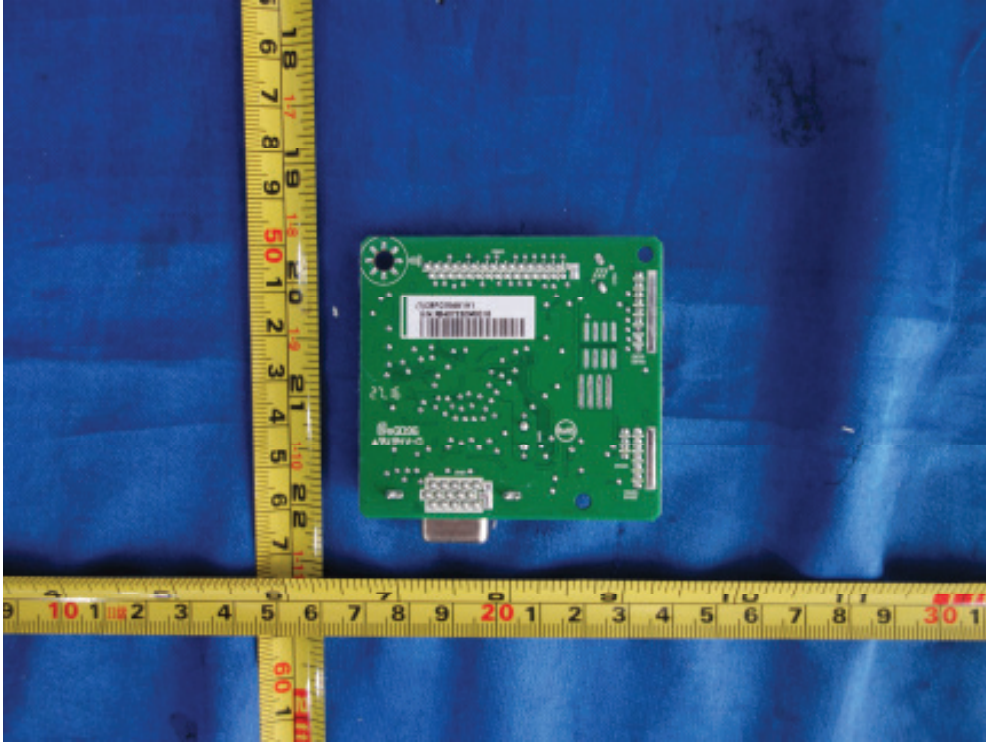

Figure 33. Main board 715G6851 type B